



Controls Operation and Troubleshooting

CONTENTS

	Page		Page
SAFETY CONSIDERATIONS	1,2		
GENERAL	2		
Abbreviations Used in This Manual	2		
HARDWARE	2-12		
Main Control Board	2		
ISM (Integrated Starter Module)	2		
IOB (Input/Output Board)	3		
Communication Cables	3		
Sensors	12		
• PRESSURE TRANSDUCERS			
• TEMPERATURE SENSORS			
Controls Outputs	12		
• EVAPORATOR/CONDENSER WATER PUMP			
• INLET GUIDE VANE			
• ECONOMIZER DAMPER VALVE			
• ENVELOP CONTROL/HGBP VALVE			
• VFD			
PIC 5 USER INTERFACE	12-17		
Web Connection	12		
General Interface Features	13		
• ICONS			
• SCREENS			
PIC 5 CONTROL OPERATION	17-31		
Start-Stop Control	17		
• LOCAL			
• LOCAL SCHEDULE			
• REMOTE			
• NETWORK			
Compressor Run Status	17		
Chiller Start-Up Sequence	18		
• PRE-START CHECK			
• START-UP			
Chiller Shutdown Sequence	19		
Oil Lubrication Control	19		
Control Points	19		
• SET POINT			
• CONTROL POINT TEMPERATURE			
• TEMPERATURE RESET			
• CAPACITY CONTROL			
• RAMP LOADING			
• SURGE CORRECTION CONTROL			
• ENVELOP/HOT GAS BYPASS (HGBP) CONTROL			
• ECONOMIZER DAMPER VALVE CONTROL			
• DEMAND LIMIT			
• OVERRIDE CONTROL			
• RECYCLE CONTROL			
• RUNNING TIMERS AND COUNTERS			
• WATER PUMPS CONTROL (FREEZE PREVENTION)			
• CONTROL TEST			
• SWIFT RESTART			
• COOLING TOWER CONTROL			
		• HEAD PRESSURE CONTROL	
		• ICE BUILD OPTION	
		• TIME SCHEDULE	
		• BLACK BOX	
		• PRESSURE TRANSDUCER CALIBRATION	
		• TEMPERATURE SENSOR CALIBRATION	
		• ISM VFD INPUT/OUTPUT CALIBRATION	
		• ALARM EMAIL	
		• PROGNOSTICS	
		• MASTER SLAVE CONTROL	
		Oil EXV Option	30
		Pumpdown/Lockout	30
		Displaying Data Trends	30
		Hydraulic Option	31
		• WATER FLOW MEASUREMENT	
		• WATER PRESSURE DIFFERENCE MEASUREMENT	
		• MARINE OPTION(S)	
		DIAGNOSTICS AND TROUBLESHOOTING ...	32-49
		Displaying Alarms	32
		Resetting Alarms	32
		Alarm/Alert Codes	32
		Event States	49
		TOUCH SCREEN SETTINGS FOR THE CONTROLLER	49-51
		Unit IP Address	49
		Web Address	50
		System Configuration	50
		General Display Settings	51
		• TOUCH SCREEN CALIBRATION	
		Touch Screen Configuration Language	51
		COMMUNICATION PROBLEMS	52-54
		Hardware Problems	52
		Web Interface Problems	52
		Ethernet/IP Connection Problems	53
		• UNIT IS POINT-TO-POINT CONNECTED TO A PC	
		• UNIT IS CONNECTED TO THE LOCAL NETWORK	
		• ETHERNET CONNECTION ON THE PC	
		• JAVA APPLICATION CONFIGURATION	
		APPENDIX A — PIC 5 SCREEN AND TABLE STRUCTURE	55-91
		APPENDIX B — INPUT/OUTPUT BOARD (IOB) AND HUMAN MACHINE INTERFACE (HMI) DIP SWITCH SETTINGS	92,93
		APPENDIX C — INPUT/OUTPUT BOARD (IOB) STATUS INDICATORS	94
		APPENDIX D — NETWORK CONFIGURATION	95-101
		APPENDIX E — ISM WIRING DIAGRAMS	102-107

SAFETY CONSIDERATIONS

Installing, starting up, and servicing this equipment can be hazardous due to system pressures, electrical components, and equipment location (roof, elevated structures, etc.). Only trained, qualified installers and service mechanics should

install, start up, and service this equipment. When working on this equipment, observe precautions in the literature, and on tags, stickers, and labels attached to the equipment, and any other safety precautions that apply. Follow all safety codes. Wear safety glasses and work gloves. Use care in handling, rigging, and setting this equipment, and in handling all electrical components.

⚠ WARNING

Electrical shock can cause personal injury and death. Shut off all power to this equipment during installation. Use lock out/tag out procedures and be aware that there may be more than one disconnect switch. Be sure to tag all disconnect locations to alert others not to restore power until work is completed. Even when the main circuit breaker or isolator is switched off, certain circuits may still be energized, since they may be connected to a separate power source.

⚠ WARNING

Electrical currents cause components to get hot either temporarily or permanently and may cause burns. Handle power cable, electrical cables and conduits, terminal box covers, and motor frames with great care.

⚠ CAUTION

This unit uses a microprocessor control system. Do not short or jumper between terminations on circuit boards or modules; control or board failure may result.

Be aware of electrostatic discharge (static electricity) when handling or making contact with circuit boards or module connections. Always touch a chassis (grounded) part to dissipate body electrostatic charge before working inside control center.

Use extreme care when handling tools near boards and when connecting or disconnecting terminal plugs. Circuit boards can easily be damaged. Always hold boards by the edges and avoid touching components and connections.

This equipment uses, and can radiate, radio frequency energy. If not installed and used in accordance with the instruction manual, it may cause interference to radio communications. The PIC 5 control boards have been tested and found to comply with the limits for a Class A computing device pursuant to International Standard in North America EN 61000-2/3 which are designed to provide reasonable protection against such interference when operated in a commercial environment. Operation of this equipment in a residential area is likely to cause interference, in which case the user, at his own expense, will be required to take whatever measures may be required to correct the interference.

Always store and transport replacement or defective boards in anti-static shipping bag.

GENERAL

This publication contains operation and troubleshooting information for PIC (Product Integrated Control) 5, a system for controlling 19XR semi-hermetic centrifugal liquid chillers. This publication is based on 19XR PIC5 Version 3.3 software (SCG-SR-20M200320).

The PIC 5 control system monitors and controls all operations of the chiller. The microprocessor control system matches the capacity of the chiller to the cooling load while providing state-of-the-art chiller protection. The

system controls cooling load within the set point plus or minus the dead band by sensing the water or brine temperature and regulating the inlet guide vane via a mechanically linked actuator motor, and regulating VFD (variable frequency drive) speed if the compressor is powered by a variable speed drive. The guide vane is a variable flow pre-whirl assembly that controls the refrigeration effect in the cooler by regulating the amount of refrigerant vapor flow into the compressor. An increase in guide vane opening increases capacity. A decrease in guide vane opening decreases capacity. The microprocessor-based control center protects the chiller by monitoring the digital and analog inputs and executing capacity overrides or safety shutdowns as necessary.

The PIC 5 control system also provides access to a Control Test function covering all outputs except compressor relay outputs.

Abbreviations Used in This Manual — The following abbreviations are used in this manual:

- CCM** — Chiller Control Module
- CCN** — Carrier Comfort Network®
- CCN mode** — Operating mode: CCN
- EC** — Envelop Control (Hot Gas Bypass)
- ECDW** — Entering Condenser Water
- ECW** — Entering Chilled Water
- EXV** — Electronic Expansion Valve
- HMI** — Human Machine Interface
- I/O** — Input/Output
- IOB** — Input/Output Board
- ISM** — Integrated Starter Module
- LCDW** — Leaving Condenser Water
- LCW** — Leaving Chilled Water
- LED** — Light-Emitting Diode
- LEN** — Local Equipment Network (internal communication linking the main board to slave boards)
- MCB** — Main Control Board
- PIC** — Product Integrated Control
- RLA** — Rated Load Amps
- SRD** — Split Ring Diffuser
- TFT** — Thin Film Transistor
- VFD** — Variable Frequency Drive
- UI** — User Interface

HARDWARE

The PIC 5 control system consists of one main control board, an ISM (integrated starter module), and four IOBs (input/output board modules). All boards communicate via an internal LEN bus. PIC 5 is also compatible with unit-mounted VFD options that do not utilize ISM. For this application a LEN to Modbus* protocol converter module is required.

Main Control Board — The main control board is supplied from a 24 VAC supply reference to earth ground. In the event of a power supply interrupt, the unit restarts automatically without the need for an external command. However, any faults active when the supply is interrupted are saved, and may in certain cases prevent a circuit or unit from restarting. Figure 1 shows the main control interface and connectors.

⚠ CAUTION

Maintain the correct polarity when connecting the power supply to the boards. Otherwise, the boards may be damaged.

ISM (Integrated Starter Module) — The ISM is the motor control module, supplied from a 115 VAC supply reference to earth ground. Table 1 lists ISM inputs and outputs. ISM wiring diagrams are shown in Appendix E.

*Modbus is a registered trademark of Schneider Electric.

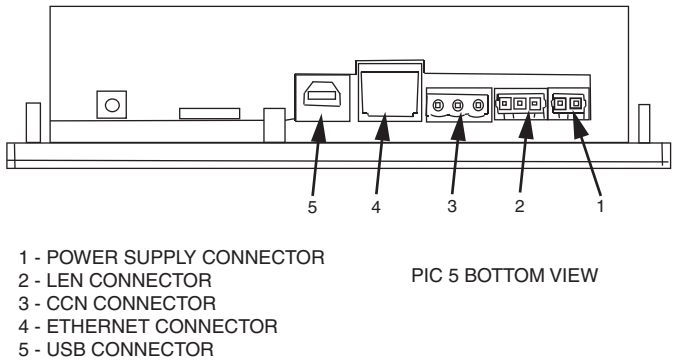
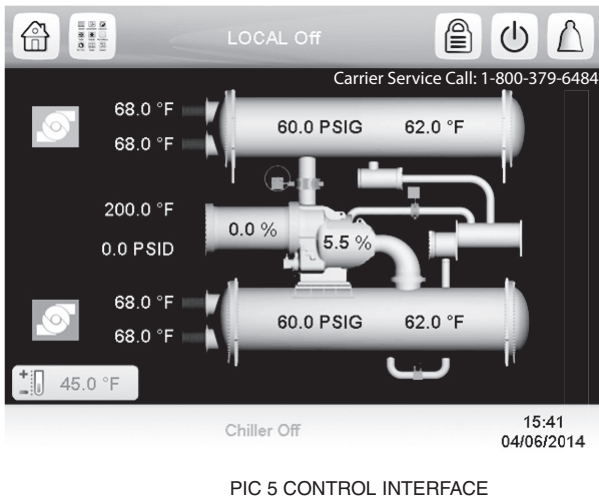

Fig. 1 — PIC 5 Control Interface and Connectors

Table 1 — ISM Input/Output Descriptions

DESCRIPTION	POINT NAME	TYPE	PIN NUMBER	INPUT/OUTPUT
Communication	COMM	Dry Contact	J7-A,B,C	Input/Output
Compressor Run Contact	RUN_AUX	Dry contact	J2-11,12	Input
Compressor Start Contact	STAR_AUX	Dry contact	J2-9,10	Input
Compressor Start Relay	COMP_SR	Relay	J9-1,2	Output
Compressor Transition Relay	TRANS	Relay	J9-3,4	Output
Ground Fault Phase 1	GRFLT_31	0 to 5 V	J5-1,2	Input
Ground Fault Phase 2	GRFLT_23	0 to 5 V	J5-3,4	Input
Ground Fault Phase 3	GRFLT_12	0 to 5 V	J5-5,6	Input
Line Current C1	LN_AMPS1	0 to 5 A (RMS)	J4-1,2	Input
Line Current C2	LN_AMPS2	0 to 5 A (RMS)	J4-3,4	Input
Line Current C3	LN_AMPS3	0 to 5 A (RMS)	J4-5,6	Input
Line Voltage V1	LN_VOLT1	0 to 575 VAC	J3-1	Input
Line Voltage V2	LN_VOLT2	0 to 575 VAC	J3-2	Input
Line Voltage V3	LN_VOLT3	0 to 575 VAC	J3-3	Input
Shunt Trip Relay	TRIPR	Relay	J9-5,6	Output
Starter Fault	STARTFELT	Dry contact	J2-7,8	Input
VFD Speed Feedback	VFD_IN	0 to 5 V (default), or 0 to 10 V (selectable)	J6-1,2	Input
VFD Target Speed	VFD_OUT	0 to 20 mA	J8-1,2	Output

IOB (Input/Output Board) — The IOB is supplied from a 24 VAC supply reference to earth ground.

IOB CONFIGURATION — The input/output boards can be configured for different types of input/output. If an input or output type is supported for the specific channel then it can be modified in the Configuration Menu as shown in Table 2:

Table 2 — IOB Configuration

ANALOG INPUT		ANALOG OUTPUT	
0	Disable	0	Disable
1	0 to 5 VDC	1	4 to 20 mA
2	4 to 20 mA	2	0 to 10 VDC
3	10 kΩ (thermistor)		
4	5 kΩ (thermistor)		
5	Ohm (Shift_Dis)		
6	100 Ohm RTD		

19XR6/7 IOB COMPONENTS AND WIRING — The components listed in Tables 3-6 are available at the user's terminal block on the IOB. Some are available only if the unit is

operating in Remote mode. Fig. 2-5 show IOB wiring diagrams. Fig. 6-9 shows additional control wiring.

Communication Cables — The communication transmission cables have the following electrical characteristics:

- 2 signal conductors and one ground conductor of 20 AWG or larger, 100% shielded
- One tinned copper braid (65% coverage)

Recommended cables are shown below:

USAGE	CABLE
Intra-Building	Belden 8772
High Temperature	Belden 85240
Plenum	Belden 89418

To avoid potential interference, route communication cables between the starter and the chiller control panels as far away as possible from high voltage cable and other likely disturbances. Always separate communication cables from other cables and always run wiring as directly as possible.

Table 3 — 19XR6/7 IOB1 Connections

DESCRIPTION	CHANNEL	TERMINAL	TYPE	OPTIONAL
Entering Chilled Water Temperature	AI1	J16-1,5	5 kΩ	—
Leaving Chilled Water Temperature	AI2	J16-2,6	5 kΩ	—
Entering Condenser Water Temperature	AI3	J16-3,7	5 kΩ	—
Leaving Condenser Water Temperature	AI4	J16-4,8	5 kΩ	—
Evaporator Refrigerant Liquid Temperature	AI5	J15-6,12	5 kΩ	—
Discharge Gas Temperature	AI6	J15-5,11	5 kΩ	—
Condenser Pressure	AI7	J15-4	5 VDC	—
Evaporator Pressure	AI8	J15-3	5 VDC	—
Economizer Pressure	AI9	J15-2	5 VDC	—
FS VFD Load Current	AI10	J15-1,7	4 to 20 mA	Yes
Chiller Status Output (ON=20mA, OFF=4mA, TRIPOUT=8mA, Not Off and Compressor not running=12mA)	AO1	J14-1,4	4 to 20 mA	Yes
Oil EXV Output	AO2	J14-2, 5	4 to 20 mA	Yes
Chiller Lockout Input	DI1	J13-5 (4TB-2)	24 VAC	Yes, NO (dry contact)
Fire Alarm Interlock	DI2	J13-6 (4TB-4)	24 VAC	Yes, NO (dry contact)
Remote Contact Input	DI3	J13-7 (4TB-6)	24 VAC	Yes, NO (dry contact); closed indicates start chiller signal
Remote Emergency Stop Input	DI4	J13-8 (4TB-8)	24 VAC	Yes, NO (dry contact); closed indicates stop chiller signal
Stage 1 IGV Increase	DO1	J12-7	24 VAC	Yes
Stage 1 IGV Decrease	DO2	J12-10	24 VAC	Yes
Chiller Alarm Relay	DO3	J12-2	24 VAC	Yes
Chiller Alert Relay	DO4	J12-5	24 VAC	Yes

LEGEND

EXV — Electronic Expansion Valve
FS — Fire Security
IGV — Inlet Guide Vane
IOB — Input/Output Board
NO — Normally Open
VFD — Variable Frequency Drive

NOTES:

1. See Fig. 2 for IOB1 wiring diagram.
2. For pressure readings, only Vout (output) terminal is indicated. See Fig. 2 for Vin (+) and ground (-).
3. Defaults are shown. In some cases the IOB can be configured differently depending on job requirements.

Table 4 — 19XR6/7 IOB2 Connections

DESCRIPTION	CHANNEL	TERMINAL	TYPE	OPTIONAL
Motor Winding Temperature 1	AI1	J16-1,5	5 kΩ	—
Motor Winding Temperature 2	AI2	J16-2,6	5 kΩ	—
Motor Winding Temperature 3	AI3	J16-3,7	5 kΩ	—
Oil Supply Temperature	AI4	J16-4, 8	5 kΩ	Yes
Oil Sump Temperature	AI5	J15-6,12	5 kΩ	—
Oil Supply Pressure	AI6	J15-5	5 VDC	—
Oil Sump Pressure	AI7	J15-4	5 VDC	—
Auto Demand Limit Input	AI8	J15-3,9	4 to 20 mA	Yes
Refrigerant Leak Sensor	AI9	J15-2,8	4 to 20 mA	Yes
Displacement Switch	AI10	J15-7	Ohm	—
Guide Vane 1 Output	AO1	J14-1,4	4 to 20 mA	—
Damper Valve Feedback Fully Open	DI1	J13-5	24 VAC	—
Damper Valve Feedback Fully Close	DI2	J13-6	24 VAC	—
High Pressure Switch	DI3	J13-7,3	24 VAC	—
Ice Build Contact	DI4	J13-8,4, (4TB-12)	24 VAC	Yes, NO (dry contact)
Oil Heater Relay	DO1	J12-7	24 VAC	—
Oil Pump Relay	DO2	J12-10	24 VAC	—
Economizer Damper Valve Open	DO3	J12-2	24 VAC	—
Economizer Damper Valve Close	DO4	J12-5	24 VAC	—

LEGEND

IOB — Input/Output Board
NO — Normally Open

NOTES:

1. See Fig. 3 for IOB2 wiring diagram.
2. For pressure readings, only Vout (output) terminal is indicated. See Fig. 3 for Vin (+) and ground (-).
3. Defaults are shown. In some cases the IOB can be configured differently depending on job requirements.

Table 5 — 19XR6/7 IOB3 Connections

DESCRIPTION	CHANNEL	TERMINAL	TYPE	OPTIONAL
Low Speed ME Bearing Temperature	AI1	J16-1,5	5 kΩ	—
Low Speed CE Bearing Temperature	AI2	J16-2,6	5 kΩ	—
High Speed ME Bearing Temperature	AI3	J16-3,7	5 kΩ	—
High Speed CE Bearing Temperature	AI4	J16-4,8	5 kΩ	—
Remote Reset Temperature	AI5	J15-6,12	5 kΩ	Yes
Guide Vane 1 Actual Position	AI6	J15-5,11	4 to 20 mA	—
Common Chilled Water Supply (CHWS) Temperature	AI7	J15-4, 10	5 KOhm	Yes
Auto Water Temperature Reset	AI8	J15-3,9	4 to 20 mA	Yes
Common Chilled Water Return (CHWR) Temperature	AI9	J15-2, 8	5 KOhm	Yes
Head Pressure Output	AO1	J14-1,4	4 to 20 mA	Yes
EC/HGBP Valve Feedback Fully Open	DI1	J13-5	24 VAC	—
EC/HGBP Valve Feedback Fully Close	DI2	J13-6	24 VAC	—
Spare Safety	DI3	J13-7 (4TB-12)	24 VAC	Yes, NO (dry contact)
Power Request Feedback	DI4	J13- 8	24 VAC	Yes
EC/HGBP Solenoid / Open	DO1	J12-7	24 VAC	—
EC/HGBP Close	DO2	J12-10	24 VAC	—
Free Cooling Mode	DO3	J12-2	24 VAC	Yes
Power Request Output	DO4	J12-5	24 VAC	Yes

LEGEND
CE — Compressor End
EC — Envelop Control
HGBP — Hot Gas Bypass
IOB — Input/Output Board
ME — Motor End
NO — Normally Open

NOTES:
 1. See Fig. 4 for IOB3 wiring diagram.
 2. For pressure readings, only Vout (output) terminal is indicated. See Fig. 4 for Vin (+) and ground (-).
 3. Defaults are shown. In some cases the IOB can be configured differently depending on job requirements.

Table 6 — 19XR6/7 IOB4 Connections

DESCRIPTION	CHANNEL	TERMINAL	TYPE	OPTIONAL
Entering Evaporator Water Pressure	AI3	J16-7	5 VDC	Yes
Leaving Evaporator Water Pressure	AI4	J16-8	5 VDC	Yes
Entering Condenser Water Pressure	AI5	J15-6	5 VDC	Yes
Leaving Condenser Water Pressure	AI6	J15-5	5 VDC	Yes
Evaporator Water Flow Measurement	AI8	J15-3, 9	4 to 20 mA	Yes
Condenser Water Flow Measurement	AI9	J15-2, 8	4 to 20 mA	Yes
Chilled Water Pump (Variable)	AO1	J14-1, 4	4 to 20 mA	Yes
Condenser Water Pump (Variable)	AO2	J14-2, 5	4 to 20 mA	Yes
Tower Fan (Variable)	AO3	J14-3, 6	4 to 20 mA	Yes
Evap Water Flow Switch	DI1	J13-1, 5	24 VAC	Yes, NO (dry contact), closed = flow
Condenser Water Flow Switch	DI2	J13-2, 6	24 VAC	Yes, NO (dry contact), closed = flow
Customer Alert	DI3	J13-3, 7	24 VAC	Yes, NO (dry contact)
Free Cooling Start Switch	DI4	J13-4, 8	24 VAC	Yes, NO (dry contact), closed = flow
Chilled Water Pump	DO1	J12-7	24 VAC	Yes
Condenser Water Pump	DO2	J12-10	24 VAC	Yes
Tower Fan High	DO3	J12-2	24 VAC	Yes
Tower Fan Low	DO4	J12-5	24 VAC	Yes

LEGEND
IOB — Input/Output Board
NO — Normally Open

NOTES:
 1. See Fig. 5 for IOB4 wiring diagram.
 2. For pressure readings, only Vout (output) terminal is indicated. See Fig. 5 for Vin (+) and ground (-).
 3. Defaults are shown. In some cases the IOB can be configured differently depending on job requirements.

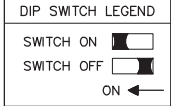

BLACK IS RAISED PORTION OF SWITCH

1 11/64 [29.85]

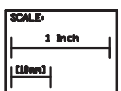
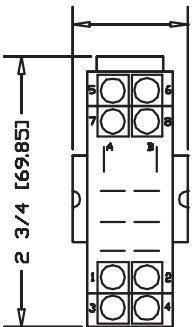

19XV05005503 BASE DIMENSIONS (REFERENCE)
DIMENSIONS IN INCHES [MM]

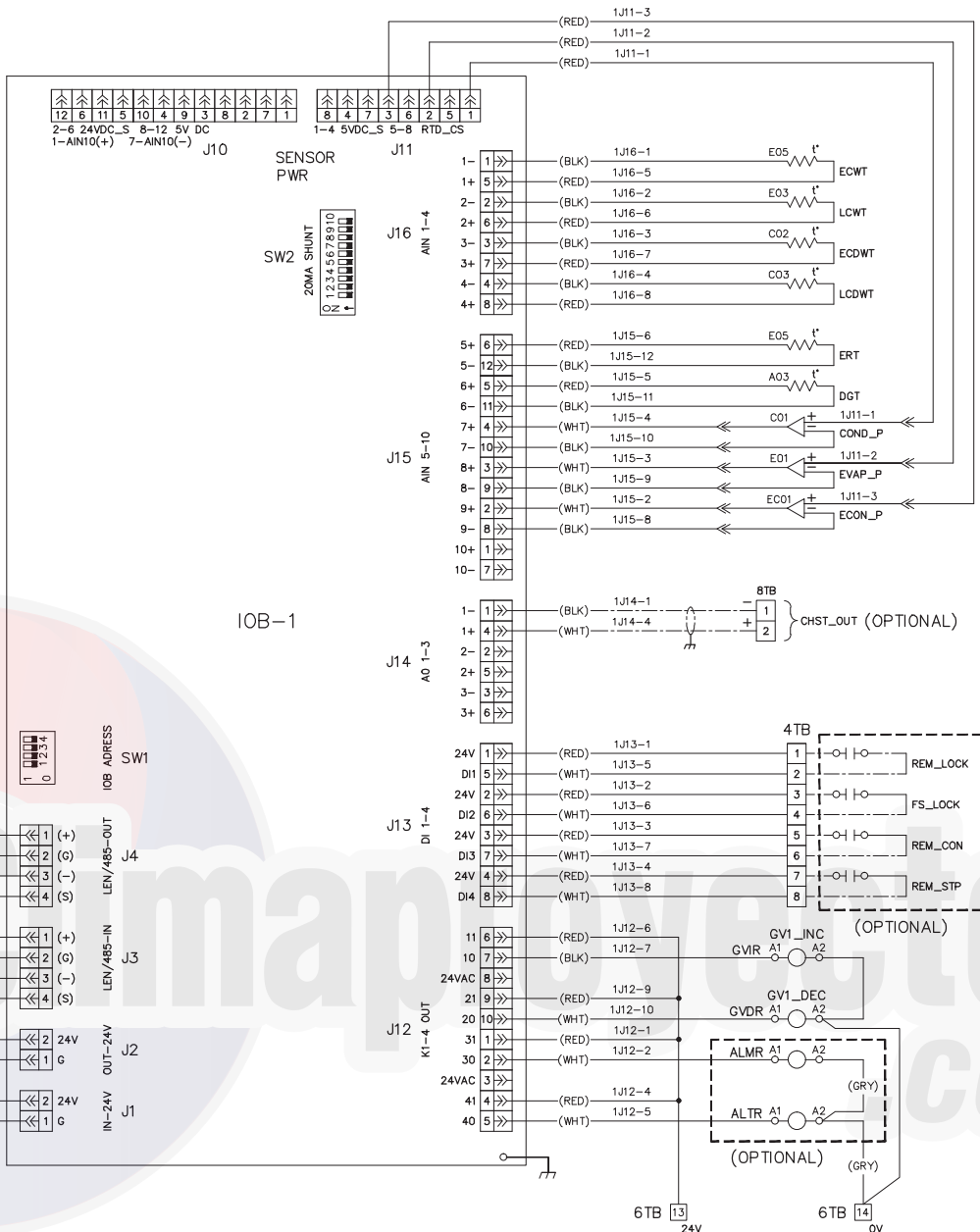

NOTE: A suitable 24 VAC relay is Carrier part number 19XV05005503. Carrier recommends using a relay with a contact rating of 10 amp sealed RMS or greater.

LEGEND FOR FIG. 2-6

- COMPONENT TERMINAL
- CONDUCTOR MALE/FEMALE CONNECTOR
- FIELD WIRING
- OPTIONAL WIRING
- COMPONENT/PANEL ENCLOSURE
- TERMINAL BLOCK FOR FIELD WIRING
- TERMINAL BLOCK FOR INTERNAL CONNECTION
- WIRE SPLICE

PART NO.	NO. OF PIN
19X4003501	2 PIN
19X4003502	4 PIN
19X4003503	6 PIN
19X4003504	8 PIN
19X4003505	10 PIN
19X4003506	12 PIN

Fig. 2 — IOB 1

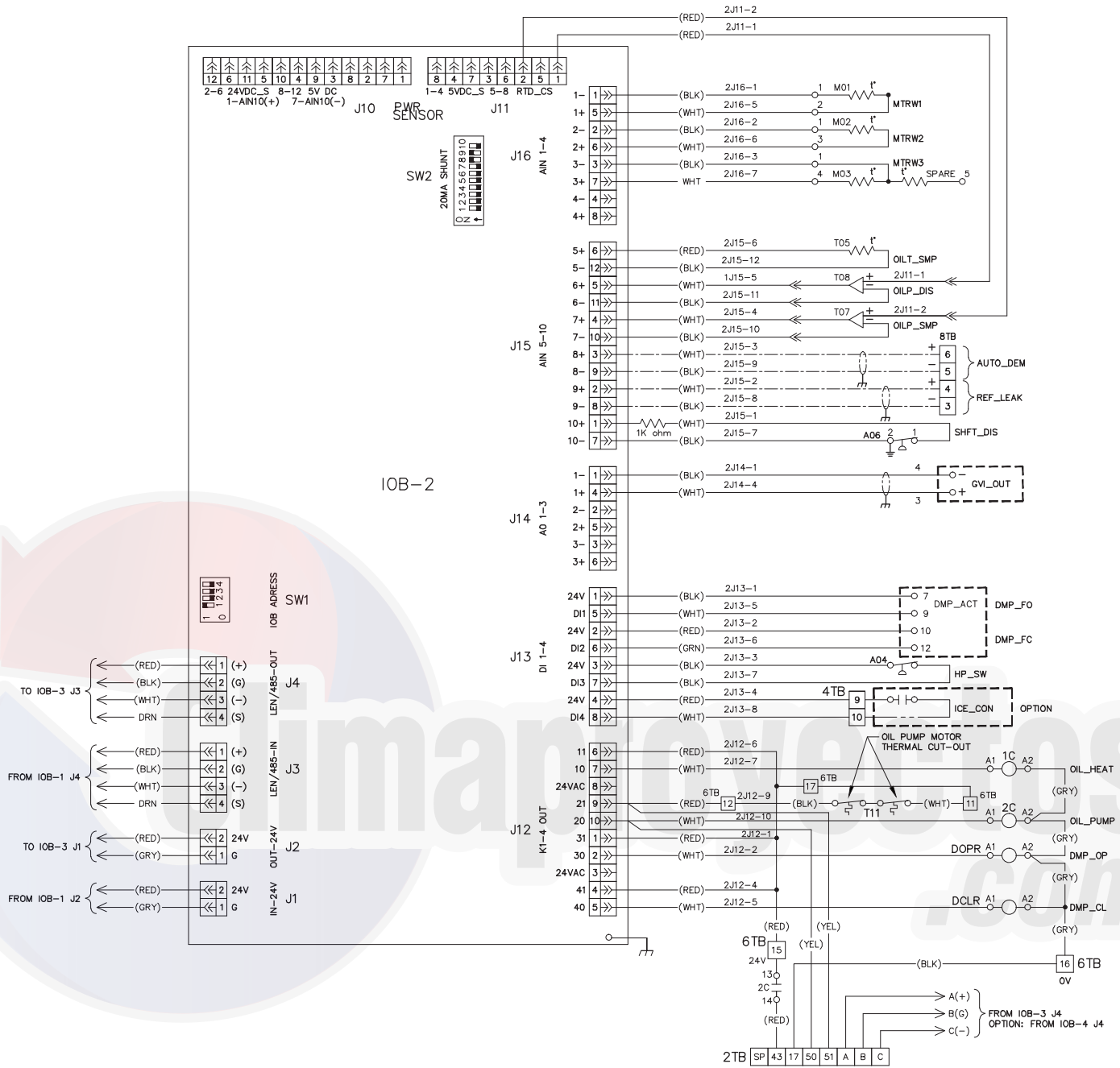

Fig. 3 — IOB 2

CONNECTORS TO DAMPER VALVE – FERRULE
 CONNECTOR TO IGV – #16-22 FORK TERMINAL.

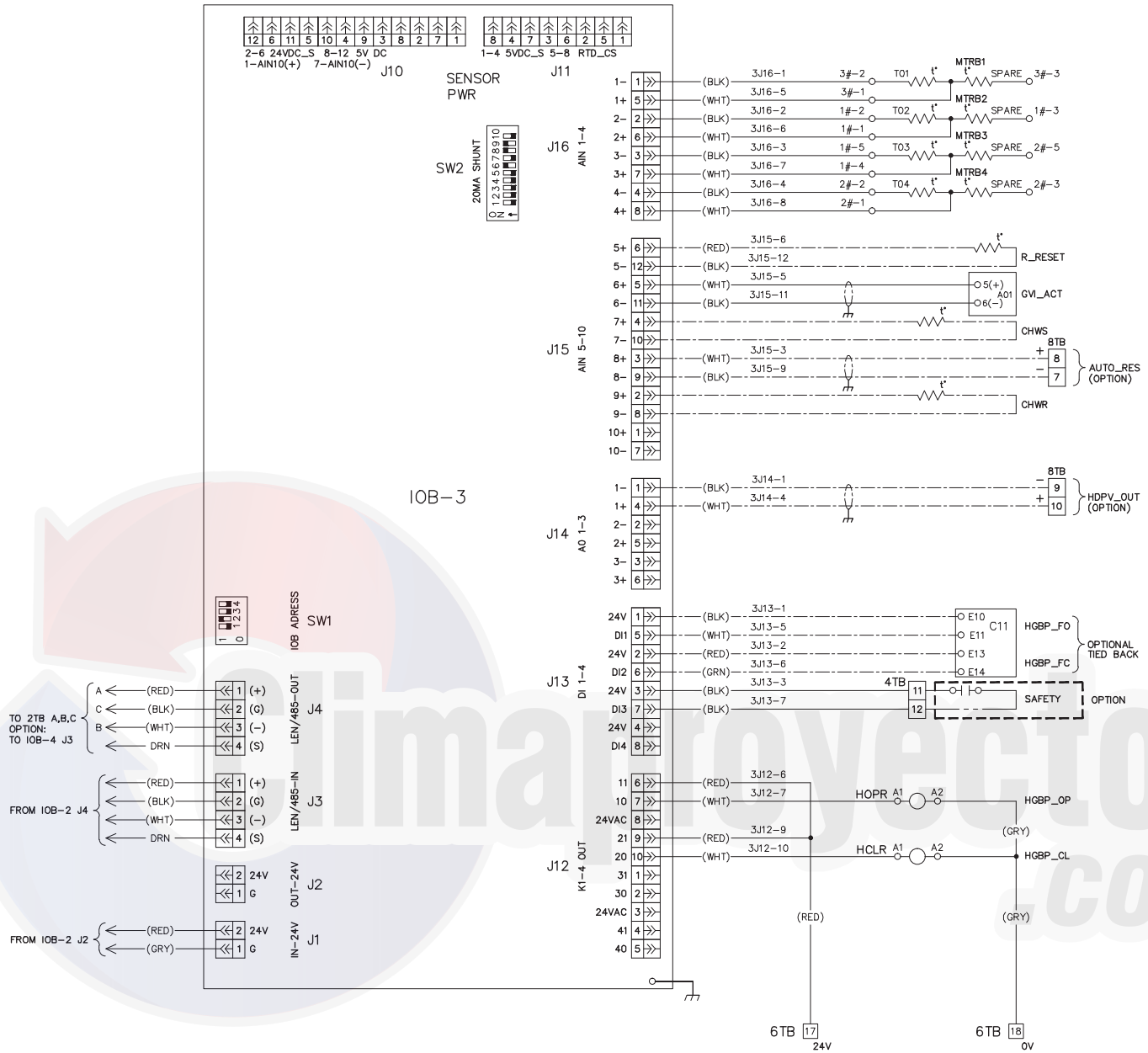

Fig. 4 — IOB 3

NOTE:
 ALL CONNECTIONS ON THIS PAGE ARE OPTIONAL.
 3TB IS INCLUDED IN CONTROL BOX BUT NOT
 CONNECTED TO RELAY CONTACTS.
 CUSTOMER NEEDS TO SUPPLY ALL RELAYS ON THIS PAGE.
 RELAY SPEC:
 COIL: 24VAC/RLA: 1.8 AMPS.

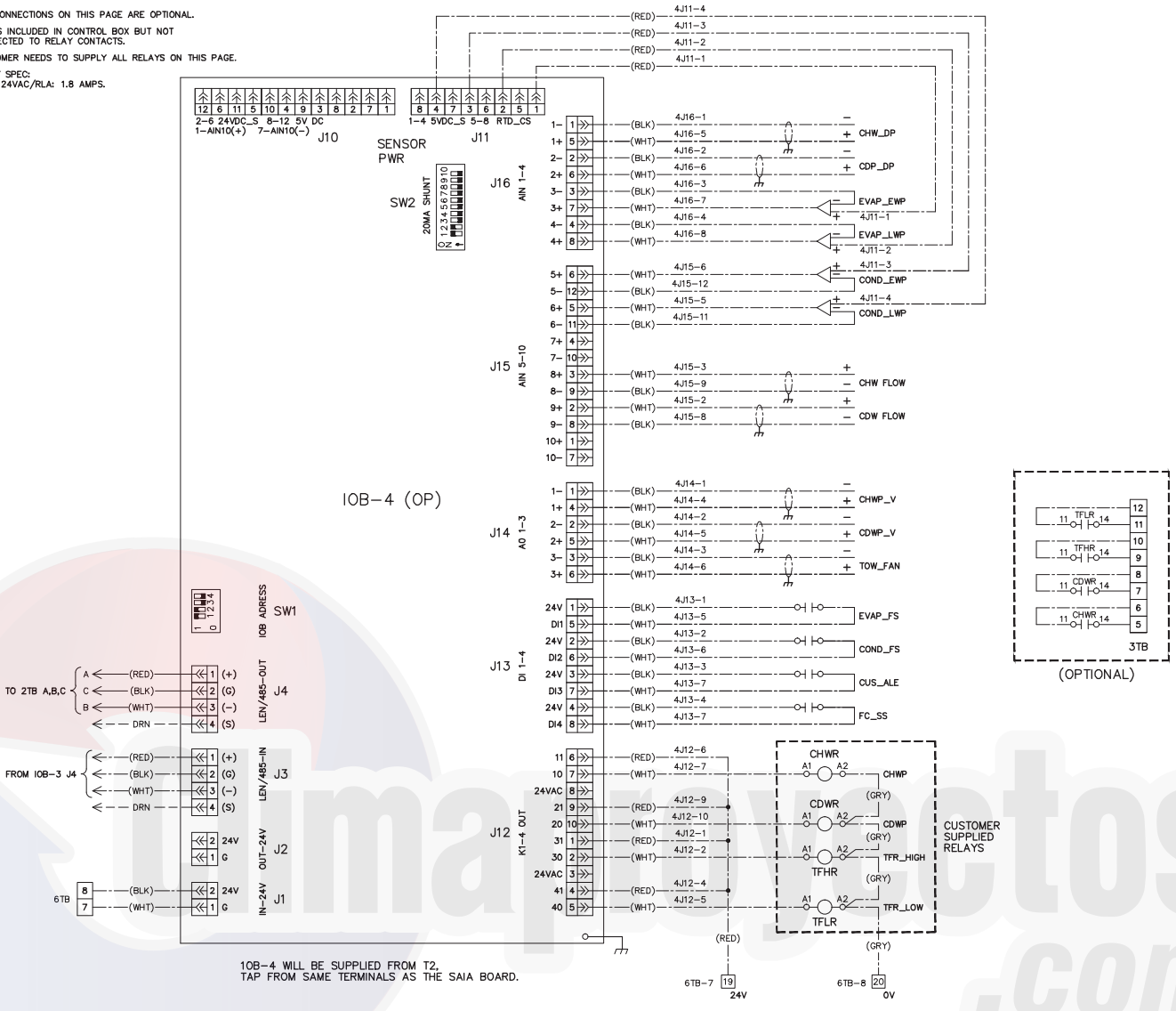

Fig. 5 — IOB 4

LUG CAPACITY: 8AWG MAX

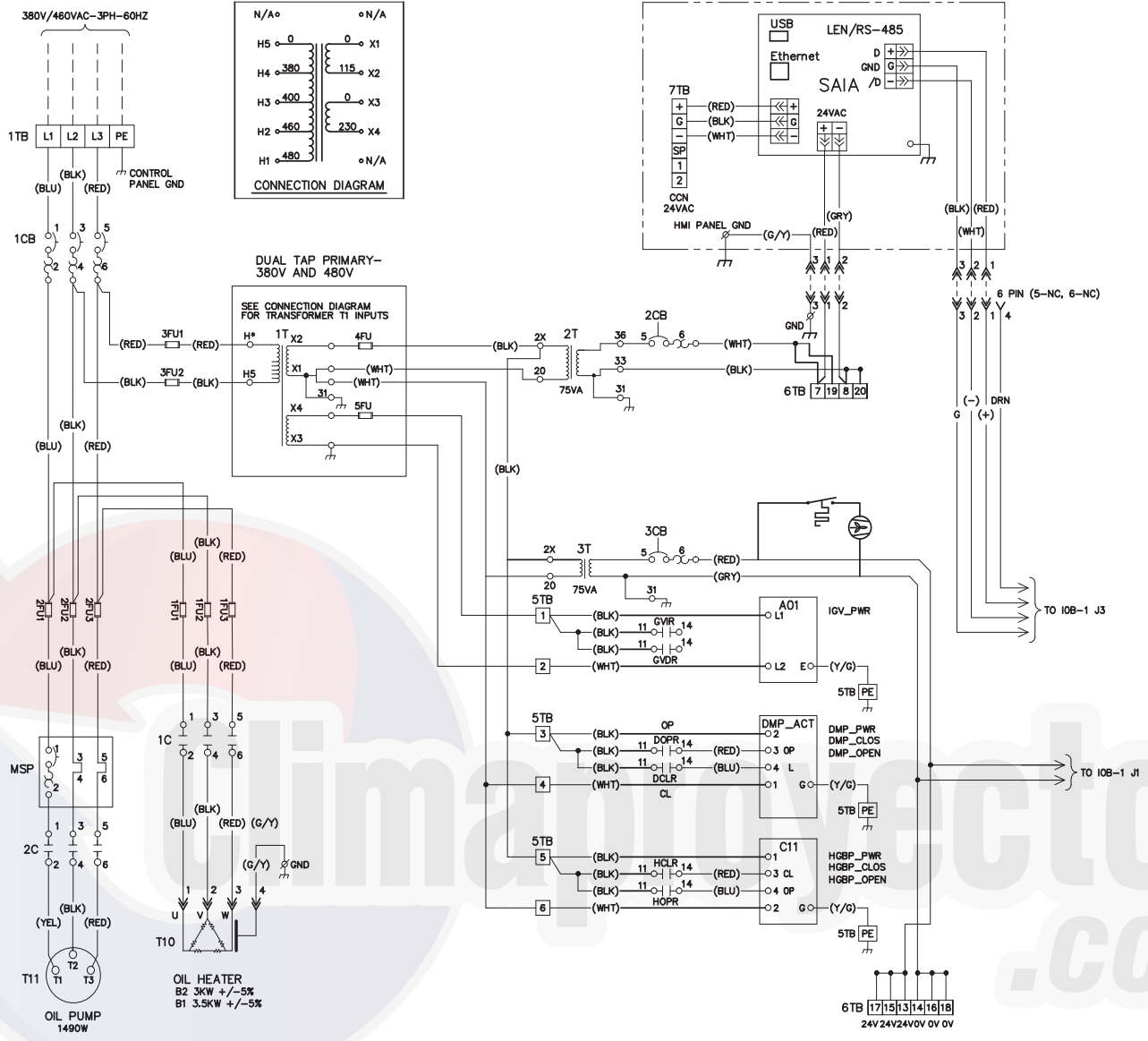

Fig. 6 — 19XR6/7 Control Wiring

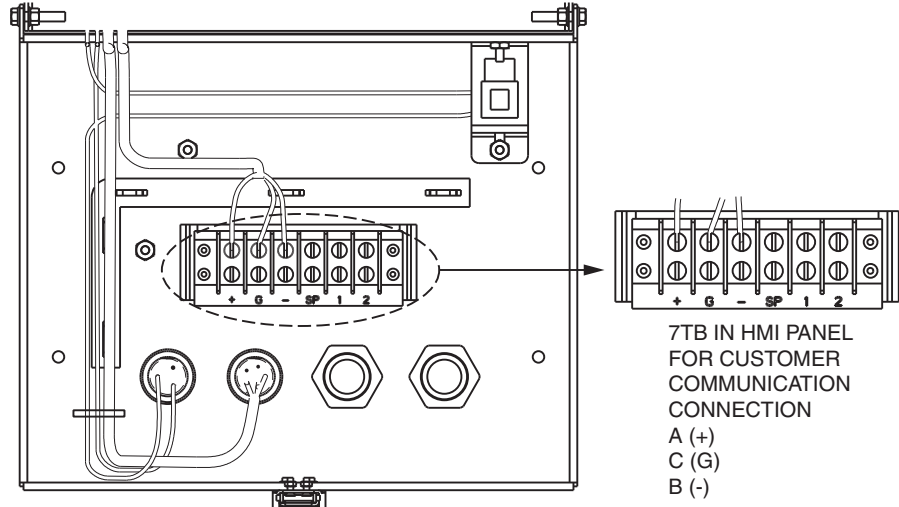

Fig. 7 — HMI Panel

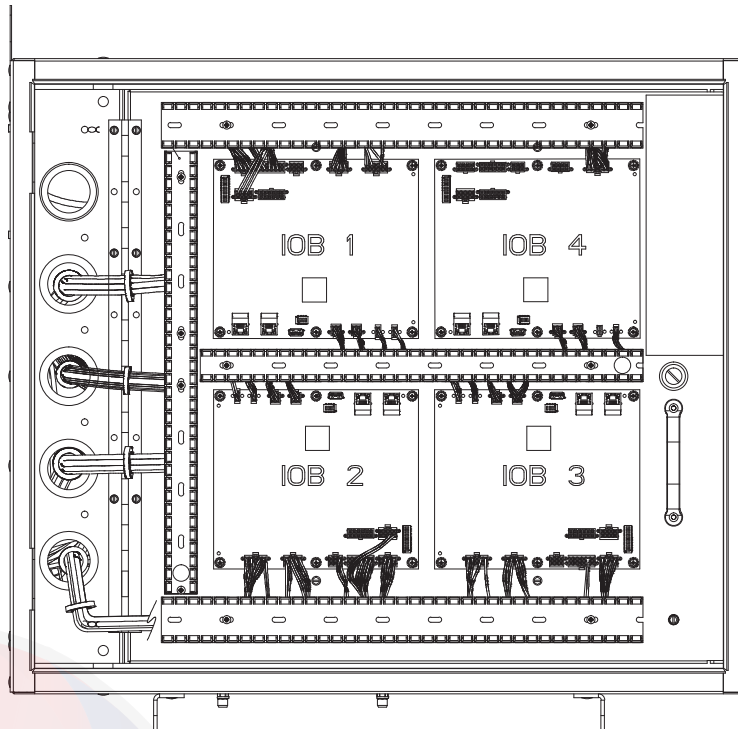

Fig. 8 — 19XR6/7 Control Panel, IOB Layer

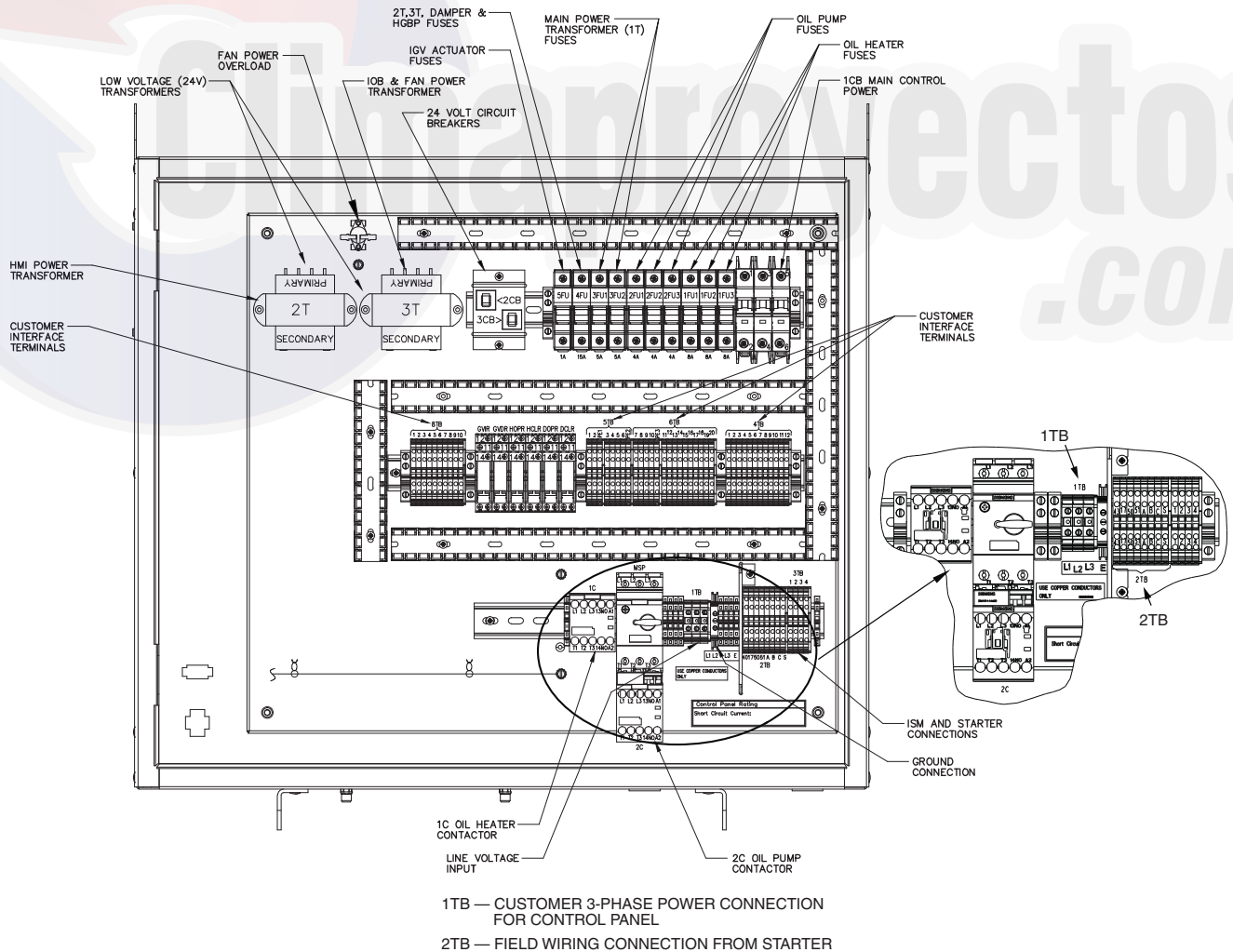

Fig. 9 — 19XR6/7 Control Panel, Bottom Layer

Sensors

PRESSURE TRANSDUCERS — Pressure transducers measure and control the pressures in the unit. These electronic sensors deliver 0 to 5 VDC. The transducers can be calibrated through the controller. The pressure transducers are connected to the IOBs. See Table 7.

Table 7 — Pressure Transducers

PRESSURE TRANSDUCER	PURPOSE
Evaporator	Measures evaporator pressure
Condenser	Measures condenser pressure
Economizer	Measures economizer pressure (if economizer)
Oil Supply	Measures oil pressure in the oil discharge piping
Oil Sump	Measures oil pressure in the oil sump
Evaporator Water Pressure Difference	(Optional) Measures pressure difference between entering and leaving water.
Condenser Water Pressure Difference	(Optional) Measures pressure difference between entering and leaving water.
Evaporator Entering Water	(Optional) Measures pressure of evaporator entering water
Evaporator Leaving Water	(Optional) Measures pressure of evaporator leaving water
Condenser Entering Water	(Optional) Measures pressure of condenser entering water
Condenser Leaving Water	(Optional) Measures pressure of condenser leaving water

TEMPERATURE SENSORS — The system uses electronic sensors to measure and control the temperatures in the unit. There are three types of temperature sensors: 5K thermistor, 10K thermistor, and RTD (resistance temperature detector, 100 ohm, 3-wire) based on IOB channel configurations. The temperature sensor range is -40 F (-40 C) to 245 F (118 C). See Table 8.

Table 8 — Temperature Sensors

TEMPERATURE SENSOR	PURPOSE
Entering Chilled Water	Measures entering evaporator water temperature
Leaving Chilled Water	Measures leaving evaporator water temperature
Entering Condenser Water	Measures entering condenser water temperature
Leaving Condenser Water	Measures leaving condenser water temperature
Evaporator Refrigerant Liquid	Measures evaporator refrigerant liquid temperature
Compressor Discharge	Measures compressor discharge temperature
Low Speed Motor End Bearing	Measures temperature of the low speed motor end bearing temperature (02XR6/7)
Low Speed Compressor End Bearing	Measures temperature of the low speed compressor end bearing temperature (02XR6/7)
High Speed Motor End Bearing	Measures temperature of the high speed motor end bearing temperature (02XR6/7)
High Speed Compressor End Bearing	Measures temperature of the high speed compressor end bearing temperature (02XR6/7)
Motor Winding End	Sensor(s) measure the temperature of each phase of the compressor motor
Oil Sump	Measures the compressor sump oil temperature
Oil Supply	Measures the oil temperature in the oil discharge piping
Compressor thrust bearing oil temperature sensor	Measure compressor thrust bearing oil temperature (02XR2-5, 02XRE)

NOTE: Text in parentheses indicates applicable product.

Controls Outputs

EVAPORATOR/CONDENSER WATER PUMP — The controller can regulate an optional evaporator/condenser water pump.

INLET GUIDE VANE — The inlet guide vane adjusts the refrigerant vapor flow into the compressor to adapt to change in the operating conditions of the machine. To adjust the refrigerant flow, the guide vane opens or closes to vary the cross-section of the refrigerant path. The high degree of accuracy with which the guide vane is positioned ensures that the flow of refrigerant is precisely controlled.

ECONOMIZER DAMPER VALVE — The economizer damper control opens or closes the economizer damper valve to maintain a minimum refrigerant pressure difference between the evaporator and economizer.

ENVELOP CONTROL/HGBP VALVE — The hot gas bypass function artificially loads the chiller and keeps it running under low load conditions or helps to prevent surge conditions. Since this function can also reduce the operating efficiency of the machine, this is a user-selectable and configurable option.

VFD — The VFD modifies motor frequency to allow compressor start-up and capacity control. The VFD controls continually monitor parameters in order to ensure compressor protection. Should a problem occur, the controller triggers an alarm and the compressor is stopped.

PIC 5 USER INTERFACE

The PIC 5 Human Machine Interface (HMI) is a color 10.4-in. TFT touch screen. Navigation is either direct from the touch screen interface or by connecting to a web interface at the Ethernet IP port of the controller. The navigation menus are the same for both connection methods.

Web Connection — Two web connections may be authorized at the same time. When two users are connected simultaneously, there is no priority between users; that is, the last modification is in effect regardless of the user.

Connection is from a personal computer using a Java-enabled web browser. See the section Touch Screen Settings for the Controller on page 49 for configuration instructions. The minimum browser configuration includes:

- Microsoft Internet Explorer (version 8 or higher) or Mozilla Firefox (version 3.5.2 or higher). In the advanced connection options, add the unit address to the address list. Do not use a proxy server.
- Java platform (version 6 or higher). In the control panel, deselect (uncheck) the option that allows storing temporary internet files and use a direct connection.

To access the PIC 5 user interface, enter the IP address of the unit in the address bar of the web browser. The IP address can be viewed or changed from the PIC 5 interface. For more information on the web browser and Java platform configuration, see the Diagnostics and Troubleshooting section.

General Interface Features

ICONS — Table 9 shows general interface icons.

Table 9 — Interface Icons

ICON	MEANING
	Green: Indicates unit is running Gray: Indicates unit is off
	Home
	Main menu
	Indicates user is logged off
	Indicates user is logged in
	Gray: Indicates no alarm or alert is active Red: Indicates alarm or alert
	Back (not visible in main menu)
	Previous and next screen

SCREENS — The Human Machine Interface includes the following screens:

- Welcome screen
- Home screen, which displays the main parameters
- Menu screens for navigation

LEGEND

- Home Screen Access Button
- Main Menu Access Button
- User Login Screen Access Button
- Unit Start/Stop Access Button
- Alarm Menu Access Button
- Condenser Saturated Temperature and Pressure
- Evaporator Saturated Temperature and Pressure
- Guide Vane Position Percentage
- Unit Capacity Percentage (Motor Load Current Percentage)
- Set Point
- Evaporator Pump Status (Hydraulic System Option is Enabled)
- Evaporator Water Inlet and Outlet Temperature
- Oil Pressure Delta
- Oil Temperature
- Condenser Pump Status (Hydraulic System Option is Enabled)
- Condenser Inlet and Outlet Temperature

- Data/configuration screens, which list the parameters by type
- Operating mode selection screen
- Password entry and language selection screen
- Parameter modification screen
- Time schedule screen

If the interface is not used for a long period, it goes into screen-saver mode and displays a black screen. However, the control is always active and the unit operating mode remains unchanged. When the user presses the black screen, the Welcome screen is displayed.

Welcome Screen — The Welcome screen (see Fig. 10) is displayed when the unit is switched on or when the user presses the screen when the interface has gone into screen-saver mode. The Welcome screen displays the current software version number. To exit from this screen, press the Home icon



Fig. 10 — Welcome Screen

System Overview (Home) Screen — Figure 11 shows the system overview screen. Press a component image to see current status. For details, see Status Display Screens on page 16.

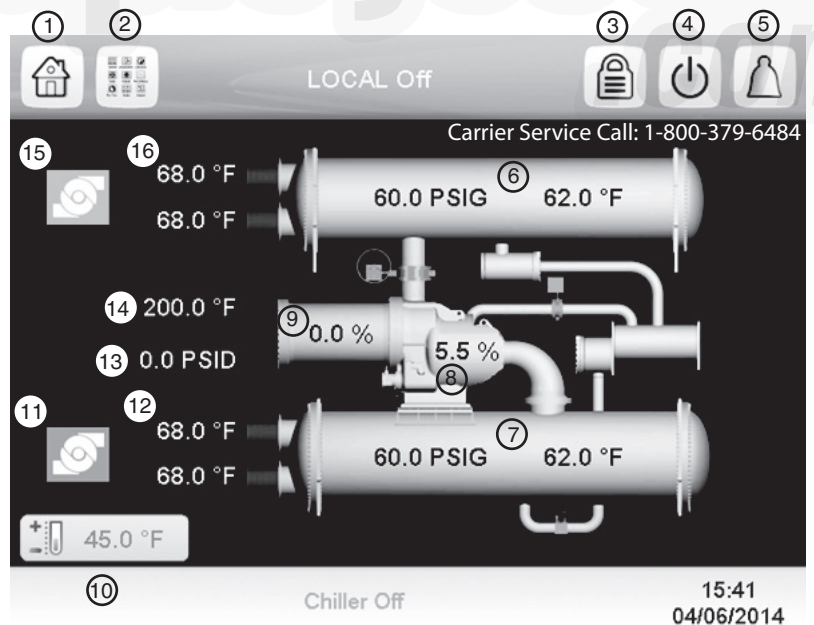

Fig. 11 — System Overview (Home) Screen

Messages — The Set Point screen, On/Off screen, User Login screen, and Main Menu screens described in the next sections may display status messages at the bottom of the screen. See Table 10.

Table 10 — Status Messages

MESSAGE	STATUS
COMMUNICATION FAILURE!	Equipment controller did not respond while reading the table content.
ACCESS DENIED!	Equipment controller does not allow access to one of the table data blocks.
LIMIT EXCEEDED!	The value entered exceeds the table limits.
Save changes?	Modifications have been made. The interface waits to confirm exit; press Save or Cancel.
HIGHER FORCE IN EFFECT!	Equipment controller rejected a Force or Auto command because the interface force level is lower than that of the equipment controller.

Set Point Screen — The Set Point screen displays the current set point table. See Fig. 12. For more information about these settings, see the Set Point section on page 19.



Fig. 12 — Set Point Screen

Unit Start/Stop Screen — The Unit Start/Stop screen allows the user to select the unit operating mode.

For unit start-up, with the unit in Local Off mode, press the gray Off icon to display the list of operating modes. Select the required mode to start up the chiller. See Fig. 13.

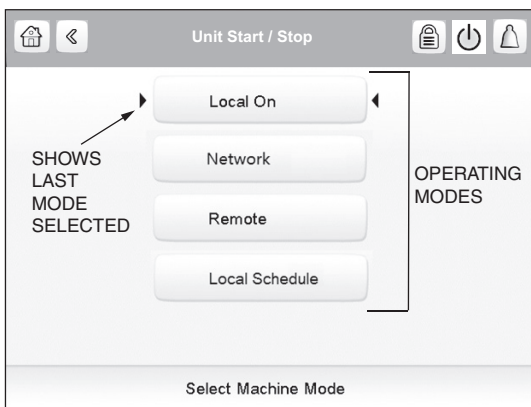

Fig. 13 — Unit Start/Stop Screen

When a start-up mode is selected, a status screen displays the progress of the start-up sequence (Fig. 14).

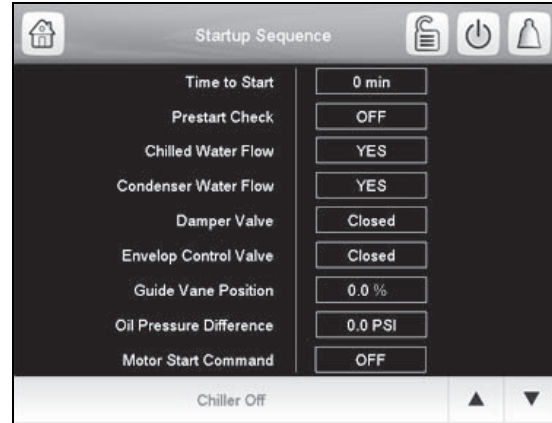

Fig. 14 — Start-Up Sequence Progress

To stop the unit, press the green On icon . Then press Confirm Stop to stop the unit, or press the Back icon to cancel the stop and return to the previous screen. See Fig. 15.

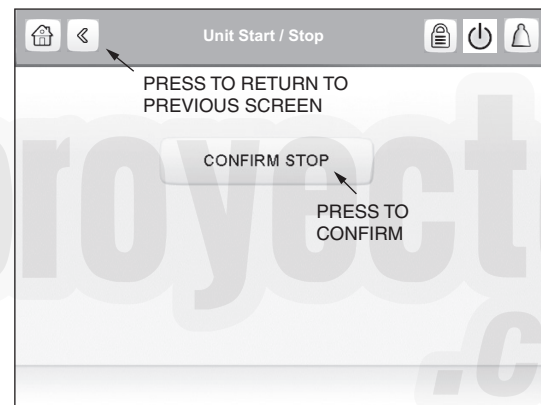
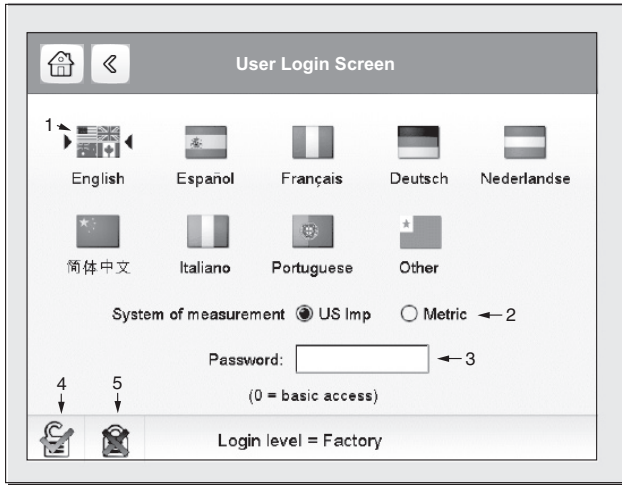

Fig. 15 — Confirm Stop

User Login Screen — Use this screen to login or log off and to set interface language and measurement system. See Fig. 16. There are three levels of password access:

- Basic access allows the user to view all data without a password.
- User access gives the user the additional ability to view and change many configuration settings, including set points and schedules. The default User password is 1111.
- Service access allows the user to test and change maintenance settings. The default Service (Advanced User) password is 2222.
- Factory access allows access to critical factory configuration settings. The default factory password is 4444.



LEGEND

- 1 — Arrows indicate active language
- 2 — Measurement system (Metric or US Imperial)
- 3 — Enter password
- 4 — Login
- 5 — Log off

Fig. 16 — User Login Screen

Main Menu Screen — To access the Main Menu screen, press the Main Menu icon. Press the icons on the screen to access the appropriate table or menu. Press the arrows at the bottom right corner, if present, to navigate through pages of tables. The options shown on the Main Menu screen depend on the user's level of access (see the section User Login Screen on page 14). Figure 17 shows the Main Menu screen as it appears for the User level of access.



Fig. 17 — Main Menu Screen (User Access)

Configuration Screen — To access the Configuration menu, press the Configuration icon on page 2 of the Main Menu (User, Service, or Factory access level). The Configuration menu opens. Then press the General Configuration icon on the Configuration menu. Press the arrows at the bottom right corner to navigate through pages. See Fig. 18. (Certain configuration settings are available only for Service or Factory access levels.) Refer to Appendix A, page 63 for more information about Configuration options.

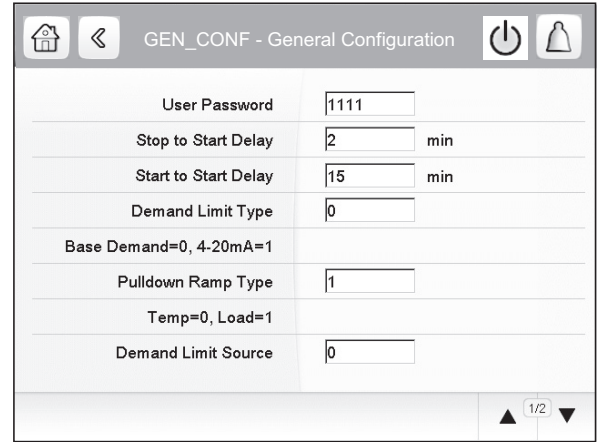

Fig. 18 — General Configuration Screen

After changing a value, press Return. The Save and Cancel icons are displayed. Press the Save icon to save the changed value. Figure 19 shows an example.

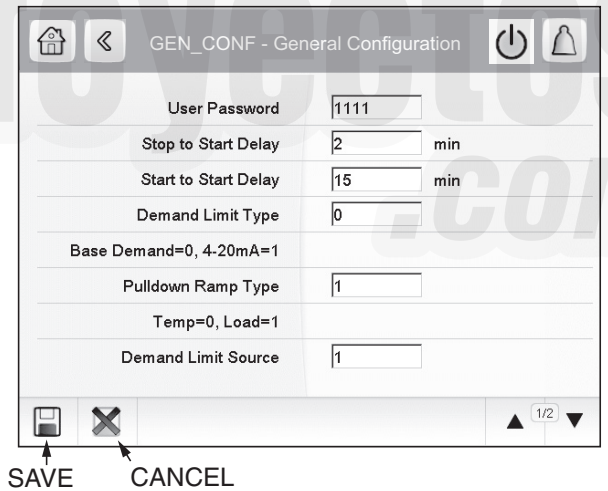



Fig. 19 — Saving a Change (General Configuration)

Schedule Menu Screen — To access the Schedule menu screen, press  on the Configuration menu screen. Select Local Schedule, Ice Build Schedule, or Network Schedule as applicable. Press the arrows at the bottom right corner to navigate through the time periods. See Fig. 20.

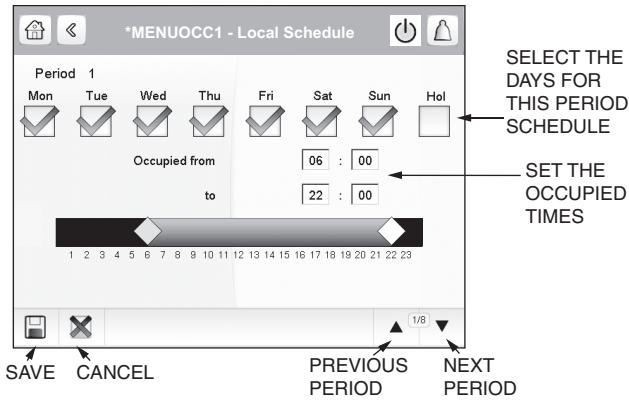

Fig. 20 — Local Schedule Menu Screen

Status Display Screens — Figure 21 shows the system status overview (home) screen. Press any component on the screen to see the status of that component. Press the arrows at the bottom right corner to navigate through the component status displays. Fig. 22-29 show the component status displays.

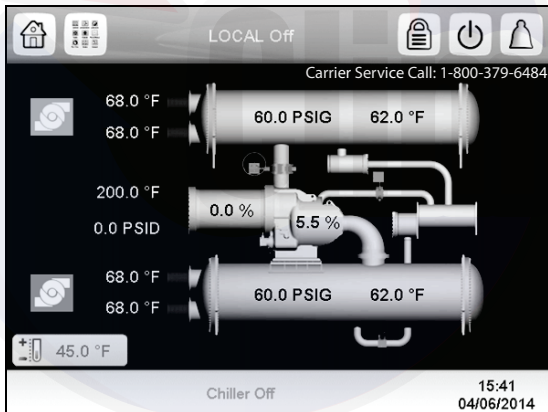

Fig. 21 — System Overview (Home) Screen

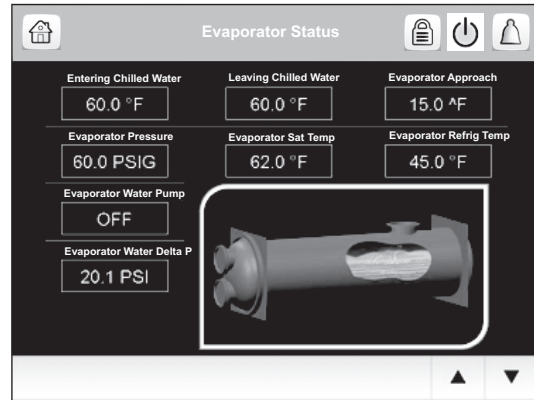

Fig. 23 — Evaporator Status

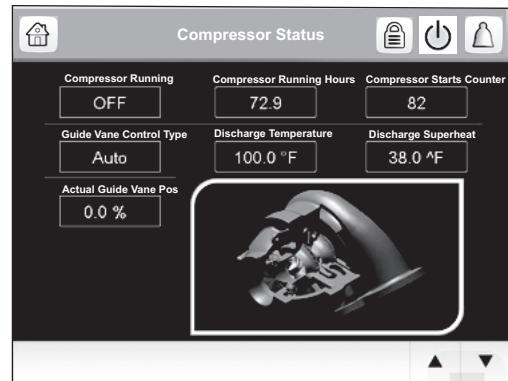

Fig. 24 — Compressor Status

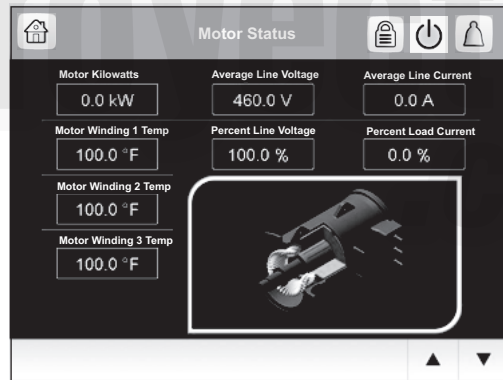

Fig. 25 — Motor Status

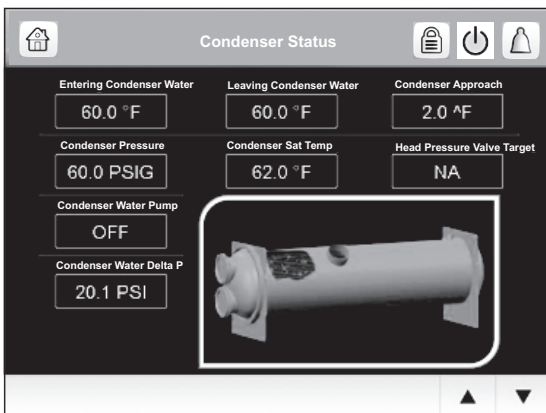
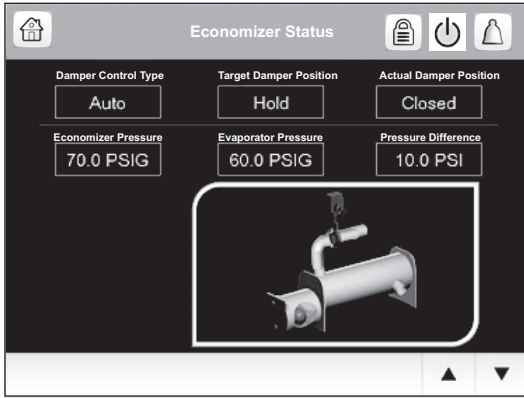

Fig. 22 — Condenser Status



NOTE: The pressure difference shown in this screen is the difference between economizer pressure and evaporator pressure.

Fig. 26 — Economizer Status

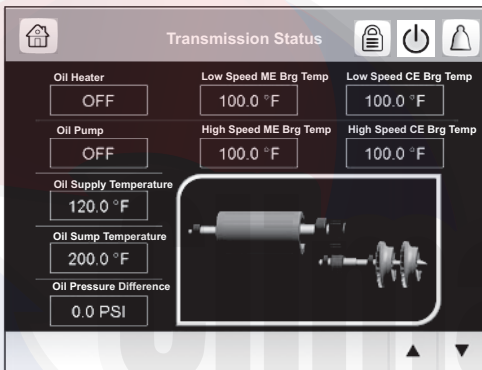

Fig. 27 — Transmission Status

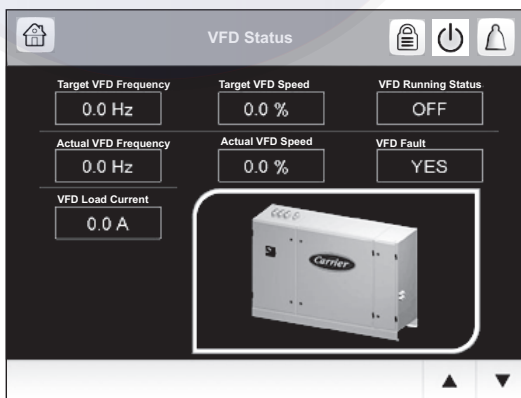

Fig. 28 — VFD Status

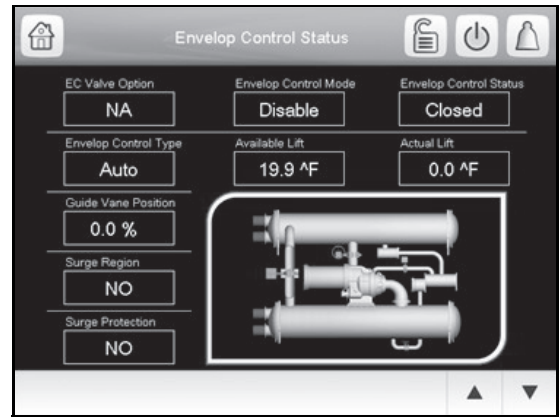

Fig. 29 — Envelop Control /HGBP (Hot Gas Bypass) Status

PIC 5 CONTROL OPERATION

Start-Stop Control — This function controls the chiller START-STOP command. The four selectable control modes are as follows: LOCAL, LOCAL SCHEDULE, REMOTE, or NETWORK. See Unit Start/Stop Screen on page 14. Specific control sources are valid to start or stop the chiller for each control mode.

LOCAL — When the control mode is LOCAL, the chiller can be started by the “Local ON” button on the PIC 5 interface screen, and can be shut down by the Confirm Stop button on the screen or by the EMSTOP software point.

LOCAL SCHEDULE — When the control mode is LOCAL SCHEDULE, the chiller will be started automatically if the configurable local schedule is Occupied. The chiller can be shut down by the unoccupied schedule, the Stop button on the PIC 5 interface screen, or by the EMSTOP software point.

REMOTE — When the control mode is REMOTE, the chiller will be started by the remote discrete input (REM_CON) located on the I/O board. The chiller can be shut down by the remote discrete input, the Stop button on the PIC 5 interface screen, or by the EMSTOP software point.

NETWORK — When the control mode is NETWORK, the chiller can be started and stopped by the CHIL_S_S and CHIL_OCC software points, which are written by other equipment through network commands and network schedule (both must be TRUE for chiller to start). To shut down the chiller, use the EMSTOP software point or stop using the HMI.

NOTE: There is a STOP OVERRIDE point in the GENUNIT table. If this point is enabled the chiller cannot be started.

Compressor Run Status — Compressor run status is shown at the top of the system overview (home) screen. Table 11 lists the chiller status numbers, names, and descriptions.

Table 11 — Compressor Run Status

STATUS NO.	STATUS NAME	DESCRIPTION
0	OFF	STATSTOP is STOP, no alarm.
1	CTLTEST	Controls Test is active.
2	PUMPDOWN	Pumpdown is active.
3	LOCKOUT	Lockout is active.
4	RECYCLE	Recycle shutdown completed on low load in effect until the need for cooling resumes; non-fault condition.
5	TRIPOUT	Shutdown completed due to alarm fault condition.
6	TIMEOUT	The controller is delaying the start sequence until the Start to Start or Stop to Start timers have elapsed.
7	PRESTART	The chiller is in the process of system checking before energizing the compressor motor.
8	STARTUP	Normal start-up in progress.
9	AUTORST	Auto Restart in progress.
10	RAMPING	Ramp loading in progress. The chiller has started and is gradually increasing its load to control electrical demand charges.
11	RUNNING	The chiller has completed ramp loading following start-up. Normal running mode, no override or demand limit.
12	OVERRIDE	Running with Override active.
13	DEMAND	Running with Demand Limit active. The chiller is prevented from loading further because it has reached an AVERAGE LOAD CURRENT limit or a MOTOR KILOWATTS limit.
14	SHUTDOWN	Compressor shutdown in progress.
15	FREECOOL	Free Cooling in Progress
16	CONDFLSH	Condenser Flush in Progress (Note: Available for "Marine Option" only).

Table 12 — Pre-Start Alerts and Alarms

PRE-START ALERT CONDITION	STATE NO.	ALARM OR ALERT
STARTS IN 12 HOURS >= 8	100	Alert
OIL SUMP TEMP <= 140 F (60 C) AND OIL SUMP TEMP <= EVAP_SAT + 50 F (27.8 C)	101	Alert
CONDENSER PRESSURE >= COND PRESS OVERRIDE - 20 psi	102	Alert
Number of recycle restart in the last 4 hours is greater than 5	103	Alert
COMP BEARING TEMP >= COMP BEARING ALERT- 10 F (5.5 C)	230	Alarm
COMP MOTOR WINDING TEMP >= MOTOR TEMP OVERRIDE - 10 F (5.5 C)	231	Alarm
COMP DISCHARGE TEMP >= COMP DISCHARGE ALERT- 10 F (5.5 C)	232	Alarm
EVAP_SAT < Evap trip point* + EVAP OVERRIDE DELTA T or EVAP REFRIG LIQUID TEMP < Evap trip point* + EVAP OVERRIDE DELTA T	233	Alarm
ACTUAL LINE VOLTAGE <= UNDERVOLTAGE THRESHOLD (n/a for UM VFDs)	234	Alarm
ACTUAL LINE VOLTAGE >= OVERVOLTAGE THRESHOLD (n/a for UM VFDs)	235	Alarm
Guide vane 1 has not been calibrated successfully	236	Alarm

*Evap trip point = 33 F (0.6 C) (water) or EVAP REFRIG TRIPPOINT (brine).

The compressor RUN STATUS parameter on the default screen line now reads PRESTART. If a test is not successful, the start-up is delayed or aborted. If all tests are successful, the chilled water pump relay energizes, and the main screen line now reads STARTUP.

START-UP — One second after the successful pre-start check, the chilled water and condenser water pump relays are energized.

Five seconds later, the control monitors the chilled water and condenser water flow devices and waits until the WATER FLOW VERIFY TIME (service-configured, default 5 minutes) expires to confirm water flow.

After water flow is verified, the water temperature is compared to CONTROL POINT + 1/2 CHILLED WATER DEAD-BAND. If the temperature is less than or equal to this value, the control turns off the condenser pump relay and goes into RECYCLE mode.

If the RECYCLE condition is not satisfied, the start-up sequence continues and checks the guide vane position. For a single-stage compressor (Comp [Single = 0, Dual = 1] = 0 in FACTORY configuration), if the guide vanes are more than "GUIDE VANE CLOSURE AT STARTUP (default 4%)" % open, the start-up waits until the controller closes the vanes. For a dual-stage compressor (Comp [Single = 0, Dual = 1] = 1 in FACTORY configuration), the guide vanes are opened to the initial position specified with GV1 Closure at Startup in the Option Configuration menu.

If an EC/HGBP or economizer damper valve is equipped and enabled, the control checks that the position of these valves is fully closed.

If the vanes and valves position are verified and the oil pump pressure difference is less than 6 psi (41.4 kPa), the oil pump relay is energized.

The control then waits until the oil pressure difference (OIL PRESS VERIFY TIME, operator-configured, default 40 seconds) reaches a maximum of 18 psi (124 kPa). After oil pressure is verified, the control waits 40 seconds for oil prelube, and the compressor start relay energizes to start the compressor.

Chiller Start-Up Sequence

PRE-START CHECK — Once start-up begins, the controller performs a series of pre-start tests to verify that all pre-start alerts and safeties are within limits. Progress is shown on the Startup Sequence screen (see Fig. 30). This screen can be accessed by touching the mode title (top blue bar) of the home screen. Table 12 lists pre-start alert and alarm conditions.

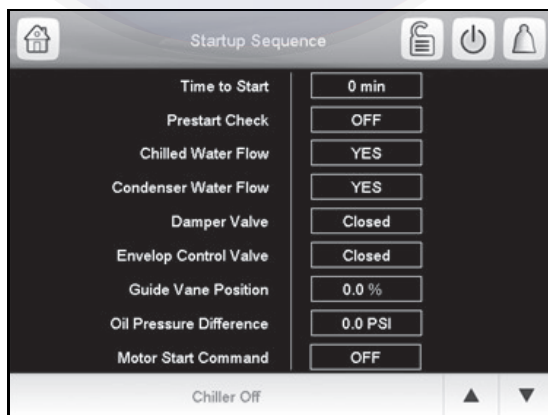

Fig. 30 — Start-Up Sequence Screen

Chiller Shutdown Sequence — Chiller shutdown begins if any of the following occurs:

- Local OFF button is pressed
- A recycle condition is present (see the previous section)
- The time schedule has gone into unoccupied mode when in either Network or Local Schedule control mode
- The chiller protective limit has been reached and chiller is in alarm
- The start/stop status (CHIL_S_S) is overridden to stop from the network when in Network mode

If the chiller is normally shut down from running, a soft-stop shutdown will be performed. The soft-stop feature closes the guide vanes of the compressor automatically if a non-alarm stop signal occurs before the compressor motor is deenergized.

Any time the compressor is directed to STOP (except in the cases of a fault shutdown), the guide vanes are directed to close and VFD will be commanded to minimum speed for a variable speed compressor. The compressor shuts off when any of the following is true:

- PERCENT LOAD CURRENT (%) drops below the SOFT STOP AMPS THRESHOLD
- ACTUAL GUIDE VANE POSITION drops below 4%
- Four minutes have elapsed since the stop was initialized

When any of these conditions is true, the shutdown sequence stops the compressor by deactivating the compressor start relay. The guide vanes are then commanded to the fully closed position. The oil pump relay will be turned off after 120 seconds post-lube.

Finally, the chilled water/brine pump and condenser water pump are shut down.

Oil Lubrication Control — As part of the pre-start checks executed by the controls, the oil sump temperature is compared to the evaporator saturated refrigerant temperature. If the oil temperature is less than 140 F (60 C) and less than evaporator saturated refrigerant temperature plus 50° F (27.8° C), the start-up will be delayed until either of these conditions is no longer true. Once this temperature is confirmed, the start-up continues.

The oil heater relay is energized whenever the chiller compressor is off and the oil sump temperature is less than 140 F (60 C) or the oil sump temperature is less than the evaporator saturated refrigerant temperature plus 53° F (29.4° C). The oil heater is turned off when either of the following conditions is true:

- Oil sump temperature is more than 152 F (66.7 C)
- Oil sump temperature is more than 144 F (62.2 C) and more than the evaporator saturated refrigerant temperature plus 55° F (30.6° C).

The oil heater is always off when the compressor is running.

Default setting for 19XR6/7 chiller energizes the oil pump for 30 seconds after each 30 minutes of the oil heat relay being energized in order to stir the oil for more evenly distributed heating.

The oil stir configuration can be adjusted in Service Parameters as follows: Oil Stir Cycle (19XR6/7):

0 → no Oil Stir.

1 → Oil Stir for 30 seconds per 30 minutes

2 → Oil Stir for 1 minute per 4 hours

3 → Oil Stir for first 50 hours of chiller in not running status (as Option 1) followed by no Oil Stir (as Option 0).

Control Points

SET POINT — The set point can be configured at the Setpoint menu (“USER” access level).

The set point is determined by the heat/cool mode, EWT (entering water temperature) option, and ice build option. See Table 13.

Table 13 — Set Point Determination

EWT CONTROL OPTION	HEAT/COOL MODE	
	COOLING	HEATING
Disabled	Cooling LCW Set Point	Heating LCDW Set Point
Enabled	Cooling ECW Set Point	Heating ECDW Set Point

NOTES:

1. The ice build option is disabled when heat/cool mode is set to Heating.
2. When the ice build option is enabled and ice build is active, the control point is the Ice Build Set Point and the controlled water temperature is the leaving chilled water temperature.

CONTROL POINT TEMPERATURE — Capacity control is based on achieving and maintaining a control point temperature, which is the sum of a valid set point (from the SETPOINT screen) and a temperature reset value. In Cooling mode, the control point temperature is equal to the set point plus temperature reset. In Heating mode, the control point temperature is equal to the set point minus temperature reset.

The control point can be viewed directly on the main screen or the General Parameters menu.

TEMPERATURE RESET — Three types of chilled water or brine reset are available and can be viewed or modified on the Reset Configuration screen.

The default screen indicates when the chilled water reset is active. The control point Reset on the General Parameters screen indicates the amount of reset.

To activate a reset type, access the Reset Configuration (RESETCFG) screen and input all configuration information for that reset type.

Reset Type 1: 4 to 20 mA Temperature Reset — Reset Type 1 is an automatic reset utilizing a 4 to 20 mA analog input signal provided from any external sensor, controller, or other device which is appropriately configured. For this type, Degrees Reset At 20 mA is configured in the RESETCFG table.

Reset Type 2: Remote Temperature Reset — Reset Type 2 is an automatic water temperature reset based on a remote temperature sensor input signal. This function can be accessed by setting the following configurations:

1. Configure the remote temperature at which no reset occurs (Remote temp → NO RESET).
2. Configure the remote temperature at which full reset occurs (Remote temp → FULL RESET).
3. Enter the amount of reset (Deg Reset Water DT Full).

Reset Type 3: Controlled Water Temp Delta Reset — Reset Type 3 is an automatic controlled water temperature reset based on heat exchanger temperature difference. This function can be accessed by setting the following configurations:

1. Configure the controlled water temperature delta T at which no reset occurs (Controlled Water DELTA T → NO RESET).
2. Configure the controlled water temperature delta T at which full reset occurs (Controlled Water DELTA T → FULL RESET).
3. Enter the amount of reset (Deg Reset Water DT Full).

CAPACITY CONTROL — Capacity control provides chilled or condenser water temperature control by modulating the position of the inlet guide vane 1, and VFD speed for variable speed compressors.

If VFD OPTION is set to VFD and increased capacity is needed, the control will first try to increase IGV TARGET POSITION if it has not reached the travel limit; if the travel limit has been reached, the control increases VFD TARGET SPEED. If decreased capacity is needed, the control first tries to decrease VFD TARGET SPEED if it has not reached the minimum VFD speed; if the minimum VFD speed has been reached, the control decreases IGV TARGET POSITION instead. See Fig. 31.

From the compressor relay closed point to the end of ramp loading, the VFD TARGET SPEED is the configured VFD start-up speed. When the chiller is running normally, the capacity control determines whether and how much to change VFD TARGET SPEED. When the chiller is in the shut-down process, VFD TARGET SPEED will be the minimum VFD speed.

NOTE: If the VFD option is set to NO VFD, or the compressor relay is not closed, VFD TARGET SPEED will be 0.

The guide vane position is determined by the Capacity Control function under normal conditions and other functions in abnormal conditions, which include capacity inhibit request or capacity decrease request. The guide vane actuator is driven by comparing the guide vane target position and the actual position. Guide vane position is limited to a value between zero and IGV Travel Limit, which is configured from the Service Configuration menu. When the chiller is shutting down or off, the guide vane is always driven to zero during normal shutdown.

RAMP LOADING — The ramp loading control slows the rate at which the compressor loads up. This control can prevent the compressor from loading up during the short period of time when the chiller is started and the chilled water loop has to be brought down to CONTROL POINT (Setpoint Table). Ramp loading helps reduce electrical demand charges by slowly bringing the chilled water to CONTROL POINT. The total power draw during this period remains almost unchanged. If the power outage lasts for more than 3 hours, then Temperature

Ramp Loading will be used regardless of user configuration and the minimum loading rate (1°F/min) will be used.

Two methods of ramp loading are available: temperature ramp loading and motor load ramp loading.

Temperature Ramp Loading — Temperature ramp loading limits the rate at which the controlled water temperature decreases for cooling and increases for heating during ramping by reducing on cooling mode or increasing in heating mode the PULLDOWN SET POINT (Maintenance Menu → Capacity) at the configured rate, until the pulldown set point is less than the cooling mode control point or greater than the heating mode control point. The PULLDOWN RAMP TYPE (Configuration Menu → General Configuration) is configured to 0 for temperature ramp loading.

Motor Load Ramp Loading — Motor load ramp loading limits the rate at which either the load current percentage or motor kilowatt percentage increases by incrementing the ramp demand limit at the configured rate. The PULLDOWN RAMP TYPE (Configuration Menu → General Configuration) is configured to 1 for motor load ramp loading.

If DEMAND LIMIT SOURCE (Configuration Menu → General Configuration) is set to AMPS, then PERCENT LOAD CURRENT is used for motor load ramp loading. If DEMAND LIMIT SOURCE is set to kW, then MOTOR PERCENT KILOWATTS is used for motor load ramp loading.

The motor load ramp loading algorithm shall be deactivated when the Ramp Demand Limit is greater than or equal to the ACTIVE DEMAND LIMIT (General Parameters). It is also deactivated when Ramp Demand Limit is greater than or equal to 80%. There will be a one-minute delay for the compressor to be uploaded to target load (ramping load target 80% or ACTIVE DEMAND LIMIT if less than 80%) after ramping load demand limit is set to 80% (or ACTIVE DEMAND LIMIT if less than 80%).

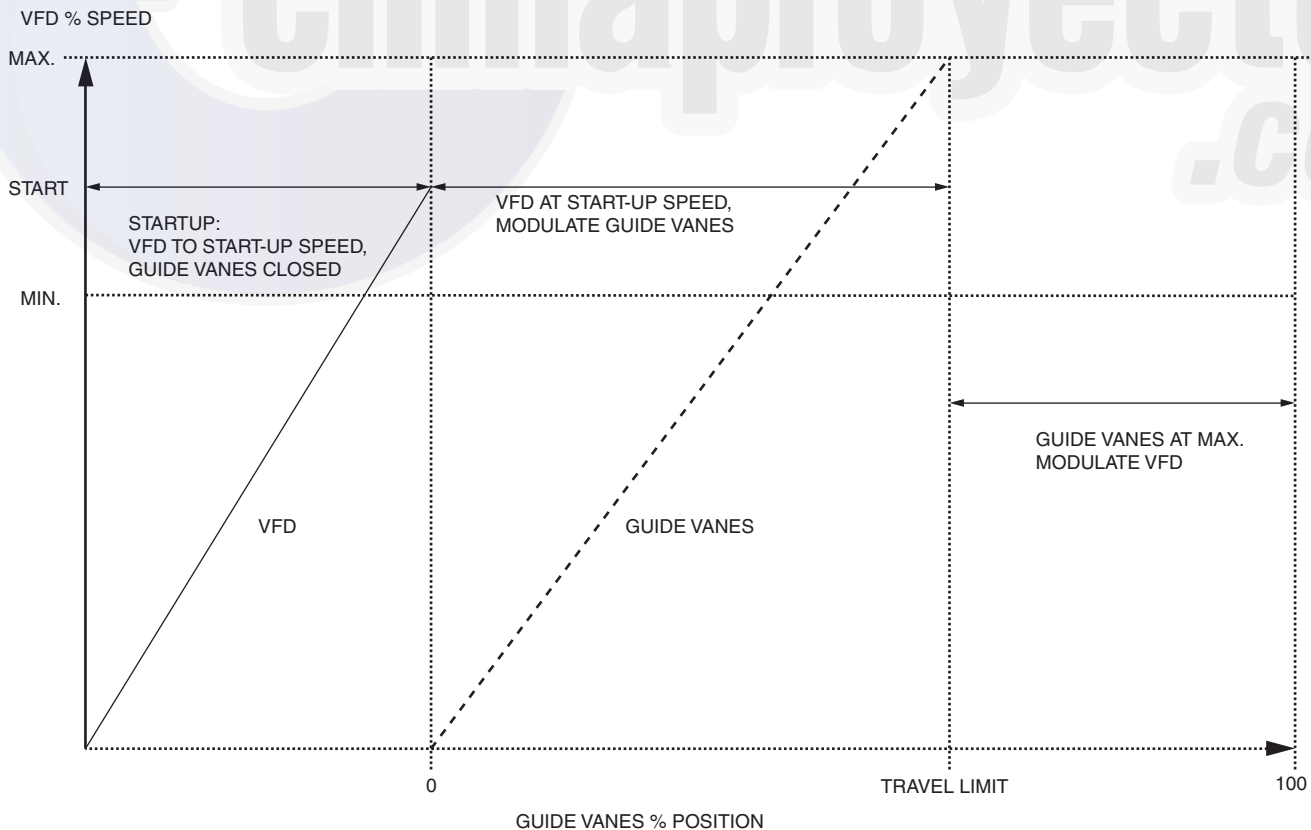

Fig. 31 — Guide Vane Position and VFD Speed

SURGE CORRECTION CONTROL — There are two stages for surge correction: envelop control (surge prevention) and surge protection.

Envelop Control — A surge condition occurs when the lift becomes so high that the gas flow across the impeller reverses. This condition can eventually cause compressor damage. The surge prevention algorithm notifies the operator that chiller operating conditions are marginal and to take action, such as lowering entering condenser water temperature, to help prevent compressor damage.

If a high sound condition occurs at low guide vane position, the EC/HGBP valve is used to decrease the sound level. The envelop control algorithm is an operator-configurable feature that can determine if lift conditions are too high for the compressor and then take corrective action. High efficiency mode or low noise mode can be selected. Lift is defined as the difference between the saturated temperature at the impeller eye and at the impeller discharge. The maximum lift a particular impeller wheel can perform varies with the gas flow across the impeller and the size of the wheel.

If Actual Lift is higher than reference lift, a capacity inhibit signal will be sent. If Actual Lift is higher than reference lift plus Envelop High Deadband, a capacity decrease signal will be sent. If Actual Lift is lower than reference lift minus Envelop Low Deadband, these 2 signals will be canceled. Capacity Control will respond to these 2 signals and make correction on IGV1 TARGET POSITION, VFD TARGET SPEED, and EC/HGBP actuator. To improve system performance SURGE PROFILE OFFSET will be incremented by 1 if no surge prevention has been active in the past 5 minutes. The Reference Lift will subtract the SURGE PROFILE OFFSET prior to comparing to Actual Lift.

Surge Protection — The Surge Protection algorithm will run after SURGE DELAY TIME has elapsed when compressor has been commanded to turn on. It compares the present PERCENT LOAD CURRENT value with the previous value once every second. If the difference exceeds the maximum AMPS change value ($SURGE\ DELTA\ \% AMPS + [PERCENT\ LINE\ CURRENT / 10]$), an incidence of surge has occurred, and the surge protection signal will be sent.

When an incidence of surge determined in this manner has occurred, the SURGE COUNTS will be incremented by one. On receiving the surge protection signal, Capacity Control will make corrections on IGV1 TARGET POSITION, VFD TARGET SPEED, and EC/HGBP actuator. When correction is in effect, Surge Protection Count will increase by 1 when a command for either IGV decrease, VFD speed increase, or EC/HGBP actuator activation is required for correction. Guide vane movement will be inhibited for 1 minute after surge protection ends.

Chiller will do 259 Alarm shutdown under the following conditions.

- If Surge Protection Counts exceed 20 within a Surge Time Period. Note that if VFD, then VFD target speed must equal max before this alarm is activated.
- If IGV, VFD, and HGBP cannot be further adjusted for surge protection when Surge Protection Counts exceed 4 within a Surge Time Period.

If IGV, VFD, and HGBP control cannot correct the problem, the chiller will initiate a shutdown alarm when the surge count is greater than 4.

ENVELOP/HOT GAS BYPASS (HGBP) CONTROL — This function is used to artificially load the chiller and keep it running under low load conditions or to prevent surge conditions. Since this also reduces the performance of the machine, EC/HGBP Control is a user-selectable option.

PIC 5 supports 3 different types of EC/HGBP control valve types:

1. Continuous; modulating valve controlled by two contactors, one to open and another to close. If both contactors are open the valve will hold its position. Valve has a feedback signal for fully open/closed position.
2. On/off; valve controlled by one contact. It has no position feedback and is unable to hold its current position.
3. mA; valve controlled by 4 to 20 mA signal. The type can be configured in the Option Configuration menu.

Envelop/hot gas bypass operation has three different modes when installed ($hgbb_opt > 0$) and enabled ($hgbb_sel > 0$):

- Envelop control and surge protection — Each compressor has unique lift characteristics that can be plotted to determine performance. The controller will determine operating conditions that could result in compressor surge and activate the bypass valve to prevent surge until the chiller operating parameters are in a safe area on the curve where the valve may be closed again.
- Envelop (HGBP) low load operation — In this condition, the valve will be opened to prevent a recycle shutdown from occurring. The valve will remain open until this minimal loading condition has passed and there is no surge condition present.
- Combination for envelop control and surge correction, as well as low load operation — When this option is selected, both EC for envelop control/surge protection and EC for low load operation will be performed. Surge protection will take higher priority if both conditions are satisfied.

ECONOMIZER DAMPER VALVE CONTROL (FOR APPLICABLE UNITS) — The economizer maintains the difference between evaporator pressure and economizer pressure. Economizer pressure should always be higher than evaporator pressure.

When the chiller is initially powered on, or when the compressor shuts down, the damper valve will be commanded to close. These and other conditions are shown in Table 14.

Table 14 — Economizer Damper Valve Status

SYSTEM CONDITION	ECONOMIZER DAMPER VALVE STATUS
Chiller initially powered on	Fully closed
Compressor shut down	Fully closed
During damper valve action delay	Fully closed
Economizer pressure > evaporator pressure + Damper valve open DB	Open
Economizer pressure < evaporator pressure + Damper valve close DB	Closed
All other conditions	Current position maintained

If the damper valve has been commanded to open for a continuous 5 minutes, and the Damper Valve Full Opened condition is still not TRUE, the control system generates an alert 154. Similarly, if the damper valve has been commanded to close for a continuous 5 minutes, and the Damper Valve Full Closed condition is still not TRUE, the control system generates an alert 154.

If the compressor is running and if economizer pressure becomes less than or equal to evaporator pressure, an alarm 268 will be tripped and compressor will be shut down.

DEMAND LIMIT — The PIC 5 controls provide a feature for limiting AVERAGE LOAD CURRENT or MOTOR KILOWATTS by limiting capacity via guide vane control/VFD control. The limit may be applied in two ways. The first is called ACTIVE DEMAND LIMIT, which is equal to a BASE DEMAND LIMIT value (set in the SETPOINT screen, default value 100%). ACTIVE DEMAND LIMIT may also be forced to be different from BASE DEMAND LIMIT by manually overriding (forcing) the value via a CCN network device. If the

DEMAND LIMIT SOURCE exceeds the ACTIVE DEMAND LIMIT by 5% or less, capacity will be inhibited. If the DEMAND LIMIT SOURCE exceeds the ACTIVE DEMAND LIMIT by more than 5%, capacity will be decreased.

Alternatively, the limit may be applied by AUTO DEMAND LIMIT INPUT, an optional 4 to 20 mA input. This demand limit control option (4 to 20 mA DEMAND LIMIT TYPE) is externally controlled by a 4 to 20 mA signal. The option is set up on the Configuration Menu → GENERAL CONFIGURATION screen. When enabled, 4 mA will set ACTIVE DEMAND LIMIT to 100% of the DEMAND LIMIT SOURCE (regardless of the value of BASE DEMAND LIMIT), and 20 mA will set ACTIVE DEMAND LIMIT to the value configured for DEMAND LIMIT AT 20 mA in the Configuration Menu → SERVICE PARAMETERS screen.

OVERRIDE CONTROL — Capacity overrides can prevent some safety shutdowns caused by exceeding the motor amperage limit, evaporator refrigerant low temperature safety limit, motor high temperature safety limit, and condenser high pressure limit. In these cases there are two stages of capacity control:

1. When the value of interest crosses the first stage set point into the override region, the capacity is prevented from increasing further, and the status line on the PIC 5 controller indicates the reason for the override. Normal capacity control operation is restored when the value crosses back over the first stage set point, leaving the override region.
2. When the value of interest is in the override region and further crosses the second stage set point, the capacity is decreased until the value meets the override termination condition. The PIC 5 controls resume normal capacity control operation after the override termination condition has been satisfied. (In the case of high discharge superheat, there is an intermediate stage.)

Table 15 summarizes these override parameters.

Other types of override events do not override control guide vane or VFD operation, but are reported:

- High compressor discharge temperature override — For compressor/frame 6 and 7, if the COMP DISCHARGE TEMP is greater than the COMP DISCHARGE ALERT threshold, then high discharge temperature override will be displayed in the main screen until the COMP DISCHARGE TEMP is less than the COMP DISCHARGE ALERT threshold – 2° F (1.1° C).
- High compressor bearing temperature override — For compressor/frame 6 and 7, if one of the compressor bearing temperatures is greater than the compressor bearing temperature Alert (Configuration Menu → Protective Limit Config) threshold, then High Bearing Temp Override shall be active until all of the compressor bearing temperatures are less than Comp Bearing Temp Alert minus 2° F (1.1° C). For compressors 2-6, D, and E, if the calculated compressor bearing temperature is greater than the bearing temperature alert threshold, then high bearing temperature override will be active until the calculated bearing temperature is less than the threshold minus 2° F (1.1° C).
- Low Discharge Superheat Temperature Override — This override is ignored during the first 5 minutes after chiller start-up. There are additional requirements for normal override function after start-up. For compressor E, condenser pressure must be 10 psi greater than cooler pressure; for compressor/frame 6 and 7, the damper must have been open for 20 consecutive seconds.

RECYCLE CONTROL — The chiller may cycle off and wait until the load increases to restart when the compressor is running in a lightly loaded condition. This normal cycling is known as “recycle.”

In cooling mode, a recycle shutdown is initiated when either of the following conditions is true:

- Leaving chilled water temperature (or entering chilled water temperature, if the EWT CONTROL OPTION is enabled) is more than 5° F (2.8° C) below the CONTROL POINT.
- Leaving chilled water temperature (or entering chilled water temperature, if the EWT CONTROL OPTION is enabled) is below the CONTROL POINT, and the chilled water temperature difference is less than the RECYCLE SHUTDOWN DELTA T.

In heating mode, a recycle cycle shutdown occurs when either of the following conditions is true:

- Leaving condenser water temperature (or entering condenser water temperature, if the EWT CONTROL OPTION is enabled) is more than 5° F (2.8° C) below the CONTROL POINT.
- Leaving condenser water temperature (or entering condenser water temperature, if the EWT CONTROL OPTION is enabled) is above the CONTROL POINT, and the condenser water temperature difference is less than the RECYCLE SHUTDOWN DELTA T.

NOTE: Recycle shutdown will not occur if the CONTROL POINT has been changed by more than 1° F (0.56° C) within the previous 5 minutes of operation.

When the chiller is in RECYCLE mode, the chilled water pump relay remains energized so the chilled water temperature can be monitored for increasing load. The recycle control uses RECYCLE RESTART DELTA T to check when the compressor should be restarted. In cooling mode, the compressor will restart when the leaving chilled water temperature (or entering chilled water temperature, if the EWT CONTROL OPTION is enabled) is greater than the CONTROL POINT plus the RECYCLE RESTART DELTA T for 5 consecutive seconds. In heating mode, the compressor will restart when the leaving condenser water temperature (or entering condenser water temperature, if the EWT CONTROL OPTION is enabled) is less than the CONTROL POINT minus the RECYCLE RESTART DELTA T for 5 consecutive seconds.

RUNNING TIMERS AND COUNTERS — The PIC 5 control maintains two run-time clocks: COMPRESSOR ONTIME and SERVICE ONTIME. COMPRESSOR ONTIME indicates the total lifetime compressor run hours. SERVICE ONTIME is a resettable timer that can be used to indicate the hours since the last service visit or any other event. A separate counter tallies compressor starts as TOTAL COMPRESSOR STARTS. All of these can be viewed on the RUN TIMES screen. Both Ontime counters roll over to 0 at 500,000 hours. Manual changes to SERVICE ONTIME from the screen are permitted at any time. If the controller is replaced, one opportunity before the first start-up with the new controller is provided to set COMPRESSOR ONTIME and TOTAL COMPRESSOR STARTS to the last readings retained with the prior controller.

The chiller also maintains a start-to-start timer and a stop-to-start timer. These timers limit how soon the chiller can be started and are displayed on the system overview (home) and RUN TIMES screens. They can be configured in the Configuration Menu → GENERAL CONFIGURATION screen. They must expire before the chiller starts. If the timers have not expired, the RUN STATUS parameter on the System Overview (Home) and GENERAL PARAMETERS screen reads TIMEOUT.

Table 15 — Override Parameters

OVERRIDE CONDITION	OVERRIDE PARAMETER	FIRST STAGE CAPACITY INHIBIT	DEFAULT VALUE/ CONFIGURABLE RANGE	SECOND STAGE CAPACITY DECREASE	OVERRIDE TERMINATION
High condenser pressure override (Unit Type Heat/Cool=1 in Configuration Menu → Factory Parameters. Before configuring Unit Type = 1 the condenser shell side must be verified to be 300 psig design or higher.)	CONDENSER PRESSURE	> COND PRESS OVERRIDE HIGH	250 psig/200-260 psig	> COND PRESS OVERRIDE HIGH + 2.4 psi	< COND PRESS OVERRIDE HIGH - 1 psi
High condenser pressure override (Unit Type Cool Only = 0 in Configuration Menu → Factory Parameters. This corresponds to a condenser with standard 185 psig design pressure.)	CONDENSER PRESSURE	> COND PRESS OVERRIDE LOW	140 psig/90-170 psig	> COND PRESS OVERRIDE LOW + 2.4 psi	< COND PRESS OVERRIDE LOW - 1 psi
Low evaporator temperature override	CALC EVAP SAT TEMP or EVAP REFRIG LIQUID TEMP	< EVAP SAT OVERRIDE TEMP (EVAP SAT OVERRIDE TEMP = EVAP TRIP-POINT + EVAP OVERRIDE DELTA T)		< EVAP SAT OVERRIDE TEMP - 1° F (0.56° C)	> EVAP SAT OVERRIDE TEMP + 2° F (1.1° C)
High motor temperature override	COMP MOTOR WINDING TEMP	> COMP MOTOR TEMP OVERRIDE	200 F/150-200 F (93.3 C/65.6-93.3 C)	COMP MOTOR WINDING TEMP > COMP MOTOR TEMP OVERRIDE + 10 F (5.6 C)	COMP MOTOR WINDING TEMP < COMP MOTOR TEMP OVERRIDE - 2° F (1.1° C)
High current override	PERCENT LINE CURRENT	PERCENT LINE CURRENT > 100%		PERCENT LINE CURRENT > 105%; 102% WHEN 32VS VFD INSTALLED	PERCENT LINE CURRENT <= 100%
Low discharge superheat override	Discharge Superheat (DSH)	< DSH REQUIRED + 1		< DSH REQUIRED - 3	> DSH REQUIRED + 2
Low source temperature protection override	Leaving water temperature (heating mode)	< LWT PROTECTION SETPOINT - 2° F (1.1° C)			>LWT PROTECTION SETPOINT + 0.5° F (0.3° C)

WATER PUMPS CONTROL (FREEZE PREVENTION)

NOTE: In order to energize the chilled and condenser pump to prevent evaporator and condenser tube freeze-up, the hydraulic system should be enabled first (this can be configured in the Configuration Menu → FACTORY PARAMETERS screen).

Evaporator Freeze Prevention—When the evaporator saturated refrigerant temperature or evaporator refrigerant temperature is less than the EVAP REFRIG TRIPPOINT + REFRIG OVERRIDE DELTA T (configurable from 2° F to 5° F (1.1° C to 2.8° C) in the Configuration Menu → PROTECTIVE LIMIT CONFIG screen), an OVERRIDE—LOW EVAP REFRIG TEMP event will occur.

For any running status, if either of the conditions below is true then unit will shut down under Alarm PROTECTIVE LIMIT - EVAPORATOR FREEZE (State 261):

- Evaporator saturated refrigerant temperature or evaporator refrigerant temperature is equal to or less than the EVAP REFRIG TRIPPOINT (33 F [0.6 C] for water, (configurable for brine in Configuration Menu → PROTECTIVE LIMIT CONFIG screen) plus 1° F (0.56° C).
- Leaving chilled water temperature or entering chilled water temperature is less than EVAP REFRIG TRIP-POINT plus 1° F (0.56° C).

NOTE: If the chiller is in recycle mode, it will transition to TRIPOUT, and the CHILLED WATER PUMP will remain on.

The alarm will be clearable when the evaporator saturated refrigerant temperature, evaporator refrigerant temperature, leaving chilled water temperature, and entering chilled water temperature rise 5° F (2.8° C) above the EVAP REFRIG TRIPPOINT.

Condenser Pump Control— The chiller will monitor the condenser pressure and may turn on the condenser pump. If the condenser pressure is greater than or equal to the COND PRESS OVERRIDE, and the entering condenser water temperature is less than 115 F (46.1 C), the condenser pump will energize to try to decrease the pressure and Process Alert - High Condenser Pressure Chiller Off (Alert 157) will be generated. The pump will turn off when the condenser pressure is 3.5 psi (24.1 kPa) less than the pressure override and the condenser refrigerant temperature is less than or equal to the entering condenser water temperature plus 3° F (1.7° C).

NOTE: COND PRESS OVERRIDE is found in the Configuration Menu → PROTECTIVE LIMIT CONFIG screen.

Condenser Freeze Prevention— This control helps prevent condenser tube freezing by energizing the condenser pump relay. The PIC 5 module controls the pump and, by starting it, helps to prevent the water in the condenser from freezing.

When the chiller is off and condenser saturated refrigerant temperature is less than or equal to the condenser freeze point, the condenser water pump will be energized (Alarm State 262, PROTECTIVE LIMIT - CONDENSER FREEZE). The fault state will clear and the pump will turn off when the condenser saturated refrigerant temperature is more than 5° F (2.7° C) above the condenser freeze point and the entering condenser water temperature is greater than the condenser freeze point. If the chiller is in recycle shutdown mode when the condition occurs, the controls will transition to a non-recycle shutdown.

NOTE: In order for the chilled water pump and the condenser water pump to operate from IOB4 to prevent freeze-up, the Dedicated Hydraulic IOB option must be enabled in Configuration Menu → FACTORY PARAMETERS.

CONTROL TEST — This feature allows the operator to quick-test the controls and related hardware, including all unit-controlled outputs except compressor output.

The unit must be off to run the test function. If the unit is on, the test function cannot be accessed. The compressor can only be started after the control test is finished. The test function also requires the user to enter the User password if it has not already been entered. All control test parameters are accessible through the Quick Test table. To perform the control test function, set the first item Quick Test Enable in the Quick Test table to Enable.

Unless otherwise noted, all protective limits remain active during the controls test.

Discrete Outputs — When the control test is enabled, discrete outputs can be enabled using the Quick Test table. Discrete valves that can be tested in Quick test are: GV1 Open, GV1 Close, Oil Pump Relay, HGBP Open, HGBP Close, Damper Open, Damper Close, Condenser Pump Relay, Evaporator Pump Relay, Alarm Relay, and Alert Relay.

NOTE: The following outputs cannot be enabled at the same time Guide Vane Increase and Guide Vane Decrease are enabled: EC/HGBP Valve Open and EC/HGBP Valve Close; Economizer Damper Valve Open and Economizer Damper Valve Close.

NOTE: For oil pressure, a value ≥ 18 psi within 40 seconds after the oil pump is turned on indicates a confirmation of pressure (Oil Pres Test Passed=YES).

Analog Output — When the control test is enabled, the following analog outputs can be enabled by entering the positions in the QCK_TST table:

- Head Pressure Valve
- Diffuser Actuator
- Oil EXV (electronic expansion valve)
- Chiller Status Output (Q_CHST)

Guide Vane Calibration — The guide vane position should be calibrated before starting the chiller. Guide vane calibration can be started by setting Quick Test Enable to Enable and GV1 Calibration Enable to Enable.

If the actuator type is digital (POS) 0, then:

- The fully closed guide vane feedback resistance will be in the range of 62.5 ohms to 688 ohms (350 ± 75 ohms target setting).
- The fully opened guide vane feedback resistance will be in the range of 6190 ohms to 11,496 ohms (10,000 ohms target setting).

If the actuator type is analog (1):

- The fully closed guide vane feedback mA value will be in the range of 3 mA to 5 mA.
- The fully opened guide vane feedback mA value will be in the range of 19 mA to 20.8 mA.

SWIFT RESTART (CAPACITY RECOVERY™) — This function is designed for data center or other applications. It allows the chiller to be restarted quickly to meet building load requirements.

To enable this function, the AUTO RESTART OPTION point in the CONF_OPT table should be set to ENABLE.

The water flow verification time, oil prelube time and other delays will be decreased compared to a normal start-up.

COOLING TOWER CONTROL — If WATER PRESSURE OPTION in the CONF_OPT table is set to 1 or 2, there will be another optional hydraulic control I/O board in the PIC 5 control system to allow PIC 5 control for the water pumps and cooling tower fans (high speed and low speed).

The cooling tower fans are controlled by the pressure difference between condenser and evaporator and entering water temperature of condenser. The objective is to maintain the entering condenser water temperature in the optimal range.

HEAD PRESSURE CONTROL — If the chiller system is equipped with a head pressure control valve, and the HEAD PRESSURE VALVE option in the CONF_OPT table is ENABLED, the PIC 5 control system will control the opening of the head pressure valve to maintain the pressure difference between condenser and evaporator. The output of this valve is 4 to 20 mA type.

Before using this function, the pressure difference values for 20 mA and 4 mA should be set.

The head pressure valve should be in fully closed position when chiller is in OFF mode.

ICE BUILD OPTION — The PIC 5 controller provides an ice build option based on efficiency improving point. The ICE BUILD OPTION in the CONF_OPT table should be set to ENABLED to make ice build active, and the following two parameters should be configured:

- Ice_recy (ICE BUILD RECYCLE) indicates whether recycle option is enabled in ice build mode.
- Ice_term (ICE BUILD TERMIN SOURCE) indicates how the ice build is terminated. There are three types: temperature (0), dry contact (1), or combined temperature and dry contact (2).

TIME SCHEDULE — The PIC 5 control provides three schedules:

- Local schedule
- Ice build schedule
- Network schedule

Each schedule has 8 time segments. If two time segments overlap, the unoccupied time segment takes priority.

There are 16 holiday time segments. Each holiday time segment is determined by three parameters—month, start date, and holiday days. The controller will be in unoccupied mode when a holiday time segment is active. PIC 5 includes a Daylight Savings Time function. Use Broadcast Menu to enable this feature and configure start and end dates.

BLACK BOX — The black box task continuously stores parameters in memory every 5 seconds. Reporting of a chiller operation alarm triggers the controller to generate a collection of data records. Each collection contains up to 180 records that consist of 168 records (corresponding to 14 min.) before the alarm and 12 records (corresponding to 1 min.) after the alarm. Each record is associated with a time stamp. Files are saved as csv files; up to 20 files can be stored.

The black box file can be uploaded with the Carrier S-Service tool. Once the upload is done, the original files are automatically deleted.

PRESSURE TRANSDUCER CALIBRATION — The HMI pressure readings are displayed in the Main Menu → Pressures screen. See Fig. 32 and 33.

Component	Reading	Unit
Evaporator Pressure	-10.0	PSIG
Condenser Pressure	-10.0	PSIG
Economizer Pressure	-10.0	PSIG
Oil Supply Pressure	-10.0	PSIG
Oil Sump Pressure	-10.0	PSIG
Oil Pump Delta P	0.0	PSIG
Diffuser Pressure	-10.0	PSIG
Head Pressure Reference	0.0	PSIG

Fig. 32 — Pressures Screen, Page 1

Sensor Name
Cond Leaving Water P

Fig. 35 — Pressure Sensor Calib Screen, Page 2

Component	Reading	Unit
Evap Entering Water Pres	0.0	PSIG
Evap Leaving Water Pres	0.0	PSIG
Cond Entering Water Pres	0.0	PSIG
Cond Leaving Water Pres	0.0	PSIG

Fig. 33 — Pressures Screen, Page 2

Once a year the pressure transducers should be checked against a pressure gage. Attach a set of accurate refrigeration gages to the transducer being checked and compare the two readings. If there is a difference the transducer can be calibrated as described below (the Oil Pump Delta P reading should be zero when the compressor is off). Calibration requires Service level access to the HMI.

NOTE: It is usually not necessary to calibrate at initial start-up unless chiller is at high altitude.

1. Go to Main Menu → Maintenance Menu → Pressure Sensor Calib. See Fig. 34 and 35.

Sensor Name
Evap Pressure Sensor
Cond Pressure Sensor
Eco Pressure Sensor
Diff Pressure Sensor
Oil Sump Pressure
Oil Supply Pressure
Evap Entering Water P
Evap Leaving Water P
Cond Entering Water P

Fig. 34 — Pressure Sensor Calib Screen, Page 1

2. Each transducer is supplied with 5 vdc from the IOB. Calibration is done by selecting the appropriate Pressure Sensor option on the Pressure Sensor Calib screen. The screen for the selected option is displayed. Figure 36 shows the Evap Pressure Sensor screen (PRSCAL01 as an example).

Parameter	Value	Unit
Calibration Enable	Disable	
Current Pressure	-10.0	PSIG
Calib Press1(0 PSI)	0.0	PSIG
Calib Press2(100-250PSI)	0.0	PSIG
Calibrated Slope	0.00	
Calibrated Intercept	0.00	
Calibration Completed	No	

Fig. 36 — Evap Pressure Sensor Screen

3. Set Calibration Enable to Enable. Calibration for this sensor is complete and the new slope and intercept will be used for the calibrated transducer in the pressure or temperature tables.
4. With the transducer at atmospheric pressure (zero gage pressure), ensure that “Calib Press1 (0 PSI)” = 0 PSIG.
5. Pressurize the transducer to a known pressure between 100 and 250 psig, and enter that pressure as read from calibrated gage in the “Calib Press2 (100-250PSI)” field and press “OK.”
6. Screen will show “Calibration Completed = Yes” upon successful calibration. To exit, use the arrow key or click the Home button.

TEMPERATURE SENSOR CALIBRATION — The four water temperature sensors can be separately calibrated to have their temperature readings offset by a specified amount. Follow these steps for each sensor:

1. Go to Main Menu → Maintenance Menu → Temp Sensor Calib. See Fig. 37.



Fig. 37 — Maintenance Menu Calibration

2. Place the temperature sensor in a 32 F (0° C) water solution.
 3. Read the sensor raw temperature on the Maintenance screen.
 4. Calculate the offset to be applied as follows:
 $32 - \text{sensor raw temp } (^{\circ}\text{F})$
 Example:
 ECW sensor raw temperature reads 32.6 F.
 ECW temperature offset must be set to -0.6°F
 $(32 - 32.6 = -0.6)$
 5. In the Temp Sensor Calib screen, enter the temperature offset for the appropriate sensor as calculated in Step 4. See Fig. 38 and 39.
- NOTE: The offset cannot exceed $\pm 2^{\circ}\text{F}$ (1.1°C).

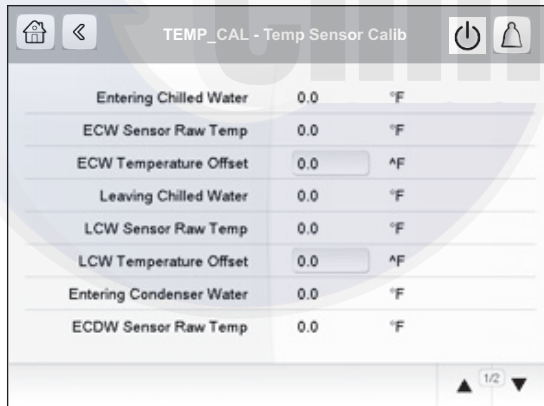

Fig. 38 — Temp Sensor Calib Screen, Page 1

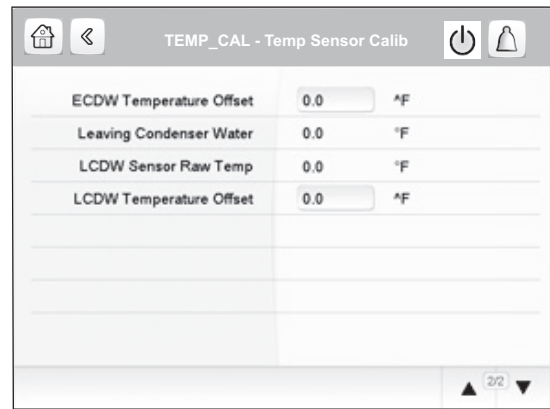

Fig. 39 — Temp Sensor Calib Screen, Page 2

6. Verify that the measured temperature value is the same as the controlled temperature.

ISM VFD INPUT/OUTPUT CALIBRATION — VFD Target Speed Output (J8-1,2) and VFD Speed Feedback (J6-1,2) must be calibrated as part of commissioning the variable frequency drive. Before performing the calibration, be sure that VFD Option = 1 (FS FVD) (Main Menu → Configuration Menu → Factory Parameters) and that the controller has been connected to the ISM board. Objective is to have target speed match actual VFD speed within 5% or better at 70 to 100% speed. Note that it is possible for all calibration to be done at the drive. J8B must be used to provide the drive with a signal.

Calibrating J8B 4-20mA Output (to VFD)

1. Go to Main Menu → Maintenance Menu → ISM Calibration. See Fig. 40.

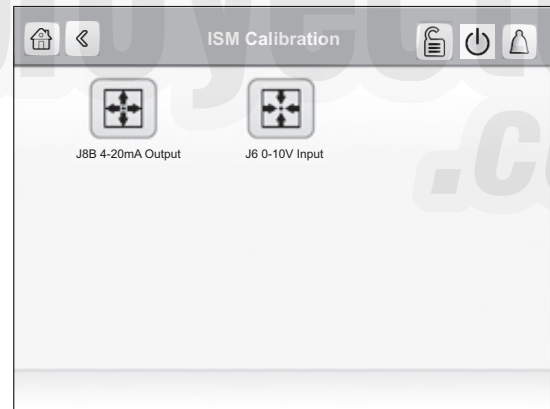

Fig. 40 — ISM Calibration Screen

2. Select J8B 4-20mA Output. The ISM_CAL1 screen is displayed. See Fig. 41.

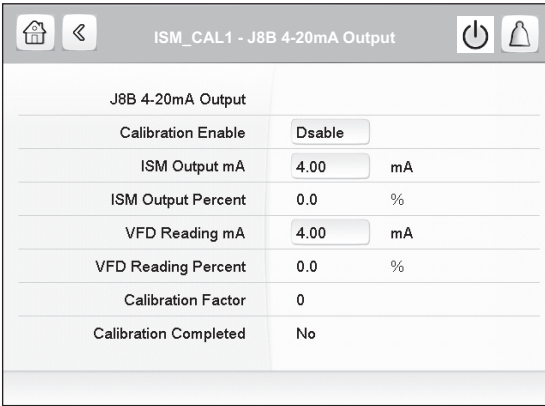

Fig. 41 — ISM_CAL1 Screen

3. Set Calibration Enable to Enable.
4. Input a test output mA value. The controller will make the ISM output this mA value upon exiting the menu using the back arrow key. See Table 16 for corresponding mA and frequency signals. Note that in current software it is necessary to execute “Dsable,” then “Enable” prior to sending a different signal to the drive. Verify/calibrate Target and Actual VFD speed at 70 to 100%. Have Rockwell Start-up Engineer calibrate input to ISM 2M Aux to close at Target Speed 58%.
5. If required, input the actual reading of mA value from VFD or mA meter.
6. PIC 5 will calculate the calibration factor as follows:

$$\text{Calibration Factor} = 1000 * (\text{Actual Reading mA} - \text{Output mA})$$
 Range: 0 to 2000

Table 16 — Corresponding mA and Frequency Signals

SIGNAL 4-20 mA	FREQ 50 Hz	FREQ 50 Hz	TARGETSPEED %
(13.2)	(28.8)	(34.5)	(58)
14.4	32.5	39.0	65.0
15.2	35.0	42.0	70.0
16.8	40.0	48.0	80.0
18.4	45.0	54.0	90.0
20.0	50.0	60.0	100.0

NOTE: Parentheses indicate testing only with no motor running.

Calibrating J6 0-10V Input (from VFD)

1. When the chiller is running, record the VFD feedback voltage and the actual reading on the ISM. Note that it is possible that calibration is only required at the drive.
2. Shut down the chiller.

3. Go to Main Menu → Maintenance Menu → ISM Calibration.
4. Select J6 0-10V Input. The ISM_CAL2 screen is displayed. See Fig. 42.

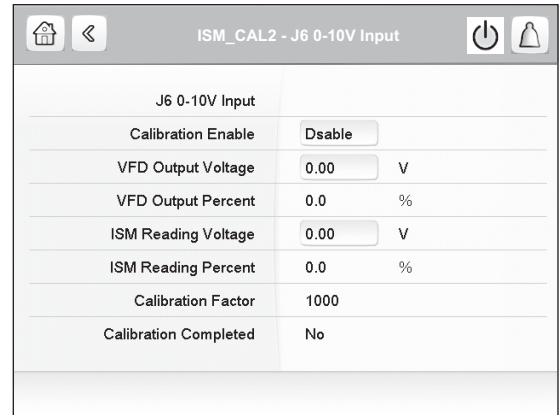

Fig. 42 — ISM_CAL2 Screen

5. Set Calibration Enable to Enable.
6. Input the VFD feedback voltage.
7. Input the actual ISM reading.
8. PIC 5 will calculate the calibration factor as follows:

$$\text{Calibration Factor} = 1000 * (\text{VFD feedback voltage} / \text{ISM actual reading voltage})$$
 Range: 800 to 1200
9. Verify that the PIC control exits calibration mode.

ALARM EMAIL — The alarm email function sends automatic email messages to specified service personnel for remote maintenance purposes. This function can be set up from the second page of Configuration Menu → E-Mail Configuration (EMAILCFG). Subsequently if there is an alarm the function will send an e-mail message. Another message is sent when all alarms return to normal. See Fig. 43-45.

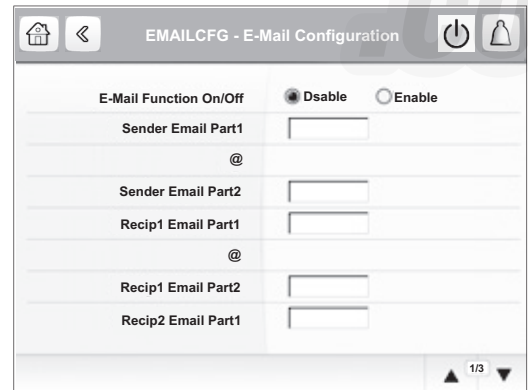

Fig. 43 — E-Mail Configuration Screen, Page 1

Fig. 44 — E-Mail Configuration Screen, Page 2

Fig. 45 — E-Mail Configuration Screen, Page 3

The alarm task runs periodically. At each alarm task run time, the status change of each alarm is checked and one email message is sent to each specified recipient when one or more alarms are switched on. When all alarms return to normal, another e-mail message is sent to remote maintenance service personnel.

The e-mail message provides the unit description and location stored in the CTRL_ID table, available from the CONFIGURATION menu. See Fig. 46.

Fig. 46 — CTRL_ID Screen

PROGNOSTICS — This advanced diagnostic and prognostic function is designed for service and to help resolve problems before they affect operating efficiency and the chiller life. The CONF_PRG (Prognostics Config) screen is available from the Alarm Menu. See Fig. 47 and 48.

Fig. 47 — Prognostics Config Screen, Page 1

Fig. 48 — Prognostics Config Screen, Page 2

The Prognostics status screen is available from the Alarm Menu. See Fig. 49 and 50.

Fig. 49 — Alarm Menu with Prognostics Option

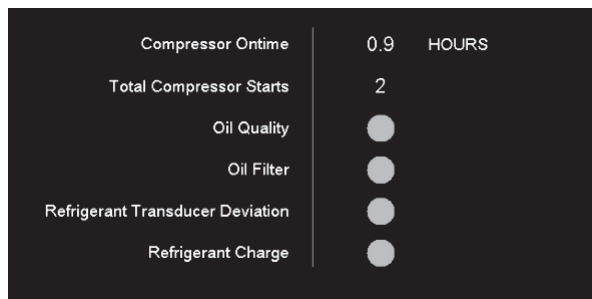

Fig. 50 — Prognostics Status Screen

The Prognostics status screen displays the following functions (green indicates normal, red indicates program function, and yellow indicates caution):

Oil Quality — The lubrication oil should be changed regularly to maintain the appropriate lubrication for the motor and compressor. On the Prognostics status screen, a green light is displayed for Oil Quality if the operating time is less than 90% of the configured oil change duration and total time (includes operation and non-operation) is less than 90% of the oil store duration.

A yellow light is displayed if the operating time is more than 90% of configured oil change duration or if total time (includes operation and non-operation) is more than 90% of the oil store duration.

A red light is displayed if the operating time is greater than configured oil change duration, or if total time (includes operation and non-operation) is more than oil store duration, and oil change is not completed.

When the light is red or yellow, the oil change completed flag is set to NO by the controller. After the oil has been changed, the oil change completed flag should be set to YES manually. The controller then changes the light to green.

Oil Filter — This alert function is active only in an oil pump control test. Two transducers, one located before the oil pump and the other located after the oil filter, are used to identify when the pressure differential has fallen below the alert threshold. If the oil pump is forced to ON and after 10 seconds, if the pressure differential is lower than the threshold set in the Oil Filter Pres Diff field, the filter needs to be replaced and the dedicated alert 160 is reported.

The Oil Filter light is updated in control test mode automatically and can be reset to green in all modes manually.

If the oil pump is forced to ON and after 10 seconds, if the pressure differential is lower than the threshold, the Oil Filter red light is displayed on the Prognostics status screen.

If the oil pump is forced to ON and after 10 seconds, if the pressure differential is between the threshold and the threshold plus 2 psig, the yellow light is displayed on the Prognostics status screen.

If oil pump is forced to ON and after 10 seconds, if the pressure differential is greater than the alert threshold plus 2 psig, the green light is displayed on the Prognostics status screen.

When the light is red or yellow, the Oil Filter Change Done flag is set to NO by the controller. After the oil filter is changed, the Oil Filter Change Done flag should be set to YES manually. The controller then changes the Oil Filter light to green.

Refrigerant Transducer Calibration — When the unit is offline for more than 5 minutes, a comparison is made among the evaporator, condenser, and economizer refrigerant pressure transducers. A difference of more than the configurable

threshold set in the Trans Calib Threshold option generates an alert 161 that a calibration is required. The comparison is done for all of the transducers.

A value more than the configurable threshold displays the red light in for Refrigerant Transducer Calibration in the Prognostics status screen. A value more than 0.9 times the configurable threshold displays the yellow light in the Prognostics status screen. A value less than 0.9 times the configurable threshold displays the green light in the Prognostics status screen.

When the light is red or yellow, the Trans Calibration Done flag is set to NO by the controller. After transducer re-calibration, the Trans Calibration Done flag should be set to YES manually. The controller then changes the Refrigerant Transducer Calibration light to green.

Refrigerant Charge — This function uses the evaporator approach (Evap Design Approach) setting and compressor discharge temperature (Bearing Degradation) setting in relation to the condenser refrigerant temperature (Low Charge Cond Approach) setting to generate an alert 162 of possible low refrigerant charge and display the red light based on the following conditions:

- compressor is running but not in ramp loading status; and
- condenser approach is greater than 0.9 times the low refrigerant charge condenser approach threshold; and
- evaporator approach is 2° F (1.1° C) greater than design approach (ap_dgap)

The Refrigerant Charge yellow light is displayed under the following conditions:

- compressor is running but not in ramp loading status; and
- condenser approach is greater than low refrigerant charge condenser approach threshold (rch_cath); and
- evaporator approach is 1.8° F (1° C) greater than design approach (ap_dgap)

When the light is red or yellow, the Refrigerant Charge Done flag is set to NO by the controller. After the refrigerant charge is completed, the Refrigerant Charge Done flag should be set to YES manually. The controller then changes the Refrigerant Charge light to green.

MASTER SLAVE CONTROL — This control, available from page 2 of the Configuration Menu, provides the capability to operate 2 chillers in Master/Slave mode. The slave chiller should be set to NETWORK mode and controlled by the master chiller.

The two chillers can be configured to be in parallel or in series. When they are in series mode, the master chiller's evaporator must be downstream. The user can configure which condenser (master or slave) is downstream. The master chiller shall monitor all external commands such as start/stop, demand limiting, or setpoint configuration.

The master/slave function provides the ability to select a lead chiller from the master and the slave chillers. Selection is based on the delta between the master and the slave run hours, and tries to optimize the runtime hours. If this function is not set, the lead chiller is always the master chiller and should be changed to lag in case of failure.

The lead chiller shall always be started first, and the lag chiller shall be maintained at zero percent capacity. When the lead chiller cannot be loaded anymore, then the lag start timer is started. The lag chiller shall always be stopped prior to lead chiller.

If a communication failure is detected between the master and the slave chillers, all master/slave functions are disabled and chillers return to stand-alone operations until communication is reestablished. If middle sensor is installed, this, among other things, can be configured in the Master Slave Config table. Fig. 51-53 show Master/Slave Config options.



Fig. 51 — Master/Slave Config Screen, Page 1



Fig. 52 — Master/Slave Config Screen, Page 2



Fig. 53 — Master/Slave Config Screen, Page 3

Oil EXV Option — If the chiller system is equipped with an Oil EXV control valve, and the Oil EXV valve option in CONF_OPT table (Option Configuration in the Configuration Menu) is enabled, the PIC 5 control system will control the opening of the Oil EXV valve to maintain the oil supply temperature. The output of this valve is 4 to 20 mA. Before using this function, configure the Oil Temp High Threshold and Oil Temp Low Threshold options.

One minute after the compressor starts, if the oil supply temperature is higher than the Oil Temp High Threshold, the oil EXV valve should be in the fully opened position. If the oil supply temperature is lower than the Oil Temp Low Threshold, the oil EXV valve should be in the fully closed position. In all other cases, the oil EXV valve position will be calculated according to the oil supply temperature.

One minute after compressor shutdown is completed, the oil EXV valve should be in fully closed position.

Pumpdown/Lockout — The Pumpdown/Lockout feature prevents compressor start-up when there is no refrigerant in the chiller. To access this function one must be logged in as Advanced User/Service or higher. The feature can be accessed from the Maintenance Menu. See Fig. 54.

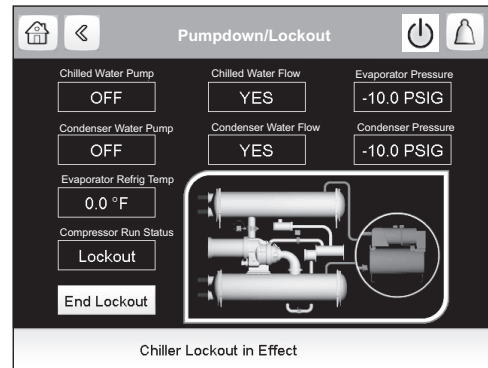

Fig. 54 — Pumpdown/Lockout Screen

The Pumpdown/Lockout function provides precautions when an external pumpout unit is removing refrigerant from chiller. When the lockout is activated, the controller takes the following steps:

- Starts water pumps and confirm flows
- Monitors evaporator pressure, condenser pressure, and evaporator refrigerant temperature during pumpout procedures
- Turns pumps off after pumpdown
- Proceeds to lock out the compressor

The Terminate Lockout feature ends the Pumpdown/Lockout after refrigerant is added. Press End Lockout on the Pumpdown/Lockout menu in order to initiate the process, which proceeds as follows:

- Starts pumps and confirm flows
- Monitors evaporator pressure, condenser pressure, evaporator temperature during charging process
- Terminates compressor lockout

Displaying Data Trends — The PIC 5 control system offers the ability to configure and display color-coded system trends without a password. Select Main Menu → Trending.

On the Trending screen (see Fig. 55), check the data to be tracked, and set the beginning and end points for the selected data. To change a data color, select the colored square and choose a new color from the pop-up color bar. To view data trends, select the down arrow at the bottom right of the Trending screen. The next page displays the selected data in the chosen colors. See Fig. 56.

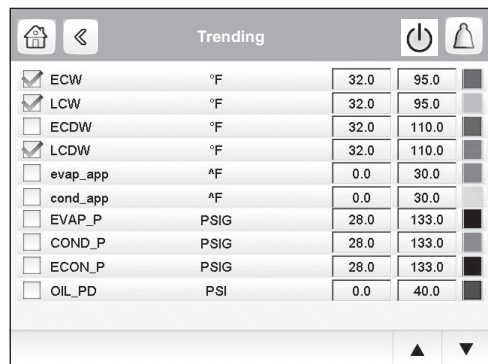

Fig. 55 — Trending Screen Set-Up Page



Fig. 56 — Trending Screen Display Page

Hydraulic Option

WATER FLOW MEASUREMENT — PIC 5 Controller provides the function of measuring water flow rate.

Equipped with a field installed flow meter, it can compute the water flow rate from the input signal sent from the evaporator/condenser water flow sensor (4 to 20 mA) to the IOB (see Fig. 5, IOB4 wiring schematic).

Step 1: Set Factory Parameters → IOB4 Option as “Yes.”

Step 2: Set Option Configuration → Water Flow Measurement as “2 = Flow Meter,” and enter the corresponding value of Water Flow at 4 mA and 20 mA.

Step 3: In “Inputs Status” menu, confirm that evaporator/condenser water flow sensor is working and giving correct readings.

Step 4: In “Hydraulic Status” menu, check evaporator/condenser water flow rate value. (The flow rate value will be linear interpolated by actual reading and configured water flow rate at 4 mA/20 mA.)

Water flow can also be computed from water pressure sensors or water pressure drop sensors (see IOB4 wiring schematic). IOB4 Option must be Enabled and Water Flow Measurement option configured as “3 = Water PD” and the evaporator/condenser pressure drop baseline and water flow must be entered as inputs. Then review Step 3 and 4 as above.

Equipped with a normally open flow switch, the evaporator/condenser water flow can be directly indicate the flow status (see Fig. 5, IOB4 wiring schematic). IOB4 Option must be Enabled and Water Flow Measurement option configured as “1 = Flow Switch.”

WATER PRESSURE DIFFERENCE MEASUREMENT —

When entering and leaving water pressure transducers or 4 to 20 mA water pressure differential transducers are installed, the PIC 5 can compute or read the water pressure difference between entering and leaving water pressure, and thereby determine if the water is flowing. After the water pump is switched on, if the water pressure difference reaches the threshold, the water flow check is passed and the chiller can start. Otherwise there will be an alarm shutdown.

Step 1: Set Factory Parameters → IOB4 Option as “Yes.”

Step 2: Set Option Configuration → Water Pressure Option as either “1 = Pres” or “2 = Pres.D” (4 to 20 mA signal). Note that for Option 2 the Water Pres Drop @ 20 mA must also be set in Option Configuration.

Step 3: In “Hydraulic Status” menu, check Condenser Water Delta P, Condenser Water Flow, Evaporator Water Delta P, Evaporator Water Flow.

MARINE OPTION(S) — A marine (shipboard) chiller has different requirements compared with typical chillers.

NOTE: These options are not intended to be used for comfort cooling applications.

Oil Stir — If Factory Parameters → Marine Option is enabled, when chiller is not running, the oil pump will be switched on for 30 seconds every 3 hours whether oil heater is on or off. When oil stir is in progress, oil heater will be switched off.

Power Request — If Factory Parameters → Power Request Option is enabled, when chiller is starting up, it will send power request signal and alert 104 while verifying water flow. After it receives permission to start feedback, the start-up will proceed. The power request signal will remain active until the compressor is switched on. If start feedback has not been received 5 minutes after power request is sent, or permission to start feedback is deactivated before compressor is switched on, the start-up process will terminate and trigger an alarm. If Factory Parameters → Cont Power Request option is enabled, the power request signal will remain active after the compressor is switched on. Should the signal be deactivated while the compressor is running, an alarm shutdown will be triggered.

Evaporator Approach Calculation — If Option Configuration → Evap App Calc Selection is set to Sat Temp, evaporator approach will be calculated from evaporator leaving water temperature and evaporator saturated temperature.

If this option is set to Ref Temp, evaporator approach will be calculated from evaporator leaving water temperature and evaporator refrigerant temperature.

Free Cooling — If Factory Parameters → Free Cooling Option is enabled, any one of the following will make the chiller start free cooling.

- Enable General Parameters → Start Free Cooling
- In Network Mode, enable General Parameters → Start Free Cooling from CCN, BACNet*, or Modbus†.
- Close Free Cooling Start Switch contact.

When free cooling is in progress, the chiller will take these actions:

- Switch on evaporator and condenser water pump
- Open head pressure valve to maximum opening position
- Open guide vane to maximum opening position
- Activate free cooling mode output contact.
- Display Free Cooling mode on the homepage.

Free cooling mode will only be activated when chiller is not running. If the chiller is running, free cooling start request will be ignored. When free cooling is in progress, chiller is not able to start up.

Condenser Flush — To prevent the chiller being corroded after left unused for a long time, it is suggested to flush the condenser once every week.

If Option Configuration → Condenser Flush Alert is enabled, when condenser pump has been not running for 7 days, alert 166 will be triggered to remind user to flush condenser. Activate condenser flush by enabling General Parameters → Start Condenser Flush. Alert 166 will be reset automatically after condenser flush is activated.

Condenser Flush will last for 2 hours and then end automatically. During Condenser Flush, the chiller will take these actions:

- Switch on the condenser water pump
- Open head pressure valve to maximum opening position
- Display Condenser Flush mode on the homepage.

Condenser Flush mode will only be activated when chiller is not running. If the chiller is running, Condenser Flush start request will be ignored. When free cooling is in progress, If chiller is commanded to start during condenser flush it will automatically end and chiller will normally start up.

*BACnet is a registered trademark of ASHRAE (American Society of Heating, Refrigerating, and Air-Conditioning Engineers).
†Modbus is a registered trademark of Schneider Electric.

DIAGNOSTICS AND TROUBLESHOOTING

The 19XR PIC 5 control system has many fault tracing aid functions. The local interface and its various menus give access to all unit operating conditions.

If an operating fault is detected, an alarm is activated. The alarm code is displayed in the Alarms menu, sub-menus Reset alarms and Current alarms. The control may record up to 10 current alarms and alerts.

Displaying Alarms — The alarm icon  on the interface (see the section Icons on page 13) indicates unit status as follows:

- A flashing red LED shows that the unit is operating but there is an alert.
- A steady red LED shows that the unit has been shut down due to a fault.

The Reset Alarms option on the main menu displays up to five alarm codes that are active on the unit. Table 17 lists alarm codes.

Resetting Alarms — When the cause of the alarm has been identified and corrected, the alarm can be reset either automatically or manually (depending on the type of alarm). See Table 17 for alarms that are eligible for automatic reset.

In the event of a power supply interrupt, if Auto Restart Option is set to ENABLE in the Option Configuration menu, the unit restarts automatically without the need for an external command.

A manual reset must be run from the main menu via the Reset Alarms Feature.

Once the alarm has been corrected or reset, all information regarding solved alarms is stored in the Alarm History. Alarm History will store last 50 alarms even after alarms have been corrected or reset.

Alarm/Alert Codes — Table 16 lists PIC 5 alarm codes. Table 18 lists PIC 5 alert codes. These do not cause machine shutdown and are automatically reset when the situation returns to normal.



Table 17 — PIC 5 Alarm Codes

ALARM CODE (ALARMRST)	ALARM TEXT DESCRIPTION	RESET TYPE	ACTION TAKEN BY CONTROL	POSSIBLE CAUSE
TEMPERATURE SENSOR FAULTS				
Alm-200	ALM-200 Sensor Fault — Leaving Chilled Water	Automatic if the temperature measured by the sensor returns to normal	Unit shuts down	Check sensor resistance. Check for proper wiring between leaving chilled water temperature sensor and IOB connector. Check for disconnected, grounded, or shorted wiring. Check IOB channel type configurations.
Alm-201	ALM-201 Sensor Fault — Entering Chilled Water	Automatic if the temperature measured by the sensor returns to normal	Unit shuts down	Check sensor resistance. Check for proper wiring between entering chilled water temperature sensor and IOB connector. Check for disconnected, grounded, or shorted wiring. Check IOB channel type configurations.
Alm-202	ALM-202 Sensor Fault — Leaving Cond Water Temp	Automatic if the temperature measured by the sensor returns to normal	Unit shuts down	Check sensor resistance. Check for proper wiring between leaving condenser water temperature sensor and IOB connector. Check for disconnected, grounded, or shorted wiring. Check IOB channel type configurations.
Alm-203	ALM-203 Sensor Fault — Entering Cond Water Temp	Automatic if the temperature measured by the sensor returns to normal	Unit shuts down	Check sensor resistance. Check for proper wiring between entering condenser water temperature sensor and IOB connector. Check for disconnected, grounded, or shorted wiring. Check IOB channel type configurations.
Alm-204	ALM-204 Sensor Fault — Comp Discharge Temp	Automatic if the temperature measured by the sensor returns to normal	Unit shuts down	Check sensor resistance. Check for proper wiring between compressor discharge temperature sensor and connector. Check for disconnected, grounded, or shorted wiring.
Alm-205	ALM-205 Sensor Fault — Oil Sump Temp	Automatic if the temperature measured by the sensor returns to normal	Unit shuts down	Check sensor resistance. Check for proper wiring between oil sump temperature sensor and IOB connector. Check for disconnected, grounded, or shorted wiring.
Alm-206	ALM-206 Sensor Fault — Oil Supply Temp	Automatic if the temperature measured by the sensor returns to normal	Unit shuts down	Check sensor resistance. Check for proper wiring between oil supply temperature sensor and IOB connector. Check for disconnected, grounded, or shorted wiring.
Alm-207	ALM-207 Sensor Fault — Evap Refrig Liquid Temp	Automatic if the temperature measured by the sensor returns to normal	Unit shuts down	Check sensor resistance. Check for proper wiring between evaporator refrigerant liquid temperature sensor and IOB connector. Check for disconnected, grounded, or shorted wiring.
Alm-208	ALM-208 Sensor Fault — Low Speed Motor End Bearing Temp	Automatic if the temperature measured by the sensor returns to normal	Unit shuts down	Check sensor resistance. Check for proper wiring between low speed motor end bearing temperature sensor and IOB connector. Check for disconnected, grounded, or shorted wiring. Check IOB channel type configurations.
Alm-209	ALM-209 Sensor Fault — Low Speed Comp End Bearing Temp	Automatic if the temperature measured by the sensor returns to normal	Unit shuts down	Check sensor resistance. Check for proper wiring between low speed compressor end bearing temperature sensor and IOB connector. Check for disconnected, grounded, or shorted wiring. Check IOB channel type configurations.
Alm-210	ALM-210 Sensor Fault — High Speed Motor End Bearing Temp	Automatic if the temperature measured by the sensor returns to normal	Unit shuts down	Check sensor resistance. Check for proper wiring between high speed motor end bearing temperature sensor and IOB connector. Check for disconnected, grounded, or shorted wiring. Check IOB channel type configurations.

Table 17 — PIC 5 Alarm Codes (cont)

ALARM CODE (ALARMRST)	ALARM TEXT DESCRIPTION	RESET TYPE	ACTION TAKEN BY CONTROL	POSSIBLE CAUSE
TEMPERATURE SENSOR FAULTS (CONT)				
Alm-211	ALM-211 Sensor Fault — High Speed Comp End Bearing Temp	Automatic if the temperature measured by the sensor returns to normal	Unit shuts down	Check sensor resistance. Check for proper wiring between high speed compressor end bearing temperature sensor and IOB connector. Check for disconnected, grounded, or shorted wiring. Check IOB channel type configurations.
Alm-212	ALM-212 Sensor Fault — Comp Motor Winding 1 Temp	Automatic if the temperature measured by the sensor returns to normal	Unit shuts down	Check sensor resistance. Check for proper wiring between compressor motor temp 1 sensor and IOB connector. Check for disconnected, grounded, or shorted wiring. Check IOB channel type configurations.
Alm-213	ALM-213 Sensor Fault — Comp Motor Winding 2 Temp	Automatic if the temperature measured by the sensor returns to normal	Unit shuts down	Check sensor resistance. Check for proper wiring between compressor motor temp 2 sensor and IOB connector. Check for disconnected, grounded, or shorted wiring. Check IOB channel type configurations.
Alm-214	ALM-214 Sensor Fault — Comp Motor Winding 3 Temp	Automatic if the temperature measured by the sensor returns to normal	Unit shuts down	Check sensor resistance. Check for proper wiring between compressor motor temp 3 sensor and IOB connector. Check for disconnected, grounded, or shorted wiring. Check IOB channel type configurations.
Alm-221	ALM-220 Sensor Fault — Thrust Bearing Oil Temp	Automatic if the temperature measured by the sensor returns to normal	Unit shuts down	Check sensor resistance. Check wiring between Thrust Bearing Oil Temp Sensor and IOB connector. Check for disconnected, grounded, or shorted wiring. Check IOB configuration.
Alm-228	ALM-228 Sensor Fault — Common CHWS Temp	Automatic if the temperature measured by the sensor returns to normal	Unit shuts down	Check sensor resistance. Check for proper wiring between Common CHWS Temp Sensor and IOB connector. Check for disconnected, grounded, or shorted wiring.
Alm-229	ALM-221 Sensor Fault — Common CHWR Temp	Automatic if the temperature measured by the sensor returns to normal	Unit shuts down	Check sensor resistance. Check for proper wiring between Common CHWR Temp Sensor and IOB connector. Check for disconnected, grounded, or shorted wiring.
PRESSURE TRANSDUCER FAULTS				
Alm-215	ALM-215 Sensor Fault — Condenser Pressure	Automatic if the voltage measured by the sensor returns to normal	Unit shuts down	Check condenser pressure transducer wiring. Confirm that 5 v reference signal is available between IOB connector. Check for disconnected, grounded, or shorted wiring. Check for condensation in transducer connector. Check SW2 dip switch in IOB for the channel configuration.
Alm-216	ALM-216 Sensor Fault — Evaporator Pressure	Automatic if the voltage measured by the sensor returns to normal	Unit shuts down	Check evaporator pressure transducer wiring. Confirm that 5 v reference signal is available between IOB connector. Check for disconnected, grounded, or shorted wiring. Check for condensation in transducer connector. Check SW2 dip switch in IOB for the channel configuration.
Alm-217	ALM-217 Sensor Fault — Economizer Pressure	Automatic if the voltage measured by the sensor returns to normal	Unit shuts down	Check economizer pressure transducer wiring. Confirm that 5 v reference signal is available between IOB connector. Check for disconnected, grounded, or shorted wiring. Check for condensation in transducer connector. Check SW2 dip switch in IOB for the channel configuration.

Table 17 — PIC 5 Alarm Codes (cont)

ALARM CODE (ALARMRST)	ALARM TEXT DESCRIPTION	RESET TYPE	ACTION TAKEN BY CONTROL	POSSIBLE CAUSE
PRESSURE TRANSDUCER FAULTS (CONT)				
Alm-218	ALM-218 Sensor Fault — Diffuser Pressure	Automatic if the voltage measured by the sensor returns to normal	Unit shuts down	Check diffuser pressure transducer wiring. Confirm that 5 v reference signal is available between IOB connector. Check for disconnected, grounded, or shorted wiring. Check for condensation in transducer connector. Check SW2 dip switch in IOB for the channel configuration.
Alm-219	ALM-219 Sensor Fault — Oil Sump Pressure	Automatic if the voltage measured by the sensor returns to normal	Unit shuts down	Check oil sump pressure transducer wiring. Confirm that 5 v reference signal is available between IOB connector. Check for disconnected, grounded, or shorted wiring. Check for condensation in transducer. Check SW2 dip switch in IOB for the channel configuration.
Alm-220	ALM-220 Sensor Fault — Oil Supply Pressure	Automatic if the voltage measured by the sensor returns to normal	Unit shuts down	Check oil supply pressure transducer wiring. Confirm that 5 v reference signal is available between IOB connectors. Check for disconnected, grounded, or shorted wiring. Check for condensation in transducer connector. Check SW2 dip switch in IOB for the channel configuration.
PRESTART FAILURES				
Alm-230	ALM-230 Prestart Failure — High Bearing Temperature	Manual	Unit shuts down. Compressor is not allowed to start.	Check Comp Bearing Temp in Temperature screen. Check oil heater and oil cooler for proper operation. Check for low oil level, partially closed oil supply valves, clogged oil filters. Check the compressor bearing temperature sensor wiring and accuracy to IOB connector. Check Comp Bearing Temp Alert setting.
Alm-231	ALM-231 Prestart Failure — High Motor Temperature	Manual	Unit shuts down. Compressor is not allowed to start.	Check Comp Motor Wind Temp in Temperature screen. Check motor temperature sensor for wiring and accuracy to IOB connector. Check motor cooling line and isolation valves for proper operation or restrictions, check refrigerant filter/drier. Check for excessive starts within a short time span. Check Comp Motor Temp Override setting.
Alm-232	ALM-232 Prestart Failure — High Discharge Temperature	Manual	Unit shuts down. Compressor is not allowed to start.	Check Comp Discharge Temp in Temperature screen. Allow compressor discharge temperature sensor to cool. Check compressor discharge temperature sensor wiring to IOB connector. Check for excessive starts. Check Comp Discharge Alert setting.
Alm-233	ALM-233 Prestart Failure — Low Refrigerant Temperature	Manual	Unit shuts down. Compressor is not allowed to start.	Check Evaporator Pressure, Evap Sat Refrig Temp, and Evap Refrig Liquid Temp in Temperature screen. Check Evaporator Pressure transducer and Evaporator Refrigerant Liquid Temperature sensor wiring and accuracy to IOB connector. Check for low chilled water supply temperatures. Check refrigerant charge. Check REFRIG OVERRIDE DELTA T and EVAP REFRIG TRIPPOINT in Configuration screen.

Table 17 — PIC 5 Alarm Codes (cont)

ALARM CODE (ALARMRST)	ALARM TEXT DESCRIPTION	RESET TYPE	ACTION TAKEN BY CONTROL	POSSIBLE CAUSE
PRESTART FAILURES (CONT)				
Alm-234	ALM-234 Prestart Failure — Low Line Voltage	Manual	Unit shuts down. Compressor is not allowed to start.	Check ACTUAL LINE VOLTAGE. Check UNDERVOLTAGE THRESHOLD in ISM_CONF screen. Check voltage supply. Check wiring to ISM J3-L1, J3-L2, and J3-L3. Check voltage transformers and switch gear. Consult power utility if voltage is low.
Alm-235	ALM-235 Prestart Failure — High Line Voltage	Manual	Unit shuts down. Compressor is not allowed to start.	Check ACTUAL LINE VOLTAGE. Check OVERVOLTAGE THRESHOLD in ISM_CONF screen. Check voltage supply. Check voltage transformers and switch gear. Consult power utility if voltage is high.
Alm-236	ALM-236 Guide Vane 1 — Calibration Not Completed	Manual	Unit shuts down. Compressor is not allowed to start.	Perform Guide Vane Calibration in Quick Test screen. Check guide vane actuator feedback potentiometer and wiring to IOB connector.
Alm-237	ALM-234 Prestart Failure — No Power Supply	Manual	Unit shuts down. Compressor is not allowed to start.	If WATER VERIFICATION TIME has passed after REQUEST TO START had been sent, there is still no PERMISSION TO START received
Alm-239	ALM-239 Envelop Control Valve Calibration Not Completed	Manual	Unit shuts down. Compressor is not allowed to start.	EC valve calibration failed during control test mode or prestart check.
PROTECTIVE LIMITS				
Alm-250	ALM-250 Protective Limit — Oil Pressure Difference Failure	Manual	Unit shuts down.	Check oil pump. Check oil filter. Check oil pump wiring.
Alm-251	ALM-251 Protective Limit — Low Chilled Water Flow	Manual	Unit shuts down.	Perform Chilled Water pump test in Quick Test screen. Check evaporator refrigerant liquid temperature and leaving chilled water temperature sensor accuracy and wiring to IOB. Check chilled water valves, pumps, and strainers. Check EVAP REFRIG TRIPPOINT, EVAP APPROACH ALERT, EVAP FLOW DELTA P CUTOUT, and WATER FLOW VERIFY TIME settings. Check load resistors, optional water flow switches or water flow delta P transducer calibration and wiring to IOB. Check for 5.0 v reference voltage between IOB connectors.
Alm-252	ALM-252 Protective Limit — Low Condenser Water Flow	Manual	Unit shuts down.	Perform Condenser Water pump test in Quick Test screen. Check condenser pressure transducer and leaving condenser water temperature sensor accuracy and wiring. Check condenser water valves and strainers. Check COND PRESS OVERRIDE, COND APPROACH ALERT, COND FLOW DELTA P CUTOUT, and WATER FLOW VERIFY TIME settings. Check load resistors, optional water flow switches or water flow delta P transducer calibration and wiring to IOB. Check for 5.0 v reference voltage between IOB connectors.

Table 17 — PIC 5 Alarm Codes (cont)

ALARM CODE (ALARMRST)	ALARM TEXT DESCRIPTION	RESET TYPE	ACTION TAKEN BY CONTROL	POSSIBLE CAUSE
PROTECTIVE LIMITS (CONT)				
Alm-253	ALM-253 Protective Limit — High Discharge Temperature	Manual	Unit shuts down.	<p>Check for closed compressor discharge isolation valve.</p> <p>Check if chiller was operating in surge conditions.</p> <p>Check compressor discharge temperature sensor resistance or voltage drop.</p> <p>Check for proper wiring to IOB connectors.</p> <p>Check for proper condenser flow and temperature.</p> <p>Check for proper inlet guide vane and optional diffuser actuator operation.</p> <p>Check for COMP DISCHARGE TEMP > 220 F (104 C)</p> <p>Check for fouled tubes, plugged water strainers, or noncondensables in the condenser.</p>
Alm-254	ALM-254 Protective Limit — Low Evaporator Refrigerant Temperature	Manual	Unit shuts down.	<p>Check for proper refrigerant charge.</p> <p>Check float valve operation.</p> <p>Check for closed condenser liquid line isolation valve.</p> <p>If problem occurs at high load, check for low condenser pressure which causes inadequate refrigerant flow through condenser flange orifices.</p> <p>Check for proper chilled water flow and temperature.</p> <p>Confirm that condenser water enters bottom row of condenser tubes first (reversed condenser water flow may cause refrigerant to stack in the condenser).</p> <p>Check evaporator pressure transducer and evaporator refrigerant liquid temperature and leaving chilled water sensors.</p> <p>Check for division plate gasket bypass.</p> <p>Check for fouled tubes.</p> <p>Check pressure transducer and temperature sensor wiring to the IOB.</p>
Alm-255	ALM-255 Protective Limit — High Motor Temperature	Manual	Unit shuts down.	<p>Check compressor motor winding temperature sensor accuracy and wiring to IOB.</p> <p>Check motor cooling line and spray nozzle for proper operation or restrictions.</p> <p>Check motor cooling filter/drier and isolation valves.</p> <p>Look for refrigerant flow through motor cooling line sight glass.</p> <p>Check for excessive starts within a short time span.</p>
Alm-256	ALM-256 Protective Limit — High Bearing Temperature	Manual	Unit shuts down.	<p>Check oil heater for proper operation; confirm that oil heater is de-energized when compressor is running.</p> <p>Check for low oil level, partially closed oil line isolation valves, or clogged oil filter.</p> <p>Check oil cooler refrigerant thermal expansion valves; confirm that expansion valve bulbs are secured to the oil lines and insulated.</p> <p>Check compressor bearing temperature sensors accuracy and wiring to IOB.</p> <p>This fault can result from excessive operation at low load with low water flow to the evaporator or condenser. Very high discharge and volute temperatures may increase the oil sump temperature. Elevated sump temperature may result from an excessively high oil level reaching the bottom of the bull gear, causing it to churn the oil.</p>

Table 17 — PIC 5 Alarm Codes (cont)

ALARM CODE (ALARMRST)	ALARM TEXT DESCRIPTION	RESET TYPE	ACTION TAKEN BY CONTROL	POSSIBLE CAUSE
PROTECTIVE LIMITS (CONT)				
Alm-257	ALM-257 Protective Limit — High Condenser Temperature	Manual	Unit shuts down.	Check CONDENSER PRESSURE. Check for high condenser water temperatures, low water flow, fouled tubes. Check for division plate/gasket bypass or plugged condenser water strainers. Check for noncondensables in condenser. Check condenser pressure transducer wiring and accuracy to IOB. Configure COND PRESS OVERRIDE in configuration screen. NOTE: This alarm is not caused by the high condenser pressure switch.
Alm-258	ALM-258 Protective Limit — Spare Safety Device	Manual	Unit shuts down.	Spare safety input has been closed.
Alm-259	ALM-259 Protective Limit — Excessive Compressor Surge	Manual	Unit shuts down.	Five SURGE PROTECTION COUNTS occurred within SURGE TIME PERIOD. VFD Only: Surge prevention alarm declared when ACTUAL VFD SPEED is at least 90%. Check for high condenser water temperatures, low water flow, fouled tubes. Check CONDENSER APPROACH. Check condenser water strainers. Check for division plate/gasket bypass. Check for noncondensables in condenser. Check surge prevention parameters in OPTIONS screen. Compare cooling tower control settings and performance against design/selection temperatures across the entire operating range of the chiller. Check EVAPORATOR APPROACH and chilled water flow.
Alm-260	ALM-260 Protective Limit — Compressor Start Relay Start Failure	Manual	Unit shuts down.	Check motor starter 1M contactor wiring. Check ISM current sensors.
Alm-261	ALM-261 Protective Limit — Evaporator Frozen	Manual	Unit shuts down.	Check CALC EVAP SAT TEMP, EVAP REFRIG LIQUID TEMP, and EVAP REFRIG TRIPPOINT. Check for proper refrigerant charge. Check float valve operation. Confirm that optional refrigerant liquid line isolation valve is open. Check for proper Chilled Water flow and temperature. Confirm that condenser water enters bottom row of condenser tubes first (reversed condenser water flow may cause refrigerant to stack in the condenser). Check evaporator pressure transducer and evaporator refrigerant liquid temperature sensor. Check for evaporator water box division plate gasket bypass. Check for fouled tubes.
Alm-262	ALM-262 Protective Limit — Condenser Frozen	Manual	Unit shuts down.	The Cond Sat Refrig Temp is less than the Condenser Freeze Point. Check Condenser Freeze Point in configuration. Condenser water too cold or chiller shut down with brine below 32° F (0° C) in cooler so equalization temperature in chiller approached 32° F (0° C). Check condenser pressure transducer and wiring to IOB. Check condenser water temperature sensors and wiring to IOB. Check refrigerant charge.
Alm-263	ALM-263 Protective Limit — Invalid Diffuser Config	Manual	Unit shuts down.	Check SRD Configurations.

Table 17 — PIC 5 Alarm Codes (cont)

ALARM CODE (ALARMRST)	ALARM TEXT DESCRIPTION	RESET TYPE	ACTION TAKEN BY CONTROL	POSSIBLE CAUSE
PROTECTIVE LIMITS (CONT)				
Alm-264	ALM-264 Protective Limit — Diffuser Position Fault	Manual	Unit shuts down.	Confirm that Diffuser Option in SRD Configuration screen has not been Enabled if compressor does not have a split ring diffuser. May indicate rotating stall condition. Check rotating stall transducer wiring accuracy and sealing. Check diffuser schedule and guide vane schedule in SRD Configuration screen. Check for proper operation of diffuser and inlet guide vane actuators including inlet guide vane calibration. Check diffuser actuator coupling for rotational slip. Check for electrical noise in IOB Diffuser Pressure wiring. Do not continue to operate compressor except for diagnostic purposes..
Alm-265	ALM-265 Protective Limit — Refrigerant Leak	Manual	Unit shuts down.	REFRIGERANT LEAK OPTION is Enabled and the REFRIGERANT LEAK SENSOR output exceeded REFRIGERANT LEAK ALARM mA. Check for refrigerant leaks. Check leak detector for proper operation. Check REFRIGERANT LEAK ALARM mA setting in the OPTIONS screen. Check 4 to 20 mA or 1 to 5 v output from refrigerant leak sensor to IOB. Confirm that IOB SW2 dip switch 1 is in the correct position.
Alm-266	ALM-266 Protective Limit — IOB Low Voltage	Automatic	Unit shuts down.	Check IOB 24 VAC power supply and the transformer output voltage.
Alm-267	ALM-267 Protective Limit — Guide Vane Fault	Manual	Unit shuts down.	Alarm before start indicates guide vane opening has not closed to less than 4%. Alarm while running indicates guide vane position is < -1% or > 103%. Enter Quick Test and conduct Guide Vane Calibration. Check wiring between the guide vane feedback potentiometer and IOB terminals. Check the 10,000 ohm guide vane position feedback potentiometer or 4 to 20mA current.
Alm-268	ALM-268 Protective Limit — Damper Valve Fault	Manual	Unit shuts down.	Check damper valve wirings. Do a control test on the damper valve to check the feedback signals.
Alm-269	ALM-268 Protective Limit — EC Valve Fault	Manual	Unit shuts down.	Check EC valve wirings. Do a control test on the EC/HGBP valve to check the feedback signals.
Alm-270	ALM-270 Protective Limit — High Cond Water Flow	Manual	Unit shuts down.	Check condenser water pressure sensor and wirings.
Alm-271	ALM-271 Protective Limit — Emergency Stop	Automatic	Unit shuts down.	Check EMSTOP command from network and the remote stop dry contact from IOB.
Alm-272	ALM-272 Protective Limit — ISM Config Conflict	Automatic	Unit shuts down.	Configuration data in controller and ISM are mismatched. In Maintenance menu, choose Maintains ISM config→Delete ISM config: NO - Upload ISM configuration data to HMI YES- Download ISM configuration to ISM
Alm-273	ALM-273 Protective Limit — Swift Restart Limit Exceeded	Manual	Unit shuts down.	Understand the reason and correct why Swift Restart happens frequently.
Alm-274	ALM-274 Protective Limit — Chiller Lockout	Automatic	Unit shuts down.	Check chiller lockout input in IOB
Alm-275	ALM-275 Protective Limit — Fire Alarm	Automatic	Unit shuts down.	Check fire alarm input in IOB
Alm-276	ALM-276 Protective Limit — Stop Override	Manual	Unit shuts down.	Check stop override point status in GENUUNIT table
Alm-280	ALM-280 Protective Limit — High VFD speed	Manual	Unit shuts down.	Check VFD actual speed

NOTE: Some alarm codes (identified in the Reset Type column) are eligible for Swift Restart when the Auto Restart option is enabled.

The Swift Restart algorithm allows for quicker restart and decreases the normal start-up delays and verification times.

Table 17 — PIC 5 Alarm Codes (cont)

ALARM CODE (ALARMRST)	ALARM TEXT DESCRIPTION	RESET TYPE	ACTION TAKEN BY CONTROL	POSSIBLE CAUSE
COMMUNICATION FAILURE				
Alm-282	ALM-282 Protective Limit — Displacement Switch	Manual	Unit shuts down.	Check impeller displacement switch.
Alm-283	ALM-283 Protective Limit — High Pressure Switch	Manual	Unit shuts down.	Check high pressure switch.
Alm-284	ALM-284 Protective Limit — Power Feedback Loss	Manual	Unit shuts down.	Check Power Feedback Input.
Alm-296	ALM-296 Protective Limit — High Evaporator Pressure	Manual	Unit shuts down.	Check evaporator pressure sensor input. Check evaporator pressure cutout configurations.
Alm-300	ALM-300 Loss Communication with ISM	Automatic when communication returns to normal (Swift Restart eligible)	Unit shuts down.	Check LEN communication cable. Check the wiring and termination resistor settings.
Alm-301	ALM-301 Loss of Communication with IOB 1	Automatic when communication returns to normal	Unit shuts down.	Check LEN communication cable. Check the wiring and termination resistor settings.
Alm-302	ALM-302 Loss of Communication with IOB 2	Automatic when communication returns to normal	Unit shuts down.	Check LEN communication cable. Check the wiring and termination resistor settings.
Alm-303	ALM-303 Loss of Communication with IOB 3	Automatic when communication returns to normal	Unit shuts down.	Check LEN communication cable. Check the wiring and termination resistor settings.
Alm-304	ALM-304 Loss of Communication with IOB 4	Automatic when communication returns to normal	Unit shuts down.	Check LEN communication cable. Check the wiring and termination resistor settings.
Alm-305	ALM-305 Loss of Communication with IOB 5	Automatic when communication returns to normal	Unit shuts down.	Check LEN communication cable. Check the wiring and termination resistor settings.
Alm-306	ALM-306 Loss of Communication with IOB 6	Automatic when communication returns to normal	Unit shuts down.	Check LEN communication cable. Check the wiring and termination resistor settings.
Alm-307	ALM-307 LEN Scan Error	Manual	Unit shuts down.	Check LEN bus hardware physical wiring and software log
Alm-308	ALM-308 Loss Communication with VFD	Automatic when communication returns to normal	Unit shuts down.	Bus installation fault or defective slave board
Alm-309	ALM-309 Loss Communication with VFD Gateway (LEN)	Manual	Unit shuts down.	Bus installation fault or defective slave board
Alm-310	ALM-310 Loss Communication with VFD (Modbus)	Manual	Unit shuts down.	Bus installation fault or defective slave board
INTEGRATED STARTER MODULE ALARMS				
Alm-400	ALM-400 ISM Fault — Line Voltage Dropout	Manual (Swift Restart eligible)	Unit shuts down.	Temporary loss of voltage. SINGLE CYCLE DROPOUT in the ISM_CONF screen is Enabled and two LINE VOLTAGES < 50% MOTOR RATED LINE VOLTAGE. Check ISM_HIST screen. Disable Single Cycle Dropout in VFD_CONF screen.
Alm-401	ALM-401 ISM Fault — Line Phase Loss	Manual (Swift Restart eligible)	Unit shuts down.	Any LINE VOLTAGE < 50% MOTOR RATED LINE VOLTAGE, or there is an excessive difference between the smallest LINE CURRENT and the largest LINE CURRENT. Check the ISM_HIST screen. Check MOTOR RATED LINE VOLTAGE in ISM_CONF screen. Check phase to phase and phase to ground power distribution bus voltage. Check current transformer wiring leading to ISM terminal block J4 and line voltage wiring leading to ISM terminal block J3. Check wiring and hardware between building power supply and motor. Current imbalance may improve if power or motor leads are rotated in the same phase sequence. Consult power company. Medium voltage applications only: Check voltage potential transformers and VOLT TRANSFORMER RATIO in ISM_CONF screen.

NOTE: Some alarm codes (identified in the Reset Type column) are eligible for Swift Restart when the Auto Restart option is enabled.

The Swift Restart algorithm allows for quicker restart and decreases the normal start-up delays and verification times.

Table 17 — PIC 5 Alarm Codes (cont)

ALARM CODE (ALARMRST)	ALARM TEXT DESCRIPTION	RESET TYPE	ACTION TAKEN BY CONTROL	POSSIBLE CAUSE
INTEGRATED STARTER MODULE ALARMS (CONT)				
Alm-402	ALM-402 ISM Fault — High Line Voltage	Manual (Swift Restart eligible)	Unit shuts down.	High LINE VOLTAGE for an excessive amount of time. Check LINE VOLTAGE in ISM_HIST screen. Check MOTOR RATED LINE VOLTAGE and OVERVOLTAGE THRESHOLD in ISM_CONF screen. Check phase to phase and phase to ground distribution bus voltage. Consult power company. Medium voltage applications only: Check voltage potential transformers and VOLT TRANSFORMER RATIO in ISM_CONF screen. Check wiring to ISM J3-VL1, J3-VL2 and J3-VL3.
Alm-403	ALM-403 ISM Fault — Low Line Voltage	Manual (Swift Restart eligible)	Unit shuts down.	Low LINE VOLTAGE for an excessive amount of time. Check LINE VOLTAGE in ISM_HIST screen. Check MOTOR RATED LINE VOLTAGE and UNDERVOLTAGE THRESHOLD in ISM_CONF screen. Check phase to phase and phase to ground distribution bus voltage. Check connections to ISM terminal block J3. Consult power company. Medium voltage applications only: Check voltage potential transformers and VOLT TRANSFORMER RATIO in ISM_CONF screen. Check wiring to ISM J3-VL1, J3-VL2 and J3-VL3.
Alm-404	ALM-404 ISM Fault — Line Current Imbalance	Manual (Swift Restart eligible)	Unit shuts down.	Current imbalance > CURRENT % IMBALANCE for greater than the CURRENT IMBALANCE TIME. Check settings in ISM_CONF screen. Check ISM_HIST screen. Check current transformer wiring leading to ISM terminal block J4. Verify phase to phase and phase to ground line voltage. Check wiring and hardware between building power supply and motor. Current imbalance may improve if power or motor leads are rotated in the same phase sequence.
Alm-405	ALM-405 ISM Fault — Line Voltage Imbalance	Manual	Unit shuts down.	Voltage Imbalance > VOLTAGE % IMBALANCE for greater than the VOLTAGE IMBALANCE TIME. Check settings in ISM_CONF screen. Check ISM_HIST screen. Check line voltage wiring leading to ISM terminal block J3. Verify phase to phase and phase to ground line voltage. Check wiring and hardware between building power supply and motor.
Alm-406	ALM-406 ISM Fault — Overload Trip	Manual	Unit shuts down.	Any phase current > 108% RLA for excessive time period. Alarm can result from significant load side current imbalance when running at full load. Check ISM_HIST screen. Check for consistent entering condenser water temperature and water flow rates. Check MOTOR RATED LOAD AMPS and STARTER LRA RATING in ISM_CONF screen. VFD applications only: Any phase current > 120% for excessive time period.

NOTE: Some alarm codes (identified in the Reset Type column) are eligible for Swift Restart when the Auto Restart option is enabled. The Swift Restart algorithm allows for quicker restart and decreases the normal start-up delays and verification times.

Table 17 — PIC 5 Alarm Codes (cont)

ALARM CODE (ALARMRST)	ALARM TEXT DESCRIPTION	RESET TYPE	ACTION TAKEN BY CONTROL	POSSIBLE CAUSE
INTEGRATED STARTER MODULE ALARMS (CONT)				
Alm-407	ALM-407 ISM Fault — Motor Locked Rotor Trip	Manual	Unit shuts down.	Any LINE CURRENT > MOTOR LOCKED ROTOR TRIP for excessive time while running after the LOCKED ROTOR START DELAY has expired. Check MOTOR LOCKED ROTOR TRIP and MOTOR CURRENT CT RATIO in ISM_CONF screen. Check motor nameplate data. Check ISM_HIST screen. Check motor wiring and motor winding resistance. Temporarily enable SINGLE CYCLE DROP OUT to capture power disturbances.
Alm-408	ALM-408 ISM Fault — Starter Lock Rotor Trip	Manual	Unit shuts down.	Any LINE CURRENT > MOTOR LOCKED ROTOR TRIP for excessive time while running after the LOCKED ROTOR START DELAY has expired. Check MOTOR LOCKED ROTOR TRIP and MOTOR CURRENT CT RATIO in ISM_CONF screen. Check motor nameplate data. Check ISM_HIST screen. Check motor wiring and motor winding resistance. Temporarily enable SINGLE CYCLE DROP OUT to capture power disturbances.
Alm-409	ALM-409 ISM Fault — Ground Fault	Manual	Unit shuts down.	Any GROUND FAULT current > GROUND FAULT CURRENT threshold for a duration > GROUND FAULT PERSISTENCE after the GROUND FAULT START DELAY has expired. Check these settings and GROUND FAULT CT RATIO in ISM_CONF screen. Check ISM_HIST screen. Confirm that ground fault current transformer orientation is correct, and that the correct motor leads have been routed through the ground fault current transformers in the right direction. Check for condensation on motor terminals or inside motor leads. Check motor power leads for phase to phase or phase to ground shorts. Disconnect motor from starter and merger motor windings to ground and phase to phase. Call Carrier Service.
Alm-410	ALM-410 ISM Fault — Phase Reversal Trip	Manual	Unit shuts down.	The ISM has detected that the input power is phased BAC instead of ABC. Confirm that the phase sequence wired to ISM terminal block J3 is consistent with the power wiring to the starter. Swap two power leads at the starter. Check ISM Status under the Maintenance Menu.
Alm-411	ALM-411 ISM Fault — Line Frequency Trip	Manual	Unit shuts down.	LINE FREQUENCY FAULTING in ISM_CONF screen is enabled and the LINE FREQUENCY has deviated approximately 7% from nominal value. Check ISM_HIST screen. Check FREQUENCY = 60 HZ? in ISM_CONF screen. Check line frequency. If operating from a generator, check generator size and speed.
Alm-412	ALM-412 ISM Fault — Starter Module Reset	Manual (Swift Restart eligible)	Unit shuts down.	AUTO RESTART OPTION in OPTIONS screen is disabled and there was a temporary loss of 115 v ISM control voltage supply. Check ISM_HIST screen. Check wiring leading to ISM terminals J1-LL1 and J1-LL2. Check control power circuit breaker, control power transformer and control power circuit fuses. Monitor chiller utility power for disruptions. Improve ISM ground connection; apply measures to reduce electrical noise to ISM. Consult power company.

NOTE: Some alarm codes (identified in the Reset Type column) are eligible for Swift Restart when the Auto Restart option is enabled.

The Swift Restart algorithm allows for quicker restart and decreases the normal start-up delays and verification times.

Table 17 — PIC 5 Alarm Codes (cont)

ALARM CODE (ALARMRST)	ALARM TEXT DESCRIPTION	RESET TYPE	ACTION TAKEN BY CONTROL	POSSIBLE CAUSE
INTEGRATED STARTER MODULE ALARMS (CONT)				
Alm-413	ALM-413 ISM Fault — Start Contact Fault	Manual	Unit shuts down.	Check 1M dry contact input.
Alm-414	ALM-414 ISM Fault — Transition Contact Fault	Manual	Unit shuts down.	Check 2M dry contact input.
Alm-415	ALM-415 ISM Fault — Oil Pump/High Pressure Switch Failure	Manual	Unit shuts down.	Check high pressure switch and oil pump.
Alm-416	ALM-416 ISM Fault — Starter Fault	Manual	Unit shuts down.	The ISM has received a start command and the starter has declared a Fault. The dry contacts connected to ISM J2-7 and J2-8 are open. See starter display for starter Fault Code. For Benshaw Inc. RediStart starters, view RediStart MICRO display. For VFD, check VFD display Fault History. Clear VFD faults with VFD keypad. For Allen-Bradley wye delta starters with RLA > 718 A, the TR3 timer may have expired as a result of a delayed transition.
Alm-417	ALM-417 ISM Fault — Motor Amps Not Sensed	Manual	Unit shuts down.	The ISM has not sensed sufficient current for an excessive delay after 1M has closed. Check ISM_HIST screen Check the MOTOR CURRENT CT RATIO and the MOTOR RATED LOAD AMPS in the ISM_CONF screen. Check VFD OPTION configuration. Check for wiring of current transformers to the J4 ISM terminals. Check if main circuit breaker has tripped. Check ISM History under the Maintenance Menu.
Alm-418	ALM-418 ISM Fault — Excessive Acceleration Time	Manual	Unit shuts down.	Any line current remains high for an excessive time duration following 1M aux and either 2M aux or transition contact closure. Check that inlet guide vanes are fully closed at start-up. Check ISM_HIST screen. Check Motor Rated Load Amps in ISM_CONF screen. Reduce condenser pressure if possible.
Alm-419	ALM-419 ISM Fault — Excessive Motor Amps	Manual	Unit shuts down.	AVERAGE LINE CURRENT > 110% for an excessive amount of time. Check MOTOR RATED LOAD AMPS and MOTOR CURRENT CT RATIO in ISM_CONF time. Check ISM_HIST screen. Check for conditions that cause excessive lift. Check guide vane actuator for proper operation. Confirm that guide vanes will fully close prior to start-up.
Alm-420	ALM-420 ISM Fault — Start Transition Contact Failure	Manual	Unit shuts down.	Check 1M and 2M dry contact inputs
Alm-421	ALM-421 ISM Fault — Motor Amps When Stopped	Manual	Unit shuts down.	High line current measured on any phase after power up or STOP command. Check the MOTOR CURRENT CT RATIO and the MOTOR RATED LOAD AMPS in the ISM_CONF screen. Check VFD OPTION in SETUP 2 screen. Check ISM_HIST screen. Check for high inrush current during power-up. Confirm that the starter de-energizes the motor when the ISM removes 115 v from ISM J9-2. Confirm that the correct STARTER TYPE has been selected in the ISM_CONF screen.
Alm-422	ALM-422 ISM Fault — Starter Module Failure	Manual	Unit shuts down.	Check ISM Hardware

Table 17 — PIC 5 Alarm Codes (cont)

ALARM CODE (ALARMRST)	ALARM TEXT DESCRIPTION	RESET TYPE	ACTION TAKEN BY CONTROL	POSSIBLE CAUSE
INTEGRATED STARTER MODULE ALARMS (CONT)				
Alm-423	ALM-423 ISM Fault — Calibration Factor Error	Manual	Unit shuts down.	Check ISM Calibration Values
Alm-424	ALM-424 ISM Fault — Invalid Configuration Error	Manual	Unit shuts down.	Check ISM Configurations
Alm-425	ALM-425 VFD Fault — Single Cycle Dropout	Manual	Unit shuts down.	Temporary loss of voltage. Disable Single Cycle Dropout in CFGUMVFD screen.
Alm-426	ALM-426 VFD Fault — Line Current Imbalance	Manual	Unit shuts down.	Check phase to phase and phase to ground power distribution bus voltage. Check Line Current Imbalance% in CFGUMVFD screen. Consult power company.
Alm-427	ALM-427 VFD Fault — High Line Voltage	Manual	Unit shuts down.	Check phase to phase and phase to ground distribution bus voltage. Consult power company.
Alm-428	ALM-428 VFD Fault — Low Line Voltage	Manual	Unit shuts down.	Check phase to phase and phase to ground distribution bus voltage. Consult power company.
Alm-429	ALM-429 VFD Fault — Low DC Bus Voltage	Manual	Unit shuts down.	Verify phase-to-phase and phase-to-ground line voltage. VFD Circuit Board malfunction. Call Carrier Service.
Alm-430	ALM-430 VFD Fault — High DC Bus Voltage	Manual	Unit shuts down.	Verify phase to phase and phase to ground line voltage. Monitor AC line for high transient voltage conditions. VFD Circuit Board malfunction. Call Carrier Service
Alm-431	ALM-431 VFD Fault — VFD Power On Reset	Manual	Unit shuts down.	Temporary loss of VFD control voltage. Check VFD control power breaker, transformer, and fuses
Alm-432	ALM-432 VFD Fault — Ground Fault	Manual	Unit shuts down.	Check for condensation on motor terminals. Check motor power leads for phase to phase or phase to ground shorts. Disconnect motor from VFD and megger motor. Call Carrier Service.
Alm-433	ALM-433 VFD Fault — Line Phase Reversal	Manual	Unit shuts down.	Reverse connections of any two line conductors to circuit breaker.
Alm-434	ALM-434 VFD Fault — Motor Overload Trip	Manual	Unit shuts down.	Check VFD configurations Any phase current > 106% RLA. Can result from significant load side current imbalance when running at full load. Check entering condenser water temperature and water flow rate. Check Motor Rated Load Amps in CFGUMVFD screen.
Alm-435	ALM-435 VFD Fault — Rectifier Power Fault	Manual	Unit shuts down.	Check VFD Status Malfunction within VFD Power Module. Call Carrier Service.
Alm-436	ALM-436 VFD Fault — Inverter Power Fault	Manual	Unit shuts down.	Check VFD Status Malfunction within VFD Power Module. Call Carrier Service.
Alm-437	ALM-437 VFD Fault — Rectifier Overcurrent	Manual	Unit shuts down.	Check VFD Status Check for high water temperatures or changes in water flow rates.
Alm-438	ALM-438 VFD Fault — Inverter Overcurrent	Manual	Unit shuts down.	Check VFD Status Check for high entering water temperature or low condenser water flow. Check current settings in CFGUMVFD screen.
Alm-439	ALM-439 VFD Fault — Condenser High Pressure	Manual	Unit shuts down.	Check Compressor Discharge High Pressure switch wiring and accuracy. Check for high condenser water temperatures, low water flow, fouled tubes. Check for division plate/gasket bypass. Check for noncondensables in refrigerant.
Alm-440	ALM-440 VFD Fault — Motor Amps Not Sensed	Manual	Unit shuts down.	Check main circuit breaker for trip. Increase Current % Imbalance in CFGUMVFD screen.
Alm-441	ALM-441 VFD Fault — Motor Acceleration Fault	Manual	Unit shuts down.	Check that inlet guide vanes are fully closed at start-up. Check Motor Rated Load Amps in CFGUMVFD screen. Reduce unit pressure if possible.

Table 17 — PIC 5 Alarm Codes (cont)

ALARM CODE (ALARMRST)	ALARM TEXT DESCRIPTION	RESET TYPE	ACTION TAKEN BY CONTROL	POSSIBLE CAUSE
INTEGRATED STARTER MODULE ALARMS (CONT)				
Alm-442	ALM-442 VFD Fault — Stop Fault	Manual	Unit shuts down.	Check Inverter Power Unit VFD Circuit Board malfunction. Call Carrier Service.
Alm-443	ALM-443 VFD Fault — Rectifier Overtemp	Manual	Unit shuts down.	Check Cooling and VFD Config. Check that VFD refrigerant isolation valves are open. Check VFD refrigerant cooling solenoid and refrigerant strainer. Check for proper VFD cooling fan operation and blockage.
Alm-444	ALM-444 VFD Fault — Inverter Overtemp	Manual	Unit shuts down.	Check Cooling and VFD Config. Check that VFD refrigerant isolation valves are open. Check VFD refrigerant cooling solenoid and refrigerant strainer. Check for proper VFD cooling fan operation and blockage.
Alm-445	ALM-445 VFD Fault — Motor Current Imbalance	Manual	Unit shuts down.	Check Motor Current Imbalance% in CFGUMVFD screen.
Alm-446	ALM-446 VFD Fault — Line Voltage Imbalance	Manual	Unit shuts down.	Check phase-to-phase and phase-to-ground distribution bus voltage. Increase Line Voltage Imbalance% in CFGUMVFD screen.
Alm-447	ALM-447 VFD Fault — Frequency Fault	Manual	Unit shuts down.	Check Power Supply. If operating from a generator, check generator size and speed. Check utility power supply.
Alm-448	ALM-448 VFD Fault — VFD Comm Fail	Manual	Unit shuts down.	Check VFD communication wiring and connectors. Check status lights on DPI Communications Interface Board. Call Carrier Service.
Alm-449	ALM-449 VFD Fault — VFD Fault	Manual	Unit shuts down.	Check fault code and possible cause in corresponding type of VFD user manuals. Call Carrier Service.
Alm-450	ALM-450 VFD Fault — VFD Start Inhibit	Manual	Unit shuts down.	The VFD Start Inhibit is derived from the Alarm bit being set in the VFD. The conditions causing the alarm must be corrected in the VFD to enable subsequent starts and operation.
Alm-451	ALM-451 VFD Fault — VFD Checksum Error	Manual	Unit shuts down.	Press Reset to Restore Configuration. Actual VFD checksum does not match calculated value.
Alm-452	ALM-452 VFD Fault — Inductor Overtemp Switch	Manual	Unit shuts down.	Check Temp Switch and Cooling Fans. Check for cooling fan air flow obstructions.
Alm-453	ALM-453 VFD Fault — Incompatibility Fault	Manual	Unit shuts down.	Load compatible version files into drive.

Table 18 — PIC 5 Alert Codes

ALERT CODE (ALARMST)	ALERT TEXT DESCRIPTION	RESET TYPE	ACTION TAKEN BY CONTROL	POSSIBLE CAUSE
PRESTART ALERTS				
Alt-100	ALT-100 Prestart Alert — Starts Limit Exceeded	Automatic when the situation returns to normal	Turn on Alert relay.	Check STARTS IN 12 HOURS in Run times screen. Enable “Enable Excessive Starts” option in Service menu if additional start is required. NOTE: Recycle restarts and auto restarts after power failure are not counted in Starts Limit.
Alt-101	ALT-101 Prestart Alert — Low Oil Temperature	Automatic when the situation returns to normal	Alert relay is ON.	Check OIL SUMP TEMP in default screen. Check oil heater contactor/relay and power. Check oil sump temperature sensor wiring and accuracy. Check oil level and oil pump operation. Check EVAP SAT TEMP.
Alt-102	ALT-102 Prestart Alert — High Condenser Pressure	Automatic when the situation returns to normal	Alert relay is ON.	Check CONDENSER PRESSURE. Check condenser pressure transducer wiring and accuracy. Check for high condenser water temperatures. Check COND PRESS OVERRIDE in configuration.
Alt-103	ALT-103 Prestart Alert — Excessive Recycle Starts	Automatic when the situation returns to normal	Alert relay is ON.	Chiller load is too low to keep compressor on line and there have been more than 5 starts in 4 hours. Increase chiller load, adjust hot gas bypass to open at a higher load, increase recycle RESTART DELTA T in service menu. Check hot gas bypass isolation valve position.
Alt-104	ALT-104 Prestart Alert — Waiting for Start Permission	Automatic when the situation returns to normal	Alert relay is ON.	Power request option is enabled.
SENSOR ALERTS				
Alt-120	Alt-120 Sensor Alert — Remote Temperature Out of Range	Automatic when the situation returns to normal	Alert relay is ON.	Type 2 Temperature Reset is Enabled and remote temperature reset sensor is out of range. Check ENABLE RESET TYPE and TEMPERATURE RESET settings in TEMP_CNTL screen. Check remote temperature reset sensor resistance or voltage drop. Check for proper wiring to IOB. Check IOB channel type configurations and SW2 dip switch setting in IOB.
Alt-121	Alt-121 Sensor Alert — Auto Water Temp Reset	Automatic when the situation returns to normal	Alert relay is ON.	Check Temp Reset Configuration. Confirm that Auto Water Temp Reset Input is between 4 mA and 20 mA. Confirm that wiring to IOB connector is not grounded.
Alt-122	Alt-122 Sensor Alert — Auto Demand Limit Input	Automatic when the situation returns to normal	Alert relay is ON.	20 mA DEMAND LIMIT OPT is Enabled, Ice Build is not Active, and Auto Demand Limit Input on IOB is < 2 mA. Check 20 mA DEMAND LIMIT OPT and DEMAND LIMIT AT 20 mA in Service screen. Confirm that Auto Demand Limit Input is between 4 mA and 20 mA. Confirm that wiring to IOB connector is not grounded. Check IOB channel type configurations and SW2 dip switch setting in IOB.
Alt-123	Alt-123 Sensor Alert — VFD Speed Out of Range	Automatic when the situation returns to normal	Alert relay is ON.	Check VFD speed feedback input in ISM
Alt-124	Alt-124 Sensor Alert — Humidity Sensor	Automatic when the situation returns to normal	Alert relay is ON.	Check humidity sensor input in IOB
Alt-125	Alt-125 Sensor Alert — Refrigerant Leak Input	Automatic when the situation returns to normal	Alert relay is ON.	Check refrigerant leak optional input in IOB
Alt-126	Alt-126 Sensor Alert — Diffuser Pos Feedback	Automatic when the situation returns to normal	Alert relay is ON.	Check diffuser position feedback.
Alt-127	ALT-127 Sensor Alert — VFD Current Input	Automatic when the situation returns to normal	Alert relay is ON.	Check VFD current input
Alt-128	Alt-128 Sensor Alert — High Cond Water Pressure	Automatic when the situation returns to normal	Alert relay is ON.	Check optional condenser water pressure sensor. Check condenser water flow.
Alt-129	Alt-129 Sensor Alert — Leaving Cond Water Temp	Automatic when the situation returns to normal	Alert relay is ON.	Leaving condenser water temperature sensor reading is out of range. Check leaving condenser water sensor resistance or voltage drop. Check for proper wiring to IOB. Check IOB channel type configurations.
Alt-130	ALT-130 Sensor Alert — Entering Cond Water Temp	Automatic when the situation returns to normal	Alert relay is ON.	Entering condenser water temperature sensor reading is out of range. Check entering condenser water sensor resistance or voltage drop. Check for proper wiring to IOB. Check IOB channel type configurations.
Alt-131	ALT-131 Sensor Alert — Entering Cond Water Press	Automatic when the situation returns to normal	Alert relay is ON.	Check entering condenser water pressure sensor voltage drop. Check for proper wiring to IOB. Check IOB channel type configurations.

Table 18 — PIC 5 Alert Codes (cont)

ALERT CODE (ALARMST)	ALERT TEXT DESCRIPTION	RESET TYPE	ACTION TAKEN BY CONTROL	POSSIBLE CAUSE
SENSOR ALERTS (CONT)				
Alt-132	ALT-132 Sensor Alert — Entering Chilled Water Press	Automatic when the situation returns to normal	Alert relay is ON.	Check entering chilled water pressure sensor voltage drop. Check for proper wiring to IOB. Check IOB channel type configurations.
Alt-133	ALT-133 Sensor Alert — Leaving Cond Water Press	Automatic when the situation returns to normal	Alert relay is ON.	Check leaving condenser water pressure sensor voltage drop. Check for proper wiring to IOB. Check IOB channel type configurations.
Alt-134	ALT-134 Sensor Alert — Leaving Chilled Water Press	Automatic when the situation returns to normal	Alert relay is ON.	Check leaving chilled water pressure sensor voltage drop. Check for proper wiring to IOB. Check IOB channel type configurations.
Alt-135	ALT-135 Sensor Alert — Guide Vane Position	Automatic when the situation returns to normal	Alert relay is ON.	Check guide vane position feedback. Check guide vane actuator wiring.
Alt-136	ALT-136 Configuration Error — Temp Reset	Automatic when the situation returns to normal	Alert relay is ON.	Check temperature reset configurations.
Alt-137	ALT-137 Configuration Error — Controlled Water Delta T Reset	Automatic when the situation returns to normal	Alert relay is ON.	Check controlled water temperature reset configurations.
Alt-138	ALT-138 Configuration Error — Head Pressure	Automatic when the situation returns to normal	Alert relay is ON.	Check head pressure configurations.
PROCESS ALERTS				
Alt-150	ALT-150 Process Alert — Low Discharge Superheat	Automatic when the situation returns to normal	Alert relay is ON.	Check for oil loss from compressor or excess oil charge. Check for excess refrigerant charge. Verify that the valves in the oil reclaim lines are open. Check oil reclaim strainers. Check actual SUPERHEAT in Temperature screen.
Alt-151	ALT-151 Process Alert — High Evaporator Approach	Automatic when the situation returns to normal	Alert relay is ON.	Check EVAP APPROACH ALERT setting. Check Evaporator Water Flow. Check evaporator refrigerant liquid temperature and leaving chilled water temperature sensor resistances and voltage drop. Check evaporator refrigerant liquid temperature and leaving chilled water temperature sensor wiring to the IOB terminal block. Check for oil loss or low refrigerant charge. Check oil reclaim line isolation valves and strainers. Confirm that the optional refrigerant liquid line isolation valve is open. Check for float valve operation and for refrigerant stacking in the condenser. Check chilled water valves and strainers. Check for air in the evaporator water box or division plate bypass. Check for fouled tubes. Confirm that the oil reclaim system is working. Take oil sample and check for mineral oil contamination. Check for 20° F (11° C) temperature difference between leaving chilled water and leaving condenser water.
Alt-152	ALT-152 Process Alert — High Condenser Approach	Automatic when the situation returns to normal	Alert relay is ON.	Check COND APPROACH ALERT setting. Check Condenser Water Flow. Check condenser pressure transducer and leaving condenser water temperature sensor resistance or voltage drop. Check condenser shell temperature against condenser pressure measured with a refrigerant gage for evidence of noncondensables in refrigerant charge. Check for condenser water box division plate bypass. Check condenser pressure transducer and leaving condenser water sensor wiring to the CCM. Check for air in the condenser water box. Confirm that the condenser tubes are not fouled.
Alt-153	ALT-153 Process Alert — High Noise Region	Automatic when the situation returns to normal	Alert relay is ON.	Check the envelop control configurations and running conditions. Check EC/HGBP valve action.
Alt-154	ALT-154 Process Alert — Damper Valve Alert	Automatic when the situation returns to normal	Alert relay is ON.	Check damper valve wiring and position feedback inputs
Alt-155	ALT-155 Process Alert — Low Oil Pressure Difference	Automatic when the situation returns to normal	Alert relay is ON.	Check oil pump wiring and oil filter Quick test oil pump as necessary
Alt-156	ALT-156 Process Alert — EC Valve Alert	Automatic when the situation returns to normal	Alert relay is ON.	Check EC/HGBP valve wiring and feedback inputs

Table 18 — PIC 5 Alert Codes (cont)

ALERT CODE (ALARMRST)	ALERT TEXT DESCRIPTION	RESET TYPE	ACTION TAKEN BY CONTROL	POSSIBLE CAUSE
PROCESS ALERTS (CONT)				
Alt-157	ALT-157 Process Alert — High Condenser Pressure Chiller Off	Automatic when the situation returns to normal	Alert relay is ON.	Check condenser pressure sensor input, and check condenser pressure override configurations
Alt-158	ALT-158 Process Alert — Prognostic Alert	Automatic	Alert relay is ON.	Check prognostic status and configuration screen for detailed information.
Alt-159	ALT-159 Process Alert — LEN Scan Warning	Manual	Alert relay is ON.	Check LEN bus traffic with bus monitor
Alt-160	ALT-160 Process Alert — Oil Filter Replacement	Manual	Alert relay is ON.	Check oil filter
Alt-161	ALT-161 Process Alert — Transducer Calibration	Manual	Alert relay is ON.	Do the indicated transducer calibration
Alt-162	ALT-162 Process Alert — Low Refrigerant Charge	Manual	Alert relay is ON.	Confirm that the unit has low refrigerant charge before adding refrigerant into chiller.
Alt-164	ALT-164 Process Alert — Displacement Switch	Manual	Alert relay is ON.	Check impeller displacement switch.
Alt-165	ALT-165 Process Alert — High Oil Supply Temperature	Automatic when the situation returns to normal	Alert relay is ON.	Check oil supply temperature and OIL EXV status (not only applicable if Oil EXV control enabled)
Alt-166	ALT-166 Process Alert — Condenser Flushing	Automatic	Alert relay is ON.	Flush condenser.
Alt-167	ALT-167 Process Alert — Customer Alert	Automatic	Alert relay is ON.	Check Customer Alert input contact.
Alt-169	ALT-169 Process Alert — High Evaporator Pressure	Automatic	Alert relay is ON.	Check evaporator pressure sensor input. Check evaporator pressure override configurations.
MASTER SLAVE ALERTS				
Alt-170	ALT-170 Master Slave Alert — Master Slave Same Address	Manual	Master slave work independent	Check master slave address configurations
Alt-171	ALT-171 Master Slave Alert — Conflict SW Version	Manual	Master slave work independent	Check master slave software version number
Alt-172	ALT-172 Master Slave Alert — Conflict Cooling Heating Mode	Manual	Master slave work independent	Check master slave cooling heating selection
Alt-173	ALT-173 Master Slave Alert — Incorrect Slave Control Type	Manual	Master slave work independent	Check slave control type
Alt-174	ALT-174 Master Slave Alert — Slave Tripout	Manual, automatic in Master side	Master slave work independent	Check slave chiller alarms
Alt-175	ALT-175 Master Slave Alert — Incorrect Master Control Type	Manual	Master slave work independent	Check master control type
Alt-176	ALT-176 Master Slave Alert — No Communication Master Slave	Automatic	Master slave work independent	Check communication between master and slave, wiring, etc.
Alt-179	ALT-179 Master Slave Alert — Master CCN Write Rejection	Manual	Master slave work independent	Check CCN communication, hardware, and software
Alt-180	ALT-180 Master Slave Alert — Address Not Slave	Manual	Master slave work independent	Check master slave configurations

Event States — An event state is a specific set of conditions that the controller may encounter when controlling the chiller. Event states are repeatable, predictable, and represent known states of the control. When the control is in a particular state, a unique message is associated with that state. The event state messages are displayed on the default screen of the control panel and are listed in Table 19.

Table 19 — Event States

EVENT NO.	DESCRIPTION
1	Chiller Off
2	Chiller Tripout
3	Pumpdown Lockout
4	Terminate Pumpdown Lockout
5	Guide Vane 1 Calibration
6	Quick Test in Progress
7	Ice Build Done
8	Ice Build In Progress
9	Free Cooling In Progress
10	Auto Restart Pending
11	Condenser Flush In Progress
13	Envelop Control Valve Calibration
20	Startup Inhibited — Loadshed in Effect
21	Prestart Check in Progress
22	Timeout — Delay to Start in XX Min
23	Recycle in Progress
24	Startup in Progress
25	Swift Restart In Progress
30	Ramp Loading — Temperature
31	Ramp Loading — Motor Load
32	Ramp Loading — Capacity Inhibit
39	Demand Limit — Capacity Inhibit
40	Demand Limit — Capacity Decrease
41	Demand Limit — Inhibit Clamp
45	Override — High Condenser Pressure
47	Override — High Motor Temperature
48	Override — Low Evap Refrig Temp
50	Override — High Bearing Temp
51	Override — Low Discharge Superheat
52	Override — Manual VFD Speed Target
53	Override — High Motor Current
54	Override — High Discharge Temp
55	Override — Low Source Temp
60	Running — Temp Reset by 4-20 mA Signal
61	Running — Temp Reset by Remote Temp Sensor
62	Running — Temp Reset by Water DT
63	Running — Cooling Leaving Chilled Water
64	Running — Cooling Entering Chilled Water
65	Running — Heating Leaving Cond Water
66	Running — Heating Entering Cond Water
67	Envelop Control — Surge Correction
68	Envelop Control — Acts Before Recycle Shutdown
69	Envelop Control — Low Load Application
70	Envelop Control — Forced
71	Running — VFD Rampdown
72	Running — Guide Vane Position Forced
73	Running — VFD Speed Forced
74	Surge Prevention — Low
75	Surge Prevention — High
76	Surge Protection
77	Running - VFD Overcurrent
79	Running - Damper Valve Forced
80	Operation - Oil EXV Forced
81	Running - Head Pressure Valve Forced
85	Running - Vapor Source Valve Forced
90	Shutdown — Normal
91	Shutdown — Alarm
93	Shutdown — Recycle
94	Shutdown — Recycle Ice Build
95	Shutdown — Compressor Deenergized
96	Shutdown - Emergency Stop
97	Transducer Calibration in Effect
98	ISM Calibration in Effect

TOUCH SCREEN SETTINGS FOR THE CONTROLLER

The Setup screen is accessible only from the controller touch screen, and is not password-protected by default. To access the Setup display, press anywhere on the screen (except on buttons or text fields) for 4 seconds. The Setup screen is displayed. See Fig. 57.

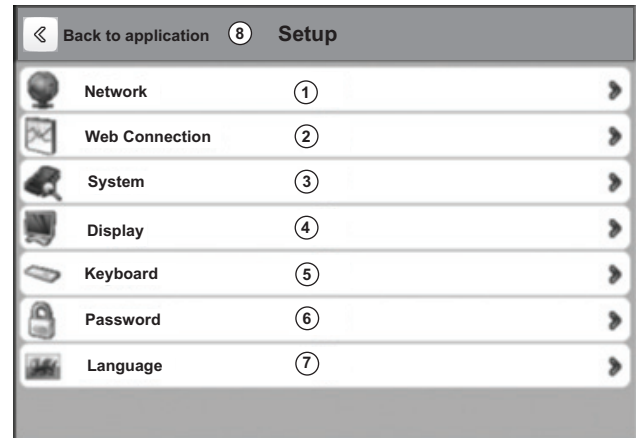

LEGEND

- 1 — Network: System properties for Ethernet interface
- 2 — Web Connection: Configuration for web-based welcome page
- 3 — System: Software version, buzzer
- 4 — Display: Settings such as contrast, backlighting
- 5 — Keyboard: Not applicable
- 6 — Password: For "Setup" access
- 7 — Language: For "Setup" only
- 8 — Return to application

Fig. 57 — Setup Screen

Unit IP Address — On the Setup screen, press Network to display the network parameters. See Fig. 58.

If "Enable DHCP" is checked the PIC 5 will attempt to automatically populate IP settings from Dynamic Host Configuration Protocol (DHCP) server.

NOTE: You must request an IP address, the subnet mask, and the default gateway from the system administrator before connecting the unit to the local Ethernet network.

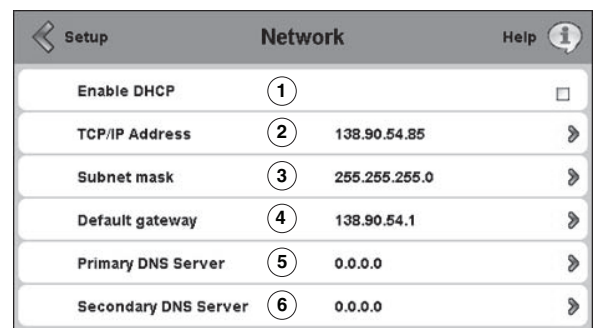

LEGEND

- 1 — Enable DHCP
- 2 — IP address
- 3 — Subnet mask
- 4 — Default gateway
- 5 — Primary DNS Server
- 6 — Secondary DNS Server

Fig. 58 — Network Screen

To change IP address manually, press TCP/IP Address to display the TCP/IP Address screen. See Fig. 59.

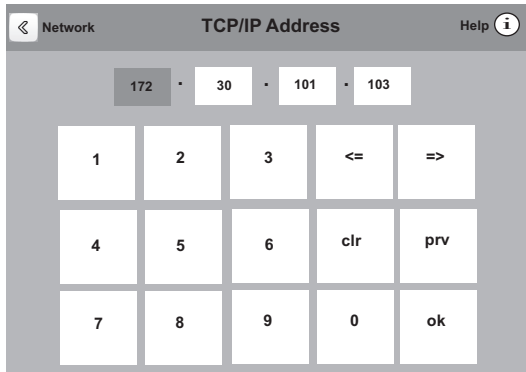

Fig. 59 — TCP/IP Address Screen

Enter the new address and validate it by pressing OK. Return to the Network screen and enter the subnet mask and default gateway using the same method. Then return to the application and save the changes. See Fig. 60.

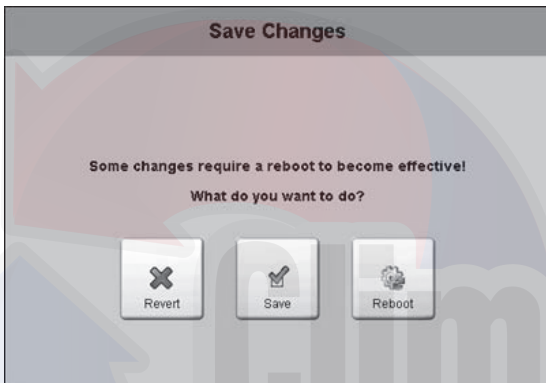

Fig. 60 — Save Changes

Web Address — This configuration is normally done at the factory and is not typically modified in the field. To check the parameters, press Web Connection. The Startup Connection screen is displayed. See Fig. 61.

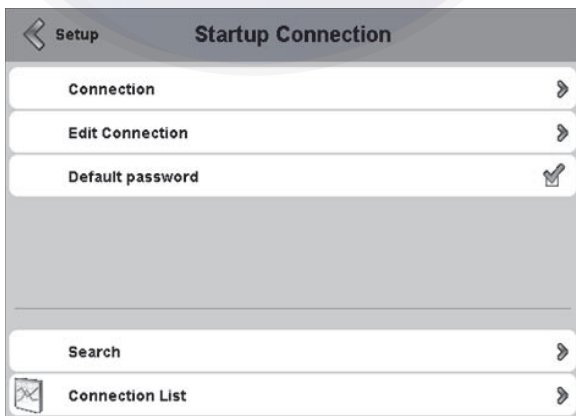
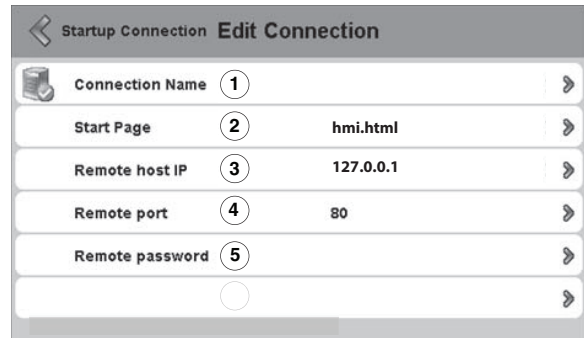

Fig. 61 — Startup Connection

If needed, press “Edit Connection.” See Fig. 62. Default parameters are shown; to modify, press a specific parameter.



LEGEND

- 1 — Connection Name: startup
- 2 — Start Page Name: hmi.html
- 3 — Remote host IP: Not applicable for the application. Do not modify.
- 4 — Remote port: Not applicable for the application. Do not modify.
- 5 — Remote password: Not applicable for the application. Do not modify.

Fig. 62 — Edit Connection

System Configuration — On the main Setup screen (see Touch Screen Settings for the Controller on page 49), press System. The System screen is displayed. See Fig. 63.

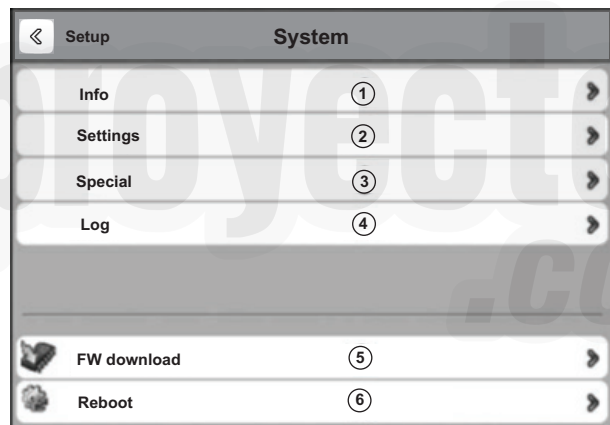

LEGEND

- 1 — Software version
- 2 — Settings: Systems Settings
- 3 — Special: Reset to 0, flash formatting, clock parameters. Do not modify.
- 4 — Log: Unit start-up history
- 5 — Firmware update (not applicable)
- 6 — Unit reboot

Fig. 63 — System Screen

Press Info on the System screen to display detailed information about the HMI panel. See Fig. 64.

System		Info
Firmware version	carrier3.11	①
Booter version	Carrier9	②
CPLD version	c	③
Production data		④ >
Extension		⑤ >
Permanent video cache used	4681728	
Flushable video cache used	87296	

LEGEND

- 1 — Firmware version that is loaded in panel
- 2 — Boot loader version that is loaded in panel
- 3 — Complex Programmable Logic Device (CPLD) version
- 4 — Detailed production data of panel
- 5 — Details of extended hardware

Fig. 64 — System Information

On the System screen, press Settings to display the System Settings screen. See Fig. 65.

System		System settings
Order of file search	Local before remote	① >
Delay during startup [s]	4	② >
Intro screen		③ >
File cache enabled		<input checked="" type="checkbox"/>
Enter setup with delay		<input checked="" type="checkbox"/>

LEGEND

- 1 — Order of file search: Local before remote. Do not modify.
- 2 — Delay during startup(s): Do not modify.
- 3 — Intro screen: Information on the system start-up screen.

Fig. 65 — System Settings

On the System Settings screen, press Intro screen to customize the Welcome screen (see the Welcome Screen section on page 13). See Fig. 66.

System		Intro screen	Help
Welcome text	Welcome	① >	
X-Position of the text	400	>	
Y-Position of the text	300	>	
Filename of the graphic	icoCarrier.gif	② >	
X-Position of the graphic	160	>	
Y-Position of the graphic	110	>	

LEGEND

- 1 — Welcome message text; default: Welcome
- 2 — Filename of graphic; default: ico.Carrier.gif (Carrier logo)

Fig. 66 — Intro Screen Settings

General Display Settings — To set contrast, screen-saver, screen image rotation, and touch screen calibration, press Display on the Setup screen (see the section Touch Screen Settings for the Controller on page 49). The Display screen opens. See Fig. 67.

Setup		Display	Help
Dimming	10	① >	
Backlight timeout [min]	15	② >	
Rotation	0°	③ >	
Resolution	Auto	④ >	
Automatic centering		<input checked="" type="checkbox"/>	
Touch screen calibration >			

LEGEND

- 1 — Dimming: Contrast control
- 2 — Backlight timeout (min): Inactivity time until screen-saver is displayed (screen goes black)
- 3 — Rotation of screen image
- 4 — Resolution
- 5 — Touch screen calibration

Fig. 67 — Display Settings

TOUCH SCREEN CALIBRATION — Depending on the user and the position of the panel, it may be necessary to calibrate the touch screen if the cursor does not move precisely with the user's touch. When the user presses Touch Screen Calibration, a white box with crosshairs appears on the display screen. Touch the center of the crosshair sight with a touch pen or similar blunt-ended stylus (do not use a metal object). When the crosshair sight is touched, it moves to a new position; touch the center of the crosshairs again. When all positions have been configured, the crosshairs disappear. Click on the now blank box on the display and check the precision of the setup (the cursor should move with the user's touch). This completes the calibration and the white box disappears.

Touch Screen Configuration Language — To set the language for touch screen configuration screens, press Language on the Setup screen (see the section Touch Screen Settings for the Controller on page 49). The Language screen offers the options shown in Fig. 68.

NOTE: The language selection on this screen controls only the display language for interface settings, not the language for the unit application. See User Login Screen on page 14 for instructions on setting the unit application language.

Setup		Language
	English	<input checked="" type="checkbox"/>
	German	<input type="checkbox"/>
	French	<input type="checkbox"/>
	Italian	<input type="checkbox"/>
	Dutch	<input type="checkbox"/>

Fig. 68 — Touch Screen Configuration Language

COMMUNICATION PROBLEMS

Hardware Problems — See Table 20 for potential communication issues caused by hardware problems.

Web Interface Problems — See Table 21 for potential communication issues caused by web interface issues.

The intranet site of the unit is the IP address (see Unit IP Address on page 49).

NOTE: The unit cannot automatically obtain the network parameters via a DHCP server.

Table 20 — Hardware Problems

SYMPTOMS	POSSIBLE CAUSES	CHECKS	SOLUTIONS
The unit does not respond to the instructions sent by the supervision PC on the CCN bus.	Problem at the RS485 converter level of the PC or connection problem on the primary CCN bus.	Check the CCN cable connections. The unit CCN address is 0.1 and the communication speed is 9600 baud by default.	Replace the RS485 connector.
Communication problem when connecting two buses (primary bus and secondary bus).	Electrical problem between 0 v CCN of the primary bus and 0 v CCN of the secondary bus.	Check the connection of the metal part of the interface casing to earth.	Connect the metal part of the interface casing to earth.

Table 21 — Web Interface Problems

SYMPTOMS	POSSIBLE CAUSES	CHECKS	SOLUTIONS
Start-up page loads, then goes to fault state.	Network property details are not valid.	Check the network parameters (see the section Ethernet/IP Connection Problems on page 53).	Contact your system administrator.
	Ethernet network is not available.	Check to see if the orange LED on the unit is flashing.	Check the Ethernet connection to the local network if the orange LED does not flash.
While accessing the unit via the web browser, the Java platform launches, but remains blocked. No file is loaded.	Proxy server problem in the local network.	Contact your system administrator.	In agreement with the system administrator, open the Runtime Java control panel and select Direct Connection in the system parameters and/or request in the web browser (Tools→Options→Connection→System parameters) that no proxy server is used to go to the local addresses. If possible, uncheck "use of an automatic configuration script." Restart the web browser.
The application has been launched, but the screens are not shown in the web browser.	A proxy server is used to access the unit and this supplies the old screens to the browser. Incorrect configuration of the Java application.	Check that the web browser does not go via a proxy server to access the unit. Check that the Java application does not store the internet files on the PC.	Open the browser and in the system connection parameters add the IP address of the unit in the proxy exceptions. (Tools→Options→Connection→System parameters→"No proxy for"). See the section Java Application Configuration on page 54.

NOTES:

1. The unit cannot automatically obtain the network parameters via a DHCP (Dynamic Host Configuration Protocol) server.
2. The intranet site address of the unit is the IP address.

Ethernet/IP Connection Problems — Use the following methods to troubleshoot:

UNIT IS POINT-TO-POINT CONNECTED TO A PC — Ensure controller is powered on prior to configuration and check Ethernet connection and PC Network Interface Card (NIC).

NOTE: In addition to the following procedure, it may be necessary to check the Ethernet connection and/or configure the PC network board.

In Network Settings, open Local Area Connection Properties. Select Internet Protocol and click Properties. See Fig. 69.

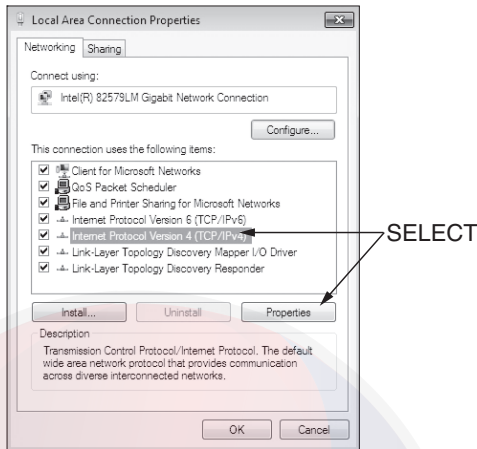

Fig. 69 — Local Area Connection Properties

The Internet Protocol Properties window is displayed.

- If no IP address is configured in the General and Alternative Configuration tabs, the unit IP address must be configured to 169.254.xxx.xxx. Modify the unit IP address and then restart the system.
- If the PC has a fixed IP address configured in one of the two tabs (General and Alternative Configuration), the IP address of the PC and the unit IP address must have the system and sub-system fields in common. The last part of the IP address is the host number and must be unique on the sub-system. For example: Unit address — 172.30.101.11 and PC address — 172.30.101.182. In this example, 172.30 corresponds to the network, and 101 corresponds to the sub-system. Carry out the necessary modifications and try to access the unit again.

In the case of a problem, open a Windows command window (Start, Execute, type **cmd** and press Enter), then type the command **ping**, followed by the unit IP address. In the example shown in Fig. 70, the PC receives four positive responses (replies).

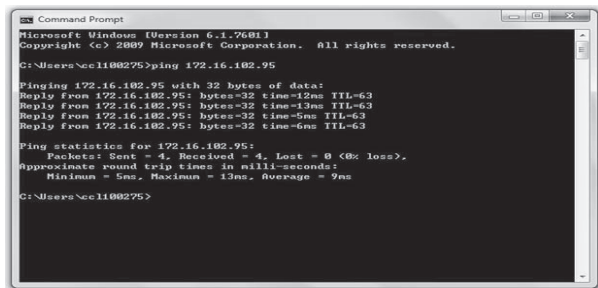

Fig. 70 — Ping — Positive Replies

In the example shown in Fig. 71, the PC receives four negative responses (request timed out).

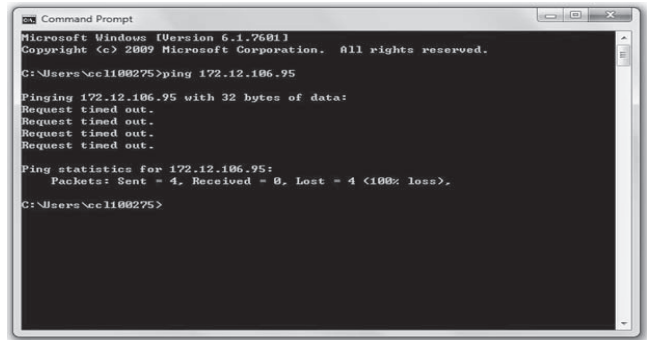

Fig. 71 — Ping — Negative Responses

If the PC receives four negative responses, check the internet browser parameters to determine if a proxy server or an automatic configuration script has been configured. If this is the case:

- Deselect the proxy server or the configuration script and restart the browser,
- Or refer to the section Java Application Configuration (page 54).

Try to access the unit again. If the PC still does not receive a response from the unit, restart the unit. Contact your system administrator.

UNIT IS CONNECTED TO THE LOCAL NETWORK — The unit is connected to the local network by an uncrossed cable, and the unit is energized. Open a Windows command window (Start, Execute, type **cmd** and press Enter), then type the command **ping**, followed by the unit IP address.

If the responses are positive (see Fig. 70), the internet browser configuration is faulty. Check the system parameters of the internet browser to determine if a proxy server or an automatic configuration script has been configured (Tools → Internet Options → Connections → System Parameters). See Fig. 72.

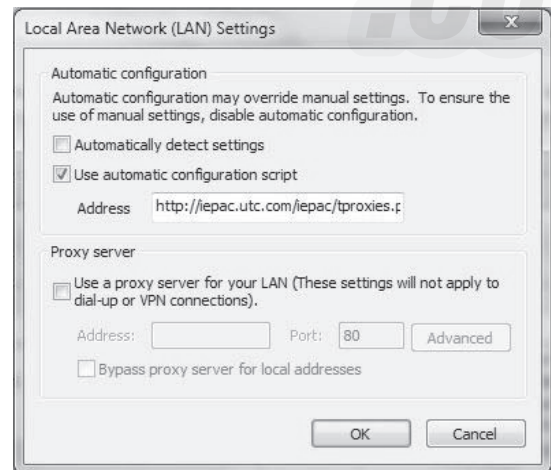

LEGEND

- 1 — Automatic configuration script
- 2 — Proxy server
- 3 — Advanced proxy configuration

Fig. 72 — Local Area Network Settings

If a proxy server is used, add the unit IP address to the exceptions list of the proxy server (advanced proxy configuration). See Fig. 73.

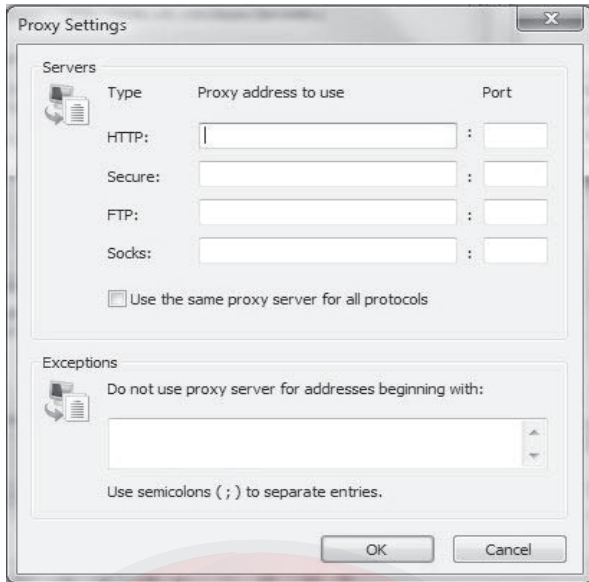

Fig. 73 — Proxy Settings

If a configuration script is used, it is not possible to add the unit IP address to the exceptions list. In this case, see the section Java Application Configuration below.

If the response to the “ping” command is negative, verify the IP address of the PC and the IP address of the unit. They must have the system network and sub-system in common. The last part of the IP address is the host number and must be unique on the sub-system; for example: Unit address — 172.30.101.11 and PC address — 172.30.101.182. In this example, 172.30 corresponds to the system network, and 101 corresponds to the sub-system. The host numbers are 11 and 182 respectively.

ETHERNET CONNECTION ON THE PC — Open the network configuration window of the PC and double-click Network Connections. Find the system interface board and check that no red “X” appears on the icon.

The connection to the local network must be authorized and in the connected status. If this is not the case, check the connections and authorize/repair the network connection.

JAVA APPLICATION CONFIGURATION — Open the Internet configuration window of the PC and double-click the Java application icon. If Java is not installed, a free download is available at <http://www.java.com>.

If Java has already been installed, check if it is used by other applications. If so, check that these are compatible with the following settings in the Java control panel. See Fig. 74.

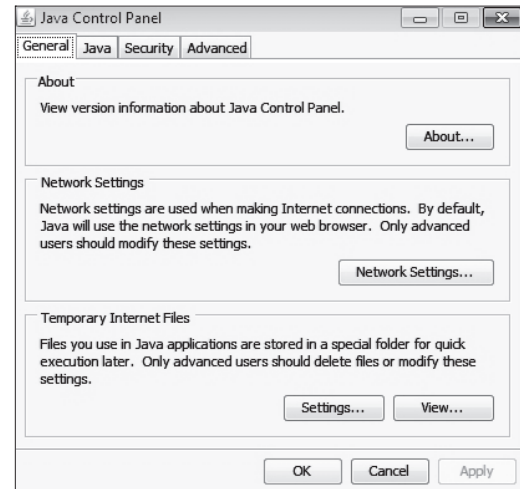

Fig. 74 — Java Control Panel

- **Network settings:** In the Java Control Panel, click Network Settings. Select a direct connection to bypass the proxy server or select the automatic configuration script. See Fig 75.

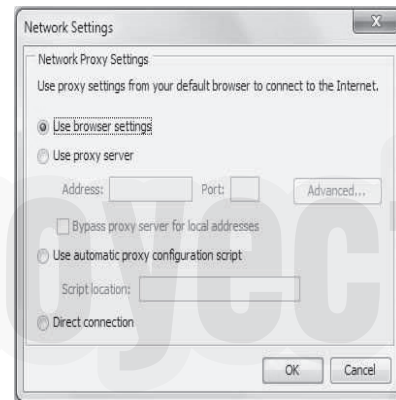

Fig. 75 — Network Settings

- **Temporary internet files:** In the Java Control Panel, click Settings in the Temporary Internet Files section. Be sure the setting Keep temporary files on my computer is unchecked (clear). See Fig. 76.

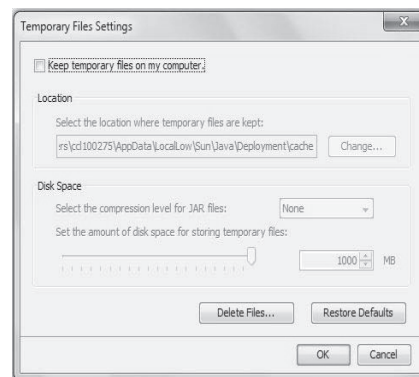

Fig. 76 — Temporary File Settings

APPENDIX A — PIC 5 SCREEN AND TABLE STRUCTURE

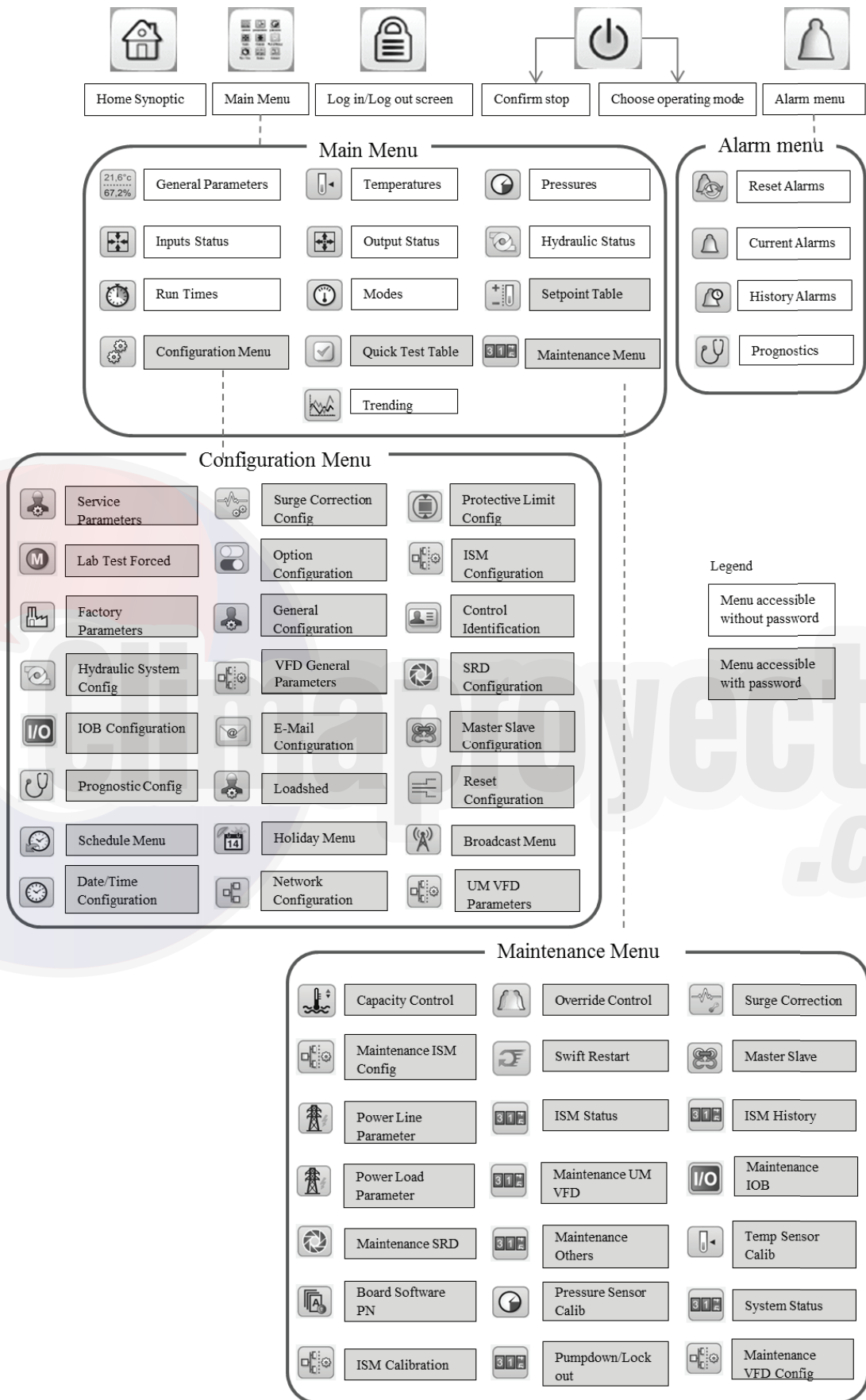











Fig. A — Screen Structure, Basic Level (All) Access (No Password Required)

APPENDIX A — PIC 5 SCREEN AND TABLE STRUCTURE (cont)

Main Menu Description

ICON	DISPLAYED TEXT*	ACCESS	ASSOCIATED TABLE	PAGE NO.
	General Parameters	All	GENUNIT	57
	Temperatures	All	TEMP	58
	Pressures	All	PRESSURE	58
	Inputs Status	All	INPUTS	59
	Outputs Status	All	OUTPUTS	60
	Hydraulic Status	All	HYDRLIC	61
	Run Times	All	RUNTIME	62
	Modes	All	MODES	62
	Setpoint	User	SETPOINT	62
	Configuration Menu	User	CONFIG	63
	Quick Test	Service	QCK_TEST	75
	Maintenance Menu	Service	MAINTAIN	76
	Trending	All	TRENDING	—

* Displayed text depends on the selected language (default is English).

APPENDIX A — PIC 5 SCREEN AND TABLE STRUCTURE (cont)

General Parameters

CCN TABLE NAME: GENUNIT

PIC 5 PATH: Main Menu → General Parameters

LINE	PIC 5 DESCRIPTION	CCN NAME	RANGE	DEFAULT VALUE*	UNIT	READ/WRITE
1	Control Mode 0 = Local, 1 = Network 2 = Remote, 3 = Local Sched	ctl_mode	0 to 3			RO
2	Compressor1 Run Status	cm_stas1	0 to 16†			RO
3	Deter Start Stop Command	stop/start				RO
4	Network: Cmd Start/Stop	CHIL_S_S	NO/YES			RW**
5	Network:Cmd Occupied	CHIL_OCC	NO/YES			RW**
6	Cooling / Heating Select	HC_SEL	COOL/HEAT	COOL		RW
7	Control Point	CTRL_PNT	10.0 to 160.0		°F	RW**
8	Control Point Reset	reset	-30.00 to 30.00		°F	RO
9	Actual Setpoint	setpoint	10.0 to 150.0		°F	RO
10	Percent Load Current	AMPS_P	0.0 to 999.0		%	RO
11	Motor Percent Kilowatts	KW_P	0 to 100		%	RO
12	Actual Demand Limit	DEM_LIM	10.0 to 100.0	100	%	RW**
13	Emergency Stop	EMSTOP	NO/YES	0		RW**
14	Chiller State Number	ch_state	0 to 500			RO
15	Local Schedule Occupied	oc_occ	NO/YES			RO
16	Ice Schedule Occupied	ice_occ	NO/YES			RO
17	MS Start Stop Command	ms_stsp	STOP/START			RO
18	Remote Reset Alarm	REM_RST	NO/YES			RO
19	Stop Override	STP_OVER	NO/YES	NO		RW
20	Start Free Cooling	FC_START	NO/YES	NO		RW
21	Start Condenser Flush	CF_START	NO/YES	NO		RW

LEGEND

RO — Read Only
RW — Read/Write

*Default value is shown only if configurable in this table.

†0 = OFF
1 = CTLTEST
2 = PUMPDOWN
3 = LOCKOUT
4 = RECYCLE
5 = TRIPOUT
6 = TIMEOUT
7 = PRESTART
8 = STARTUP
9 = AUTORST
10 = RAMPING
11 = RUNNING
12 = OVERRIDE
13 = DEMAND
14 = SHUTDOWN
15 = FREECOOL
16 = CONDFLSH
**RW from network.

APPENDIX A — PIC 5 SCREEN AND TABLE STRUCTURE (cont)

Temperatures

CCN TABLE NAME: TEMP

PIC 5 PATH: Main Menu → Temperatures

LINE	PIC 5 DESCRIPTION	CCN NAME	RANGE	DEFAULT VALUE*	UNIT	READ/WRITE
1	Entering Chilled Water	ECW	-40.0 to 245		°F	RO
2	Leaving Chilled Water	LCW	-40.0 to 245		°F	RO
3	Entering Condenser Water	ECDW	-40.0 to 245		°F	RO
4	Leaving Condenser Water	LCDW	-40.0 to 245		°F	RO
5	Evap Sat Refrig Temp	EVAP_SAT	-40.0 to 245		°F	RO
6	Evap Refrig Liquid Temp	EVAP_T	-40.0 to 245		°F	RO
7	Evaporator Approach	evap_app	0.0 to 99.0		°F	RO
8	Condenser Approach	cond_app	0.0 to 99.0		°F	RO
9	Cond Sat Refrig Temp	COND_SAT	-40.0 to 245		°F	RO
10	Comp Discharge Temp	DGT	-40.0 to 245		°F	RO
11	Discharge Superheat	DSH	-20.0 to 99.0		°F	RO
12	Thrust Bearing Oil Temp	MTRB_OIL	-40.0 to 245		°F	RO
13	Thrust Bearing Temp	MTRB	-40.0 to 245		°F	RO
14	Low Speed ME Brg Temp	MTRB1	-40.0 to 245		°F	RO
15	Low Speed CE Brg Temp	MTRB2	-40.0 to 245		°F	RO
16	High Speed ME Brg Temp	MTRB3	-40.0 to 245		°F	RO
17	High Speed CE Brg Temp	MTRB4	-40.0 to 245		°F	RO
18	Comp Motor Winding 1 Temp	MTRW1	-40.0 to 245		°F	RO
19	Comp Motor Winding 2 Temp	MTRW2	-40.0 to 245		°F	RO
20	Comp Motor Winding 3 Temp	MTRW3	-40.0 to 245		°F	RO
21	Oil Sump Temp	OILT_SMP	-40.0 to 245		°F	RO
22	Oil Supply Temp	OILT_DIS	-40.0 to 245		°F	RO
23	Actual Lift	LIFT_A	0.0 to 200.0		°F	RO
24	VDO High Lift Load Line	LIFT_1	0.0 to 200.0		°F	RO
25	VDO Low Lift Load Line	LIFT_2	0.0 to 200.0		°F	RO
26	Remote Reset Sensor	R_RESET	-40.0 to 245		°F	RO
27	Common CHWS Temp	CHWS_T	-40 to 245		°F	RO
28	Common CHWR Temp	CHWR_T	-40 to 245		°F	RO

Pressures (Associated Table: PRESSURE)

CCN TABLE NAME: PRESSURE

PIC 5 PATH: Main Menu → Pressures

LINE	PIC 5 DESCRIPTION	CCN NAME	RANGE	DEFAULT VALUE*	UNIT	READ/WRITE
1	Evaporator Pressure	EVAP_P	-6.7 to 420.0		psig	RO
2	Condenser Pressure	COND_P	-6.7 to 420.0		psig	RO
3	Economizer Pressure	ECON_P	-6.7 to 420.0		psig	RO
4	Oil Supply Pressure	OILP_DIS	-6.7 to 420.0		psig	RO
5	Oil Sump Pressure	OILP_SMP	-6.7 to 420.0		psig	RO
6	Oil Pump Delta P	OIL_PD	-6.7 to 420.0		psig	RO
7	Oil Pump Delta P Offset	pd_off	-5.0 to 5.0		psi	RW
8	Diffuser Pressure	DIFF_P	-6.7 to 420.0		psig	RO
9	Head Pressure Reference	HEAD_P	-6.7 to 420.0		psig	RO

LEGEND

*Default value is shown only if configurable in this table.

RO — Read Only

APPENDIX A — PIC 5 SCREEN AND TABLE STRUCTURE (cont)

Inputs Status

CCN TABLE NAME: INPUTS						
PIC 5 PATH: Main Menu → Inputs Status						
LINE	PIC 5 DESCRIPTION	CCN NAME	RANGE	DEFAULT VALUE*	UNIT	READ/WRITE
1	Compressor Start Contact	STAR_AUX	OPEN/CLOSE			RO
2	Compressor Run Contact	RUN_AUX	OPEN/CLOSE			RO
3	Damper Valve Fully Closed	DMP_FC	NO/YES			RO
4	Damper Valve Fully Opened	DMP_FO	NO/YES			RO
5	Damper Valve Status 0=Closed, 1=Interim, 2=Opened 3=Failure	DMP_ACT	0 to 3			RO
6	EC Valve Fully Closed	HGBP_FC	NO/YES			RO
7	EC Valve Fully Opened	HGBP_FO	NO/YES			RO
8	EC Valve Status 0=Closed, 1=Interim, 2=Opened 3=Failure	HGBP_ACT	0 to 3			RO
9	High Pressure Switch	HP_SW	OPEN/CLOSE			RO
10	Remote Contact	REM_CON	OPEN/CLOSE			RO
11	Emergency Stop Contact	E_STOP	OPEN/CLOSE			RO
12	Ice Build Contact	ICE_CON	OPEN/CLOSE			RO
13	Chiller Lockout	REM_LOCK	OPEN/CLOSE			RO
14	Spare Safety Input	SAFETY	OPEN/CLOSE			RO
15	Starter Fault Feedback	STARTFLT	OPEN/CLOSE			RO
16	Fire Security Interlock	FS_LOCK	OPEN/CLOSE			RO
17	Guide Vane 1 Actual Ohms	GV1_OHMS			ohms	RO
18	Guide Vane 1 Actual Pos	GV1_ACT			%	RO
19	Actual VFD Speed Per	VFD_ACT			%	RO
20	Diffuser Actual Pos	DIFF_ACT			%	RO
21	Auto Demand Limit Input	AUTO_DEM			mA	RO
22	Auto Water Temp Reset	AUTO_RES			mA	RO
23	Refrig Leak Sensor	REF_LEAK			mA	RO
24	VFD Speed Feedback	VFD_IN			V	RO
25	Guide Vane 1 Pos Feedback	GV1_MA			mA	RO
26	VFD Current Input	VFDC_MA			mA	RO
27	Actual ECV Pos Per	HGBPACTP			%	RO
28	ECV Current Feedback	HGBP_MA			mA	RO
29	ISM Trip Relay Status	TRIPR	OPEN/CLOSE			RO
30	BACnet Dongle	bacdongl	NO/YES			RO
31	Displacement Switch	SHAFTDIS	OPEN/CLOSE			RO
32	Power Request Feedback	POW_FDB	NO/YES			RO
33	Free Cool Start Switch	FC_SS	Off/On			RO
34	Customer Alert	CUS_ALE	Open/close			RO

LEGEND

RO — Read Only

*Default value is shown only if configurable in this table.

APPENDIX A — PIC 5 SCREEN AND TABLE STRUCTURE (cont)

Outputs Status

CCN TABLE NAME: OUTPUTS

PIC 5 PATH: Main Menu → Outputs Status

LINE	PIC 5 DESCRIPTION	CCN NAME	RANGE	DEFAULT VALUE*	UNIT	READ/WRITE
1	Diffuser Output	DIFF_OUT	4.0 to 20.0		mA	RO
2	Head Pres Output	HDPV_OUT	4.0 to 20.0		mA	RO
3	Chiller Status Output	CHST_OUT	4.0 to 20.0		mA	RO
4	VFD Speed Output	VFD_OUT	4.0 to 20.0		mA	RO
5	Oil EXV Output	EXV_OUT	4.0 to 20.0		mA	RO
6	Oil EXV Target	exv_tgt	0.0 to 100.0		%	RO
7	Oil Pump VFD Output mA	OP_VFD	4.0 to 20.0		mA	RO
8	Oil Pump VFD Target	op_vfd_t			%	RO
9	Head Pres Valve Tgt Pos	hdpv_tgt	0.0 to 100.0		%	RO
10	Guide Vane 1 Output	GV1_OUT	0.0 to 20.8		mA	RO
11	EC Valve Output mA	HGBP_OUT	4.0 to 20.0		mA	RO
12	Alarm Relay	ALM	OFF/ON		OFF/ON	RO
13	Alert Relay	ALE	OFF/ON		OFF/ON	RO
14	Compressor Start Relay	COMP_SR	OFF/ON		OFF/ON	RO
15	Starter Trans Sw Status	TRANS	OFF/ON		OFF/ON	RO
16	Damper Valve Close	DMP_CL	OFF/ON		OFF/ON	RO
17	Damper Valve Open	DMP_OP	OFF/ON		OFF/ON	RO
18	Guide Vane 1 Decrease	GV1_DEC	OFF/ON		OFF/ON	RO
19	Guide Vane 1 Increase	GV1_INC	OFF/ON		OFF/ON	RO
20	EC Valve Close	HGBP_OFF	OFF/ON		OFF/ON	RO
21	EC Valve Open	HGBP_ON	OFF/ON		OFF/ON	RO
22	Oil Heater Relay	OIL_HEAT	OFF/ON		OFF/ON	RO
23	Oil Pump Relay	OIL_PUMP	OFF/ON		OFF/ON	RO
24	Tower Fan Relay High	TFR_HIGH	OFF/ON		OFF/ON	RO
25	Tower Fan Relay Low	TFR_LOW	OFF/ON		OFF/ON	RO
26	Damper Valve Tgt Pos 0=Close,1=Hold, 2=Open	dmp_tgt	0 to 2			RO
27	EC Valve Tgt Pos 0=Close,1=Hold, 2=Open	hgbp_tgt	0 to 2			RO
28	Power Request	POW_REQ	OFF/ON			RO
29	Free Cooling Mode	FC_MODE	NO/YES			RO
30	VFD Coolant Solenoid	VFD_SOL	OFF/ON			RO
31	Vapor Source SV	VS_SV	Off/On			RO

APPENDIX A — PIC 5 SCREEN AND TABLE STRUCTURE (cont)

Hydraulic Status

CCN TABLE NAME: HYDRLIC						
PIC 5 PATH: Main Menu → Hydraulic Status						
LINE	PIC 5 DESCRIPTION	CCN NAME	RANGE	DEFAULT VALUE*	UNIT	READ/WRITE
1	Chilled Water Pump	CHWP	OFF/ON			RO
2	Condenser Water Flow	CDW_FLOW	NO/YES			RO
3	Cond Water Flow Value	CDW_FV	0-10,000	0.0	GPM	RO
4	Entering Cond Water Pres	COND_EWP	-6.7 to 420.0		psig	RO
5	Leaving Cond Water Pres	COND_LWP	-6.7 to 420.0		psig	RO
6	Condenser Water Delta P	cdw_off	-10.0-10.0	0.0	psi	RW
7	Condenser Delta P Offset	cdw_off	-10.0-10.0	0.0	psig	RW
8	Cond Water Pulldown/Min	cdw_pull	-20 to 20.0		°F	RO
9	Condenser Water Pump	CDWP	OFF/ON			RO
10	Chilled Water Pump					
11	Chilled Water Flow	CHW_FLOW	NO/YES			RO
12	Chilled Water Flow Value	CHW_FV	-10.0 to 10.0	0.0	psi	RW
13	Entering Chilled Water P	EVAP_EWP	-6.7 to 420.0		psig	RO
14	Leaving Chilled Water P	EVAP_LWP	-6.7 to 420.0		psig	RO
15	Chilled Water Delta P	chw_pd	-6.7 to 420.0		psig	RO
16	Chilled Delta P Offset	chw_off	-10 to 10.00	0.0	psig	RW
17	Chilled Water Pulldown/Min	chw_pull	-20 to 20.0		°F	RO
18	Chilled Water Flow Input	CHWF_IN	4 to 20		mA	RO
19	Cond Water Flow Input	CDWF_IN	4 to 20		mA	RO
20	Chilled Water Pres Drop	CHW_PDMA	4 to 20		mA	RO
21	Cond Water Pres Drop	CDW_PDMA	4 to 20		mA	RO
22	Evap Water Flow Switch	EVAP_FS	OPEN/CLOSE			
23	Cond Water Flow Switch	COND_FS	OPEN/CLOSE			
24	Tower Fan Relay High	TFR_HI	OFF/ON			RO
25	Tower Fan Relay Low	TFR_LO	OFF/ON			RO
26	Controlled Water DT	ctrlw_dt	-40.0 to 245.0		°F	RO
27	Cond Water Flow Status 0=Fail or Not Started 1=Success, 2=Verifying	cdw_fl_s	0 to 2			RO
28	Chilled Water Flow Status 0=Fail or Not Started 1=Success, 2=Verifying	chw_fl_s	0 to 2			RO
29	Pumpdown/Lockout State	pdown_st	0 to 255			RO

LEGEND

RO — Read Only
RW — Read/Write

*Default value is shown only if configurable in this table.

APPENDIX A — PIC 5 SCREEN AND TABLE STRUCTURE (cont)

Run Times

CCN TABLE NAME: RUNTIME

PIC 5 PATH: Main Menu → Run Times

LINE	PIC 5 DESCRIPTION	CCN NAME	RANGE	DEFAULT VALUE*	UNIT	READ/WRITE
1	Starts in 12 Hours	ST_CNT12	0 to 8			RO
2	Compressor Starts Num	C_STARTS	0 to 99999			RO
3	Compressor Running Hrs	COMP_HRS	0 to 500000.0		hr	RO
4	After Service Hrs	SRV_HRS	0 to 500000.0	0.0	hr	RW
5	Stop to Start Timer	spst_tim	1.0 to 15.0		min	RO
6	Start to Start Timer	stst_tim	4.0 to 45.0		min	RO
7	Oil Lubrication Duration	oilb_dur	1000 to 8000		hr	RO
8	Oil Storage Duration	oils_dur	5000 to 15000		hr	RO
9	Recy Startup in 4 Hours	RCYSTCNT	0 to 6			RO
10	Swift Restarts in 1 Hour	SWIFTCNT	0 to 4			RO

LEGEND

RO — Read Only
RW — Read/Write

NOTE: The displayed runtime is updated every hour. To avoid the loss of data in case of disruption, the values are backed up.

*Default value is shown only if configurable in this table.

Modes

CCN TABLE NAME: MODES

PIC 5 PATH: Main Menu → Modes

LINE	PIC 5 DESCRIPTION	CCN NAME	RANGE	DEFAULT VALUE*	UNIT	READ/WRITE
1	Normal Shutdown	shut_nor	NO/YES			RO
2	Recycle Shutdown	shut_rcy	NO/YES			RO
3	Alarm Shutdown	shut_alm	NO/YES			RO
4	Recycle Startup	str_rcy	NO/YES			RO
5	Temperature Ramping	tmp_ramp	NO/YES			RO
6	Load Ramping	ld_ramp	NO/YES			RO
7	IGV1 Inhibiting	gv1_inh	NO/YES			RO
8	Ice Building	ice_act	NO/YES			RO
9	Ice Build Terminated	ice_term	NO/YES			RO
10	Ice Build Recy Startup	ice_rcy	NO/YES			RO
11	Ramp Loading	ramp_act	NO/YES			RO
12	Demand Limit	dem_act	NO/YES			RO
13	VFD Rampdown	vfdrpact	NO/YES			RO
14	Demand Limit Inhibit	dem_inh	NO/YES			RO
15	Evaporator Frozen	evaprfrze	NO/YES			RO
16	Condenser Frozen	condfrze	NO/YES			RO
17	Recycle Shutdown Done	rcysh_cm	NO/YES			RO
18	NonRecycle Shutdown Done	nrysh_cm	NO/YES			RO
19	In Alarm	alm_act	NO/YES			RO
20	In Override	over_act	NO/YES			RO
21	Comp1 Run State Val	cm_stat1	0 to 13			RO

LEGEND

RO — Read Only

*Default value is shown only if configurable in this table.

Setpoint

CCN TABLE NAME: SETPOINT

PIC 5 PATH: Main Menu → Setpoint

LINE	PIC 5 DESCRIPTION	CCN NAME	RANGE	DEFAULT VALUE*	UNIT	READ/WRITE
1	Cooling ECW Setpoint	ecw_sp	15.0 to 120.0	60.0	°F	RW
2	Cooling LCW Setpoint	lcw_sp	10.0 to 120.0	45.0	°F	RW
3	Heating ECDW Setpoint	ecdw_sp	63.0 to 150.0	104.0	°F	RW
4	Heating LCDW Setpoint	lcdw_sp	68.0 to 150.0	113.0	°F	RW
5	Ice Build Setpoint	ice_sp	15.0 to 60.0	40.0	°F	RW
6	Base Limit Demand	dem_base	10.0 to 100.0	100.0	%	RW
7	EWT Control Option	EWT_OPT	DSABLE/ENABLE	DSABLE		RW

LEGEND

RW — Read/Write

*Default value is shown only if configurable in this table.

APPENDIX A — PIC 5 SCREEN AND TABLE STRUCTURE (cont)

Configuration Menu

Navigation: MAIN MENU → CONFIGURATION MENU

ICON	DISPLAYED TEXT	ACCESS	ASSOCIATED TABLE	PAGE NO.
	Service Parameters	Service	SERVICE1	64
	Surge Correction Config	Service	CFGSURGE	64
	Protective Limit Config	Service	CFGLIMIT	65
	Lab Test Forced	Service	LABONLY	Factory only
	Option Configuration	Service	CONF_OPT	66
	ISM Configuration	Service	CONF_ISM	67
	Factory Parameters	Factory	FACTORY	68
	General Configuration	User	GEN_CONF	68
	Control Identification	User	CTRL_ID	Info. only
	Hydraulic System Config	Service	HYDRCONF	Not used
	VFD Parameters	Service	CONF_VFD	68
	SRD Configuration	Service	CONF_SRD	69
	IOB Configuration	Service	CONF_IOB	70
	E-Mail Configuration	Service	EMAILCFG	70
	Master Slave Config	Service	CONF_MS	71
	Prognostics Config	Service	CONF_PRG	71
	Loadshed	Service	LOADSHED	Not used
	Reset Configuration	User	RESETCFG	71
	Schedule Menu	User	SCHEDULE	72
	Holiday Menu	User	HOLIDAY	73
	Broadcast Menu	User	BROADCAST	73
	Date/Time Configuration	User	DATETIME	74
	Network Configuration	Service	CONNECT	74

APPENDIX A — PIC 5 SCREEN AND TABLE STRUCTURE (cont)

Service Parameters

CCN TABLE NAME: SERVICE1

PIC 5 PATH: Main Menu → Configuration Menu → Service Parameters

LINE	PIC 5 DESCRIPTION	CCN NAME	RANGE	DEFAULT VALUE*	UNIT	READ/WRITE
1	Service Password	ser_pass	0 to 65535	2222		RW
2	Atmospheric Pressure	atom_pre	8 to 15	14.5	psi	RW
3	GV1 Travel Limit	gv1_lim	30 to 100	80	%	RW
4	GV1 Closure at Startup	gv1stpos	0 to 40	4	%	RW
5	Controlled Fluid DB	ctrl_db	0.5 to 2.0	1.0	°F	RW
6	Derivative EWT Gain	ewtdgain	1.0 to 3.0	2.0		RW
7	Proportional Dec Band	gv1decdb	2.0 to 10.0	6.0		RW
8	Proportional Inc Band	gv1incdb	2.0 to 10.0	6.5		RW
9	Maximum GV Movement	max_gv	2.0 to 4.0	2.0	%	RW
10	Demand Limit At 20 mA	dem_20ma	10 to 100	40	%	RW
11	Demand Limit Prop Band	dem_pdb	3.0 to 15.0	10.0	%	RW
12	Amps or KW Ramp per Min	ldramprt	5 to 20	10	%	RW
13	Temp Ramp Rate per Min	tmramprt	1 to 10	3	°F	RW
14	Recycle Shutdown Delta T	rcysh_dt	0.5 to 4.0	1.0	°F	RW
15	Recycle Restart Delta T	rcyst_dt	2.0 to 10.0	5.0	°F	RW
16	Damper Valve Act Delay	dmp_dly	0 to 20	5	min	RW
17	Damper Valve Close DB	dmp_cldb	2.0 to 10.0	5.0	psig	RW
18	Damper Valve Open DB	dmp_opdb	10.0 to 20.0	13.0	psig	RW
19	Damper Action Delta T	dmp_dt	4.0 to 10.0	7.0	°F	RW
20	Oil Press Verify Time	oilpvr_t	15 to 300	40	sec	RW
21	Soft Stop Amps Threshold	sf_st_th	40 to 100	70	%	RW
22	Water Flow Verify Time	wflow_t	0.5 to 5.0	5.0	min	RW
23	Power Calibration Factor	mbb_pfcl	0.900 to 1.000	0.970		RW
24	Enable Excessive Starts	ex_start	YES/NO	NO		RW
25	Oil Stir Cycle (19XR6/7) 0 = No stir, 1 = 30s/30m, 2 = 1m/4hr, 3 = Comb 0&1	oilstiro	0 to 3	1		RW

Surge Correction Config

CCN TABLE NAME: CFGSURGE

PIC 5 PATH: Main Menu → Configuration Menu → Surge Correction Config

LINE	PIC 5 DESCRIPTION	CCN NAME	RANGE	DEFAULT VALUE*	UNIT	READ/WRITE
1	Surge Line Configuration 0=PR, 1=Delta T	sgl_cfg	0 to 1	0		RW
2	IGV1 Pos Configuration 0-Degree, 1=Percentage	gv1c_sel	0 to 1	0		RW
3	Surge Delta Tsmax	dts_max	0.0 to 150.0	70.0	° F	RW
4	Surge Delta Tsmmin	dts_min	0.0 to 150.0	45.0	° F	RW
5	PR at Full Load Opening	pr_ful	1.0000 to 5.0000	3.0000		RW
6	PR at Min. Opening	pr_min	1.0000 to 5.0000	1.5000		RW
7	IGV1 Full Load Open Deg	gv1_dful	90 to 120.0	88.0	degree	RW
8	Sound Ctrl IGV1 Open Deg	gv1_dmed	10.0 to 40.0	27.0	degree	RW
9	IGV1 Minimum Open Deg	gv1_dmin	0.0 to 10.0	2.0	degree	RW
10	IGV1 Maximum Open Deg	gv1_dmax	90.0 to 120.0	109.0	degree	RW
11	IGV1 Minimum Position	gv1_pmin	0 to 100	5	%	RW
12	IGV1 Full Load Position	gv1_pful	0 to 100	100	%	RW
13	Envelop Line Offset	sgl_off	1.0 to 3.0	2.0	° F	RW
14	Envelop Lower Deadband	sql_hoff	0.5 to 3.0	1.5	° F	RW
15	Envelop Upper Deadband	sql_hoff	0.1 to 3.0	1.5	° F	RW
16	Surge Line Shape Factor	sgl_shfh	-1.000 to 0.000	-0.010		RW
17	Sound Line Shape Factor	sgl_shfl	0.000 to 1.000	0.010		RW
18	Envelop Speed Factor	sgl_spdf	0.00 to 3.00	2.00		RW
19	Surge Delay Time	surg_del	0 to 120	15	sec	RW
20	Surge Time Period	surge_t	7 to 10	8	min	RW
21	Surge Delta Amps %	surge_a	5 to 40	20	%	RW
22	GV1 Close Step Surge	gvstp_sg	1.0 to 3.0	2.0	%	RW
23	VFD Speed Step Surge	vfdstpsg	1.0 to 5.0	1.5	%	RW
24	EC Valve Step Surge	hbpstsg	1.0 to 10.0	4.0	%	RW
25	Surge Profile Offset	sgl_pro	0.0 to 5.0	0.0	°F	RW
26	High Efficiency Mode	high_eff	DSABLE/ENABLE	DSABLE		RW
27	High Noise Alert	noi_alt	DSABLE/ENABLE	DSABLE		RW

LEGEND

*Default value is shown only if configurable in this table.

RW — Read/Write

APPENDIX A — PIC 5 SCREEN AND TABLE STRUCTURE (cont)

Protective Limit Config

CCN TABLE NAME: CFGLIMIT						
PIC 5 PATH: Main Menu → Configuration Menu → Protective Limit Config						
LINE	PIC 5 DESCRIPTION	CCN NAME	RANGE	DEFAULT VALUE*	UNIT	READ/WRITE
1	Evap Approach Alert	evap_al	0.5 to 15	5	°F	RW
2	Cond Approach Alert	cond_al	0.5 to 15	6	°F	RW
3	Cond Press Override Low	cpov_lo	90 to 157	140	psig	RW
4	Cond Press Override High	cpov_hi	200 to 265	250	psig	RW
5	Cond Press Cutout Low	cpcut_lo	155 to 160	160	psig	RW
6	Cond Press Cutout High	cpcut_hi	270 to 275	275	psig	RW
7	Evap Override Delta T	ert_ovdt	2 to 5	3	°F	RW
8	Evap Refrig Trippoint	ert_trip	0 to 40	33	°F	RW
9	High Evap Press Override	ep_ov	90 to 157	140	psig	RW
10	High Evap Press Cutout	ep_cut	160 to 170	165	°F	RW
11	Condenser Freeze Point	cdfreeze	-20.0 to 35.0	34.0	°F	RW
12	Comp Discharge Alert	dgt_alrt	125 to 200	200	°F	RW
13	Comp Motor Temp Override	mt_over	150 to 200	200	°F	RW
14	Comp Bearing Temp Alert	tb_alrt	155 to 175	175	°F	RW
15	Comp Bearing Temp Trip	tb_trip	175 to 185	185	°F	RW
16	Comp Bearing Alert XR6/7	tb_alt2	185 to 210	210	°F	RW
17	Comp Bearing Trip XR6/7	tb_trip2	210 to 220	220	°F	RW
18	Minimum Brine LWT	bri_min	10 to 34	34	°F	RW
19	Heating LWT Protect Set	lwtp_sp	41 to 50	42.8	°F	RW
20	Evap Flow Delta P Cutout	evap_cut	0.5 to 50	5	psig	RW
21	Cond Flow Delta P Cutout	cond_cut	0.5 to 50	5	psig	RW
22	Cond Hi Flow DP Limit	cond_val	0.5 to 50	50	psig	RW
23	Cond Hi Flow Alarm	cond_alm	DSABLE/ENABLE	DSABLE		RW

Climaproyectos
.com

APPENDIX A — PIC 5 SCREEN AND TABLE STRUCTURE (cont)

Option Configuration

CCN TABLE NAME: CONF_OPT

PIC 5 PATH: Main Menu → Configuration Menu → Option Configuration

LINE	PIC 5 DESCRIPTION	CCN NAME	RANGE	DEFAULT VALUE*	UNIT	READ/WRITE
1	Auto Restart Option	astart	DSABLE/ENABLE	DSABLE		RW
2	Common Sensor Option	commsens	DSABLE/ENABLE	DSABLE		RW
3	Water Pressure Option	wp_opt	DSABLE/ENABLE	DSABLE		RW
4	EC Valve Option 0 = No, 1 = Cont 2 = On/Off, 3 = 4-20 mA	hgbp_opt	0 to 3	0		RW
5	EC Selection 0 = Disable, 1 = Surge 2 = Low Load, 3 = Comb	hgbp_sel	0 to 3	0		RW
6	ECV Open IGV1 Position	hpop_gv1	0.5 to 10	5.0	%	RW
7	ECV Close IGV1 Position	hgcl_gv1	1.5 to 20	10.0	%	RW
8	ECV Off DT for Low Load	hgb_toff	0.5 to 10.0	4.0	^F	RW
9	ECV On DT for Low Load	hgb_ton	0.5 to 10.0	2.0	^F	RW
10	ECV Low Load DB	hgbp_ldb	0.5 to 2.0	1.0	^F	RW
11	Head Pres Valve Option	hdpv_opt	DSABLE/ENABLE	DSABLE		RW
12	Head Pres Delta P 0%	hdp_0	20.0 to 85.0	25.0	psig	RW
13	Head Pres Delta P 100%	hdp_100	20.0 to 85.0	50.0	psig	RW
14	Head Pressure Min Output	hdpv_min	0.0 to 100.0	0.0	%	RW
15	Ice Build Option	ice_opt	DSABLE/ENABLE	DSABLE		RW
16	Ice Build Recycle	ice_recy	DSABLE/ENABLE	DSABLE		RW
17	Ice Build Termin Source 0 = Temp, 1 = Contact, 2 = Both	ice_term	0 to 2	0		RW
18	Tower Fan High set point	tfh_sp	55 to 105	75		RW
19	Refrigerant Leak Option	leak_en	DSABLE/ENABLE	DSABLE		RW
20	Refrig Leakage Alarm mA	exv_opt	4 to 20	20		RW
21	Oil EXV Option	leak_ma	DSABLE/ENABLE	DSABLE	mA	RW
22	Oil Temp High Threshold	oil_high	100 to 140	120	°F	RW
23	Oil Temp Low Threshold	oil_low	90 to 130	110	°F	RW
24	Gas Torque Factor	gt_fact	0.25 to 3.0	1	°F	RW
25	Guide Vane/SRD Factor	gv_srd_f	0.7 to 1.20	0.95		RW
26	Power Recovery Timeout	pd_tcfg	0 to 60	15	min	RW
27	Evap Liquid Temp Opt	evap_ref	DSABLE/ENABLE	Enable		
28	Evap App Calc Selection Sat Temp = 0, Ref Temp = 1	evap_ref	0/1	1		RW
29	Condenser Flush Alert	cfa_opt	DSABLE/ENABLE	DSABLE		RW
30	Customer Alert Option	cusa_opt	DSABLE/ENABLE	DSABLE		RW
31	Water Flow Measurement 0 = No, 1 = Digital, 2 = Analog	wfm_opt	0-2	0		RW
32	Water Flow at 4 mA	flow4ma	0-200	0.00	GPS	RW
33	Water Flow at 20mA	flow20ma	0-200	0.00	GPS	RW
34	Evap Flow Rate Baseline	chwf_bas	0-150	0.00	GPS	RW
35	Evap Pres Drop Baseline	evpd_bas	0-20	0.00	PSI	RW
36	Cond Flow Rate Baseline	cdwf_bas	0-150	0.00	PSI	RW
37	Cond Pres Drop Baseline	cdpd_bas	0-20	0.00	PSI	RW
38	Water Pres Drop @ 20mA	wpd_20ma	0-40	10.00	PSI	RW
41	Vapor Source SV Delay	vssv_dly	0-10	5.0	min	RW
42	Max Oil Pressure Diff	opvfdmax	35-60	50	PSI	RW
43	Oil Pump VFD Max Step	opvfdstp	0-10	7	%	RW
44	Vapor Source SV Delay	vssv_dly	0-10	5	min	RW
45	Vapor Source SV Option	vssv_dly	DSABLE/ENABLE	DSABLE		RW

LEGEND

*Default value is shown only if configurable in this table.

RW — Read/Write

APPENDIX A — PIC 5 SCREEN AND TABLE STRUCTURE (cont)

ISM Configuration

CCN TABLE NAME: CONF_ISM						
PIC 5 PATH: Main Menu → Configuration Menu → ISM Configuration						
LINE	PIC 5 DESCRIPTION	CCN NAME	RANGE	DEFAULT VALUE*	UNIT	READ/WRITE
1	Communication Timeout	com_tout	0 to 255	10	sec	RW
2	Starter Type 0 = Full Volt, 1 = Reduced Volt 2 = Solid State, 3 = FS VFD	star_typ	0 to 3	0		RW
3	Single Cycle Dropout	scycd_en	DSABLE/ENABLE	DSABLE		RW
4	Motor Rated Load Amps	rla	10 to 5000	200	amp	RW
5	Motor Rated Kilowatts	rkw	1000 to 8000	1500	kW	RW
6	Motor Locked Rotor Trip	mot_lra	100 to 65535	1000	amp	RW
7	Locked Rotor Start Delay	lrs_del	1 to 10	5	cycles	RW
8	Starter LRA Rating	str_lra	100 to 65535	2000	amp	RW
9	Motor Rated Line Voltage	rlv	200 to 13800	460	V	RW
10	Current Imbal Threshold	cu_th	5 to 100	15	%	RW
11	Voltage Imbal Threshold	vu_th	1 to 10	5	%	RW
12	Motor Current CT Ratio:1	ct_ratio	3 to 1000	100		RW
13	Volt Transformer Ratio:1	vt_rat	1 to 115	1		RW
14	Current Imbal Persist	cu_per	1 to 10	5	sec	RW
15	Voltage Imbal Persist	vu_per	1 to 10	5	sec	RW
16	Line Frequency Faulting	lfref_en	DSABLE/ENABLE	DSABLE		RW
17	Frequency (NO=50 Hz, YES=60 Hz)	linefreq	NO/YES	NO		RW
18	Ground Fault Protection	gfp_en	DSABLE/ENABLE	ENABLE		RW
19	Ground Fault Current	gf_amps	1 to 25	15	amp	RW
20	Ground Fault Persistence	gfp_pers	1 to 10	5	cycles	RW
21	Ground Fault Start Delay	gfs_del	1 to 20	10	cycles	RW
22	Ground Fault CT Ratio:1	gfct_rat	150 to 150	150		RW
23	Overvoltage Threshold	ovvol_th	105 to 115	115	%	RW
24	Undervoltage Threshold	udvol_th	85 to 95	85	%	RW
25	Over Under Volt Persist	ovud_per	1 to 10	5	sec	RW
26	Under Volt Start Delay	uvs_del	1 to 4	1	sec	RW

LEGEND

RW — Read/Write

*Default value is shown only if configurable in this table.

APPENDIX A — PIC 5 SCREEN AND TABLE STRUCTURE (cont)

Factory Parameters

CCN TABLE NAME: FACTORY

PIC 5 PATH: Main Menu → Configuration Menu → Factory Parameters

LINE	PIC 5 DESCRIPTION	CCN NAME	RANGE	DEFAULT VALUE*	UNIT	READ/WRITE
1	Factory Password	fac_pass	0 to 65535	4444		RW
2	Chiller Type 0=19XR6/7, 1=19XR2-5/E/D/V	chil_typ	0 to 1	0		RW
3	Unit Type 0 = Cool Only, 1 = Heat Machine	unit_typ	0 to 1	0		RW
4	Refrigerant Type 0 = R134a, 1 = Low Pressure	refg_typ	0 to 1	0		RW
5	Comp 0 = Single, 1 = Dual	comp_typ	0 to 1	1		RW
6	Cond Shell Side MAWP 0=185 psi, 1=300 psi	cond_typ	0 to 1	0		RW
7	Chilled Medium Type	chmedium	WATER/BRINE	WATER		RW
8	Country Code	coun_cod	0 to 500	86		RW
9	Free Cooling Option	freecool	YES/NO	NO		RW
10	VFD Option 0 = No, 1 = FS FVD, 2 = UM VFD	vfd_opt	0 to 2	0		RW
11	IOB3 Option (19XR2-E/D/V)		YES/NO	YES		RW
13	IOB4 Option	hyd_opt	YES/NO	NO		RW
14	Heat Reclaim Option	heatrecl	YES/NO	NO		RW
15	Guide Vane1 Type 0 = Digital, 1 = Analog	gv1_type	0 to 1	0		RW
16	VFD Feedback Voltage Sel 0 = 0 to 5 V, 1 = 0 to 10 V	vfd_fdv	0 to 1	0		RW
17	Electrical Damper Valve	dmp_auto	DSABLE/ENABLE	DSABLE		RW
18	Marine Option	mrn_opt	DSABLE/ENABLE	DSABLE		RW
19	Power Request Option	pr_opt	DSABLE/ENABLE	DSABLE		RW
20	Cont. Power Request	cpr_opt	DSABLE/ENABLE	DSABLE		RW

General Configuration

CCN TABLE NAME: GEN_CONF

PIC 5 PATH: Main Menu → Configuration Menu → General Configuration

LINE	PIC 5 DESCRIPTION	CCN NAME	RANGE	DEFAULT VALUE*	UNIT	READ/WRITE
1	User Password		1 to 9999	1111		RW
2	Stop to Start Delay	min_off	1 to 15	2	min	RW
3	Start to Start Delay	strt_dly	4 to 45	15	min	RW
4	Demand Limit Type 0 = Base Demand, 1 = 4 to 20 mA	dem_sel	0 to 1	0		RW
5	Pulldown Ramp Type 0 = Temp, 1 = Load	ramp_slct	0 to 1	1		RW
6	Demand Limit Source 0 = amps, 1 = kW	DEM_SLCT	0 to 1	0		RW

LEGEND

*Default value is shown only if configurable in this table.

RW — Read/Write

VFD Parameters

Freestanding VFD

CCN TABLE NAME: CFGGEVFD

PIC 5 PATH: Main Menu → Configuration Menu → General VFD Config

LINE	PIC 5 DESCRIPTION	CCN NAME	RANGE	DEFAULT VALUE*	UNIT	READ/WRITE
1	VFD Gain	vfd_gain	0.10 to 1.50	0.75		RW
2	VFD Max Speed Per	vfd_max	90.0 to 110.0	100.0	%	RW
3	VFD Min Speed Per	vfd_min	65.0 to 100.0	70.0	%	RW
4	VFD Start Speed Per	vfd_str	65.0 to 100.0	100.0	%	RW
5	VFD Current Limit	vfdculm	0.0 to 99999.0	250	amp	RW
6	VFD Load Current 20 mA	vfdc20ma	10.0 to 5000.0	200.0	amp	RW
7	Comp Frequency 100%	comp_100	45.0 to 62.0	50.0	Hz	RW
8	VFD Load Current Input	vfd_ldap	DSABLE/ENABLE	ENABLE		RW

APPENDIX A — PIC 5 SCREEN AND TABLE STRUCTURE (cont)

Unit Mount VFD

CCN TABLE NAME: CFGUMVFD

PIC 5 PATH: Main Menu → Configuration Menu → General VFD Config

LINE	PIC 5 DESCRIPTION	CCN NAME	RANGE	DEFAULT VALUE*	UNIT	READ/WRITE
1	Compressor Speed 100%	comp_hz	47 to 110	50	Hz	RW
2	Rated Line Voltage	rlv_i	200-13800	460	V	RW
3	Motor Nameplate Current	rla	10 to 1500	200	AMPS	RW
4	Motor Nameplate Voltage	rlv	200 to 13800	460	Volts	RW
5	Motor Nameplate RPM	rpm	1500 to 3600	3000	rpm	RW
6	Motor Nameplate KW	rlkw	0 to 5600	1500	KW	RW
7	Skip Frequency 1	skipfrq1	0.0 to 102.0	102	Hz	RW
8	Skip Frequency 2	skipfrq2	0.0 to 102.0	102	Hz	RW
9	Skip Frequency 3	skipfrq3	0.0 to 102.0	102	Hz	RW
10	Skip Frequency Band	skipband	0.0 to 102.0	0	Hz	RW
11	Motor Rated Load Current	rla_load	10 to 1500	200	AMPS	RW
12	Increase Ramp Time	ramp_inc	5 to 60	30	sec	RW
13	Decrease Ramp Time	ramp_dec	5 to 60	30	sec	RW
14	Line Voltage Imbalance%	lvim_th	1 to 10	10	%	RW
15	Line Volt Imbalance Time	lvim_per	1 to 10	10	sec	RW
16	Line Current Imbalance%	lcim_th	5 to 40	40	%	RW
17	Line Current Imbal Time	lcim_per	1 to 10	10	sec	RW
18	Motor Current Imbalance%	mcim_th	5 to 40	40	%	RW
19	Motor Current Imbal Time	mcim_per	1 to 10	10	sec	RW
20	Single Cycle Dropout	scycd_en	0 to 1	0		RW
21	PWM Switch Frequency 0=2KHZ, 1=4KHZ	pwm_freq	0 to 1	0		RW
22	Restore Defaults	res_def	0 to 1	0		RW
23	LEN Comm Timeout	com_tout	0 to 255	10	sec	RW
24	Modbus Comm Timeout	mod_tout	0 to 255	2	sec	RW
25	Gateway Modbus Baud Rate 4800=1, 9600=2, 19200=3, 38400=4	gw_baud	1 to 4	2		RW

SRD Configuration

CCN TABLE NAME: CONF_SRD

PIC 5 PATH: Main Menu → Configuration Menu → SRD Configuration

LINE	PIC 5 DESCRIPTION	CCN NAME	RANGE	DEFAULT VALUE*	UNIT	READ/WRITE
1	Diffuser Option	diff_opt	DSABLE/ENABLE	DSABLE		RW
2	SRD IGV Offset Select	off_sel	1 to 5	3		RW
3	Low Lift Profile Select	pro_sel	1 to 5	3		RW
4	Diffuser Full Span mA	diff_ma	15.0 to 22.0	18.0	mA	RW
5	GV1 Pos @ 25% Load	gv11_25	0.0 to 83.0	6.4	%	RW
6	GV1 Pos @ 50% Load	gv11_50	0.0 to 83.0	22.9	%	RW
7	GV1 Pos @ 75% Load	gv11_75	0.0 to 83.0	41.3	%	RW
8	SRD Pos @ 25% Load	srd1_25	0.0 to 100.0	73.5	%	RW
9	SRD Pos @ 50% Load	srd1_50	0.0 to 100.0	35.1	%	RW
10	SRD Pos @ 75% Load	srd1_75	0.0 to 100.0	19.5	%	RW
11	High Lift Load @ 100%	lf1_100	0.0 to 100.0	67.5	°F	RW
12	High Lift Load @ 25%	lf1_25	0.0 to 100.0	52.4	°F	RW
13	Low Lift Load @ 25%	lf2_25	0.0 to 100.0	27.2	°F	RW
14	Peak Detection Threshold	peak_th	0.0000 to 5.0000	0.0000	Volts	RW

LEGEND

RW — Read/Write

*Default value is shown only if configurable in this table.

APPENDIX A — PIC 5 SCREEN AND TABLE STRUCTURE (cont)

IOB Configuration

CCN TABLE NAME: CONF_IOB

PIC 5 PATH: Main Menu → Configuration Menu → IOB Configuration

LINE	PIC 5 DESCRIPTION	CCN NAME	RANGE	DEFAULT VALUE*	UNIT	READ/WRITE
1	Low Entered Volt V1 IOB		17.0 to 19.0	17		RW
2	Low Exited Volt V2 IOB		19.0 to 21.0	19		RW
3	IOB1 AI#1 Type		0 to 6	4		RW
4	IOB1 AI#2 Type		0 to 6	4		RW
5	IOB1 AI#3 Type		0 to 6	4		RW
6	IOB1 AI#4 Type		0 to 6	4		RW
7	IOB1 AI#9 Type		0 to 5	2		RW
8	IOB1 AO#1 Type		0 to 2	1		RW
9	IOB2 AI#1 Type		0 to 6	4		RW
10	IOB2 AI#2 Type		0 to 6	4		RW
11	IOB2 AI#3 Type		0 to 6	4		RW
12	IOB2 AI#4 Type		0 to 6	0		RW
13	IOB2 AI#8 Type		0 to 5	0		RW
14	IOB2 AI#9 Type		0 to 5	0		RW
15	IOB2 AI#10 Type		0 to 5	5		RW
16	IOB2 AO#1 Type		0 to 2	1		RW
17	IOB2 AO#2 Type		0 to 2	1		RW
17	IOB3 AI#1 Type		0 to 6	4		RW
18	IOB3 AI#2 Type		0 to 6	4		RW
19	IOB3 AI#3 Type		0 to 6	4		RW
20	IOB3 AI#4 Type		0 to 6	4		RW
21	IOB3 AI#5 Type		0 to 5	0		RW
22	IOB3 AI#6 Type		0 to 5	5		RW
23	IOB3 AI#8 Type		0 to 5	0		RW
24	IOB3 AI#9 Type		0 to 5	0		RW
25	IOB3 AI#10 Type		0 to 5	0		RW
26	IOB3 AO#1 Type		0 to 2	1		RW
27	IOB3 AO#2 Type		0 to 2	1		RW
28	IOB4 AI#1 Type		0 to 6	0		RW
29	IOB4 AI#2 Type		0 to 6	0		RW
30	IOB4 AI#3 Type		0 to 6	0		RW
31	IOB4 AI#4 Type		0 to 6	0		RW
33	IOB4 AI#5 Type		0 to 6	0		RW
34	IOB4 AI#6 Type		0 to 6	0		RW
35	IOB4 AI#7 Type		0 to 6	0		RW
36	IOB4 AI#10 Type		0 to 6	0		RW

E-Mail Configuration

CCN TABLE NAME: EMAILCFG

PIC 5 PATH: Main Menu → Configuration Menu → E-Mail Configuration

LINE	PIC 5 DESCRIPTION	CCN NAME	RANGE	DEFAULT VALUE*	UNIT	READ/WRITE
1	E-Mail Function		DSABLE/ENABLE	DSABLE		RW
2	Sender Email Part 1		24 characters			RW
3	Sender Email Part 2		24 characters			RW
4	Recip 1 Email Part 1		24 characters			RW
5	Recip 1 Email Part 2		24 characters			RW
6	Recip 2 Email Part 1		24 characters			RW
7	Recip 2 Email Part 2		24 characters			RW
8	SMTP IP Addr Part 1		0 to 255	0		RW
9	SMTP IP Addr Part 2		0 to 255	0		RW
10	SMTP IP Addr Part 3		0 to 255	0		RW
11	SMTP IP Addr Part 4		0 to 255	0		RW
12	Account Email Part 1		24 characters			RW
13	Account Email Part 2		24 characters			RW
14	Account Password		24 characters			RW
15	Port Number		0 to 255	25		RW
16	Server Timeout		0 to 255	30	sec	RW
17	Server Authentication 0 = No Authentication, 1 = Username Only 2 = Username & domain name		0 to 2	0		RW

LEGEND

*Default value is shown only if configurable in this table.

RW — Read/Write

APPENDIX A — PIC 5 SCREEN AND TABLE STRUCTURE (cont)

Master Slave Configuration

CCN TABLE NAME: CONF_MS						
PIC 5 PATH: Main Menu → Configuration Menu → Master Slave Config						
LINE	PIC 5 DESCRIPTION	CCN NAME	RANGE	DEFAULT VALUE*	UNIT	READ/WRITE
1	Slave Address	slv_addr	1 to 236	2		RW
2	Master/Slave Select 0=Disable, 1=Master, 2=Slave	mssl_sel	0 to 2	0		RW
3	Chiller Connection Type 0=Parallel, 1=Series	ms_type	0 to 1	0		RW
4	Middle Sensor Option	mids_opt	YES/NO	YES		RW
5	Master Lead/Lag Select 0=Lead change to Lag Once Failed 1=Runtime Balance	lead_sel	0 to 1	0		RW
6	Series Counter Flow	serct_fl	YES/NO	NO		RW
7	Master per Capacity	ms_per	25 to 75	50	%	RW
8	LAG Shutdown Threshold	lag_shut	25 to 75	50	%	RW
9	Prestart Fault Time	pref_tim	2 to 30	5	min	RW
10	Lead Unload Threshold		50 to 100	100	%	RW
11	Lead/Lag Balance Delta	ll_bal_d	40 to 400	168	hr	RW
12	Lag Start Time	lstr_tim	2 to 30	10	min	RW
13	Lag Stop Time	lstp_tim	2 to 30	10	min	RW
14	Lead Pulldown Time	lead_pul	0 to 60	0	min	RW
15	Lag Minimum Run Time	lag_mini	0 to 150	0	min	RW
16	Lag Run Delta T	lagrundt	0 to 10.0	3.0	^F	RW
17	Lag Off Delta T	lagoffdt	0 to 10.0	1.8	^F	RW

Prognostics Config

CCN TABLE NAME: CONF_PRG						
PIC 5 PATH: Main Menu → Configuration Menu → Prognostics Config						
LINE	PIC 5 DESCRIPTION	CCN NAME	RANGE	DEFAULT VALUE*	UNIT	READ/WRITE
1	Prog Function Enable	prog_en	YES/NO	NO		RW
2	Oil Change Done	oilch_cm	YES/NO	YES		RW
3	Oil Filter Change Done	oilfc_cm	YES/NO	YES		RW
4	Trans Calibration Done	tracl_cm	YES/NO	YES		RW
5	Refrigerant Charge Done	refch_cm	YES/NO	YES		RW
6	Oil Filter PD Threshold	oilfl_th	-6.7 to 420	10	psig	RW
7	Oil Lub Expire Time	oilch_nt	1000.0 to 8000.0	2000.0	hr	RW
8	Oil Storage Expire Time	oilst_nt	5000.0 to 15000.0	8640	hr	RW
9	Trans Calib Threshold	refgc_th	0 to 5	2	psig	RW
10	Low Charge Cond Approach	rch_cath	20 to 40	20	°F	RW
11	Evap Design Approach	ep_dgap	0 to 10	3	°F	RW
12	Bearing Degradation	bearth_th	100 to 230	200	°F	RW

Reset Configuration

CCN TABLE NAME: RESETCFG						
PIC 5 PATH: Main Menu → Configuration Menu → Reset Configuration						
LINE	PIC 5 DESCRIPTION	CCN NAME	RANGE	DEFAULT VALUE*	UNIT	READ/WRITE
1	Temp Reset Type 0 = No, 1 = 4 to 20 mA 2 = Remote Temp, 3 = Water DT [delta temperature]	res_sel	0 to 3	0		RW
2	Degrees Reset At 20 mA	der_20ma	-30.0 to 30.0	10.0	°F	RW
3	Maximum Deg Temp Reset	deg_rset	-30.0 to 30.0	10.0	°F	RW
4	Remote Temp Full Reset	remtm_fu	-40.0 to 245.0	65.0	°F	RW
5	Remote Temp No Reset	remtm_no	-40.0 to 245.0	85.0	°F	RW
6	Deg Reset Water DT Full	drwdt_fu	-30.0 to 30.0	10.0	°F	RW
7	Controlled DT Full Reset	ctldt_fu	0.0 to 15.0	0.0	°F	RW
8	Controlled DT No Reset	ctldt_no	0.0 to 15.0	10.0	°F	RW

LEGEND



RW — Read/Write

*Default value is shown only if configurable in this table.

APPENDIX A — PIC 5 SCREEN AND TABLE STRUCTURE (cont)

Schedule Menu

Navigation: MAIN MENU → CONFIGURATION MENU → SCHEDULE MENU

ICON	DISPLAYED TEXT	ACCESS	ASSOCIATED TABLE
	Local Schedule	User	
	Ice Build Schedule	User	
	Network Schedule	User	

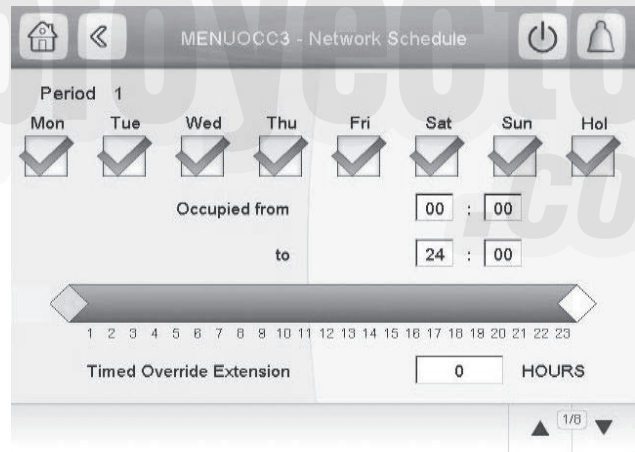
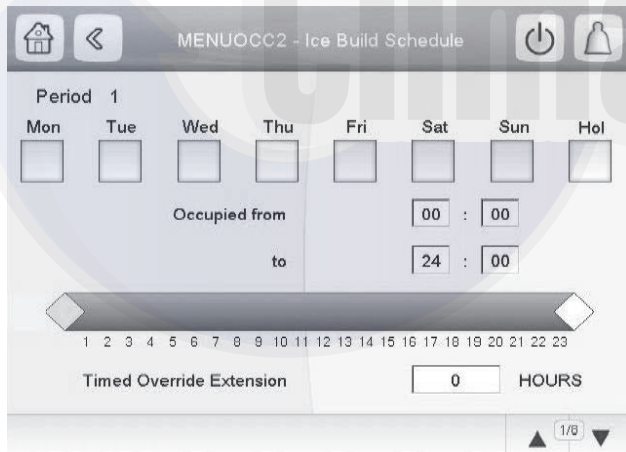
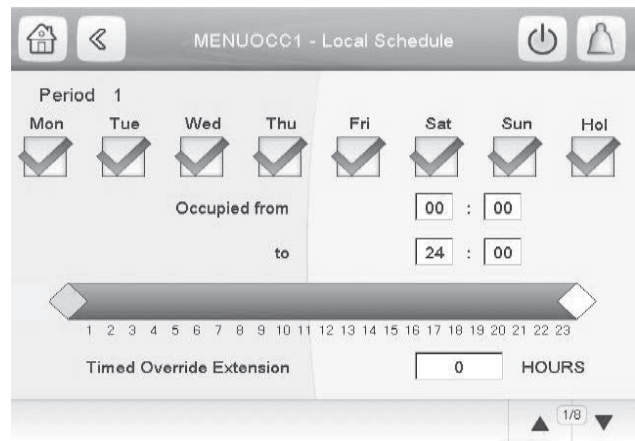
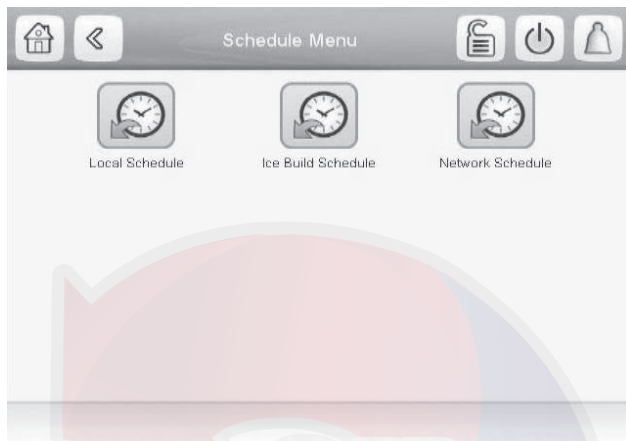

Fig. B — Schedule Menu and Submenus

APPENDIX A — PIC 5 SCREEN AND TABLE STRUCTURE (cont)

Holiday Menu

Navigation: MAIN MENU → CONFIGURATION MENU → HOLIDAY MENU

The Holiday Menu has 16 submenus (HOLDY-01 to HOLDY_16), so it is possible to set 16 different holiday periods. For more information about holiday periods, see the Time Schedule section on page 24. Figure C below shows the Holiday Menu and a sample submenu.

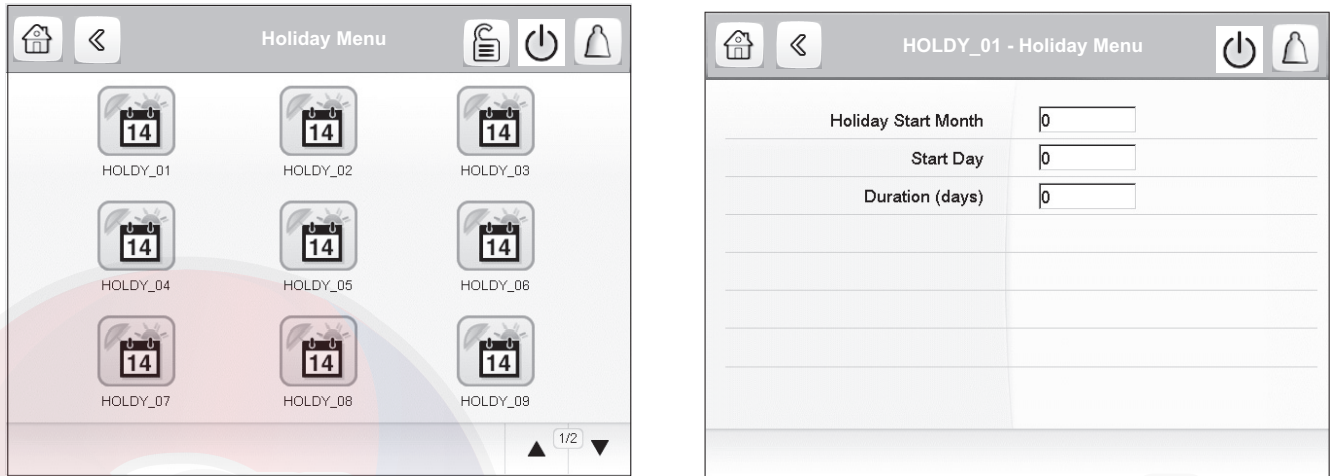

Fig. C — Holiday Menu and Submenu

Broadcast Menu

Navigation: MAIN MENU → CONFIGURATION MENU → BROADCAST MENU

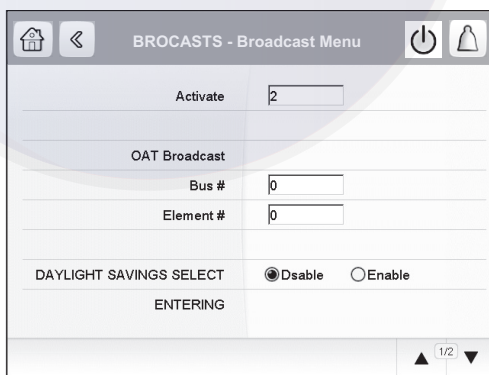

Fig. D — Broadcast Menu

APPENDIX A — PIC 5 SCREEN AND TABLE STRUCTURE (cont)

Date/Time Configuration

Navigation: MAIN MENU → CONFIGURATION MENU → DATE/TIME CONFIGURATION

The screenshot shows a web-based configuration interface for the DATE/TIME settings. At the top, there are navigation icons (home, back, power, and notification) and the title 'DATETIME - Date/Time Configuration'. Below this, the date is set to 2015 / May / 06, the day of the week is Wednesday, and the time is 00:14. There are three checkboxes: 'Daylight Savings Time On', 'Today is a Holiday', and 'Tomorrow is a Holiday', all of which are currently unchecked.

Fig. E — Date/Time Configuration Menu

Network Configuration

CCN TABLE NAME: CONNECT

PIC 5 PATH: Main Menu → Configuration Menu → CONNECT

LINE	PIC 5 DESCRIPTION	CCN NAME	RANGE	DEFAULT VALUE*	UNIT	READ/WRITE
Modbus Configuration						
1	Modbus Option	mb_opt	DSABLE/ENABLE	DSABLE		RW
2	Modbus Server Type 0=IP, 1=RS485	ser_type	0/1	1		RW
3	Modbus Server UID	ser_UID	1 to 255	1		RW
4	Modbus Metric Unit	metric	NO/YES	YES		RW
5	Modbus IP Port Number	port_nbr	0 to 1024	502		RW
6	Modbus RS485 Config Parity Option 0=No Parity, 1=Odd Parity 2=Even Parity, 3= Force Parity Low 4 = Force Parity High 5= Multi Drop parity	parity	0 to 5	0		RW
7	Stop Bit Number 0= 1 Bit, 1= 2 Bits	stop_bit	0 to 1	0		RW
8	Modbus RS485 Baudrate	baudrate	9600 to 38400	9600		RW
BACnet Configuration						
9	BACnet Enable	bacena	DSABLE/ENABLE	ENABLE		RW
10	BACnet Metric Unit	bacunit	NO/YES	YES		RW
11	BACnet Network	network	1 to 9999	1601		RW
12	BACnet Identifier	ldent	0 to 9999999	1600001		RW
Call Home Configuration						
13	Call Home Option	ch_opt	DSABLE/ENABLE	DSABLE		RW
14	Call Home IP Addr Part 1	ch_ip_P1	0 to 255	140		RW
15	Call Home IP Addr Part 2	ch_ip_P2	0 to 255	206		RW
16	Call Home IP Addr Part 3	ch_ip_P3	0 to 255	129		RW
17	Call Home IP Addr Part 4	ch_ip_P4	0 to 255	10		RW

LEGEND

RW — Read/Write

*Default value is shown only if configurable in this table.

NOTES:

1. The BACnet network and the device object identifier can be modified. The default identifier has been chosen to easily recognize the chiller on a BACnet network. The first two digits are the BACnet CARRIER vendor number (16). These parameters must be

- unique on the BACnet network. They must be modified if more than one Carrier chiller is connected to the BACnet network.
2. Changing one of these BACnet parameters will cause a reboot of the board after 1 minute.
3. Changing IP address from the PIC 5 SETUP menu will require a manual reboot or power cycle of the PIC 5 controller in order to re-build the BACnet stack.
4. For more information, see Appendix D — Network Configuration on page 95.

APPENDIX A — PIC 5 SCREEN AND TABLE STRUCTURE (cont)

Quick Test Menu

Navigation: MAIN MENU → QUICK TEST

Quick Test

CCN TABLE NAME: QCK_TEST						
PIC 5 PATH: Main Menu → Quick Test						
LINE	PIC 5 DESCRIPTION	CCN NAME	RANGE	DEFAULT VALUE*	UNIT	READ/WRITE
1	Quick Test Enable	QCK_TEST	DSABLE/ENABLE	DSABLE		RW
2	GV 1 Calibration Enable	GV1_CAL	DSABLE/ENABLE	DSABLE		RW
3	GV1 Calibration Status 0=No Calibration or Failure 1=In Progress, 2=Completed	GV1_STAT	0 to 2			RO
4	Guide Vane 1 Actual Ohms	GV1_OHM	0.00 to 12000.00			RO
5	Guide Vane 1 Actual mA	GV1_MAF	0.0 to 20.8		mA	RO
6	Guide Vane 1 Tested Position	Q_GV1POS	0.0 to 100.0	0.0	%	RW
7	Quick Test GV1 Open	Q_GV1OP	OFF/ON	OFF		RW
8	Quick Test GV1 Close	Q_GV1CL	OFF/ON	OFF		RW
9	Quick Test Oil Pump	Q_OILP	OFF/ON	OFF		RW
10	Oil Pres Test Passed	OP_PASS	NO/YES			RO
11	Oil Pump Delta Pressure	OIL_PDQ	-6.7 to 420.0		psig	RO
12	Quick Test Oil Heater	Q_OILH	OFF/ON	OFF		RW
13	EC Valve Calib Enable	HGBP_CAL	DSABLE/ENABLE	DSABLE		RW
14	EC Valve Calib Status 0 = No Calib or Failure 1 = Progress, 2 = completed)	HGBP_ST	0-2			RO
15	EC Valve Actual mA	HGBP_AMA			mA	RO
16	Quick Test EC Valve Pos	Q_HGBP_T	0-100	0.0	%	RW
17	Quick Test ECV Open	Q_HGBPOP	OFF/ON	OFF		RW
18	Quick Test ECV Close	Q_HGBPCL	OFF/ON	OFF		RW
19	Quick Test Damper Open	Q_DMPOP	OFF/ON	OFF		RW
20	Quick Test Damper Close	Q_DMPCL	OFF/ON	OFF		RW
21	Quick Test Cond Pump	Q_CDWP	OFF/ON	OFF		RW
22	Condenser Water Flow	CDW_FLOW	NO/YES			RO
23	Quick Test Chilled Pump	Q_CHWP	OFF/ON	OFF		RW
24	Chilled Water Flow	CHW_FLOW	NO/YES			RO
25	Quick Test Head Val Pos	Q_HDP	0.0 to 100.0	0.0	%	RW
26	Quick Test Diffuser Pos	Q_SRD	0.0 to 100.0	0.0	%	RW
27	Quick Test Chiller Status	Q_CHST	4.0 to 20.0	4.0	mA	RW
28	Quick Test Oil EXV	Q_EXV	4.0 to 20.0	4.0	mA	RW
29	Condenser Water Delta T	CDW_DT	-40.0 to 245.0		°F	RO
30	Chilled Water Delta T	CHW_DT	-40.0 to 245.0		°F	RO
31	Guide Vane 1 Ohms 100%	GV1_MAXO	0.00 to 12000.00			RO
32	Guide Vane 1 Ohms 0%	GV1_MINO	0.00 to 12000.00			RO
33	Guide Vane 1 mA 100%	GV1_MAXA	0.0 to 20.8		mA	RO
34	Guide Vane 1 mA 0%	GV1_MINA	0.0 to 20.8		mA	RO
35	Quick Test VFD Cooling	Q_VFDCOL	OFF/ON	OFF		RW
36	EC Valve mA 100%	HBP_MAXA		0.0	mA	RO
37	EC Valve mA 0%	HBP_MINA		0.0	mA	RO
38	Quick Test Alarm Output	Q_ALM	OFF/ON	OFF		RW
39	Quick Test Alert Output	Q_ALE	OFF/ON	OFF		RW
40	Quick Test VFD Cooling	Q_VFDCOL	OFF_ON	OFF		RW
41	Quick Test Vapor SV	Q_VAPSUC	OFF/ON	OFF		RW

LEGEND

RO — Read Only
RW — Read/Write

*Default value is shown only if configurable in this table.

APPENDIX A — PIC 5 SCREEN AND TABLE STRUCTURE (cont)

Maintenance Menu

Navigation: MAIN MENU → MAINTENANCE MENU

ICON	DISPLAYED TEXT*	ACCESS	ASSOCIATED TABLE	PAGE NO.
	Capacity Control	Service	CAPACTRL	77
	Override Control	Service	OVERRIDE	77
	Surge Correction	Service	MAISURGE	78
	Maintenance ISM Config	Service	ISM_MCFG	78
	Maintenance VFD Config	Service	VFD_MCFG	79
	Swift Restart	Service	MAISWRST	79
	Master Slave	Service	MAIN_MS	80
	Power Line Parameters	Service	POWER_I	80
	ISM Status	Service	MAIISM	81
	ISM History	Service	MAIISMH	81
	Power Load Parameters		POWER_O	82
	UM VFD Status		VFD_STAT	83
	Maintenance SRD	Service	MAIN_SRD	83
	Maintenance Others	Service	MAIOTHER	84
	Maintenance IOB	Service	MAIOB	85
	Board Software PN	Service	MAI_BDSN	85
	Pressure Sensor Calib	Service	PRES_CAL	86
	Temp Sensor Calib	Service	TEMP_CAL	89
	ISM Calibration	Service	ISM_CAL	90
	Pumpdown/Lockout	Service	PUMPDOWN	90
	System Status	Service	SYS_STAT	91

*Displayed text depends on the selected language (default is English).

APPENDIX A — PIC 5 SCREEN AND TABLE STRUCTURE (cont)

Capacity Control

CCN TABLE NAME: CAPACTRL						
PIC 5 PATH: Main Menu → Maintenance Menu → Capacity Control						
LINE	PIC 5 DESCRIPTION	CCN NAME	RANGE	DEFAULT VALUE*	UNIT	READ/WRITE
1	Total Error + Resets	tot_err			°F	RO
2	Control Point Error	ctrl_err			°F	RO
3	Controlled Water Temp	ctrl_wt			°F	RO
4	Control Point	ctrl_pnt			°F	RO
5	Actual Set Point	setpoint			°F	RO
6	Entering Water Change DT	ewt_dt			°F	RO
7	Enter Water Temp Reset	ewt_res			°F	RO
8	Leaving Water Temp Reset	lwt_res			°F	RO
9	Discharge Gas Temp Reset	dgt_res			°F	RO
10	Capacity Delta	capa_dlt	0 to 100		%	RO
11	Target GV1 Pos	gv1_tgt			%	RO
12	GV1 Pos Change Delta	gv1delta			%	RO
13	GV1 Change Flag 0 = Stop, 1 = Change, 2 = Cont	gv1_chg	0 to 2			RO
14	VFD Speed Change Flag 0 = Stop, 1 = Change, 2 = Cont	vfd_chg	0 to 2			RO
15	Target VFD Speed Percent	vfd_tgt			%	RO
16	VFD Speed Change Delta	vfd_dlt				RO
17	EC Valve Target Percent	hgbp_tp	0 to 100		%	RO
18	Capacity Inhibit Flag	cap_inh	NO/YES			RO
19	Capacity Decrease Flag	cap_dec	NO/YES			RO
20	Condenser Water Delta T	cdw_dt			°F	RO
21	Chilled Water Delta T	chw_dt			°F	RO
22	Pulldown Set Point	pull_set			%	RO
23	Demand Limit Inh Clamp	deinhclm			%	RO
24	Ramping Demand Limit Val	ramp_dem	NO/YES			RO
25	Compressor is Running	comp_run	NO/YES			RO
26	Comp1 Run State Val	cm_stat1	0 to 14		%	RO

LEGEND

RO — Read Only

*Default value is shown only if configurable in this table.

Override Control

CCN TABLE NAME: OVERRIDE						
PIC 5 PATH: Main Menu → Maintenance Menu → Override Control						
LINE	PIC 5 DESCRIPTION	CCN NAME	RANGE	DEFAULT VALUE*	UNIT	READ/WRITE
1	Capacity Inhibit	cap_inho	NO/YES			RO
2	Capacity Decrease	cap_deco	NO/YES			RO
3	High Condenser Pressure	cpov_fl	NO/YES			RO
4	Low Discharge Superheat	dshov_fl	NO/YES			RO
5	Low Suction Sat Temp	sstov_fl	NO/YES			RO
6	High Motor Temp	mtov_fl	NO/YES			RO
7	High Bearing Temp	tbov_fl	NO/YES			RO
8	Low Source Temp	lstov_fl	NO/YES			RO
9	High Discharge Temp	dgtov_fl	NO/YES			RO
10	High Motor Current	ampov_fl	NO/YES			RO
11	Required DSH	dsh_req			°F	RO
12	Evap Sat Override Temp	ert_over			°F	RO
13	IGV Step DSH Increase	dshinstp			%	RO
14	IGV Step DSH Decrease	dshdestp			%	RO
15	Cond Press Trip Value	cp_trip			psig	RO

LEGEND

RO — Read Only

*Default value is shown only if configurable in this table.

APPENDIX A — PIC 5 SCREEN AND TABLE STRUCTURE (cont)

Surge Correction

CCN TABLE NAME: MAISURGE

PIC 5 PATH: Main Menu → Maintenance Menu → Surge Correction

LINE	PIC 5 DESCRIPTION	CCN NAME	RANGE	DEFAULT VALUE*	UNIT	READ/WRITE
1	Surge Region 0 = No, 1 = Low, 2 = High, 3 = Deadband, 4 = Noise	act_reg	0 to 2			RO
2	Active Delta Tsat	dts_act			° F	RO
3	Calc Ref Delta Tsat	dts_cal			°F	RO
4	High Eff Delta Tsat	dts_he			°F	RO
5	Amps Change Surge Prot	amps_dta			%	RO
6	Max Amps Change Value	amch_max			%	RO
7	Surge Counts	sc				RO
8	Surge Protection Counts	spc				RO
9	Surge Prevention Active	surg_act	NO/YES			RO
10	Surge Protection Active	surg_pro	NO/YES			RO
11	EC Vlave Change Flag 0 = Close, 1 = Hold, 2 = Open	hgbp_chg	0 to 2			RO
12	Cal Surge Delta Tmax	dts_maxc	0 to 150.0		°F	RO
13	Cal Surge Delta Tmin	dts_minc	0 to 150.0		°F	RO
14	Cal Surge Delta Tmed	dts_medc	0 to 150.0		°F	RO
15	IGV1 Full Load Position	gv1_sful	0 to 100.0		%	RO
16	IGV1 Minimum Position	gv1_smin	0.0 to 100.0		%	RO
17	Opti-Sound IGV1 Position	gvi_smed			%	RO
18	Envelop Line Optimized	enlp_opt	NO/YES			RO

Maintenance ISM Config

CCN TABLE NAME: ISM_MCFG

PIC 5 PATH: Main Menu → Maintenance Menu → Maintenance ISM Config

LINE	PIC 5 DESCRIPTION	CCN NAME	RANGE	DEFAULT VALUE*	UNIT	READ/WRITE
1	ISM Config Conflict	ism_cflt	NO/YES		—	RO
2	Delete ISM Config	del_ismc	NO/YES	NO	—	RW
3	Communication Timeout	com_tout	0 to 255		sec	RO
	High Eff Ref Delta Tsat	dts_he			°F	RO
4	Starter Type 0=Full Volt, 1=Redu Volt 2=Solid State, 3=FS VFD	star_typ	0 to 3		—	RO
5	Single Cycle Dropout	scycd_en	DSABLE/ENABLE		—	RO
6	Motor Rated Load Amps	rla	10 to 5000		amp	RO
7	Motor Locked Rotor Trip	mot_ira	100 to 65535		amp	RO
8	Locked Rotor Start Delay	lrs_del	1 to 10		cycles	RO
9	Starter LRA Rating	str_ira	100 to 65535		amp	RO
10	Motor Rated Line Voltage	rlv	200 to 13800		V	RO
11	Current Imbal Threshold	cu_th	5 to 100		%	RO
12	Voltage Imbal Threshold	vu_th	1 to 10		%	RO
13	Motor Current CT Ratio:1	ct_ratio	3 to 1000		—	RO
14	Volt Transformer Ratio:1	vt_rat	1 to 115		—	RO
15	Current Imbal Persist	cu_per	1 to 10		sec	RO
16	Voltage Imbal Persist	vu_per	1 to 10		sec	RO
17	Line Frequency Faulting	lfref_en	DSABLE/ENABLE		—	RO
18	Frequency (No=50, Y=60Hz)	linefreq	NO/YES		—	RO
19	Ground Fault Protection	gfp_en	DSABLE/ENABLE		—	RO
20	Ground Fault Current	gf_amps	1 to 25		amp	RO
21	Ground Fault Persistence	gfp_pers	1 to 10		cycles	RO
22	Ground Fault Start Delay	gfs_del	1 to 20		cycles	RO
23	Ground Fault CT Ratio:1	gfct_rat	150 to 150		—	RO
24	Overvoltage Threshold	ovvol_th	105 to 115		%	RO
25	Undervoltage Threshold	udvol_th	85 to 95		%	RO
26	Over Under Volt Persist	ovud_per	1 to 10		sec	RO
27	Under Volt Start Delay	uvs_del	1 to 4		sec	RO

LEGEND

RO — Read Only
RW — Read/Write

*Default value is shown only if configurable in this table.

APPENDIX A — PIC 5 SCREEN AND TABLE STRUCTURE (cont)

Maintenance VFD Config

CCN TABLE NAME: VFD_MCFG						
PIC 5 PATH: Main Menu → Maintenance Menu → Maintenance VFD Config						
LINE	PIC 5 DESCRIPTION	CCN NAME	RANGE	DEFAULT VALUE*	UNIT	READ/WRITE
1	VFD Config Conflict	vfd_cflt	NO/YES	No		RO
2	Delete VFD Config Yes = Delete, No = Keep	del_vfdc	NO/YES	No		RW
3	Motor Rated Load Current	rla_load		200	amps	RO
4	Motor Nameplate Current	rla		200	amps	RO
5	Motor Nameplate Voltage	rlv		460	volts	RO
6	Motor Nameplate RPM	rpm		3000	rpm	RO
7	Motor Nameplate kW	rlkw		1500	kW	RO
8	Compressor Speed 100%	comp_100		50	Hz	RO
9	Skip Frequency 1	skipfrq1		102	Hz	RO
10	Skip Frequency 2	skipfrq2		102	Hz	RO
11	Skip Frequency 3	skipfrq3		102	Hz	RO
12	Skip Frequency Band	skipband		0	Hz	RO
13	Increase Ramp Time	ramp_inc		30	sec	RO
14	Decrease Ramp Time	ramp_dec		30	sec	RO
15	Line Voltage Imbalance%	lvim_th		10	%	RO
16	Line Volt Imbalance Time	lvim_per		10	sec	RO
17	Line Current Imbalance%	lcim_th		40	%	RO
18	Line Current Imbal Time	lcim_per		10	sec	RO
19	Motor Current Imbalance%	mcim_th		40	%	RO
20	Motor Current Imbal Time	mcim_per		10	sec	RO
21	Single Cycle Dropout	scycd_en	DSABLE/ENABLE	DSABLE		RO
22	PWM Switch Frequency 0 = 2 kHz, 1 = 4 kHz	pwm_freq	0/1	0		RO
23	Restore Defaults	res_def	NO/YES	No		RO
24	Communication Timeout	com_tout		10	sec	RO

Swift Restart

CCN TABLE NAME: MAISWRST						
PIC 5 PATH: Main Menu → Maintenance Menu → Swift Restart						
LINE	PIC 5 DESCRIPTION	CCN NAME	RANGE	DEFAULT VALUE*	UNIT	READ/WRITE
1	SRD Position @ Shutdown	srd_shut	0 to 100		%	RO
2	VFD Speed @ Shutdown	vfd_shut	0 to 100		%	RO
3	GV1 Position @ Shutdown	gv1_shut	0 to 100		%	RO
4	Evap Sat Temp @ Shutdown	est_shut	-40 to 280		°F	RO
5	Power Recovery Duration	pd_dur	0 to 65535		min	RO
6	Power Down Active	power_dn	NO/YES			RO
7	Auto Restart Active	auto_rst	NO/YES			RO
8	Swift Restart Active	sw_rst	NO/YES			RO

LEGEND

RO — Read Only

*Default value is shown only if configurable in this table.

Master Slave

CCN TABLE NAME: MAIN_MS
PIC 5 PATH: Main Menu → Maintenance Menu → Master Slave

LINE	PIC 5 DESCRIPTION	CCN NAME	RANGE	DEFAULT VALUE*	UNIT	READ/WRITE
1	Unit is Lead or Lag 0 = Disable 1 = Lead 2 = Lag	lead_lag	0 to 2			RO
2	Master Control Type 0 = Local 1 = Network 2 = Remote 3 = Local Sched	ms_ctrl	0 to 3			RO
3	Slave Control Type 0 = Local 1 = Network 2 = Remote 3 = Local Sched	sl_ctrl	0 to 3			RO
4	Lead Lag Communication	ll_comm	TRUE/FALSE			RO
5	Master Slave Fault 0 = No Fault 1 = Master 2 = Slave 3 = Both	ll_fault	0 to 3			RO
6	Slave Run Status	lagstat	0 to 14			RO
7	Slave Start/Stop	lag_s_s	START/STOP			RO
8	Capacity Decrease	CAP_DECL	NO/YES			RO
9	Capacity Inhibit	CAP_INHL	NO/YES			RO
10	Master Chiller Running	MST_RUN	NO/YES			RO
11	Local Surge Status	LCL_SRG	0 to 3			RO
12	Remote Surge Status	RMT_SRG	0 to 3			RO
13	EWT Control Option	EWT_OPT	DSABLE/ENABLE			RO
14	Demand Limit Source 0 = Amps, 1 = KW	DEM_SLCT	0 to 1			RO
15	Lag Start Timer	lagstart	0 to 60		min	RO
16	Lag Stop Timer	lagstop	0 to 60		min	RO
17	Prestart Fault Timer	prefft	0 to 30		min	RO
18	Pulldown Timer	pulltime	0 to 30		min	RO
19	Pulldown: Delta T / Min	pull_dt	0 to 100		°F	RO
20	Lead/Lag Hours Delta	ll_hr_d	-99999 to 99999		hours	RO
21	Overrid Control Point	ctrpntov	10 to 160.0		°F	RO
22	Overrid Act Demand Limit	demlimov	10 to 100.0		%	RO

Power Parameters

CCN TABLE NAME: POWER_I
PIC 5 PATH: Main Menu → Maintenance Menu → Power Line Parameters

LINE	PIC 5 DESCRIPTION	CCN NAME	RANGE	DEFAULT VALUE*	UNIT	READ/WRITE
1	Line Current Phase 1	LN_AMPS1			amp	RO
2	Line Current Phase 2	LN_AMPS2			amp	RO
3	Line Current Phase 3	LN_AMPS3			amp	RO
4	Actual Line Current	AMPS_A			amp	RO
5	Percent Line Current	AMPS_P			%	RO
6	Ground Fault Phase 1	GRFT_1			amp	RO
7	Ground Fault Phase 2	GRFT_2			amp	RO
8	Ground Fault Phase 3	GRFT_3			amp	RO
9	Line Voltage Phase 1	LN_VOLT1			V	RO
10	Line Voltage Phase 2	LN_VOLT2			V	RO
11	Line Voltage Phase 3	LN_VOLT3			V	RO
12	Actual Line Voltage	VOLT_A			V	RO
13	Percent Line Voltage	VOLT_P			%	RO
14	Motor Kilowatts	KW			kW	RO
15	Motor Kilowatts Hours	KWH			kW	RO
16	Line Frequency	LN_FREQ			Hz	RO
17	Power Factor	POW_FACT				RO
18	Line Current Imbalance%	In_imb_i			%	RO
19	Line Voltage Imbalance%	In_imb_v			%	RO

LEGEND
RO — Read Only

*Default value is shown only if configurable in this table.

APPENDIX A — PIC 5 SCREEN AND TABLE STRUCTURE (cont)

ISM Status

CCN TABLE NAME: MAIISMCM						
PIC 5 PATH: Main Menu → Maintenance Menu → ISM Status						
LINE	PIC 5 DESCRIPTION	CCN NAME	RANGE	DEFAULT VALUE*	UNIT	READ/WRITE
1	Single Cycle Dropout	cycle_1	NO/YES			RO
2	Phase Loss	ph_loss	NO/YES			RO
3	Over Voltage	ov_volt	NO/YES			RO
4	Under Voltage	un_volt	NO/YES			RO
5	Current Imbalance	amp_unb	NO/YES			RO
6	Voltage Imbalance	volt_unb	NO/YES			RO
7	Overload Trip	overload	NO/YES			RO
8	Locked Rotor Trip	lratrip	NO/YES			RO
9	Starter LRA Trip	slratrip	NO/YES			RO
10	Ground Fault	grnd_ft	NO/YES			RO
11	Phase Reversal	ph_rev	NO/YES			RO
12	Frequency Out of Range	freqflt	NO/YES			RO
13	ISM Power On Reset	ism_por	NO/YES			RO
14	Phase 1 Fault	phase_1	NO/YES			RO
15	Phase 2 Fault	phase_2	NO/YES			RO
16	Phase 3 Fault	phase_3	NO/YES			RO
17	1CR Start Complete	start_ok	NO/YES			RO
18	1M Start/Run Fault	1m_ft	NO/YES			RO
19	2M Start/Run Fault	2m_ft	NO/YES			RO
20	Pressure Trip Contact	prs_trip	NO/YES			RO
21	Starter Fault	strt_ft	NO/YES			RO
22	Motor Amps Not Sensed	no_amps	NO/YES			RO
23	Starter Accel Fault	accelflt	NO/YES			RO
24	High Motor Amps	highamps	NO/YES			RO
25	1CR Stop Complete	stop_ok	NO/YES			RO
26	1M/2M Stop Fault	1m2mstop	NO/YES			RO
27	Motor Amps When Stopped	ampstop	NO/YES			RO
28	Hardware Failure	hardware	NO/YES			RO
29	Calibration Factor Error	calfc_er	NO/YES			RO
30	Invalid Configuration	conf_err	NO/YES			RO
31	Unused	un_used	NO/YES			RO

ISM History

CCN TABLE NAME: MAIISMHM						
PIC 5 PATH: Main Menu → Maintenance Menu → ISM History						
LINE	PIC 5 DESCRIPTION	CCN NAME	RANGE	DEFAULT VALUE*	UNIT	READ/WRITE
1	Line Current Phase 1	AMPS_H1			amp	RO
2	Line Current Phase 2	AMPS_H2			amp	RO
3	Line Current Phase 3	AMPS_H3			amp	RO
4	Line Frequency	FREQ_H			Hz	RO
5	Ground Fault Phase 3	GRFT_H1			amp	RO
6	Ground Fault Phase 2	GRFT_H2			amp	RO
7	Ground Fault Phase 1	GRFT_H3			amp	RO
8	Phase 1 Faulted	phase_h1	NO/YES			RO
9	Phase 2 Faulted	phase_h2	NO/YES			RO
10	Phase 3 Faulted	phase_h3	NO/YES			RO
11	I2T Sum Heat Phase 1	sum1ht_h			%	RO
12	I2T Sum Heat Phase 2	sum2ht_h			%	RO
13	I2T Sum Heat Phase 3	sum3ht_h			%	RO
14	Line Voltage Phase 1	VOLT_H1			V	RO
15	Line Voltage Phase 2	VOLT_H2			V	RO
16	Line Voltage Phase 3	VOLT_H3			V	RO

*Default value is shown only if configurable in this table.

LEGEND
RO — Read Only

APPENDIX A — PIC 5 SCREEN AND TABLE STRUCTURE (cont)

Power Load Parameters

CCN TABLE NAME: POWER_O

PIC 5 PATH: Main Menu → Maintenance Menu → Power Load Parameters

LINE	PIC 5 DESCRIPTION	CCN NAME	RANGE	DEFAULT VALUE*	UNIT	READ/WRITE
1	VLF Load Current	VFD_LOAD			amp	
2	Percent VFD Load Current	amps_p_o			%	
3	Ground Fault Current	gf_amps			amp	
4	Motor Current Imbalance%	mt_imb_i			%	
5	Motor Actual Frequency	MOT_FREQ			Hz	
6	Motor Target Frequency	tgt_freq			Hz	
7	DC Bus Voltage	bus_volt			V	
8	DC Bus Voltage Reference	bus_ref			V	
9	Load Current Ph 1(U)	ld_amps1			amp	
10	Load Current Ph 2(V)	ld_amps2			amp	
11	Load Current Ph 3(W)	ld_amps3			amp	
12	Actual VFD Speed Per	vfd_act			%	
13	Motor Power Factor	motor_pf				
14	Motor Kilowatts	motor_kw			kW	
15	Motor Overload	motor_ov			%	
16	Motor Kilowatt-Hours	motorkwh				
17	Rectifier Overload	rect_ov			%	
18	Inverter Overload	inv_ov			%	
19	VFD Enclosure Temp	enc_temp			°F	
20	VFD Cold Plate Temp	cp_temp			°F	
21	Inverter Temperature	inv_temp			°F	
22	Rectifier Temperature	rec_temp			°F	
23	Shunt Trip Relay Status	tripr	0 to 1			
24	Precharge Relay Status	prechar	0 to 1			
25	VFD Run Relay Status	vfd_run	0 to 1			
26	Precharge Feedback	prech_fd	0 to 1			
27	VFD Load Factor	VFD_FACT				
28	VFD Load Current	VFD_LOAD			amp	
29	LR Temp Switch	lrtem_sw	0 to 1			
30	VFD Alarm Code	alm_code				
31	VFD Status Word	stat_wd				
32	VFD Command Word	cmd_wd				
33	VFD Start Inhibit Status	str_inh				
34	VFD Appl Digital Output	appl_do				
35	Safety Stop Status	safestop	0 to 1			
36	SPD Feedback	spd_fd	0 to 1			
37	High VFD Current	VFDC_HI	NO/YES			

*Default value is shown only if configurable in this table.

APPENDIX A — PIC 5 SCREEN AND TABLE STRUCTURE (cont)

UM VFD Status

CCN TABLE NAME: VFD_STAT						
PIC 5 PATH: Main Menu → Maintenance Menu → UM VFD Status						
LINE	PIC 5 DESCRIPTION	CCN NAME	RANGE	DEFAULT VALUE*	UNIT	READ/WRITE
1	Single Cycle Dropout	cycle_1	NO/YES	NO		RO
2	Line Current Imbalance	lineim_i	NO/YES	NO		RO
3	High Line Voltage	hi_volt	NO/YES	NO		RO
4	Low Line Voltage	low_volt	NO/YES	NO		RO
5	Low DC Bus Voltage	lo_dcbus	NO/YES	NO		RO
6	High DC Bus Voltage	hi_dcbus	NO/YES	NO		RO
7	VFD Power On Reset	vfd_por	NO/YES	NO		RO
8	Ground Fault	grndflt	NO/YES	NO		RO
9	Line Phase Reversal	ph_rev	NO/YES	NO		RO
10	Motor Overload Trip	motor_ov	NO/YES	NO		RO
11	Start Complete	start_ok	NO/YES	NO		RO
12	Rectifier Power Fault	rect_pu	NO/YES	NO		RO
13	Invert Power Fault	inv_pu	NO/YES	NO		RO
14	Rectifier Overcurrent	rect_oi	NO/YES	NO		RO
15	Inverter Overcurrent	inv_oi	NO/YES	NO		RO
16	Condenser High Pressure	prs_trip	NO/YES	NO		RO
17	Motor Amps Not Sensed	no_amps	NO/YES	NO		RO
18	Motor Acceleration Fault	acclflt	NO/YES	NO		RO
19	Stop Complete	stop_ok	NO/YES	NO		RO
20	Stop Fault	ampstop	NO/YES	NO		RO
21	Rectifier Overtemp	rect_ot	NO/YES	NO		RO
22	Inverter Overtemp	inv_ot	NO/YES	NO		RO
23	Motor Current Imbalance	motim_i	NO/YES	NO		RO
24	Line Voltage Imbalance	lineim_v	NO/YES	NO		RO
25	Frequency Fault	fregflt	NO/YES	NO		RO
26	VFD Comm Fault	vfd_comm	NO/YES	NO		RO
27	VFD Fault	vfdfault	NO/YES	NO		RO
28	Read Config Complete	readone	NO/YES	NO		RO
29	VFD Start Inhibit	strt_inh	NO/YES	NO		RO
30	VFD Checksum Error	checksum	NO/YES	NO		RO
31	Inductor Overtemp Switch	inot_sw	NO/YES	NO		RO
32	Incompatibility Fault	incomp	NO/YES	NO		RO

Maintenance SRD

CCN TABLE NAME: MAIN_SRD						
PIC 5 PATH: Main Menu → Maintenance Menu → Maintenance SRD						
LINE	PIC 5 DESCRIPTION	CCN NAME	RANGE	DEFAULT VALUE*	UNIT	READ/WRITE
1	Diffuser Target Pos	diff_tgt			%	RO
2	Diffuser Fault	diffault	NO/YES			RO
3	SRD Rotating Stall Alarm	diff_alm	NO/YES			RO
4	Calculated SRD Position	srd_a			%	RO
5	Calc High Lift SRD Pos	srd_1			%	RO
6	Calc Low Lift SRD Pos	srd_2			%	RO
7	Actual Lift	lift_a			°F	RO
8	VDO High Lift Load Line	lift_1			°F	RO
9	VDO Low Lift Load Line	lift_2			°F	RO
10	VDO Logic Start Delay	strt_tmr			min	RO
11	SRD Stall Closure Time	stalltmr			min	RO

LEGEND

RO — Read Only

*Default value is shown only if configurable in this table.

APPENDIX A — PIC 5 SCREEN AND TABLE STRUCTURE (cont)

Maintenance Others

CCN TABLE NAME: MAIOTHER

PIC 5 PATH: Main Menu → Maintenance Menu → Maintenance Others

LINE	PIC 5 DESCRIPTION	CCN NAME	RANGE	DEFAULT VALUE*	UNIT	READ/WRITE
1	5V Sensor Power Monitor	tran_v			V	RO
2	Evap Pres Trans Volts	evapp_v			V	RO
3	Cond Pres Trans Volts	condp_v			V	RO
4	Econ Pres Trans Volts	econp_v			V	RO
5	Diffuser Pres Tran Volts	diffp_v			V	RO
6	Oil Sump Pres Tran Volts	opsmp_v			V	RO
7	Oil Sup Pres Trans Volts	opdis_v			V	RO
8	Evap Enter Water Volts	evewp_v			V	RO
9	Evap Leave Water Volts	evlwp_v			V	RO
10	Cond Enter Water Volts	cdewp_v			V	RO
11	Cond Leave Water Volts	cdlwp_v			V	RO
12	Last Cond Pump Run Time	last_cpt				RO
13	Prestart Check Status	pre_chck	NO/YES			RO
14	GV1 Pos at Startup OK	gvpos_ok	NO/YES			RO
15	OIL PD at Startup OK	oilpd_ok	NO/YES			RO
16	ECV Pos at Startup OK	hgbp_ok	NO/YES			RO
17	Damper Pos at Startup OK	dmp_ok	NO/YES			RO
18	Oil Pump Req Oil Heater	op_heat	NO/YES			RO
19	Oil Pump Req Prestart	op_prest	NO/YES			RO
20	Oil Pump Req Startup	op_start	NO/YES			RO
21	Oil Pump Req Shutdown	op_shut	NO/YES			RO
22	Oil Pump Req Swift Rst	op_srst	NO/YES			RO
23	Evap Pump Req Startup	ep_start	NO/YES			RO
24	Evap Pump Req Diagnostic	ep_diag	NO/YES			RO
25	Evap Pump Req Frozen	ep_freze	NO/YES			RO
26	Evap Pump Req Shutdown	ep_shut	NO/YES			RO
27	Evap Pump Req Pumpdown	ep_pdown	NO/YES			RO
28	Cond Pump Req Prestart	cp_prest	NO/YES			RO
29	Cond Pump Req Startup	cp_start	NO/YES			RO
30	Cond Pump Req Override	cp_overr	NO/YES			RO
31	Cond Pump Req Shutdown	cp_shut	NO/YES			RO
32	Cond Pump Req Tower	cp_tower	NO/YES			RO
33	Cond Pump Req Diagnostic	co_diag	NO/YES			RO
34	Cond Pump Req Frozen	cp_freze	NO/YES			RO
35	Cond Pump Req Pumpdown	cp_pdown	NO/YES			RO
36	Capacity Inhibit Ramping	cap_inhr	NO/YES			RO
37	Capacity Inhibit Demand	cap_inhd	NO/YES			RO
38	Capacity Decrease Demand	cap_decd	NO/YES			RO
39	Guide Vane Inh Surge	gv1_inhs	NO/YES			RO
40	Capacity Decrease Surge	cap_decs	NO/YES			RO
41	Capacity Inh Low SST	capinhst	NO/YES			RO
42	Capacity Dec Low SST	capdecst	NO/YES			RO
43	Capacity Inh Cond Pres	capinhcp	NO/YES			RO
44	Capacity Dec Cond Pres	capdeccp	NO/YES			RO
45	Capacity Inh Motor Temp	capinhmt	NO/YES			RO
46	Capacity Dec Motor Temp	capdecmt	NO/YES			RO
47	Capacity Inh Hi Current	capinham	NO/YES			RO
48	Capacity Dec Hi Current	capdecam	NO/YES			RO
49	Capacity Dec Low Temp	capdecls	NO/YES			RO
50	Capacity Inh DSH	capinhsh	NO/YES			RO

LEGEND

*Default value is shown only if configurable in this table.

RO — Read Only

APPENDIX A — PIC 5 SCREEN AND TABLE STRUCTURE (cont)

Maintenance IOB

CCN TABLE NAME: MAIIOB

PIC 5 PATH: Main Menu → Maintenance Menu → Maintenance IOB

LINE	PIC 5 DESCRIPTION	CCN NAME	RANGE	DEFAULT VALUE*	UNIT	READ/WRITE
1	IOB1 Power Supply Volt	vol_iob1			V	RO
2	IOB1 Num Peak Prev Sec	nm_peak1				RO
3	IOB1 Low Voltage Flag	low_vol1	NO/YES			RO
4	IOB1 24VAC Fuse Status	fusstat1	CLOSE/OPEN			RO
5	IOB2 Power Supply Volt	vol_iob2			V	RO
6	IOB2 Num Peak Prev Sec	nm_peak2				RO
7	IOB2 Low Voltage Flag	low_vol2	NO/YES			RO
8	IOB2 24VAC Fuse Status	fusstat2	CLOSE/OPEN			RO
9	IOB3 Power Supply Volt	vol_iob3			V	RO
10	IOB3 Num Peak Prev Sec	nm_peak3				RO
11	IOB3 Low Voltage Flag	low_vol3	NO/YES			RO
12	IOB3 24VAC Fuse Status	fusstat3	CLOSE/OPEN			RO
13	IOB4 Power Supply Volt	vol_iob4			V	RO
14	IOB4 Num Peak Prev Sec	nm_peak4				RO
15	IOB4 Low Voltage Flag	low_vol4	NO/YES			RO
16	IOB4 24VAC Fuse Status	fusstat4	CLOSE/OPEN			RO
17	IOB5 Power Supply Volt	vol_iob5			V	RO
18	IOB5 Num Peak Prev Sec	nm_peak5				RO
19	IOB5 Low Voltage Flag	low_vol5	NO/YES			RO
20	IOB5 24VAC Fuse Status	fusstat5	CLOSE/OPEN			RO
21	IOB6 Power Supply Volt	vol_iob6			V	RO
22	IOB6 Num Peak Prev Sec	nm_peak6				RO
23	IOB6 Low Voltage Flag	low_vol6	NO/YES			RO
24	IOB6 24VAC Fuse Status	fusstat6	CLOSE/OPEN			RO

Board Software PN

CCN TABLE NAME: MAI_BDSN

PIC 5 PATH: Main Menu → Maintenance Menu → Board Software PN

LINE	PIC 5 DESCRIPTION	CCN NAME	RANGE	DEFAULT VALUE*	UNIT	READ/WRITE
1	IOB #1 Soft Part Number	sn_iob1				RO
2	IOB #2 Soft Part Number	sn_iob2				RO
3	IOB #3 Soft Part Number	sn_iob3				RO
4	IOB #4 Soft Part Number	sn_iob4				RO
5	IOB #5 Soft Part Number	sn_iob5				RO
6	IOB #6 Soft Part Number	sn_iob6				RO
7	ISM Software Part Number	sn_ism				RO
8	Gateway Soft Part Number	sn_gw				RO
9	DCIB Soft Part Number	sn-dcib				RO
10	MBB SVN Revision	svn_rev				RO

LEGEND











RO — Read Only

*Default value is shown only if configurable in this table.

APPENDIX A — PIC 5 SCREEN AND TABLE STRUCTURE (cont)

Pressure Sensor Calib (PRES_CAL) Menu Description

Navigation: MAIN MENU → MAINTENANCE MENU → PRESSURE SENSOR CALIB

ICON	DISPLAYED TEXT	ACCESS	ASSOCIATED TABLE	PAGE NO.
	Evap Pressure Sensor	Service	PRSCAL01	87
	Cond Pressure Sensor	Service	PRSCAL02	87
	Eco Pressure Sensor	Service	PRSCAL03	87
	Diff Pressure Sensor	Service	PRSCAL04	87
	Oil Sump Pressure	Service	PRSCAL05	88
	Oil Supply Pressure	Service	PRSCAL06	88
	Evap Entering Water P	Service	PRSCAL07	88
	Evap Leaving Water P	Service	PRSCAL08	88
	Cond Entering Water P	Service	PRSCAL09	89
	Cond Leaving Water P	Service	PRSCAL10	89

APPENDIX A — PIC 5 SCREEN AND TABLE STRUCTURE (cont)

Evap Pressure Sensor

CCN TABLE NAME: PRSCAL01						
PIC 5 PATH: Main Menu → Maintenance Menu → Pressure Sensor Calib → Evap Pressure Sensor						
LINE	PIC 5 DESCRIPTION	CCN NAME	RANGE	DEFAULT VALUE*	UNIT	READ/WRITE
1	Evap Pressure Sensor					
2	Calibration Enable	cal_en	DSABLE/ENABLE	DSABLE		RW
3	Current Pressure	cur_pres			psig	RO
4	Calib Press1 (0 PSI)	cal_p1	9 digit numeric string	0	psig	RW
5	Calib Press2 (100-250PSI)	cal_p2	9 digit numeric string	0	psig	RW
6	Calibrated Slope	cal_s				RO
7	Calibrated Intercept	cal_i				RO
8	Calibration Completed	cal_st	NO/YES	NO		RO

Cond Pressure Sensor

CCN TABLE NAME: PRSCAL02						
PIC 5 PATH: Main Menu → Maintenance Menu → Pressure Sensor Calib → Cond Pressure Sensor						
LINE	PIC 5 DESCRIPTION	CCN NAME	RANGE	DEFAULT VALUE*	UNIT	READ/WRITE
1	Cond Pressure Sensor					
2	Calibration Enable	cal_en	DSABLE/ENABLE	DSABLE		RW
3	Current Pressure	cur_pres			psig	RO
4	Calib Press1 (0 PSI)	cal_p1	9 digit numeric string	0	psig	RW
5	Calib Press2 (100-250PSI)	cal_p2	9 digit numeric string	0	psig	RW
6	Calibrated Slope	cal_s				RO
7	Calibrated Intercept	cal_i				RO
8	Calibration Completed	cal_st	NO/YES	NO		RO

Eco Pressure Sensor

CCN TABLE NAME: PRSCAL03						
PIC 5 PATH: Main Menu → Maintenance Menu → Pressure Sensor Calib → Eco Pressure Sensor						
LINE	PIC 5 DESCRIPTION	CCN NAME	RANGE	DEFAULT VALUE*	UNIT	READ/WRITE
1	Eco Pressure Sensor					
2	Calibration Enable	cal_en	DSABLE/ENABLE	DSABLE		RW
3	Current Pressure	cur_pres			psig	RO
4	Calib Press1 (0 PSI)	cal_p1	9 digit numeric string	0	psig	RW
5	Calib Press2 (100-250PSI)	cal_p2	9 digit numeric string	0	psig	RW
6	Calibrated Slope	cal_s				RO
7	Calibrated Intercept	cal_i				RO
8	Calibration Completed	cal_st	NO/YES	NO		RO

Diff Pressure Sensor

CCN TABLE NAME: PRSCAL04						
PIC 5 PATH: Main Menu → Maintenance Menu → Pressure Sensor Calib → Diff Pressure Sensor						
LINE	PIC 5 DESCRIPTION	CCN NAME	RANGE	DEFAULT VALUE*	UNIT	READ/WRITE
1	Diff Pressure Sensor					
2	Calibration Enable	cal_en	DSABLE/ENABLE	DSABLE		RW
3	Current Pressure	cur_pres			psig	RO
4	Calib Press1 (0 PSI)	cal_p1	9 digit numeric string	0	psig	RW
5	Calib Press2 (100-250PSI)	cal_p2	9 digit numeric string	0	psig	RW
6	Calibrated Slope	cal_s				RO
7	Calibrated Intercept	cal_i				RO
8	Calibration Completed	cal_st	NO/YES	NO		RO

LEGEND

RO — Read Only
RW — Read/Write

*Default value is shown only if configurable in this table.

APPENDIX A — PIC 5 SCREEN AND TABLE STRUCTURE (cont)

Oil Sump Pressure

CCN TABLE NAME: PRSCAL05

PIC 5 PATH: Main Menu → Maintenance Menu → Pressure Sensor Calib → Oil Sump Pressure

LINE	PIC 5 DESCRIPTION	CCN NAME	RANGE	DEFAULT VALUE*	UNIT	READ/WRITE
1	Oil Sump Pressure					
2	Calibration Enable	cal_en	DSABLE/ENABLE	DSABLE		RW
3	Current Pressure	cur_pres			psig	RO
4	Calib Press1 (0 PSI)	cal_p1	9 digit numeric string	0	psig	RW
5	Calib Press2 (100-250PSI)	cal_p2	9 digit numeric string	0	psig	RW
6	Calibrated Slope	cal_s		0		RO
7	Calibrated Intercept	cal_i		0		RO
8	Calibration Completed	cal_st	NO/YES	0		RO

Oil Supply Pressure

CCN TABLE NAME: PRSCAL06

PIC 5 PATH: Main Menu → Maintenance Menu → Pressure Sensor Calib → Oil Supply Pressure

LINE	PIC 5 DESCRIPTION	CCN NAME	RANGE	DEFAULT VALUE*	UNIT	READ/WRITE
1	Oil Supply Pressure					
2	Calibration Enable	cal_en	DSABLE/ENABLE	DSABLE		RW
3	Current Pressure	cur_pres			psig	RO
4	Calib Press1 (0 PSI)	cal_p1	9 digit numeric string	0	psig	RW
5	Calib Press2 (100-250PSI)	cal_p2	9 digit numeric string	0	psig	RW
6	Calibrated Slope	cal_s				RO
7	Calibrated Intercept	cal_i				RO
8	Calibration Completed	cal_st	NO/YES	NO		RO

Evap Entering Water P

CCN TABLE NAME: PRSCAL07

PIC 5 PATH: Main Menu → Maintenance Menu → Pressure Sensor Calib → Evap Entering Water P

LINE	PIC 5 DESCRIPTION	CCN NAME	RANGE	DEFAULT VALUE*	UNIT	READ/WRITE
1	Evap Entering Water P					
2	Calibration Enable	cal_en	DSABLE/ENABLE	DSABLE		RW
3	Current Pressure	cur_pres			psig	RO
4	Calib Press1 (0 PSI)	cal_p1	9 digit numeric string	0	psig	RW
5	Calib Press2 (100-250PSI)	cal_p2	9 digit numeric string	0	psig	RW
6	Calibrated Slope	cal_s				RO
7	Calibrated Intercept	cal_i				RO
8	Calibration Completed	cal_st	NO/YES	NO		RO

Evap Leaving Water P

CCN TABLE NAME: PRSCAL08

PIC 5 PATH: Main Menu → Maintenance Menu → Pressure Sensor Calib → Evap Leaving Water P

LINE	PIC 5 DESCRIPTION	CCN NAME	RANGE	DEFAULT VALUE*	UNIT	READ/WRITE
1	Evap Leaving Water P					
2	Calibration Enable	cal_en	DSABLE/ENABLE	DSABLE		RW
3	Current Pressure	cur_pres			psig	RO
4	Calib Press1 (0 PSI)	cal_p1	9 digit numeric string	0	psig	RW
5	Calib Press2 (100-250PSI)	cal_p2	9 digit numeric string	0	psig	RW
6	Calibrated Slope	cal_s				RO
7	Calibrated Intercept	cal_i				RO
8	Calibration Completed	cal_st	NO/YES	NO		RO

LEGEND

*Default value is shown only if configurable in this table.

RO — Read Only
RW — Read/Write

APPENDIX A — PIC 5 SCREEN AND TABLE STRUCTURE (cont)

Cond Entering Water P

CCN TABLE NAME: PRSCAL09						
PIC 5 PATH: Main Menu → Maintenance Menu → Pressure Sensor Calib → Cond Entering Water P						
LINE	PIC 5 DESCRIPTION	CCN NAME	RANGE	DEFAULT VALUE*	UNIT	READ/WRITE
1	Cond Entering Water P					
2	Calibration Enable	cal_en	DSABLE/ENABLE	DSABLE		RW
3	Current Pressure	cur_pres			psig	RO
4	Calib Press1(0 PSI)	cal_p1	9 digit numeric string	0	psig	RW
5	Calib Press2 (100-250PSI)	cal_p2	9 digit numeric string	0	psig	RW
6	Calibrated Slope	cal_s				RO
7	Calibrated Intercept	cal_i				RO
8	Calibration Completed	cal_st	NO/YES	NO		RO

Cond Leaving Water P

CCN TABLE NAME: PRSCAL10						
PIC 5 PATH: Main Menu → Maintenance Menu → Pressure Sensor Calib → Cond Leaving Water P						
LINE	PIC 5 DESCRIPTION	CCN NAME	RANGE	DEFAULT VALUE*	UNIT	READ/WRITE
1	Cond Leaving Water P					
2	Calibration Enable	cal_en	DSABLE/ENABLE	DSABLE		RW
3	Current Pressure	cur_pres			psig	RO
4	Calib Press1(0 PSI)	cal_p1	9 digit numeric string	0	psig	RW
5	Calib Press2 (100-250PSI)	cal_p2	9 digit numeric string	0	psig	RW
6	Calibrated Slope	cal_s				RO
7	Calibrated Intercept	cal_i				RO
8	Calibration Completed	cal_st	NO/YES	NO		RO

LEGEND

*Default value is shown only if configurable in this table.

RO — Read Only
RW — Read/Write

Temp Sensor Calib

CCN TABLE NAME: TEMP_CAL						
PIC 5 PATH: Main Menu → Maintenance Menu → Temp Sensor Calib						
LINE	PIC 5 DESCRIPTION	CCN NAME	RANGE	DEFAULT VALUE*	UNIT	READ/WRITE
1	Entering Chilled Water	ECW			°F	RO
2	ECW Sensor Raw Temp	ECW_RAW			°F	RO
3	ECW Temperature Offset	ECW_OFF	-2.0 to 2.0	0	^F	RW
4	Leaving Chilled Water	LCW			°F	RO
5	LCW Sensor Raw Temp	LCW_RAW			°F	RO
6	LCW Temperature Offset	LCW_OFF	-2.0 to 2.0	0	^F	RW
7	Entering Condenser Water	ECDW			°F	RO
8	ECDW Sensor Raw Temp	ECDW_RAW			°F	RO
9	ECDW Temperature Offset	ECDW_OFF	-2.0 to 2.0	0	^F	RW
10	Leaving Condenser Water	LCDW			°F	RO
11	LCDW Sensor Raw Temp	LCDW_RAW			°F	RO
12	LCDW Temperature Offset	LCDW_OFF	-2.0 to 2.0	0	^F	RW

LEGEND

*Default value is shown only if configurable in this table.

RO — Read Only
RW — Read/Write

APPENDIX A — PIC 5 SCREEN AND TABLE STRUCTURE (cont)

ISM Calibration — J8B 4 to 20mA Output

CCN TABLE NAME: ISM_CAL1

PIC 5 PATH: Main Menu → Maintenance Menu → ISM Calibration → J8B 4-20mA Output

LINE	PIC 5 DESCRIPTION	CCN NAME	RANGE	DEFAULT VALUE*	UNIT	READ/WRITE
1	Calibration Enable	cal_en	DSABLE/ENABLE	DSABLE		RW
2	ISM Output mA	ism_ma	4 to 20	0	mA	RW
3	ISM Output Percent	ismo_per	0 to 100	0	%	RO
4	VFD Reading mA	vfd_ma	4 to 20	0	mA	RW
5	VFD Reading Percent	vfdi_per	0 to 100	0	%	RO
6	Calibration Factor	cal_fact	0 to 2000	0		RO
7	Calibration Completed	cal_done	NO/YES	NO		RO

LEGEND

*Default value is shown only if configurable in this table.

RW — Read/Write

ISM Calibration — J6 0-10V Input

CCN TABLE NAME: ISM_CAL2

PIC 5 PATH: Main Menu → Maintenance Menu → ISM Calibration → J6 0-10V Input

LINE	PIC 5 DESCRIPTION	CCN NAME	RANGE	DEFAULT VALUE*	UNIT	READ/WRITE
1	Calibration Enable	cal_en	DSABLE/ENABLE	DSABLE		RW
2	VFD Output Voltage	vfd_v	0 to 10	0	Volts	RW
3	VFD Output Percent	vfd_o_per	0 to 100	0	%	RO
4	ISM Reading Voltage	ism_v	0 to 10	0	Volts	RW
5	ISM Reading Percent	ismi_per	0 to 100	0	%	RO
6	Calibration Factor	cal_fact	800 to 1200	1000		RO
7	Calibration Completed	cal_done	NO/YES	NO		RO

LEGEND

*Default value is shown only if configurable in this table.

RW — Read/Write

Pumpdown/Lockout (Screen 1)

Navigation: MAIN MENU → MAINTENANCE MENU → PUMPDOWN/LOCKOUT

PUMPDOWN — The control shall support the use of an external means to pump the refrigerant from the evaporator to the condenser for service purposes.

Upon entering Pumpdown, the following message is displayed:

Press OK to Start Pumpdown?

If the operator selects the OK key, chilled water pump and condenser water pump shall be turned on and the following message is displayed:

Water Flow Verifying...

If both flows are not confirmed before the WATER FLOW VERIFY TIME, then both pumps shall be de-energized and either, or both, of the following messages will be displayed:

Water Flow Verification Failed

At this point, EXIT will be the only course of action.

If both flows are confirmed, the following message will be displayed with the OK and Cancel soft key:

Continue?

When the operator confirms flow by pressing the OK soft key the following message will be displayed:

Please Remove Refrigerant. Press OK if Completed.

After operator removes refrigerant and then selects the OK soft key, the following message will be displayed:

Chiller Lockout in Effect

Once Lockout is in effect, a Startup will not be allowed until a Terminate Lockout (next section) is performed. The following message “Chiller Start or in Quick Test, Pumpdown/Lockout Denied” will be displayed.

The Hot Gas Bypass Relay shall be set to OFF to prevent it from being energized until Lockout is terminated. The only option the user has at this time is to exit Pumpdown.

TERMINATE LOCKOUT — Upon entering Terminate Lockout, the operator is prompted by the following message:

Chiller Lockout in Effect

Upon selecting the “End Lockout” key, the following message will be displayed:

Press OK to Terminate Lockout?

The CHILLED WATER PUMP and CONDENSER WATER PUMP shall be energized and water flows will be verified. And then The “Continue?” text will be displayed.

Operator should manually check the water flows. If operator presses the “Exit” button, the following description will be displayed.

Water Flow Verification Failed

At this point, EXIT will be the only course of action.

If OK button is pressed, the following message will be displayed:

Please Add Refrigerant. Press OK if Completed.

After adding refrigerant to chiller, the operator shall select the OK soft key to continue. Upon doing so, the operator is further prompted as follows:

Chiller Lockout Terminated

The operator can only exit Terminate Lockout at this point. Startup is once again allowed by the control and the Hot Gas Bypass Relay shall be enabled to be turned ON.

APPENDIX A — PIC 5 SCREEN AND TABLE STRUCTURE (cont)

System Status





CCN TABLE NAME: SYS_STAT						
PIC 5 PATH: Main Menu → Maintenance Menu → System Status						
LINE	PIC 5 DESCRIPTION	CCN NAME	RANGE	DEFAULT VALUE*	UNIT	READ/WRITE
1	System Control Mode	sys_ctlm				RO
2	System Status	sys_stat				RO
3	Master Run Status	mas_stat				RO
4	Slave Run Status	sla_stat				RO
5	System Percent Load	sys_perl			%	RO
6	System KW	sys_kw			kW	RO
7	System Control Point	sys_stlp			°F	RO
8	System Demand Limit	sys_dem			%	RO
9	Supply Liquid Temp	sys_supt				RO
10	Return Liquid Temp	sys_rent				RO

LEGEND

*Default value is shown only if configurable in this table.

RO — Read Only

Alarms Menu Description

ICON	DISPLAYED TEXT	ACCESS	ASSOCIATED TABLE	PAGE NO.
	Reset Alarms	All	ALARMRST	91
	Current Alarms	All	CUR_ALM	
	History Alarms	All	ALMHIST1	
	Prognostics	All	HEALTH	

Alarm Reset

CCN TABLE NAME: ALARMRST						
PIC 5 PATH: Main Menu → Alarm Menu → Alarm Reset						
LINE	PIC 5 DESCRIPTION	CCN NAME	RANGE	DEFAULT VALUE*	UNIT	READ/WRITE
1	Alarm Reset	RST_ALM	NO/YES	NO		RW
2	Alarm State	ALM_STAT				RO
3	Current Alarm 1	alarm_1c				RO
4	Current Alarm 2	alarm_2c				RO
5	Current Alarm 3	alarm_3c				RO
6	Current Alarm 4	alarm_4c				RO
7	Current Alarm 5	alarm_5c				RO
8	Jbus Current Alarm 1	alarm_1				RO
9	Jbus Current Alarm 2	alarm_2				RO
10	Jbus Current Alarm 3	alarm_3				RO
11	Jbus Current Alarm 4	alarm_4				RO
12	Jbus Current Alarm 5	alarm_5				RO

LEGEND

*Default value is shown only if configurable in this table.

RO — Read Only
RW — Read/Write

NOTE: For more information about viewing and resetting alarms, see the Diagnostics and Troubleshooting section on page 32.

APPENDIX B — INPUT/OUTPUT BOARD (IOB) AND HUMAN MACHINE INTERFACE (HMI) DIP SWITCH SETTINGS

IOB Dip Switch Settings (Fig. F)

IOB	SW1 SETTING (1 TO 4)	SW2 SETTING (1 TO 10)
IOB-1	0000	0000000000
IOB-2	1000	0000000110
IOB-3	0100	0000010110
IOB-4	1100	1100000110

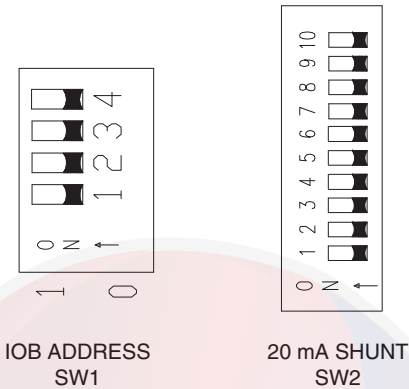

IOB-1 Dip Switch Settings

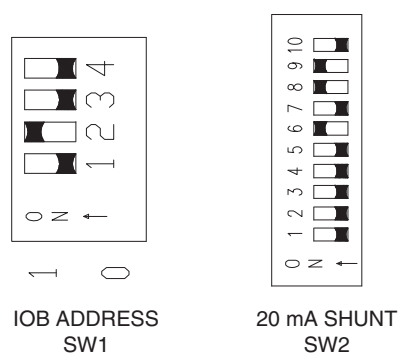

IOB-3 Dip Switch Settings

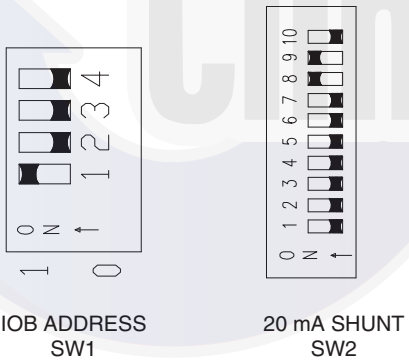

IOB-2 Dip Switch Settings

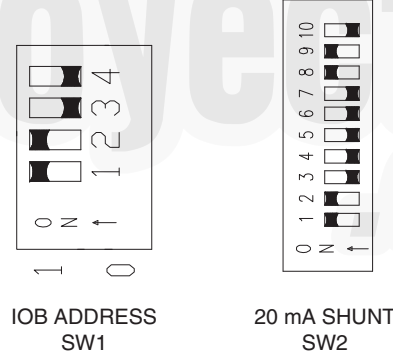

IOB-4 Dip Switch Settings

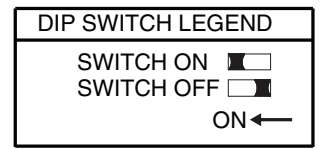

BLACK IS RAISED PORTION OF SWITCH

Fig. F — IOB Dip Switch Settings

APPENDIX B — INPUT/OUTPUT BOARD (IOB) AND HUMAN MACHINE INTERFACE (HMI) DIP SWITCH SETTINGS (cont)

HMI Dip Switch Settings — To access switches, remove the access cover on the back of the HMI panel. See Fig. G.

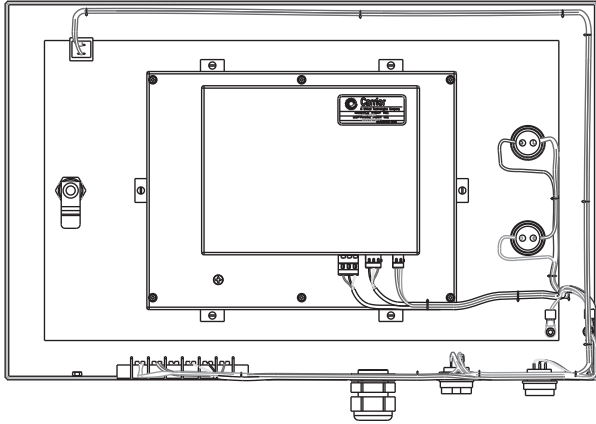

Fig. G — HMI Access Cover

Set the HMI dip switches as shown in Fig. H.



Fig. H — HMI Dip Switch Settings

APPENDIX C — INPUT/OUTPUT BOARD (IOB) STATUS INDICATORS

All control boards have LED indicators that show control board and communication status.

A red LED on each control module operates in the following manner:

- Power not present or power supply failure: LED is off
- Power present but microprocessor in Reset: LED is off
- Microprocessor operational but not communicating: LED flashes 3 seconds on, 3 seconds off
- Microprocessor operational and communicating with control system: LED flashes at 0.5 Hz rate (1 second on, 1 second off) in sync (± 100 ms) with all other new control modules on the same communication bus

- Microprocessor in boot mode: LED flashes at 0.2 seconds on, 0.2 seconds off

Each independent communication port has a green status LED. The green LED is on when data is being transmitted by the board.

All RS485 ports have a green LED.



APPENDIX D — NETWORK CONFIGURATION

General: Net Protocol

Extended Modbus Connector — Ethernet connector and CCN connector on PIC 5 controller can be configured to be a Modbus connector:

Step 1: Configuration Menu → Network Configuration, Modbus Option set to Enable

Step 2: When the Modbus Server Type is set to 0(IP), Ethernet connector will be the Modbus connector; when the Modbus Server Type is set to 1(RS485), CCN connector will be the Modbus connector.

Step 3: Wait 40 seconds; the controller will reboot automatically to save the configuration change.

Extended Open Protocol Connector — Ethernet connector and CCN connector on PIC 5 controller can be configured to be a Modbus connector (feature initiated in v3.2 software) with the following steps:

Step 1: Configuration Menu → Network Configuration, Modbus Option set to Enable

Step 2: Modbus Server Type set to 0(IP), Ethernet connector will be the Modbus connector; Set to 1(RS485), CCN connector will be the Modbus connector.

Step 3: Wait 40 seconds; controller will reboot automatically to save the configuration change.

See Fig. I-L. Even if ethernet connector is configured to be the extended Modbus connector, it still can be configured to BACnet with BACnet dongle installed and BACnet option set to enable.

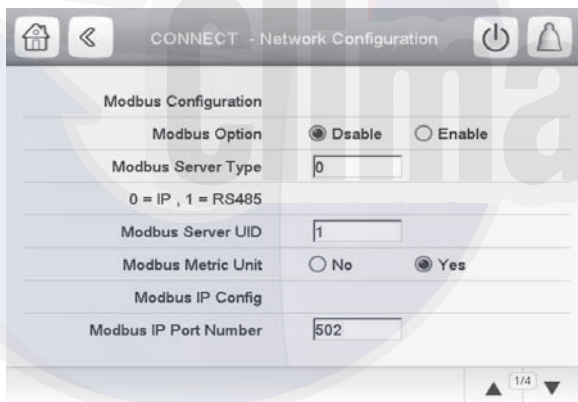

Fig. I —Network Configuration Screen, Page 1

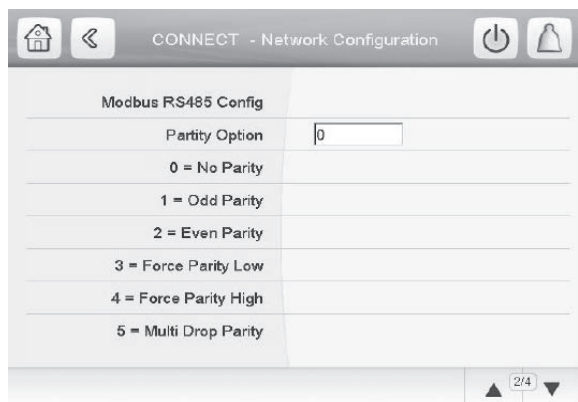

Fig. J —Network Configuration Screen, Page 2

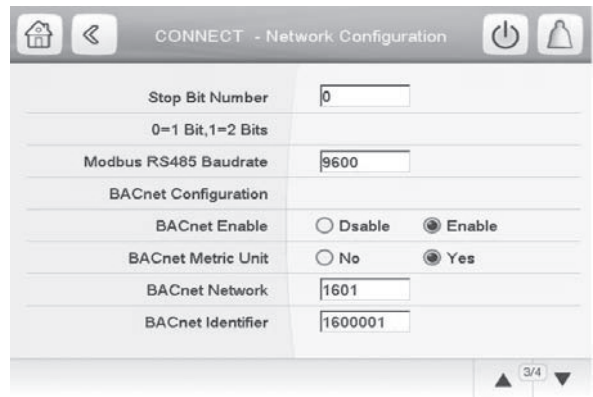

Fig. K —Network Configuration Screen, Page 3

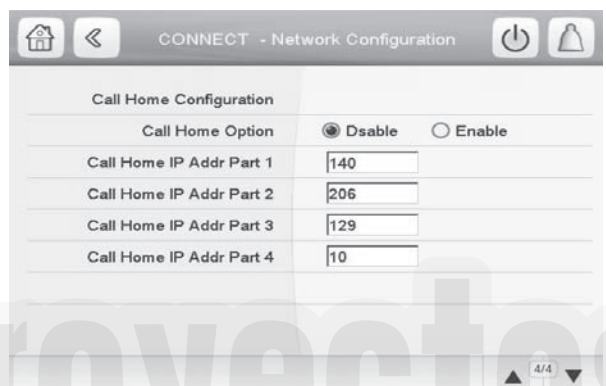

Fig. L —Network Configuration Screen, Page 4

BACnet/IP — The 19XR PIC 5 controller supports the BACnet protocol as B-ASC BACnet equipment over IP. In addition, BACnet on the PIC 5 controller supports the following features:

- Optional properties such as Change of Value (COV), Intrinsic Reporting, and Commandable properties on some objects.
- The generation of limited alarm and event notifications and the ability to direct them to recipients
- The tracking of acknowledgments of alarms from human operators
- The adjustment of alarm parameters
- Read/write property for many objects

Installing the BACnet Dongle — The BACnet option can be implemented at the factory or on-site. This section is intended for on-site installation.

It is strongly recommended to disconnect the complete power supply before any intervention. Disconnect the main power supply with appropriate disconnect devices. Only personnel qualified to the level recommended in standard IEC 60364 (International Electrotechnical Commission) and trained to do this may have access to electrical components.

APPENDIX D — NETWORK CONFIGURATION (cont)

⚠ CAUTION

The components that make up the chiller controller include electronic components. These may generate or be damaged by electromagnetic interference such as electrostatic discharge (ESD).

Technicians who do not have access to an ESD wrist strap on site should follow these recommendations in order to minimize the risk of ESD:

- Be sure to be at zero potential by touching an unpainted surface on the electrical box.
- Do not wear clothing that tends to conduct electrical charge, such as a wool sweater.
- Electrical storms can increase the ESD risk; unless absolutely necessary, do not work on the chiller controller during an electrical storm.

MOUNTING THE BACNET DONGLE — Follow these steps to mount the BACnet dongle in the PIC 5 control box:

1. Disconnect the PIC 5 control power supply.
2. Open the metal cover of the control box with a screwdriver. See Fig. M and N.

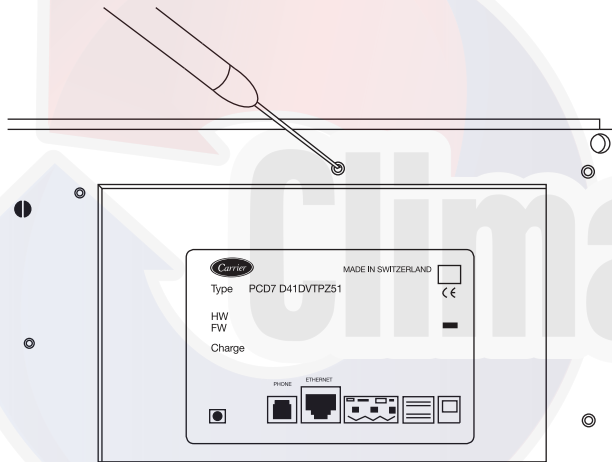

Fig. M — Opening Cover

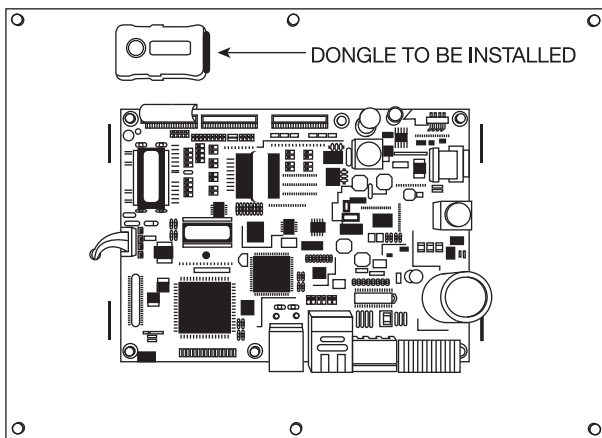

Fig. N — Cover Removed

3. Insert the BACnet dongle into the connector. See Fig. O.

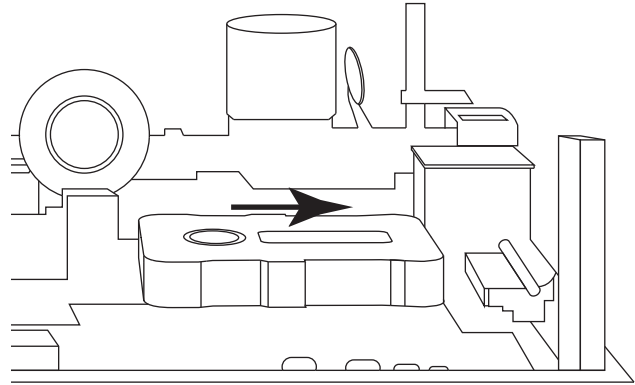

Fig. O — Inserting BACnet Dongle

4. Mount the plastic holder that holds the dongle to the board. See Fig. P.

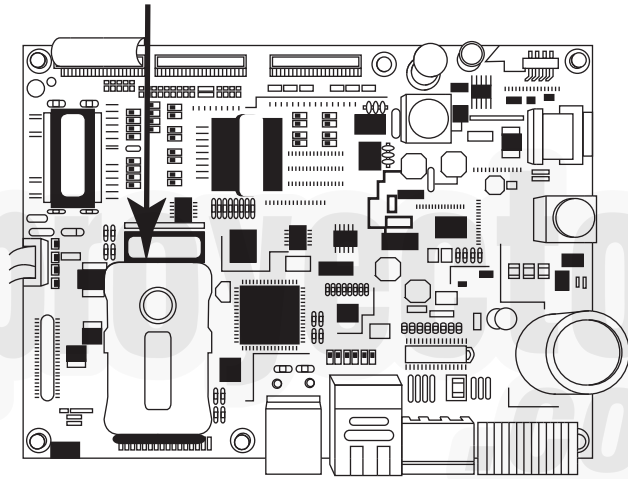

Fig. P — Mounting Plastic Holder

5. Close the box and power up the PIC 5 controller.

TESTING THE INSTALLATION — To verify that the dongle connection is correctly inserted and detected by the equipment, with the controller powered up, go to the PIC 5 Main Menu → Inputs Status and confirm that the BACnet Dongle status is Yes.

BACnet Settings — BACnet settings are available on the Main Menu → Configuration Menu → CONNECT. The menu requires the Advanced User password for access. For details, see the Network Configuration table on page 74.

BACnet Objects — The 19XR PIC 5 contains up to 500 BACnet objects. They can be of ANALOG_VALUE (AV) or BINARY_VALUE (BV) type. Objects name are assigned by concatenating the CCN table name and CCN point name. This enables easy identification and recognition of the points. For a detailed list, see the BACnet Object table beginning on page 98.

In general, the equipment configuration parameters are available as Read Only. Setpoint parameters can be read and written (Read-Write).

APPENDIX D — NETWORK CONFIGURATION (cont)

Compressor status is ASCII-coded. In order to obtain the status from BACnet, statuses are assigned a BACnet code as shown in Table A.

Table A — Equipment Status

BACNET CODE	TEXT
0	Off
1	Control Test
2	Pumpdown
3	Lockout
4	Recycle
5	Tripout
6	Timeout
7	Prestart
8	Startup
9	Autorst
10	Ramping
11	Running
12	Override
13	Demand
14	Shutdown
15	Freecool
16	Condflsh

Alarm states are coded as shown in Table B.

Table B — Alarm States

BACNET CODE	CCN CODE
0	Normal
1	Partial (Alert)
2	Shutdown (Alarm)

Modifying the Unit IP Address — Note that changing IP address from the PIC 5 SETUP menu will require a manual reboot or power cycle of the PIC 5 controller in order to re-build the BACnet stack. For detailed instructions, see the Unit IP Address section on page 49.

BACnet IP Communication Problems — If the unit does not respond to the building management system, possible causes include the following:

- The BACnet dongle is not detected by the chiller application.
- The Ethernet cable is not correctly connected.
- Network parameters are not correct (see the Ethernet/IP Connection Problems section on page 53).
- There is an IP router between the equipment and the building management system.
- BACnet Enable parameter in the PIC 5 Configuration Menu is set to No.

To troubleshoot problems, try these measures:

- Open the metal casing of the 19XR PIC 5 controller and verify that the blue BACnet dongle is correctly connected.
- On the Ethernet connector, verify that the green LED is ON and the orange LED is blinking.
- Use the Windows ping utility to ping the IP address of the controller.
- Open 19XR PIC 5 Configuration Menu (Service password required) and check BACnet parameters.
- Use the free software called BDT (BACnet Discovery Tool) available on the internet (search *bacnet bdt*) and install it on the PC. All equipment connected to the BACnet network will respond to the “Who Is” command sent by this tool. Find the equipment configured with the BACnet device instance (1600001 default for Carrier equipment).

APPENDIX D — NETWORK CONFIGURATION (cont)

Table C — BACnet Object Table

OBJECT NAME	OBJECT ID	OPTION	READ/WRITE	DESCRIPTION
ALARMRST_alarm_1	AV:68		RO	Jbus Current Alarm 1
ALARMRST_alarm_2	AV:69		RO	Jbus Current Alarm 2
ALARMRST_alarm_3	AV:70		RO	Jbus Current Alarm 3
ALARMRST_alarm_4	AV:71		RO	Jbus Current Alarm 4
ALARMRST_alarm_5	AV:72		RO	Jbus Current Alarm 5
CAPACTRL_cm_stat1	AV:76	COV, IR	RO	Comp1 Run State Val
CAPACTRL_ctrl_wt	AV:73		RO	Controlled Water Temp
CAPACTRL_gv1_tgt	AV:74		RO	Target GV1 Pos
CAPACTRL_vfd_tgt	AV:75		RO	Target VFD Speed Per
CFGSURGE_gv1_pful	AV:96		RO	IGV1 Full Load Position
CFGSURGE_gv1_pmin	AV:95		RO	IGV1 Minimum Position
CFGSURGE_sgl_hoff	AV:99		RO	Envelop Upper Deadband
CFGSURGE_sgl_loff	AV:98		RO	Envelop Lower Deadband
CFGSURGE_sgl_off	AV:97		RO	Envelop Line Offset
CFGSURGE_sgl_pro	AV:103		RO	Surge Profile Offset
CFGSURGE_sgl_shfh	AV:100		RO	Surge Line Shape Factor
CFGSURGE_sgl_shfl	AV:101		RO	Sound Line Shape Factor
CFGSURGE_sgl_spdf	AV:102		RO	Envelop Speed Factor
CONF_OPT_hgbp_opt	AV:104		RO	EC Valve Option No=0, Cont.=1, ON/OFF=2, mA=3
CONF_OPT_hgbp_sel	AV:105		RO	EC Selection Disable=0, Surge=1 Low Load=2, Comb=3
CONNECT_bacena	BV:37		RO	BACnet Enable
CONNECT_bacunit	BV:38		RO	BACnet Metric Unit
CONNECT_ident	AV:107		RO	BACnet Identifier Call Home Configuration
CONNECT_network	AV:106		RO	BACnet Network
GENUNIT_AMPS_P	AV:4	COV, IR	RO	Percent Load Current
GENUNIT_ch_state	AV:7		RO	Chiller Status Code
GENUNIT_CHIL_OCC_rd	BV:3	COV, IR	RO	Network:Cmd Occupied
GENUNIT_CHIL_OCC_wr	BV:42	CMD	RW	Network:Cmd Occupied
GENUNIT_CHIL_S_S_rd	BV:2	COV	RO	Network:Cmd Start/Stop
GENUNIT_CHIL_S_S_wr	BV:40	CMD	RW	Network:Cmd Start/Stop
GENUNIT_ctl_mode	AV:1	COV, IR	RO	Control Mode Local=0, Network=1 Remote=2, Local Sched=3
GENUNIT_CTRL_PNT_rd	AV:3	COV, IR	RO	Control Point
GENUNIT_CTRL_PNT_wr	AV:114	CMD	RW	Control Point
GENUNIT_DEM_LIM_rd	AV:6	COV	RO	Actual Demand Limit
GENUNIT_DEM_LIM_wr	AV:115	CMD	RW	Actual Demand Limit
GENUNIT_EMSTOP_rd	BV:4	COV	RO	Emergency Stop
GENUNIT_EMSTOP_wr	BV:41	CMD	RW	Emergency Stop
GENUNIT_FC_START_rd	BV:7	COV	RO	Start Free Cooling
GENUNIT_FC_START_wr	BV:43	CMD	RW	Start Free Cooling
GENUNIT_HC_SEL_rd	AV:2	COV	RO	Cooling/Heating Select
GENUNIT_HC_SEL_wr	AV:116	CMD	RW	Cooling/Heating Select
GENUNIT_ice_occ	BV:6	COV	RO	Ice Schedule Occupied
GENUNIT_KW_P	AV:5		RO	Motor Percent Kilowatts

APPENDIX D — NETWORK CONFIGURATION (cont)

Table C — BACnet Object Table (cont)

OBJECT NAME	OBJECT ID	OPTION	READ/WRITE	DESCRIPTION
GENUNIT_loc_occ	BV:5	COV	RO	Local Schedule Occupied
GENUNIT_statstop	BV:1	COV	RO	Deter Start Stop Command
HYDRLIC_CDW_FV	AV:45		RO	Cond Water Flow Value
HYDRLIC_cdw_pd	AV:46		RO	Condenser Water Delta P
HYDRLIC_CDWP	BV:27		RO	Condenser Water Pump
HYDRLIC_CHW_FV	AV:47		RO	Chilled Water Flow Value
HYDRLIC_chw_pd	AV:48		RO	Chilled Water Delta P
HYDRLIC_CHWP	BV:28		RO	Chilled Water Pump
INPUTS_DMP_ACT	AV:36		RO	Damper Valve Status Cl=0,Inter=1,Op=2,Fail=3
INPUTS_E_STOP	BV:11		RO	Emergency Stop Contact
INPUTS_FS_LOCK	BV:16		RO	Fire Security Interlock
INPUTS_GV1_ACT	AV:38		RO	Guide Vane 1 Actual Pos
INPUTS_HGBP_ACT	AV:37			EC Valve Status Cl=0,Inter=1,Op=2,Fail=3
INPUTS_HGBPACTP	AV:40		RO	Actual ECV Pos Per
INPUTS_HP_SW	BV:9		RO	High Pressure Switch
INPUTS_ICE_CON	BV:12		RO	Ice Build Contact
INPUTS_REM_CON	BV:10		RO	Remote Contact
INPUTS_REM_LOCK	BV:13		RO	Chiller Lockout
INPUTS_SAFETY	BV:14		RO	Spare Safety Input
INPUTS_STAR_AUX	BV:8		RO	Compressor Start Contact
INPUTS_STARTFLT	BV:15		RO	Starter Fault Feedback
INPUTS_TRIPR	BV:17		RO	ISM Trip Relay Status
INPUTS_VFD_ACT	AV:39		RO	Actual VFD Speed Per
LABONLY_gv1_fc	BV:36		RO	GV1 Forced
MAIN_MS_lag_s_s	BV:35		RO	Slave Start/Stop
MAIN_MS_lagstart	AV:90		RO	Lag Start Timer
MAIN_MS_lagstat	AV:89		RO	Slave Run Status
MAIN_MS_lagstop	AV:91		RO	Lag Stop Timer
MAIN_MS_lead_lag	AV:87		RO	Unit is Lead or Lag Disable=0, Lead=1, Lag=2
MAIN_MS_II_comm	BV:34		RO	Lead Lag Communication
MAIN_MS_II_fault	AV:88		RO	Master Slave Fault No Fault=0, Master=1 Slave=2, Both=3
MAIN_MS_II_hr_d	AV:94		RO	Lead/Lag Hours Delta
MAIN_MS_prefft	AV:92		RO	Prestart Fault Timer
MAIN_MS_pulltime	AV:93		RO	Pulldown Timer
MAIN_SRD_diff_alm	BV:33		RO	SRD Rotating Stall Alarm
MAIN_SRD_lift_1	AV:85		RO	VDO High Lift Load Line
MAIN_SRD_lift_2	AV:86		RO	VDO Low Lift Load Line
MAIN_SRD_lift_a	AV:84		RO	Actual Lift
MAISURGE_act_reg	AV:77		RO	Surge Region No=0, Low=1, High=2 Deadband=3, Noise=4
MAISURGE_dts_act	AV:78		RO	Actual Delta Tsat
MAISURGE_dts_cal	AV:79		RO	Calc Ref Delta Tsat
MAISURGE_sc	AV:80		RO	Surge Counts
MAISURGE_spc	AV:81		RO	Surge Protection Counts

APPENDIX D — NETWORK CONFIGURATION (cont)

Table C — BACnet Object Table (cont)

OBJECT NAME	OBJECT ID	OPTION	READ/WRITE	DESCRIPTION
MAISURGE_surg_act	AV:82		RO	Surge Prevention Active
MAISURGE_surg_pro	AV:83		RO	Surge Protection Active
OUTPUTS_ALE	BV:19		RO	Alert Relay
OUTPUTS_ALM	BV:18		RO	Alarm Relay
OUTPUTS_CHST_OUT	AV:41		RO	Chiller Stat Output mA
OUTPUTS_COMP_SR	BV:20		RO	Compressor Start Relay
OUTPUTS_exv_tgt	AV:42		RO	Oil EXV Target
OUTPUTS_GV1_DEC	BV:21		RO	Guide Vane 1 Decrease
OUTPUTS_GV1_INC	BV:22		RO	Guide Vane 1 Increase
OUTPUTS_hdpv_tgt	AV:44		RO	Head Pres Valve Tgt Pos
OUTPUTS_OIL_HEAT	BV:23		RO	Oil Heater Relay
OUTPUTS_OIL_PUMP	BV:24		RO	Oil Pump Relay
OUTPUTS_op_vfd_t	AV:43		RO	Oil Pump VFD Target
OUTPUTS_TFR_HIGH	BV:25		RO	Tower Fan Relay High
OUTPUTS_TFR_LOW	BV:26		RO	Tower Fan Relay Low
POWER_I_AMPS_A_I	AV:51		RO	Actual Line Current
POWER_I_AMPS_P_I	AV:52		RO	Percent Line Current
POWER_I_KW	AV:55		RO	Motor Kilowatts
POWER_I_POW_FACT	AV:56		RO	Motor Power Factor
POWER_I_VOLT_A	AV:53		RO	Actual Line Voltage
POWER_I_VOLT_P	AV:54		RO	Percent Line Voltage
POWER_O_alm_code	AV:67		RO	VFD Alarm Code
POWER_O_bus_volt	AV:59		RO	DC Bus Voltage
POWER_O_enc_temp	AV:64		RO	VFD Enclosure Temp
POWER_O_inv_temp	AV:65		RO	Inverter Temperature
POWER_O_lrtm_sw	BV:30		RO	LR Temp Switch
POWER_O_MOT_FREQ	AV:58		RO	Motor Actual Frequency
POWER_O_motor_kw	AV:62		RO	Motor Kilowatts
POWER_O_motor_pf	AV:61		RO	Motor Power Factor
POWER_O_motorkwh	AV:63		RO	Motor Kilowatt-Hours
POWER_O_prech_fd	BV:29		RO	Precharge Feedback
POWER_O_rec_temp	AV:66		RO	Rectifier Temperature
POWER_O_spd_fd	BV:31		RO	SPD Feedback
POWER_O_vfd_act	AV:60		RO	Actual VFD Speed Per
POWER_O_VFD_LOAD	AV:57		RO	VFD Load Current
POWER_O_VFDC_HI	BV:32		RO	High VFD Current
PRESSURE_COND_P	AV:31	COV, IR	RO	Condenser Pressure
PRESSURE_DIFF_P	AV:34	COV, IR	RO	Diffuser Pressure
PRESSURE_ECON_P	AV:32	COV, IR	RO	Economizer Pressure
PRESSURE_EVAP_P	AV:30	COV, IR	RO	Evaporator Pressure
PRESSURE_HEAD_P	AV:35	COV, IR	RO	Head Pressure Reference
PRESSURE_OIL_PD	AV:33	COV, IR	RO	Oil Pump Delta P
RUNTIME_C_STARTS	AV:49		RO	Compressor Starts Num
RUNTIME_SRV_HRS	AV:50		RO	After Service Hrs
SETPOINT_dem_base	AV:113		RW	Base Demand Limit
SETPOINT_ecdw_sp	AV:110		RW	Heating ECDW Setpoint
SETPOINT_ecw_sp	AV:108		RW	Cooling ECW Setpoint

APPENDIX D — NETWORK CONFIGURATION (cont)

Table C — BACnet Object Table (cont)

OBJECT NAME	OBJECT ID	OPTION	READ/WRITE	DESCRIPTION
SETPOINT_EWT_OPT	BV:39		RW	EWT Control Option
SETPOINT_ice_sp	AV:112		RW	Ice Build Setpoint
SETPOINT_lcdw_sp	AV:111		RW	Heating LCDW Setpoint
SETPOINT_lcw_sp	AV:109		RW	Cooling LCW Setpoint
TEMP_cond_app	AV:15	IR	RO	Condenser Approach
TEMP_COND_SAT	AV:16	COV, IR	RO	Cond Sat Refrig Temp
TEMP_DGT	AV:17	COV, IR	RO	Comp Discharge Temp
TEMP_DSH	AV:18		RO	Discharge Superheat
TEMP_ECDW	AV:10	COV, IR	RO	Entering Condenser Water
TEMP_ECW	AV:8	COV, IR	RO	Entering Chilled Water
TEMP_evap_app	AV:14	IR	RO	Evaporator Approach
TEMP_EVAP_SAT	AV:12	COV, IR	RO	Evap Sat Refrig Temp
TEMP_EVAP_T	AV:13	COV, IR	RO	Evap Refrig Liquid Temp
TEMP_LCDW	AV:11	COV, IR	RO	Leaving Condenser Water
TEMP_LCW	AV:9	COV, IR	RO	Leaving Chilled Water
TEMP_MTRB	AV:20	COV, IR	RO	Thrust Bearing Temp
TEMP_MTRB_OIL	AV:19	IR	RO	Thrust Bearing Oil Temp
TEMP_MTRB1	AV:21	COV, IR	RO	Low Speed ME Brg Temp
TEMP_MTRB2	AV:22	COV, IR	RO	Low Speed CE Brg Temp
TEMP_MTRB3	AV:23	COV, IR	RO	High Speed ME Brg Temp
TEMP_MTRB4	AV:24	COV, IR	RO	High Speed CE Brg Temp
TEMP_MTRW1	AV:25	COV, IR	RO	Motor Winding 1 Temp
TEMP_MTRW2	AV:26	COV, IR	RO	Motor Winding 2 Temp
TEMP_MTRW3	AV:27	COV, IR	RO	Motor Winding 3 Temp
TEMP_OILT_DIS	AV:29	COV, IR	RO	Oil Supply Temp
TEMP_OILT_SMP	AV:28	COV, IR	RO	Oil Sump Temp

LEGEND
AV — Analog Value
BV — Binary Value
CMD — Commandable
COV — Change of Value
IR — Intrinsic Reporting
RO — Read Only
RW — Read/Write

APPENDIX E — ISM WIRING DIAGRAMS (cont)

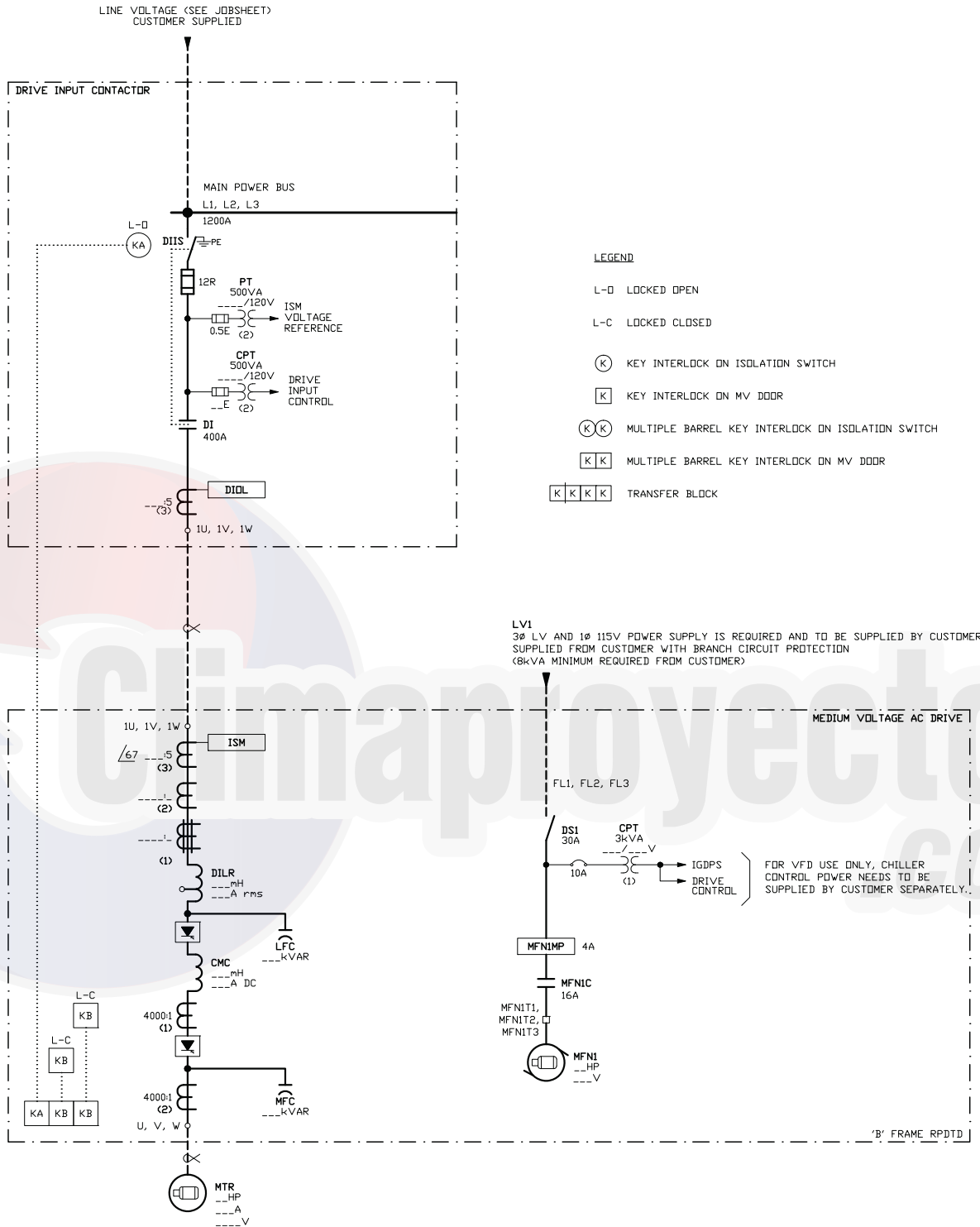

Fig. T — One Line Diagram of Medium Voltage VFD Power (Typical)

APPENDIX E — ISM WIRING DIAGRAMS (cont)

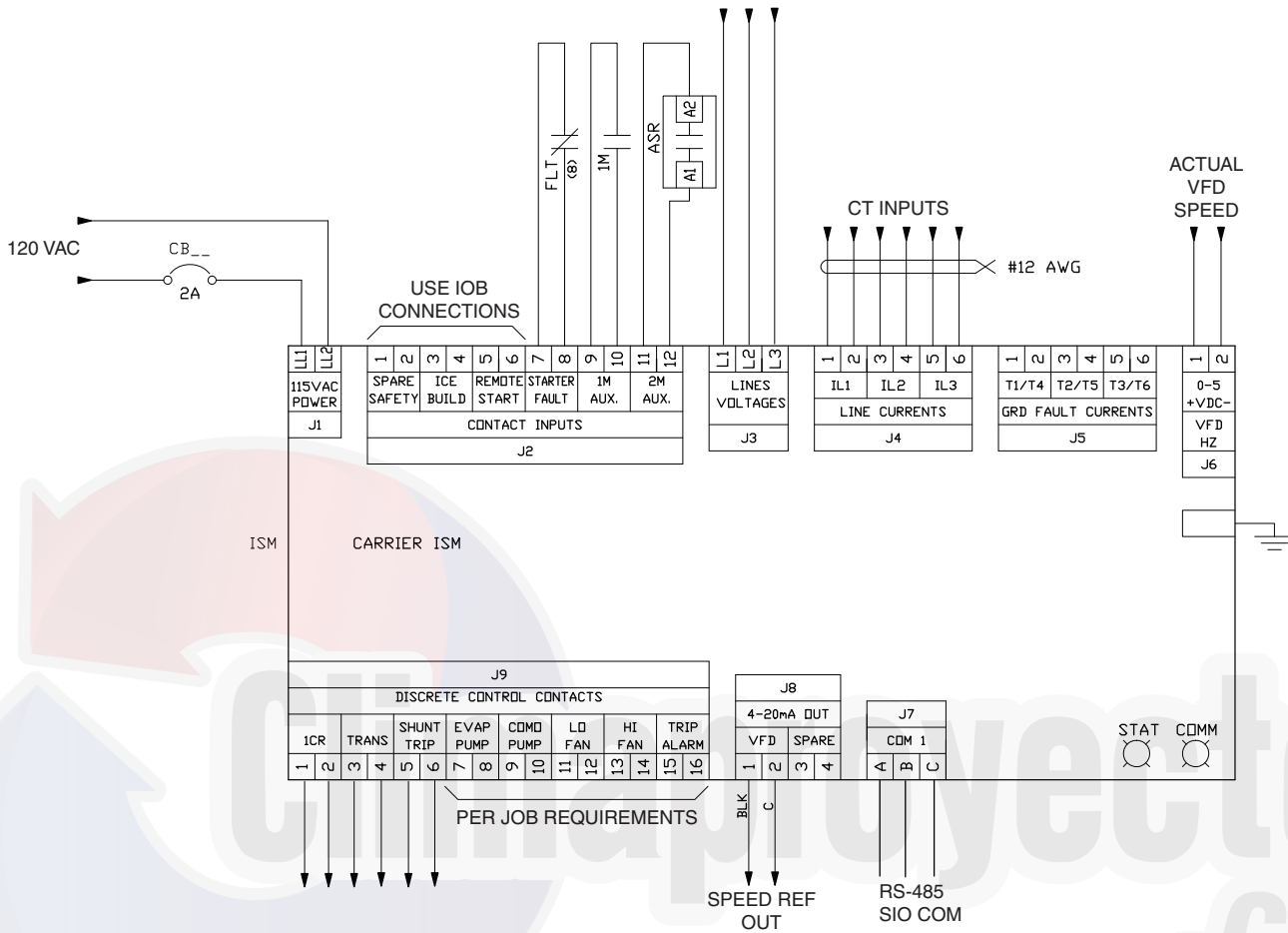

Fig. U — Medium Voltage VFD ISM I/O (Typical)

APPENDIX E — ISM WIRING DIAGRAMS (cont)

FOR CUSTOMER SUPPLIED CONNECTION POINTS
USE MOLEX CONNECTOR AND FEMALE PIN SHOWN HERE.

CUSTOMER OPTIONAL PLUG CONNECTOR P/N		
ITEM	MOLEX P/N	CARRIER P/N
PIN REMOVAL TOOL	11-03-0044	---
FEMALE PIN	46018-1541	19XF05002401
J1 PLUG (2 PIN)	39-01-2025	19XF05002201
J3 PLUG (4 PIN)	39-01-2045	19XF05002202
J11 PLUG (8PIN-BLACK)	50-36-1713	19XF05002207
J12 PLUG (10 PIN)	39-01-2105	19XF05002205
J13 PLUG (8 PIN)	39-01-2085	19XF05002204
J14 PLUG (6 PIN)	39-01-2065	19XF05002203
J15 PLUG (12 PIN)	39-01-2125	19XF05002206
J16 PLUG (8 PIN)	39-01-2085	19XF05002204

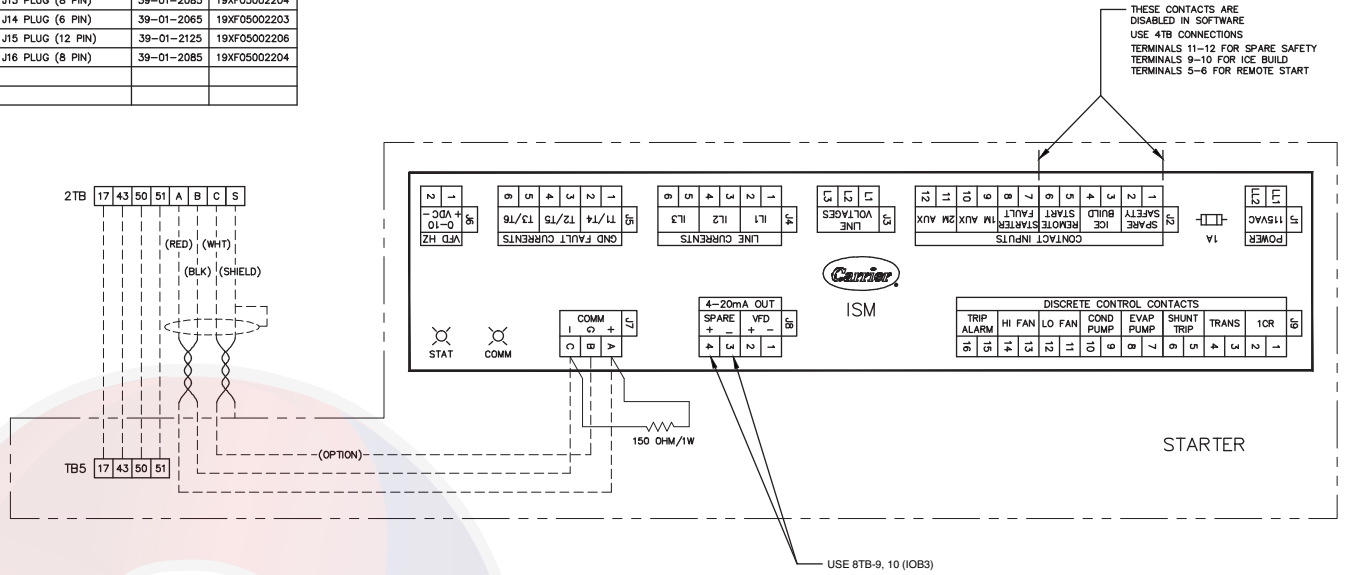

Fig. V — Starter Field Wiring Schematic

