



X-Power Full DC Inverter Super Plus Series



High Efficiency

High EER and COP

DC compressors and fan motors together with a high-efficiency heat exchanger combine to give the Super Plus Series top-class energy efficiency in cooling and heating.

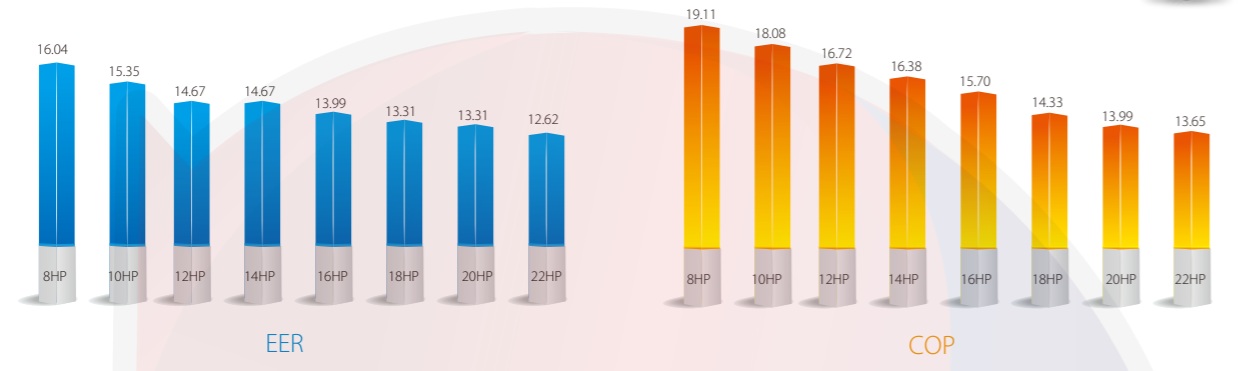

All DC Inverter Compressors

At the heart of the Super Plus Series outdoor unit lies a world-leading DC inverter scroll compressor. The compressor's innovative design and numerous high performance features reduce power consumption by 25%.



All DC Fan Motors

Fan speed is controlled according to the system pressure and system load, minimizing energy consumption.

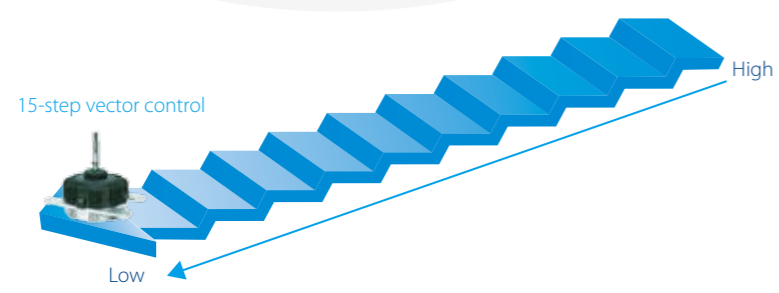

High Efficiency Heat Exchanger

Newly designed fins enlarge the heat exchange area and decrease air resistance, enhance heat exchange performance and save more energy.
 Hydrophilic fins and internally threaded copper pipes optimize heat exchange efficiency.
 δ design increases the degree of liquefaction in the condenser and improves heat-exchange efficiency.

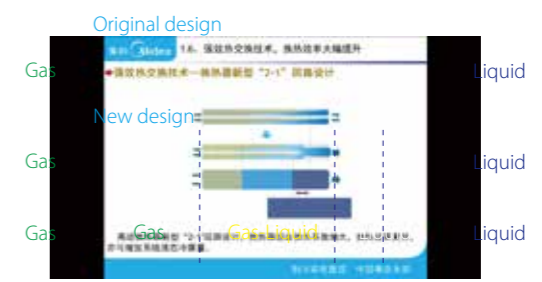
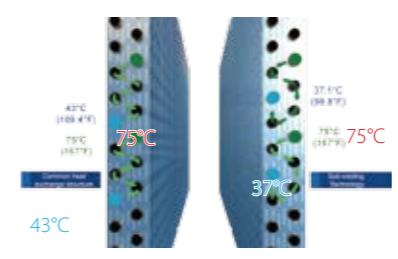
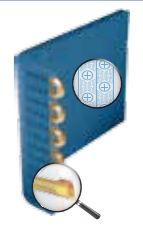

Newly Designed Fan

A new blade with sharp edges and a slight curve increases the airflow rate and lowers vibration and airflow resistance.



Precise Control

Multiple solenoid valves ensure precise temperature control, stable and efficient operation, and improved comfort.

Dual EXVs Control

Dual EXVs in one system, each EXV part achieves 480 Pulse rate to precisely adjust refrigerant flow.

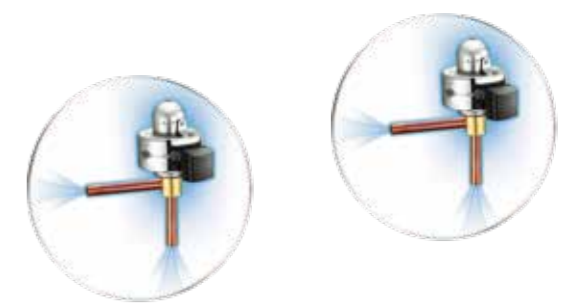

Wide Application Range

Wide Capacity Range

The Super Plus series has an extensive range of capacities, from 8HP to 88HP(max.72HP for tropical model combination), meeting all customer requirements from small to large buildings.



Wide Range of Indoor Units

Carrier provides 12 types and more than 100 models of VRF indoor units to meet varied customer requirements in a wide range of locations including shopping malls, hospitals, office buildings, hotels and airports.

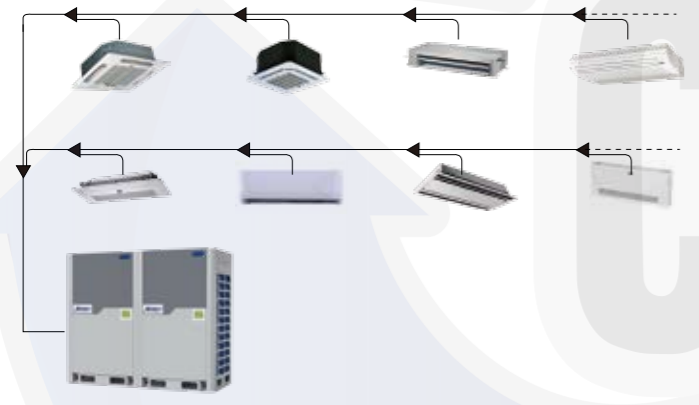

Wide Operation Range

Super Plus Series operates stably under extreme conditions, ranging from minus 20° C to 48° C. (-20° C to 54° C for tropical model).

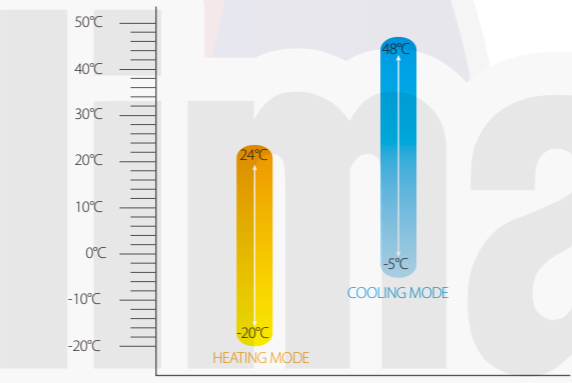

Long Piping Capability

Piping length	Capability
Total piping length	1000m
Longest length - actual (equivalent)	175m (200m)
Longest length after first branch	90m*
Largest height difference between indoor and outdoor units - ODU up (down)	90m (110m)
Largest height difference between indoor units	30m

*The longest length after first branch is 40m as standard but can be extended to up to 90m under certain conditions. Please contact your local Carrier sales companies for further information.

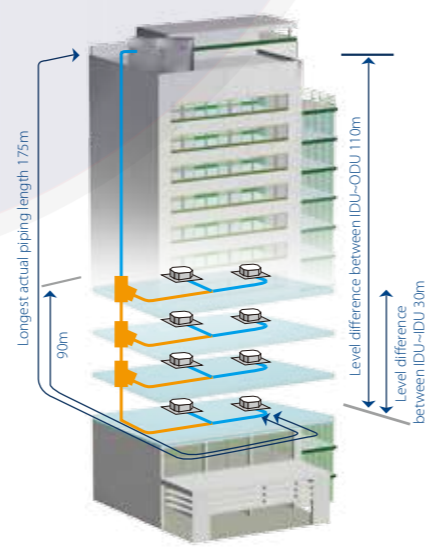

High Reliability

Duty Cycling

Duty cycling equalizes the running time of the outdoor units in a multiple-unit system and of the compressors in each unit, significantly extending compressor lifespan.



Backup

In a multi-unit system, if one module fails, the other modules provide backup so that the system can continue operating.



Precise Oil Control Technology

Five stages of oil control technology ensure all outdoor compressor oil is always kept at a safe level, eliminating any compressor oil shortage problems.

- The 1st stage:** Compressor internal oil separation.
- The 2nd stage:** High-efficiency centrifugal oil separator (with separation efficiency of up to 99%) ensures that oil is separated from the discharge gas and returned to the compressors in a timely fashion.
- The 3rd stage:** Oil balance pipes between compressors ensure even oil distribution to keep compressors running normally.
- The 4th stage:** Oil balance pipes among modules ensure even oil distribution among modules.
- The 5th stage:** Auto oil return program monitors the running time and system status to ensure reliable oil return.

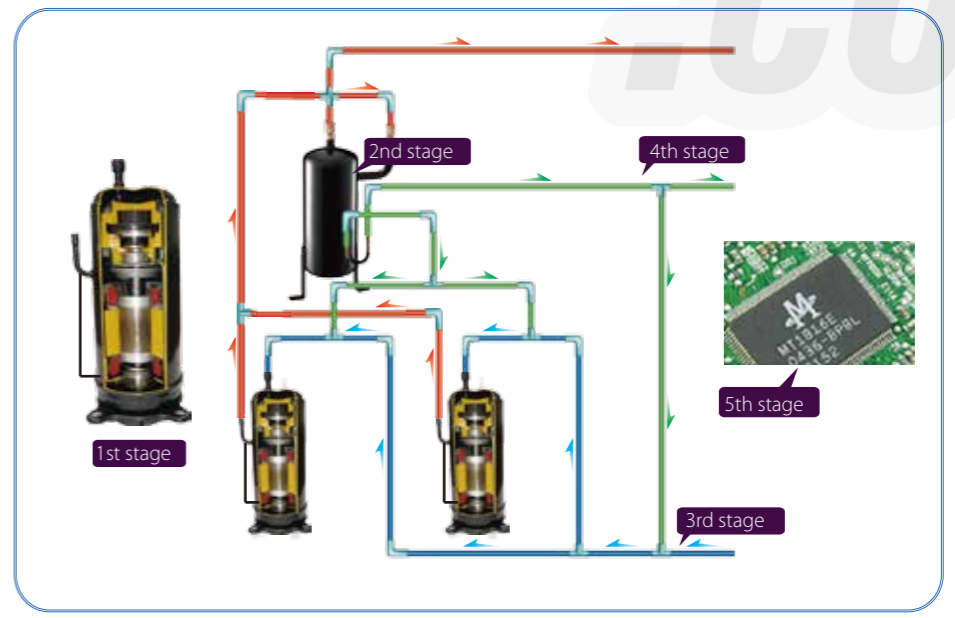

Enhanced Comfort

Night Silent Mode

The night silent mode feature, which is easily configured on the outdoor unit's PCB, includes various scheduling options that can be used to reduce noise levels at times when low noise operation is required.

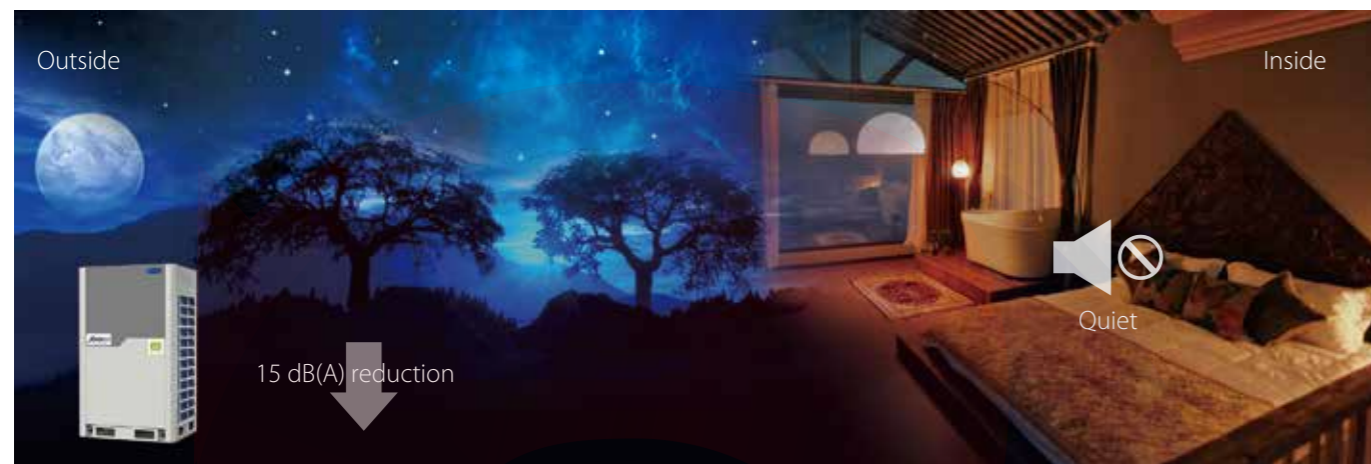

Intelligent Defrosting Technology

The intelligent defrosting program calculates the time required for defrosting according to the actual system status, eliminating heat losses from unnecessary defrosting. A specialized defrosting valve reduces time required for defrosting to as little as four minutes.

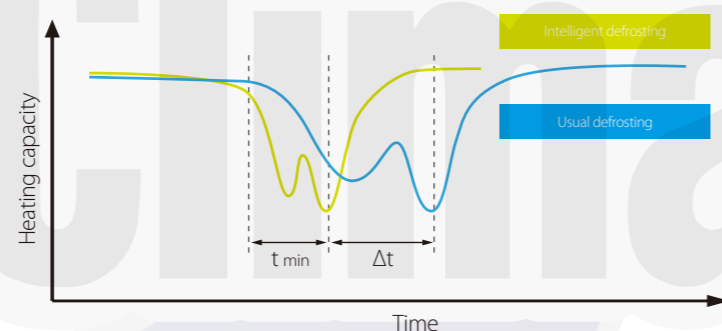

Rapid Cooling or Heating

The DC inverter compressor reaches full capacity rapidly, providing quicker cooling or heating with lower levels of temperature fluctuation during the cooling/heating operation.

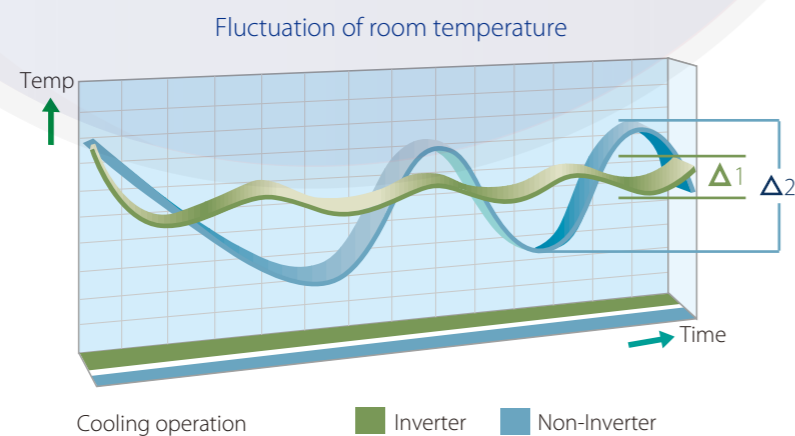

Anti-corrosion Protection

Outdoor units are given anti-corrosion treatment for non-extreme conditions as standard and can also be customized with heavy anti-corrosion treatment on steel sheets, grills, coil fins, electric control box case and screws/bolts for surface protection against corrosive air, acid rain and saline air (for installations in coastal regions) to extend overall useful life.

The integrity of the anti-corrosion treatment is ensured by subjecting major components and parts to salt mist testing, moisture and heating testing and light aging testing.



Heat Exchanger Aluminum Foil

Standard products:
72h of neutral salt mist

Heavy anti-corrosion products:
1000h of neutral salt mist
140h of acid salt mist

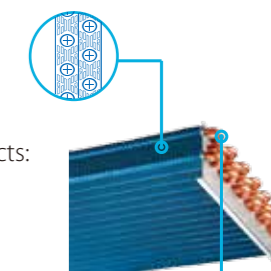

Motor

Standard products:
72h of neutral salt mist

Heavy anti-corrosion products:
240h of neutral salt mist



Copper

Standard products:
24h of neutral salt mist

Heavy anti-corrosion products:
120h of neutral salt mist



Painted Sheet Metal

Standard products:
500h of neutral salt mist
1000h of moisture and heating test
500h of light aging test

Heavy anti-corrosion products:
1000h of neutral salt mist
2000h of moisture and heating test
720h of light aging test



Electric Control Box Case

Standard products:
96h of neutral salt mist

Heavy anti-corrosion products:
240h of neutral salt mist



Screws / Bolts / Gaskets

Standard products:
300h of neutral salt mist

Heavy anti-corrosion products:
720h of neutral salt mist



Compressor / Motor Bolts

Standard products:
72h of neutral salt mist

Heavy anti-corrosion products:
168h of neutral salt mist

Specifications



8-12HP

Model name		38VF008H119015 38VF008H117015	38VF010H119015 38VF010H117015	38VF012H119015 38VF012H117015	38VF014H119015 38VF014H117015	
Power supply		V/Ph/Hz 380-415/3/50(60) 220/3/60				
Cooling	Capacity	kW 25.2	28.0	33.5	40.0	
		kBtu/h 86.0	95.6	114.3	136.5	
	Power input	kW 5.36	6.22	7.79	9.30	
	EER	KBtu/h/kW 16.04	15.35	14.67	14.67	
	IPLV	KBtu/h/kW 27.30	27.80	26.61	26.27	
Heating	Capacity	kW 27.0	31.5	37.5	45.0	
		kBtu/h 92.1	107.5	128.0	153.6	
	Power input	kW 4.82	5.94	7.65	9.38	
	COP	KBtu/h/kW 19.11	18.08	16.72	16.38	
Connectable indoor unit	Total capacity	50~130% of outdoor unit capacity				
	Max. quantity	13	16	20	23	
Compressor	Type	DC inverter				
	Quantity	1	1	1	2	
	Crankcase heater	W 27.6x2	27.6x2	27.6x2	27.6x4	
	Refrigerant oil type	FVC68D				
	Refrigerant oil charge	ml(gal.) 500(0.132)	500(0.132)	500(0.132)	500(0.132)x2	
Fan motor	Type	DC motor				
	Quantity	1	1	1	2	
	Insulation class	E				
	Safe class	IP23				
	Static pressure	Pa(in. W.G.)	0-20(0-0.08) (default)			
Pa(in. W.G.)		20-60(0.08-0.24) (customized)				
Fan	Material	Plastic				
	Type	Axial				
	Quantity	1	1	1	2	
Outdoor coil	Number of rows	2	2	3	2	
	Fin type	Hydrophilic aluminum				
	Tube OD	mm(in.)	Φ7.94(Φ5/16)			
	Tube type	Inner-grooved				
	Number of circuits	22				
Refrigerant	Type	R410A				
	Factory charging	kg(lbs.) 9(20)	9(20)	11(24)	13(29)	
Pipe connection	Liquid pipe	mm(in.)	Φ12.7(Φ1/2)		Φ15.9(Φ5/8)	
	Gas pipe	mm(in.)	Φ25.4(Φ1)		Φ28.6(Φ1-1/8)	
	Oil balance pipe	mm(in.)	Φ8(Φ5/16)			
Design pressure(High/low)	MPa	4.4/2.6				
	PSI	640/380				
Air flow rate	m ³ /h	12000	12000	12000	14000	
Sound pressure level	dB(A)	58	59	60	62	
Net dimension (WxHxD)	mm	990x1635x790			1340x1635x790	
	inch	39x64-3/8x31-1/8			52-3/4x64-3/8x31-1/8	
Packing size (WxHxD)	mm	1055x1805x855			1405x1805x855	
	inch	41-1/2x71-1/16x33-5/8			55-3/8x71-1/16x33-5/8	
Net weight	kg(lbs.)	219(483)	219(483)	237(523)	297(655)	
Gross weight	kg(lbs.)	234(516)	234(516)	252(556)	315(695)	
Operating temperature range	°C(°F)	Cooling: -5~48(23~118.4); Heating: -20~24(-4~75.2)				

Notes:

- Indoor temperature 27°C (80.6°F) DB, 19°C (66.2°F) WB; outdoor temperature 35°C (95.0°F) DB; equivalent refrigerant piping length 7.5m (24.6ft.) with zero level difference.
- Indoor temperature 20°C (68.0°F) DB; outdoor temperature 7°C (44.6°F) DB, 6°C (42.8°F) WB; equivalent refrigerant piping length 7.5m (24.6ft.) with zero level difference.
- Diameters given are those of the unit's stop valve.
- Sound pressure level is measured at a position 1m (3.28ft) in front of the unit and 1.3m (4.3ft) above the floor in a semi-anechoic chamber.
- The data in this catalogue may be changed without notice for further improvement on quality and performance.
- IPLV are complied with GB 21454 - 2008.
- Super plus series will not launch in Mexico/Colombia/Puerto Rico/Costa Rica/Salvador/Dominica/Honduras/Bolivia.



14-22HP

Model name		38VF016H119015 38VF016H117015	38VF018H119015 38VF018H117015	38VF020H119015 38VF020H117015	38VF022H119015 38VF022H117015
Power supply		V/Ph/Hz 380-415/3/50(60) 220/3/60			
Cooling	Capacity	kW 45.0	50.0	56.0	61.5
		kBtu/h 153.6	170.6	191.1	209.9
	Power input	kW 10.98	12.82	14.51	16.44
	EER	KBtu/h/kW 13.99	13.31	13.31	12.62
	IPLV	KBtu/h/kW 25.93	25.93	25.59	25.25
Heating	Capacity	kW 50.0	56.0	63.0	69.0
		kBtu/h 170.6	191.1	215.0	235.5
	Power input	kW 10.87	13.18	15.29	17.12
	COP	KBtu/h/kW 15.70	14.33	13.99	13.65
Connectable indoor unit	Total capacity	50~130% of outdoor unit capacity			
	Max. quantity	26	29	33	36
Compressor	Type	DC inverter			
	Quantity	2			
	Crankcase heater	W 27.6x4			
	Refrigerant oil type	FVC68D			
	Refrigerant oil charge	ml(gal.) 500(0.132)x2			
Fan motor	Type	DC motor			
	Quantity	2			
	Insulation class	E			
	Safe class	IP23			
	Static pressure	Pa(in. W.G.)	0-20(0-0.08) (default)		
Pa(in. W.G.)		20-60(0.08-0.24) (customized)			
Fan	Material	Plastic			
	Type	Axial			
	Quantity	2			
Outdoor coil	Number of rows	2	2	3	3
	Fin type	Hydrophilic aluminum			
	Tube OD	mm(in.)	Φ7.94(Φ5/16)		
	Tube type	Inner-grooved			
	Number of circuits	22			
Refrigerant	Type	R410A			
	Factory charging	kg(lbs.) 13(29)	13(29)	16(35)	16(35)
Pipe connection	Liquid pipe	mm(in.)	Φ15.9(Φ5/8)		Φ19.1(Φ3/4)
	Gas pipe	mm(in.)	Φ31.8(Φ1-1/4)		Φ31.8(Φ1-1/4)
	Oil balance pipe	mm(in.)	Φ8(Φ5/16)		
Design pressure(High/low)	MPa	4.4/2.6			
	PSI	640/380			
Air flow rate	m ³ /h	14000	16000	16000	16000
Sound pressure level	dB(A)	62	63	63	63
Net dimension (WxHxD)	mm	1340x1635x790			
	inch	52-3/4x64-3/8x31-1/8			
Packing size (WxHxD)	mm	1405x1805x855			
	inch	55-3/8x71-1/16x33-5/8			
Net weight	kg(lbs.)	297(655)	305(673)	340(750)	340(750)
Gross weight	kg(lbs.)	315(695)	323(712)	358(790)	358(790)
Operating temperature range	°C(°F)	Cooling: -5~48(23~118.4); Heating: -20~24(-4~75.2)			

Notes:

- Indoor temperature 27°C (80.6°F) DB, 19°C (66.2°F) WB; outdoor temperature 35°C (95.0°F) DB; equivalent refrigerant piping length 7.5m (24.6ft.) with zero level difference.
- Indoor temperature 20°C (68.0°F) DB; outdoor temperature 7°C (44.6°F) DB, 6°C (42.8°F) WB; equivalent refrigerant piping length 7.5m (24.6ft.) with zero level difference.
- Diameters given are those of the unit's stop valve.
- Sound pressure level is measured at a position 1m (3.28ft) in front of the unit and 1.3m (4.3ft) above the floor in a semi-anechoic chamber.
- The data in this catalogue may be changed without notice for further improvement on quality and performance.
- IPLV are complied with GB 21454 - 2008.
- Super plus series will not launch in Mexico/Colombia/Puerto Rico/Costa Rica/Salvador/Dominica/Honduras/Bolivia.

Recommended combination table

Model	No. of Outdoor Units	No. of Compressors	Outdoor Unit Combination								Max No. of Connectable Indoor Unit	Capacity			
			8	10	12	14	16	18	20	22		Cooling		Heating	
												kW	kBtu/h	kW	kBtu/h
8	1	1	•								13	25.2	86.0	27	92.1
10	1	1		•							16	28	95.5	31.5	107.5
12	1	1			•						20	33.5	114.3	37.5	128.0
14	1	2				•					23	40	136.5	45	153.5
16	1	2					•				26	45	153.5	50	170.6
18	1	2						•			29	50	170.6	56	191.1
20	1	2							•		33	56	191.1	63	215.0
22	1	2								•	36	61.5	209.8	69	235.4
24	2	2			••						39	67	228.6	75	255.9
26	2	3		•				•			43	73	249.1	81.5	278.1
28	2	3		•					•		46	78	266.1	87.5	298.6
30	2	3		•						•	50	84	286.6	94.5	322.4
32	2	3		•						•	53	89.5	305.4	100.5	342.9
34	2	3			•					•	56	95	324.1	106.5	363.4
36	2	4							••		59	100	341.2	112	382.1
38	2	4						•		•	63	106.5	363.4	119	406.0
40	2	4							•	•	64	111.5	380.4	125	426.5
42	2	4							•	•	64	117.5	400.9	132	450.4
44	2	4								••	64	123	419.7	138	470.9
46	3	4			••					•	64	128.5	438.4	144	491.3
48	3	5		•				•		•	64	134.5	458.9	150.5	513.5
50	3	5		•					•	•	64	139.5	476.0	156.5	534.0
52	3	5		•					•	•	64	145.5	496.4	163.5	557.9
54	3	5		•						••	64	151	515.2	169.5	578.3
56	3	5			•					••	64	156.5	534.0	175.5	598.8
58	3	6							••	•	64	161.5	551.0	181	617.6
60	3	6						•		••	64	168	573.2	188	641.5
62	3	6							•	••	64	173	590.3	194	661.9
64	3	6							•	••	64	179	610.7	201	685.8
66	3	6								•••	64	184.5	629.5	207	706.3
68	4	6			••					••	64	190	648.3	213	726.8
70	4	7		•				•		••	64	196	668.8	219.5	748.9
72	4	7		•					•	••	64	201	685.8	225.5	769.4
74	4	7		•						•	64	207	706.3	232.5	793.3
76	4	7		•						•••	64	212.5	725.1	238.5	813.8
78	4	7			•					•••	64	218	743.8	244.5	834.2
80	4	8							••	••	64	223	760.9	250	853.0
82	4	8						•		•••	64	229.5	783.1	257	876.9
84	4	8							•	•••	64	234.5	800.1	263	897.4
86	4	8							•	•••	64	240.5	820.6	270	921.2
88	4	8								••••	64	246	839.4	276	941.7

Notes:

Capacities are based on the following conditions:

Cooling: Indoor temperature 27°C(80.6°F) DB/19°C(66.2°F) WB; Outdoor temperature 35°C(95°F) DB/24°C(75.2°F) WB

Heating: Indoor temperature 20°C(68°F) DB/15°C(59°F) WB; Outdoor temperature 7°C(44.6°F) DB/6°C(42.8°F) WB

Piping length: Interconnecting piping length is 7.5m(24.6ft), level difference is zero.

The above combination models are factory-recommended models

Dimensions

Body dimension

Unit: in.(mm)

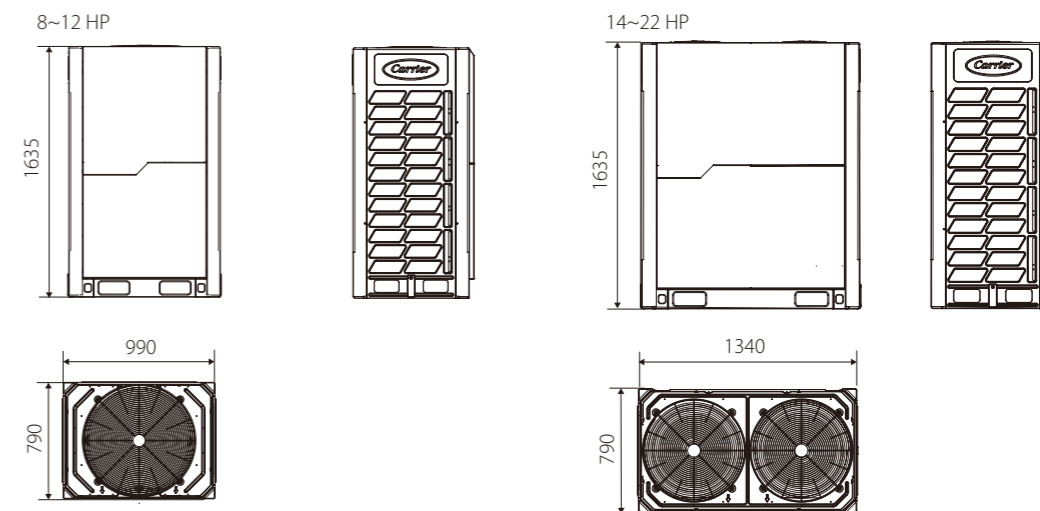

Installation dimension

Unit: in.(mm)

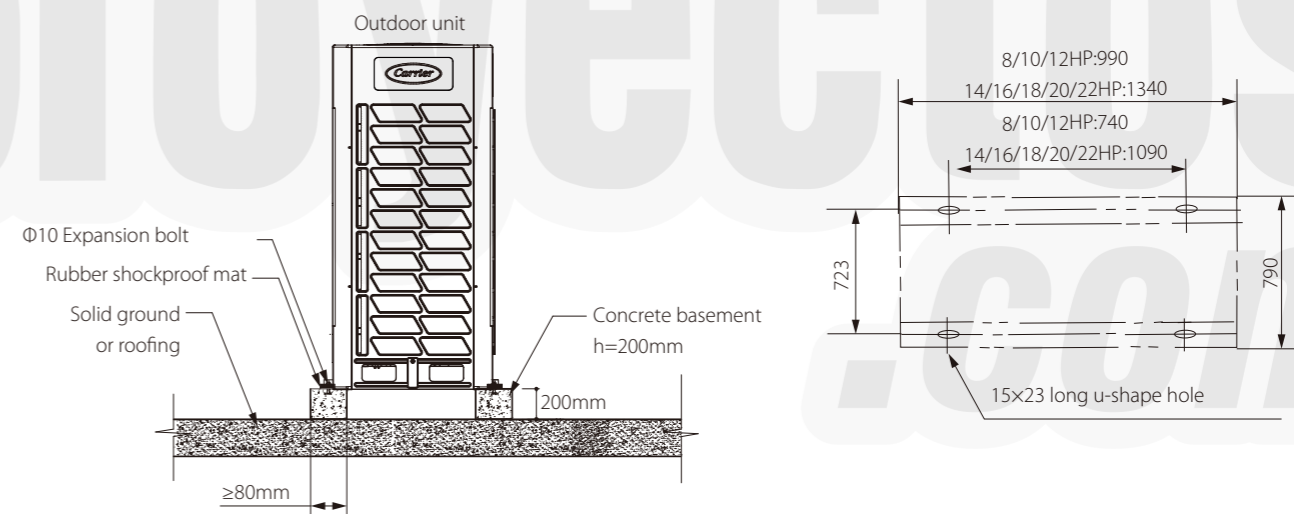

X-Power Full Inverter Super S Series

Features

Wide Application Range

Wide range of outdoor units

The outdoor units capacity range from 8HP up to 72HP in 2HP increment. Maximum 64 indoor units with capacity up to 130% of total outdoor units can be connected in one refrigeration system.

8, 10HP



12, 14, 16HP



18HP



18, 20, 22, 24, 26, 28, 30, 32HP



34,36, 38, 40, 42, 44, 46, 48HP



50, 52, 54, 56, 58, 60, 62, 64HP



66, 68, 70, 72HP



Large connectable indoor units quantity

The large quantity of connectable units is suitable for large buildings and projects.

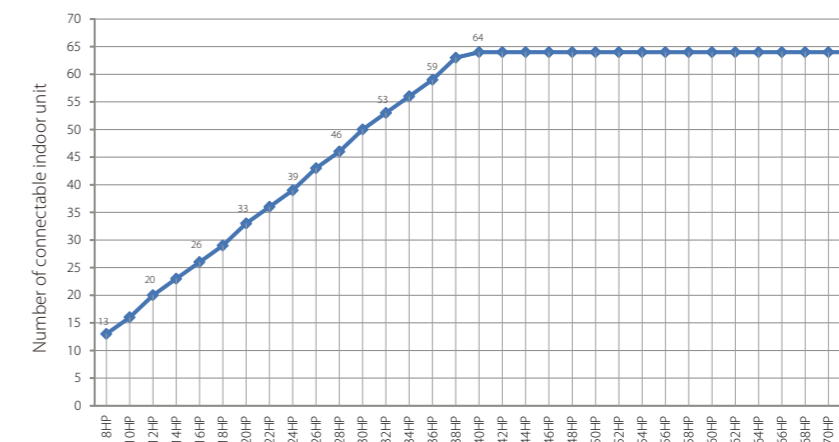

Wide operation range

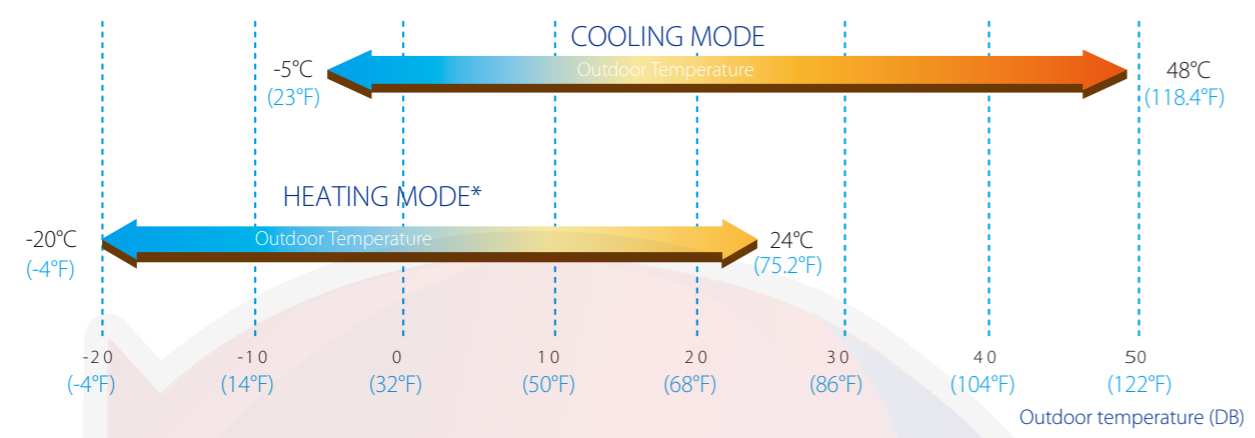

The X-Power series system operates stably at extreme temperatures ranging from -20°C(-4°F) to 48°C(118.4°F).

Long piping length

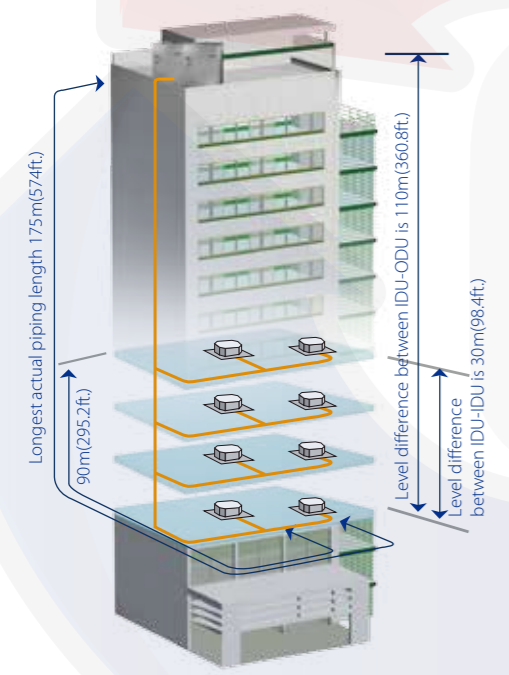

		Permitted value		
		m	ft.	
Piping length	Total piping length (Actual)	1000*	3280*	
	Longest piping	Actual length	175	574
		Equivalent length	200	656
	Equivalent piping length from the farthest IDU to the first indoor branch joint	40/90*	131.2/295.2*	
Level difference	Level difference between IDU~ODU	Outdoor unit up	70	229.6
		Outdoor unit down	110	360.8
	Level difference between IDU-IDU	30	98.4	

*Total pipe length is equal to two times pipe length plus.
 *When the piping length from the farthest IDU to the first indoor branch joint is more than 40m(131.2ft.), it needs to meet specific conditions according to the installation part of the technical manual to achieve 90m(295.2ft.).

High external static pressure

Max. 60Pa(0.24" W.G.) external static pressure can be customized for the outdoor unit, flexible to build-in installation.
 A standard 0-20Pa(0-0.08" W.G.) external static pressure is equipped by default for all outdoor units. 0-40Pa(0-0.16" W.G.) external static pressure can be customized for 8, 10, 14, 16HP outdoor units, and 0-60Pa(0-24" W.G.) can be customized for 12HP outdoor unit.

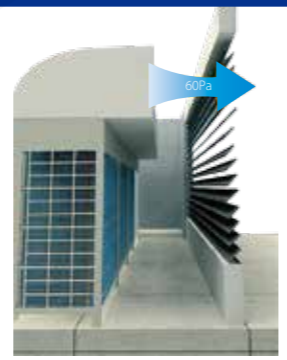

High Efficiency

High COP/EER values

The cooling EER up to 14.64 and the heating COP up to 14.98 in the 8HP category.

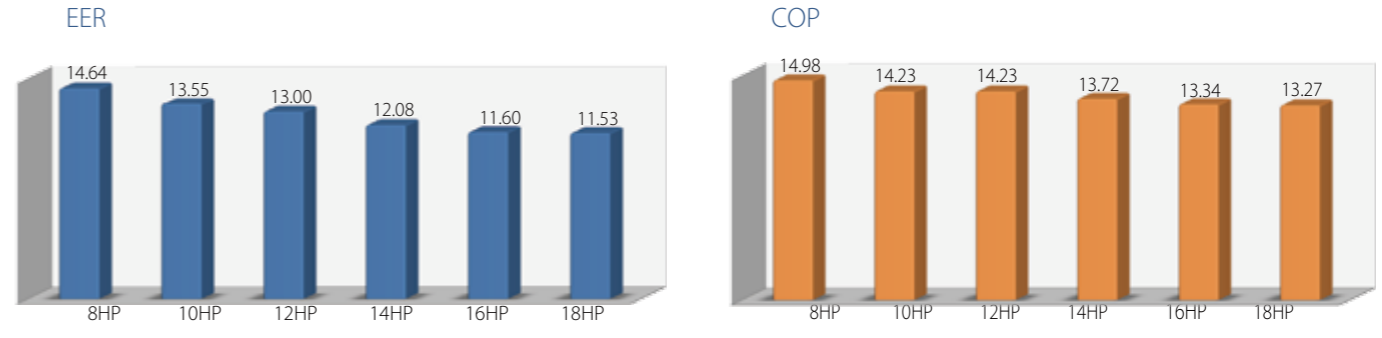

All DC inverter technology

All DC inverter compressors make the capacity output better distributed, and always work at 60-120Hz which is the most efficient range. It makes the efficiency more than 30% higher than the normal.



- New structure enhances mid-frequency performance
- Specially designed scroll profile for R410A
- More compact, weight reduced by 50%
- Advanced permanent magnet DC motor improves the low frequency band performance

All DC Inverter Compressors

All DC Fan Motors

According to the running load and system pressure, the system controls the speed of DC fan to achieve the minimum energy consumption and best performance.

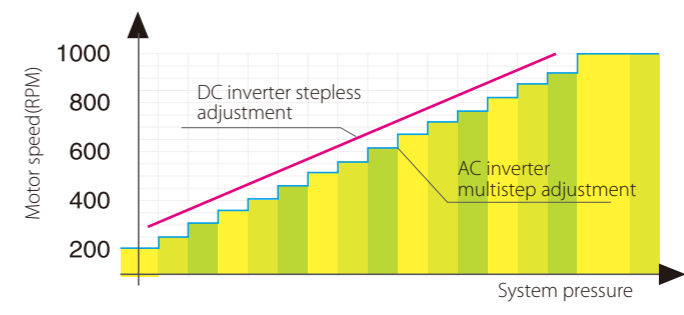

High performance heat exchanger

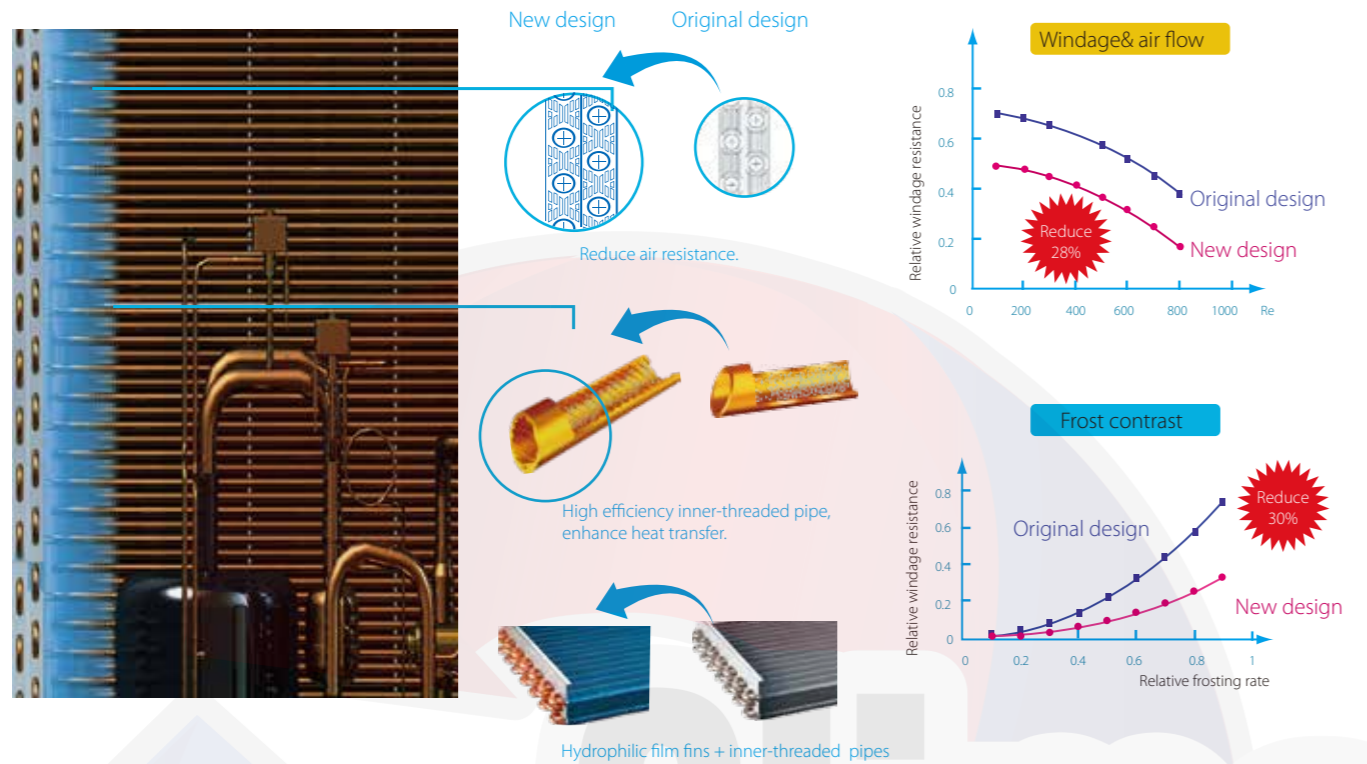

- The new designed window fins enlarge the heat-exchanging area, decrease the air resistance, save more power and enhance heat exchange performance.
- Hydrophilic film fins and inner-threaded copper pipes optimize heat exchange efficiency.

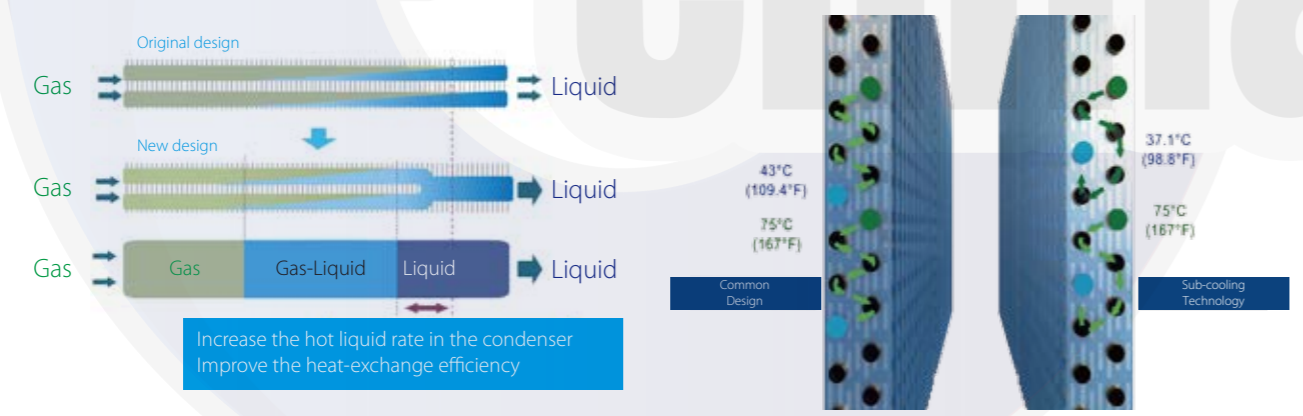

- Innovative designed high efficiency heat exchanger, which can reach up to 12°C(21.6°F) subcooling degree, reduces the system resistance and improves reliability.
- When the outdoor temperature is 35°C(95°F), the refrigerant can be cooled down to 37.1°C(98.8°F), thus achieving high heat-exchanging efficiency with only 2.1°C(3.8°F) temperature difference.

Enhanced Comfort

Night silent operation mode

High comfort outdoor unit's multi-choice of silent mode during the night. Super silent operation mode can reduce sound level further, minimum 45dB (A).

Night silent operation will be activated X hours after the peak temperature during daytime, and it will go back to normal operation after Y hours.

-Mode 1→X: 6 hours, Y: 10 hours
-Mode 2→X: 8 hours, Y: 10 hours
-Mode 3→X: 6 hours, Y: 12 hours
-Mode 4→X: 8 hours, Y: 8 hours

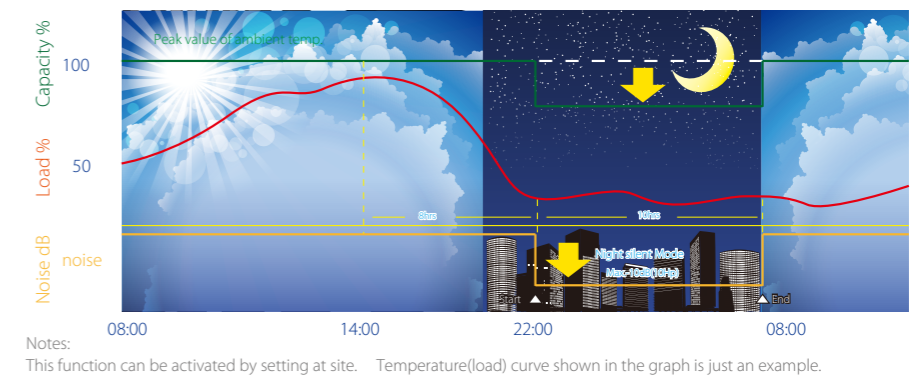

Intelligent defrosting technology

Intelligent defrosting program will judge the defrosting time according to the system real requirement, reduce the heating loss by unnecessary defrosting and make the indoor side more comfortable. Defrosting time can be shortened to 4 min. due to the specialized defrosting valve.

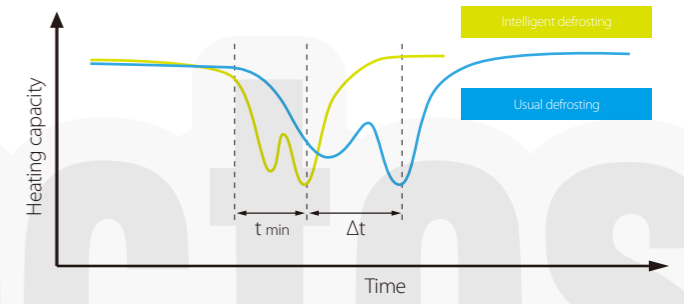

Easier Installation and Service

Simple signal line connection

Centralized controller (CRF-10-CM or CRF-30-CM) can be connected from indoor side or outdoor side (XYE terminals) at will. Only one group of communication wire of PQE, achieved both of communication for indoor & outdoor unit. It's more convenient for communication wiring.

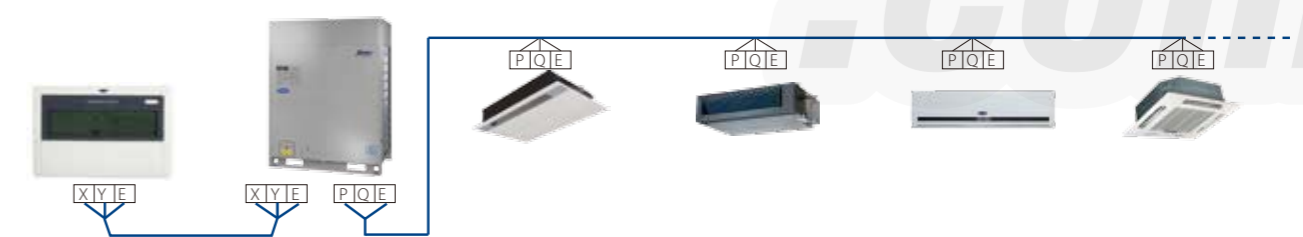

Auto addressing

Outdoor unit can distribute addresses for indoor unit automatically. Wireless and wired controllers can query and modify each indoor unit's address.

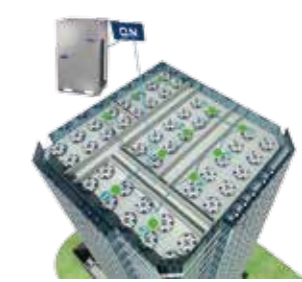

Specifications

X-Power Full Inverter Super S Series

Model			38VF008H117010 38VF008H117010-E 38VF008H118010	38VF010H117010 38VF010H117010-E 38VF010H118010	38VF012H117010 38VF012H117010-E 38VF012H118010	
Power supply		V-Ph-Hz	208/230V 3~60Hz 220V 3~50Hz	208/230V 3~60Hz 220V 3~50Hz	208/230V 3~60Hz 220V 3~50Hz	
Cooling (*1)	Capacity	kW	25.2	28	33.5	
		RT	7.2	8	9.6	
	Input	kW	5.88	7.05	8.79	
	EER	KBtu/h/kW	14.64	13.55	13.00	
	IPLV	KBtu/h/kW	19.11	19.45	19.11	
Heating (*2)	Capacity	kW	27	31.5	37.5	
		RT	7.7	9.0	10.7	
	Input	kW	6.15	7.55	8.99	
COP	KBtu/h/kW	14.98	14.23	14.23		
Connectable indoor unit	Total capacity	%	50-130%	50-130%	50-130%	
	Max.quantity		13	16	20	
Outdoor sound level (*3)		dB(A)	57	57	59	
Pipe connections	Liquid side	mm	Φ12.7	Φ12.7	Φ15.9	
	Gas side	mm	Φ25.4	Φ25.4	Φ31.8	
	Oil balance pipe	mm	Φ6.35	Φ6.35	Φ6.35	
Compressor	Quantities		1	1	1+1	
	Type		DC	DC	DC	
	Capacity	Btu/h(W)	31.59	31.59	31.59+11.80	
		Btu/h	107800	107800	107800+40300	
	Input	W	10340	10340	10340+3665	
	Crankcase	W	27.6x2	27.6x2	27.6x4	
	Refrigerant oil	Type	FVC68D	FVC68D	FVC68D	
ml		500	500	500+500		
Fan Motor	Type		DC motor	DC motor	DC motor	
	Quantities		1	1	2	
	Air flow rate	CFM	6620	6620	7660	
		m ³ /h	11242	11242	13000	
	Output	W	420(rated)	420(rated)	210x2(rated)	
ESP.	pa	0-20 (Default) 0-40 (Customize)	0-20 (Default) 0-40 (Customize)	0-20 (Default) 0-60 (Customize)		
Charged refrigerant	Dimension(WxHxD)		mm	960x1615x765	960x1615x765	1250x1615x765
	Packing(WxHxD)		mm	1025x1790x830	1025x1790x830	1305x1790x820
	Net/Gross weight		kg	202/218	202/218	285/305
	type			R410A	R410A	R410A
	volume		kg	9	9	11
Throttle type			EXV	EXV	EXV	
Design pressure (High/Low)		Mpa	4.4/2.6	4.4/2.6	4.4/2.6	
Ambient temperature range	Cooling	°C	-5~48	-5~48	-5~48	
	Heating	°C	-20~24	-20~24	-20~24	

1. IPLV are complied with GB 21454 - 2008.

Specifications

X-Power Full Inverter Super S Series

Model			38VF014H117010 38VF014H117010-E 38VF014H118010	38VF016H117010 38VF016H117010-E 38VF016H118010	38VF018H117010 38VF018H118010	
Power supply		V-Ph-Hz	208/230V 3~60Hz 220V 3~50Hz	208/230V 3~60Hz 220V 3~50Hz	208/230V 3~60Hz 220V 3~50Hz	
Cooling (*1)	Capacity	kW	40	45	50	
		RT	11.4	12.9	14.3	
	Input	kW	11.30	13.25	14.79	
	EER	KBtu/h/kW	12.08	11.60	11.53	
	IPLV	KBtu/h/kW	18.77	18.42	19.79	
Heating (*2)	Capacity	kW	45	50	56	
		RT	12.9	14.3	16.0	
	Input	kW	11.20	12.79	14.4	
COP	KBtu/h/kW	13.72	13.34	13.27		
Coneectable indoor unit	Total capacity	%	50-130%	50-130%	50-130%	
	Max.quantity		23	26	29	
Outdoor sound level (*3)		dB(A)	61	62	62	
Pipe connections	Liquid side	mm	Φ15.9	Φ15.9	Φ19.1	
	Gas side	mm	Φ31.8	Φ31.8	Φ31.8	
	Oil balance pipe	mm	Φ6.35	Φ6.35	Φ6.35	
Compressor	Quantities		1+1	1+1	2	
	Type		DC	DC	DC	
	Capacity	Btu/h(W)	31.59+11.80	31.59+11.80	31.59+31.59	
		Btu/h	107800+40300	107800+40300	107800+107800	
	Input	W	10340+3665	10340+3665	10340+10340	
	Crankcase	W	27.6x4	27.6x4	27.6x4	
	Refrigerant oil	Type	FVC68D	FVC68D	FVC68D	
ml		500+500	500+500	500+500		
Fan Motor	Type		DC motor	DC motor	DC motor	
	Quantities		2	2	2	
	Air flow rate	CFM	9200	9200	9200	
		m ³ /h	15620	15620	15620	
	Output	W	360x2(rated)	360x2(rated)	360x2	
ESP.	pa	0-20 (Default) 0-40 (Customize)	0-20 (Default) 0-40 (Customize)	0-20 (Default) 0-40 (Customize)		
Charged refrigerant	Dimension(WxHxD)		mm	1250x1615x765	1250x1615x765	1250x1615x765
	Packing(WxHxD)		mm	1305x1790x820	1305x1790x820	1305x1790x820
	Net/Gross weight		kg	285/305	288/308	310/330
	type			R410A	R410A	R410A
	volume		kg	13	13	16
Throttle type			EXV	EXV	EXV	
Design pressure (High/Low)		Mpa	4.4/2.6	4.4/2.6	4.4/2.6	
Ambient temperature range	Cooling	°C	-5~48	-5~48	-5~48	
	Heating	°C	-20~24	-20~24	-20~24	

1. IPLV are complied with GB 21454 - 2008.

Specifications

X-Power Full Inverter Super S Series

Model		38VF008H116010	38VF010H116010	38VF012H116010	38VF014H116010	38VF016H116010		
Power supply		V-Ph-Hz	460V 3Ph ~ 60Hz	460V 3Ph ~ 60Hz	460V 3Ph ~ 60Hz	460V 3Ph ~ 60Hz		
Cooling	Capacity	kW	25.2	28	33.5	40.0	45.0	
		Btu/h	86000	95500	114300	136500	153500	
	Input	kW	5.88	7.05	8.79	11.30	13.25	
	EER	kBtu/h/kW	14.64	13.55	13.00	12.08	11.60	
	IPLV	kBtu/h/kW	19.11	19.45	19.11	18.77	18.42	
Heating	Capacity	kW	27	31.5	37.5	45.0	50.0	
		Btu/h	92100	107500	128000	153500	170600	
	Input	kW	6.15	7.55	8.99	11.19	12.79	
	COP	kBtu/h/kW	14.98	14.23	14.23	13.72	13.34	
Compressor	Quantities		1	1	1+1	1+1	1+1	
	Capacity	Btu/h(W)	107800(31590)	107800(31590)	107800(31590)+40300(11800)	107800(31590)+40300(11800)	107800(31590)+40300(11800)	
	Input	W	10340	10340	10340+3665	10340+3665	10340+3665	
	Crankcase	W	27.6x2	27.6x2	27.6x4	27.6x4	27.6x4	
	Refrigerant oil	gal.(ml)	FVC68D / 0.132(500)	FVC68D / 0.132(500)	FVC68D / 0.132(500)+FVC68D / 0.132(500)	FVC68D / 0.132(500)+FVC68D / 0.132(500)	FVC68D / 0.132(500)+FVC68D / 0.132(500)	
Fan motor	Type		DC inverter	DC inverter	DC inverter	DC inverter	DC inverter	
	Quantities		1	1	2	2	2	
	Insulation class		E	E	E	E	E	
	Safe class		IPX4	IPX4	IPX4	IPX4	IPX4	
	Output	W	420	420	210x2	360x2	360x2	
Outdoor air flow		CFM(m³/h)	6604(11242)	6604(11242)	7647(13000)	9185(15620)	9185(15620)	
External static pressure		Pa	0~20 (default) 0~40 (optional)	0~20 (default) 0~40(optional)	0~20 (default) 0~60 (optional)	0~20 (default) 0~40 (optional)	0~20 (default) 0~40 (optional)	
Outdoor sound level		dB(A)	57	57	59	61	62	
Outdoor unit	Dimension (WxHxD)	in.(mm)	37-25/32x63-9/16x30-1/8 (960x1615x765)	37-25/32x63-9/16x30-1/8 (960x1615x765)	49-7/32x63-9/16x30-1/8 (1250x1615x765)	49-7/32x63-9/16x30-1/8 (1250x1615x765)	49-7/32x63-9/16x30-1/8 (1250x1615x765)	
		Packing(WxHxD)	in.(mm)	40-3/8x70-1/2x32-11/16 (1025x1790x830)	40-3/8x70-1/2x32-11/16 (1025x1790x830)	51-3/8x70-1/2x32-11/16 (1305x1790x820)	51-3/8x70-1/2x32-11/16 (1305x1790x820)	51-3/8x70-1/2x32-11/16 (1305x1790x820)
	Net/Gross weight		lbs.(kg)	466/485(212/227)	466/485(212/227)	634/678(288/308)	634/678(288/308)	634/678(288/308)
	Charged refrigerant type and volume		lbs.(kg)	R410A/ 22(10)	R410A/ 22(10)	R410A/ 26(12)	R410A/ 33(15)	R410A/ 33(15)
Throttle type			EXV	EXV	EXV	EXV	EXV	
Excessive operating pressure		MPa	4.4/2.6	4.4/2.6	4.4/2.6	4.4/2.6	4.4/2.6	
Liquid side/ Gas side		in.(mm)	1/2(Φ12.7)/1(Φ25.4)	1/2(Φ12.7)/1(Φ25.4)	5/8(Φ15.9)/1-1/4(Φ31.8)	5/8(Φ15.9)/1-1/4(Φ31.8)	5/8(Φ15.9)/1-1/4(Φ31.8)	
Oil balance pipe		in.(mm)	1/4(Φ6.35)	1/4(Φ6.35)	1/4(Φ6.35)	1/4(Φ6.35)	1/4(Φ6.35)	
Ambient temperature range	Cooling	°F(°C)	23~118.4(-5~48)	23~118.4(-5~48)	23~118.4(-5~48)	23~118.4(-5~48)	23~118.4(-5~48)	
	Heating	°F(°C)	-4~75.2(-20~24)	-4~75.2(-20~24)	-4~75.2(-20~24)	-4~75.2(-20~24)	-4~75.2(-20~24)	

IPLV are complied with GB 21454 - 2008.

Recommended combination table

Model	N° of Outdoor Units	N° of Compressors	Outdoor Unit Combination						Maximum N° of Connectable Indoor Units	Capacity			
			8HP	10HP	12HP	14HP	16HP	*18HP		Cooling		Heating	
										kW	kBtu/h	kW	kBtu/h
8HP	1	1	1						13	25.2	86.0	27.0	92.1
10HP	1	1		1					16	28.0	95.5	31.5	107.5
12HP	1	2			1				20	33.5	114.3	37.5	128.0
14HP	1	2				1			23	40.0	136.5	45.0	153.5
16HP	1	2					1		26	45.0	153.5	50.0	170.6
*18HP	1	2						1	29	50.0	170.6	56.0	191.1
20HP	2	2		2					33	56.0	191.1	63.0	215.0
22HP	2	3		1	1				36	61.5	209.8	69.0	235.4
24HP	2	3		1		1			39	68.0	232.0	76.5	261.0
26HP	2	3		1			1		43	73.0	249.1	81.5	278.1
28HP	2	3		1				1	46	78.0	266.1	87.5	298.6
30HP	2	4				1	1		50	85.0	290.0	95.0	324.1
32HP	2	4				1		1	53	90.0	307.1	101.0	344.6
34HP	2	4					1	1	56	95.0	324.1	106.0	361.7
36HP	2	4						2	59	100.0	341.2	112.0	382.1
38HP	3	4		2				1	63	106.0	361.7	119.0	406.0
40HP	3	5		1		1	1		64	113.0	385.6	126.5	431.6
42HP	3	5				3			64	120.0	409.4	135.0	460.6
44HP	3	5		1			1	1	64	123.0	419.7	137.5	469.2
46HP	3	5		1				2	64	128.0	436.7	143.5	489.6
48HP	3	6				1	1	1	64	135.0	460.6	151.0	515.2
50HP	3	6				1		2	64	140.0	477.7	157.0	535.7
52HP	3	6					1	2	64	145.0	494.7	162.0	552.7
54HP	3	6						3	64	150.0	511.8	168.0	573.2
56HP	4	6		2				2	64	156.0	532.3	175.0	597.1
58HP	4	7		1		1	1	1	64	163.0	556.2	182.5	622.7
60HP	4	7		1		1		2	64	168.0	573.2	188.5	643.2
62HP	4	7		1			1	2	64	173.0	590.3	193.5	660.2
64HP	4	7		1				3	64	178.0	607.3	199.5	680.7
66HP	4	8				1	1	2	64	185.0	631.2	207.0	706.3
68HP	4	8				1		3	64	190.0	648.3	213.0	726.8
70HP	4	8					1	3	64	195.0	665.3	218.0	743.8
72HP	4	8						4	64	200.0	682.4	224.0	764.3

Notes:

Capacities are based on the following conditions:

Cooling: Indoor temperature 27°C(80.6°F) DB/19°C(66.2°F) WB; Outdoor temperature 35°C(95°F) DB/24°C(75.2°F) WB

Heating: Indoor temperature 20°C(68°F) DB/15°C(59°F) WB; Outdoor temperature 7°C(44.6°F) DB/6°C(42.8°F) WB

Piping length: Interconnecting piping length is 7.5m(24.6ft), level difference is zero.

The above combination models are factory-recommended models.

*18HP model is customize

Dimensions

Body dimension

Unit: in.(mm)
8/10 HP

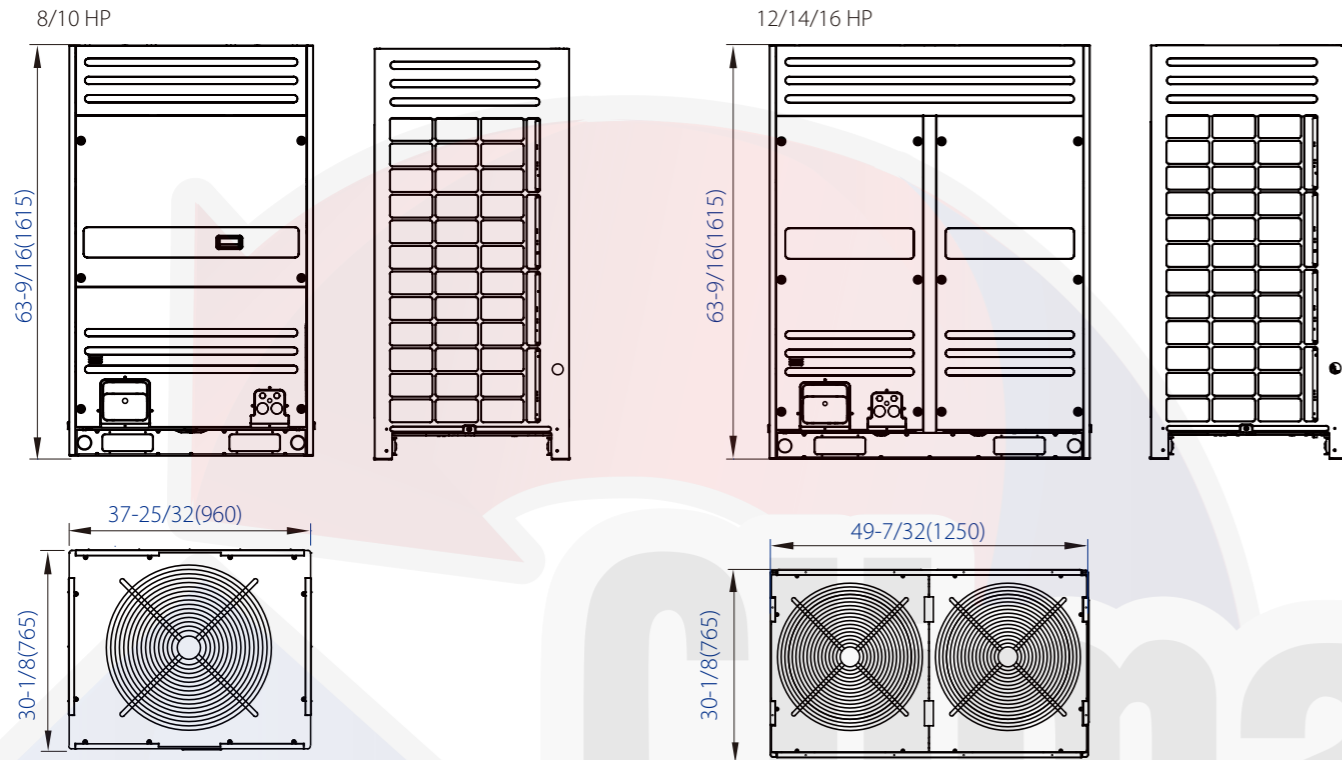

Installation dimension

Unit: in.(mm)

Screw bolt position

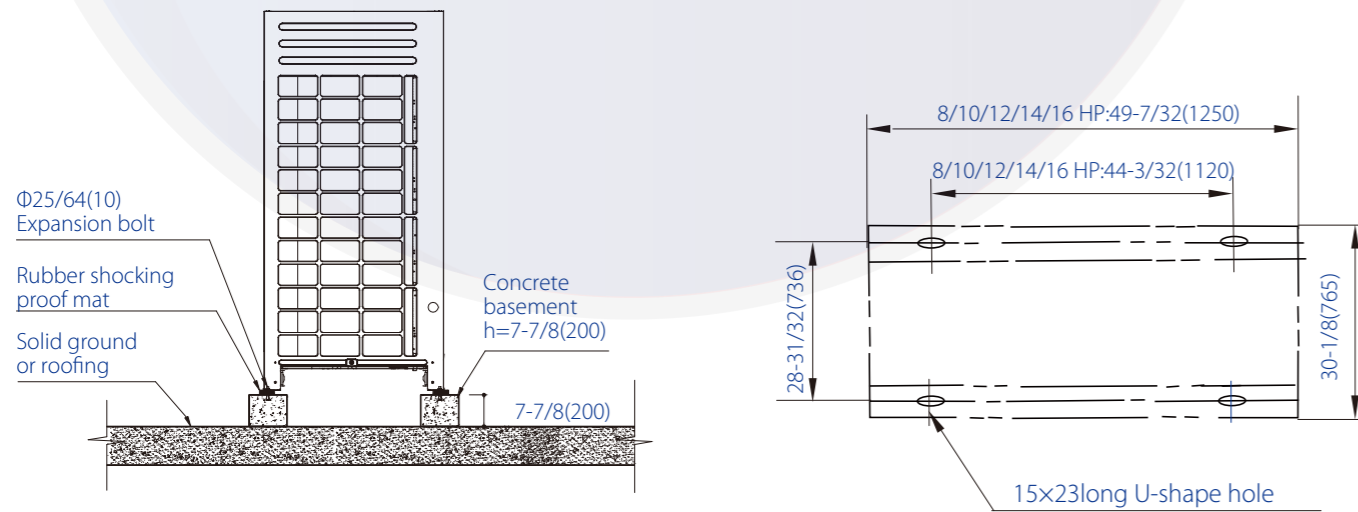

X-Power Full DC Inverter Heat Recovery Series



Heat Recovery, EER up to 23.88

Heat recovery is achieved by diverting exhaust heat from indoor units in cooling mode to areas requiring heating, maximizing energy efficiency, reducing electricity costs and leading to high partload efficiencies (up to 7.0 in the 8HP category).

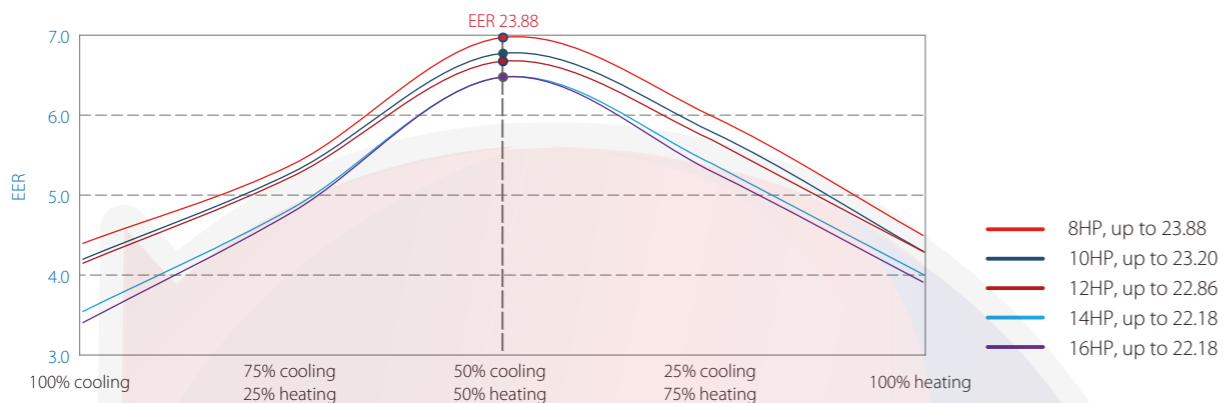

EER in simultaneous cooling and heating mode are based on the following condition:
Outdoor temperature 7°CDB/6°CWB, indoor temperature 27°CDB/19°CWB for cooling, indoor temperature 20°CDB for heating.

Long Piping Length

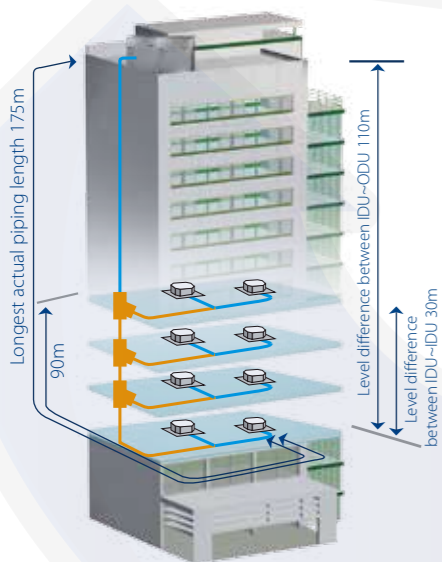

Total piping length	1000m
Longest length actual (Equivalent)	175(200)m
Longest length after first branch	90*m
Longest length from MS to its downstream indoor unit	40m
Level difference between indoor and outdoor units - ODU up (down)	70(110)m
Level difference between indoor units	30m

*The longest piping length is 40m standard. It can be extended to 90m. When the length is over 40m, please contact your local Carrier sales company for more information and restrictions.

Adjustable Outdoor Heat Exchanger

Two parts condenser individual design, the unit can distribute a part of evaporator to be as condensing area according to the heating load requirement to improve the utilization rate of the condenser.

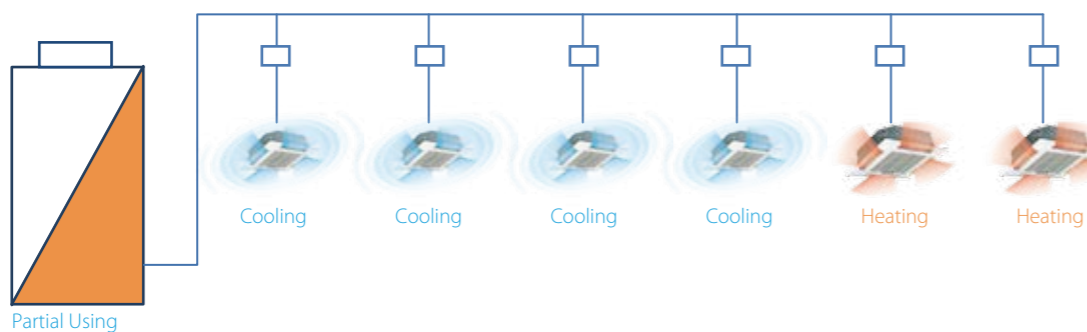

Continuous Heating During Defrost Operation

Each heat exchanger is defrosted by using heat transferred from one heat exchanger to the other in the outdoor unit. Defrost has no impact on the indoor unit on heating mode.

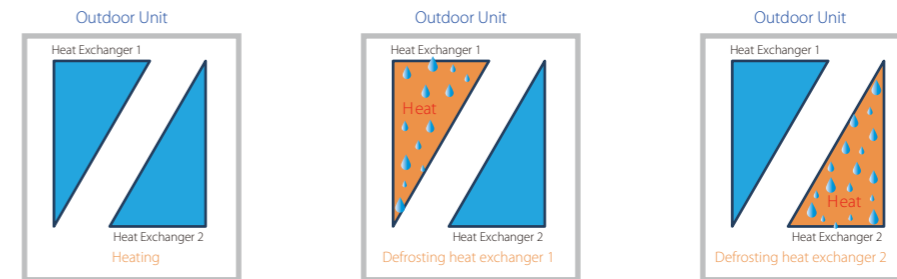

Auto Mode Control

Under the Auto Mode, the indoor unit can change the operation mode automatically, to keep the indoor temperature at a constant level.

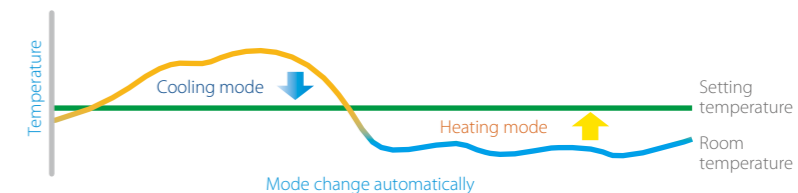

Note: Auto Mode can be activated only with wired controller WR-120B-CM.

Innovative Mode Switch (MS) Box

Simultaneous cooling and heating achieved for new designed MS (Mode Switch) box.

- ❖ Low noise operation for precise control of multiple solenoid valves;
- ❖ Max. 24 indoor units connect to a MS box;
- ❖ Max. 56kW indoor units connect to a MS box;

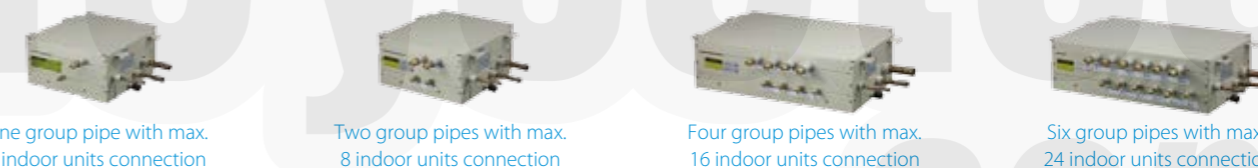

- ❖ Indoor units connected to a same MS can realize simultaneous cooling and heating operation.

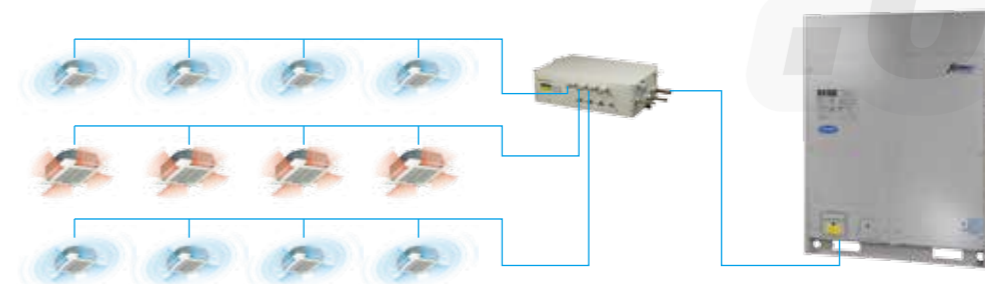

Rotatable Control Box

Newly designed rotating control box can rotate in a wide angle. It is convenient for the inspection and maintenance of the pipeline system and greatly reduces the dismount time of the electric control box.

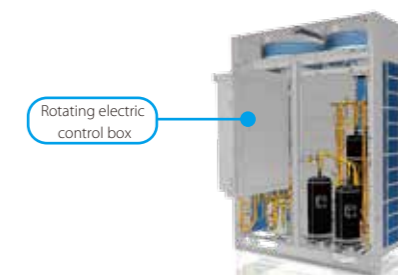

Xpower Heat Recovery Series



Capacity(HP)		8	10	12	14	16	
Model 38VR		38VF008T119010 38VF008T118010	38VF010T119010 38VF010T118010	38VF012T119010 38VF012T118010	38VF014T119010 38VF014T118010	38VF016T119010 38VF016T118010	
Power supply	V/Ph/Hz	380-415/3/50 380-415/3/60					
Cooling	Capacity	kW	25.2	28	33.5	40	45
	Power input	kW	5.73	6.67	8.07	11.3	13.24
	EER	kBtu/h/kW	15.01	14.33	14.16	12.08	11.60
Heating	Capacity	kW	27	31.5	37.5	45	50
	Power input	kW	6	7.33	8.72	11.19	12.79
	COP	kBtu/h/kW	15.35	14.67	14.67	13.72	13.34
Connectable indoor unit	Total capacity	50~130% of outdoor unit capacity					
Compressor	Max. quantity	13	16	20	23	26	
	Type	DC inverter					
Fan motor	Quantity	1	1	1	2	2	
	Type	DC motor					
Refrigerant	Static pressure	Pa	0-20 (default)			20-40 (customized)	
	Type	Pa	20-40 (customized)			20-60 (customized)	
Pipe connections	Factory charging	kg	10	10	10	13	13
	Liquid pipe	mm	Φ12.7	Φ12.7	Φ15.9	Φ15.9	Φ15.9
Air flow rate	Low pressure gas pipe	mm	Φ22.2	Φ22.2	Φ25.4	Φ25.4	Φ28.6
	High pressure gas pipe	mm	Φ19.1	Φ19.1	Φ19.1	Φ22.2	Φ22.2
	High pressure gas balance pipe	mm	Φ19.1	Φ19.1	Φ19.1	Φ19.1	Φ19.1
	Oil balance pipe	mm	Φ6.35	Φ6.35	Φ6.35	Φ6.35	Φ6.35
Sound pressure level	m ³ /h	12000	12000	13000	15000	15000	
Net dimension (WxHxD)	dB(A)	57	57	58	60	60	
Packing size (WxHxD)	mm	1250x1615x765					
Net weight	mm	1305x1790x820					
Gross weight	kg	255	255	255	303	303	
Operating temperature range	kg	273	273	273	322	322	
Operating temperature range °C							

Notes:
 Capacities are based on the following conditions:
 Cooling: Indoor temperature 27°C DB/19°C WB; Outdoor temperature 35°C DB/24°C WB; Heating: Indoor temperature 20°C DB/15°C WB; Outdoor temperature 7°C DB/6°C WB.
 Piping length: Interconnecting piping length is 7.5m, level difference is zero.
 Sound values are measured in a semi-anechoic room, at a position 1m in front of the unit and 1.3m above the floor.

Xpower Heat Recovery Series - MS Box



Model		MSFT-01C-CM	MSFT-02C-CM	MSFT-04C-CM	MSFT-06C-CM	MSFT-02E-CM	MSFT-04E-CM		
Applicable indoor units		All VRF indoor units except high static pressure duct				Only high static pressure duct			
Max. indoor unit groups		1	2	4	6	1	1		
Max. number of each group of indoor units		4	4	4	4	1	1		
Max. number of downstream indoor units		4	8	16	24	1	1		
Max. capacity of each group of indoor units	kW	16	16	16	16	20/25/28	40/45/56		
Max. total capacity of all downstream indoor units	kW	16	28	45	45	20-28	40-56		
Piping connections	Connected to outdoor unit	Liquid pipe	mm	Φ9.53	Φ12.7	Φ15.9	Φ15.9	Φ12.7	Φ15.9
		High pressure gas pipe	mm	Φ15.9	Φ19.1	Φ22.2	Φ22.2	Φ19.1	Φ22.2
		Low pressure gas pipe	mm	Φ19.1	Φ25.4	Φ31.8	Φ31.8	Φ25.4	Φ31.8
	Connected to indoor unit	Liquid pipe	mm	Φ9.53	Φ9.53	Φ9.53	Φ9.53	Φ9.53	Φ9.53
		Gas pipe	mm	Φ15.9	Φ15.9	Φ15.9	Φ15.9	Φ15.9	Φ15.9
		Sound pressure level	dB(A)	33	33	33	40	33	33
Net dimension (WxHxD)	mm	630x225x600	630x225x600	960x225x600	960x225x600	630x225x600	960x225x600		
Packing size (WxHxD)	mm	725x325x685	725x325x685	1055x325x685	1055x325x685	725x325x685	1055x325x685		
Net weight	kg	18	19.5	31	35	19.5	31		
Gross weight	kg	25	27	40	44.5	27	40		

Note:
 Sound values are measured in a semi-anechoic room, at a position 1m below the MS equipment in mode switch condition.
 It is not recommended to install in a place where low noise performance is required.

Recommended combination table

Model	No. of units	No. of compressor	Modules ¹					Max No. of connectable indoor unit	Cooling capacity		Heating capacity	
			8	10	12	14	16		kW	kBtu/h	kW	kBtu/h
8	1	1	●					13	25.2	86.0	27.0	92.1
10	1	1		●				16	28	95.5	31.5	107.5
12	1	1			●			20	33.5	114.3	37.5	128.0
14	1	2				●		23	40	136.5	45.0	153.5
16	1	2					●	26	45	153.5	50.0	170.6
18	2	2	●	●				29	50	170.6	58.5	199.6
20	2	2		●●				33	56	191.1	63.0	215.0
22	2	2		●	●			36	61.5	209.8	69.0	235.4
24	2	3		●		●		39	67	228.6	76.5	261.0
26	2	3		●			●	43	73	249.1	81.5	278.1
28	2	4				●●		46	78.5	267.8	90.0	307.1
30	2	4				●	●	50	85	290.0	95.0	324.1
32	2	4					●●	53	90	307.1	100.0	341.2
34	3	4		●●		●		56	95	324.1	108.0	368.5
36	3	4		●●			●	59	101.5	346.3	113.0	385.6
38	3	4		●	●		●	63	106.5	363.4	119.0	406.0
40	3	5		●		●	●	64	112	382.1	126.5	431.6
42	3	6				●●●		64	117.5	400.9	112.5	383.9
44	3	6				●●	●	64	123	419.7	125.0	426.5
46	3	6				●	●●	64	128.5	438.4	145.0	494.7
48	3	6					●●●	64	134.5	458.9	150.0	511.8
50	4	6	●	●			●●	64	140	477.7	158.5	540.8
52	4	6		●●			●●	64	146	498.2	163.0	556.2
54	4	6		●	●		●●	64	151.5	516.9	169.0	576.6
56	4	7		●		●	●●	64	157	535.7	176.5	602.2
58	4	8				●●●	●	64	163.5	557.9	185.0	631.2
60	4	8				●●	●●	64	168.5	574.9	190.0	648.3
62	4	8				●	●●●	64	175	597.1	195.0	665.3
64	4	8					●●●●	64	180	614.2	200.0	682.4

Notes:
 Capacities are based on the following conditions:
 Cooling: Indoor temperature 27°C(80.6°F) DB/19°C(66.2°F) WB; Outdoor temperature 35°C(95°F) DB/24°C(75.2°F) WB
 Heating: Indoor temperature 20°C(68°F) DB/15°C(59°F) WB; Outdoor temperature 7°C(44.6°F) DB/6°C(42.8°F) WB
 Piping length: Interconnecting piping length is 7.5m(24.6ft), level difference is zero.
 The above combination models are factory-recommended models

Body dimension

Unit: in.(mm)

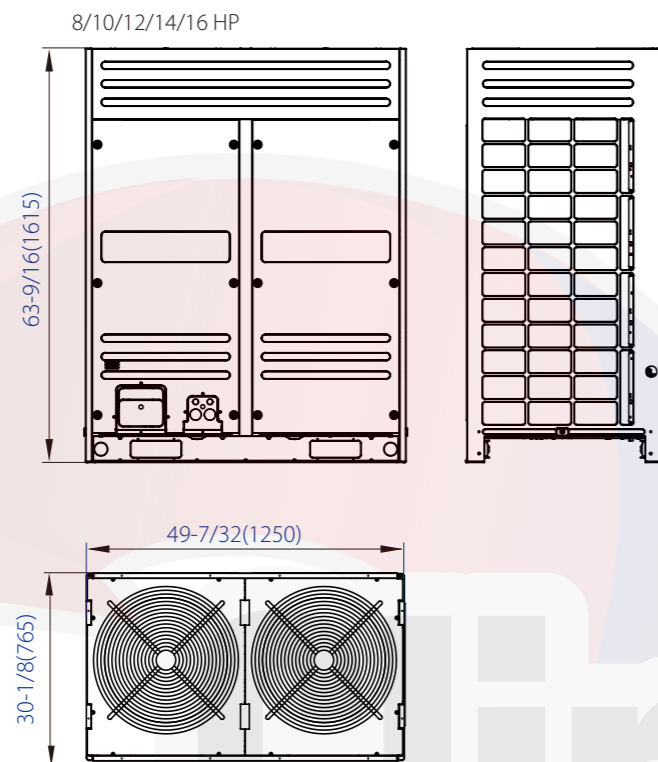

Installation dimension

Unit: in.(mm)

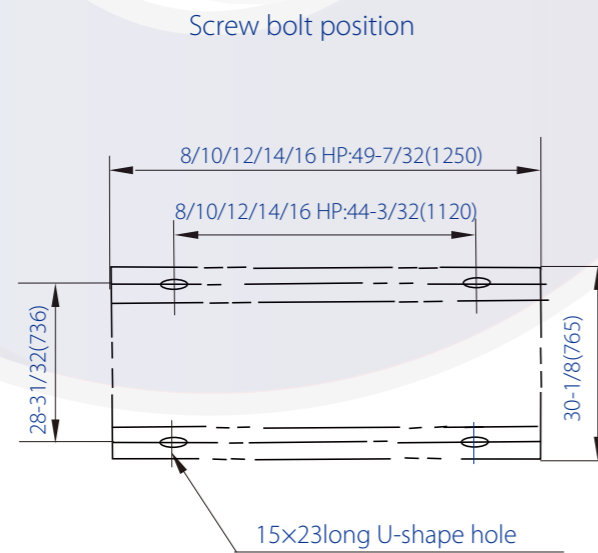



X-Power Full DC Inverter Mini H Series



NEW
Fashion
Design

R-410A

DC Inverter

ctos
com

Features

Wide Application Range

Wide range of outdoor units

The outdoor units' capacity range from 8kW(27,3kBTU/h) to 45kW(153,5kBTU/h) which is ideal for small offices, villas, apartment and shops, making it perfect for commercial and residential application.

8kW; 10kW (27,3kBTU/h; 35,8kBTU/h)	12kW; 14kW; 16kW (40,9kBTU/h; 47,8kBTU/h; 52,9kBTU/h)	20kW; 22.4kW; 26kW; 33.5kW (68.2kBTU/h; 76.4kBTU/h; 88.7kBTU/h; 114.3kBTU/h)	40kW; 50kW (136,5kBTU/h; 153,5kBTU/h)
---------------------------------------	--	---	--



Flexible indoor units connection

Mini VRF with intelligent control gives you independent zoning control with maximum flexibility. A single outdoor unit supports up to nine indoor units, freeing up considerable space outside. Use your backyard more wisely with much more space available created by less number of outdoor units.

- Max. 7 indoor units for a 16kW(52,900Btu/h) outdoor unit installation
- Max. 6 indoor units for a 14kW(47,800Btu/h) outdoor unit installation
- Max. 6 indoor units for a 12kW(40,900Btu/h) outdoor unit installation
- Max. 5 indoor units for a 10.5kW(35,800Btu/h) outdoor unit installation

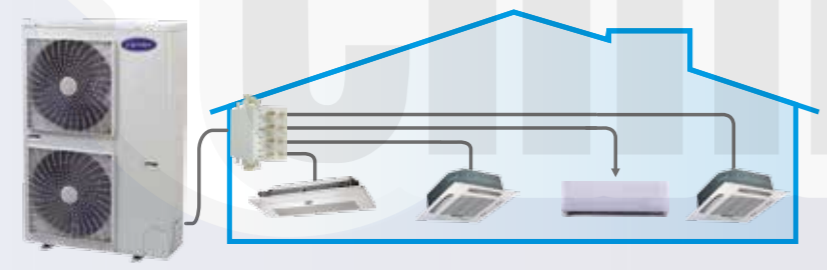

*For 20-45KW unit, please check the information in the specifications.

Wide operation temperature range

Mini VRF system operates stably at extreme temperature range from minus 15°C (5°F) to 43°C(118.4°F).

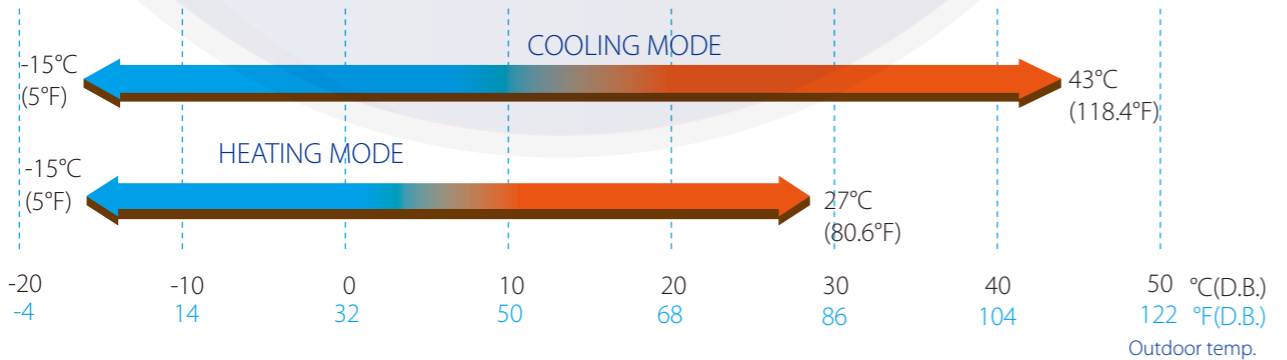

*For 20-45KW unit, please check the information in the following specifications.

Flexible piping design

The Mini VRF provides a total piping length possibility of 250m(820.2ft), a maximum height difference between outdoor and indoor units of 30m(98.4ft). The height difference between indoors unit can be up to 8m(26.2ft). These generous allowances facilitate an extensive array of system designs.

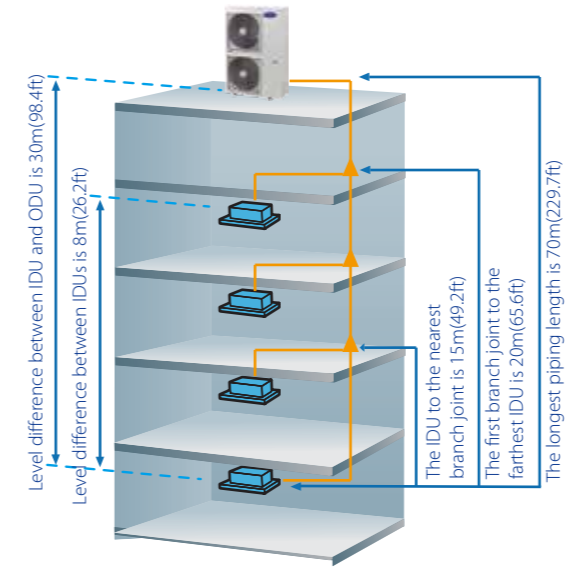

Permitted value		8/10kW (27.3/35.8kBTU/h)	12/14/16/18kW (40.9/47.8/ 52.9 kBTU/h)	20/22.4/26/28/ 33.5kW(68.2/76.4/ 88.7/114.3kBTU/h)	40/45kW 136.5/153.5kBTU/h)	
Piping length	Total piping length (Actual)	100m(328ft)	100m(328ft)	120m(393.7ft)	250m(820.2ft)	
	Longest piping (L)	Actual length	45m(146.7ft)	60m(196.9ft)	60m(196.9ft)	100m(328ft)
		Equivalent length	50m(164ft)	70m(229.7ft)	70m(229.7ft)	120m(393.7ft)
Level difference	Equivalent piping length (from the farthest IDU to the first indoor branch joint)		20m(65.6ft)	20m(65.6ft)	20m(65.6ft)	40m(131.2)
	Level difference between IDU-ODU	Outdoor unit up	30m(98.4ft)	30m(98.4ft)	30m(98.4ft)	30m(98.4ft)
		Outdoor unit down	20m(65.6ft)	20m(65.6ft)	20m(65.6ft)	20m(65.6ft)
	Level difference between IDU-IDU		8m(26.2ft)	8m(26.2ft)	8m(26.2ft)	8m(26.2ft)

1 Total pipe length is equal to all the liquid pipe or all the gas pipe length.
 2 When the total equivalent pipe length of liquid side plus gas side is more than 90m(295.2ft), it needs to meet the specific conditions according to the installation part of the technical manual.
 3 *For 20-45KW unit, please check the information in the specifications.

High Efficiency

High COP and EER values

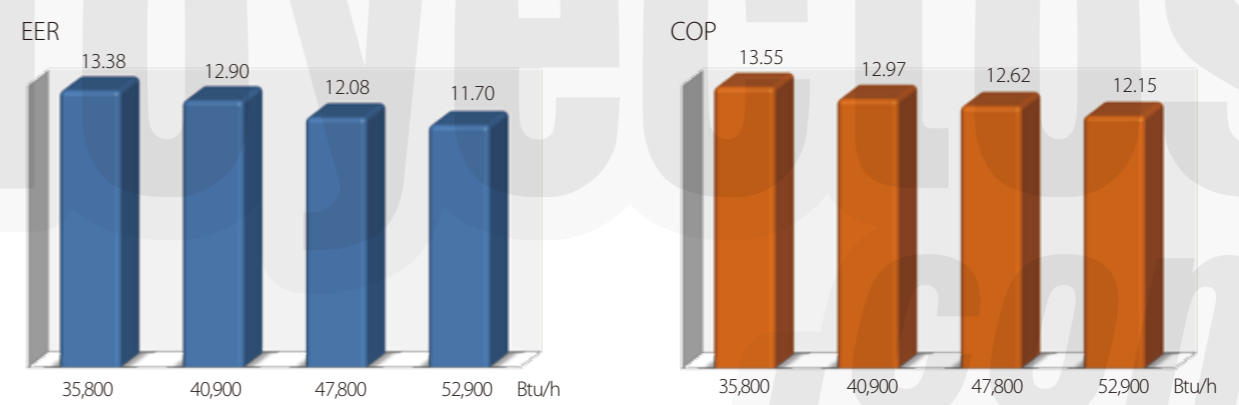

*For 20-45KW unit, please check the information in the specifications.

High performance heat exchanger

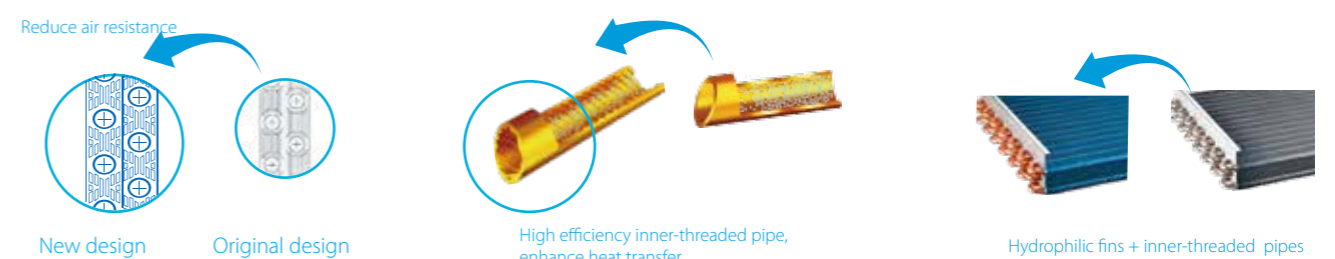

- The new designed window fins enlarge the heat-exchanging area, decrease the air resistance, save more power and enhance heat exchange performance.
- Hydrophilic film fins and inner-threaded copper pipes optimize heat exchange efficiency.
- The specially coated blue fins enhance durability and protect against corrosion from air, water and other corrosive agents, assures a longer coil service life.

More convenience in installation

A four-direction space is available for connecting pipes and wiring in various installation sites.

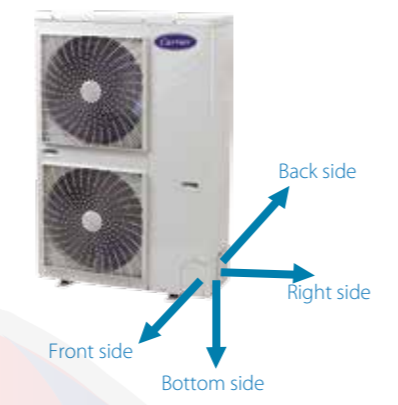
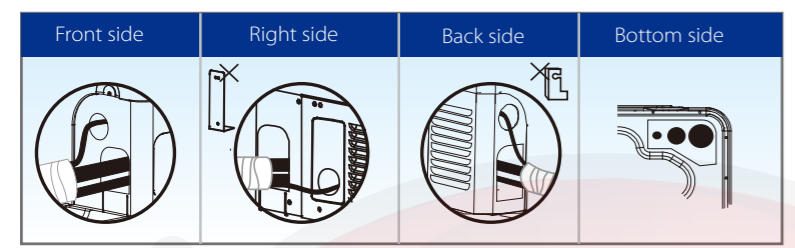

More convenient piping connector - branch box

Easier and safer installation thanks to a branch box that simplifies piping work and the adoption of screw connection. Both left and right pipe flare connection from outdoor unit to branch box is reserved, which greatly simplifies field installation. Two sets of pipe size converter are packed with branch box to transfer the pipe size from $\Phi 6.35\text{mm}(\Phi 1/4\text{in})$ to $\Phi 9.53\text{mm}(\Phi 3/8\text{in})$ and from $\Phi 12.7\text{mm}(\Phi 1/2\text{in})$ to $\Phi 15.9\text{mm}(\Phi 5/8\text{in})$.

- Low noise**
 The branch pipe is linear expansion design regulates the flow of refrigerant and reduces the noise. By locating the branch box in the ceiling or outside, noise generated by the branch box can be kept clear of living spaces, thus makes noise level to a minimum.
- Brazing-free quick installation**
 All the piping leading to and from the branch box is connected using screw joints, which can be installed quickly and easily.
- Indoor installation**
 The branch box can be installed in the ceiling rather than outside. Removing the side and bottom covers provides easy access for maintaining inner components such as circuit boards.



New piping connection design

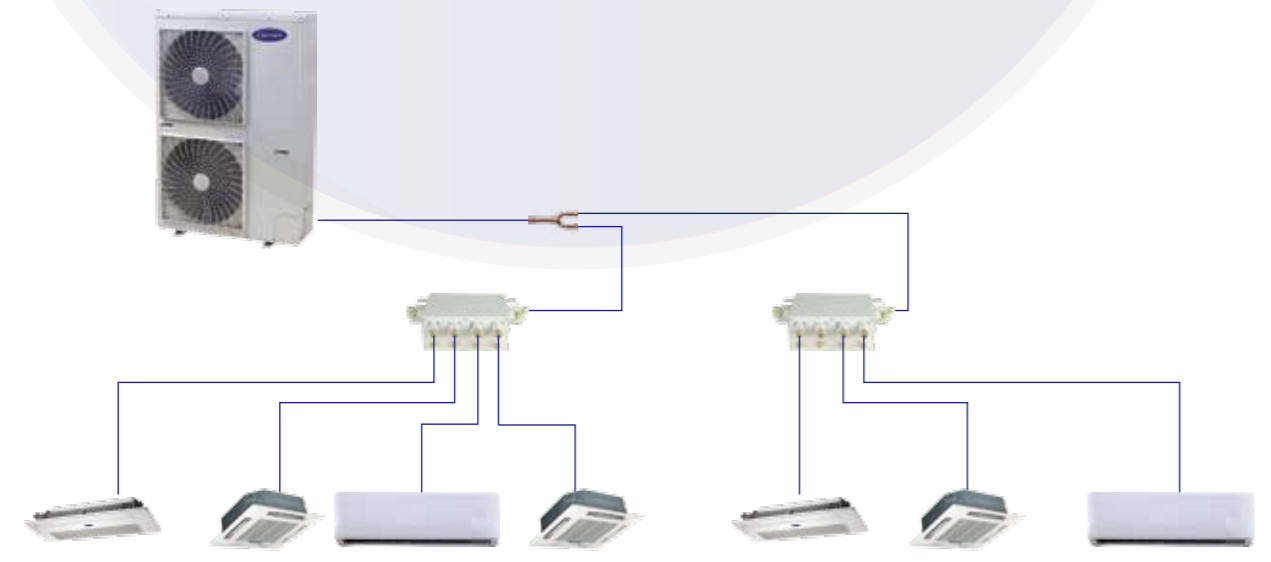

*40/45KW unit can not connect branch box

Advanced Technologies

Full DC inverter technology

At the heart of our system is a highly intelligent inverter driven compressor. This advanced technology enables the output of the outdoor unit to be modulated by the cooling or heating demands of the zone that it controls. This advanced system ensures precise temperature regulation and highly efficient energy usage, making a significant contribution to the limiting the impact on the environment.

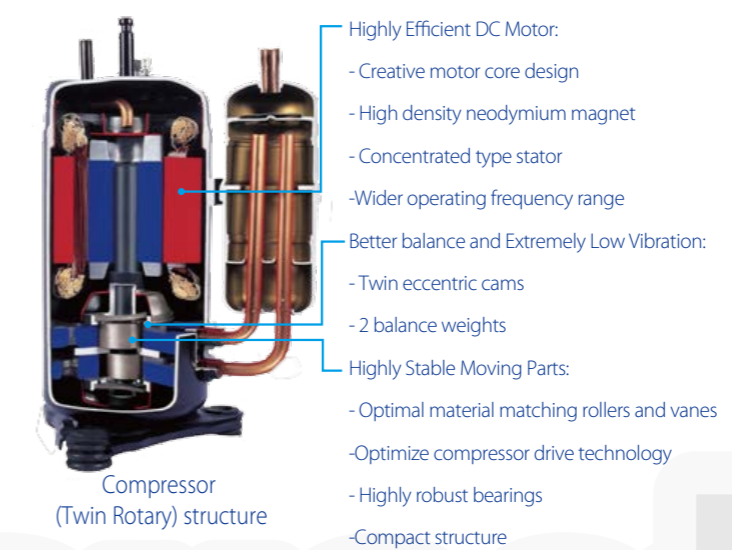

High efficiency DC fan motor saved power up to 50%.

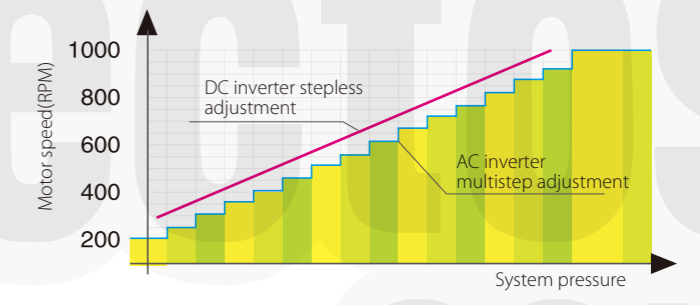

Noise reducing design

Optimally designed fan shape and air discharge grille increases air volume and reduces running noise.



Specifications 50Hz

Sales Model		38VR007H119010	38VR008H119015	38VR010H119015	38VR012H119015	38VR014H119015	38VR016H119015	
Power supply		V-Ph-Hz	380-415V-3N~50Hz	380-415V-3N~50Hz	380-415V-3N~50Hz	380-415-3N~50	380-415-3N~50	
Cooling	Capacity	kW	20	22.4	26	33.5	40	45
		RT	5.7	6.4	7.4	9.5	11.4	12.9
	Input	kW	6.1	6.8	7.6	9.85	11.9	13.6
	EER	KBtu/h/kW	11.19	11.23	11.67	11.6	11.43	11.33
Heating	Capacity	kW	22	24.5	28.5	33.5	45	50
		RT	6.29	7	8.1	9.5	12.86	14.3
	Input	kW	6.1	5.9	6.8	8.38	11.1	12.7
	COP	KBtu/h/kW	12.32	14.16	14.30	13.65	13.82	13.41
Outdoor sound level(*3)		dB(A)	59	59	60	62	62	62
Pipe connections	Liquid side	mm	Φ9.53	Φ9.53	Φ9.53	Φ12.7	Φ12.7	Φ12.7
	Gas side	mm	Φ19.1	Φ19.1	Φ22.2	Φ22.2	Φ22.2	Φ25.4
Connectable	Total capacity	%	50-130%	50-130%	50-130%	50-130%	50-130%	50-130%
	Max.quantity		10	11	12	13	14	15
Compressor	Type		Rotary	Rotary	Rotary	Rotary	Rotary	Rotary
	Brand		mitsubishi	mitsubishi	mitsubishi	mitsubishi	mitsubishi	mitsubishi
	Capacity	Btu/h	13980	16860	16860	57526	13980×2	16860×2
	Crankcase	W	25	25	25	5.2	25×2	25×2
	Refrigerant oil	Type	FV50S	FV50S	FV50S	FV50S	FV50S	FV50S
	Refrigerant oil	ml	1400+1300	1700+1500	1700+1500	1700+1500	1400×2+2500	1700×2+3600
Fan Motor	Type		DC motor	DC motor	DC motor	DC	DC+AC	DC+AC
	Quantity		2	2	2	2	1+1	1+1
	Output	W	210/160	200/150	200/150	220+180	560/320	560/320
		CFM	6470	6173	6173	6374	9750	9750
Airflow	m ³ /h	10999	10494	10494	10837	16575	16575	
Outdoor unit	Dimension(WxHxD)	mm	1120×1558×528	1120×1558×528	1120×1558×528	1120×1558×528	1360×1650×540	1460×1650×540
	Net/Gross weight	kg	137/153	146.5/162.5	147/163	157/173	240/260	275/290
Refrigerant	Type		R410A	R410A	R410A	R410A	R410A	R410A
	Charged volume	g	4800	6200	6200	3750	9000	12000
Throttle type			EXV					
Design pressure		MPa	4.4/2.6					
Ambient temp	°F(°C)		-15~46	-15~46	-15~46	-5~48	-5~48	-5~48
			-15~24	-15~24	-15~24	-15~24	-15~24	-15~24

- Note:
- The cooling conditions: indoor temp.: 27°C DB(80.6°F), 19°C WB(60°F) outdoor temp.: 35°C DB(95°F) equivalent pipe length: 5m drop length: 0m.
 - The heating conditions: indoor temp.: 20°C DB(68°F), 15°C WB(44.6°F) outdoor temp.: 7°C DB(42.8°F) equivalent pipe length: 5m drop length: 0m.
 - Sound level: Anechoic chamber conversion value, measured at a point 1 m(3.28ft) in front of the unit at a height of *m(1m(3.28ft) for 105 model, 1.2m(3.94ft) for 120~160model). During actual operation, sound level might be affected by ambient conditions.
 - The above data may be changed without notice for future improvement on quality and performance.

Outdoor Unit

208/230V~1Ph~60Hz

38VR004H113015
38VR004H113010
38VR005H113010
38VR006H113010

220-240V~1Ph~50Hz

38VR003H112010 38VR005H112010
38VR004H112015 38VR006H112010
38VR004H112010



Specifications 60Hz&50Hz

Sale Model			38VR004H113015	38VR004H113010	38VR005H113010	38VR006H113010
Power supply		V-Ph-Hz	208-230V-1Ph~60Hz	208-230V-1Ph~60Hz	208-230V-1Ph~60Hz	208-230V-1Ph~60Hz
Cooling	Capacity	kW	10.5	12	14	15.5
		RT	3	3.4	4.0	4.4
	Input	kW	2.68	3.25	3.95	4.52
	EER	KBtu/h/kW	13.38	12.59	12.08	11.70
Heating	Capacity	kW	11.5	13.2	15.4	17
		RT	3.3	3.8	4.4	4.9
	Input	kW	2.9	3.47	4.16	4.77
	COP	KBtu/h/kW	13.55	12.97	12.62	12.15
Connectable indoor unit	Total capacity	%	50-130%	50-130%	50-130%	50-130%
	Max.quantity		5	6	6	7
Outdoor sound level (*3)		dB(A)	57	57	57	57
Pipe connections	Liquid side	mm	Φ9.53	Φ9.53	Φ9.53	Φ9.53
	Gas side	mm	Φ15.9	Φ15.9	Φ15.9	Φ19.1
Compressor	Type		Rotary	Rotary	Rotary	Rotary
	Brand		mitsubishi	mitsubishi	mitsubishi	mitsubishi
	Capacity	Btu/h	24330	33710	33710	47713
	Input	W	2200	3010	3010	4240
	Crankcase	W	25	27	25	20
	Refrigerant oil	Type ml	FV50S 670	FV50S 870	FV50S 870	FV50S 1400
Fan Motor	Type		DC motor	DC motor	DC motor	DC motor
	Quantity		1	2	2	2
	Output	W	170	2 x 85	2 x 85	2 x 85
		CFM	3000	3531	3531	3531
Air floor rate	m ³ /h	5100	6000	6000	6000	
Outdoor unit	Dimension (W x H x D)	mm	1075x966x396	900x1327x400		
	Packing (W x H x D)	mm	1120x1100x435	1030x1456x435		
	Net/Gross weight	kg	78/85	95/106	95/106	102/113
Refrigerant	Type		R410a			
	Charged volume	kg	3	3.3	3.9	3.9
Throttle type			EXV	EXV	EXV	EXV
Design pressure		MPa	4.4/2.6	4.4/2.6	4.4/2.6	4.4/2.6
Ambient temperature range	Cooling	°C	-15~43°C			
	Heating	°C	-15~27°C			

- Note:
- The cooling conditions: indoor temp.: 27°C DB(80.6°F), 19°C WB(60°F) outdoor temp.: 35°C DB(95°F) equivalent pipe length: 5m drop length: 0m.
 - The heating conditions: indoor temp.: 20°C DB(68°F), 15°C WB(44.6°F) outdoor temp.: 7°C DB(42.8°F) equivalent pipe length: 5m drop length: 0m.
 - Sound level: Anechoic chamber conversion value, measured at a point 1 m in front of the unit at a height of *m(0.9m for 80model, 1m for 105 model, 1.2m for 120~160model). During actual operation, these values are normally somewhat higher as a result of ambient conditions.
 - The above data may be changed without notice for future improvement on quality and performance.

Dimension

Unit Dimensions, unit: mm(in)

8/10.5kW

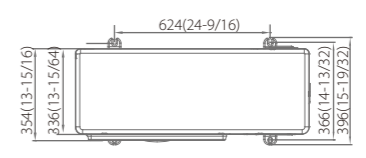
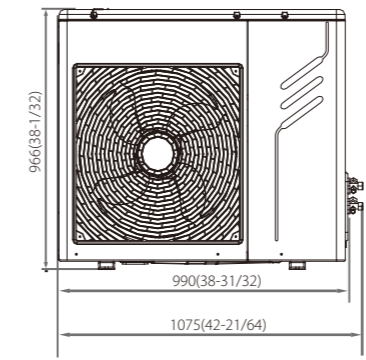

12/14/16kW

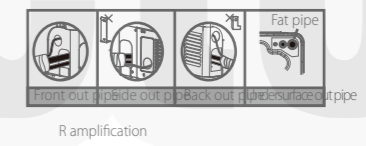
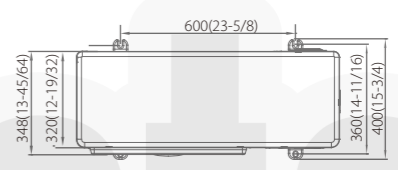
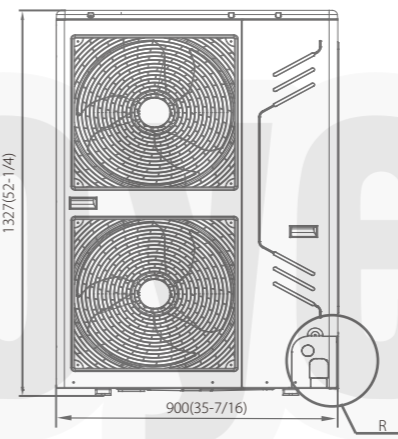

18/20/24/26kW

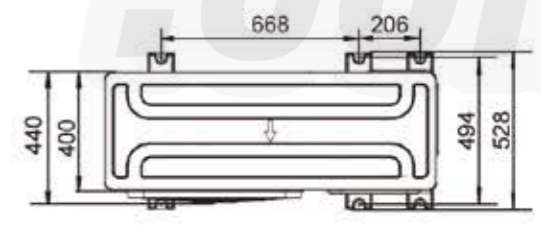
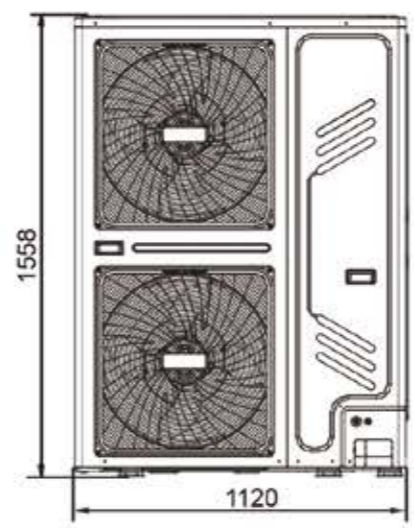

40/45kW

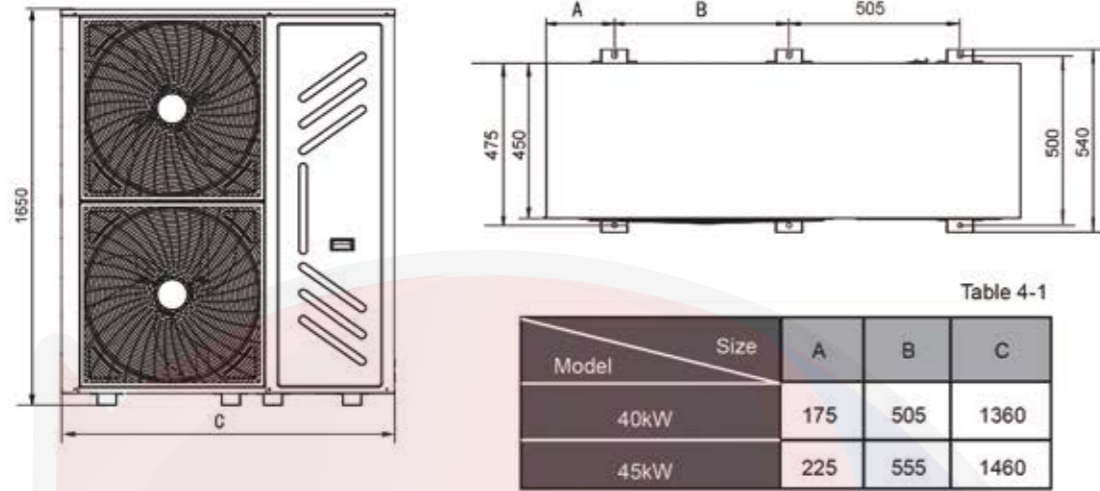

Unit installation : mm

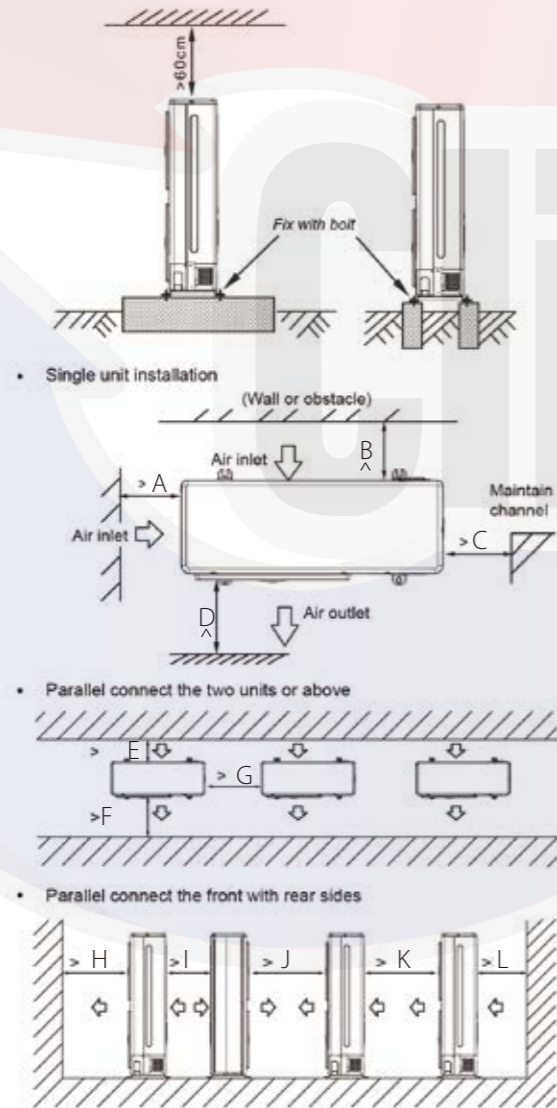

Model (kW)	A	B	C	D	E	F	G	H	I	G	K	L
8-18kW	300	300	600	2000	300	2000	600	2000	500	3000	3000	300
20-26kW	300	300	600	3000	300	3000	600	3000	1000	6000	4000	300
40-15kW	400	400	600	4000	400	4000	600	4000	1000	8000	6000	400

2nd Generation VRF DC INDOOR UNITS





2nd Generation VRF DC INDOOR UNITS

Wide Application Range

Wide Range of Indoor Units

With 11 types and more than 100 models, Carrier VRF indoor units meet varied customer requirements in a wide range of locations including shopping malls, hospitals, office buildings, hotels and airports.



Multiple Appearance Options

For Four-way Cassette and Compact Four-way Cassette Units, interchangeable 360° airflow and four-way airflow panels are available.



360° airflow



Four-way airflow

For Floor Standing Units, the F3B (concealed) unit is designed to be concealed in walls while the F4 (front air intake) and F5 (underside air intake) offer a choice of air intake options.



F3B (concealed)



F4 (front air intake)



F5 (underside air intake)

Comfort and Efficiency

High Efficiency DC Fan Motor

The power consumption of DC fan motor can be reduced greatly in comparison to corresponding AC type.

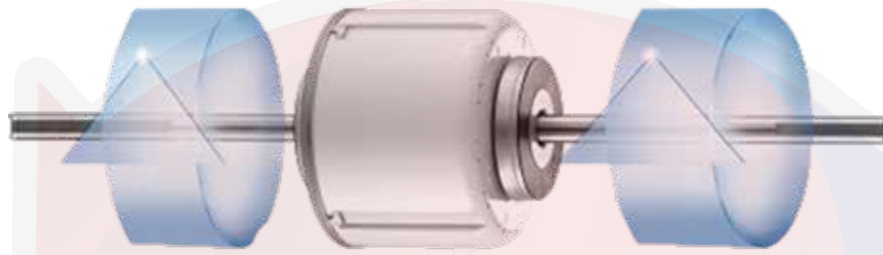

Quiet Operation

The low sound operation DC fan motor and optimized fan blades guarantees the air discharge smoothly and provides a quiet living environment.



Constant Level of Indoor Air Temperature

Plate Heat Exchanger as a secondary intercooler to gain up to 18°C subcooling and improves 10% energy efficiency.

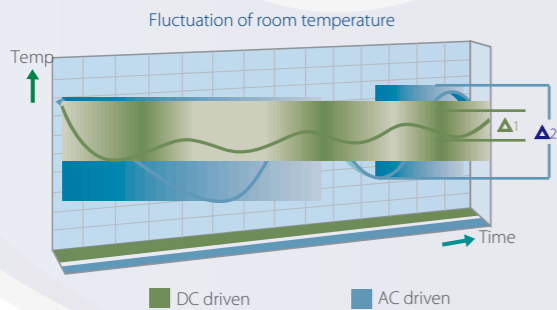

5-step Swing Louver

The air is comfortably spread upwards and downwards thanks to the 5-step swing louver that can be programmed via the controller.

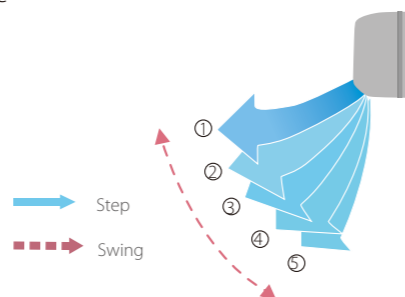

Comfort and Efficiency

Static Pressure 20 Steps Control (Duct Unit)

Depending on the installation environment, medium static pressure duct is controlled the static pressure up to 10 steps and high static pressure duct is controlled the static pressure up to 20 steps via wired remote controller, for providing comfortable environment suitable for any environment.

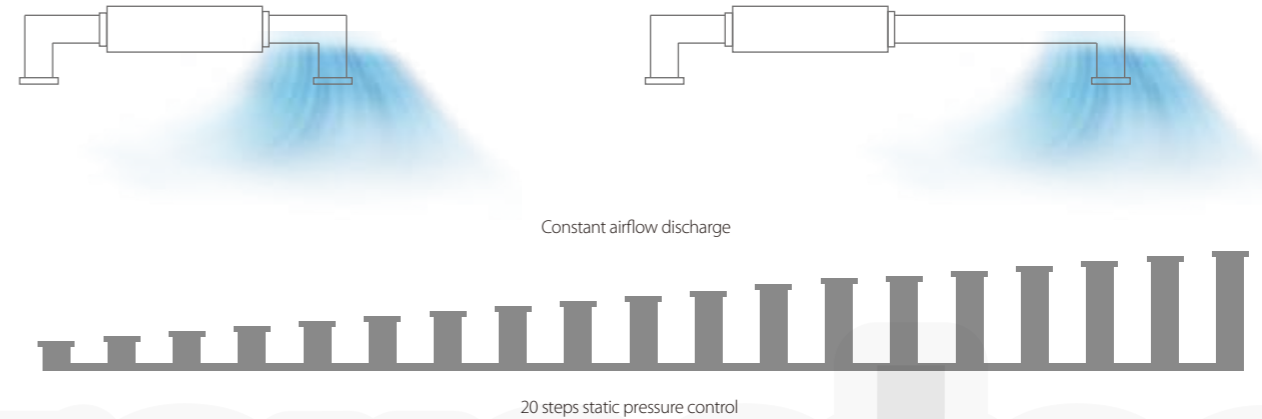

7-Speed Fan Control

7 indoor fan speeds provide control flexibility to meet the needs of different indoor conditions.

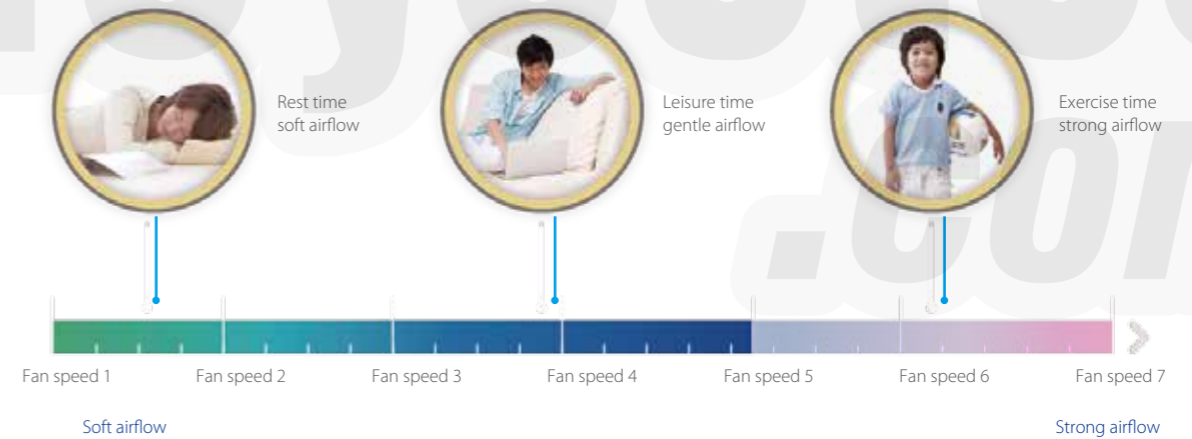

Fresh Air Intake

On selected models, a reserved outside air intake port allows outdoor air to be introduced directly into the unit, negating the need for a separate ventilation system.



Convenience

High-lift Drain Pump

A drain pump with a 750mm or 500mm pump head is fitted as standard or optional, simplifying installation of the drain piping.

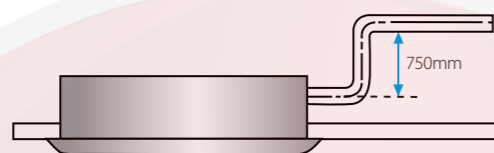

Flexible Installation

For Medium Static Pressure Duct Units, to provide the flexibility to adapt to differing installation situations, the air inlet may be positioned either on the underside or the rear of the unit.

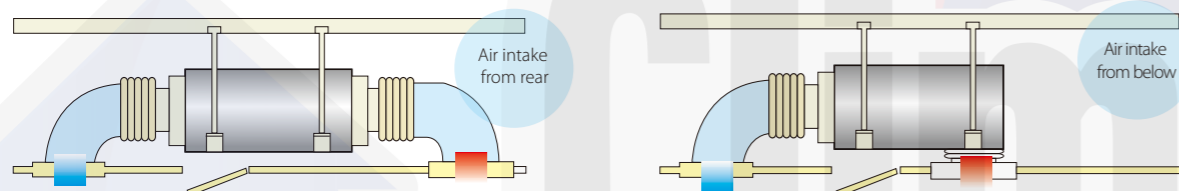

For Wall Mounted Units, the refrigerant outlet direction can be left, right or rear as the installation situation requires. A new fixing plate design speeds installation and provides extra stability.

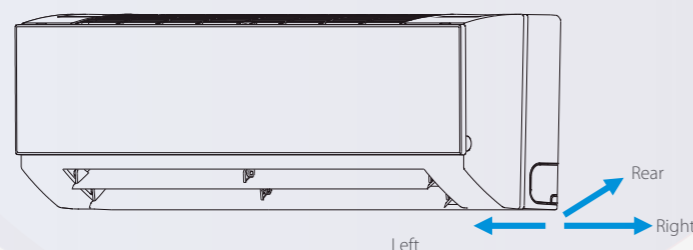

Ceiling / Floor Units can be installed either on the ceiling or the floor, providing flexibility to accommodate a wide range of room designs.

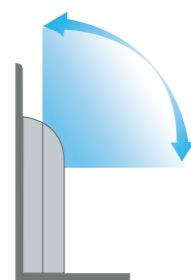

Floor installation

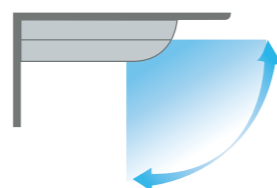

Ceiling installation

One-way Cassette

- Fresh air intake
- One-way air discharge, ideal for corner locations
- Drain pump with 750mm pump head fitted as standard



Standard controller

Optional controller



WL-12B-CM



WL-12D-CM



WR-86KD-CM



WR-120G-CM

Model			40VZ006H11500016	40VZ007H11500016	40VZ009H11500016	40VZ012H11500016
Power supply			1-phase, 220-240V, 50/60Hz			
Cooling ¹	Capacity	kW	1.8	2.2	2.8	3.6
		kBtu/h	6.1	7.5	9.6	12.3
	Power input	W	25	25	30	30
Heating ²	Capacity	kW	2.2	2.6	3.2	4.0
		kBtu/h	7.5	8.9	10.9	13.6
	Power input	W	25	25	30	30
Air flow rate ³		m ³ /h	523/482/448/404/360/312/275		573/531/492/456/420/364/315	
Sound pressure level ⁴		dB(A)	37/36/35/34/32/31/30		39/38/37/36/35/35/34	
Main body	Net dimensions ⁵ (WxHxD)	mm	1054x153x425			
	Packed dimensions (WxHxD)	mm	1155x245x490			
	Net/Gross weight	kg	11.8/15.3		12.3/15.8	
Panel	Net dimensions (WxHxD)	mm	1180x25x465			
	Packed dimensions (WxHxD)	mm	1232x107x517			
	Net/Gross weight	kg	3.5/5.2			
Pipe connections	Liquid/Gas pipe	mm	Φ6.35/Φ12.7			
	Drain pipe	mm	OD Φ32			

Model			40VZ016H11500016	40VZ020H11500016	40VZ024H11500016
Power supply			1-phase, 220-240V, 50/60Hz		
Cooling ¹	Capacity	kW	4.5	5.6	7.1
		kBtu/h	15.4	19.1	24.2
	Power input	W	40	48	60
Heating ²	Capacity	kW	5.0	6.3	8.0
		kBtu/h	17.1	21.5	27.3
	Power input	W	40	48	60
Air flow rate ³		m ³ /h	693/662/638/600/556/510/476	792/763/728/688/643/589/549	933/873/815/749/689/637/592
Sound pressure level ⁴		dB(A)	41/40/39/38/37/36/35	42/41/40/39/38/37/36	44/43/42/41/39/38/37
Main body	Net dimensions ⁵ (WxHxD)	mm	1275x189x450		
	Packed dimensions (WxHxD)	mm	1370x295x505		
	Net/Gross weight	kg	16.1/20.4	16.4/20.7	17.6/22.4
Panel	Net dimensions (WxHxD)	mm	1350x25x505		
	Packed dimensions (WxHxD)	mm	1410x95x560		
	Net/Gross weight	kg	4/5.4		
Pipe connections	Liquid/Gas pipe	mm	Φ6.35/Φ12.7		Φ9.53/Φ15.9
	Drain pipe	mm	OD Φ32		

Notes:

1. Indoor temperature 27°C DB, 19°C WB; outdoor temperature 35°C DB; equivalent refrigerant piping length 7.5m with zero level difference.
2. Indoor temperature 20°C DB; outdoor temperature 7°C DB, 6°C WB; equivalent refrigerant piping length 7.5m with zero level difference.
3. Each model's 7 airflow rate options are listed in order, from highest to lowest.
4. Each model's 7 sound pressure levels are listed in order from highest to lowest and correspond to the model's 7 airflow rate options (see Note 3). Sound pressure level is measured 1.4m below the unit in a semi-anechoic chamber.
5. Unit body dimensions given are the largest external dimensions of the unit, including hanger attachments.

Two-way Cassette

- Two-way air discharge, perfect for limited ceiling space applications
- Drain pump with 750mm pump head fitted as standard
- Fresh air intake



Model	40VT007H11500016		40VT009H11500016		40VT012H11500016	
Power supply	1-phase, 220-240V, 50/60Hz					
Cooling ¹	Capacity	kW	2.2	2.8	3.6	
		kBtu/h	7.5	9.6	12.3	
	Power input	W	35	40	40	
Heating ²	Capacity	kW	2.6	3.2	4.0	
		kBtu/h	8.9	10.9	13.6	
	Power input	W	35	40	40	
Air flow rate ³	m ³ /h	654/612/571/530/488/449/410			725/679/641/591/554/509/458	
Sound pressure level ⁴	dB(A)	33/31/30/29/27/25/24			35/33/32/30/29/27/25	
Main body	Net dimensions ⁵ (WxHxD)	mm	1172x299x591			
	Packed dimensions (WxHxD)	mm	1355x400x675			
	Net/Gross weight	kg	33.5/42.0			
Panel	Net dimensions (WxHxD)	mm	1430x53x680			
	Packed dimensions (WxHxD)	mm	1525x130x765			
	Net/Gross weight	kg	10.5/15			
Pipe connections	Liquid/Gas pipe	mm	Φ6.35/Φ12.7			
	Drain pipe	mm	OD Φ32			

Model	40VT016H11500016		40VT020H11500016		40VT024H11500016	
Power supply	1-phase, 220-240V, 50/60Hz					
Cooling ¹	Capacity	kW	4.5	5.6	7.1	
		kBtu/h	15.4	19.1	24.2	
	Power input	W	50	69	98	
Heating ²	Capacity	kW	5.0	6.3	8.0	
		kBtu/h	17.1	21.5	27.3	
	Power input	W	50	69	98	
Air flow rate ³	m ³ /h	850/792/731/670/631/592/550	980/925/855/800/755/702/670	1200/1115/1068/1000/921/808/770		
Sound pressure level ⁴	dB(A)	37/36/35/34/32/31/30	39/37/36/35/33/31/30	44/42/41/40/38/36/34		
Main body	Net dimensions ⁵ (WxHxD)	mm	1172x299x591			
	Packed dimensions (WxHxD)	mm	1355x400x675			
	Net/Gross weight	kg	35/43.5			
Panel	Net dimensions (WxHxD)	mm	1430x53x680			
	Packed dimensions (WxHxD)	mm	1525x130x765			
	Net/Gross weight	kg	10.5/15			
Pipe connections	Liquid/Gas pipe	mm	Φ6.35/Φ12.7	Φ9.53/Φ15.9		
	Drain pipe	mm	OD Φ32			

Notes:

1. Indoor temperature 27°C DB, 19°C WB; outdoor temperature 35°C DB; equivalent refrigerant piping length 7.5m with zero level difference.
2. Indoor temperature 20°C DB; outdoor temperature 7°C DB, 6°C WB; equivalent refrigerant piping length 7.5m with zero level difference.
3. Each model's 7 airflow rate options are listed in order, from highest to lowest.
4. Each model's 7 sound pressure levels are listed in order from highest to lowest and correspond to the model's 7 airflow rate options (see Note 3). Sound pressure level is measured 1.4m below the unit in a semi-anechoic chamber.
5. Unit body dimensions given are the largest external dimensions of the unit, including hanger attachments.

Compact Four-way Cassette

- 360° airflow allows for even, wide-range cooling and heating
- Drain pump with 500mm pump head fitted as standard



Model	40VX007H11500016		40VX009H11500016		40VX012H11500016		40VX016H11500016	
Power supply	1-phase, 220-240V, 50/60Hz							
Cooling ¹	Capacity	kW	2.2	2.8	3.6	4.5		
		kBtu/h	7.5	9.6	12.3	15.4		
	Power input	W	35	35	40	50		
Heating ²	Capacity	kW	2.4	3.2	4.0	5.0		
		kBtu/h	8.2	10.9	13.6	17.1		
	Power input	W	35	35	40	50		
Air flow rate ³	m ³ /h	576/552/524/503/462/441/405				604/573/541/516/478/434/400		
Sound pressure level ⁴	dB(A)	35/34/33/29/26/23/22				41/38/35/32/30/29/28		
Main body	Net dimensions ⁵ (WxHxD)	mm	630x260x570					
	Packed dimensions (WxHxD)	mm	700x330x660					
	Net/Gross weight	kg	18/23.5		19.2/24.7			
Panel	Net dimensions (WxHxD)	mm	647x50x647					
	Packed dimensions (WxHxD)	mm	715x123x715					
	Net/Gross weight	kg	2.5/4.5					
Pipe connections	Liquid/Gas pipe	mm	Φ6.35/Φ12.7					
	Drain pipe	mm	OD Φ32					

Notes:

1. Indoor temperature 27°C DB, 19°C WB; outdoor temperature 35°C DB; equivalent refrigerant piping length 7.5m with zero level difference.
2. Indoor temperature 20°C DB; outdoor temperature 7°C DB, 6°C WB; equivalent refrigerant piping length 7.5m with zero level difference.
3. Each model's 7 airflow rate options are listed in order, from highest to lowest.
4. Each model's 7 sound pressure levels are listed in order from highest to lowest and correspond to the model's 7 airflow rate options (see Note 3). Sound pressure level is measured 1.4m below the unit in a semi-anechoic chamber.
5. Unit body dimensions given are the largest external dimensions of the unit, including hanger attachments.

Four-way Cassette

- Fresh air intake
- Four-way airflow, allows wide-angle, equal distribution of cooling and heating
- Drain pump with 750mm pump head fitted as standard
- Brand-new, elegant panel with four independently controlled louvers

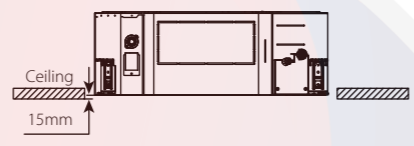
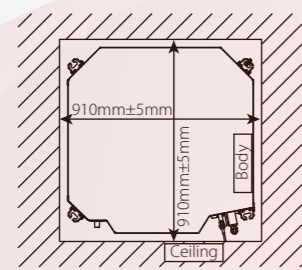

Model	40VK009H11500016	40VK012H11500016	40VK016H11500016	40VK020H11500016	40VK024H11500016		
Power supply	1 phase, 220-240V, 50/60Hz						
Cooling ¹	Capacity	kW	2.8	3.6	4.5	5.6	7.1
		kBtu/h	9.6	12.3	15.4	19.1	24.2
Heating ²	Capacity	kW	2.5	3.1	3.1	4.6	4.6
		kBtu/h	10.9	13.6	17.1	21.5	27.3
Air flow rate ³	m ³ /h 801/751/711/658/637/611/542					893/866/804/744/714/698/635	977/937/864/800/778/738/671
Sound pressure level ⁴	dB(A) 32/31/30/28/26/23					35/34/31/31/30/28/26	35/35/34/31/30/28/27
Main body	Net dimensions ⁵ (WxHxD)	mm	840x230x840				
	Packed dimensions (WxHxD)	mm	955x260x955				
	Net/Gross weight	kg	21.3/25.8		23.2/27.6		
Panel	Net dimensions (WxHxD)	mm	950x54.5x950				
	Packed dimensions (WxHxD)	mm	1035x90x1035				
	Net/Gross weight	kg	5/8				
Pipe connections	Liquid/Gas pipe	mm	Φ6.35/Φ12.7		Φ9.53/Φ15.9		
	Drain pipe	mm	OD Φ32				

Model	40VK028H11500016	40VK030H11500016	40VK034H11500016	40VK036H11500016	40VK048H11500016			
Power supply	1 phase, 220-240V, 50/60Hz							
Cooling ¹	Capacity	kW	8.0	9.0	10.0	11.2	14.0	
		kBtu/h	27.3	30.7	34.1	38.2	47.8	
Heating ²	Capacity	kW	4.8	7.5	7.5	9.4	9.4	
		kBtu/h	30.7	34.1	37.5	42.7	54.6	
Air flow rate ³	m ³ /h 1203/1131/1064/977/912/840/774					1349/1294/1230/1201/1111/1029/970	1641/1544/1431/1309/1225/1198/1143	1662/1574/1448/1348/1253/1219/1170
Sound pressure level ⁴	dB(A) 36/35/34/31/31/29/28					37/35/34/31/31/30/28	38/36/35/34/31/31/30	39/37/36/35/34/31/31
Main body	Net dimensions ⁵ (WxHxD)	mm	904x230x840		840x230x840			
	Packed dimensions (WxHxD)	mm	955x260x955		955x330x955			
	Net/Gross weight	kg	23.2/27.6		28.4/33.8			
Panel	Net dimensions (WxHxD)	mm	950x54.5x950					
	Packed dimensions (WxHxD)	mm	1035x90x1035					
	Net/Gross weight	kg	5/8					
Pipe connections	Liquid/Gas pipe	mm	Φ9.53/Φ15.9		Φ9.53/Φ15.9			
	Drain pipe	mm	OD Φ32					

- Notes:**
1. Indoor temperature 27°C DB, 19°C WB; outdoor temperature 35°C DB; equivalent refrigerant piping length 7.5m with zero level difference.
 2. Indoor temperature 20°C DB; outdoor temperature 7°C DB, 6°C WB; equivalent refrigerant piping length 7.5m with zero level difference.
 3. Each model's 7 airflow rate options are listed in order, from highest to lowest.
 4. Each model's 7 sound pressure levels are listed in order from highest to lowest and correspond to the model's 7 airflow rate options (see Note 3). Sound pressure level is measured 1.4m below the unit in a semi-anechoic chamber.
 5. Unit body dimensions given are the largest external dimensions of the unit, including hanger attachments.

Medium Static Pressure Duct

- Fresh air intake
- 6-step static pressure control on 2.2kW to 7.1kW models and 10-step static pressure control on 8kW to 14kW units (requires latest generation wired controllers)
- Drain pump with 750mm pump head fitted as standard
- Flexible installation for the air inlet may be positioned either on the underside or the rear of the unit



Model	42VD007H115003016		42VD009H115003016		42VD012H115003016	
Power supply	1 phase, 220-240V, 50/60Hz					
Cooling ¹	Capacity	kW	2.2	2.8	3.6	3.6
		kBtu/h	7.5	9.6	12.3	12.3
Heating ²	Capacity	kW	4.0	4.0	4.0	4.0
		kBtu/h	10.9	10.9	13.6	13.6
Air flow rate ³	m ³ /h 520/480/440/400/360/330/300					580/540/500/460/430/400/370
External static pressure	Pa 10 (0~50)					
Sound pressure level ⁴	dB(A) 32/31/29/28/26/25/23					
Unit	Net dimensions ⁵ (WxHxD)	mm	780x210x500			
	Packed dimensions (WxHxD)	mm	870x285x525			
	Net/Gross weight	kg	18/21			
Pipe connections	Liquid/Gas pipe	mm	Φ6.35/Φ12.7			
	Drain pipe	mm	OD Φ25			

Model	42VD016H115003016		42VD020H115003016		42VD024H115003016		
Power supply	1 phase, 220-240V, 50/60Hz						
Cooling ¹	Capacity	kW	4.5	5.6	7.1	7.1	
		kBtu/h	15.4	19.1	24.2	24.2	
Heating ²	Capacity	kW	9.2	9.2	9.8	9.8	
		kBtu/h	17.1	21.5	27.3	27.3	
Air flow rate ³	m ³ /h 800/740/680/620/540/480/400					830/760/720/680/640/600/560	1000/960/900/840/780/720/680
External static pressure	Pa 10 (0~50)						
Sound pressure level ⁴	dB(A) 36/34/32/31/29/27/25						
Unit	Net dimensions ⁵ (WxHxD)	mm	1000x210x500				
	Packed dimensions (WxHxD)	mm	1115x285x525				
	Net/Gross weight	kg	21.5/25				
Pipe connections	Liquid/Gas pipe	mm	Φ6.35/Φ12.7		Φ9.53/Φ15.9		
	Drain pipe	mm	OD Φ25				

Model	42VD028H115003016		42VD030H115003016		42VD036H115003016		42VD048H115003016		
Power supply	1 phase, 220-240V, 50/60Hz								
Cooling ¹	Capacity	kW	8.0	9.0	11.2	14.0	14.0	14.0	
		kBtu/h	27.3	30.7	38.2	47.8	47.8	47.8	
Heating ²	Capacity	kW	110	120	200	250	250	250	
		kBtu/h	30.7	34.1	42.7	52.9	52.9	52.9	
Air flow rate ³	m ³ /h 1260/1180/1100/1020/940/860/780							1500/1430/1360/1290/1210/1140/1080	1960/1860/1760/1660/1560/1460/1360
External static pressure	Pa 20 (10~100)								
Sound pressure level ⁴	dB(A) 37/35/34/33/31/29/28								
Unit	Net dimensions ⁵ (WxHxD)	mm	1230x270x775					1290x300x865	
	Packed dimensions (WxHxD)	mm	1355x350x795					1400x375x925	
	Net/Gross weight	kg	36.5/44.5		37/45		46.5/55.5		
Pipe connections	Liquid/Gas pipe	mm	Φ9.53/Φ15.9						
	Drain pipe	mm	OD Φ25						

- Notes:**
1. Indoor temperature 27°C DB, 19°C WB; outdoor temperature 35°C DB; equivalent refrigerant piping length 7.5m with zero level difference.
 2. Indoor temperature 20°C DB; outdoor temperature 7°C DB, 6°C WB; equivalent refrigerant piping length 7.5m with zero level difference.
 3. Each model's 7 airflow rate options are listed in order, from highest to lowest.
 4. Each model's 7 sound pressure levels are listed in order from highest to lowest and correspond to the model's 7 airflow rate options (see Note 3). Sound pressure level is measured 1.4m below the unit in a semi-anechoic chamber.
 5. Unit body dimensions given are the largest external dimensions of the unit, including hanger attachments. All specifications are measured at standard external static pressure.

High Static Pressure Duct



Optional controller



- External static pressure up to 400Pa facilitates extensive duct and grille network
- 20-step static pressure control on all models (requires latest generation wired controllers)
- A double-skin drainage pan provides double protection for ceilings (models 71 to 160).
- Water pump box is available as a customization option

Model	42VD024H115011016		42VD028H115011016		42VD030H115011016	
Power supply	1 phase, 220-240V, 50/60Hz					
Cooling ¹	Capacity	kW	7.1	8.0	9.0	
		kBtu/h	24.2	27.3	30.7	
Heating ²	Capacity	kW	8.0	9.0	10.0	
		kBtu/h	27.3	30.7	34.1	
Power input	W	180	180	220		
Air flow rate ³	m ³ /h	1360/1327/1293/1260/1227/1193/1160		1360/1327/1293/1260/1227/1193/1160		1420/1373/1327/1280/1233/1187/1140
External static pressure	Pa	100 (30~200)		100 (30~200)		
Sound pressure level ⁴	dB(A)	46/46/45/45/44/43/42		46/46/45/45/44/43/42		50/49/48/48/47/46/45
Unit	Net dimensions ⁵ (WxHxD)	mm	952x420x690		1090x440x768	
	Packed dimensions (WxHxD)	mm	952x420x690		1090x440x768	
	Net/Gross weight	kg	41/47		51/57	
Pipe connections	Liquid/Gas pipe	mm	Φ9.53/Φ15.9		Φ9.53/Φ15.9	
	Drain pipe	mm	OD Φ25		OD Φ25	

Model	42VD036H115011016		42VD048H115011016		42VD054H115011016		42VD070H115011016	
Power supply	1 phase, 220-240V, 50/60Hz							
Cooling ¹	Capacity	kW	11.2	14.0	16.0	20.0		
		kBtu/h	38.2	47.8	54.6	68.2		
Heating ²	Capacity	kW	12.5	16.0	17.0	22.5		
		kBtu/h	42.7	54.6	58.0	76.8		
Power input	W	380	420	700	990			
Air flow rate ³	m ³ /h	1870/1783/1697/1610/1523/1437/1350		2240/2133/2027/1920/1813/1707/1600		2660/2530/2400/2270/2140/2010/1880		4330/4230/4130/4030/3930/3830/3730
External static pressure	Pa	100 (30~200)		100 (30~200)		170 (20~250)		
Sound pressure level ⁴	dB(A)	50/50/49/48/47/46/45		53/52/51/51/50/49/48		54/54/53/52/51/50/50		57/56/55/54/53/52/50
Unit	Net dimensions ⁵ (WxHxD)	mm	952x420x690		1300x420x690		1440x505x925	
	Packed dimensions (WxHxD)	mm	1090x440x768		1436x450x768		1509x550x990	
	Net/Gross weight	kg	51/57		63/70		130/142	
Pipe connections	Liquid/Gas pipe	mm	Φ9.53/Φ19.1		Φ12.7/Φ22.2		Φ12.7/Φ22.2	
	Drain pipe	mm	OD Φ25		OD Φ32		OD Φ32	

Model	42VD085H115011016		42VD096H115011016		42VD140H115011016		42VD160H115011016		42VD190H115011016	
Power supply	1 phase, 220-240V, 50/60Hz									
Cooling ¹	Capacity	kW	25.0	28.0	40.0	45.0	56			
		kBtu/h	85.3	95.5	136.5	153.6	191.1			
Heating ²	Capacity	kW	26.0	31.5	45.0	56.0	63			
		kBtu/h	88.7	107.5	153.6	191.1	215			
Power input	W	1200	1200	1800	1800	2272				
Air flow rate ³	m ³ /h	4330/4230/4130/4030/3930/3830/3730				6500/6150/5800/5450/5100/4750/4400		7400/7000/6600/6200/5800/5400/5000		
External static pressure	Pa	170 (20~250)				300 (100~400)		300 (100~400)		
Sound pressure level ⁴	dB(A)	57/56/55/54/53/52/50				60/59/58/57/55/54/52		59/58/57/56/55/53/51		
Unit	Net dimensions ⁵ (WxHxD)	mm	1440x505x925		2005x929x670		2005x929x670		2095x964x800	
	Packed dimensions (WxHxD)	mm	1509x550x990		2095x964x800		2095x964x800		2095x964x800	
	Net/Gross weight	kg	130/142		210/235		218/248		218/248	
Pipe connections	Liquid/Gas pipe	mm	Φ12.7/Φ22.2		Φ15.9/Φ28.6		Φ15.9/Φ28.6		Φ15.9/Φ28.6	
	Drain pipe	mm	OD Φ32		OD Φ32		OD Φ32		OD Φ32	

Notes:
 1. Indoor temperature 27°C DB, 19°C WB; outdoor temperature 35°C DB; equivalent refrigerant piping length 7.5m with zero level difference.
 2. Indoor temperature 20°C DB; outdoor temperature 7°C DB, 6°C WB; equivalent refrigerant piping length 7.5m with zero level difference.
 3. Each model's 7 airflow rate options are listed in order, from highest to lowest.
 4. Each model's 7 sound pressure levels are listed in order from highest to lowest and correspond to the model's 7 airflow rate options (see Note 3). Sound pressure level is measured 1.4m below the unit in a semi-anechoic chamber.
 5. Unit body dimensions given are the largest external dimensions of the unit, including hanger attachments. All specifications are measured at standard external static pressure.

Fresh Air Processing Unit



Optional controller



- 100% fresh air processing unit, both fresh air filtration and heating/cooling can be achieved in a single system
- External static pressure up to 400Pa facilitates extensive duct and grille network
- 20-step static pressure control on all models (requires latest generation wired controllers)
- Water pump box is available as a customization option

Model	42VD042H115211016		42VD048H115211016	
Power supply	1 phase, 220-240V, 50/60Hz			
Cooling ¹	Capacity	kW	12.5	14.0
		kBtu/h	42.6	47.8
Heating ²	Capacity	kW	10.5	12.0
		kBtu/h	36.0	41.0
Power input	W	370	370	
Air flow rate ³	m ³ /h	2000/1917/1833/1750/1667/1583/1500		
External static pressure	Pa	180 (30~200)		
Sound pressure level ⁴	dB(A)	48/47/46/45/44/43/42		
Unit	Net dimensions ⁵ (WxHxD)	mm	1300x420x690	
	Packed dimensions (WxHxD)	mm	1436x450x768	
	Net/Gross weight	kg	63/70	
Pipe connections	Liquid/Gas pipe	mm	Φ9.53/Φ19.1	
	Drain pipe	mm	OD Φ25	

Model	42VD070H115211016		42VD085H115211016		42VD096H115211016		42VD160H115211016		42VD190H115211016	
Power supply	1 phase, 220-240V, 50/60Hz									
Cooling ¹	Capacity	kW	20.0	25.0	28.0	45.0	56			
		kBtu/h	68.2	85.3	95.5	153.6	191			
Heating ²	Capacity	kW	18.0	20.0	22.0	28.0	39			
		kBtu/h	61.4	68.2	75.0	95.6	133			
Power input	W	615	670	670	1080	2272				
Air flow rate ³	m ³ /h	3000/2833/2667/2500/2333/2167/2000					4200/3967/3733/3500/3267/3033/2800		7400/7000/6600/6200/5800/5400/5000	
External static pressure	Pa	200 (30~250)					300 (100~400)			
Sound pressure level ⁴	dB(A)	50/49/48/47/46/44/43					58/56/55/53/51/49/48		59/58/57/56/54/53/51	
Unit	Net dimensions ⁵ (WxHxD)	mm	1450x505x925		2005x929x670		2095x964x800			
	Packed dimensions (WxHxD)	mm	1509x550x990		2005x929x670		2095x964x800			
	Net/Gross weight	kg	130/142		210/235		218/248			
Pipe connections	Liquid/Gas pipe	mm	Φ12.7/Φ22.2		Φ15.9/Φ28.6		Φ15.9/Φ28.6			
	Drain pipe	mm	OD Φ32		OD Φ32		OD Φ32			

Notes:
 1. Indoor temperature 27°C DB, 19°C WB; outdoor temperature 35°C DB; equivalent refrigerant piping length 7.5m with zero level difference.
 2. Indoor temperature 20°C DB; outdoor temperature 7°C DB, 6°C WB; equivalent refrigerant piping length 7.5m with zero level difference.
 3. Each model's 7 airflow rate options are listed in order, from highest to lowest.
 4. Each model's 7 sound pressure levels are listed in order from highest to lowest and correspond to the model's 7 airflow rate options (see Note 3). Sound pressure level is measured 1.4m below the unit in a semi-anechoic chamber.
 5. Unit body dimensions given are the largest external dimensions of the unit, including hanger attachments. All specifications are measured at standard external static pressure.

Wall Mounted Unit

- Three interchangeable panels allow units to blend easily with any interior decoration, perfect for rooms with no false ceilings or free floor space
- Refrigerant outlet direction can be left, right or rear as the installation situation requires



Model	42VH007H115000106		42VH009H115000106	
Power supply	1 phase, 220-240V, 50/60Hz			
Cooling ¹	Capacity	kW	2.2	2.8
		kBtu/h	7.5	9.6
	Power input	W	28	28
Heating ²	Capacity	kW	2.4	3.2
		kBtu/h	8.2	10.9
	Power input	W	28	28
Air flow rate ³	m ³ /h	422/411/402/393/380/368/356		417/402/386/370/353/338/316
Sound pressure level ⁴	dB(A)	31/30/30/30/29/29/29		31/30/30/30/29/29/29
Unit	Net dimensions ⁵ (WxHxD)	mm	835x280x203	
	Packed dimensions (WxHxD)	mm	935x385x320	
	Net/Gross weight	kg	8.4/12.1	9.5/13.1
Pipe connections	Liquid/Gas pipe	mm	Φ6.35/Φ12.7	
	Drain pipe	mm	OD Φ16	

Model	42VH012H115000106		42VH016H115000106		42VH020H115000106	
Power supply	1 phase, 220-240V, 50/60Hz					
Cooling ¹	Capacity	kW	3.6	4.5	5.6	
		kBtu/h	12.3	15.4	19.1	
	Power input	W	30	40	45	
Heating ²	Capacity	kW	4.0	5.0	6.3	
		kBtu/h	13.6	17.1	21.5	
	Power input	W	30	40	45	
Air flow rate ³	m ³ /h	656/628/591/573/544/515/488		594/563/535/507/478/450/424		747/713/685/648/613/578/547
Sound pressure level ⁴	dB(A)	33/32/32/31/31/30/30		35/34/33/33/32/31/31		38/37/36/36/35/34/34
Unit	Net dimensions ⁵ (WxHxD)	mm	990x315x223			
	Packed dimensions (WxHxD)	mm	1085x420x335			
	Net/Gross weight	kg	11.4/15.5	12.8/16.9		
Pipe connections	Liquid/Gas pipe	mm	Φ6.35/Φ12.7		Φ9.53/Φ15.9	
	Drain pipe	mm	OD Φ16			

Model	42VH024H115000106		42VH028H115000106		42VH030H115000106	
Power supply	1 phase, 220-240V, 50/60Hz					
Cooling ¹	Capacity	kW	7.1	8.0	9.0	
		kBtu/h	24.2	27.3	30.7	
	Power input	W	55	55	82	
Heating ²	Capacity	kW	8.0	9.0	10.0	
		kBtu/h	27.3	30.7	34.1	
	Power input	W	55	55	82	
Air flow rate ³	m ³ /h	1195/1130/1065/1005/940/875/809		1195/1130/1065/1005/940/875/809		1421/1300/1125/1067/1005/934/867
Sound pressure level ⁴	dB(A)	44/43/42/39/38/37/36		44/43/42/39/38/37/36		48/46/45/43/41/40/38
Unit	Net dimensions ⁵ (WxHxD)	mm	1194x343x262			
	Packed dimensions (WxHxD)	mm	1290x375x460			
	Net/Gross weight	kg	17.0/22.4			
Pipe connections	Liquid/Gas pipe	mm	Φ9.53/Φ15.9			
	Drain pipe	mm	OD Φ16			

- Notes:
1. Indoor temperature 27°C DB, 19°C WB; outdoor temperature 35°C DB; equivalent refrigerant piping length 7.5m with zero level difference.
 2. Indoor temperature 20°C DB; outdoor temperature 7°C DB, 6°C WB; equivalent refrigerant piping length 7.5m with zero level difference.
 3. Each model's 7 airflow rate options are listed in order, from highest to lowest.
 4. Each model's 7 sound pressure levels are listed in order from highest to lowest and correspond to the model's 7 airflow rate options (see Note 3). Sound pressure level is measured 1m in front and 1m below the unit in a semi-anechoic chamber.
 5. Unit body dimensions given are the largest external dimensions of the unit, including hanger attachments.

Ceiling / Floor

Can be installed either on the ceiling or floor



Model	42VF012H115000016		42VF016H115000016		42VF020H115000016		42VF024H115000016	
Power supply	1 phase, 220-240V, 50/60Hz							
Cooling ¹	Capacity	kW	3.6	4.5	5.6	7.1		
		kBtu/h	12.3	15.4	19.1	24.2		
	Power input	W	49	115	115	115		
Heating ²	Capacity	kW	4.0	5.0	6.3	8.0		
		kBtu/h	13.6	17.1	21.5	27.3		
	Power input	W	49	115	115	115		
Air flow rate ³	m ³ /h	550/525/500/480/460/440/420			930/895/860/830/792/755/720			
Sound pressure level ⁴	dB(A)	40/39/38/38/37/36/36			43/42/41/41/39/38/38			

Unit	Net dimensions ⁵ (WxHxD)	mm	990x660x203					
	Packed dimensions (WxHxD)	mm	1089x744x296					
	Net/Gross weight	kg	26/32			28/34		
Pipe connections	Liquid/Gas pipe	mm	Φ6.35/Φ12.7			Φ9.53/Φ15.9		
	Drain pipe	mm	OD Φ16					

Model	42VF028H115000016		42VF030H115000016		42VF036H115000016		42VF048H115000016		
Power supply	1 phase, 220-240V, 50/60Hz								
Cooling ¹	Capacity	kW	8.0	9.0	11.2	14.0			
		kBtu/h	27.2	30.7	38.2	47.8			
	Power input	W	130	130	180	180			
Heating ²	Capacity	kW	9.0	10.0	12.5	15.0			
		kBtu/h	30.7	34.1	42.7	51.2			
	Power input	W	130	130	180	180			
Air flow rate ³	m ³ /h	1280/1245/1210/1170/1130/1085/1050			1890/1830/1765/1700/1660/1620/1580				
Sound pressure level ⁴	dB(A)	45/44/43/43/42/41/40			47/46/45/45/44/43/42				
Unit	Net dimensions ⁵ (WxHxD)	mm	1280x660x203				1670x680x244		
	Packed dimensions (WxHxD)	mm	1379x744x296				1915x760x330		
	Net/Gross weight	kg	35/41		48/58				
Pipe connections	Liquid/Gas pipe	mm	Φ9.53/Φ15.9						
	Drain pipe	mm	OD Φ16						

- Notes:
1. Indoor temperature 27°C DB, 19°C WB; outdoor temperature 35°C DB; equivalent refrigerant piping length 7.5m with zero level difference.
 2. Indoor temperature 20°C DB; outdoor temperature 7°C DB, 6°C WB; equivalent refrigerant piping length 7.5m with zero level difference.
 3. Each model's 7 airflow rate options are listed in order, from highest to lowest.
 4. Each model's 7 sound pressure levels are listed in order from highest to lowest and correspond to the model's 7 airflow rate options (see Note 3). Floor standing: Sound pressure level is measured 1m in front and 1m above the floor in a semi-anechoic chamber. Ceiling mounted: Sound pressure level is measured 1m in front and 1m below the unit in a semi-anechoic chamber.
 5. Unit body dimensions given are the largest external dimensions of the unit, including hanger attachments.

Floor Standing Unit (Concealed)

- Designed to be concealed in walls with only the suction and discharge grills visible



Model		42VS007H115003016		42VS009H115003016	
Power supply		1 phase, 220-240V, 50/60Hz			
Cooling ¹	Capacity	kW	2.2	2.8	
		kBtu/h	7.5	9.6	
Power input		W	40	45	
Heating ²	Capacity	kW	2.4	3.2	
		kBtu/h	8.2	10.9	
Power input		W	40	45	
Air flow rate ³		m ³ /h	530/504/478/456/439/418/400		569/540/515/485/462/443/421
Sound pressure level ⁴		dB(A)	36/35/34/33/31/30/29		36/35/34/33/31/30/29
Unit	Net dimensions ⁵ (WxHxD)	mm	840x545x212		
	Packed dimensions (WxHxD)	mm	925x639x305		
	Net/Gross weight	kg	21/25.5		
Pipe connections	Liquid/Gas pipe	mm	Φ6.35/Φ12.7		
	Drain pipe	mm	Φ16		

Model		42VS012H115003016		42VS016H115003016	
Power supply		1 phase, 220-240V, 50/60Hz			
Cooling ¹	Capacity	kW	3.6	4.5	
		kBtu/h	12.3	15.4	
Power input		W	55	60	
Heating ²	Capacity	kW	4.0	5.0	
		kBtu/h	13.6	17.1	
Power input		W	55	60	
Air flow rate ³		m ³ /h	624/591/557/522/473/420/375		660/625/583/542/501/475/440
Sound pressure level ⁴		dB(A)	37/36/35/34/32/31/30		37/36/35/34/32/31/30
Unit	Net dimensions ⁵ (WxHxD)	mm	1036x639x305		
	Packed dimensions (WxHxD)	mm	1125x639x305		
	Net/Gross weight	kg	25.5/30.5		
Pipe connections	Liquid/Gas pipe	mm	Φ6.35/Φ12.7		
	Drain pipe	mm	Φ16		

Model		42VS020H115003016		42VS024H115003016		42VS028H115003016	
Power supply		1 phase, 220-240V, 50/60Hz					
Cooling ¹	Capacity	kW	5.6	7.1	8.0		
		kBtu/h	19.1	24.2	27.3		
Power input		W	88	110	130		
Heating ²	Capacity	kW	6.3	8.0	9.0		
		kBtu/h	21.5	27.3	30.7		
Power input		W	88	110	130		
Air flow rate ³		m ³ /h	1150/1094/1028/970/925/886/830		1380/1290/1205/1100/1033/955/870		1380/1290/1205/1100/1033/955/870
Sound pressure level ⁴		dB(A)	41/39/37/35/33/32/31		44/42/40/39/37/35/33		44/42/40/39/37/35/33
Unit	Net dimensions ⁵ (WxHxD)	mm	1340x545x212				
	Packed dimensions (WxHxD)	mm	1425x639x305				
	Net/Gross weight	kg	30.5/35.5		32/37		
Pipe connections	Liquid/Gas pipe	mm	Φ9.53/Φ15.9				
	Drain pipe	mm	Φ16				

- Notes:
- Indoor temperature 27°C DB, 19°C WB; outdoor temperature 35°C DB; equivalent refrigerant piping length 7.5m with zero level difference.
 - Indoor temperature 20°C DB; outdoor temperature 7°C DB, 6°C WB; equivalent refrigerant piping length 7.5m with zero level difference.
 - Each model's 7 airflow rate options are listed in order, from highest to lowest.
 - Each model's 7 sound pressure levels are listed in order from highest to lowest and correspond to the model's 7 airflow rate options (see Note 3). Sound pressure level is measured 1m in front and 1m above the floor in a semi-anechoic chamber.
 - Unit body dimensions given are the largest external dimensions of the unit, including hanger attachments.
- All specifications are measured at 10Pa external static pressure.

Floor Standing Unit (Exposed)

The F4 (front air intake) and F5 (underside air intake) offer a choice of air intake options



Model		42VS007H115002016		42VS009H115002016	
Power supply		1 phase, 220-240V, 50/60Hz			
Cooling ¹	Capacity	kW	2.2	2.8	
		kBtu/h	7.5	9.6	
Power input		W	40	45	
Heating ²	Capacity	kW	2.4	3.2	
		kBtu/h	8.2	10.9	
Power input		W	40	45	
Air flow rate ³		m ³ /h	530/504/478/456/439/418/400		569/540/515/485/462/443/421
Sound pressure level ⁴		dB(A)	36/35/34/33/31/30/29		36/35/34/33/31/30/29
Unit	Net dimensions ⁵ (WxHxD)	mm (F4)	1000x596x225		
		mm (F5)	1000x677x220		
	Packed dimensions (WxHxD)	mm (F4)	1089x683x312		
		mm (F5)	1182x683x312		
Net/Gross weight		kg (F4)	28/33		
		kg (F5)	28/35		
Pipe connections	Liquid/Gas pipe	mm	Φ6.35/Φ12.7		
	Drain pipe	mm	Φ16		

Model		42VS012H115002016		42VS016H115002016	
Power supply		1 phase, 220-240V, 50/60Hz			
Cooling ¹	Capacity	kW	3.6	4.5	
		kBtu/h	12.3	15.4	
Power input		W	55	60	
Heating ²	Capacity	kW	4.0	5.0	
		kBtu/h	13.6	17.1	
Power input		W	55	60	
Air flow rate ³		m ³ /h	624/591/557/522/473/420/375		660/625/583/542/501/475/440
Sound pressure level ⁴		dB(A)	37/36/35/34/32/31/30		37/36/35/34/32/31/30
Unit	Net dimensions ⁵ (WxHxD)	mm (F4)	1200x596x225		
		mm (F5)	1200x677x220		
	Packed dimensions (WxHxD)	mm (F4)	1289x683x312		
		mm (F5)	1382x683x312		
Net/Gross weight		kg (F4)	33/38.6		
		kg (F5)	33/40.7		
Pipe connections	Liquid/Gas pipe	mm	Φ6.35/Φ12.7		
	Drain pipe	mm	Φ16		

Model		42VS020H115002016		42VS024H115002016		42VS028H115002016	
Power supply		1 phase, 220-240V, 50/60Hz					
Cooling ¹	Capacity	kW	5.6	7.1	8.0		
		kBtu/h	19.1	24.2	27.3		
Power input		W	88	110	130		
Heating ²	Capacity	kW	6.3	8.0	9.0		
		kBtu/h	21.5	27.3	30.7		
Power input		W	88	110	130		
Air flow rate ³		m ³ /h	1150/1094/1028/970/925/886/830		1380/1290/1205/1100/1033/955/870		1380/1290/1205/1100/1033/955/870
Sound pressure level ⁴		dB(A)	41/39/37/35/33/32/31		44/42/40/39/37/35/33		44/42/40/39/37/35/33
Unit	Net dimensions ⁵ (WxHxD)	mm (F4)	1500x596x225				
		mm (F5)	1500x677x220				
	Packed dimensions (WxHxD)	mm (F4)	1589x683x312				
		mm (F5)	1682x683x312				
Net/Gross weight		kg (F4)	40/46		41.5/47.5		
		kg (F5)	40.4/48.6		41.5/49.5		
Pipe connections	Liquid/Gas pipe	mm	Φ9.53/Φ15.9				
	Drain pipe	mm	Φ16				

- Notes:
- Indoor temperature 27°C DB, 19°C WB; outdoor temperature 35°C DB; equivalent refrigerant piping length 7.5m with zero level difference.
 - Indoor temperature 20°C DB; outdoor temperature 7°C DB, 6°C WB; equivalent refrigerant piping length 7.5m with zero level difference.
 - Each model's 7 airflow rate options are listed in order, from highest to lowest.
 - Each model's 7 sound pressure levels are listed in order from highest to lowest and correspond to the model's 7 airflow rate options (see Note 3). Sound pressure level is measured 1m in front and 1m above the floor in a semi-anechoic chamber.
 - Unit body dimensions given are the largest external dimensions of the unit, including hanger attachments.

Console

- Combination of four air inlets and two air outlets ensures that cooling and heating are distributed in all directions.



Standard controller

Optional controller



WL-12B-CM



WL-12D-CM



WR-86KD-CM



WR-120G-CM

Model			42VC007H115000016	42VC009H115000016	42VC012H115000016	42VC016H115000016
Power supply			1 phase, 220-240V, 50/60Hz			
Cooling ¹	Capacity	kW	2.2	2.8	3.6	4.5
		kBtu/h	7.5	9.6	12.3	15.4
	Power input	W	20	25	25	35
Heating ²	Capacity	kW	2.6	3.2	4.0	5.0
		kBtu/h	8.9	10.9	13.4	17.1
	Power input	W	20	25	25	35
Air flow rate ³		m ³ /h	430/401/374/345/302/268/229	510/482/456/430/355/286/229	660/614/561/512/478/436/400	
Sound pressure level ⁴		dB(A)	38/36/34/32/28/27/26	39/37/35/33/31/29/27	42/41/40/39/37/36/36	
Unit	Net dimensions ⁵ (WxHxD)		mm 700x600x210			
	Packed dimensions (WxHxD)		mm 810x710x305			
	Net/Gross weight		kg	14/19	15/20	
Pipe connections	Liquid/Gas pipe		mm Φ 6.35/ Φ 12.7			
	Drain pipe		mm OD Φ 16			

Notes:

1. Indoor temperature 27°C DB, 19°C WB; outdoor temperature 35°C DB; equivalent refrigerant piping length 7.5m with zero level difference.
2. Indoor temperature 20°C DB; outdoor temperature 7°C DB, 6°C WB; equivalent refrigerant piping length 7.5m with zero level difference.
3. Each model's 7 airflow rate options are listed in order, from highest to lowest.
4. Each model's 7 sound pressure levels are listed in order from highest to lowest and correspond to the model's 7 airflow rate options (see Note 3). Sound pressure level is measured 1m in front and 1m above the floor in a semi-anechoic chamber.
5. Unit body dimensions given are the largest external dimensions of the unit, including hanger attachments.

CONTROL SOLUTIONS

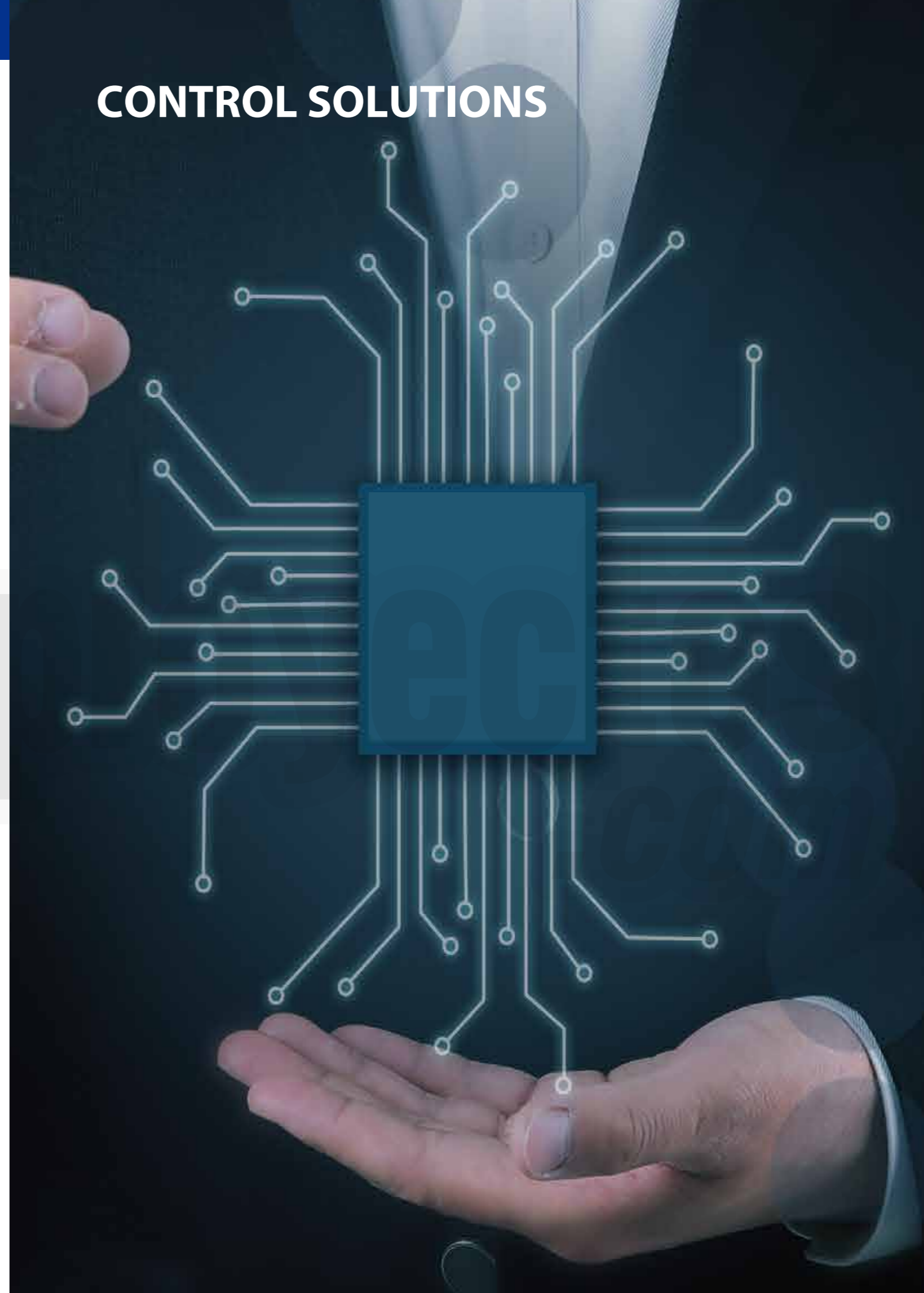



CONTROLLER LINEUP

Wireless Remote Controllers	Wired Controllers	Centralized Controllers		Network Control System	BMS Gateways	Accessories
<p>WL-12B-CM</p> 	<p>WR-86K-CM</p> 	<p>CRF-180A-CM</p> 		<p>4GNS-20-CM Phased out on 31 Dec 2019</p> 	<p>NW-BAC-CM Phased out on 31 Dec 2019</p> 	<p>Hotel Key Card Interface Module</p>  <p>CA-NIM05/E</p>  <p>CA-NIM05B/E</p>
<p>WL-12D-CM</p> 	<p>WR-86KD-CM</p> 	<p>CRF-270B-CM</p> 		<p>OR</p>  <p>4GNS-BAC-CM</p> <p>OR</p>  <p>CRF-270B-CM</p>	<p>GW-LON</p> 	<p>Infrared Sensor Controller</p>  <p>CA-NIM09</p>
	<p>WR-120G-CM</p> 			<p>+</p>  <p>4GNS-20-IF</p> <p>=</p> <p>Intelligent Management System</p>	<p>NW-MOD-CM</p> 	<p>Diagnosis software</p>  <p>VRF-DIAG-B</p>

Wireless Remote Controllers



Features

Model	 WL-12B-CM	 WL-12D-CM
On / Off	●	●
Mode selection	●	●
Temperature setting	● (0.5°C or 1°C steps)	● (0.5°C or 1°C steps)
7-speed fan control	●	●
Auto swing	●	●
5-step swing louver	●	●
Address setting	●	●
Follow me	■	●
Eco mode	●	●
Night silent mode	●	●
Display shut-off	●	●
Daily timer	●	●
Keyboard lock	●	●
Background light	●	●
Dimensions (HxWxD) (mm)	150x65x20	170x48x20
Batteries	1.5V (LR03/AAA) x 2	

Temperature Setting

Set temperature can be adjusted in 0.5°C or 1°C steps, enabling precise comfort control.

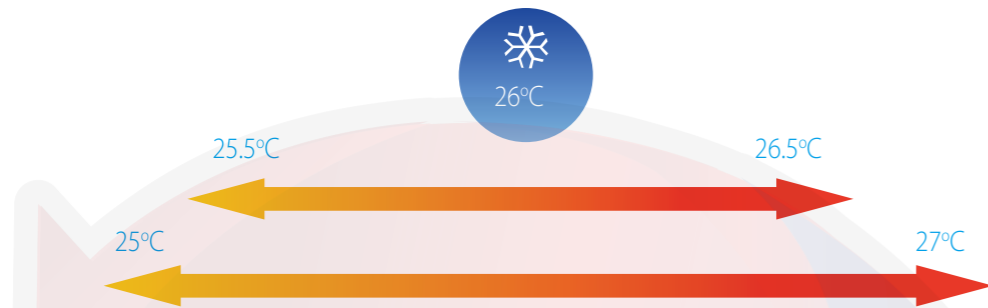

7-Speed Fan Control

7 indoor fan speeds provide control flexibility to meet the needs of different indoor conditions.

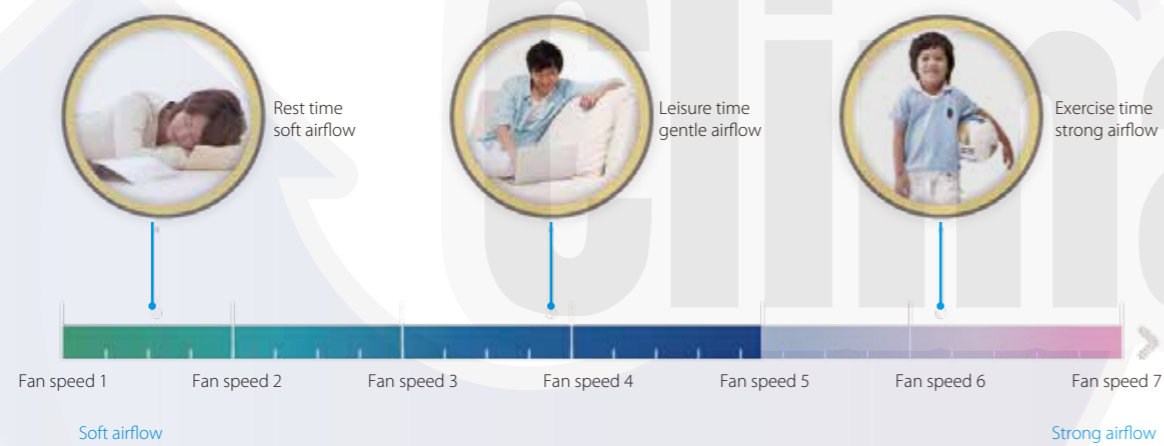

Display Shut-off

Indoor unit displays can be shut off at night, creating a better environment for rest.



5-step Swing Louver

The air is comfortably spread upwards and downwards thanks to the 5-step swing louver that can be programmed via the controller.

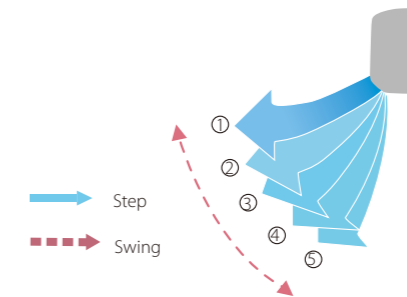

Follow Me

With the follow me function, the indoor unit responds to the temperature measured by the temperature sensor built-in to the wireless remote controller, rather than the temperature sensor in the indoor unit itself, enabling more precise control of the temperature in the user's immediate environment.



Eco Mode

Eco mode saves energy whilst retaining a comfortable indoor environment.



Wired Controllers



Features

Model	 WR-86KD-CM	 WR-86K-CM	 WR-120G-CM
On / Off	●	●	●
Mode selection	●	●	●
Temperature setting	● (0.5°C or 1°C steps)	● (0.5°C or 1°C steps)	● (0.5°C or 1°C steps)
Dual temperature set points	●	—	●
7-speed fan control	●	●	●
Auto swing	●	●	●
5-step swing louver	●	●	●
Address setting	●	●	●
Follow me	●	●	●
Eco mode	●	●	●
Room temperature display	●	—	●
°F/°C display	●	●	●
Keyboard lock	—	—	●
Background light	●	●	●
Daily timer	●	●	●
Weekly schedule timer	—	—	●
Auto restart	●	●	●
2 permission levels	—	—	●
Bi-directional communication	●	—	●
Group control	—	—	●
Main or secondary controller setting	●	—	●
Display shut-off	●	●	●
Night silent mode	●	●	●
Remote signal receiver	●	●	●
Clean filter reminder	●	●	●
Extension function	—	—	●
Daylight saving time	—	—	●
Clock display	—	—	●
Dot matrix display	—	—	●
Error check function	●	—	●
System parameter querying	●	—	●
System setting control	●	—	●
Dimensions (WxHxD) (mm)	86x86x18	86x86x18	120x120x20
Power supply	18 DC	5V DC	18 DC

Group Control

One controller can be used to unify the settings across up to 16 indoor units.



Main or Secondary Controller Setting

Two controllers can be used together, with the indoor units' operating mode and settings being set according to the most recent instruction received. The controller display screens are synchronized so that both displays update when a setting is adjusted.



2 Permission Levels

2 permission levels ensure users can easily access control functions and allow administrators convenient access to operating parameters.

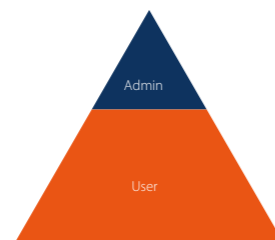

Extension Function

The extension function is specifically designed for users working overtime. Pressing the delay button postpones system shutdown by 1 or 2 hours.



Dual Temperature Set Points

With dual temperature set point control, the set temperature changes automatically when the operating mode is changed.

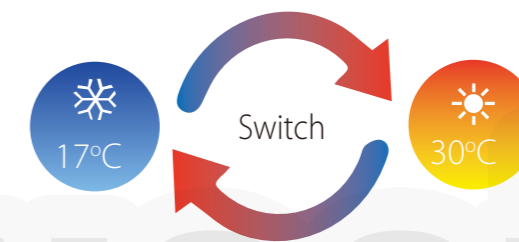

Weekly Schedule Timer

The weekly schedule timer allows users to set multiple schedules each with its own operating mode, temperature settings and fan speeds.

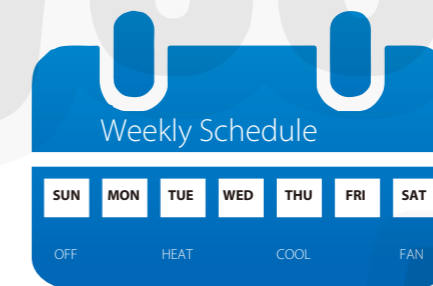

Bi-directional Communication



The wired controller can query the system operating parameters thanks to the new bi-directional communication functionality. In addition, settings including static pressure, cold draft prevention and temperature compensation can be configured on the wired controller.



Centralized Controllers



Features

Model	 CRF-180A-CM	 CRF-270B-CM
Max. number of indoor units	64	384
Max. number of outdoor units	32	192
Max. number of refrigerant systems	8	48
Touch screen	● (6.2-inch)	● (10.1-inch)
On / Off	●	●
Mode selection	●	●
Temperature setting	● (0.5°C or 1°C steps)	● (0.5°C steps)
Dual temperature set points	●	●
7-speed fan control	●	●
Auto swing	●	●
5-step swing louver	●	●
Room temperature display	—	●
Outdoor unit Eco mode setting	●	●
Holiday setting	●	●
°C/°F display	●	●
Schedule management	●	●
Clock display	●	●
2 permission levels	●	●
Extension function	●	—
Unit model recognition	●	●
Electricity charge distribution	—	●
Visual schematic	—	●
Energy management	●	●
Group management	●	●
Error check function	●	●
System parameter querying	●	—
USB output		Error report, operation record and electricity consumption report
Report display	Error report	
Operation log	—	●
LAN access	—	●
languages supported	English	English
Dimensions (WxHxD) (mm)	182x123x34	270x183x27
Power supply	12V DC	24V AC

Touch Screen

Colorful touch screen and vivid display make operation more convenient and simple.



Electricity Charge Distribution

The controllers estimate the electricity consumption of the outdoor units and then divide it among the indoor units so that the electricity charges can be equitably divided among building occupants.



Energy Management

User can set limits or locks on an indoor unit, such as minimum cooling temperature, maximum heating temperature, fan speed, operation mode, swing lock, remote controller lock and wired controller lock.



Visual Schematic

By importing floor plans and then dragging and dropping the indoor units to their actual positions on the floor plan, users can create a tailored system schematic which enables monitoring and control of the indoor units through a clear visual representation of the system layout.



Group Management

Units can be viewed according to group, system or location, making unit management clearer and more convenient.



Outdoor Unit Configuration

Outdoor unit configuration and settings can be monitored and controlled without having to go outdoors.



Unit Model Recognition

The controller recognizes the model of indoor and outdoor units and different models are represented by different icons.



Schedule Management

Daily, weekly or annual schedules can be used to set unit settings such as on/off, operating mode, set temperature, fan speed and swing.

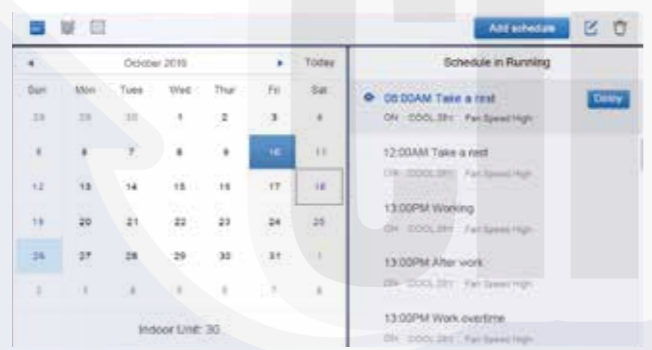

LAN Access

A desktop or laptop PC can be used for browser-based access via a LAN connection.



Wiring Flexibility

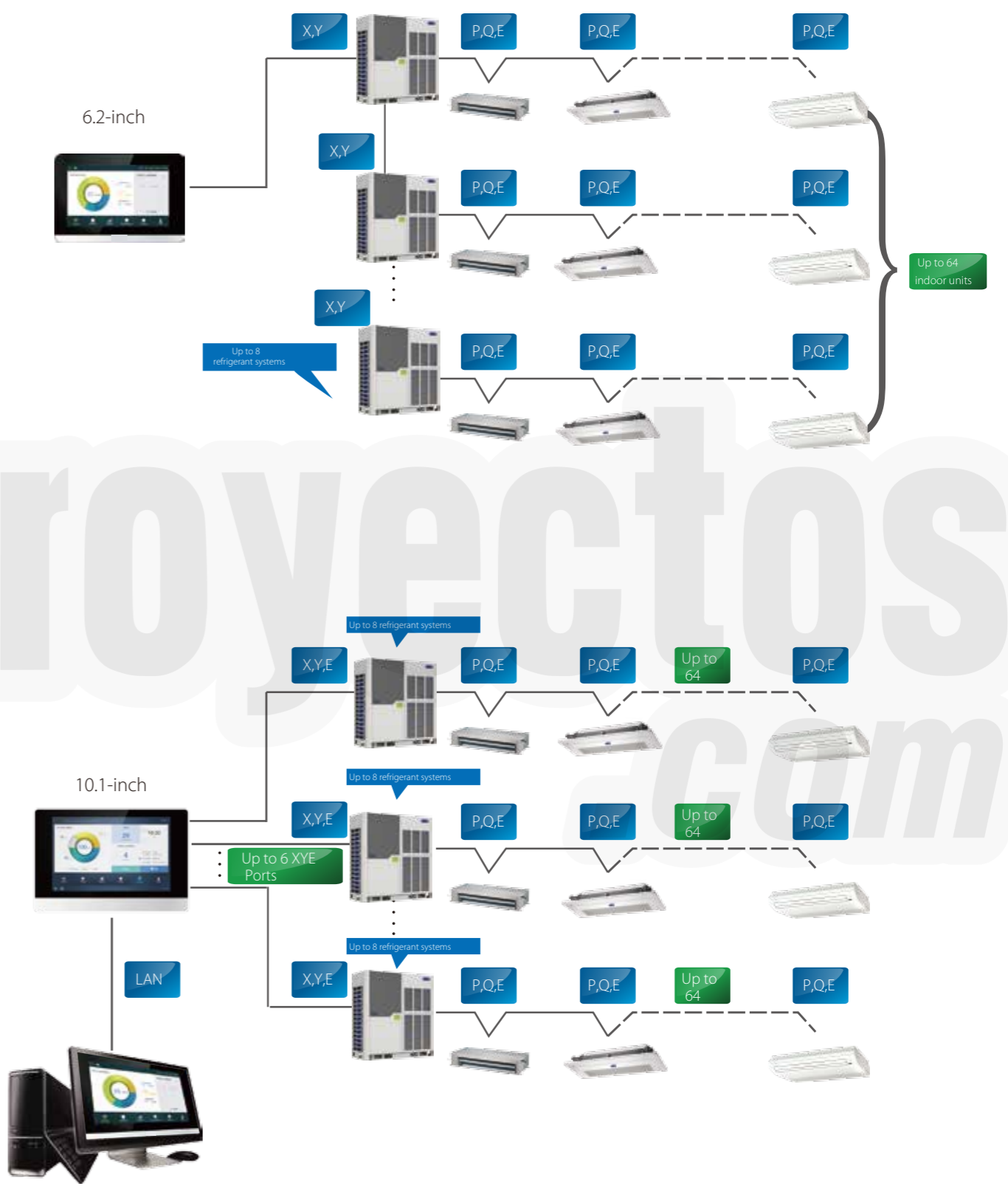

The controllers can be connected to the master outdoor unit directly.

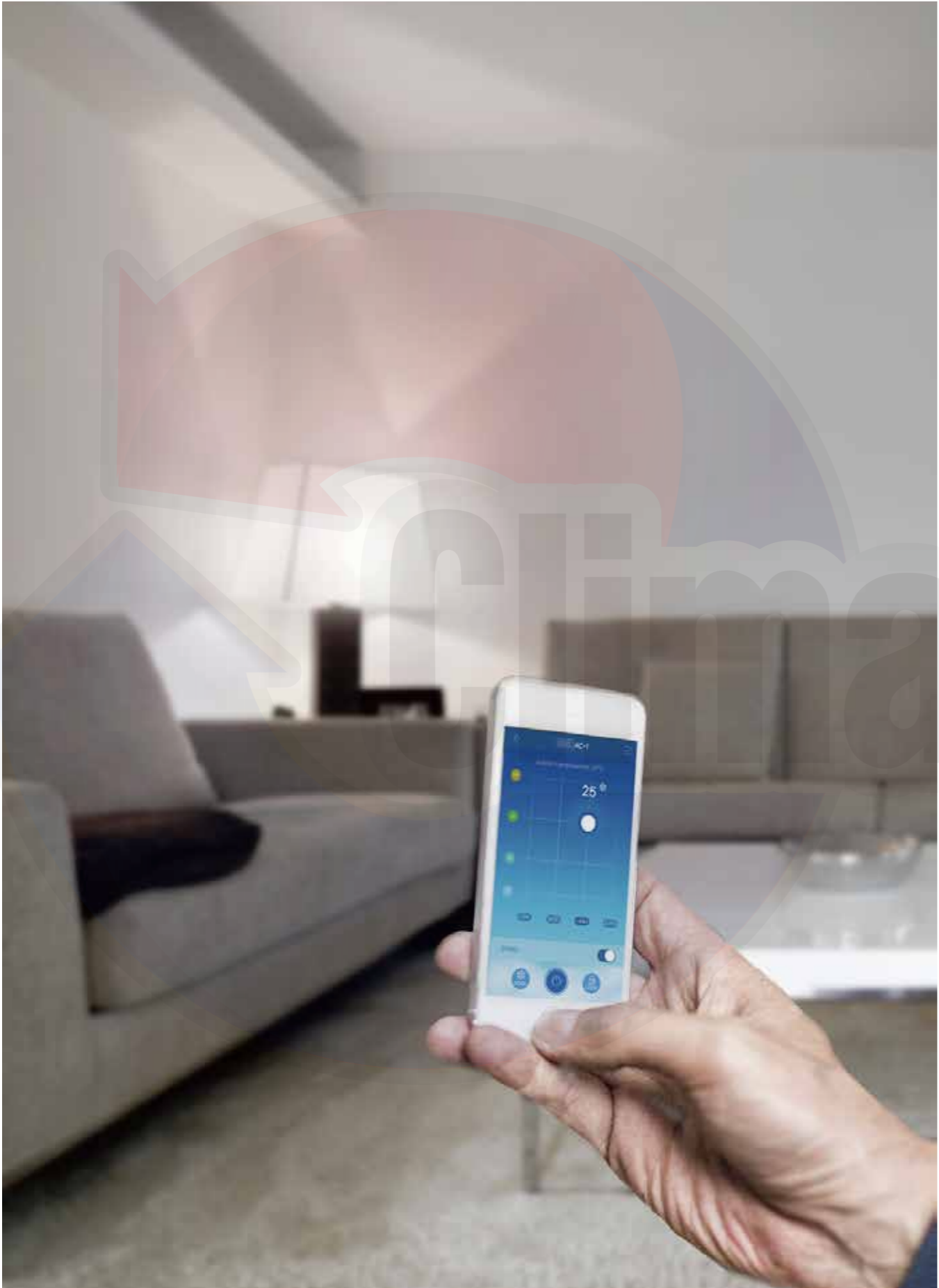

Data Converter



Features

Hardware model	 CIF-15A-CM	
Application scenarios	 Mobile Phone Application	 Cloud Server Website
Max. number of CCM-15 for one mobile APP	10	10
Max. number of indoor units	640	640
Max. number of refrigerant systems	80	80
On/Off	●	●
Mode selection	●	●
Temperature setting	● (1°C steps)	● (1°C steps)
7-speed fan control	—	—
Auto swing	●	●
5-step swing louver	—	—
Room temperature display	●	●
°C/°F display	●	●
Weekly timer	●	●
Indoor unit type recognition	—	—
Energy management	●	●
Group management	●	●
User group management	●	●
Operation log	●	●
Device log	●	●
Login record	●	●
Error log	—	●
Configuration	●	—
Account registration	●	—
Virtual	●	—
Mode display	●	●
Languages supported	English, French, Spanish	English, French, Spanish
Dimensions (W×H×D) (mm)	187×115×28	
Power supply	1 phase, 100-240V, 50/60Hz	

High Compatibility

Compatible with a variety of operating systems.



User Friendly Interface

Clear, stylish interface designed by leading industrial designers.



Cloud Server Website

In addition to "M-control", users can control air conditioners and query the status of air conditioning equipment anytime and anywhere through the cloud server website.

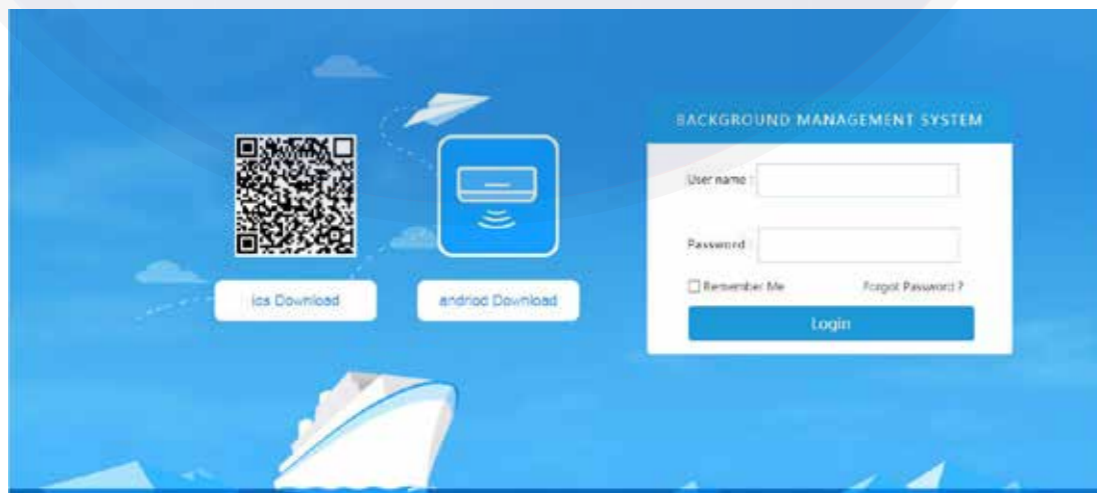

Virtual Experience

After downloading "M-control", you can experience the operation of the interface through the virtual experience function without registration.

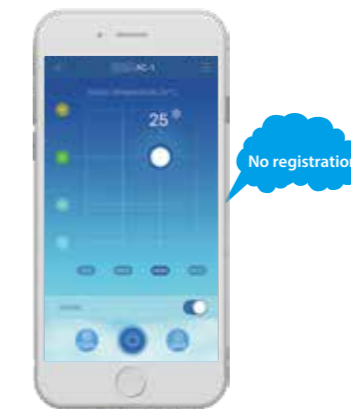

Easy Configuration

User groups can be joined simply by scanning a QR code.



Convenient Operation

Drag the position of the floating bubbles to change temperature and fan speed.



Anytime Control

Remote access to CIF-15A-CM allows anytime, anywhere control.



Clear Icons

Clear, color-coded icons allow unit operating states to be viewed at a glance.



Group Management

The user can group the air conditioners equipment, and the air conditioner in the same group can be controlled together just with one tap.



2 Permission Levels

Administrators can set different permissions for different users to facilitate better management of devices.

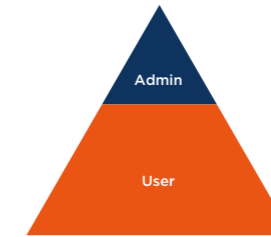

Multiple Language Options

Supports multiple languages so that users of different languages can operate easily.



Flexibility

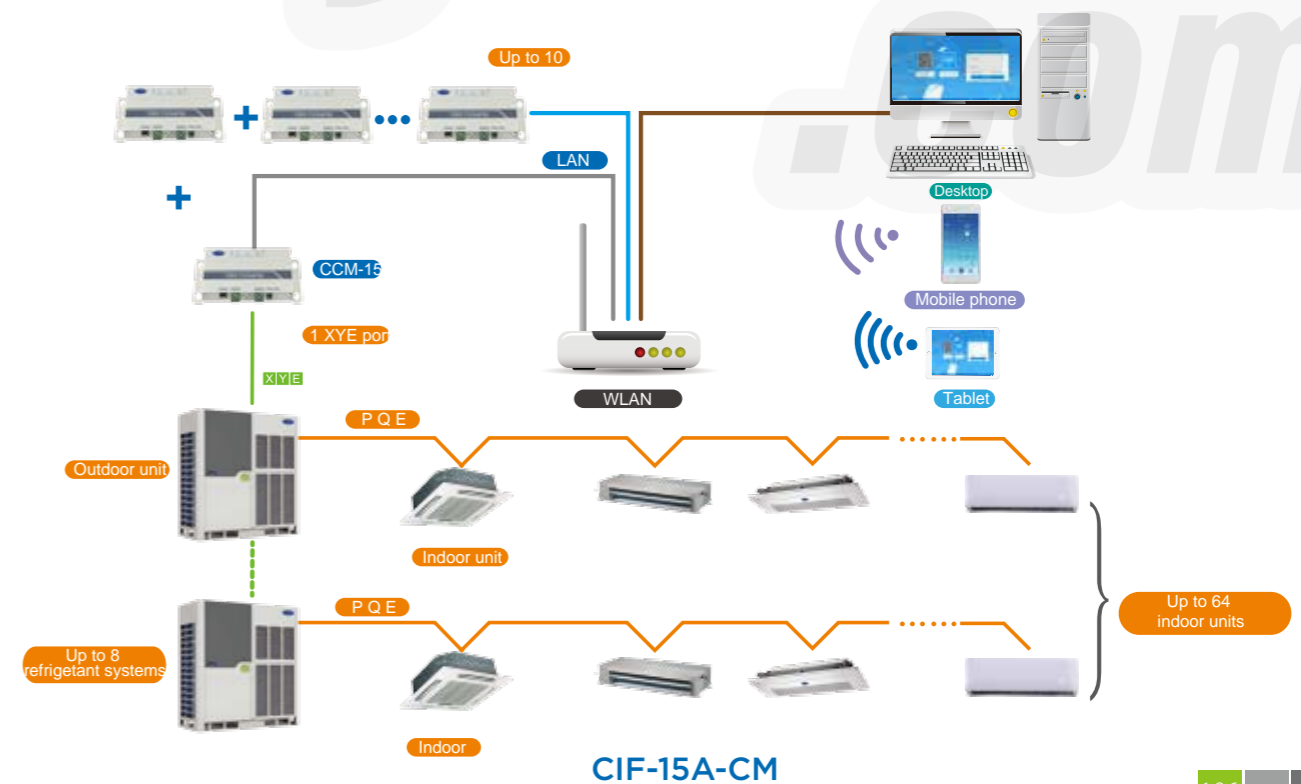

The Data Converter can be connected directly to a network of indoor/outdoor units.



Network Control System



Features

Software model	4GNS-20-IF		
Hardware model	 4GNS-20-CM	 4GNS-BAC-CM	 CRF-270A-CM
Max. number per IMM system	10		10
Max. number of indoor units	2560		3840
Max. number of outdoor units	1280		1920
Max. number of refrigerant systems	320		480
Temperature setting	● (0.5°C steps)		● (0.5°C steps)
Dual temperature set points	●		●
7-speed fan control	●		●
Auto swing	●		●
5-step swing louver	●		●
Outdoor unit Eco mode setting	●		●
Holiday setting	●		●
Schedule management	●		●
Clock display	●		●
2 permission levels	●		●
Unit model recognition	●		●
Electricity charge distribution	●		●
Visual schematic	●		●
Energy management	●		●
Group management	●		●
Error check function	●		●
System parameter querying	●		●
Report output	●		●
Operation log	●		●
LAN access	●		●
Data backup	●		●
Remote VPN access	●		●
Languages supported	English, French, Spanish		English, French, Spanish
Dimensions (WxHxD) (mm)	251x319x66		270x183x27
Power supply	1 phase, 100-240V, 50/60Hz		24V AC

User-friendly Interface

Simple, practical user interface makes for a user-friendly experience even for first-time users.



Outdoor Unit Configuration

Outdoor unit configuration and settings can be monitored and controlled without having to go outdoors.

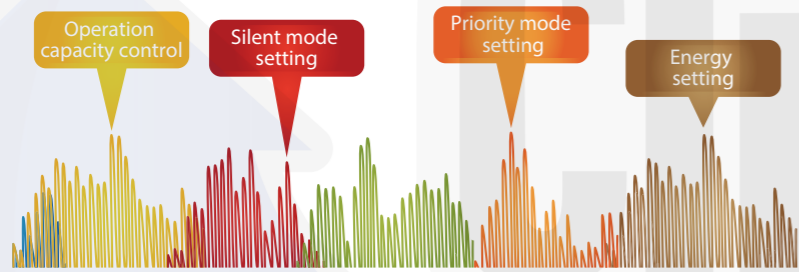

Electricity Charge Distribution

The IMMPRO uses the Calculation Method to estimate the electricity consumption of the outdoor units and then divide it among the indoor units so that the electricity charges can be equitably divided among building occupants.

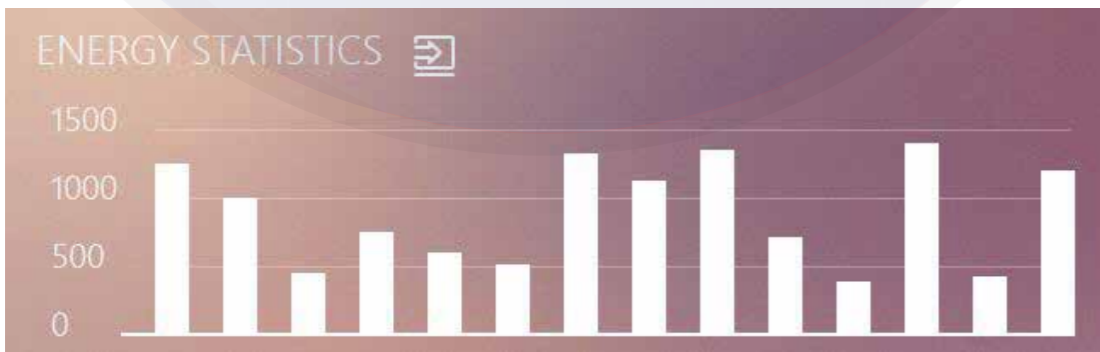

Public and Idle Devices

Marking a unit as a public device or idle device ensures the electricity charge distribution is more accurate and reasonable.



Visual Schematic

By importing floor plans and then dragging and dropping the indoor units to their actual positions on the floor plan, users can create a tailored system schematic which enables monitoring and control of the indoor units through a clear visual representation of the system layout.



Schedule Management

Daily, weekly or annual schedules can be used to set unit settings such as on/off, operating mode, set temperature, fan speed and swing.



Xpress Installation

With the Xpress Installation wizard, IMMPRO can be installed quickly and easily without requiring support from a technical support engineer.

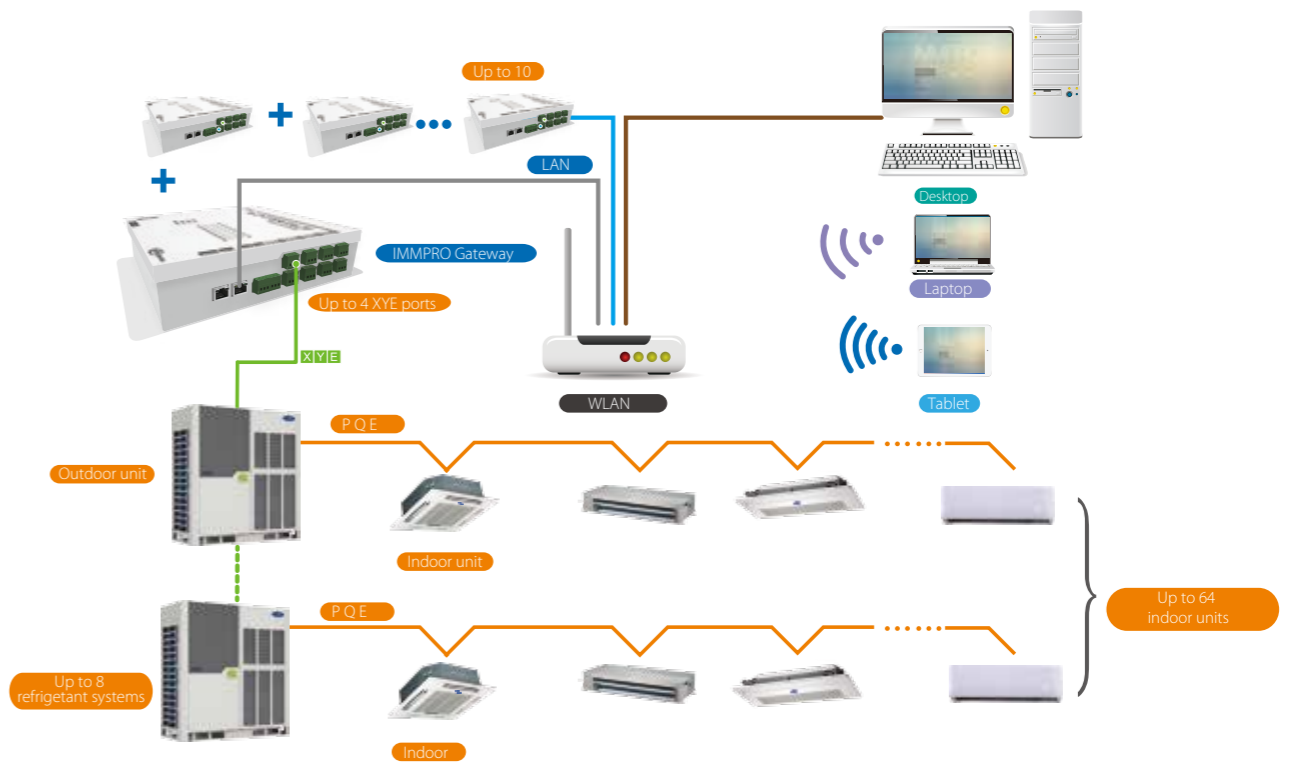

Network Flexibility

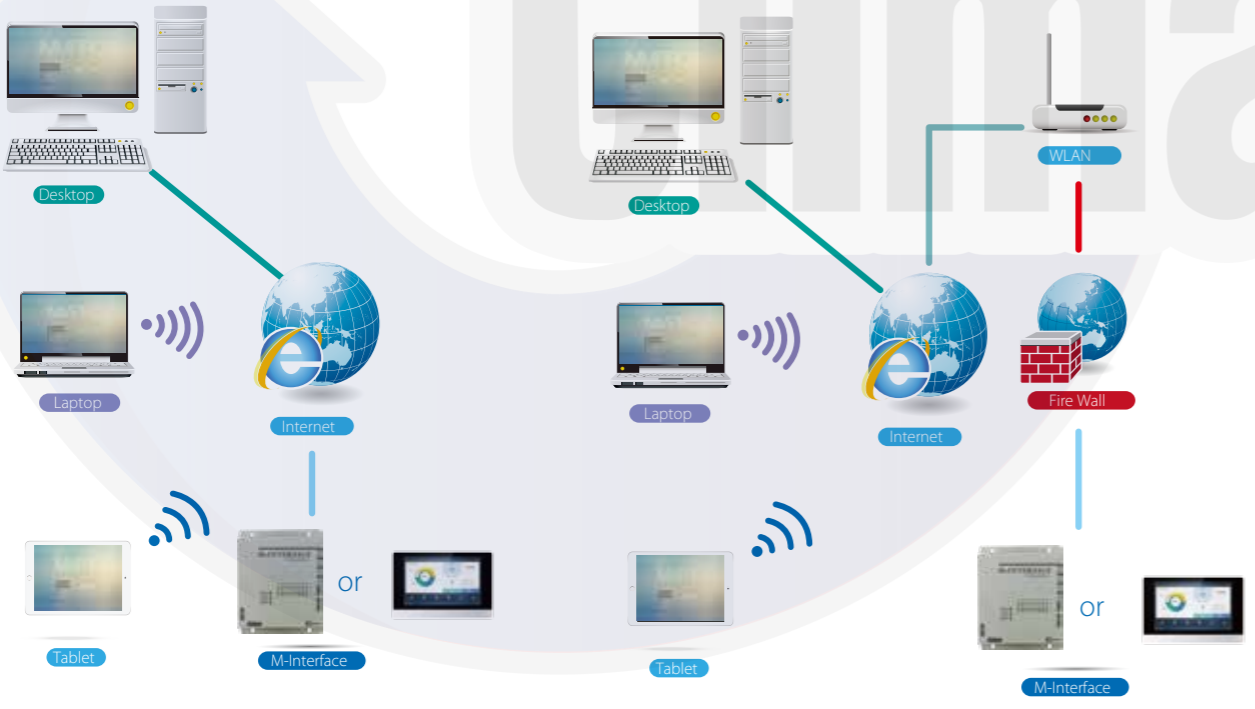

LAN access

Remote VPN access

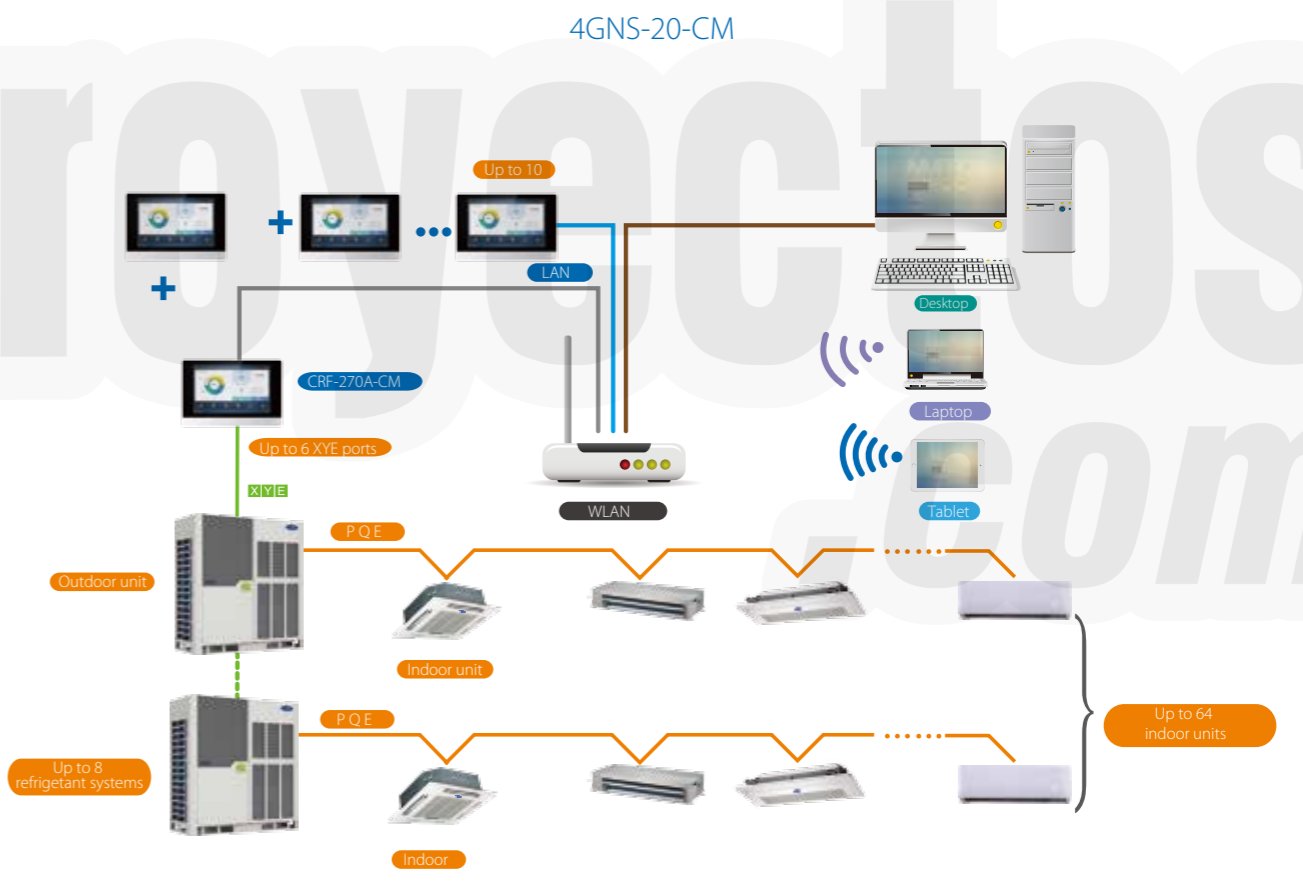

CRF-270A-CM

BMS Gateway

Monitoring and control of Carrier's VRF air conditioners can be integrated into building management systems, enabling air conditioning to be monitored alongside lighting, power, fire, access and security systems. Carrier's gateway devices provide full compatibility with the leading BMS protocols: BACnet, LonWorks and Modbus.



BACnet® Gateway

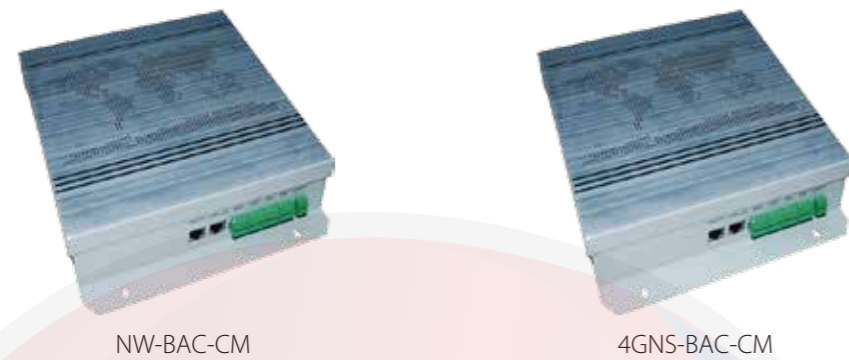

Full Integration

The NW-BAC-CM Gateway allows Carrier VRF systems to be monitored and controlled alongside other building management technology that use the BACnet protocol such as access control, fire detection and lighting systems.

Network Flexibility

The gateway can be connected to master outdoor units' XYE ports directly.

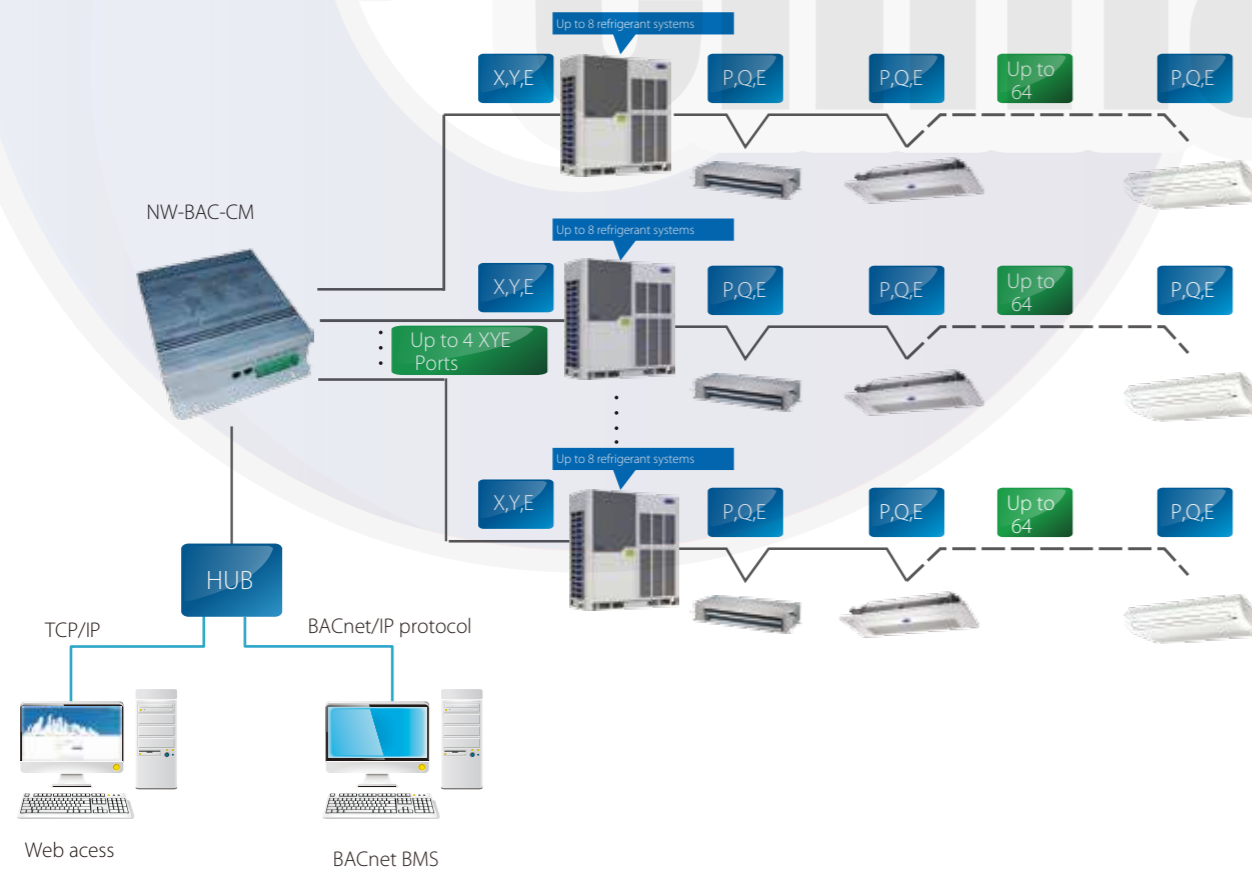

Features

Model	NW-BAC-CM / 4GNS-BAC-CM		
Max. number of indoor units	256		
Max. number of outdoor units	128		
Max. number of refrigerant systems	32		
Control	On / Off	●	
	Mode selection	●	
	Temperature setting	●	
	Fan speed	●	
	Energy management	●	
Indoor unit monitoring	Room temperature display	●	
	Error status	●	
	Error alarms	●	
	Operating mode	●	
	Outdoor ambient temperature	●	
Outdoor unit monitoring	Fan speed	●	
	Compressor operating frequency	●	
	Discharge temperature	●	
	System pressure	●	
	Error status	●	
	Error alarms	●	
	LAN access	●	
	BTL certification	●	
	Compatibility	Siemens	APOGEE
		Trane	TRACER
Honeywell		ALERTON	
Schneider		Andover Continuum	
Johnson Controls		METASYS	
Dimensions (HxWxD)(mm)	319x251x61		
Power supply	1 phase, 100-240V, 50/60Hz		



LonWorks® Gateway

NW-LON-CM

Full Integration

The NW-LON-CM Gateway allows Carrier VRF systems to be monitored and controlled alongside other building management technology on the LonWorks platform such as security, fire safety and lighting systems.

Network Flexibility



Features

Model	NW-LON-CM		
Max. number of indoor units		64	
Max. number of outdoor units		32	
Max. number of refrigerant systems		8	
Control	Mode selection	•	
	Temperature setting	•	
	Fan speed	•	
	Group shut down	•	
	On / Off	•	
	Operating mode	•	
	Set temperature	•	
	Fan speed	•	
	Indoor unit monitoring	Online status	•
		Operating status	•
	Room temperature	•	
	Error status	•	
Outdoor unit monitoring	Error status	•	
Dimensions (HxWxD) (mm)	319x251x61		
Power supply	1 phase, 100-240V, 50/60Hz		



Modbus® Gateway

NW-MOD-CM

Full Integration

The NW-MOD-CM Gateway enables seamless connection of Carrier VRF systems with building management systems built on the Modbus communication protocol.

Network Flexibility

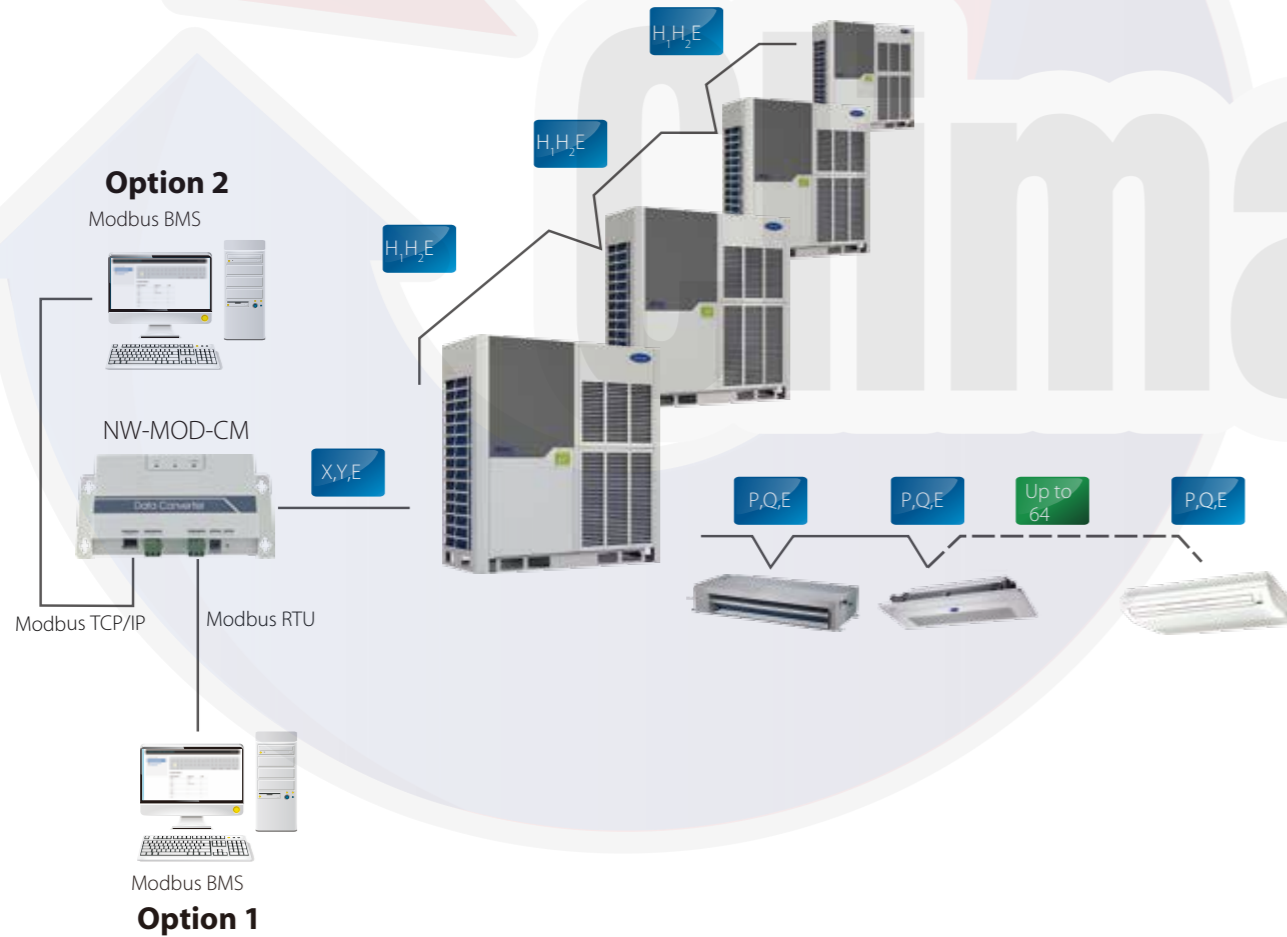

Features

Model	NW-MOD-CM	
Max. number of indoor units		64
Max. number of outdoor units		4
Max. number of refrigerant systems		1
Control	On / Off	●
	Mode selection	●
	Temperature setting	●
	Fan speed	●
	Group on/off	●
Indoor unit monitoring	Online status	●
	Room temperature	●
	Error status	●
	Operating mode	●
	Operating mode	●
Outdoor unit monitoring	Lock status	●
	Fan speed	●
	Set temperature	●
	Outdoor ambient temperature	●
	Error status	●
LAN access		●
Dimensions (HxWxD)(mm)		319x251x61
Power supply		1 phase, 100-240V, 50/60Hz

Hotel Key Card Interface Modules

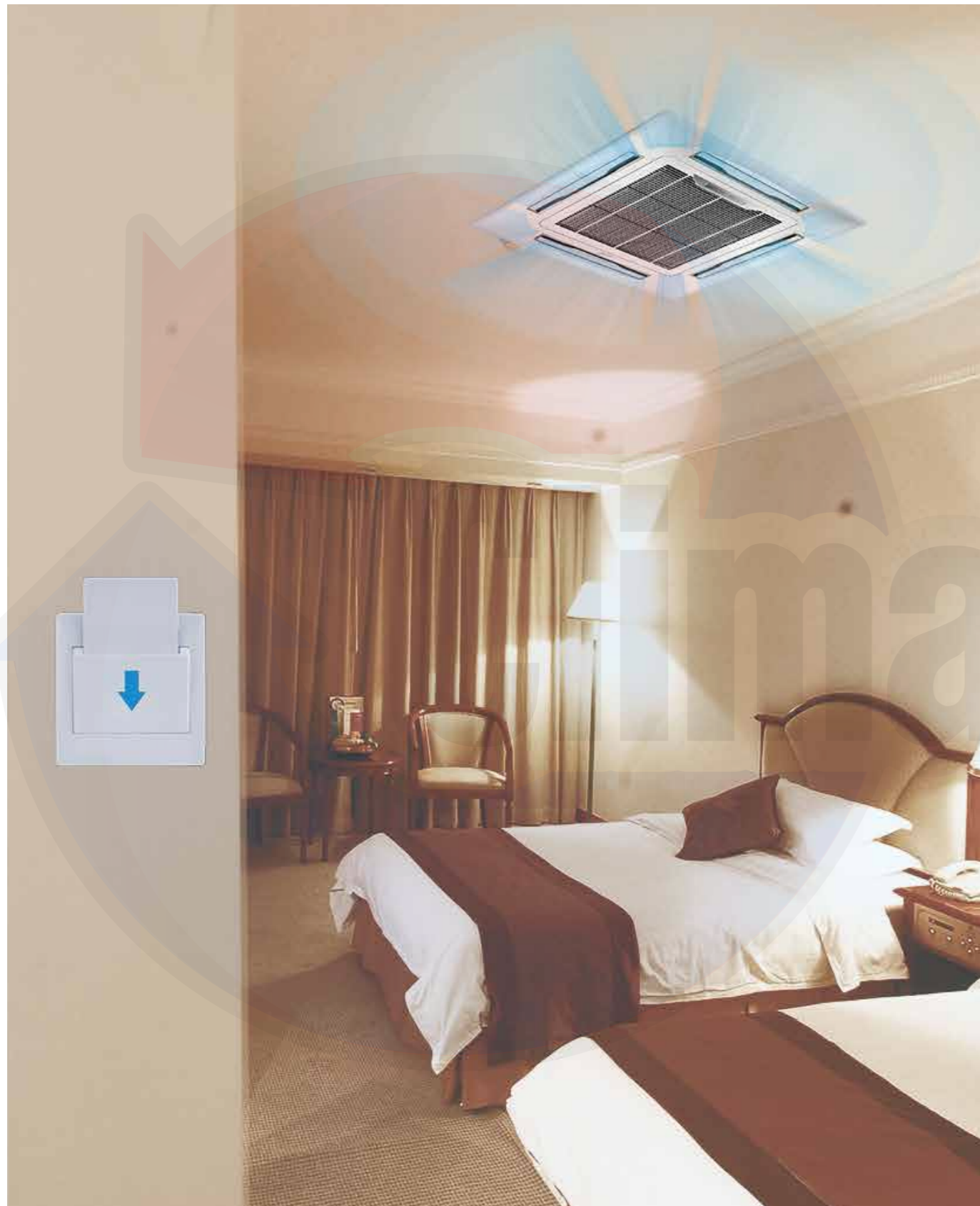

Full Integration

The Hotel Key Card Interface Modules enable power supply to indoor units to be integrated with hotel key card power supply management systems, which are designed to save energy by only running appliances whilst guests are present in their room.

Features

Model	CA-NIM05/E	CA-NIM05B/E
Appearance		
Network flexibility		
Auto restart	●	●
Compatibility	Remote and wired controller	Remote and wired controller
Dimensions (HxWxD) (mm)	15.5x86x72.8	87x150x70
Power supply	5V DC (Supplied by indoor unit)	1 phase, 100-240V, 50/60Hz

Infrared Sensor Controller

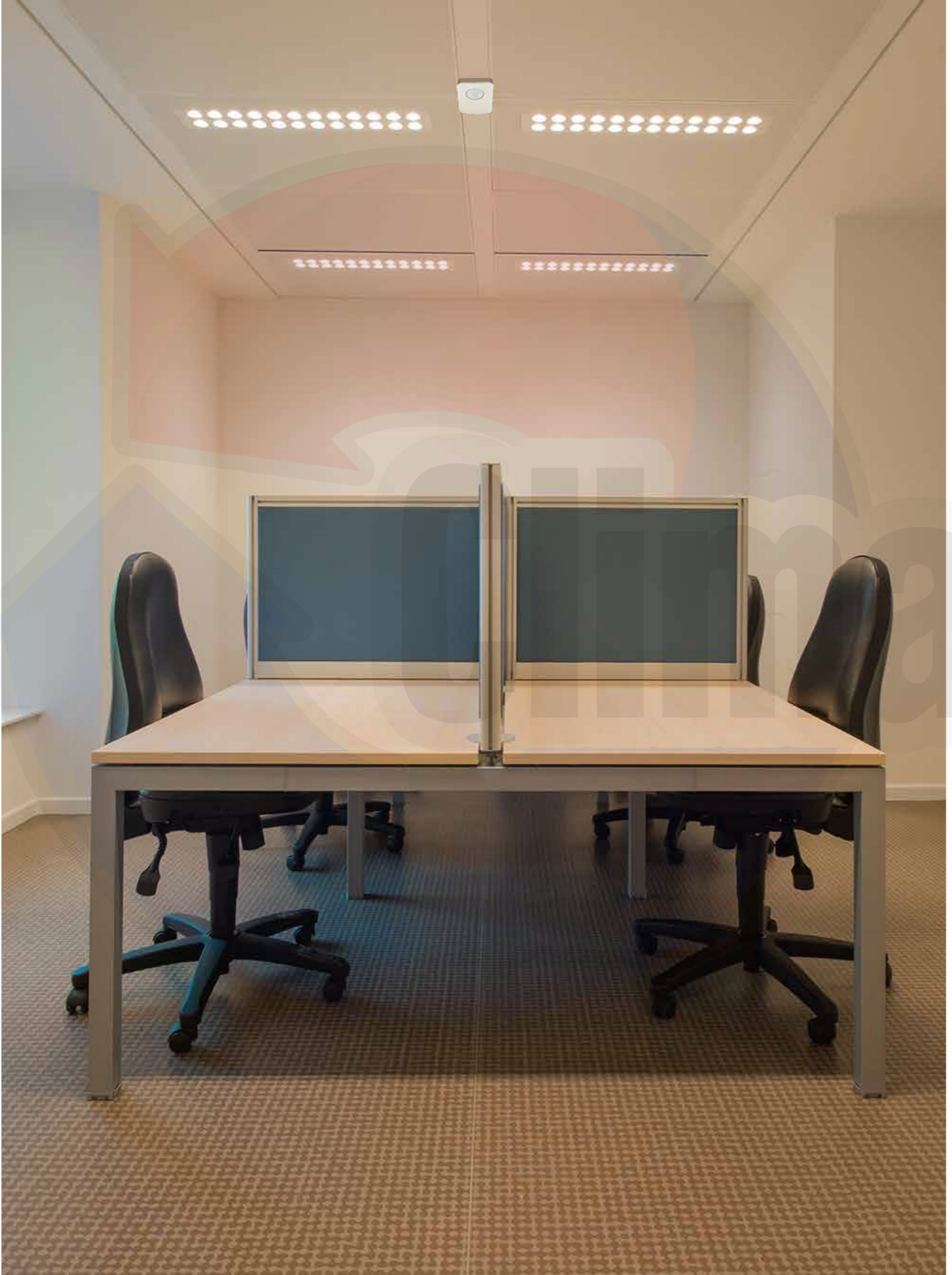

Full Integration

Using infrared sensors to detect movement, the CA-NIM09 Infrared Sensor Controller automatically turns indoor units on or off upon sensing that the room is occupied or unoccupied. Suitable for hotels, offices, conference rooms and residences, the Infrared Sensor Controller ensures climate control whilst minimizing energy consumption.

Features

Model	CA-NIM09
Appearance	
Network flexibility	
Dimensions (HxWxD)(mm)	Sensor 46x30x25.6, Control box 86x72.8x15.5
Power supply	5V DC (Supplied by indoor unit)

Diagnosis Software



Monitor and Diagnose

Carrier's VRF Diagnosis Software tool is used to monitor VRF systems and diagnose system errors. System settings and operating parameters can be accessed easily and data logs can be reviewed for fault prevention purposes.

Features

Model		VRF-DIAG-B
Max. number of indoor units		64
Max. number of outdoor units		4
Max. number of refrigerant systems		1
Control	Mode selection	●
	Temperature setting	●
	Fan speed	●
Outdoor unit monitoring	Operating mode	●
	Capacity	●
	Compressor operating frequency	●
	Operating current	●
	Error status	●
	Temperatures	T3,T4,Tp (See note 1)
	Valve statuses	SV2, SV4, SV5, SV6, ST1 (See note 2)
Indoor unit monitoring	EXV position	●
	Operating mode	●
	Capacity	●
	Fan speed	●
	Address	●
	Temperatures	T1, T2, T2B, TS (See note 3)
	EXV position	●
Error codes	●	
Troubleshooting	●	
Data logs	●	
Diagrams	System schematic, refrigerant flow diagram, parameter chart	
Languges supported	English	

Notes:

1. Heat exchanger temperature, outdoor ambient temperature, discharge temperature.
2. Discharge temperature control valve, oil return valve, defrosting valve, EXV bypass valve, four-way valve.
3. Indoor ambient temperature, indoor heat exchanger mid-point temperature, indoor heat exchanger outlet temperature, set temperature.

Expert Diagnosis

Carrier's VRF Diagnosis Software is specially designed to allow after-sales engineers, to understand the operating status of the system at a glance.



Use-friendly Interface

A stylish and simple interface with rich graphical representations makes diagnosing system issues quick and convenient.



Diagrams

A system schematic, refrigerant flow diagram and parameter chart can be generated to provide a graphical interpretation of the system status.

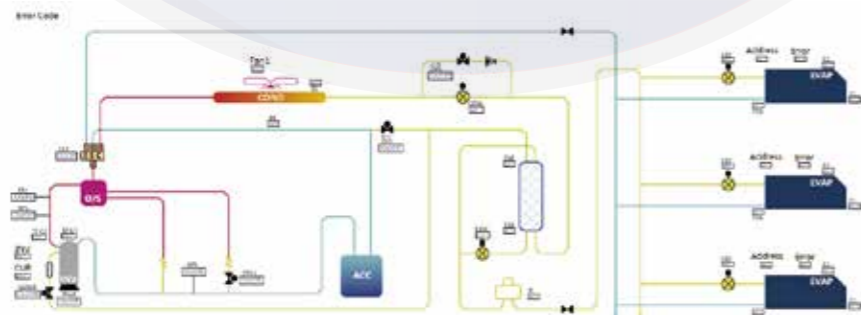

Parameter Querying

Access all the system parameters easily.



Data Logs

Data logs including operating records and error reports are saved by the software which is useful for discovering system issues.



Wiring Schematic

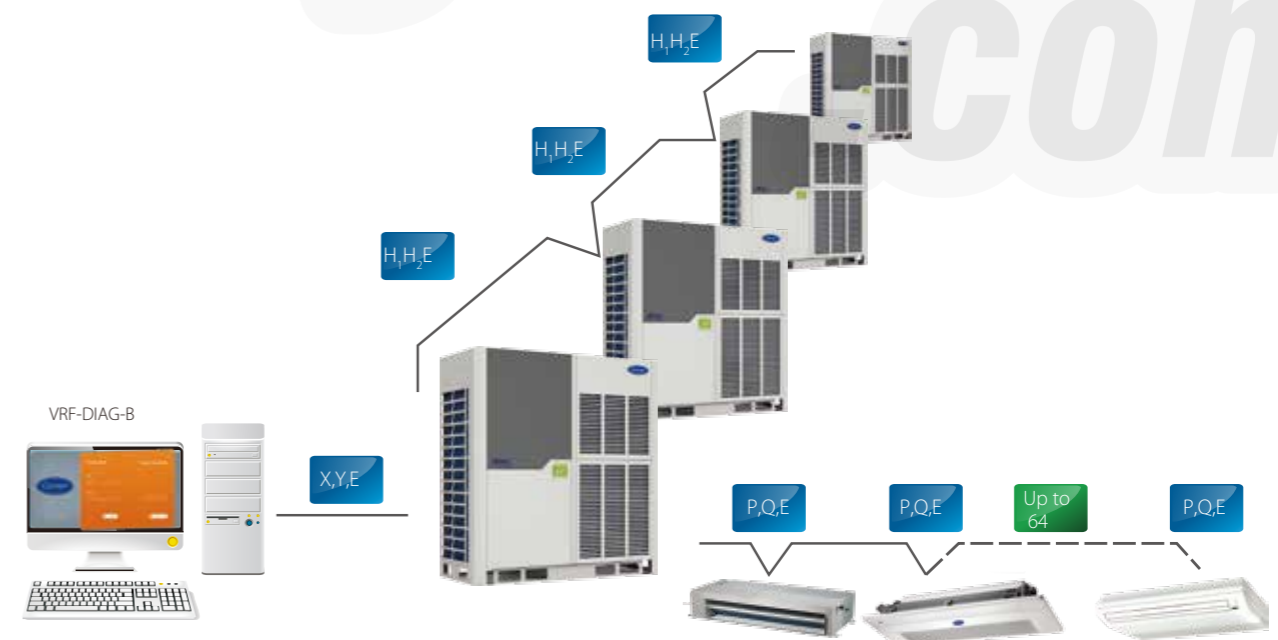

VRF AHU Control Box

High Efficiency

AHU kit facilitates raising the EER/COP of the complete AHU system.



Wide Capacity Range

Four kits can be used in parallel, giving an overall capacity range of 3.2HP to 80HP.



Compatible with All VRF Systems

AHU kits are compatible with all Carrier VRF outdoor units and can be used together with all types of Carrier VRF indoor units.



Single AHU Control Box Connection

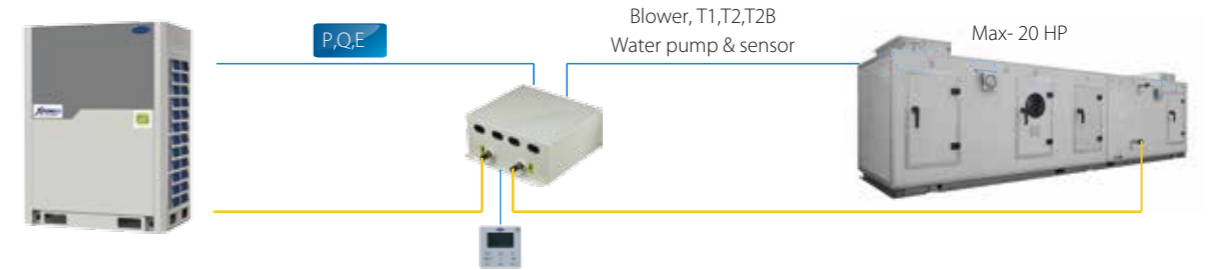

Multi AHU Control Boxes Connection

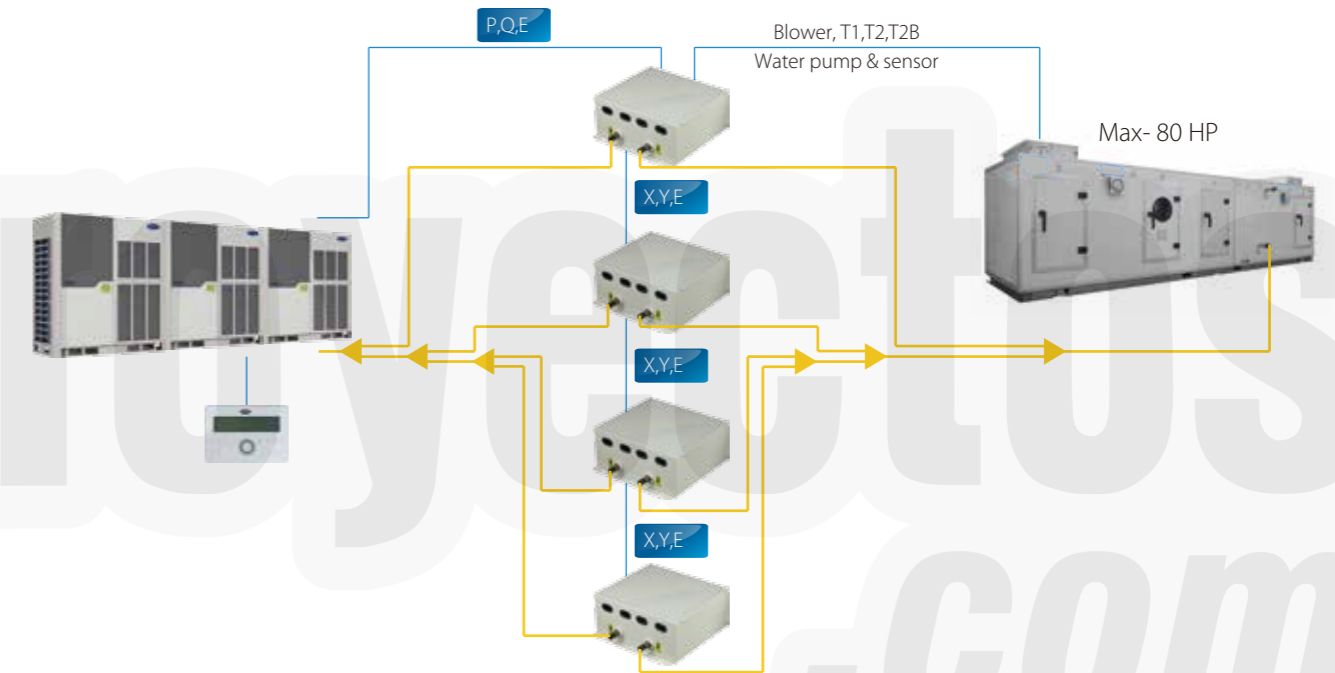

Specifications

Model		AHUKZ-01B	AHUKZ-02B	AHUKZ-03B
Capacity	HP	3.2-6	8-12	14-20
Power supply		1 phase, 208-230V, 60Hz		
Refrigerant		R410A		
Pipe connections (inlet and outlet)	mm	Ø8	Ø12.7	Ø15.9
Net dimensions (WxHxD)	mm	350x150x375		
Packed dimensions (WxHxD)	mm	420x240x490		
Net weight	kg	8.4	8.7	8.9
Gross weight	kg	11.4	11.7	11.9
Operating modes		Cooling, heating and fan only		
Standard controller		Wired controller		
Optional controller		Wireless remote controller; SIEMENS controller		

Selection Software

High Efficiency

Carrier's advanced design automation tool can be used by designers, consultants and distributors to greatly reduce the time and effort that must be devoted to the selection process. The software provides quick and convenient selectable options for users, supports multiple languages, and greatly improves the selection process.

The Selection Software provides distributors' sales team with a comprehensive selection of system design reports and calculations. Load calculations may be on either an initial estimate basis or detailed room-by-room basis. Based on the indoor units, outdoor units and controllers selected, the software produces detailed system layout diagrams and piping requirement calculations.

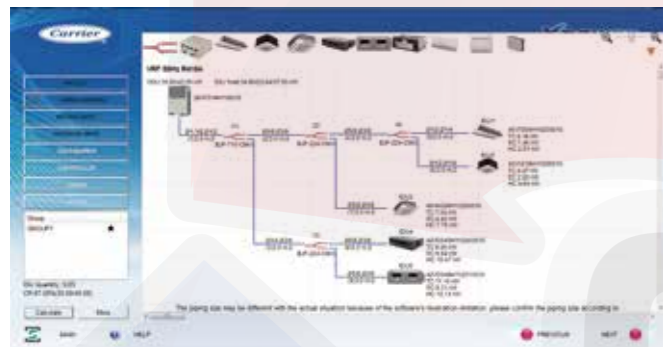

Piping diagram



Wiring diagram

Selection Software



Controller selection

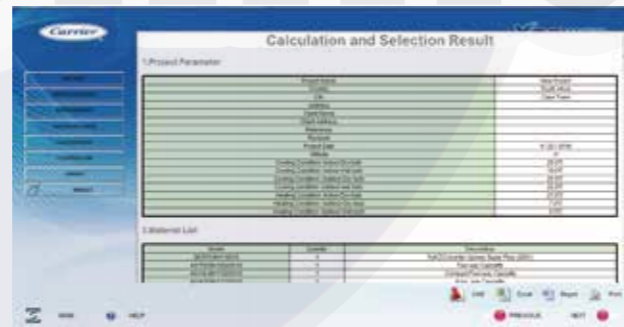

Report

Compatible Table Of Control System

Outdoor Unit Series	Indoor Unit Series	1 st Generation (Remote/Wired Controllers & KNX Gateway1)	1 st Generation Centralized Controllers	1 st generation BMS	2 nd Generation (Remote/Wired Controllers & KNX Gateway1)	2 nd Generation Centralized Controllers	2 nd Generation BMS	Data Converter	Network Control System	Diagnosis Software	Accessories
Super X/ Super Xi	1 st DC/AC	WR-12-CM WR-29B-CM WR-90D-CM WL-12-CM WL-14-CM WR-120B-CM WR-120C-CM	CRF-10-CM CRF-30-CM WCRF-10-CM (Connect with indoor unit)	/	/	CRF-180A-CM CRF-270A-CM	NW-BAC-CM NW-MOD-CM NW-LON-CM	CIF-15A-CM	CRF-270A-CM + 4GNS-20-IF or 4GNS-20-CM + 4GNS-20-IF	VRF-DIAG-B	CA-NIM05/E CA-NIM05B/E CA-NIM09
Super X/ Super Xi	2 nd DC	/	/	/	WL-12D-CM WL-12B-CM WR-86K-CM WR-86KD-CM WR-120G-CM	CRF-180A-CM CRF-270A-CM	NW-BAC-CM NW-MOD-CM NW-LON-CM	CIF-15A-CM	CRF-270A-CM + 4GNS-20-IF or 4GNS-20-CM + 4GNS-20-IF	VRF-DIAG-B	CA-NIM05/E CA-NIM05B/E CA-NIM09
Non Super X/ Super Xi	1 st DC/AC	WR-12-CM WR-29B-CM WR-90D-CM WL-12-CM WL-14-CM WR-120B-CM WR-120C-CM	CRF-10-CM CRF-30-CM WCRF-10-CM CRC-10-CM	NW-BCN-CM CRF-18-CM NW-LNWD-CM NW-KNX-CM	/	/	/	CIF-15A-CM	M-interface + IMM	VRF-DIAG-B	CA-NIM05/E CA-NIM05B/E CA-NIM09
Non Super X/ Super Xi	2 nd DC	/	CRF-10-CM CRF-30-CM WCRF-10-CM CRC-10-CM	NW-BCN-CM CRF-18-CM NW-LNWD-CM	WL-12D-CM WL-12B-CM WR-86K-CM WR-86KD-CM WR-120G-CM	CRF-180A-CM CRF-270A-CM	/	CIF-15A-CM	M-interface + IMM	VRF-DIAG-B	CA-NIM05/E CA-NIM05B/E CA-NIM09

Heat Recovery Ventilator

Fan Motor Options

AC and DC fan versions available.

Enhanced Efficiency

The Carrier heat recovery ventilator (HRV) can greatly reduce energy losses and room temperature fluctuations caused by the ventilation process. The Carrier HRV's strong performance is a result of the advanced technology incorporated into its design. The heat exchanger core is made of specially treated paper which gives enhanced temperature and humidity control. Temperature exchange efficiency is over 65% and enthalpy exchange efficiency is 50-65%.



HRV-200
HRV-300
HRV-400



HRV-1500
HRV-2000

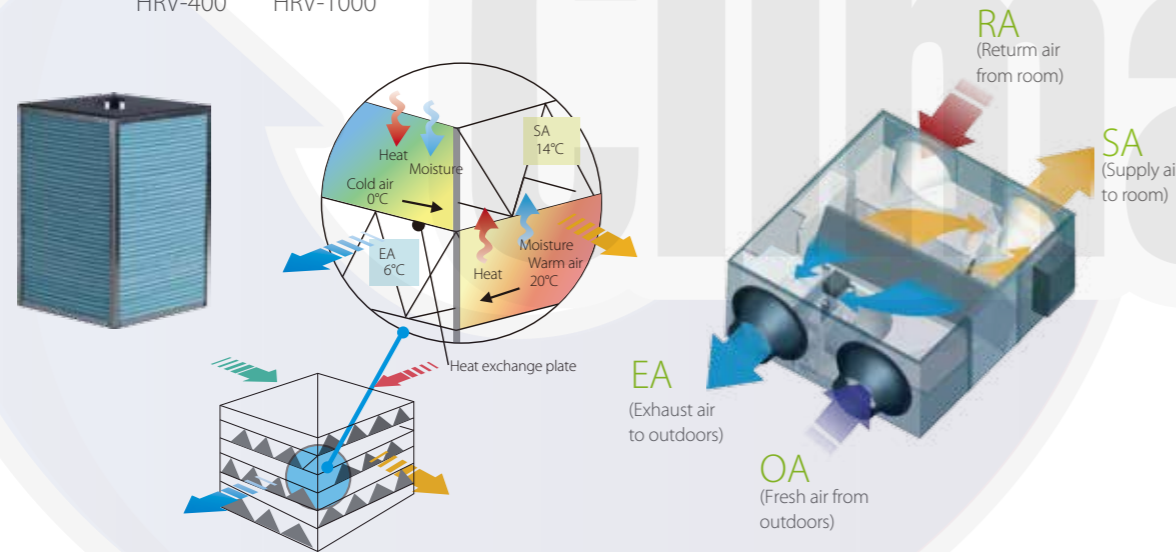

Low Noise

Soundproofing is used to guarantee quiet operation.

Flexibility

Heights starting from as little as 264mm and weights from as little as 23kg mean that the Carrier HRV can be easily installed even where space is limited.

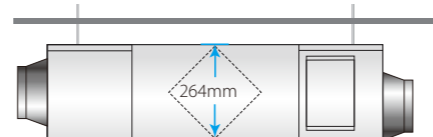

Multiple Modes

Heat exchange mode

The flows of incoming and outgoing air pass close to each other, allowing heat transfer between the two channels. During summer, incoming air is cooled by the indoor air being exhausted and in winter, incoming air is warmed.

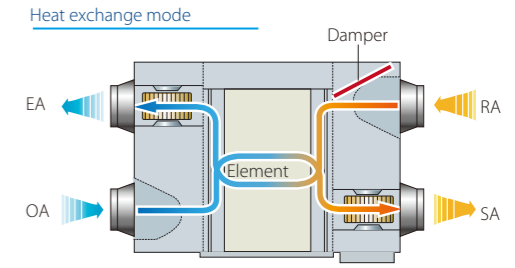

Bypass mode

In mild climates or seasons, where temperature and humidity differences between indoors and outdoors are small, the HRV can work as a conventional ventilation fan. In standard bypass mode the supply and exhaust fans run at the same speed.

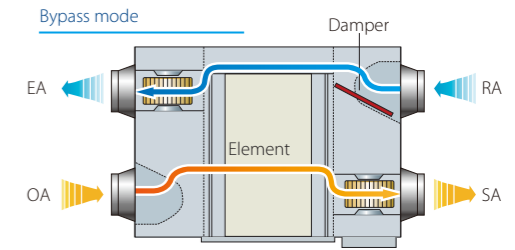

Air supply mode

Air supply mode is a form of bypass mode where the supply fan is set to run faster than the exhaust fan, which is useful in mild climate installations with high fresh air ventilation requirements.

Exhaust mode

Exhaust mode is a form of bypass mode where the exhaust fan is set to run faster than the supply fan, which is useful in mild climate installations with large amounts of exhaust air to be expelled.

Auto mode

The controller chooses heat exchange mode or bypass mode according to the temperature difference between outdoors and indoors. Both fans are set to run at low speed.

Flexible Control

HRV can be controlled together with other indoor units.

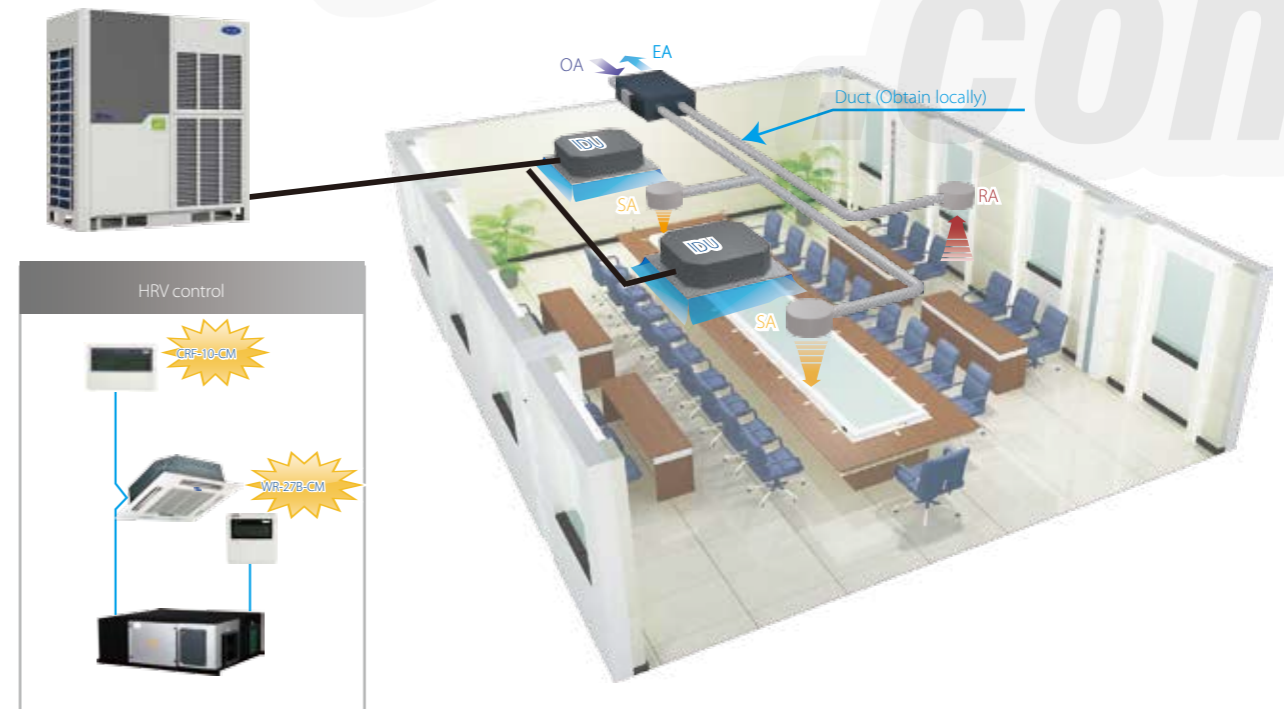

Specifications

AC Series

Model		HRV-200	HRV-300	HRV-400	HRV-500
Power supply	V/Ph/Hz	220-240/1/50		220-240/1/50 & 220/1/60	
Cooling temp. exchange efficiency (H/M/L)	%	55/55/60	55/55/60	55/55/60	55/55/60
Cooling enthalpy exchange efficiency (H/M/L)	%	50/50/55	50/50/55	50/50/55	50/50/55
Heating temp. exchange efficiency (H/M/L)	%	60/60/65	60/60/65	60/60/65	65/65/70
Heating enthalpy exchange efficiency (H/M/L)	%	55/55/60	55/55/60	60/60/65	60/60/65
Sound pressure level in heat exchange mode (H/M/L)	dB(A)	27/26/20	30/29/23	32/31/25	35/34/28
Sound pressure level in bypass mode (H/M/L)	dB(A)	28/27/22	31/30/25	33/32/27	36/35/30
Airflow rate (H/M/L)	m ³ /h	200/200/150	300/300/225	400/400/300	500/500/375
External static pressure (H/M/L)	Pa	75/58/35	75/60/40	80/65/43	80/68/45
Motor type		AC			
Duct diameter	mm	Φ144	Φ144	Φ144	Φ194
Net dimensions (WxDxH)	mm	866x655x264	944x722x270	944x927x270	1038x1026x270
Packed dimensions (WxDxH)	mm	960x770x445	1020x810x452	1020x1020x452	1120x1120x452
Net weight	kg	23	26	31	41
Gross weight	kg	40	44	52	64
Operating temperature range	°C	-7 to 43 DB, RH 80% or lower			

Model		HRV-800	HRV-1000	HRV-1500	HRV-2000
Power supply	V/Ph/Hz	220-240/1/50 & 220/1/60		380-415/3/50 & 220/3/60	
Cooling temp. exchange efficiency (H/M/L)	%	55/55/60	55/55/60	55	55
Cooling enthalpy exchange efficiency (H/M/L)	%	50/50/55	50/50/55	50	50
Heating temp. exchange efficiency (H/M/L)	%	65/65/70	65/65/70	65	65
Heating enthalpy exchange efficiency (H/M/L)	%	60/60/65	60/60/65	60	60
Sound pressure level in heat exchange mode (H/M/L)	dB(A)	39/38/32	40/39/33	51	53
Sound pressure level in bypass mode (H/M/L)	dB(A)	40/39/34	41/40/35	52	54
Airflow rate (H/M/L)	m ³ /h	800/800/600	1000/1000/750	1500	2000
External static pressure (H/M/L)	Pa	100/82/54	100/85/58	160	170
Motor type		AC			
Duct dimensions	mm	Φ242	Φ242	346x326	346x326
Net dimensions (WxDxH)	mm	1286x1006x388	1286x1256x388	1600x1270x540	1650x1470x540
Packed dimensions (WxDxH)	mm	1380x1100x573	1400x1370x573	1710x1410x720	1760x1610x720
Net weight	kg	62	79	163	182
Gross weight	kg	88	110	224	247
Operating temperature range	°C	-7 to 43 DB, RH 80% or lower			

- Note:
- Models HRV-200 to HRV-1000 each have 3 airflow settings; the airflow rates of the HRV-1500 and HRV-2000 are not adjustable.
 - Sound level is measured 1.4m below the center of the unit in a semi-anechoic chamber.
 - Efficiency is measured under the following conditions:
Cooling: exhaust air temp 27°C DB, 19.5°C WB; fresh air temp. 35°C DB, 28°C WB.
Heating: exhaust air temp 21°C DB, 13°C WB; fresh air temp. 5°C DB, 2°C WB.

Specifications

DC Series

Model		HRV-D200(A)	HRV-D300(A)	HRV-D400(A)	HRV-D500(A)
Power supply	V/Ph/Hz	220-240/1/50(60)			
Cooling temp. exchange efficiency	%	76.1	74.8	76.2	76.1
Cooling enthalpy exchange efficiency	%	77.3	76.1	78.7	78.2
Heating temp. exchange efficiency	%	76.1	74.8	76.2	76.1
Heating enthalpy exchange efficiency	%	82.6	79.8	83.6	80.4
Sound pressure level	dB(A)	27	30	32	35
Airflow rate	m ³ /h	200	300	400	500
External static pressure	Pa	75	75	80	80
Motor type		DC			
Duct diameter	mm	Φ144	Φ144	Φ144	Φ194
Net dimensions (WxDxH)	mm	852x665x264	928x734x270	928x940x270	1020x1036x270
Packed dimensions (WxDxH)	mm	910x710x430	980x774x435	1010x1010x440	1120x1120x452
Net weight	kg	25	27	32	35
Gross weight	kg	37	40	46	51
Operating temperature range	°C	-7 to 43 DB, RH 80% or lower			

Model		HRV-D800(A)	HRV-D1000(A)	HRV-D1500(A)	HRV-D2000(A)
Power supply	V/Ph/Hz	220-240/1/50(60)		220V/1/50 (60)	
Cooling temp. exchange efficiency	%	76.9	75.8	77.8	77.2
Cooling enthalpy exchange efficiency	%	78.1	76.9	79.2	78.7
Heating temp. exchange efficiency	%	76.9	75.8	77.8	77.2
Heating enthalpy exchange efficiency	%	80.1	78.6	80.5	80.3
Sound pressure level	dB(A)	39	40	51	53
Airflow rate	m ³ /h	800	1000	1500	2000
External static pressure	Pa	100	100	160	170
Motor type		DC			
Duct dimensions	mm	Φ242	Φ242	346x326	346x326
Net dimensions (WxDxH)	mm	1276x1020x388	1276x1269x388	1600x1270x540	1650x1470x540
Packed dimensions (WxDxH)	mm	1355x1045x560	1400x1370x573	1710x1410x720	1760x1610x720
Net weight	kg	58	69	151	165
Gross weight	kg	77	90	184	198
Operating temperature range	°C	-7 to 43 DB, RH 80% or lower			

- Note:
- All models each have 3 airflow setting.
 - Sound level is measured 1.4m below the center of the unit in a semi-anechoic chamber.
 - Efficiency is measured under the following conditions:
Cooling: exhaust air temp 27°C DB, 19.5°C WB; fresh air temp. 35°C DB, 28°C WB.
Heating: exhaust air temp 21°C DB, 13°C WB; fresh air temp. 5°C DB, 2°C WB.

Air handler

Optional wireless remote controller



WL-14-CM WL-12-CM

Optional wired controller



WR-29B-CM WR-90D-CM



Model		40VM018H115003010		40VM024H115003010		40VM030H115003010		40VM036H115003010		40VM048H115003010		40VM054H115003010	
Power supply		V- Ph-Hz		1 phase, 208-230V,60Hz									
Cooling	Capacity	kW	5.3	7.1	9	10.5	14	16					
		kBtu/h	18	24	30	36	48	54					
	Input	W	220	290	390	350	590	700					
Heating	Capacity	kW	8	9	10	12.5	16	17					
		kBtu/h	21	27	34	40	54	60					
	Input	W	220	290	390	350	590	700					
Indoor air flow (H/M/L)		m³/h	1100/930/780	1360/1240/1020	1700/1480/1275	2040/1785/1530	2700/2300/1900	3000/2600/2100					
		CFM	650 / 550 / 460	800 / 730 / 600	1000 / 870 / 750	1200 / 1050 / 900	1600 / 1360 / 1120	1800 / 1530 / 1260					
Indoor noise level (H/M/L)		dB(A)	48 / 45 / 43	49 / 47 / 43	52 / 49 / 47	53 / 50 / 47	57 / 54 / 52	58 / 57 / 55					
Indoor unit		Dimension (WxHxD)	mm	500x1180x550	500x1180x550	500x1180x550	560x1385x610	560x1385x610	560x1385x610				
		Packing (WxHxD)	mm	567x1274x644	567x1274x644	567x1274x644	627x1479x704	627x1479x704	627x1479x704				
		Net/Gross weight	kg	55.7/66.6	55.7/66.6	55.7/66.6	73.8/86	73.8/86	73.8/86				
Refrigerant piping	Liquid / Gas	mm	Φ9.53/ Φ15.9	Φ9.53/ Φ15.9	Φ9.53/ Φ15.9	Φ9.53/ Φ15.9	Φ9.53/ Φ15.9	Φ9.53/ Φ15.9					
Drainage water pipe diameter		OD Φ19.05											

- Notes:
- Indoor temperature 27°C DB, 19°C WB; outdoor temperature 35°C DB; equivalent refrigerant piping length 7.5m with zero level difference.
 - Indoor temperature 20°C DB; outdoor temperature 7°C DB, 6°C WB; equivalent refrigerant piping length 7.5m with zero level difference.
 - Each model's 7 airflow rate options are listed in order, from highest to lowest.
 - Each model's 7 sound pressure levels are listed in order from highest to lowest and correspond to the model's 7 airflow rate options (see Note 3). Sound pressure level is measured 1m in front and 1m above the floor in a semi-anechoic chamber.
 - Unit body dimensions given are the largest external dimensions of the unit, including hanger attachments.

Branch Joints

Type	Appearance	Model	Packed Dimensions mm	Gross Weight kg	Note
Branch joints for outdoor units		BJC-02E-CM(i)	255x150x185	2.0	Connecting two outdoor units
		BJC-03E-CM(i)	345x160x285	4.3	Connecting three outdoor units
Branch joints for indoor units		BJF-224-CM(i)	290x105x100	0.4	/
		BJF-330-CM(i)	290x105x100	0.6	/
		BJF-710-CM(i)	310x130x125	0.9	/
		BJF-1344-CM(i)	350x180x170	1.5	/
		BJF-E1344-CM(i)	365x195x215	1.9	/
		BJF-E1500-CM(i)	390x230x255	3.1	/
		BJF-E2690-CM(i)	390x230x255	3.4	/

Dimensions

Outdoor Branch Joints

Model	Gas side joints	Liquid side joints
BJC-02E-CM(i)		
BJC-03E-CM(i)		

Dimensions

Indoor Branch Joints

Model	Gas side joints	Liquid side joints
BJF-224-CM(i)		
BJF-330-CM(i)		
BJF-710-CM(i)		
BJF-1344-CM(i)		
BJF-E1344-CM(i)		
BJF-E1500-CM(i)		
BJF-E2690-CM(i)		

Branch Pipe

Branch joints of two-pipe refrigerant system

Model	Appearance	Model name	Packing Size (mm)	Gross Weight (kg)	Description
		BJC-02-CM(i)	255x150x185	1.5	For two outdoor units connection
		BJC-03-CM(i)	345x160x285	3.4	For three outdoor units connection
		BJC-04-CM(i)	475x165x300	4.8	For four outdoor units connection

Branch joint for R410A outdoor unit

A*:The total capacity of indoor units which is connected to this branch joint

Model	Gas side joints	Liquid side joints
BJC-02-CM(i)		
BJC-03-CM(i)		
BJC-04-CM(i)		