



United Technologies

Product Data

AquaSnap®

Air-Cooled Chillers

50/60 Hz

11 to 150 Nominal Tons

(39 to 528 Nominal kW)

AQUASNAP greenspeed



30RAP018-150 Air-Cooled Chillers and
30RAP011-060 Air-Cooled Chillers with
Greenspeed® Intelligence
with Puron® Refrigerant (R-410A)

Carrier’s innovative chiller design provides savings at initial purchase, at installation, and for years afterward.

The AquaSnap chiller is an effective all-in-one package that is easy to install and easy to own. AquaSnap chillers operate quietly and efficiently. Value-added features include:

- Rotary scroll compression
- HFC Puron® refrigerant (R-410A)
- EERs (Energy Efficiency Ratios) for all units meet ASHRAE (American Society of Heating, Refrigeration and Air-Conditioning Engineers) Standard 90.1-2013
- EERs for 30RAP011-060 units with Greenspeed® Intelligence meet ASHRAE Standard 90.1-2016
- Low-sound AeroAcoustic™ fan system
- Easy to use ComfortLink controls
- Optional integrated hydronic pump package (60 Hz only) with VFD (variable frequency drive) compatible motors, with optional VFD on size 070-150 models
- Coil design flexibility—Microchannel and RTPF coil technology available on all units
- Accessory fluid storage tank on size 011-060 models
- Optional digital scroll compressors on size 011-090 models
- Optional high-efficiency, variable-speed condenser fans (30RAP011-060 with Greenspeed® intelligence)

Costs less right from the start

Carrier’s AquaSnap chillers feature a compact, all-in-one package design that installs quickly and easily on the ground or the rooftop.

The optional pump and hydronic components (60 Hz only) are already built in; this costs less than buying and installing the components individually. The chiller’s fully integrated and pre-assembled hydronic system (60 Hz only) installs in minutes.

Among chillers in its class, the AquaSnap chiller is one of the easiest and least expensive to install.

The preassembled and integrated hydronic module uses high-quality components and pumps to ensure years of reliable operation.

Use of the optional fluid storage tank, available on size 011-060 models, reduces installation costs and ensures that sufficient fluid volume is available for close-coupled and process cooling applications. The AquaSnap unit’s high efficiency keeps energy costs down.

AquaSnap® chillers make noise in the marketplace, not the workplace.

The AquaSnap chiller’s low-sound AeroAcoustic™ fan produces up to half the sound level of propeller fans. Much of the noise reduction is in frequencies where noise is most annoying, which makes AquaSnap chillers ideal for sound-sensitive environments. When lower ambient temperatures allow part load operation or during scheduled nighttime operation, the units operate with fewer fans and become even quieter. AquaSnap chillers are quiet during the day and even quieter at night.

Savings will continue to mount

Besides costing less to buy and install, AquaSnap chillers are also affordable to operate. Carrier’s Aqua Series chillers are our most efficient air-cooled

models. The AquaSnap chiller provides full load EER (Energy Efficiency Ratio) up to 10.60 for 60 Hz applications and up to 11.15 for 50 Hz applications. The AquaSnap chiller provides IPLV (integrated part load value) up to 16.00 for 60 Hz applications, and up to 16.70 for 50 Hz applications. When Greenspeed® intelligence is employed, the IPLV values rise to as high as 16.78 for 60 Hz applications and up to 17.43 for 50 Hz applications. AquaSnap chillers use ultra-quiet, high-efficiency rotary scroll compressors, operated in tandem (sizes 011-060) and tandem or trio (sizes 070-150) per independent circuit for greater efficiency at partial loads.

30RAP chillers with Greenspeed intelligence feature a high-efficiency, variable-speed condenser fan option along with fine-tuned ComfortLink controls, which together provide premium part load efficiency to facilitate reduced utility costs over the lifespan of the chiller. Additionally, the lower sound levels achieved at part load conditions can be very beneficial for sensitive acoustic applications. NOTE: Unit sizes 011 and 016 are only available with Greenspeed intelligence.

Standard DC link reactor for 30RAP units with Greenspeed intelligence is included in all drives for the fans. The use of this component mitigates customer concern over electrical system harmonics; therefore, AC line reactors should not be required for applications employing 30RAP chillers with Greenspeed intelligence.

Electronic expansion valve (EXV) allows for precise control through all operating ranges, resulting in higher efficiency and improved reliability.

Proven reliability that’s built in

Thousands of AquaSnap chillers are already in service around the world. This field-proven design is backed by a 12-month warranty that includes the hydronic system. The compressors are maintenance-free and protected by an auto-adaptive control that minimizes compressor wear. Unit sizes 035 and up have two independent refrigerant circuits to increase system safety and flexibility. Year-round operation is standard, from -20°F (-29°C) (with optional cooler heater, low ambient control [on units with fixed speed fans], and wind baffles) to 120°F (50°C).

Table of contents

	Page
Features/Benefits	2
Model Number Nomenclature	5
Physical Data	7
Options and Accessories	19
Base Unit Dimensions	22
Accessory Dimensions	30
Selection Procedure	33
Performance Data	34
Typical Piping and Wiring	60
Electrical Data	64
Controls	84
Typical Control Wiring Schematic	87
Application Data	88
Guide Specifications	97

Rotary scroll compressors provide smooth, quiet, and reliable operation.

All-in-one package

AquaSnap chillers provide one of the most comprehensive chilled water circuits available for air-cooled chillers. Included is a brazed plate direct expansion cooler that may be remote-mounted. The cooler is also completely drainable with factory-installed vents and drains.

Strainer included

A 40-mesh strainer is provided with every 30RAP unit, making the chiller installation easier, lower in cost, and eliminating customer concern. Other manufacturers also require the strainer but may not include it with their chillers, giving the impression that they offer a lower pressure drop chiller. It is important to note that the strainer is required for all brazed plate heat exchangers; therefore, not considering it from the beginning may lead to the selection of the incorrect pump for the system and an incorrect evaluation of the overall installation cost.

Electronic thermal-dispersion

flow switch is included with the cooler. The switch is factory installed and tested and contains no moving parts for high reliability.

Optional integrated hydronic

package (60 Hz chillers only) is more than just a pump; it is an entire chilled-water system, including:

- Single/dual pumps up to 15 hp and 160 ft head
- Strainer
- Flow regulator
- Freeze protection to -20°F (-29°C) (with freeze protection option)
- Heaters
- Required piping
- Pressure/temperature taps
- Isolation valves for dual pump systems
- VFD available on sizes 070-150, and VFD compatibility on all models

The factory-installed and tested hydronic package provides faster, simpler and less expensive installation.

Digital scroll compressors are available as a factory-installed option on sizes 011-090. These allow for incremental unloading with capacity modulation to better match building load when compared to standard scroll compressors.

Environmentally balanced

Carrier's Puron® refrigerant (R-410A) is a responsible choice for protecting the earth's ozone layer. Puron refrigerant is an HFC refrigerant that does not contain chlorine that is damaging to the ozone layer. Puron refrigerant is a safe, efficient, and environmentally balanced refrigerant.

Durable construction

The 30RAP chillers have a structurally sound base that can be point-loaded; therefore, no perimeter base rail is required. All 30RAP units have weatherized cabinets constructed of heavy-duty galvanized steel with exterior panels painted with corrosion-resistant baked enamel. Inside and outside surfaces are protected to ensure long life and good appearance. The durable, galvanized steel, painted components exceed the requirements of the 500-hour salt spray test per ASTM (American Society for Testing and Materials) B117.

ComfortLink controls speak your language

The *ComfortLink* controls communicate in plain English, making it as easy as possible to monitor and control each AquaSnap chiller while accurately maintaining fluid temperatures. The large scrolling marquee display acts as a window into the unit's operation, providing easy-to-read information about chiller performance and over 15 diagnostic functions. Carrier's 30 Series chillers' *ComfortLink* controls provide features such as chilled water temperature reset, demand limiting, compressor wear minimization and protection, temperature and pressure displays, and diagnostic functions. These controls result in higher chiller reliability, simplified training, and more productive service calls with correspondingly lower operational and maintenance costs.

Carrier's exclusive accessory handheld Navigator™ display provides convenience and powerful information in the palm of your hand. The Navigator display helps technicians to quickly diagnose problems and even prevent them from occurring.

All AquaSnap units are ready to be used with the Carrier Comfort Network® (CCN) system.

A BACnet¹ communication option is also available for the i-Vu® Open control system or a third-party BACnet building automation system.

AquaSnap units minimize the impact on your footprint, as well as your bottom line

The integrated hydronics and the chilled fluid storage tank's placement under the chiller minimize the footprint, allowing easy installation almost anywhere.

Seismic certification

A seismic kit is available. Its use will result in a unit SDS (seismic design acceleration parameter) level of 2.5 for 30RAP011-060 units, or a unit SDS level of 2.1 for 30RAP070-150 units.

Novation® heat exchanger technology

The Novation heat exchanger design with microchannel (MCHX) condenser coil is a robust, cost effective alternative to traditional coil design. These coils are offered coated or uncoated to match coil protection to site conditions. The e-coated version of this coil can withstand an 8,000-hour salt spray test in accordance with ASTM B-117 Standard. The Carrier Electronic Catalog (E-Cat) can be used to determine whether or not corrosion protection is recommended for particular applications in coastal/marine environments. Following the input of the requested data, the E-Cat program output will recommend the appropriate coil to be used. Other factors described in "Selection Guide: Environmental Corrosion Protection" catalog number 04-581061-01 must also be considered to determine if corrosion protection is required.

Microchannel coils are more robust than other coil types, making them easier to clean without causing damage to the coil.

Due to the compact, all-aluminum design, microchannel coils will reduce average unit operating weight by 25% compared to the previous 30RA units. The streamlined MCHX coil design also reduces refrigerant charge by an average of 60% compared to previous 30RA units.

1. BACnet is a registered trademark of ASHRAE (American Society of Heating, Refrigerating, and Air-Conditioning Engineers).

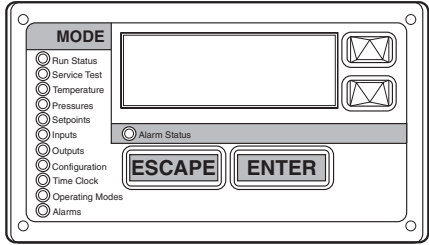

SCROLLING MARQUEE DISPLAY

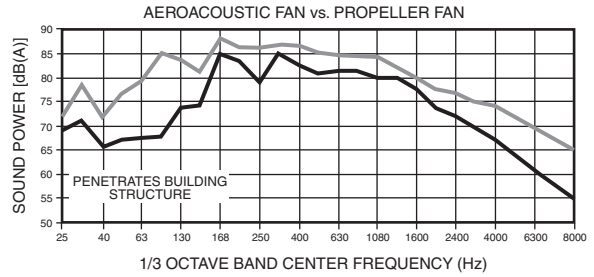

AEROACOUSTIC FAN VS PROPELLER FAN



NAVIGATOR™ DISPLAY MODULE

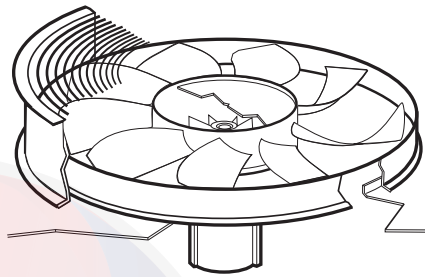

LOW-SOUND AEROACOUSTIC FAN WITH NIGHTTIME LOW SOUND

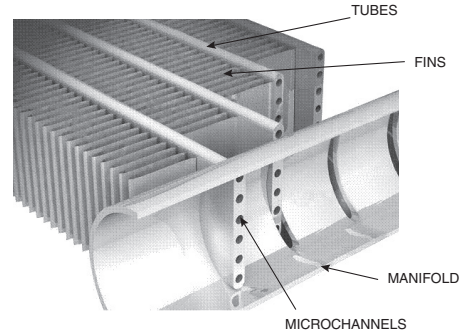

NOVATION® HEAT EXCHANGER TECHNOLOGY WITH MICROCHANNEL CONDENSER COILS



Model number nomenclature



AQUASNAP® CHILLER MODEL NUMBER DESIGNATION, 30RAP011-060

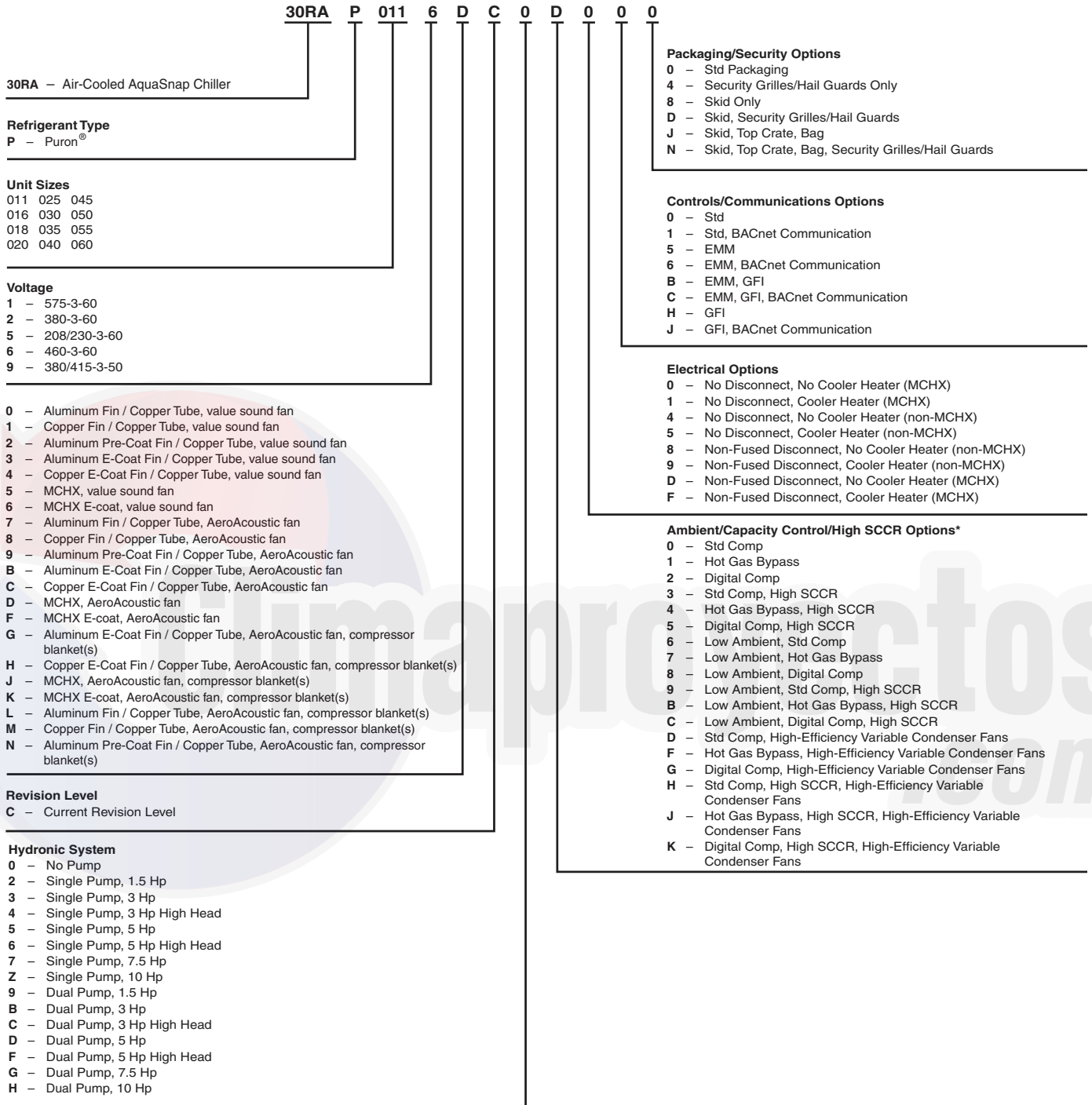

LEGEND

- EMM** — Energy Management Module
- GFI** — Ground Fault Interrupting
- MCHX** — Microchannel Heat Exchanger
- SCCR** — Short Circuit Current Rating

*High-efficiency variable condenser fans (codes D, F, G, H, J, and K) are the only choices for sizes 011 and 016.

Quality Assurance



ISO 9001: 2008-certified processes

SEISMICOMPLIANT*

* Meets IBC 2006, ASCE-7-05, CBC 2007, and OSHPD seismic requirements.

Model number nomenclature (cont)



AQUASNAP® CHILLER MODEL NUMBER DESIGNATION, 30RAP070-150

30RA P 070 6 D B 0 6 0 0 0

30RA – Air-Cooled AquaSnap Chiller

Refrigerant Type

P – Puron®

Unit Sizes

070 115
080 130
090 150
100

Voltage

1 – 575-3-60
2 – 380-3-60
5 – 208/230-3-60
6 – 460-3-60
9 – 380/415-3-50

Condenser Coil and Low Sound Options

0 – Aluminum/Copper, Value Sound Fan
1 – Copper/Copper, Value Sound Fan
2 – Aluminum/Copper, Pre-Coat, Value Sound Fan
3 – Aluminum/Copper, E-Coat, Value Sound Fan
4 – Copper/Copper, E-Coat, Value Sound Fan
5 – MCHX, Value Sound Fan
6 – MCHX, E-Coat, Value Sound Fan
7 – Aluminum/Copper, AeroAcoustic™ Fan
8 – Copper/Copper, AeroAcoustic Fan
9 – Copper/Aluminum, Pre-Coat, AeroAcoustic Fan
B – Copper/Aluminum, E-Coat, AeroAcoustic Fan
C – Copper/Copper, E-Coat, AeroAcoustic Fan
D – MCHX, AeroAcoustic Fan
F – MCHX, E-Coat, AeroAcoustic Fan
J – MCHX, AeroAcoustic Fan, Compressor Blanket(s)
K – MCHX, E-Coat, AeroAcoustic Fan, Compressor Blanket(s)
L – Aluminum/Copper, AeroAcoustic Fan, Compressor Blanket(s)
M – Copper/Copper, AeroAcoustic Fan, Compressor Blanket(s)
N – Aluminum/Copper, Pre-Coat, AeroAcoustic Fan, Compressor Blanket(s)
P – Aluminum/Copper, E-Coat, AeroAcoustic Fan, Compressor Blanket(s)
Q – Copper/Copper, E-Coat, AeroAcoustic Fan, Compressor Blanket(s)

Revision Level

B – Current Revision Level

Hydronic System

0 – No Pump
2 – Single Pump, 5 Hp
3 – Single Pump, 7.5 Hp
4 – Single Pump, 10 Hp
5 – Single Pump, 15 Hp
8 – Dual Pump, 7.5 Hp
9 – Dual Pump, 10 Hp
B – Dual Pump, 15 Hp
D – Single Pump, 5 Hp with VFD
F – Single Pump, 7.5 Hp with VFD
G – Single Pump, 10 Hp with VFD
H – Single Pump, 15 Hp with VFD
L – Dual Pump, 7.5 Hp with VFD
M – Dual Pump, 10 Hp with VFD
N – Dual Pump, 15 Hp with VFD

Packaging/Security Options

0 – Std Packaging
4 – Security Grilles/Hail Guards Only
8 – Skid Only
D – Skid, Security Grilles/Hail Guards
J – Skid, Top Crate, Bag
N – Skid, Top Crate, Bag, Security Grilles/Hail Guards

Controls/Communications Options

0 – Std
1 – Std, BACnet Communication
5 – EMM
6 – EMM, BACnet Communication
B – EMM, GFI
C – EMM, GFI, BACnet Communication
H – GFI
J – GFI, BACnet Communication

Electrical Options

0 – Single Point, No Disconnect, No Cooler Heater
1 – Single Point, No Disconnect, Cooler Heater
2 – Single Point, Non-Fused Disconnect, No Cooler Heater
3 – Single Point, Non-Fused Disconnect, Cooler Heater
4 – Dual Point, No Disconnect, No Cooler Heater
5 – Dual Point, No Disconnect, Cooler Heater

Ambient/Capacity Control/High SCCR Options

0 – Std Comp
1 – Hot Gas Bypass
2 – Digital Comp
3 – Std Comp, High SCCR
4 – Hot Gas Bypass, High SCCR
5 – Digital Comp, High SCCR
6 – Low Ambient, Std Comp
7 – Low Ambient, Hot Gas Bypass
8 – Low Ambient, Digital Comp
9 – Low Ambient, Std Comp, High SCCR
B – Low Ambient, Hot Gas Bypass, High SCCR
C – Low Ambient, Digital Comp, High SCCR
D – Std Comp, Suction Service Valve
F – Hot Gas Bypass, Suction Service Valve
G – Digital Comp, Suction Service Valve
H – Std Comp, High SCCR, Suction Service Valve
J – Hot Gas Bypass, High SCCR, Suction Service Valve
K – Digital Comp, High SCCR, Suction Service Valve
L – Low Ambient, Std Comp, Suction Service Valves
M – Low Ambient, Hot Gas Bypass, Suction Service Valves
N – Low Ambient, Digital Comp, Suction Service Valves
P – Low Ambient, Std Comp, High SCCR, Suction Service Valves
Q – Low Ambient, Hot Gas Bypass, High SCCR, Suction Service Valves
R – Low Ambient, Digital Comp, High SCCR, Suction Service Valves

LEGEND

EMM — Energy Management Module
GFI — Ground Fault Interrupting
MCHX — Microchannel Heat Exchanger
SCCR — Short Circuit Current Rating
VFD — Variable Frequency Drive

Quality Assurance

ISO 9001: 2008-certified processes



Physical data



ENGLISH

UNIT 30RAP	011	016	018	020	025	
OPERATING WEIGHT (lb)						
MCHX Condenser Coil, No Pump	762	800	1125	1133	1242	
MCHX Condenser Coil, Single Pump (60 Hz only)	925	963	1288	1296	1405	
MCHX Condenser Coil, Dual Pump (60 Hz only)	1087	1125	1450	1458	1567	
Al-Cu Condenser Coil, No Pump	822	860	1197	1205	1332	
Al-Cu Condenser Coil, Single Pump (60 Hz only)	985	1023	1360	1368	1495	
Al-Cu Condenser Coil, Dual Pump (60 Hz only)	1147	1185	1522	1530	1657	
Cu-Cu Condenser Coil, No Pump	903	941	1337	1345	1508	
Cu-Cu Condenser Coil, Single Pump (60 Hz only)	1066	1104	1500	1508	1671	
Cu-Cu Condenser Coil, Dual Pump (60 Hz only)	1228	1266	1662	1670	1833	
REFRIGERANT TYPE						
Total Refrigerant Charge MCHX (lb)	8.3	9.3	R-410A, EXV Controlled System		15.2	16.7
Refrigerant Charge MCHX (lb) Ckt A/Ckt B	8.3/—	9.3/—	14.6/—	15.2/—	16.7/—	16.7/—
Total Refrigerant Charge RTPF (lb)	20.3	21.3	31.0	31.6	36.9	36.9
Refrigerant Charge RTPF (lb) Ckt A/Ckt B	20.3/—	21.3/—	31.0/—	31.6/—	36.9/—	36.9/—
COMPRESSORS						
Scroll, Hermetic						
Quantity	2	2	2	2	2	
Speed (Rpm)	3500 (60 Hz)/2900 (50 Hz)					
(Qty) Tons, Ckt A	(2) 6/4	(2) 9/6	(2) 9	(2) 10	(2) 13	
(Qty) Tons, Ckt B	—	—	—	—	—	
Oil Charge (Pt) Ckt A/Ckt B	6.4/—	9.1/—	13.8/—	13.8/—	13.8/—	
No. Capacity Steps						
Standard	3	3	2	2	2	
With Hot Gas Bypass	—	—	3	3	3	
Digital Compressor Option	21	21	22	22	22	
Minimum Capacity Step (%)						
Standard	40	40	50	50	50	
With Hot Gas Bypass	—	—	20	24	29	
Digital Compressor Option	20	20	17	17	17	
Capacity (%)						
Circuit A	100	100	100	100	100	
Circuit B	—	—	—	—	—	
COOLER						
Braze, Direct-Expansion Plate Heat Exchanger						
Weight (lb) (empty)	22.4	31.8	31.8	40.3	46.3	
Net Fluid Volume (gal)	0.6	0.9	0.9	1.2	1.4	
Maximum Refrigerant Pressure (psig)	505	505	505	505	505	
Maximum Water-Side Pressure Without Pump(s) (psig)	300	300	300	300	300	
Maximum Water-Side Pressure With Pump(s) (psig)	150	150	150	150	150	
CHILLER WATER CONNECTIONS (in.)						
Inlet and Outlet, Victaulic (IPS Carbon Steel)*	2	2	2	2	2	
Drain (NPT)	1/4	1/4	1/4	1/4	1/4	
CONDENSER FANS						
Standard Low-Sound AeroAcoustic™ Type						
Fan Speed (Rpm)						
Plastic Type, Axial, Vertical Discharge 850 (60 Hz)/710 (50 Hz)						
No. Blades...Diameter (in.)	9...30	9...30	9...30	9...30	9...30	
No. Fans	1	1	2	2	2	
Total Airflow 60 Hz (Cfm)	9400	9400	17,500	17,500	19,400	
Total Airflow 50 Hz (Cfm)	7849	7849	14,613	14,613	16,199	
Optional Value Sound Type						
Propeller Type, Axial, Vertical Discharge 1140 (60 Hz)/950 (50 Hz)						
Fan Speed (Rpm)	4...30	4...30	4...30	4...30	4...30	
No. Blades...Diameter (in.)	4...30	4...30	4...30	4...30	4...30	
No. Fans	1	1	2	2	2	
Total Airflow 60 Hz (Cfm)	10,100	10,100	18,500	18,500	20,900	
Total Airflow 50 Hz (Cfm)	8434	8434	15,448	15,448	17,452	
CONDENSER COILS						
Novation® MCHX Aluminum Tube, Aluminum Fin						
Quantity (Ckt A/Ckt B)	1/—	1/—	1/—	1/—	1/—	
Total Face Area (sq ft)	19	19	26	26	33	
Maximum Refrigerant Pressure (psig)	656	656	656	656	656	
HYDRONIC MODULE (Optional, 60 Hz only)†						
Pump(s), Strainer with Blowdown Valve, Expansion Tank, Pressure Taps, Drain and Vent Plugs, Flow Switch, and Balance Valve						
Single or Dual, Centrifugal Monocell Pump(s), 3500 Rpm. Dual pumps with check valves and isolation valves.						
Pump						
Expansion Tank Volume (gal) Total/Acceptance	4.4/3.2					
CHASSIS DIMENSIONS (ft - in.)						
Length	5-7	5-7	7-5	7-5	7-5	
Width	3-5	3-5	3-5	3-5	3-5	
Height	5-6	5-6	5-6	5-6	6-6	

LEGEND

EXV — Electronic Expansion Valve
MCHX — Microchannel Heat Exchanger
RTPF — Round Tube, Plate Fin (Condenser Coil)

*Unit connection is IPS Carbon Steel piping.

†Flow switch and strainer are standard on all units, with or without hydronic package.

NOTE: 30RAP chillers with Greenspeed® intelligence are not available on unit sizes 070-150.

Physical data (cont)



ENGLISH (cont)

UNIT 30RAP	030	035	040	045	050	055	060
OPERATING WEIGHT (lb)							
MCHX Condenser Coil, No Pump	1283	2163	2185	2238	2263	2369	2375
MCHX Condenser Coil, Single Pump (60 Hz only)	1446	2507	2529	2582	2606	2713	2719
MCHX Condenser Coil, Dual Pump (60 Hz only)	1608	2850	2872	2925	2950	3056	3062
Al-Cu Condenser Coil, No Pump	1372	2308	2330	2417	2442	2548	2554
Al-Cu Condenser Coil, Single Pump (60 Hz only)	1535	2652	2674	2761	2785	2892	2898
Al-Cu Condenser Coil, Dual Pump (60 Hz only)	1697	2995	3017	3104	3129	3235	3241
Cu-Cu Condenser Coil, No Pump	1548	2588	2610	2769	2794	2900	2906
Cu-Cu Condenser Coil, Single Pump (60 Hz only)	1711	2932	2954	3113	3137	3244	3250
Cu-Cu Condenser Coil, Dual Pump (60 Hz only)	1873	3275	3297	3456	3481	3587	3593
REFRIGERANT TYPE							
Total Refrigerant Charge MCHX (lb)	19.0	31.0	31.4	34.6	36.6	37.0	37.0
Refrigerant Charge MCHX (lb) Ckt A/Ckt B	19.0/—	15.5/15.5	15.6/15.8	17.3/17.3	18.2/18.4	18.5/18.5	18.5/18.5
Total Refrigerant Charge RTPF (lb)	39.3	63.4	63.8	70.6	72.6	73.0	73.0
Refrigerant Charge RTPF (lb) Ckt A/Ckt B	39.3/—	31.7/31.7	31.8/32.0	35.3/35.3	36.2/36.4	36.5/36.5	36.5/36.5
COMPRESSORS							
Quantity	2	4	4	4	4	4	4
Speed (Rpm)			3500	3500	2900	2900	2900
(Qty) Tons, Ckt A	(2) 15	(2) 10	(2) 10	(2) 11	(2) 13	(2) 13	(2) 15
(Qty) Tons, Ckt B	—	(2) 9	(2) 11	(2) 13	(2) 13	(2) 15	(2) 15
Oil Charge (Pt) Ckt A/Ckt B	13.8/—	13.8/13.8	13.8/13.8	13.8/13.8	13.8/13.8	13.8/13.8	13.8/13.8
No. Capacity Steps							
Standard	2	4	4	4	4	4	4
With Hot Gas Bypass	3	5	5	5	5	5	5
Digital Compressor Option	22	44	44	44	44	44	44
Minimum Capacity Step (%)							
Standard	50	23	23	24	25	23	25
With Hot Gas Bypass	32	9	11	12	14	13	16
Digital Compressor Option	17	9	8	8	8	8	8
Capacity (%)							
Circuit A	100	54	47	47	50	46	50
Circuit B	—	46	53	53	50	54	50
COOLER							
Weight (lb) (empty)	99.3	98	109	117	129	140	140
Net Fluid Volume (gal)	2.62	3.4	3.9	4.2	4.6	5.2	5.2
Maximum Refrigerant Pressure (psig)	565	565	565	565	565	565	565
Maximum Water-Side Pressure							
Without Pump(s) (psig)	300	300	300	300	300	300	300
Maximum Water-Side Pressure							
With Pump(s) (psig)	150	150	150	150	150	150	150
CHILLER WATER CONNECTIONS (in.)							
Inlet and Outlet, Victaulic (IPS Carbon Steel)*	2	2 1/2	2 1/2	2 1/2	2 1/2	2 1/2	2 1/2
Drain (NPT)	1/4	1/4	1/4	1/4	1/4	1/4	1/4
CONDENSER FANS							
Standard Low-Sound AeroAcoustic™ Type							
Fan Speed (Rpm)				850 (60 Hz)/710 (50 Hz)			
No. Blades...Diameter (in.)	9...30	9...30	9...30	9...30	9...30	9...30	9...30
No. Fans	2	3	3	3	3	4	4
Total Airflow 60 Hz (Cfm)	19,400	29,600	29,600	30,500	30,500	38,800	38,800
Total Airflow 50 Hz (Cfm)	16,199	24,716	24,716	25,468	25,468	32,398	32,398
Optional Value Sound Type							
Fan Speed (Rpm)				1140 (60 Hz)/950 (50 Hz)			
No. Blades...Diameter (in.)	4...30	4...30	4...30	4...30	4...30	4...30	4...30
No. Fans	2	3	3	3	3	4	4
Total Airflow 60 Hz (Cfm)	20,900	32,000	32,000	33,300	33,300	41,800	41,800
Total Airflow 50 Hz (Cfm)	17,452	26,720	26,720	27,805	27,805	34,903	34,903
CONDENSER COILS							
Quantity (Ckt A/Ckt B)	1/—	1/1	1/1	1/1	1/1	1/1	1/1
Total Face Area (sq ft)	33	53	53	66	66	66	66
Maximum Refrigerant Pressure (psig)	656	656	656	656	656	656	656
HYDRONIC MODULE (Optional, 60 Hz only)†							
Pump	Pump(s), Strainer with Blowdown Valve, Expansion Tank, Pressure Taps, Drain and Vent Plugs, Flow Switch, and Balance Valve						
Expansion Tank Volume (gal)	Single or Dual, Centrifugal Monocell Pump(s), 3500 Rpm. Dual pumps with check valves and isolation valves.						
Total/Acceptance	4.4/3.2	10.3/10.3					
CHASSIS DIMENSIONS (ft - in.)							
Length	7-5	7-5	7-5	7-5	7-5	7-5	7-5
Width	3-5	7-9	7-9	7-9	7-9	7-9	7-9
Height	6-6	5-6	5-6	6-6	6-6	6-6	6-6

LEGEND

- EXV — Electronic Expansion Valve
- MCHX — Microchannel Heat Exchanger
- RTPF — Round Tube, Plate Fin (Condenser Coil)

*Unit connection is IPS Carbon Steel piping.

†Flow switch and strainer are standard on all units, with or without hydronic package.

NOTE: 30RAP chillers with Greenspeed® intelligence are not available on unit sizes 070-150.

ENGLISH (cont)

UNIT 30RAP	070	080	090	100	115	130	150
OPERATING WEIGHT (lb)							
MCHX Condenser Coil, No Pump	3410	3641	3697	4690	5008	6451	6938
MCHX Condenser Coil, Single Pump (60 Hz only)	3812	4035	4061	5089	5407	6850	7337
MCHX Condenser Coil, Dual Pump (60 Hz only)	4092	4390	4411	5374	5692	7135	7622
AI-Cu Condenser Coil, No Pump	3759	4064	4119	5548	5939	7113	7673
AI-Cu Condenser Coil, Single Pump (60 Hz only)	4161	4457	4483	5947	6338	7512	8072
AI-Cu Condenser Coil, Dual Pump (60 Hz only)	4441	4737	4763	6232	6623	7797	8357
Cu-Cu Condenser Coil, No Pump	4359	4784	4839	6388	6899	8193	8873
Cu-Cu Condenser Coil, Single Pump (60 Hz only)	4761	5177	5203	6787	7298	8592	9272
Cu-Cu Condenser Coil, Dual Pump (60 Hz only)	5041	5457	5483	7072	7583	8877	9557
REFRIGERANT TYPE			R-410A, EXV Controlled System				
Total Refrigerant Charge MCHX (lb)	60.5	70.2	71.0	88.3	100.9	110.4	119.5
Refrigerant Charge MCHX (lb) Ckt A/Ckt B	25.5/35	35.1/35.1	35.5/35.5	39.3/49.0	50.6/50.3	51.2/59.2	60.0/59.5
Total Refrigerant Charge RTPF (lb)	150.0	169.2	170.0	192.0	213.0	239.2	264.0
Refrigerant Charge RTPF (lb) Ckt A/Ckt B	65.5/84.5	84.6/84.6	85.0/85.0	87.0/105.0	106.5/106.5	107.5/131.7	132.0/132.0
COMPRESSORS			Scroll, Hermetic				
Quantity	5	6	6	5	6	6	6
Speed (Rpm)			3500 (60 Hz)/ 2900 (50 Hz)				
(Qty, Tons) Ckt A	(2) 15	(3) 13	(3) 15	(1) 20 (1) 25	(3) 20	(3) 20	(3) 25
(Qty, Tons) Ckt B	(3) 15	(3) 15	(3) 15	(3) 20	(3) 20	(3) 25	(3) 25
Oil Charge (Pt) Ckt A/Ckt B	13.8/20.6	20.6/20.6	20.6/20.6	28.4/42.6	42.6/42.6	42.6/42.6	42.6/42.6
No. Capacity Steps							
Standard	5	6	6	5	6	6	6
With Hot Gas Bypass	6	7	7	6	7	7	7
Digital Compressor Option	55	66	66	—	—	—	—
Minimum Capacity Step (%)							
Standard	20	15	17	19	17	15	17
With Hot Gas Bypass	13	9	11	13	11	9	11
Digital Compressor Option	7	5	6	—	—	—	—
Capacity (%)							
Circuit A	40	46	50	43	50	44	50
Circuit B	60	54	50	57	50	56	50
COOLER			Braze, Direct-Expansion Plate Heat Exchanger				
Weight (lb) (empty)	197	228	245	267	304	334	378
Net Fluid Volume (gal)	4.3	5.0	6.8	7.4	8.6	9.5	10.9
Maximum Refrigerant Pressure (psig)	450	450	450	450	450	450	450
Maximum Water-Side Pressure Without Pump(s) (psig)	300	300	300	300	300	300	300
Maximum Water-Side Pressure With Pump(s) (psig)	150	150	150	150	150	150	150
CHILLER WATER CONNECTIONS (in.)							
Inlet and Outlet, Victaulic (IPS Carbon Steel)*	3	3	3	4	4	4	4
Drain (NPT)	1/4	1/4	1/4	1/4	1/4	1/4	1/4
CONDENSER FANS			Plastic Type, Axial, Vertical Discharge				
Standard Low-Sound AeroAcoustic™ Type			850 (60 Hz)/710 (50 Hz)				
Fan Speed (Rpm)			9...30	9...30	9...30	9...30	9...30
No. Blades...Diameter (in.)	5	6	6	7	8	9	10
Total Airflow, 60 Hz (Cfm)	48,500	58,200	58,200	67,900	77,600	87,300	97,000
Total Airflow, 50 Hz (Cfm)	40,512	48,614	48,614	56,716	64,819	72,921	81,024
Optional Value Sound Type			Propeller Type, Axial, Vertical Discharge				
Fan Speed (Rpm)			1140 (60 Hz)/950 (50 Hz)				
No. Blades...Diameter (in.)	4...30	4...30	4...30	4...30	4...30	4...30	4...30
No. Fans	5	6	6	7	8	9	10
Total Airflow, 60 Hz (Cfm)	51,250	61,500	61,500	71,750	82,000	92,250	102,500
Total Airflow, 50 Hz (Cfm)	42,809	51,371	51,371	59,932	68,494	77,056	85,618
CONDENSER COILS			Novation® MCHX Aluminum Tube, Aluminum Fin or RTPF				
Quantity (Ckt A/Ckt B)	2/3	3/3	3/3	3/4	4/4	4/5	5/5
Total Face Area (sq ft)	124.7	149.6	149.6	174.5	199.4	224.4	249.3
Maximum Refrigerant Pressure (psig)	656	656	656	656	656	656	656
HYDRONIC MODULE (Optional, 60 Hz Only)†			Pump(s), Strainer with Blowdown Valve, Expansion Tank, Pressure Taps, Drain and Vent Plugs, Flow Switch, and Balance Valve				
Pump			Single or Dual, Centrifugal Monocell Pump(s), 3500 Rpm. Dual pumps with check valves and isolation valves.				
Expansion Tank Volume (gal)							
Total/Acceptance	—	—	—	—	—	—	—
CHASSIS DIMENSIONS (ft - in.)							
Length	12-7	12-7	12-7	15-11	15-11	19-4	19-4
Width	7-4	7-4	7-4	7-4	7-4	7-4	7-4
Height	6-6	6-6	6-6	6-6	6-6	6-6	6-6

LEGEND

- EXV — Electronic Expansion Valve
- MCHX — Microchannel Heat Exchanger
- RTPF — Round Tube, Plate Fin (Condenser Coil)

*Unit connection is IPS Carbon Steel piping.

†Flow switch and strainer are standard on all units, with or without hydronic package.

NOTE: 30RAP chillers with Greenspeed® intelligence are not available on unit sizes 070-150.

Physical data (cont)



SI

UNIT 30RAP	011	016	018	020	025
OPERATING WEIGHT (kg)					
MCHX Condenser Coil, No Pump	346	363	510	514	564
MCHX Condenser Coil, Single Pump (60 Hz only)	419	437	584	588	637
MCHX Condenser Coil, Dual Pump (60 Hz only)	493	510	658	661	711
Al-Cu Condenser Coil, No Pump	373	390	543	547	604
Al-Cu Condenser Coil, Single Pump (60 Hz only)	447	464	617	621	678
Al-Cu Condenser Coil, Dual Pump (60 Hz only)	520	538	691	694	751
Cu-Cu Condenser Coil, No Pump	410	427	606	610	684
Cu-Cu Condenser Coil, Single Pump (60 Hz only)	484	501	680	684	758
Cu-Cu Condenser Coil, Dual Pump (60 Hz only)	557	574	754	757	831
REFRIGERANT TYPE					
	R-410A, EXV Controlled System				
Total Refrigerant Charge MCHX (kg)	3.8	4.2	6.6	7.1	7.6
Refrigerant Charge MCHX (kg) Ckt A/Ckt B	3.8/—	4.2/—	6.6/—	7.1/—	7.6/—
Total Refrigerant Charge RTPF (kg)	9.2	9.6	14.0	14.3	16.7
Refrigerant Charge RTPF (kg) Ckt A/Ckt B	9.2/—	9.6/—	14.0/—	14.3/—	16.7/—
COMPRESSORS					
	Scroll, Hermetic				
Quantity	2	2	2	2	2
Speed (R/s)	58.3 (60 Hz)/48.3 (50 Hz)				
(Qty) kW, Ckt A	(2) 21/14	(2) 31/21	(2) 32	(2) 35	(2) 46
(Qty) kW, Ckt B	—	—	—	—	—
Oil Charge (L) Ckt A/Ckt B	3/—	4.3/—	6.5/—	6.5/—	6.5/—
No. Capacity Steps					
Standard	3	3	2	2	2
With Hot Gas Bypass	—	—	3	3	3
Digital Compressor Option	21	21	22	22	22
Minimum Capacity Step (%)					
Standard	40	40	50	50	50
With Hot Gas Bypass	—	—	20	24	29
Digital Compressor Option	20	20	17	17	17
Capacity (%)					
Circuit A	100	100	100	100	100
Circuit B	—	—	—	—	—
COOLER					
	Brazed, Direct-Expansion Plate Heat Exchanger				
Weight (kg) (empty)	10.1	14.4	14.4	18.3	21.0
Net Fluid Volume (L)	2.3	3	3.4	4.5	5.3
Maximum Refrigerant Pressure (kPa)	3482	3482	3482	3482	3482
Maximum Water-Side Pressure Without Pump(s) (kPa)	2068	2068	2068	2068	2068
Maximum Water-Side Pressure With Pump(s) (kPa)	1034	1034	1034	1034	1034
CHILLER WATER CONNECTIONS (in.)					
Inlet and Outlet, Victaulic (IPS Carbon Steel)*	2	2	2	2	2
Drain (NPT)	1/4	1/4	1/4	1/4	1/4
CONDENSER FANS					
Standard Low-Sound AeroAcoustic™ Type					
Plastic Type, Axial, Vertical Discharge					
Fan Speed (R/s)	14.2 (60 Hz)/11.8 (50 Hz)				
No. Blades...Diameter (mm)	9...762	9...762	9...762	9...762	9...762
No. Fans	1	1	2	2	2
Total Airflow 60 Hz (L/s)	4437	4437	8260	8260	9157
Total Airflow 50 Hz (L/s)	3705	3705	6897	6897	7646
Optional Value Sound Type					
Propeller Type, Axial, Vertical Discharge					
Fan Speed (R/s)	19.0 (60 Hz)/15.8 (50 Hz)				
No. Blades...Diameter (mm)	4...762	4...762	4...762	4...762	4...762
No. Fans	1	1	2	2	2
Total Airflow 60 Hz (L/s)	4800	4800	8732	8732	9865
Total Airflow 50 Hz (L/s)	3981	3981	7291	7291	8237
CONDENSER COILS					
	Novation® MCHX Aluminum Tube, Aluminum Fin				
Quantity (Ckt A/Ckt B)	1/—	1/—	1/—	1/—	1/—
Total Face Area (sq m)	1.8	1.8	2.4	2.4	3.1
Maximum Refrigerant Pressure (kPa)	4523	4523	4523	4523	4523
HYDRONIC MODULE (Optional, 60 Hz Only)†					
Pump(s), Strainer with Blowdown Valve, Expansion Tank, Pressure Taps, Drain and Vent Plugs, Flow Switch, and Balance Valve					
Pump	Single or Dual, Centrifugal Monocell Pump(s), 3500 Rpm. Dual pumps with check valves and isolation valves.				
Expansion Tank Volume (L) Total/Acceptance	17.4/12.3				
CHASSIS DIMENSIONS (mm)					
Length	1689	1689	2242	2242	2242
Width	1029	1029	1025	1025	1025
Height	1689	1689	1689	1689	1994

LEGEND

- EXV — Electronic Expansion Valve
- MCHX — Microchannel Heat Exchanger
- RTPF — Round Tube, Plate Fin (Condenser Coil)

*Unit connection is IPS Carbon Steel piping.

†Flow switch and strainer are standard on all units, with or without hydronic package.

NOTE: 30RAP chillers with Greenspeed® intelligence are not available on unit sizes 070-150.

SI (cont)

UNIT 30RAP	030	035	040	045	050	055	060
OPERATING WEIGHT (kg)							
MCHX Condenser Coil, No Pump	582	981	991	1015	1026	1075	1077
MCHX Condenser Coil, Single Pump (60 Hz only)	656	1137	1147	1171	1182	1231	1233
MCHX Condenser Coil, Dual Pump (60 Hz only)	729	1293	1303	1327	1338	1386	1389
Al-Cu Condenser Coil, No Pump	623	1047	1057	1096	1108	1156	1159
Al-Cu Condenser Coil, Single Pump (60 Hz only)	696	1203	1213	1252	1263	1312	1315
Al-Cu Condenser Coil, Dual Pump (60 Hz only)	770	1358	1368	1408	1419	1467	1470
Cu-Cu Condenser Coil, No Pump	702	1174	1184	1256	1267	1316	1318
Cu-Cu Condenser Coil, Single Pump (60 Hz only)	776	1330	1340	1412	1423	1472	1474
Cu-Cu Condenser Coil, Dual Pump (60 Hz only)	850	1485	1495	1568	1579	1627	1630
REFRIGERANT TYPE							
Total Refrigerant Charge MCHX (kg)	8.6	14.1	14.3	15.7	16.6	16.8	16.8
Refrigerant Charge MCHX (kg) Ckt A/Ckt B	8.6/—	7.0/7.0	7.1/7.2	7.9/7.9	8.3/8.4	8.4/8.4	8.4/8.4
Total Refrigerant Charge RTPF (kg)	17.8	28.8	28.9	32.0	32.9	33.1	33.1
Refrigerant Charge RTPF (kg) Ckt A/Ckt B	17.8/—	14.4/14.4	14.4/14.5	16.0/16.0	16.4/16.5	16.6/16.6	16.6/16.6
COMPRESSORS							
Scroll, Hermetic							
Quantity	2	4	4	4	4	4	4
Speed (R/s)	58.3 (60 Hz)/48.3 (50 Hz)						
(Qty) kW, Ckt A	(2) 53	(2) 35	(2) 35	(2) 38	(2) 46	(2) 46	(2) 53
(Qty) kW, Ckt B	—	(2) 32	(2) 38	(2) 46	(2) 46	(2) 53	(2) 53
Oil Charge (L) Ckt A/Ckt B	6.5/—	6.5/6.5	6.5/6.5	6.5/6.5	6.5/6.5	6.5/6.5	6.5/6.5
No. Capacity Steps	Standard						
Standard	2	4	4	4	4	4	4
With Hot Gas Bypass	3	5	5	5	5	5	5
Digital Compressor Option	22	44	44	44	44	44	44
Minimum Capacity Step (%)	Standard						
Standard	50	23	23	24	25	23	25
With Hot Gas Bypass	32	9	11	12	14	13	16
Digital Compressor Option	17	9	8	8	8	8	8
Capacity (%)	Circuit A						
Circuit A	100	54	47	47	50	46	50
Circuit B	—	46	53	53	50	54	50
COOLER							
Braze, Direct-Expansion Plate Heat Exchanger							
Weight (kg) (empty)	45	44.5	49.5	53.2	58.6	63.6	63.6
Net Fluid Volume (L)	9.9	12.9	14.8	15.9	17.4	19.7	19.7
Maximum Refrigerant Pressure (kPa)	3896	3896	3896	3896	3896	3896	3896
Maximum Water-Side Pressure Without Pump(s) (kPa)	2068	2068	2068	2068	2068	2068	2068
Maximum Water-Side Pressure With Pump(s) (kPa)	1034	1034	1034	1034	1034	1034	1034
CHILLER WATER CONNECTIONS (in.)							
Inlet and Outlet, Victaulic (IPS Carbon Steel)*	2	2½	2½	2½	2½	2½	2½
Drain (NPT)	¼	¼	¼	¼	¼	¼	¼
CONDENSER FANS							
Standard Low-Sound AeroAcoustic™ Type							
Fan Speed (R/s)	Plastic Type, Axial, Vertical Discharge 14.2 (60 Hz)/11.8 (50 Hz)						
No. Blades...Diameter (mm)	9...762	9...762	9...762	9...762	9...762	9...762	9...762
No. Fans	2	3	3	3	3	4	4
Total Airflow 60 Hz (L/s)	9157	13 971	13 971	14 396	14 396	18 314	18 314
Total Airflow 50 Hz (L/s)	7646	11 666	11 666	12 021	12 021	15 292	15 292
Optional Value Sound Type							
Fan Speed (R/s)	Propeller Type, Axial, Vertical Discharge 19.0 (60 Hz)/15.8 (50 Hz)						
No. Blades...Diameter (mm)	4...762	4...762	4...762	4...762	4...762	4...762	4...762
No. Fans	2	3	3	3	3	4	4
Total Airflow 60 Hz (L/s)	9865	15 104	15 104	15 718	15 718	19 730	19 730
Total Airflow 50 Hz (L/s)	8237	12 612	12 612	13 124	13 124	16 474	16 474
CONDENSER COILS							
Novation® MCHX Aluminum Tube, Aluminum Fin							
Quantity (Ckt A/Ckt B)	1/—	1/1	1/1	1/1	1/1	1/1	1/1
Total Face Area (sq m)	3.1	4.9	4.9	6.1	6.1	6.1	6.1
Maximum Refrigerant Pressure (kPa)	4523	4523	4523	4523	4523	4523	4523
HYDRONIC MODULE (Optional, 60 Hz Only)†							
Pump	Pump(s), Strainer with Blowdown Valve, Expansion Tank, Pressure Taps, Drain and Vent Plugs, Flow Switch, and Balance Valve						
Expansion Tank Volume (L)	Single or Dual, Centrifugal Monocell Pump(s), 3500 Rpm. Dual pumps with check valves and isolation valves.						
Total/Acceptance	17.4/12.3						39.0/39.0
CHASSIS DIMENSIONS (mm)							
Length	2242	2248	2248	2248	2248	2248	2248
Width	1025	2350	2350	2350	2350	2350	2350
Height	1994	1689	1689	1994	1994	1994	1994

LEGEND

- EXV — Electronic Expansion Valve
- MCHX — Microchannel Heat Exchanger
- RTPF — Round Tube, Plate Fin (Condenser Coil)

*Unit connection is IPS Carbon Steel piping.

†Flow switch and strainer are standard on all units, with or without hydronic package.

NOTE: 30RAP chillers with Greenspeed® intelligence are not available on unit sizes 070-150.

Physical data (cont)



SI (cont)

UNIT 30RAP	070	080	090	100	115	130	150
OPERATING WEIGHT (kg)							
MCHX Condenser Coil, No Pump	1547	1652	1677	2127	2272	2926	3147
MCHX Condenser Coil, Single Pump (60 Hz only)	1729	1830	1842	2308	2453	3107	3328
MCHX Condenser Coil, Dual Pump (60 Hz only)	1856	1991	2001	2438	2582	3236	3457
Al-Cu Condenser Coil, No Pump	1705	1843	1868	2517	2694	3226	3480
Al-Cu Condenser Coil, Single Pump (60 Hz only)	1887	2022	2033	2698	2875	3407	3661
Al-Cu Condenser Coil, Dual Pump (60 Hz only)	2014	2149	2160	2827	3004	3537	3791
Cu-Cu Condenser Coil, No Pump	1977	2170	2195	2898	3129	3716	4025
Cu-Cu Condenser Coil, Single Pump (60 Hz only)	2160	2348	2360	3079	3310	3897	4206
Cu-Cu Condenser Coil, Dual Pump (60 Hz only)	2287	2475	2487	3208	3440	4027	4335
REFRIGERANT TYPE							
	R-410A, EXV Controlled System						
Total Refrigerant Charge MCHX (kg)	27.5	31.8	32.2	40.1	45.8	50.1	54.2
Refrigerant Charge MCHX (kg) Ckt A/Ckt B	11.6/15.9	15.9/15.9	16.1/16.1	17.8/22.3	23.0/22.8	23.2/26.9	27.2/27.0
Total Refrigerant Charge RTPF (kg)	68.0	76.8	77.2	87.1	96.6	108.5	119.8
Refrigerant Charge RTPF (kg) Ckt A/Ckt B	29.7/38.3	38.4/38.4	38.6/38.6	39.5/47.6	48.3/48.3	48.8/59.7	59.9/59.9
COMPRESSORS							
	Scroll, Hermetic						
Quantity	5	6	6	5	6	6	6
Speed (R/s)	58.3 (60 Hz)/48.3 (50 Hz)						
(Qty, kW) Ckt A	(2) 53	(3) 46	(3) 53	(1) 70 (1) 87.9	(3) 70	(3) 70	(3) 87.9
(Qty, kW) Ckt B	(3) 53	(3) 53	(3) 53	(3) 70	(3) 70	(3) 87.9	(3) 87.9
Oil Charge (L) Ckt A/Ckt B	6.5/9.7	9.7/9.7	9.7/9.7	13.4/20.1	20.1/20.1	20.1/20.1	20.1/20.1
No. Capacity Steps							
Standard	5	6	6	5	6	6	6
With Hot Gas Bypass	6	7	7	6	7	7	7
Digital Compressor Option	55	66	66	—	—	—	—
Minimum Capacity Step (%)							
Standard	20	15	17	19	17	15	17
With Hot Gas Bypass	13	9	11	13	11	9	11
Digital Compressor Option	7	5	6	—	—	—	—
Capacity (%)							
Circuit A	40	46	50	43	50	44	50
Circuit B	60	54	50	57	50	56	50
COOLER							
	Braze, Direct-Expansion Plate Heat Exchanger						
Weight (kg) (empty)	89.4	103.4	111.1	121.0	137.7	151.3	171.2
Net Fluid Volume (L)	16.3	18.9	25.7	28.0	32.5	35.9	41.2
Maximum Refrigerant Pressure (kPa)	3103	3103	3103	3103	3103	3103	3103
Maximum Water-Side Pressure	2068	2068	2068	2068	2068	2068	2068
Without Pump(s) (kPa)							
Maximum Water-Side Pressure	1034	1034	1034	1034	1034	1034	1034
With Pump(s) (kPa)							
CHILLER WATER CONNECTIONS (in.)							
Inlet and Outlet, Victaulic (IPS Carbon Steel)*	3	3	3	4	4	4	4
Drain (NPT)	1/4	1/4	1/4	1/4	1/4	1/4	1/4
CONDENSER FANS							
	Standard Low-Sound AeroAcoustic™ Type						
	Plastic Type, Axial, Vertical Discharge						
Fan Speed (R/s)	14.2 (60 Hz)/11.8 (50 Hz)						
No. Blades...Diameter (mm)	9...762	9...762	9...762	9...762	9...762	9...762	9...762
No. Fans	5	6	6	7	8	9	10
Total Airflow, 60 Hz (L/s)	22 890	27 467	27 467	32 045	36 623	41 201	45 779
Total Airflow, 50 Hz (L/s)	19 120	22 943	22 943	26 767	30 591	34 415	38 239
	Optional Value Sound Type						
	Propeller Type, Axial, Vertical Discharge						
Fan Speed (R/s)	19.0 (60 Hz)/15.8 (50 Hz)						
No. Blades...Diameter (mm)	4...762	4...762	4...762	4...762	4...762	4...762	4...762
No. Fans	5	6	6	7	8	9	10
Total Airflow, 60 Hz (L/s)	24 187	29 025	29 025	33 862	38 700	43 537	48 375
Total Airflow, 50 Hz (L/s)	20 204	24 245	24 245	28 285	32 326	36 367	40 407
CONDENSER COILS							
	Novation® MCHX Aluminum Tube, Aluminum Fin or RTPF						
Quantity (Ckt A/Ckt B)	2/3	3/3	3/3	3/4	4/4	4/5	5/5
Total Face Area (sq m)	11.6	13.9	13.9	16.2	18.5	20.8	23.2
Maximum Refrigerant Pressure (kPa)	4523	4523	4523	4523	4523	4523	4523
HYDRONIC MODULE (Optional, 60 Hz Only)†							
Pump	Pump(s), Strainer with Blowdown Valve, Expansion Tank, Pressure Taps, Drain and Vent Plugs, Flow Switch, and Balance Valve						
Expansion Tank Volume (L)	Single or Dual, Centrifugal Monocell Pump(s), 3500 Rpm. Dual pumps with check valves and isolation valves.						
Total/Acceptance	—	—	—	—	—	—	—
CHASSIS DIMENSIONS (mm)							
Length	3826	3826	3826	4864	4864	5893	5893
Width	2241	2241	2241	2241	2241	2241	2241
Height	1976	1976	1976	1976	1976	1976	1976

LEGEND

- EXV — Electronic Expansion Valve
- MCHX — Microchannel Heat Exchanger
- RTPF — Round Tube, Plate Fin (Condenser Coil)

*Unit connection is IPS Carbon Steel piping.

†Flow switch and strainer are standard on all units, with or without hydronic package.

NOTE: 30RAP chillers with Greenspeed® intelligence are not available on unit sizes 070-150.

**UNIT WEIGHTS
MCHX COIL, NO PUMP UNITS**

30RAP SIZE	POUNDS						
	A	B	C	D	E	F	Total Weight
011	243	187	144	187	—	—	762
016	261	195	147	197	—	—	800
018	363	264	209	288	—	—	1125
020	365	266	211	290	—	—	1133
025	393	290	237	321	—	—	1242
030	405	301	246	331	—	—	1283
035	652	730	413	369	—	—	2163
040	704	697	390	394	—	—	2185
045	675	758	425	379	—	—	2238
050	732	724	401	405	—	—	2263
055	744	762	437	427	—	—	2369
060	746	762	438	429	—	—	2375
070	930	984	727	770	—	—	3410
080	936	1038	791	877	—	—	3641
090	952	1057	800	888	—	—	3697
100	779	805	963	617	595	931	4690
115	796	824	1027	697	672	991	5008
130	1100	1179	1430	680	682	1380	6451
150	1120	1205	1554	779	781	1499	6938

30RAP SIZE	KILOGRAMS						
	A	B	C	D	E	F	Total Weight
011	110	85	66	85	—	—	346
016	119	88	67	89	—	—	363
018	165	120	95	131	—	—	510
020	166	121	96	132	—	—	514
025	178	132	108	146	—	—	564
030	184	136	112	150	—	—	582
035	296	331	187	167	—	—	981
040	319	316	177	179	—	—	991
045	306	344	193	172	—	—	1015
050	332	328	182	184	—	—	1026
055	337	346	198	193	—	—	1075
060	338	346	199	194	—	—	1077
070	422	446	330	349	—	—	1547
080	425	471	359	398	—	—	1652
090	432	479	363	403	—	—	1677
100	353	365	437	280	270	422	2127
115	361	374	466	316	305	450	2272
130	499	535	649	309	309	626	2926
150	508	546	705	353	354	680	3147

MCHX COIL, SINGLE PUMP UNITS

30RAP SIZE	POUNDS						
	A	B	C	D	E	F	Total Weight
011	264	249	200	212	—	—	925
016	282	257	202	222	—	—	963
018	393	317	258	320	—	—	1288
020	395	319	260	322	—	—	1296
025	423	343	286	353	—	—	1405
030	436	352	294	364	—	—	1446
035	692	863	529	424	—	—	2507
040	743	832	504	450	—	—	2529
045	715	891	541	434	—	—	2582
050	771	858	515	462	—	—	2606
055	783	895	552	483	—	—	2713
060	785	896	553	485	—	—	2719
070	1036	1032	871	874	—	—	3812
080	1054	1070	963	948	—	—	4035
090	1063	1082	967	950	—	—	4061
100	1105	871	886	823	554	850	5089
115	1121	892	948	904	631	912	5407
130	1418	1252	1415	817	615	1333	6850
150	1437	1280	1537	916	714	1453	7337

30RAP SIZE	KILOGRAMS						
	A	B	C	D	E	F	Total Weight
011	120	113	91	96	—	—	419
016	128	117	92	101	—	—	437
018	178	144	117	145	—	—	584
020	179	145	118	146	—	—	588
025	192	155	130	160	—	—	637
030	198	160	133	165	—	—	656
035	314	391	240	192	—	—	1137
040	337	377	229	204	—	—	1147
045	324	404	245	197	—	—	1171
050	350	389	234	210	—	—	1182
055	355	406	250	219	—	—	1231
060	356	406	251	220	—	—	1233
070	470	468	395	396	—	—	1729
080	478	485	437	430	—	—	1830
090	482	491	438	431	—	—	1842
100	501	395	402	373	252	385	2308
115	508	405	430	410	286	414	2453
130	643	568	642	370	279	605	3107
150	652	581	697	415	324	659	3328

MCHX COIL, DUAL PUMP UNITS

30RAP SIZE	POUNDS						
	A	B	C	D	E	F	Total Weight
011	285	312	256	234	—	—	1087
016	303	320	257	244	—	—	1125
018	422	370	307	350	—	—	1450
020	424	372	309	352	—	—	1458
025	452	396	336	383	—	—	1567
030	465	405	344	394	—	—	1608
035	734	993	646	477	—	—	2850
040	783	964	621	505	—	—	2872
045	757	1022	659	488	—	—	2925
050	811	991	631	517	—	—	2950
055	824	1027	669	537	—	—	3056
060	826	1027	670	539	—	—	3062
070	1123	1036	928	1005	—	—	4092
080	1159	1094	1038	1099	—	—	4390
090	1167	1104	1041	1099	—	—	4411
100	1353	908	820	990	506	797	5374
115	1367	931	881	1070	583	860	5692
130	1658	1297	1404	922	559	1295	7135
150	1676	1326	1526	1020	659	1415	7622

30RAP SIZE	KILOGRAMS						
	A	B	C	D	E	F	Total Weight
011	129	142	116	106	—	—	493
016	138	145	117	111	—	—	510
018	191	168	139	159	—	—	658
020	192	169	140	160	—	—	661
025	205	180	152	174	—	—	711
030	211	184	156	179	—	—	729
035	333	451	293	216	—	—	1293
040	355	437	282	229	—	—	1303
045	343	464	299	221	—	—	1327
050	368	449	286	234	—	—	1338
055	374	466	303	243	—	—	1386
060	375	466	304	244	—	—	1389
070	509	470	421	456	—	—	1856
080	526	496	471	499	—	—	1991
090	529	501	472	499	—	—	2001
100	614	412	372	449	229	361	2438
115	620	422	400	485	264	360	2582
130	752	588	637	418	254	587	3236
150	760	601	692	463	299	642	3457

NOTES:

1. Mounting points are shown on page 18.
2. 30RAP chillers with Greenspeed® intelligence are not available on unit sizes 070-150.

UNIT WEIGHTS (cont) AL/CU COIL, NO PUMP UNITS

30RAP SIZE	POUNDS							Total Weight	30RAP SIZE	KILOGRAMS							Total Weight
	A	B	C	D	E	F	A			B	C	D	E	F			
011	244	192	170	216	—	—	822	011	111	87	77	98	—	—	373		
016	263	200	171	226	—	—	860	016	119	91	78	102	—	—	390		
018	367	267	237	326	—	—	1197	018	166	121	108	148	—	—	543		
020	369	269	239	328	—	—	1205	020	167	122	108	149	—	—	547		
025	397	293	273	369	—	—	1332	025	180	133	124	167	—	—	604		
030	409	303	281	379	—	—	1372	030	185	138	128	172	—	—	623		
035	695	779	440	393	—	—	2308	035	315	353	200	178	—	—	1047		
040	751	744	416	420	—	—	2330	040	340	337	189	190	—	—	1057		
045	729	819	459	409	—	—	2417	045	331	371	208	186	—	—	1096		
050	790	781	433	437	—	—	2441	050	358	354	196	198	—	—	1107		
055	800	819	470	459	—	—	2548	055	363	372	213	208	—	—	1156		
060	802	820	471	461	—	—	2554	060	364	372	214	209	—	—	1158		
070	1017	1030	862	851	—	—	3759	070	461	467	391	386	—	—	1705		
080	1062	1100	968	935	—	—	4064	080	482	499	439	424	—	—	1843		
090	1035	1153	1018	914	—	—	4119	090	469	523	462	414	—	—	1868		
100	887	911	1179	724	702	1145	5548	100	402	413	535	328	319	519	2517		
115	913	940	1261	813	789	1223	5939	115	414	427	572	369	358	555	2694		
130	1183	1261	1596	763	765	1545	7113	130	537	572	724	346	347	701	3226		
150	1213	1296	1739	871	873	1682	7673	150	550	588	789	395	396	763	3480		

AL/CU COIL, SINGLE PUMP UNITS

30RAP SIZE	POUNDS							Total Weight	30RAP SIZE	KILOGRAMS							Total Weight
	A	B	C	D	E	F	A			B	C	D	E	F			
011	265	254	228	238	—	—	984	011	120	115	104	108	—	—	447		
016	283	262	230	248	—	—	1022	016	128	119	104	113	—	—	464		
018	396	320	288	356	—	—	1360	018	180	145	130	162	—	—	617		
020	398	322	289	358	—	—	1368	020	181	146	131	163	—	—	620		
025	427	346	323	399	—	—	1494	025	194	157	147	181	—	—	678		
030	439	355	331	410	—	—	1535	030	199	161	150	186	—	—	696		
035	732	912	559	448	—	—	2652	035	332	414	254	203	—	—	1203		
040	785	879	533	476	—	—	2674	040	356	399	242	216	—	—	1213		
045	765	953	579	464	—	—	2760	045	347	432	262	211	—	—	1252		
050	824	917	550	494	—	—	2785	050	374	416	250	224	—	—	1263		
055	835	954	588	514	—	—	2892	055	379	433	267	233	—	—	1312		
060	837	955	589	517	—	—	2898	060	380	433	267	234	—	—	1314		
070	1126	1140	954	942	—	—	4161	070	511	517	433	427	—	—	1887		
080	1164	1206	1062	1025	—	—	4457	080	528	547	482	465	—	—	2022		
090	1126	1255	1108	994	—	—	4483	090	511	569	502	451	—	—	2033		
100	1215	982	1098	929	664	1059	5947	100	551	445	498	421	301	480	2697		
115	1240	1012	1178	1019	750	1140	6338	115	562	459	534	462	340	517	2875		
130	1506	1337	1577	901	696	1495	7512	130	683	606	715	409	316	678	3407		
150	1534	1373	1718	1009	804	1634	8072	150	696	623	779	458	365	741	3661		

AL/CU COIL, DUAL PUMP UNITS

30RAP SIZE	POUNDS							Total Weight	30RAP SIZE	KILOGRAMS							Total Weight
	A	B	C	D	E	F	A			B	C	D	E	F			
011	286	315	287	260	—	—	1147	011	130	143	130	118	—	—	520		
016	304	323	288	270	—	—	1185	016	138	147	130	123	—	—	537		
018	425	373	339	386	—	—	1522	018	193	169	154	175	—	—	691		
020	427	375	340	388	—	—	1530	020	194	170	154	176	—	—	694		
025	456	399	374	428	—	—	1657	025	207	181	170	194	—	—	751		
030	468	408	382	439	—	—	1697	030	212	185	173	199	—	—	770		
035	771	1048	678	499	—	—	2995	035	350	475	307	226	—	—	1358		
040	823	1015	651	528	—	—	3017	040	373	461	295	239	—	—	1368		
045	803	1085	699	517	—	—	3104	045	364	492	317	235	—	—	1408		
050	860	1051	670	548	—	—	3129	050	390	477	304	249	—	—	1419		
055	872	1087	708	568	—	—	3235	055	396	493	321	258	—	—	1467		
060	875	1087	709	570	—	—	3241	060	397	493	322	259	—	—	1470		
070	1201	1216	1018	1005	—	—	4441	070	545	552	462	456	—	—	2014		
080	1237	1282	1128	1089	—	—	4737	080	561	581	512	494	—	—	2149		
090	1197	1333	1177	1057	—	—	4763	090	543	605	534	479	—	—	2160		
100	1459	1023	1034	109	622	1004	6232	100	662	464	469	495	282	455	2827		
115	1483	1055	1113	1180	708	1085	6623	115	673	478	505	535	321	492	3004		
130	1744	1383	1565	1005	641	1458	7797	130	791	627	710	456	291	661	3536		
150	1771	1421	1706	1112	750	1597	8357	150	803	645	774	504	340	724	3790		

NOTES:

1. Mounting points are shown on page 18.

2. 30RAP chillers with Greenspeed® intelligence are not available on unit sizes 070-150.

UNIT WEIGHTS (cont)
CU/CU COIL, NO PUMP UNITS

30RAP SIZE	POUNDS						
	A	B	C	D	E	F	Total Weight
011	242	195	208	258	—	—	903
016	261	203	209	268	—	—	941
018	367	267	296	407	—	—	1337
020	369	269	298	409	—	—	1345
025	395	292	349	472	—	—	1508
030	407	302	358	482	—	—	1548
035	780	873	494	441	—	—	2588
040	841	833	466	470	—	—	2610
045	836	938	526	469	—	—	2769
050	904	894	495	501	—	—	2793
055	910	932	535	522	—	—	2900
060	913	933	536	525	—	—	2906
070	1179	1194	999	987	—	—	4359
080	1250	1294	1140	1100	—	—	4784
090	1216	1354	1196	1073	—	—	4839
100	992	1016	1389	829	808	1354	6388
115	1033	1060	1501	933	909	1463	6899
130	1319	1395	1867	898	900	1814	8193
150	1363	1445	2039	1021	1023	1981	8873

30RAP SIZE	KILOGRAMS						
	A	B	C	D	E	F	Total Weight
011	110	88	94	117	—	—	410
016	118	92	95	122	—	—	427
018	167	121	134	185	—	—	607
020	167	122	135	186	—	—	610
025	179	132	158	214	—	—	684
030	185	137	162	219	—	—	702
035	354	396	224	200	—	—	1174
040	381	378	211	213	—	—	1184
045	379	426	239	213	—	—	1256
050	410	405	224	227	—	—	1267
055	413	423	243	237	—	—	1315
060	414	423	243	238	—	—	1318
070	535	542	453	448	—	—	1977
080	567	587	517	499	—	—	2170
090	552	614	542	487	—	—	2195
100	450	461	630	376	366	614	2898
115	469	481	681	423	412	664	3129
130	598	633	847	407	408	823	3716
150	618	655	925	463	464	899	4025

CU/CU COIL, SINGLE PUMP UNITS

30RAP SIZE	POUNDS						
	A	B	C	D	E	F	Total Weight
011	262	257	270	276	—	—	1065
016	281	265	271	286	—	—	1103
018	397	320	350	433	—	—	1500
020	399	322	351	435	—	—	1508
025	426	345	403	497	—	—	1670
030	438	354	410	508	—	—	1711
035	809	1009	618	496	—	—	2932
040	867	971	589	526	—	—	2954
045	862	1074	652	523	—	—	3112
050	928	1033	620	556	—	—	3137
055	936	1071	660	577	—	—	3244
060	939	1071	661	579	—	—	3250
070	1288	1304	1091	1078	—	—	4761
080	1352	1401	1233	1191	—	—	5177
090	1307	1456	1285	1154	—	—	5203
100	1317	1090	1308	1030	773	1268	6787
115	1357	1135	1418	1135	873	1379	7298
130	1639	1474	1846	1035	832	1766	8592
150	1682	1525	2017	1158	955	1935	9272

30RAP SIZE	KILOGRAMS						
	A	B	C	D	E	F	Total Weight
011	119	117	123	125	—	—	483
016	127	120	123	130	—	—	501
018	180	145	159	196	—	—	680
020	181	146	159	197	—	—	684
025	193	156	183	225	—	—	758
030	199	161	186	230	—	—	776
035	367	458	280	225	—	—	1330
040	393	441	267	239	—	—	1340
045	391	487	296	237	—	—	1412
050	421	469	281	252	—	—	1423
055	425	486	299	262	—	—	1471
060	426	486	300	263	—	—	1474
070	584	591	495	489	—	—	2160
080	613	635	559	540	—	—	2348
090	593	660	583	524	—	—	2360
100	597	494	593	467	351	575	3078
115	615	515	643	515	396	626	3310
130	743	668	837	469	377	801	3897
150	763	692	915	525	433	878	4206

CU/CU COIL, DUAL PUMP UNITS

30RAP SIZE	POUNDS						
	A	B	C	D	E	F	Total Weight
011	306	337	307	278	—	—	1228
016	324	345	307	289	—	—	1266
018	464	407	370	421	—	—	1662
020	466	409	372	423	—	—	1670
025	504	441	414	473	—	—	1833
030	517	450	422	484	—	—	1873
035	843	1146	741	545	—	—	3275
040	900	1110	711	576	—	—	3297
045	894	1208	778	576	—	—	3456
050	957	1169	745	610	—	—	3481
055	967	1205	785	630	—	—	3587
060	970	1206	786	632	—	—	3593
070	1364	1381	1156	1141	—	—	5041
080	1425	1476	1300	1255	—	—	5457
090	1378	1534	1355	1216	—	—	5483
100	1558	1134	1246	1187	735	1211	7072
115	1597	1181	1356	1291	836	1323	7583
130	1875	1523	1834	1137	778	1730	8877
150	1917	1575	2004	1260	902	1899	9557

30RAP SIZE	KILOGRAMS						
	A	B	C	D	E	F	Total Weight
011	139	153	139	126	—	—	557
016	147	157	139	131	—	—	574
018	210	185	168	191	—	—	754
020	211	186	169	192	—	—	758
025	229	200	188	215	—	—	831
030	234	204	191	220	—	—	850
035	382	520	336	247	—	—	1485
040	408	503	323	261	—	—	1495
045	406	548	353	261	—	—	1568
050	434	530	338	277	—	—	1579
055	439	547	356	286	—	—	1627
060	440	547	356	287	—	—	1630
070	618	626	524	518	—	—	2287
080	647	670	590	569	—	—	2475
090	625	696	614	552	—	—	2487
100	707	514	565	539	333	549	3208
115	724	536	615	586	379	600	3440
130	851	691	832	516	353	785	4026
150	870	715	909	571	406	861	4335

NOTES:

1. Mounting points are shown on page 18.

2. 30RAP chillers with Greenspeed® intelligence are not available on unit sizes 070-150.

UNIT WEIGHTS (cont) RTPF AL/CU COIL, NO PUMP UNITS

30RAP SIZE	WEIGHT AT MOUNTING POINTS (POUNDS)						
	A	B	C	D	E	F	Total Weight
070	1017	1030	862	851	—	—	3759
080	1062	1100	968	935	—	—	4064
090	1035	1153	1018	914	—	—	4119
100	887	911	1179	724	702	1145	5548
115	913	940	1261	813	789	1223	5939
130	1183	1261	1596	763	765	1545	7113
150	1213	1296	1739	871	873	1682	7673

30RAP SIZE	WEIGHT AT MOUNTING POINTS (KILOGRAMS)						
	A	B	C	D	E	F	Total Weight
070	461	467	391	386	—	—	1705
080	482	499	439	424	—	—	1843
090	469	523	462	414	—	—	1868
100	402	413	535	328	319	519	2517
115	414	427	572	369	358	555	2694
130	537	572	724	346	347	701	3226
150	550	588	789	395	396	763	3480

RTPF AL/CU COIL, SINGLE PUMP UNITS

30RAP SIZE	WEIGHT AT MOUNTING POINTS (POUNDS)						
	A	B	C	D	E	F	Total Weight
070	1126	1140	954	942	—	—	4161
080	1164	1206	1062	1025	—	—	4457
090	1126	1255	1108	994	—	—	4483
100	1215	982	1098	929	664	1059	5947
115	1240	1012	1178	1019	750	1140	6338
130	1506	1337	1577	901	696	1495	7512
150	1534	1373	1718	1009	804	1634	8072

30RAP SIZE	WEIGHT AT MOUNTING POINTS (KILOGRAMS)						
	A	B	C	D	E	F	Total Weight
070	511	517	433	427	—	—	1887
080	528	547	482	465	—	—	2022
090	511	569	502	451	—	—	2033
100	551	445	498	421	301	480	2697
115	562	459	534	462	340	517	2875
130	683	606	715	409	316	678	3407
150	696	623	779	458	365	741	3661

RTPF AL/CU COIL, DUAL PUMP UNITS

30RAP SIZE	WEIGHT AT MOUNTING POINTS (POUNDS)						
	A	B	C	D	E	F	Total Weight
070	1201	1216	1018	1005	—	—	4441
080	1237	1282	1128	1089	—	—	4737
090	1197	1333	1177	1057	—	—	4763
100	1459	1023	1034	109	622	1004	6232
115	1483	1055	1113	1180	708	1085	6623
130	1744	1383	1565	1005	641	1458	7797
150	1771	1421	1706	1112	750	1597	8357

30RAP SIZE	WEIGHT AT MOUNTING POINTS (KILOGRAMS)						
	A	B	C	D	E	F	Total Weight
070	545	552	462	456	—	—	2014
080	561	581	512	494	—	—	2149
090	543	605	534	479	—	—	2160
100	662	464	469	495	282	455	2827
115	673	478	505	535	321	492	3004
130	791	627	710	456	291	661	3536
150	803	645	774	504	340	724	3790

NOTES:

1. RTPF AL/CU coils are available for unit sizes 070-150 only.
2. Mounting points are shown on page 18.
3. 30RAP chillers with Greenspeed® intelligence are not available on unit sizes 070-150.

UNIT WEIGHTS (cont)
RTPF CU/CU COIL, NO PUMP UNITS

30RAP SIZE	WEIGHT AT MOUNTING POINTS (POUNDS)						
	A	B	C	D	E	F	Total Weight
070	1179	1194	999	987	—	—	4359
080	1250	1294	1140	1100	—	—	4784
090	1216	1354	1196	1073	—	—	4839
100	992	1016	1389	829	808	1354	6388
115	1033	1060	1501	933	909	1463	6899
130	1319	1395	1867	898	900	1814	8193
150	1363	1445	2039	1021	1023	1981	8873

30RAP SIZE	WEIGHT AT MOUNTING POINTS (KILOGRAMS)						
	A	B	C	D	E	F	Total Weight
070	535	542	453	448	—	—	1977
080	567	587	517	499	—	—	2170
090	552	614	542	487	—	—	2195
100	450	461	630	376	366	614	2898
115	469	481	681	423	412	664	3129
130	598	633	847	407	408	823	3716
150	618	655	925	463	464	899	4025

RTPF CU/CU COIL, SINGLE PUMP UNITS

30RAP SIZE	WEIGHT AT MOUNTING POINTS (POUNDS)						
	A	B	C	D	E	F	Total Weight
070	1288	1304	1091	1078	—	—	4761
080	1352	1401	1233	1191	—	—	5177
090	1307	1456	1285	1154	—	—	5203
100	1317	1090	1308	1030	773	1268	6787
115	1357	1135	1418	1135	873	1379	7298
130	1639	1474	1846	1035	832	1766	8592
150	1682	1525	2017	1158	955	1935	9272

30RAP SIZE	WEIGHT AT MOUNTING POINTS (KILOGRAMS)						
	A	B	C	D	E	F	Total Weight
070	584	591	495	489	—	—	2160
080	613	635	559	540	—	—	2348
090	593	660	583	524	—	—	2360
100	597	494	593	467	351	575	3078
115	615	515	643	515	396	626	3310
130	743	668	837	469	377	801	3897
150	763	692	915	525	433	878	4206

RTPF CU/CU COIL, DUAL PUMP UNITS

30RAP SIZE	WEIGHT AT MOUNTING POINTS (POUNDS)						
	A	B	C	D	E	F	Total Weight
070	1364	1381	1156	1141	—	—	5041
080	1425	1476	1300	1255	—	—	5457
090	1378	1534	1355	1216	—	—	5483
100	1558	1134	1246	1187	735	1211	7072
115	1597	1181	1356	1291	836	1323	7583
130	1875	1523	1834	1137	778	1730	8877
150	1917	1575	2004	1260	902	1899	9557

30RAP SIZE	WEIGHT AT MOUNTING POINTS (KILOGRAMS)						
	A	B	C	D	E	F	Total Weight
070	618	626	524	518	—	—	2287
080	647	670	590	569	—	—	2475
090	625	696	614	552	—	—	2487
100	707	514	565	539	333	549	3208
115	724	536	615	586	379	600	3440
130	851	691	832	516	353	785	4026
150	870	715	909	571	406	861	4335

NOTES:

1. RTPF CU/CU coils are available for unit sizes 070-150 only.
2. Mounting points are shown on page 18.
3. 30RAP chillers with Greenspeed® intelligence are not available on unit sizes 070-150.

MOUNTING POINTS

30RAP011-030 UNITS*

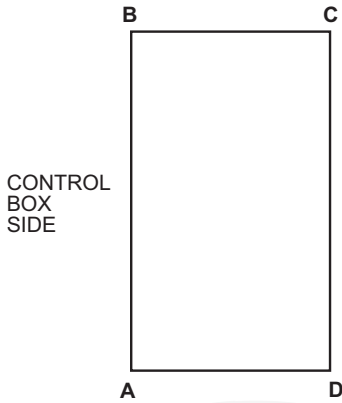

30RAP035-090 UNITS*

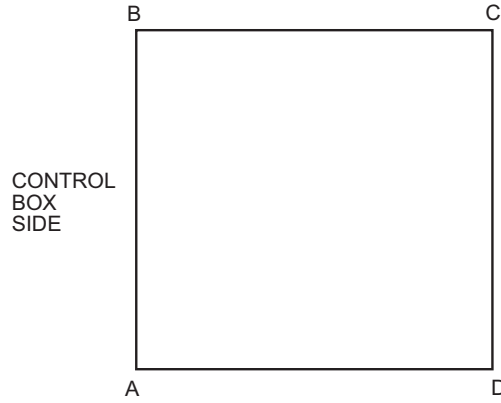

*30RAP chillers with Greenspeed® intelligence are not available on unit sizes 070-150.

NOTE: When the accessory storage tank is employed (sizes 011-060 only), the value for total weight increases (to be added to the weights shown in the mounting weight tables) by 1673 lb (759 kg) on 30RAP011 and 016, by 2193 lb (995 kg) on 30RAP018-030, and by 4361 lb (1978 kg) on 30RAP035-060. Even with the storage tank, all 30RAP011-060 chillers require only 4-point support.

30RAP100-150 UNITS*

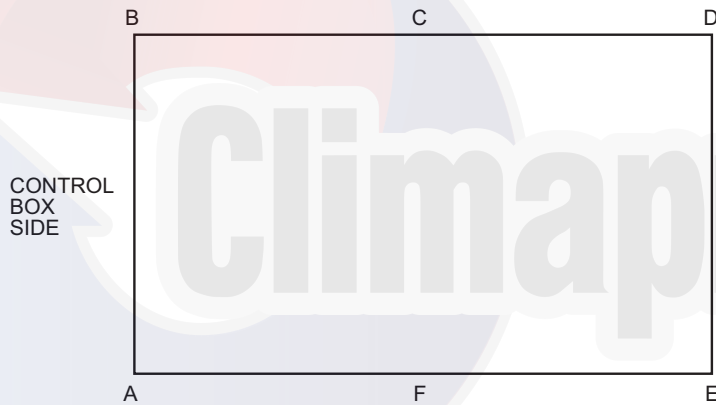

Climaproyectos.com

Options and accessories



ITEM	FACTORY-INSTALLED OPTION	FIELD-INSTALLED ACCESSORY
Condenser Coil and Sound Options		
MCHX, E-Coated	X	
Aluminum Fins/Copper Tube	X	
Aluminum Fins/Copper Tube, Pre-Coated	X	
Aluminum Fins/Copper Tube, E-Coat	X	
Copper Fins/Copper Tube	X	
Copper Fins/Copper Tube, E-Coat	X	
Low Sound Compressor Blankets		X
Value Sound Fans	X	
Ultra-Low Sound	X	
Controls/Communication Options		
BACnet Communication	X	
BACnet/Modbus Translator Control		X
Chillervisor System Manager III Multi-Unit Control		X
Energy Management Module (EMM)	X	X
LON (Local Operating Network) Translator Control		X
Navigator™ Display		X
Remote Enhanced Display		X
Touch Pilot™ Display		X
Cooler Options		
Freeze Protection — Cooler Heaters	X	
Remote Cooler Kit		X
Electrical Options		
Unit-Mounted Main Disconnect, Non-Fused (not available with dual point power or 208/230 volt sizes 100-150)	X	
GFI Convenience Outlet (115 v) (60 Hz only)	X	X
High SCCR (Short Circuit Current Rating) (includes non-fused disconnect) (not available with dual point power or 208/230 volt sizes 100-150)	X	
Hydronics Option (60 Hz only)		
Hydronic Pump Package	X	
Chilled Water Storage Tank (available on sizes 011-060)		X
Variable Frequency Drive (VFD) Pump (available on sizes 070-150)	X	
Refrigeration Circuit Options		
High-Efficiency Variable Condenser Fans (not available on unit sizes 070-150)	X	
Compressor Suction Service Valves (available on sizes 070-150)	X	
Low Ambient Temperature Head Pressure Control (not available with high-efficiency variable condenser fans)	X	X
Hot Gas Bypass (not available as a factory option on sizes 011, 016)	X	X
Digital Compressor (available on sizes 011-090)	X	
Security/Packaging Options		
Security Grilles/Hail Guards	X	X
Vibration Isolation		X
Wind Baffles		X

LEGEND

E-Coated — Epoxy Coating Applied to Entire Coil Assembly
EMM — Energy Management Module
LON — Local Operating Network
MCHX — Microchannel Heat Exchanger

NOTES:

1. Std SCCR (short circuit current rating) (5 kA).
2. High SCCR 460-v, 380-v, 380/415-v, and 208/230-v (65 kA) or 575-v (25 kA).

Factory-installed options

Condenser coil options are available to match coil construction to the site conditions for the best durability. Refer to the Condenser Coil Corrosion Protection Options table on page 21 or the appropriate selection guide for more information.

Value sound fans provide a metal, propeller-type fan system which is cost-effective when compared to the low-sound AeroAcoustic™ fan system. This factory-installed fan option is compatible with the low ambient head pressure control option.

Ultra-low sound provides a combination of low sound AeroAcoustic™ fans with sound blankets.

Digital compressor control allows incremental unloading for a closer match to building load. This option is not

available on sizes 100-150, or on any application with a leaving fluid temperature below 35°F (2°C).

High-efficiency variable condenser fans control the speed of all fans for improvement in part load efficiency and sound levels. Additionally, high-efficiency variable condenser fans maintain head pressure control down to -20°F (-29°C) ambient temperature with the use of glycol and wind baffles. Varying the speed of all fans on a circuit to a prescribed speed provides accurate head pressure control to the most efficient point while achieving optimum usage of the coils to accomplish excellent part load efficiency. These fans are the key component of the 30RAP chiller with Greenspeed® intelligence. This option is not available on unit sizes 070-150.

High short circuit current rating (SCCR) provides a short circuit current rating protection for the unit up to 65 kA on 460-v, 380-v, 380/415-v, and 208/230-v units or 25 kA on 575-v units. The high SCCR option includes a non-fused disconnect for all unit sizes. The high SCCR option is not available with dual point power at any size or with 208/230-v units in the size range of 30RAP100-150. The standard SCCR rating, regardless of voltage, is 5 kA.

Low ambient temperature head pressure control permits the operation of 30RAP018-150 units to -20°F (-29°C outdoor ambient temperature). This option requires field-installed wind baffles, and is also available as a field-installed accessory. This option is not available on unit sizes 011 and 016 because units in this size range are automatically provided with low-ambient capability. This option is not available on any unit that employs high-efficiency variable condenser fans, because units with such fans already have low-ambient capability.

Non-fused disconnect includes factory-installed non-fused disconnect capability for power and control located at the unit. This is not available on dual point power at any size, or on any 208/230-volt chiller in the 100-150 size range. This option is included with the high SCCR option.

Energy management module (EMM) provides energy management capabilities to minimize chiller energy consumption. Several features are provided with this module including leaving fluid temperature reset, cooling set point reset or demand limit control from a 4 to 20 mA signal, 2-point demand limit control (from 0 to 100%) activated by a remote contact closure, and discrete input for “Ice Done” indication for ice storage system interface. The EMM is also available as an accessory.

Freeze protection with cooler heaters provides protection from cooler freeze-up to -20°F (-29°C) on 60 Hz units and down to -15°F (-26°C) on 50 Hz units.

GFI convenience outlet is a factory-installed convenience outlet that includes 4-amp GFI (ground fault interrupter) receptacle with independent fuse protection. Convenience outlet is 115-v female receptacle, and is only available for 60 Hz applications. This option is also available as an accessory.

Compressor suction service valve provides additional isolation of the compressor from the cooler vessel for service. This option is only available on sizes 070-150.

Hydronic pump package (60 Hz only) option adds circulating pumps, complete with controls, contactor, VFD compatible motors, and insulated expansion tank (expansion tank available on sizes 011-060 only). Available in single or dual (lead/lag controlled) cooler pump versions, with total dynamic head external to the chiller from approximately 15 to 160 ft (4.6 to 48.8 m). A VFD option is available on sizes 070-150.

Hot gas bypass option allows additional capacity reduction for unit operation down below the minimum standard step of capacity. This option is not available on units with the digital compressor option, on size 011 and 016 units, or on any application with a leaving fluid temperature below 35°F (2°C). This option is also available as an accessory on all 30RAP units without digital compressors.

Security grilles/hail guards consist of louvered, sheet metal panels which securely fasten to the chiller and provide condenser coil protection against hail and physical damage. This option directly covers the coil(s) on sizes

011-060. On sizes 070 and larger, the louvered panels are only on the ends of the chiller, with a wire guard entirely covering the sides of the chiller. This option is also available as an accessory.

BACnet communication option — Provides pre-programmed factory-installed communication capability with a BACnet MS/TP network. Allows integration with i-Vu® Open control system or a third-party BACnet building automation system. No field programming is required.

Field-installed accessories

BACnet/Modbus¹ translator control provides an interface between the unit and a BACnet Local Area Network (LAN, i.e., MS/TP EIA-485). Field programming is required.

Chillervisor System Manager III multi-unit control accessory allows sequencing between two and eight chillers in parallel. Pump control is also provided.

Energy management module provides energy management capabilities to minimize chiller energy consumption. Several features are provided with this module including leaving fluid temperature reset, cooling set point reset or demand limit control from a 4 to 20 mA signal, 2-point demand limit control (from 0 to 100%) activated by a remote contact closure, and discrete input for “Ice Done” indication for ice storage system interface. The EMM is also available as a factory-installed option.

LON (local operating network) translator control provides an interface between the unit and a local operating network (i.e., LonWorks² FT-10A ANSI/EIA-709.1). Field programming is required.

Navigator™ display module provides a portable, hand held display module for convenient access to unit status, operation, configuration and troubleshooting diagnostics capability. The 4-line, 80-character LCD (liquid crystal display) display provides clear language information in English, French, Spanish or Portuguese. The weatherproof enclosure and industrial grade extension cord make the Navigator module ideally suited for outdoor applications. Magnets located on the back of the module allow attachment of any sheet metal component for hands-free operation.

Remote enhanced display accessory kit contains a remotely mounted 40-character per line, 16-line display panel for unit diagnostics.

Touch Pilot™ display is a cost-effective, touch-screen, remote-mount device that can be used in lieu of the remote enhanced display.

Low ambient temperature head pressure control permits the operation of 30RAP018-150 units to -20°F (-29°C outdoor ambient temperature). This accessory requires field-installed wind baffles, and is also available as a factory-installed option. This accessory is not available on sizes 011 and 016 because units in this size range are automatically provided with low-ambient capability. This accessory is not available on any unit that employs high-efficiency variable condenser fans; units with such fans already have low-ambient capability.

Chilled water storage tank provides a minimum of 4 gallons per ton loop storage capacity. Includes insulated

1. Modbus is a registered trademark of Schneider Electric.
2. LonWorks is a registered trademark of Echelon Corporation.

steel shell tank, Victaulic pipe connections, electric tank heaters (with thermostat to prevent overheating), electric cables, vent, drain, and enclosure to allow tank to be installed under the chiller to protect to -20°F (-29°C). The power supply for the storage tank is obtained from the chiller, so no separate power source is required for this accessory. This is available with sizes 011-060 only.

Vibration isolation consists of field-installed $\frac{1}{4}$ -in. (0.64 cm) neoprene isolator pads (24-in. x 3-in.) (61.0 cm x 7.6 cm) that reduce vibration transmission from the compressor through the floor and into the conditioned space.

Low sound compressor blankets reduce unit sound levels by providing an acoustic blanket on each compressor.

Hot gas bypass accessory allows additional capacity reduction for unit operation below the minimum standard step of capacity. This accessory is not available on units that have the digital compressor option or any application with a leaving fluid temperature below 35°F (2°C). This field-installed accessory is also available as a factory-installed option, but the factory option is not available with digital compressors or unit sizes 011 and 016.

Remote cooler kit provides the additional hardware required to remotely mount the cooler from the unit. There are limits to total separation of the unit to the cooler as well as vertical separation limits, and these are delineated in the accessory installation instructions. Never bury refrigerant piping on these or any other applications.

GFI convenience outlet is a field-installed convenience outlet that includes a 4-amp GFI (ground fault interrupter) receptacle with independent fuse protection. The convenience outlet is a 115-v female receptacle, and is only available for 60 Hz applications. The GFI convenience outlet is also available as a factory-installed option.

Security grilles/hail guards consist of louvered, sheet metal panels which securely fasten to the chiller and provide condenser coil protection against hail and physical damage. This accessory directly covers the coil(s) on sizes 011-060. On sizes 070 and larger, the louvered panels are only on the ends of the chiller, with a wire guard entirely covering the sides of the chiller. Security grilles/hail guards are also available as a factory-installed option.

Wind baffles facilitate operation down to -20°F (-29°C) when used in conjunction with either low ambient temperature head pressure control or high-efficiency variable condenser fans.

CONDENSER COIL CORROSION PROTECTION OPTIONS

ENVIRO-SHIELD™ OPTION*	ENVIRONMENT				
	Standard	Mild Coastal	Severe Coastal	Industrial	Combined Industrial/Coastal
Novation® Heat Exchanger (Standard)	See NACO Packaged Chiller Builder				
Novation Heat Exchanger, E-coat	See NACO Packaged Chiller Builder				
AL Fins	X				
CU Fins		X			
AL Fins, E-coat			X	X	X
CU Fins, E-coat			X		
AL Fins, Pre-coated		X			

LEGEND

AL — Aluminum
 CU — Copper
 NACO — North American Commercial Operations

* See NACO Packaged Chiller Builder for details. Additional corrosion protection is available. For Novation or round tube/plate fin (RTPF) heat exchangers, see selection guide "Environmental Corrosion Protection" (Publication 04-581061-01).

Base unit dimensions — 30RAP011, 016

30RAP011, 016 WITH GREENSPEED® INTELLIGENCE

UNIT	CENTER OF GRAVITY		UNIT HEIGHT		WATER CONNECTION CYCLAMIC IPS CARBON STEEL
	X	Y	H (STANDARD)	H (VALUE SOUND)	
STANDARD	19.40 [493]	34.80 [884]	66.5 [1689]	61.0 [1549]	2"
30RA016	19.10 [485]	34.30 [871]	66.5 [1689]	61.0 [1549]	2"

NOTES:

- DO NOT CAP OR OTHERWISE OBSTRUCT THE LIQUID LINE TEMPERATURE RELIEF.
- Ø7/8 [22.41] PILOT HOLE PROVIDED FOR LOCATING FIELD POWER WIRING. ACTUAL HOLE REQUIRED DEPENDS ON FIELD WIRE SIZING.
- Ø0.437 [11.10] HOLE USED FOR MOUNTING UNIT.
- UNIT MUST HAVE CLEARANCES AS FOLLOWS:
TOP - DO NOT RESTRICT.
COIL SIDE - 42 [1067] FROM SOLID SURFACE.
PANEL SIDE - 48 [1219] PER NEC.
- SEE TABLE COLUMN H: DIMENSION FOR STANDARD FAN OR VALUE SOUND FAN OPTION.
- CARRIER DOES NOT RECOMMEND INSTALLATION IN A PIT.
- UNIT CAN BE HANDLED USING THE FORK TRUCK LIFT POCKETS.
- WATER CONNECTIONS RECESSED, 2-3/8 INCHES INSIDE UNIT.
ALL WATER DRAIN AND VENTING HOLES ARE 3/4" NPT.

DIMENSIONS IN () ARE IN MILLIMETERS

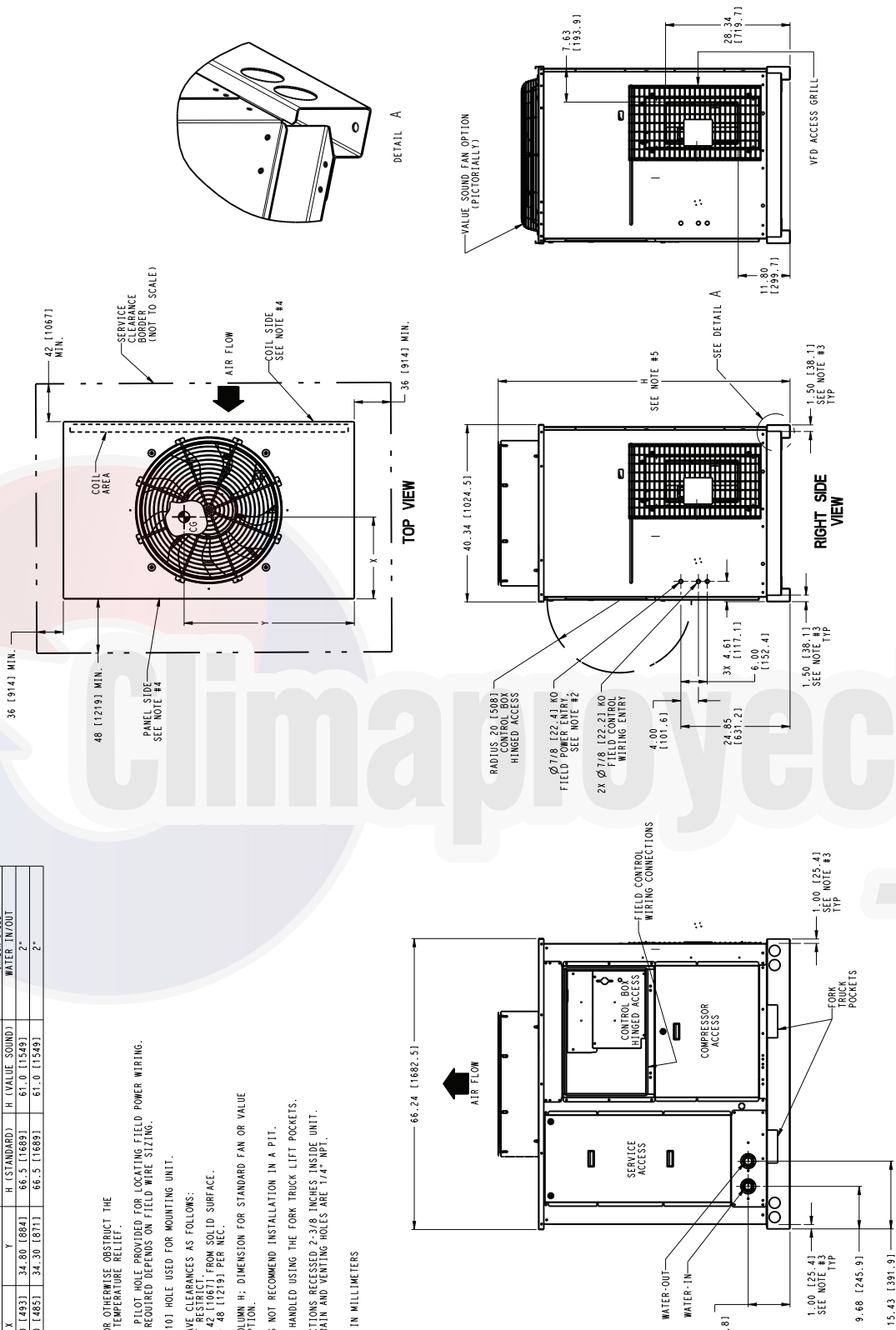

ITC CLASSIFICATION	SHEET	DATE	SUPERCEDES	DESCRIPTION	REV
U.S. ECCN:EAR99	1 OF 1	09/07/18	A	38RAP011-016 UNIT ASSY	B
				30RA55561	

Base unit dimensions — 30RAP018-030 (cont)



30RAP018-030 WITH GREENSPEED® INTELLIGENCE

UNIT	CENTER OF GRAVITY		UNIT HEIGHT	POWER ENTRY	WATER CONNECTION	
	X	Y			WATER IN	WATER OUT
30RA018	19.30 [490]	38.77 [985]	H (STANDARD)	P	WATER IN	WATER OUT
30RA020	19.30 [490]	38.79 [985]	66.5 [1689]	24.9 [631]	2"	2"
30RA025	19.60 [498]	38.93 [989]	67.0 [1727]	24.9 [631]	2"	2"
30RA030	19.60 [498]	38.98 [990]	73.0 [1854]	36.9 [936]	2"	2"

NOTES:

- DO NOT CAP OR OTHERWISE OBSTRUCT THE LIQUID LINE TEMPERATURE RELIEF.
- Ø7/8 [22.4] PILOT HOLE PROVIDED FOR LOCATING FIELD POWER WIRING. ACTUAL HOLE REQUIRED DEPENDS ON FIELD WIRE SIZING.
- Ø0.437 [11.101] HOLE USED FOR MOUNTING UNIT.
- UNIT MUST HAVE CLEARANCES AS FOLLOWS:
TOP - DO NOT RESTRICT.
COIL SIDE - 42 [1067] FROM SOLID SURFACE.
PANEL SIDE - 48 [1219] PER NEC.
- SEE TABLE COLUMN H; DIMENSION FOR STANDARD FAN OR VALUE SOUND FAN OPTION.
- CARRIER DOES NOT RECOMMEND INSTALLATION IN A PIT.
- UNIT CAN BE HANDLED USING THE FORK TRUCK LIFT POCKETS.
- WATER CONNECTIONS RECESSED 2 INCHES INSIDE UNIT.
ALL WATER DRAIN AND VENTING HOLES ARE 1/4" NPT.

DIMENSIONS IN () ARE IN MILLIMETERS

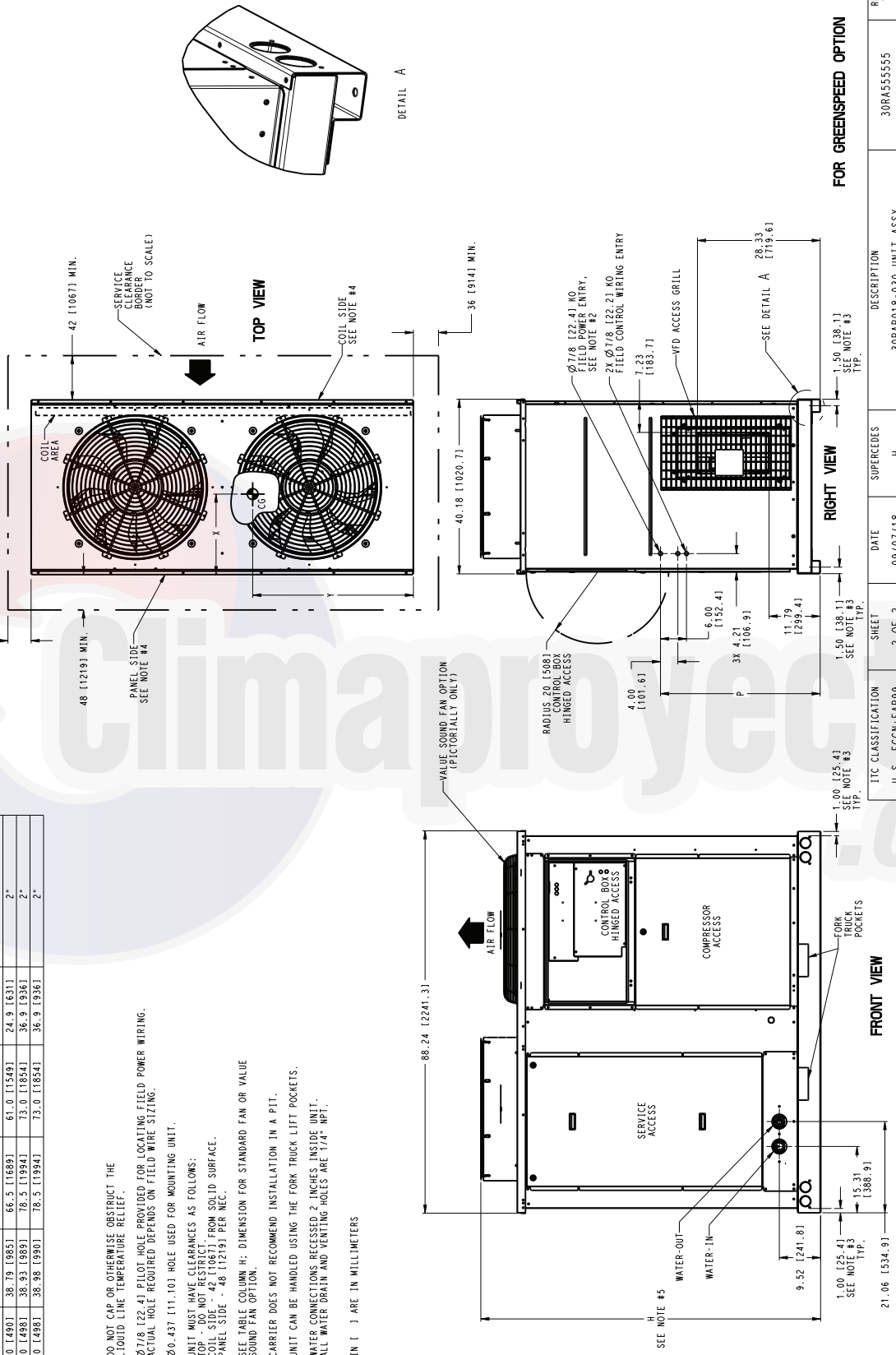

DETAIL A

FOR GREENSPEED OPTION

REV	DESCRIPTION	DATE	SHEET	U.S. ECCN	DATE	SUPERCEDES	DESCRIPTION	REV
I	30RAP018-030 UNIT ASSY	09/07/18	2 OF 2	ECCN:EAR99	09/07/18	H	30RAP018-030 UNIT ASSY	I

Base unit dimensions — 30RAP035-060



30RAP035-060 WITH FIXED SPEED FANS

UNIT	CENTER OF GRAVITY		UNIT HEIGHT		WATER CONNECTION VERTICAL DIS. CARBON STEEL	
	X	Y	H (STANDARD)	H (VALUE SOUND)	WATER IN/OUT	
30RA035	36.45 [926]	46.08 [1170]	66.5 [1689]	61.0 [1549]	2-1/2"	
30RA040	36.24 [921]	44.03 [1118]	66.5 [1689]	61.0 [1549]	2-1/2"	
30RA045	36.24 [921]	46.15 [1172]	78.5 [1994]	73.0 [1854]	2-1/2"	
30RA050	36.00 [914]	44.00 [1118]	78.5 [1994]	73.0 [1854]	2-1/2"	
30RA055	36.48 [927]	44.60 [1133]	78.5 [1994]	73.0 [1854]	2-1/2"	
30RA060	36.50 [927]	44.56 [1132]	78.5 [1994]	73.0 [1854]	2-1/2"	

NOTES:

- DO NOT CAP OR OTHERWISE OBSTRUCT THE LIQUID LINE TEMPERATURE RELIEF.
- Ø7/8 (22.4) PILOT HOLE PROVIDED FOR LOCATING FIELD POWER WIRING. ACTUAL HOLE REQUIRED DEPENDS ON FIELD WIRE SIZING.
- Ø0.437 (11.10) HOLE USED FOR MOUNTING UNIT.
- UNIT MUST HAVE CLEARANCES AS FOLLOWS:
 1. TOP: DO NOT RESTRICT FROM SOLID SURFACE.
 2. COIL SIDE: 48 (1219) PER NEC.
 3. PANEL SIDE: 48 (1219) PER NEC.
- SEE TABLE COLUMN H: DIMENSION FOR STANDARD FAN OR VALUE SOUND FAN OPTION.
- CARRIER DOES NOT RECOMMEND INSTALLATION IN A PIT.
- UNIT CAN BE HANDLED USING THE FORK TRUCK LIFT POCKETS (MINIMUM OF 60" FORK LENGTH).
- WATER CONNECTIONS RECESSED 2-5/8 INCHES INSIDE UNIT. ALL WATER DRAIN AND VENTING HOLES ARE 1/4" NPT.

DIMENSIONS IN [] ARE IN MILLIMETERS

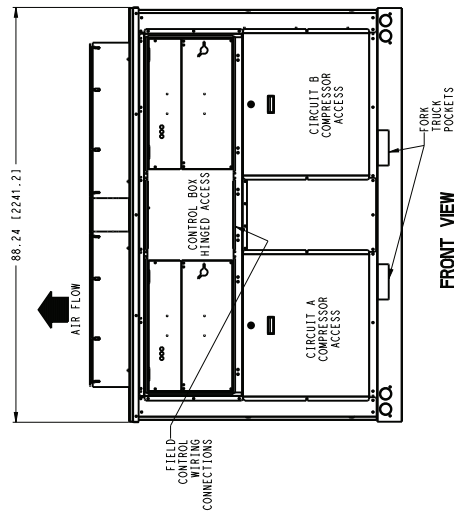
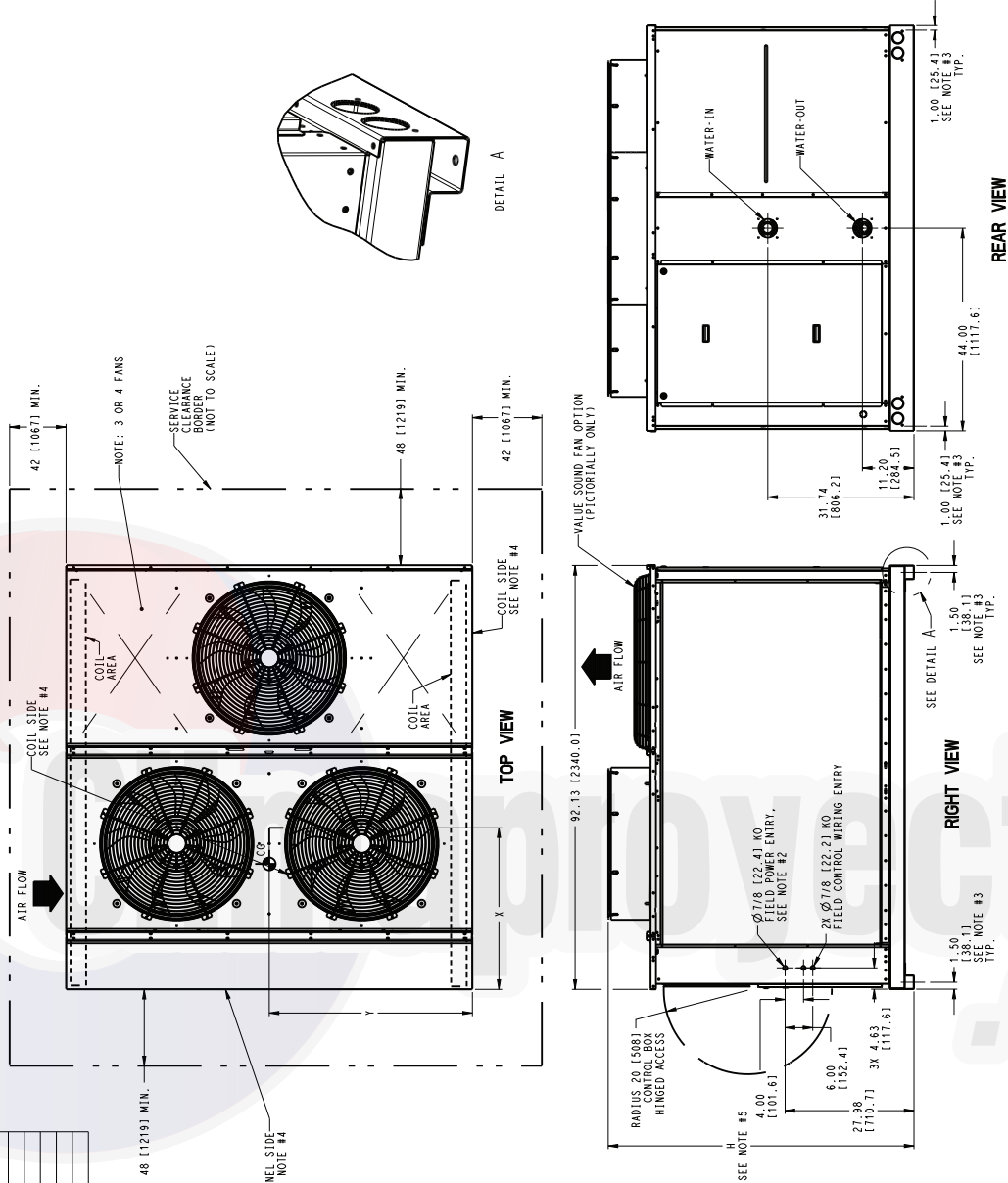

FOR LOW AMBIENT OPTION

DATE	09/07/15	SUPPLEMENT	6	REV	H
30RAP035-060 UNIT ASSY			30RA55556		

Base unit dimensions — 30RAP035-060 (cont)



30RAP035-060 WITH GREENSPEED® INTELLIGENCE

UNIT	CENTER OF GRAVITY		UNIT HEIGHT		WATER CONNECTION	
	X	Y	H (STANDARD)	H (VALUE SOUND)	VACUUM UPS CARBON STEEL	WATER IN/OUT
30RA035	36.45 [926]	46.08 [1170]	66.5 [1689]	61.0 [1549]	2-1/2"	2-1/2"
30RA040	36.24 [921]	44.03 [1118]	66.5 [1689]	61.0 [1549]	2-1/2"	2-1/2"
30RA045	36.24 [921]	46.15 [1172]	78.5 [1994]	73.0 [1854]	2-1/2"	2-1/2"
30RA050	36.00 [914]	44.00 [1118]	78.5 [1994]	73.0 [1854]	2-1/2"	2-1/2"
30RA055	36.48 [927]	44.60 [1133]	78.5 [1994]	73.0 [1854]	2-1/2"	2-1/2"
30RA060	36.50 [927]	44.56 [1132]	78.5 [1994]	73.0 [1854]	2-1/2"	2-1/2"

NOTES:

- DO NOT CAP OR OTHERWISE OBSTRUCT THE LIQUID LINE TEMPERATURE RELIEF.
- Ø7/8 (22.4) PILOT HOLE PROVIDED FOR LOCATING FIELD POWER WIRING. ACTUAL HOLE REQUIRED DEPENDS ON FIELD WIRE SIZING.
- Ø0.437 (11.1) HOLE USED FOR MOUNTING UNIT.
- UNIT MUST HAVE CLEARANCES AS FOLLOWS:
 COIL SIDE - 42 (1067) FROM SOLID SURFACE.
 PANEL SIDE - 48 (1219) PER NEC.
- SEE TABLE COLUMN H; DIMENSION FOR STANDARD FAN OR VALUE SOUND FAN OPTION.
- CARRIER DOES NOT RECOMMEND INSTALLATION IN A PIT.
- UNIT CAN BE HANDLED USING THE FORK TRUCK LIFT POCKETS (MINIMUM OF 60" FORK LENGTH).
- WATER CONNECTIONS RECESSED 2-5/8 INCHES INSIDE UNIT. ALL WATER DRAIN AND VENTING HOLES ARE 1/4" NPT.

DIMENSIONS IN [] ARE IN MILLIMETERS

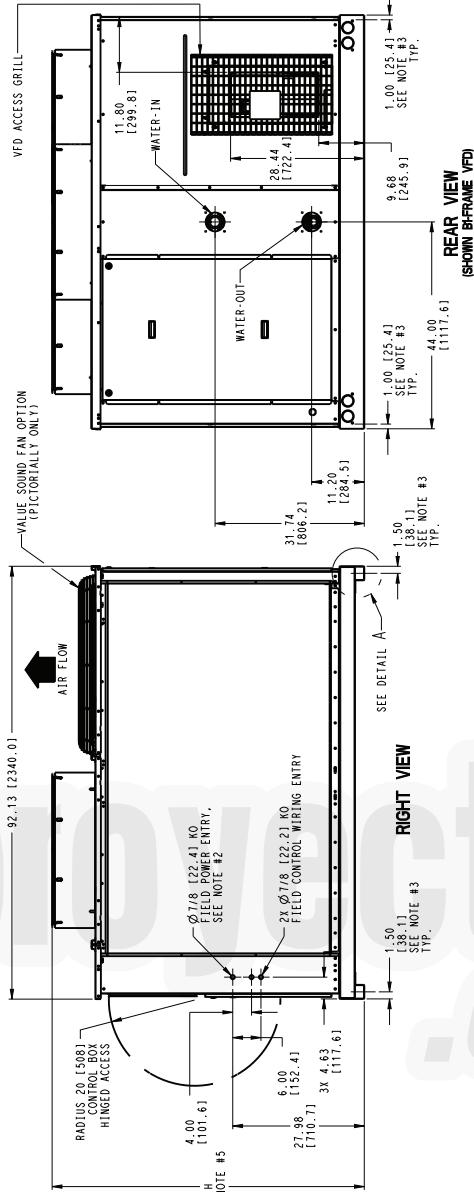
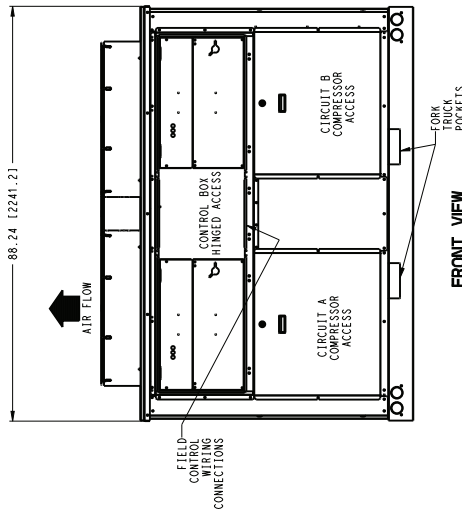
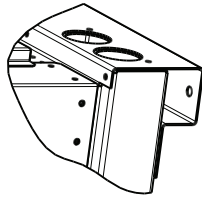
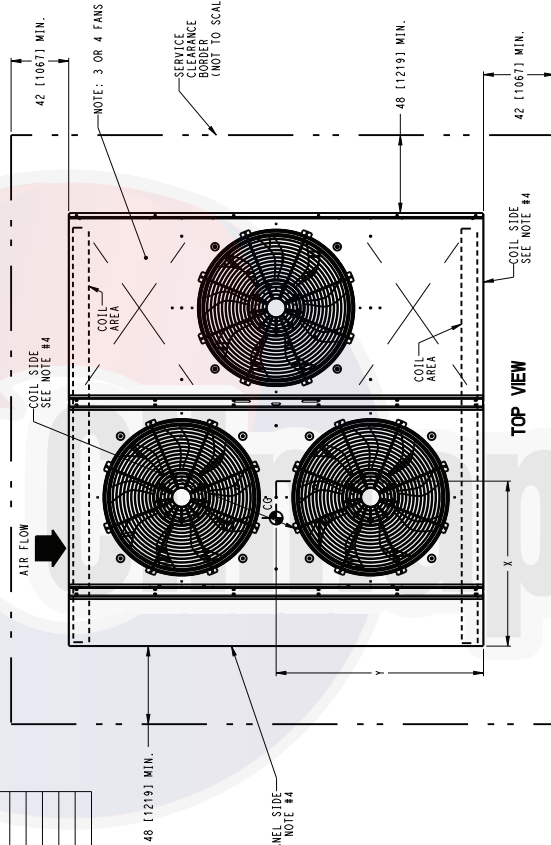

FOR GREENSPEED OPTION

DATE	09/07/15	DATE	09/07/15
SUPERSEDES	G	SUPERSEDES	G
30RAP035-060 UNIT ASSY		30RA55556	
REV	H	REV	H

Base unit dimensions — 30RAP070-090



30RAP070-090

NOTES: 1. UNIT MUST HAVE CLEARANCES AS FOLLOWS:

- TOP: DO NOT RESTRICT
- SIDES AND END: 6" FROM SOLID SURFACE. FOR AIRFLOW
- FIELD PUMP: REQUIRED FOR COIL SERVICE AREA. BOTTOM OF VOLUME FOR DRAINING.
- TEMPERATURE RELIEF DEVICES LOCATED ON SUCTION LINE, LIQUID LINE AND FILTER DRIER OF EACH CIRCUIT AND HAVE 1/4" FLARE CONNECTION.
- TWO Ø7/8(22.41) PILET HOLES PROVIDED FOR LOCATING FIELD POWER WIRING.
- FIELD PUMP: REQUIRED FOR COIL SERVICE AREA. BOTTOM OF VOLUME FOR DRAINING.
- DIMENSIONS ARE IN INCHES. DIMENSIONS IN [] ARE IN MILLIMETERS.
- VITALLIC CONNECTION SIZING INFORMATION IS CONSISTENT WITH IPS CARBON STEEL PIPING.

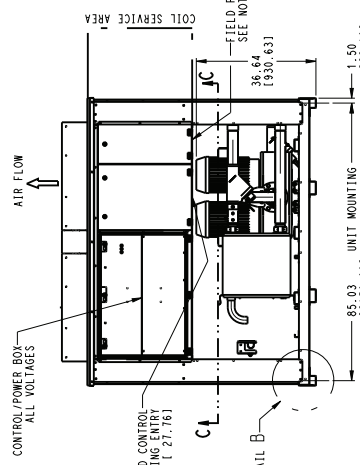
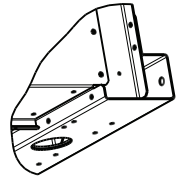
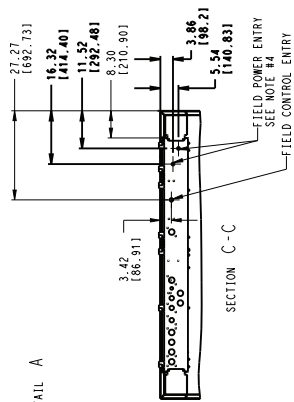
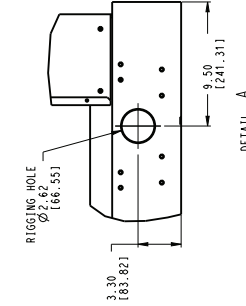
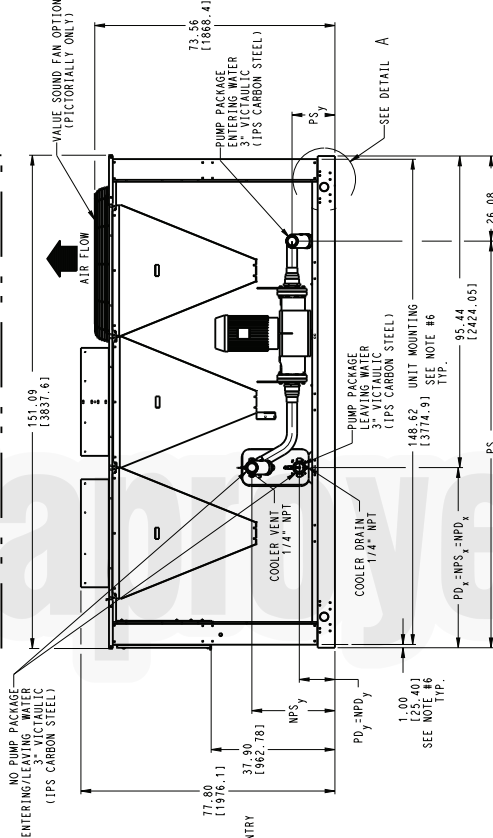
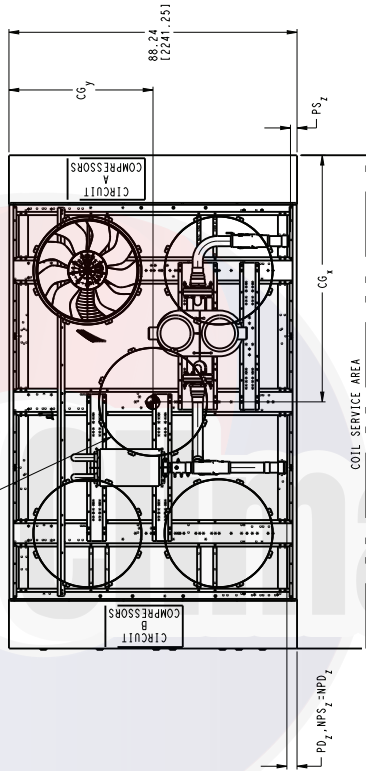

WEIGHT (MAX)	WEIGHT (MAX)	WEIGHT (MAX)	WEIGHT (MAX)	WEIGHT (MAX)	WEIGHT (MAX)	PUMP SUCTION (PS)		PUMP DISCHARGE (PD)		NO PUMP SUCTION (NPS)		NO PUMP DISCHARGE (NPD)		
						Y	Z	Y	Z	Y	Z	Y	Z	
30RAP-070	3556/1522	3991/1810	4340/1968	4305/1952	4940/2240	124.5	13.1	55.2	10.9	55.2	25.5	3.0	55.2	10.9
30RAP-080	3519/1623	4289/1945	4637/2103	4722/2141	5357/2429	124.5	13.1	55.2	11.0	55.2	25.5	3.0	55.2	11.0
30RAP-090	3605/1623	4370/1945	4748/2141	4663/2141	5383/2441	124.5	13.1	55.2	12.0	55.2	25.5	3.0	55.2	12.0
30RAP-090	1635	1935	2114	2153	2441	3182.3	333.7	50.8	1140.7	305.6	127.0	140.7	305.6	127.0

DATE: 02/09/15
 SUPERSEDES: 30RAP-70, 80 AND 90 AIR COOLED CHILLERS
 30RA555557

Base unit dimensions — 30RAP100, 115



30RAP100, 115

NOTES: 1. UNIT MUST HAVE CLEARANCES AS FOLLOWS:

1. TOP: 10" MIN. CLEARANCE.
2. SIDES AND END: 6" FROM SOLID SURFACE, FOR AIRFLOW.
3. SIDE - 8" REQUIRED FOR COIL SERVICE AREA.
4. ALL PUMPS HAVE DRAINS LOCATED AT THE BOTTOM OF VOLUTE FOR DRAINING.
5. FILTER ORIFER OF EACH CIRCUIT AND HAVE 3/4" FLARE CONNECTION.
6. TWO Ø7/8(22.4) PILOT HOLES PROVIDED FOR LOCATING FIELD POWER WIRING.
7. ACTUAL HOLE REQUIRED DEPENDS ON FIELD WIRE SIZING.
8. FIELD WIRING MUST BE LOCATED WITHIN THE UNIT.
9. Ø10-52(13.3) HOLES USED FOR MOUNTING UNITS.
10. VICTAULIC CONNECTION SIZING INFORMATION IS CONSISTENT WITH IPS CARBON STEEL PIPING.

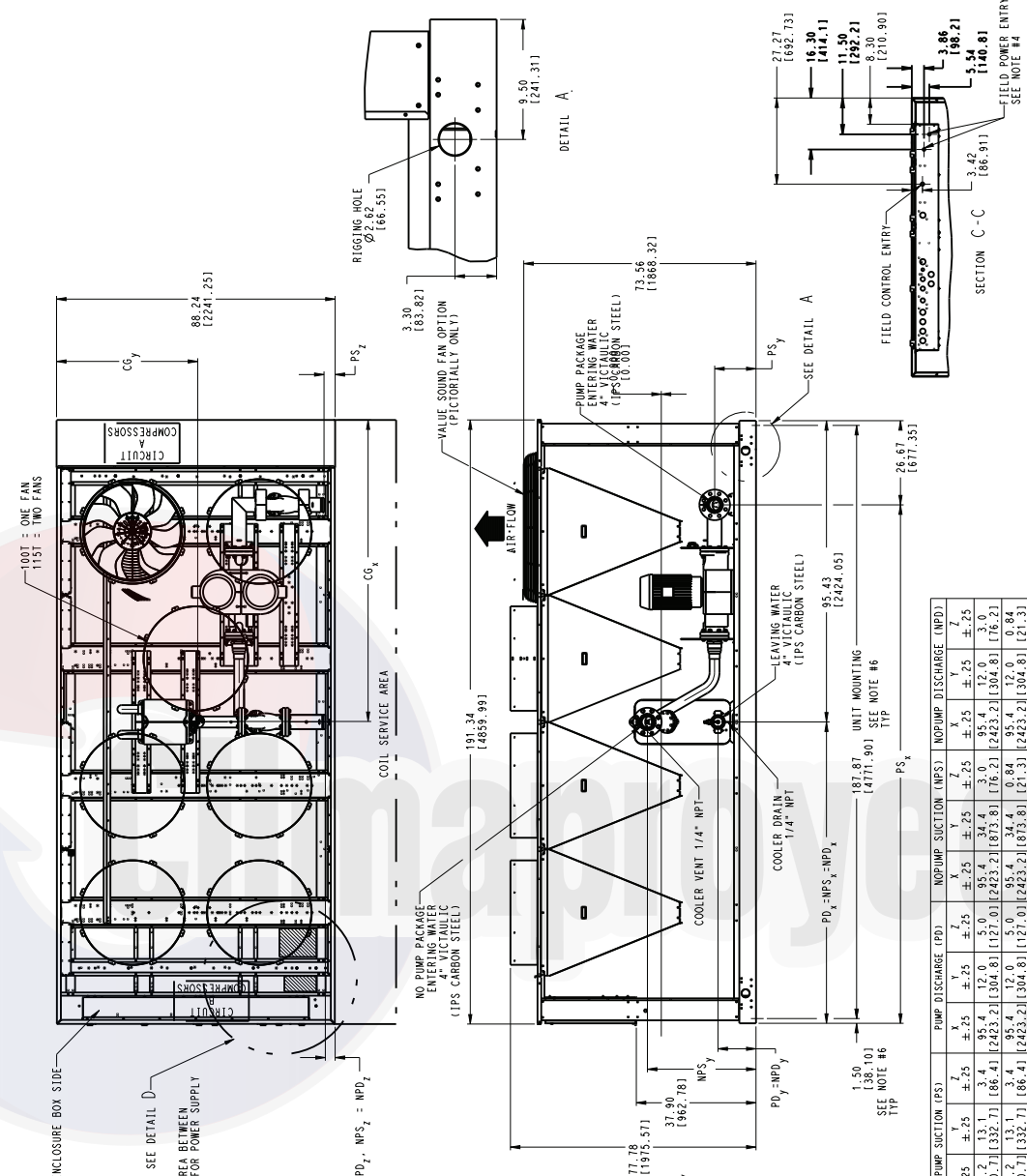

1. UNIT MUST HAVE CLEARANCES AS FOLLOWS:
1. TOP: 10" MIN. CLEARANCE.
2. SIDES AND END: 6" FROM SOLID SURFACE, FOR AIRFLOW.
3. SIDE - 8" REQUIRED FOR COIL SERVICE AREA.
4. ALL PUMPS HAVE DRAINS LOCATED AT THE BOTTOM OF VOLUTE FOR DRAINING.
5. FILTER ORIFER OF EACH CIRCUIT AND HAVE 3/4" FLARE CONNECTION.
6. TWO Ø7/8(22.4) PILOT HOLES PROVIDED FOR LOCATING FIELD POWER WIRING.
7. ACTUAL HOLE REQUIRED DEPENDS ON FIELD WIRE SIZING.
8. FIELD WIRING MUST BE LOCATED WITHIN THE UNIT.
9. Ø10-52(13.3) HOLES USED FOR MOUNTING UNITS.
10. VICTAULIC CONNECTION SIZING INFORMATION IS CONSISTENT WITH IPS CARBON STEEL PIPING.

WEIGHT MAX WEIGHT lb/kg	WEIGHT AL-CU lb/kg	WEIGHT CH-CU lb/kg	MAX WEIGHT CH-CU lb/kg	CENTER OF GRAVITY CGX INCH (MM)	CGY INCH (MM)	PUMP SUCTION (IPS)			PUMP DISCHARGE (PD)			NO PUMP SUCTION (NPS)			NO PUMP DISCHARGE (NPD)			
						Y	X	Z	Y	X	Z	Y	X	Z	Y	X	Z	
30RAP-100 4592/2082	3267/1479	6290/2853	6967/3159	104.4 (2652)	115.1 (2918)	±25	±25	±25	±25	±25	±25	±25	±25	±25	±25	±25	±25	±25
30RAP-115 4900/2222	3575/1624	6507/2951	7467/3386	101 (2565)	114.8 (2916)	±25	±25	±25	±25	±25	±25	±25	±25	±25	±25	±25	±25	±25

REV	DATE	DESCRIPTION	BY	CHKD	APP'D
G	02/06/15	30RAP-100 AND 115 AIR COOLED CHILLER	F		
F					
E					
D					
C					
B					
A					

ACCESSORY STORAGE TANK FOR UNIT SIZES 011 AND 016

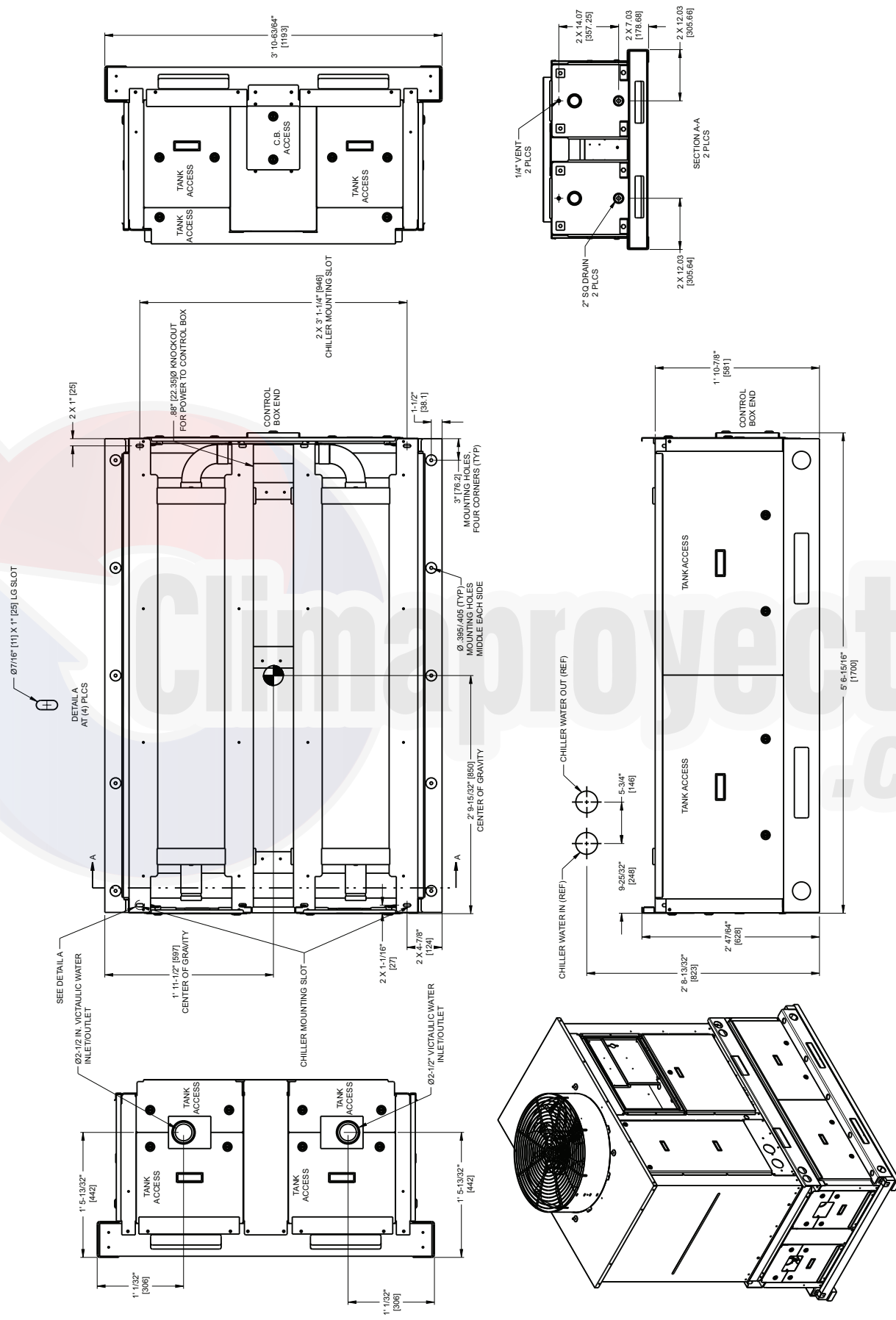

Selection procedure



Carrier's electronic catalog chiller selection program provides quick, easy selection of Carrier chillers. The program considers specific temperature, fluid, flow requirements, system pressure drop (for proper pump selection, when required), as well as other factors, such as fouling and altitude correction.

To select a 30RAP chiller, including optional pump package when required (60 Hz only), use the NACO (North American Commercial Operation) Packaged Chiller Builder Program.

PUMP IMPELLER SIZES (60 Hz CHILLERS ONLY)

UNIT 30RAP	PUMP Hp	SINGLE PUMP					DUAL PUMP				
		Option Code*		Rpm	Impeller Dia. (in.)	Pump Curve	Option Code*		Rpm	Impeller Dia. (in.)	Pump Curve
		non-VFD	VFD				non-VFD	VFD			
011-030	1.5	2	N/A	3500	4.25	I	9	N/A	3500	4.25	I
	3	3	N/A	3500	4.75	I	B	N/A	3500	4.75	I
	3 (high head)	4	N/A	3500	5.00	I	C	N/A	3500	5.00	I
	5	5	N/A	3500	5.50	II	D	N/A	3500	5.50	II
035-045	3	3	N/A	3500	4.75	I	B	N/A	3500	4.75	I
	3 (high head)	4	N/A	3500	5.25	I	C	N/A	3500	5.25	I
	5	5	N/A	3500	4.50	III	D	N/A	3500	4.50	III
	5 (high head)	6	N/A	3500	4.88	III	F	N/A	3500	4.88	III
050-060	7.5	7	N/A	3500	5.50	IV	G	N/A	3500	5.50	IV
	3 (high head)	4	N/A	3500	5.25	I	C	N/A	3500	5.25	I
	5	5	N/A	3500	4.50	III	D	N/A	3500	4.50	III
	5 (high head)	6	N/A	3500	4.88	III	F	N/A	3500	4.88	III
070	7.5	7	N/A	3500	5.50	IV	G	N/A	3500	5.50	IV
	7.5	3	F	3500	5.25	VI	8	L	3500	5.25	IX
	10	4	G	3500	5.75	VI	9	M	3500	5.90	IX
	10	Z	N/A	3500	6.00	IV	H	N/A	3500	6.00	IV
080-100	7.5	3	F	3500	5.25	VI	8	L	3500	5.00	VIII
	10	4	G	3500	5.75	VI	9	M	3500	5.40	VIII
	15	5	H	3500	6.50	VI	B	N	3500	6.10	VIII
115,130	7.5	3	F	3500	5.00	X	8	L	3500	5.00	VIII
	10	4	G	3500	5.40	X	9	M	3500	5.40	VIII
	15	5	H	3500	6.10	X	B	N	3500	6.00	VIII
150	5	2	D	1750	6.50	XI	—	—	—	—	—
	7.5	3	F	1750	7.40	XI	8	L	3500	5.00	VIII
	10	4	G	3500	4.60	XII	9	M	3500	5.40	VIII
	15	5	H	3500	5.20	XII	B	N	3500	6.00	VIII

*Option Code refers to the Hydronics Option (position 12) in the model number. See the 30RAP nomenclature on pages 5 and 6 for option identification.

NOTES:

1. Pump selections are chiller size dependent. For example, option code 5 on a 30RAP011-030 chiller is not the same as option code 5 on a 30RAP035-045 chiller.
2. 30RAP chillers with Greenspeed® intelligence are not available on unit sizes 070-150.

HEAT EXCHANGER PRESSURE DROP — 30RAP011-030 (ENGLISH)

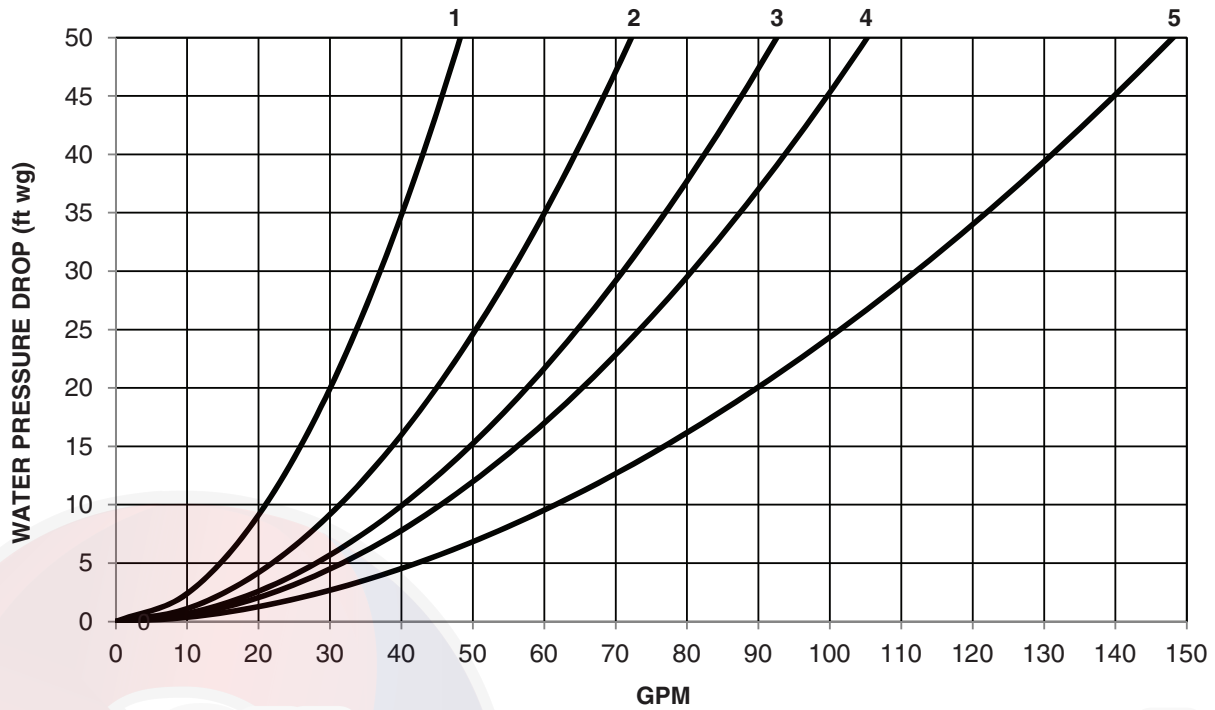

- LEGEND
- 1 — 30RAP011
 - 2 — 30RAP016,018
 - 3 — 30RAP020
 - 4 — 30RAP025
 - 5 — 30RAP030

HEAT EXCHANGER PRESSURE DROP — 30RAP035-060 (ENGLISH)

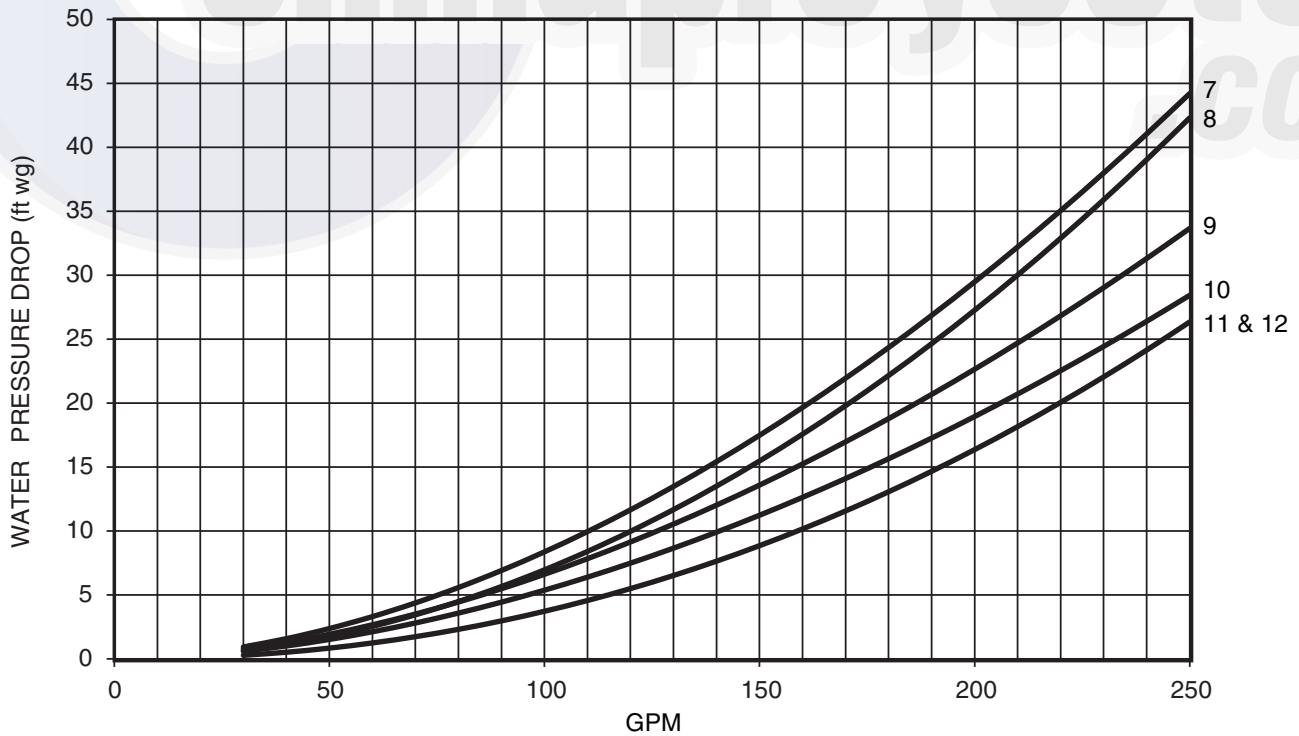

- LEGEND
- 7 — 30RAP035
 - 8 — 30RAP040
 - 9 — 30RAP045
 - 10 — 30RAP050
 - 11 — 30RAP055
 - 12 — 30RAP060

HEAT EXCHANGER PRESSURE DROP — 30RAP070-090 (ENGLISH)

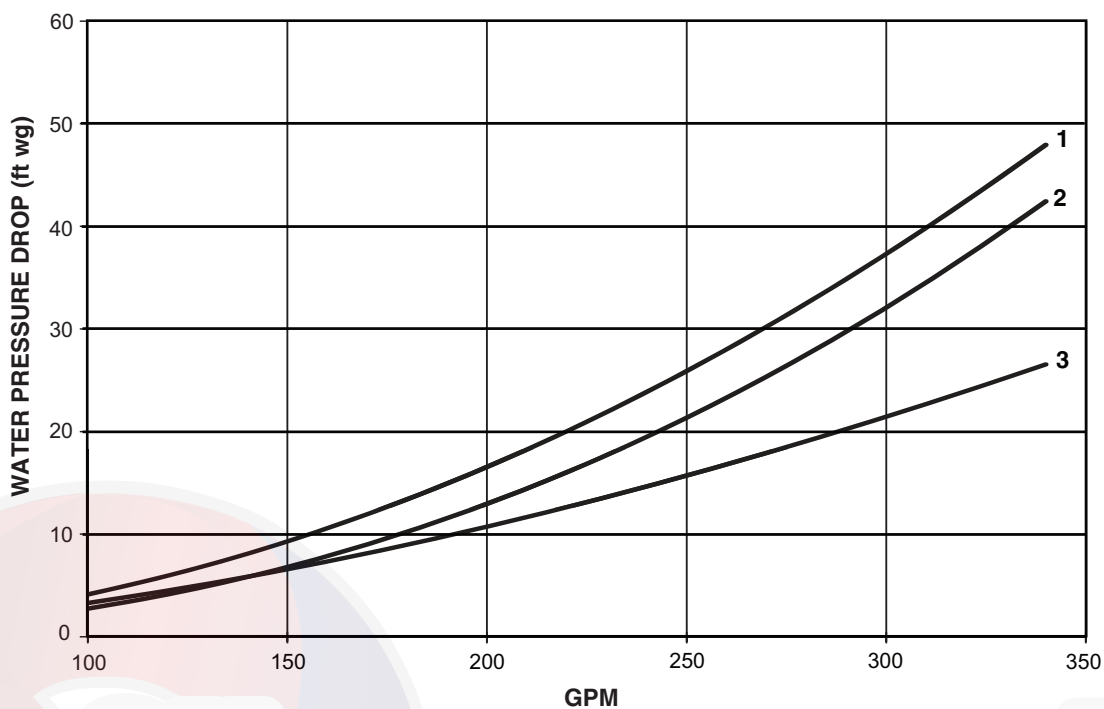

LEGEND
1 — 30RAP070
2 — 30RAP080
3 — 30RAP090

HEAT EXCHANGER PRESSURE DROP — 30RAP011-030 (SI)

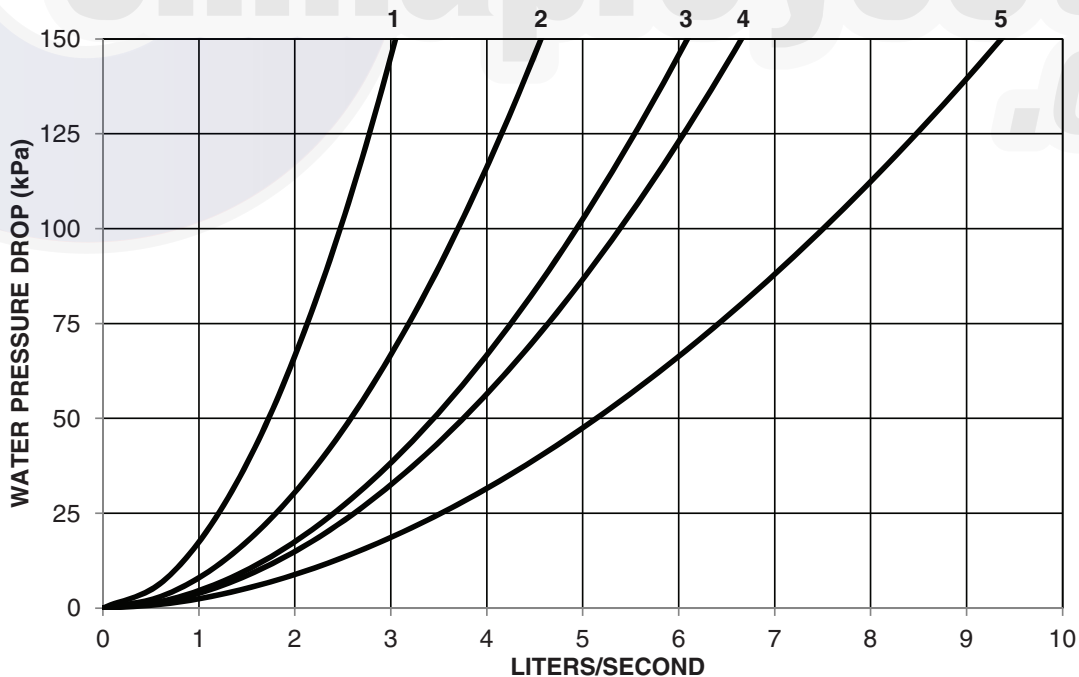

LEGEND
1 — 30RAP011 4 — 30RAP025
2 — 30RAP016,018 5 — 30RAP030
3 — 30RAP020

HEAT EXCHANGER PRESSURE DROP — 30RAP035-060 (SI)

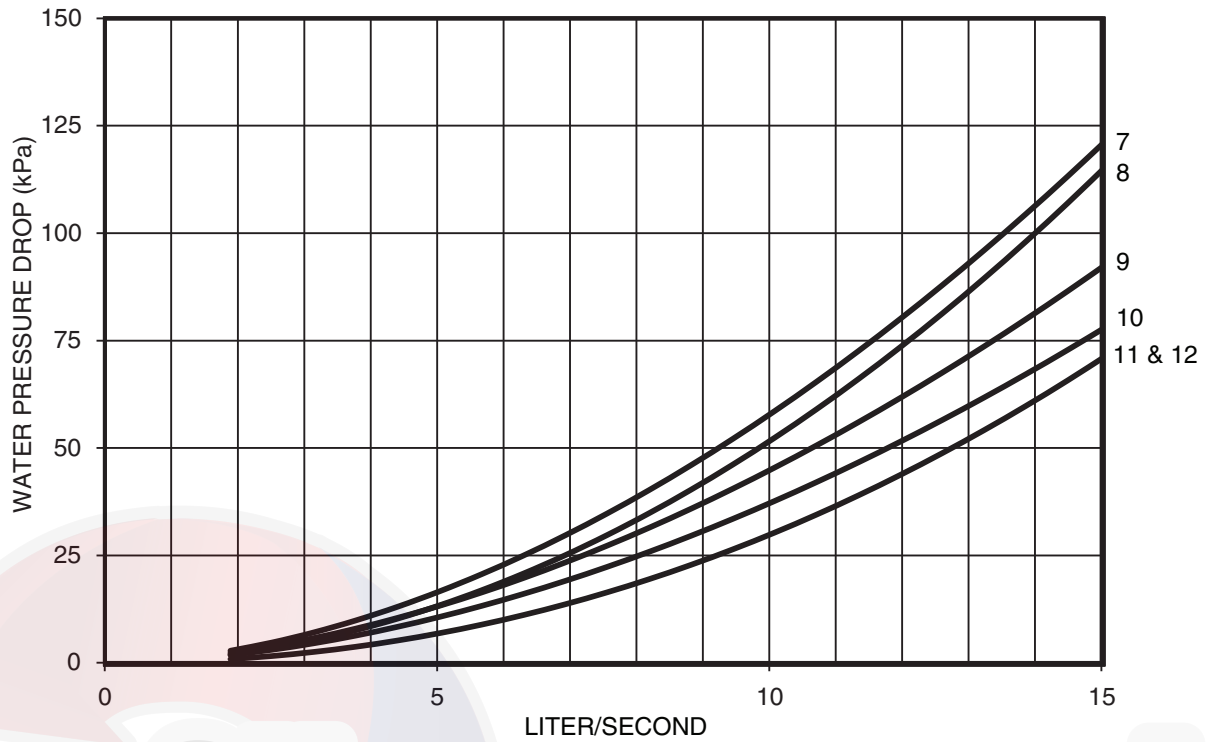

- LEGEND
- 7 — 30RAP035
 - 8 — 30RAP040
 - 9 — 30RAP045
 - 10 — 30RAP050
 - 11 — 30RAP055
 - 12 — 30RAP060

HEAT EXCHANGER PRESSURE DROP — 30RAP070-090 (SI)

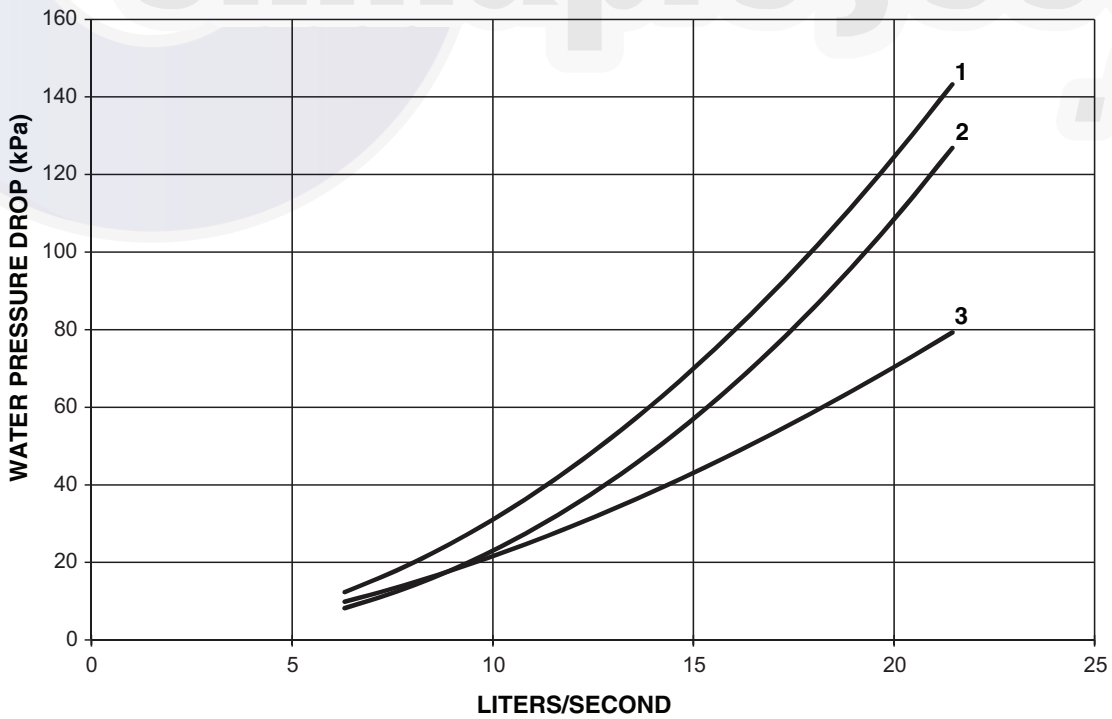

- LEGEND
- 1 — 30RAP070
 - 2 — 30RAP080
 - 3 — 30RAP090

UNIT PRESSURE DROP — NO HYDRONIC PACKAGE — 30RAP011-030 (ENGLISH)

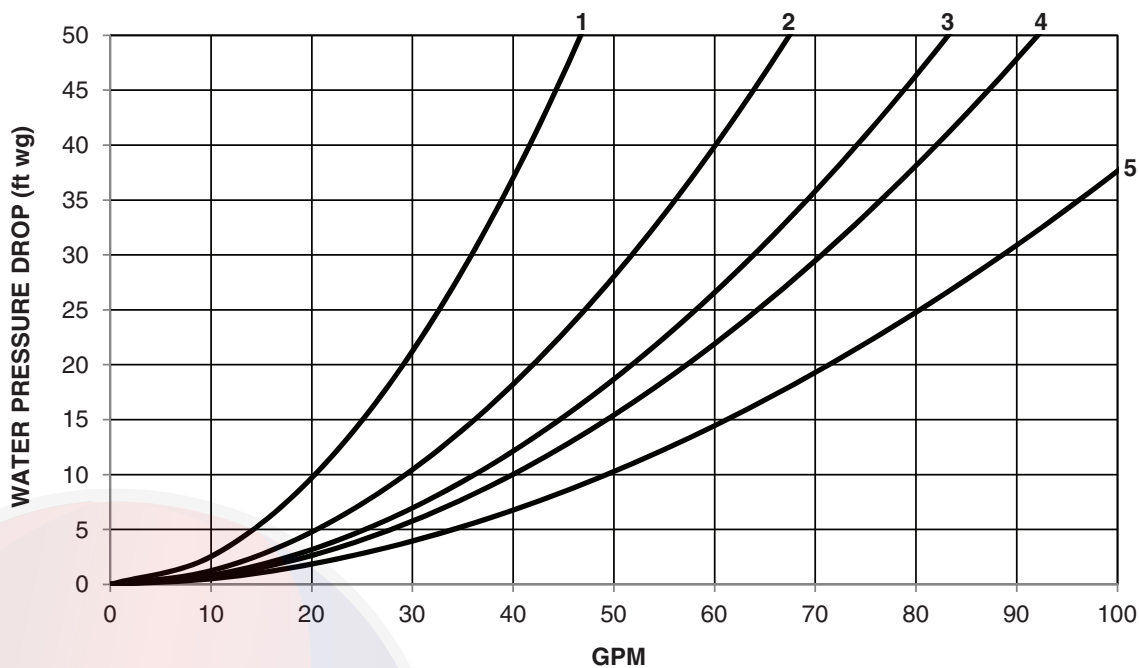

LEGEND
 1 — 30RAP011 4 — 30RAP025
 2 — 30RAP016,018 5 — 30RAP030
 3 — 30RAP020

UNIT PRESSURE DROP — NO HYDRONIC PACKAGE — 30RAP035-060 (ENGLISH)

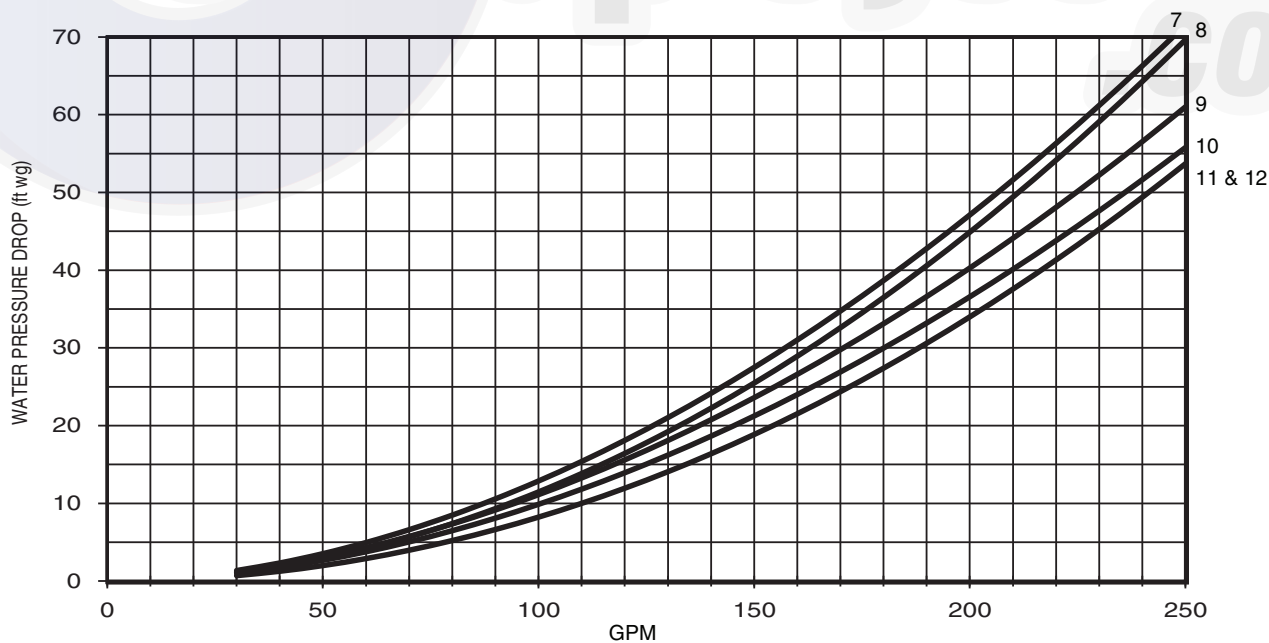

LEGEND
 7 — 30RAP035 10 — 30RAP050
 8 — 30RAP040 11 — 30RAP055
 9 — 30RAP045 12 — 30RAP060

UNIT PRESSURE DROP — NO HYDRONIC PACKAGE — 30RAP070-090 (ENGLISH)

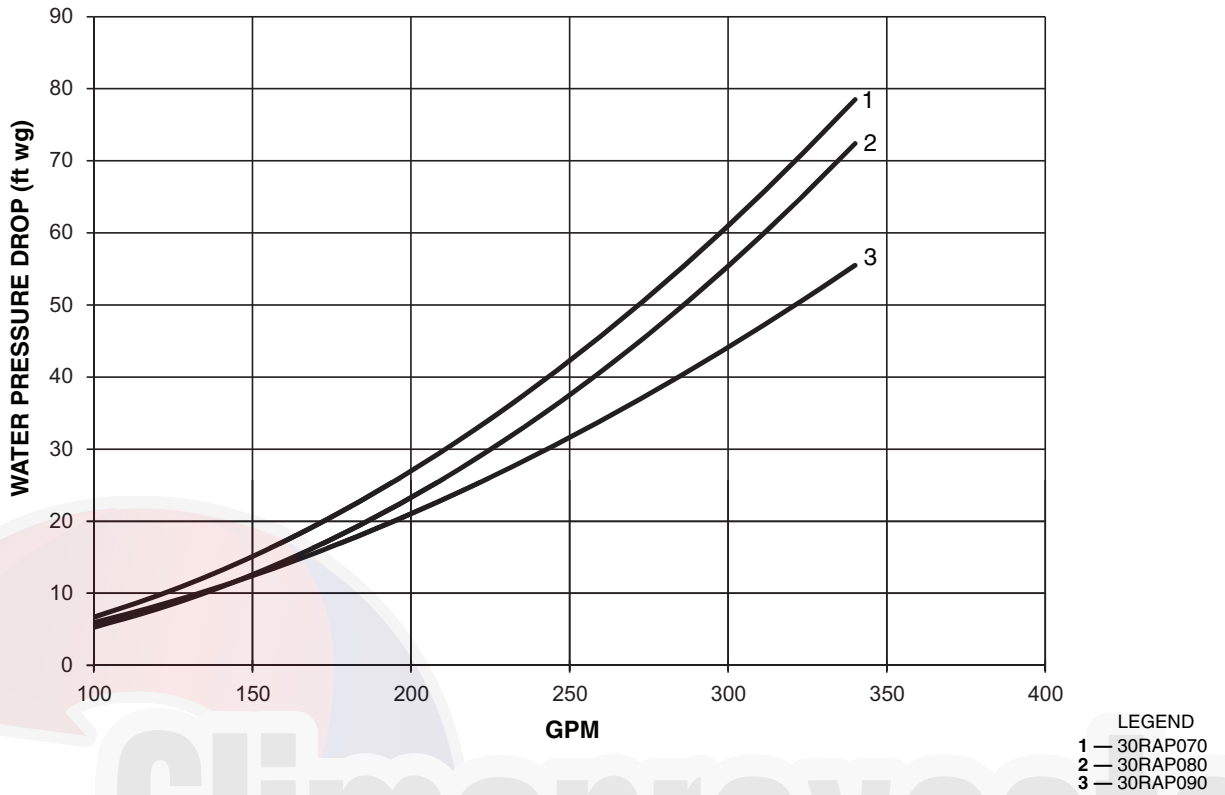

UNIT PRESSURE DROP — NO HYDRONIC PACKAGE — 30RAP100-150 (ENGLISH)

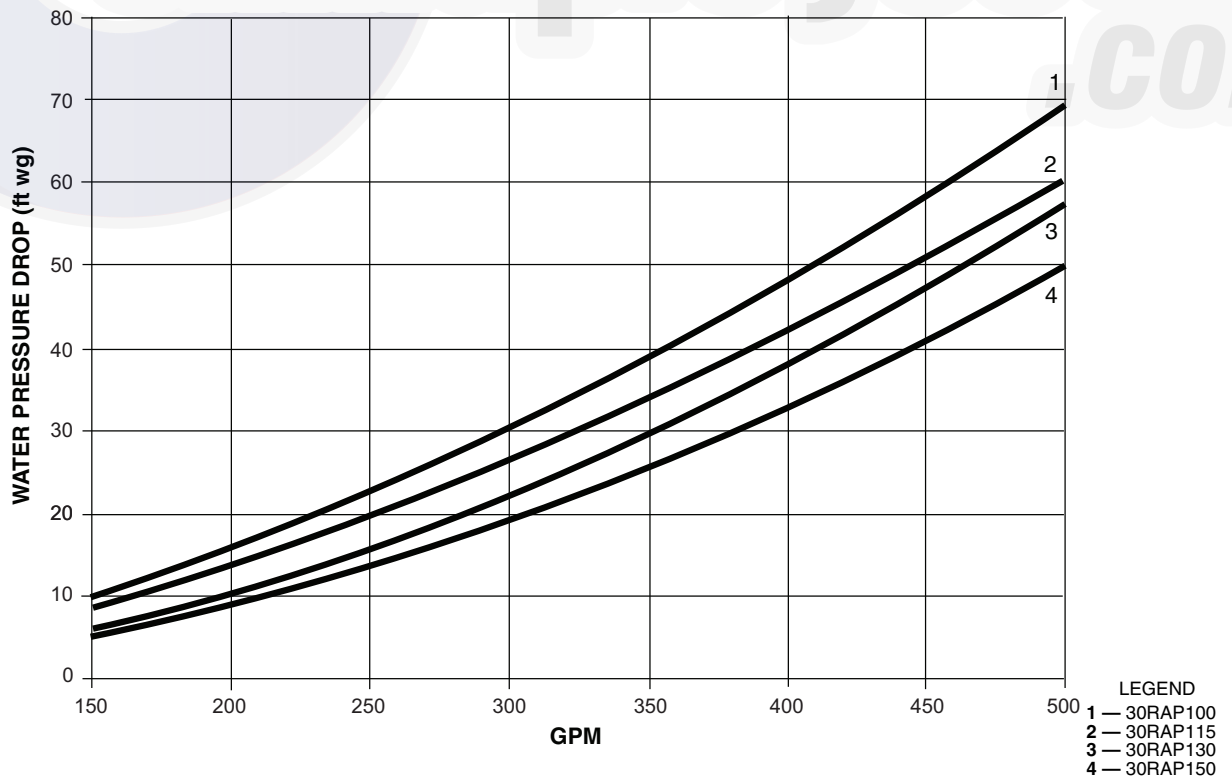

UNIT PRESSURE DROP — NO HYDRONIC PACKAGE — 30RAP011-030 (SI)

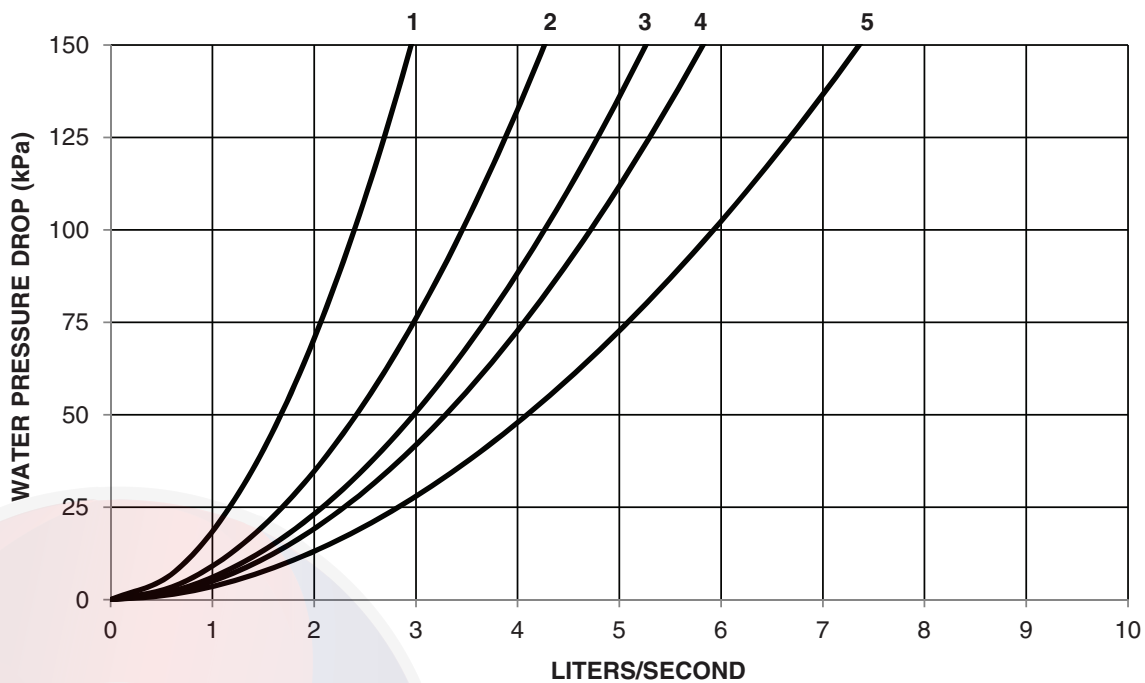

- LEGEND
- 1 — 30RAP011
 - 2 — 30RAP016,018
 - 3 — 30RAP020
 - 4 — 30RAP025
 - 5 — 30RAP030

UNIT PRESSURE DROP — NO HYDRONIC PACKAGE — 30RAP035-060 (SI)

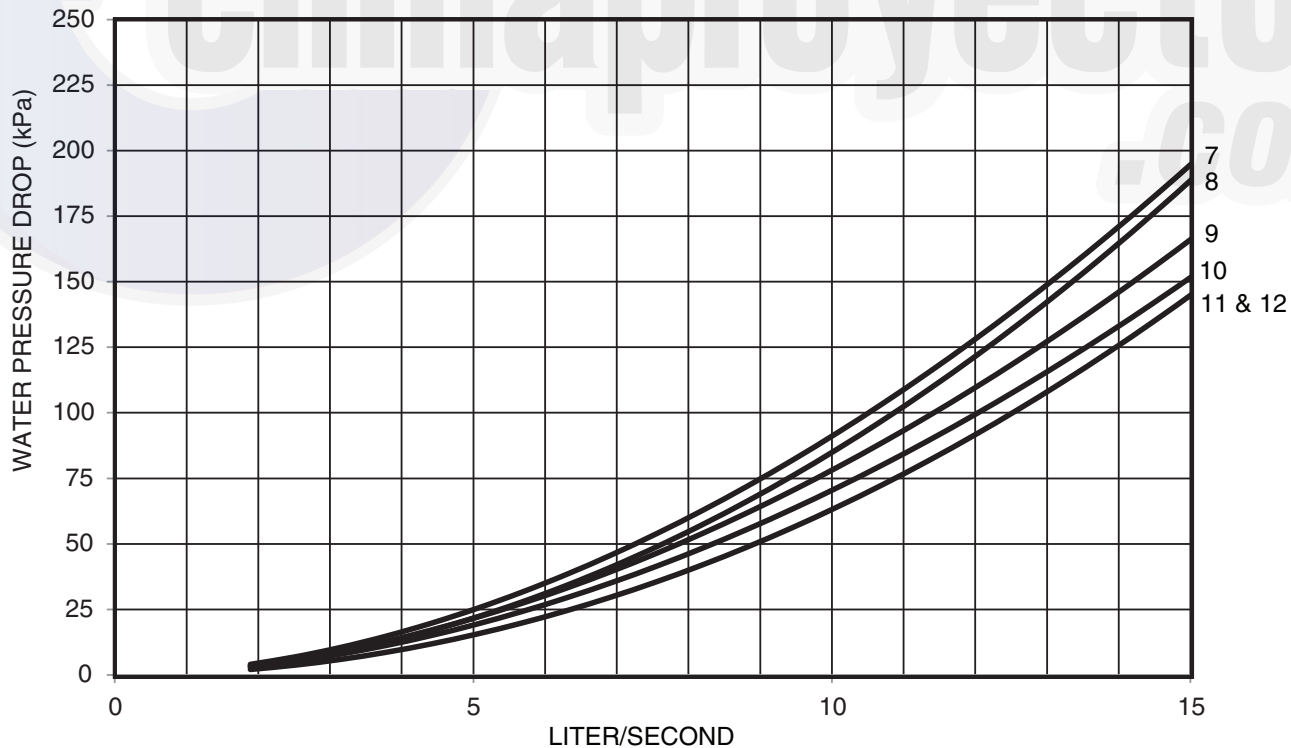

- LEGEND
- 7 — 30RAP035
 - 8 — 30RAP040
 - 9 — 30RAP045
 - 10 — 30RAP050
 - 11 — 30RAP055
 - 12 — 30RAP060

Performance data (cont)

UNIT PRESSURE DROP — NO HYDRONIC PACKAGE — 30RAP070-090 (SI)

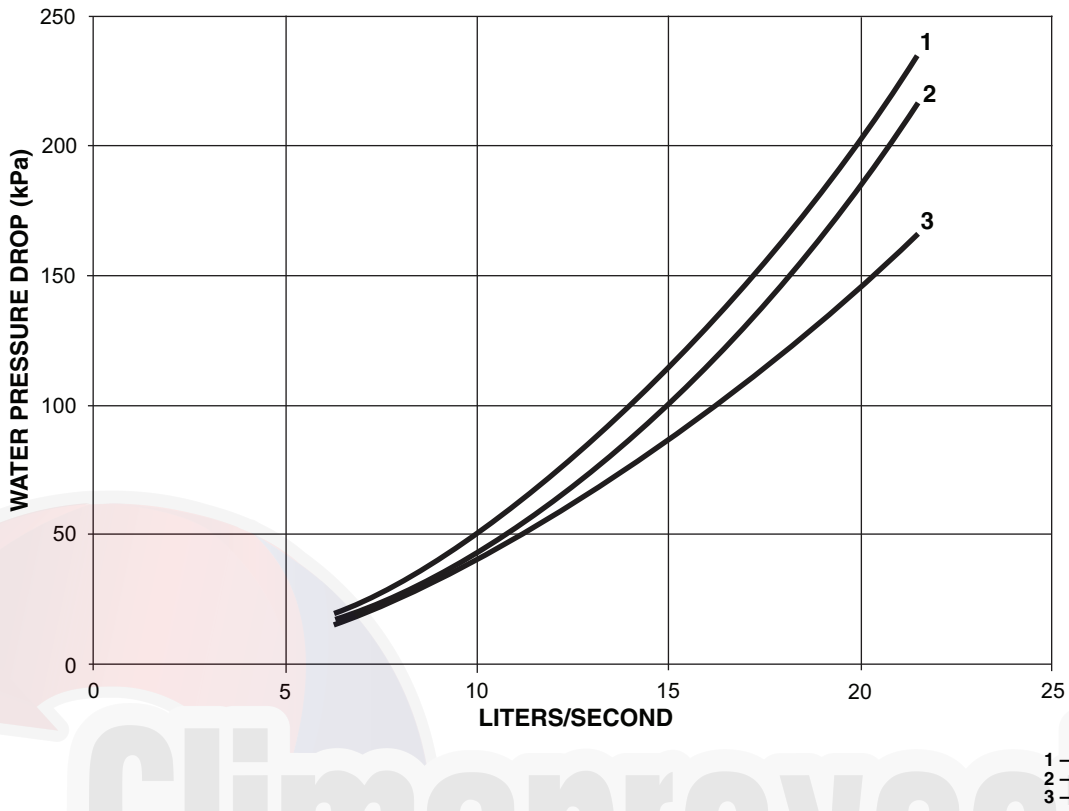

UNIT PRESSURE DROP — NO HYDRONIC PACKAGE — 30RAP100-150 (SI)

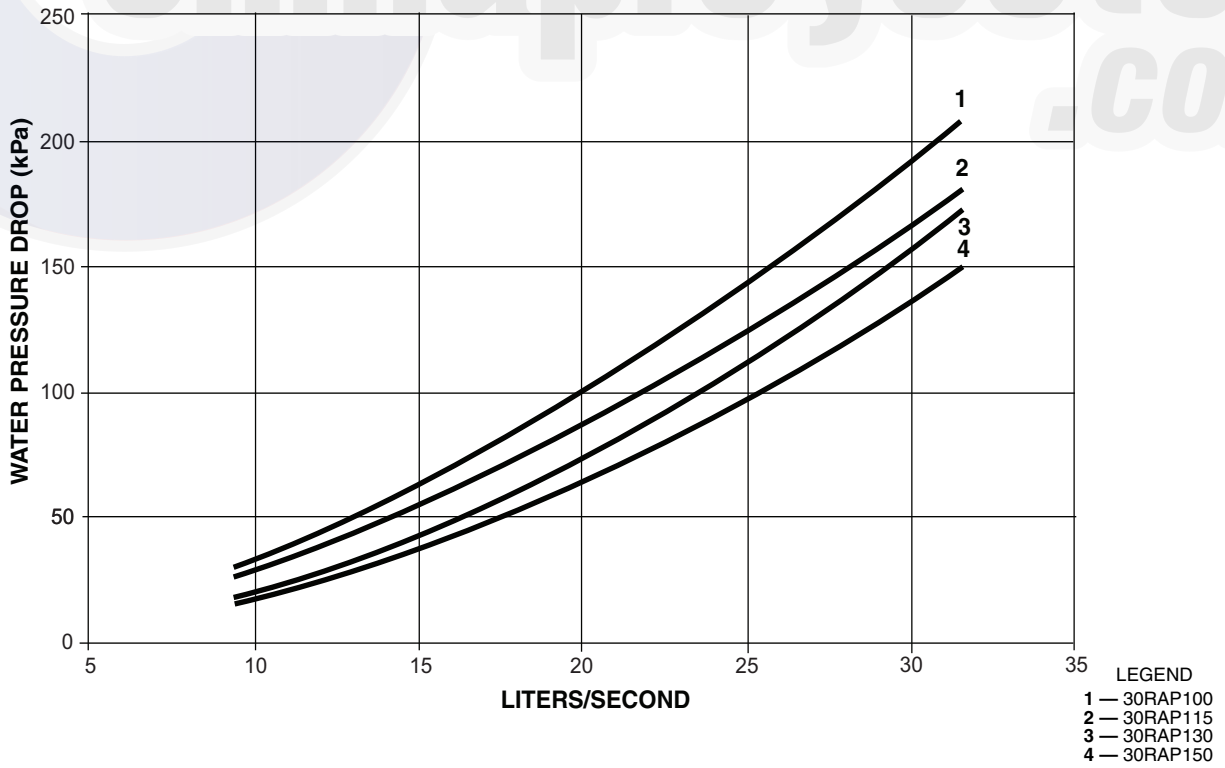

UNIT PRESSURE DROP — SINGLE PUMP HYDRONIC PACKAGE, 60 Hz ONLY — 30RAP011-030 (ENGLISH)

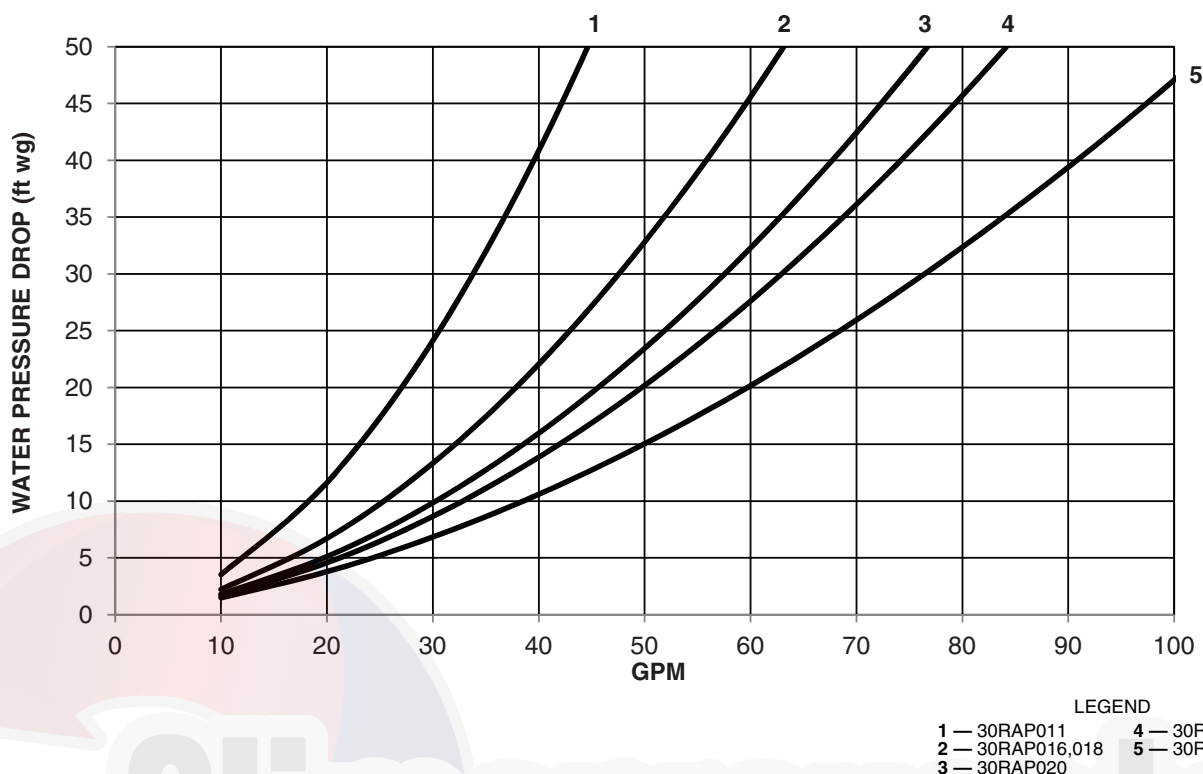

UNIT PRESSURE DROP — SINGLE PUMP HYDRONIC PACKAGE, 60 Hz ONLY — 30RAP035-060 (ENGLISH)

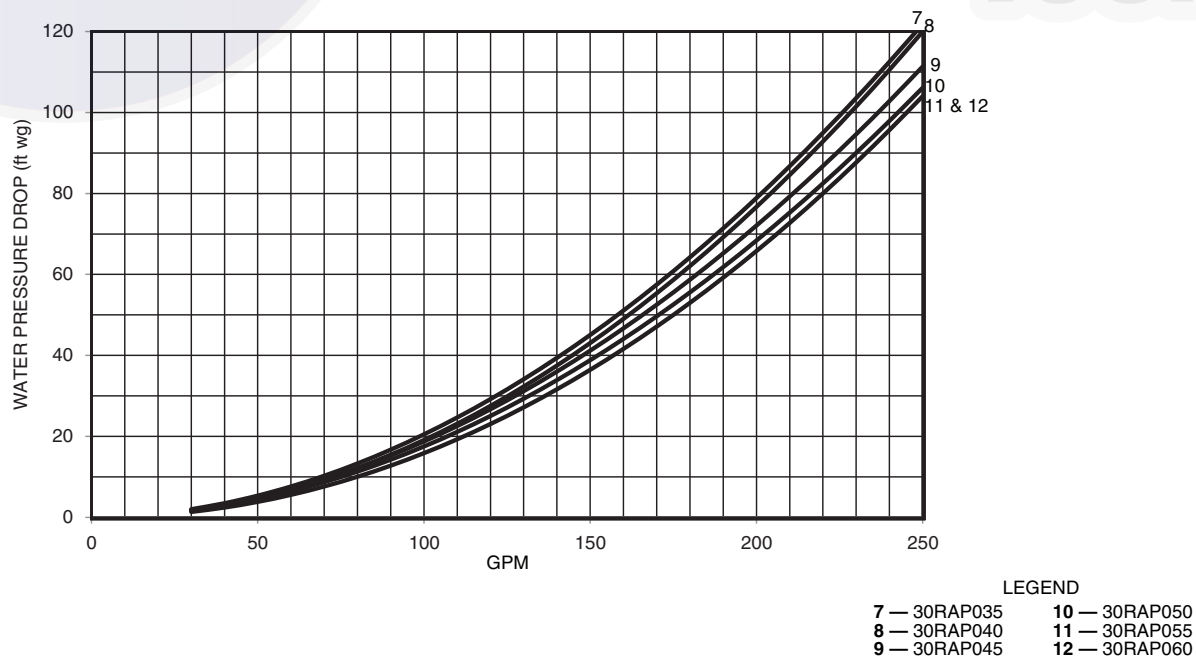

UNIT PRESSURE DROP — SINGLE PUMP HYDRONIC PACKAGE, 60 Hz ONLY — 30RAP070-090 (ENGLISH)

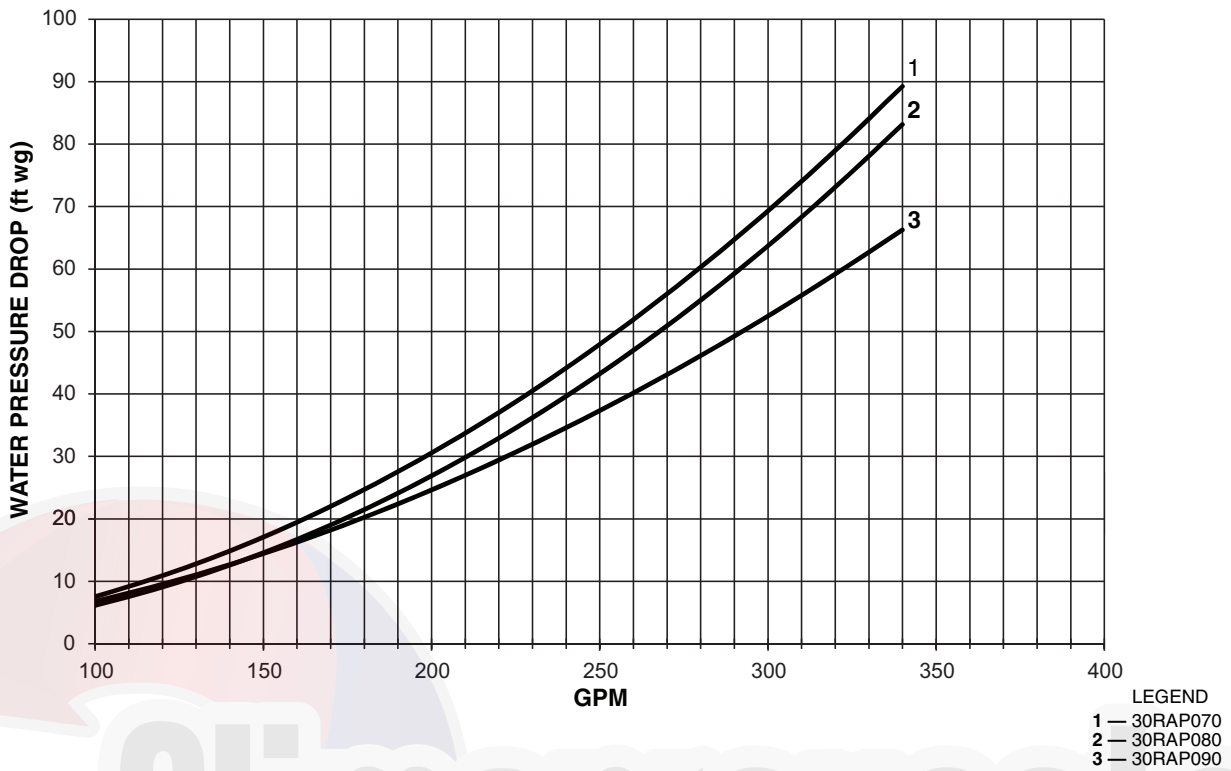

UNIT PRESSURE DROP — SINGLE PUMP HYDRONIC PACKAGE, 60 Hz ONLY — 30RAP100-150 (ENGLISH)

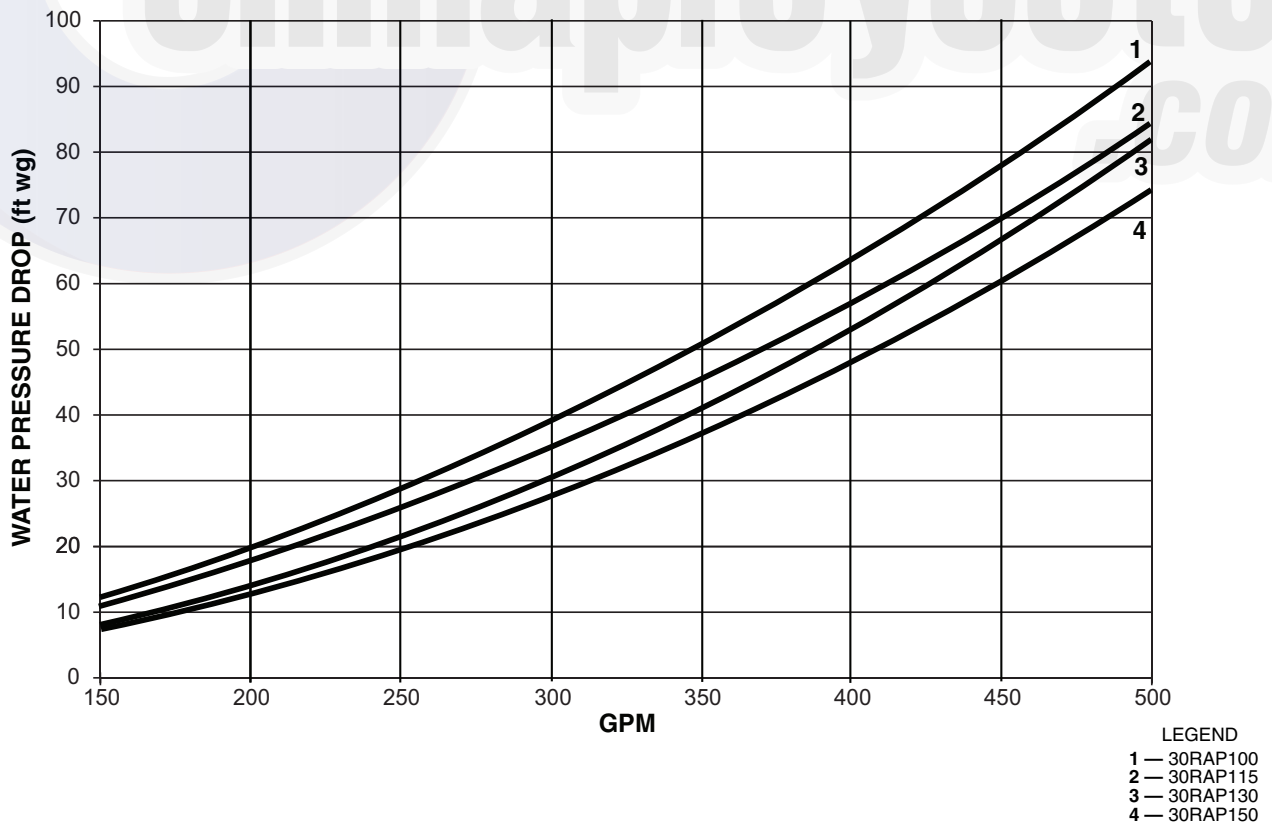

UNIT PRESSURE DROP — SINGLE PUMP HYDRONIC PACKAGE, 60 Hz ONLY — 30RAP011-030 (SI)

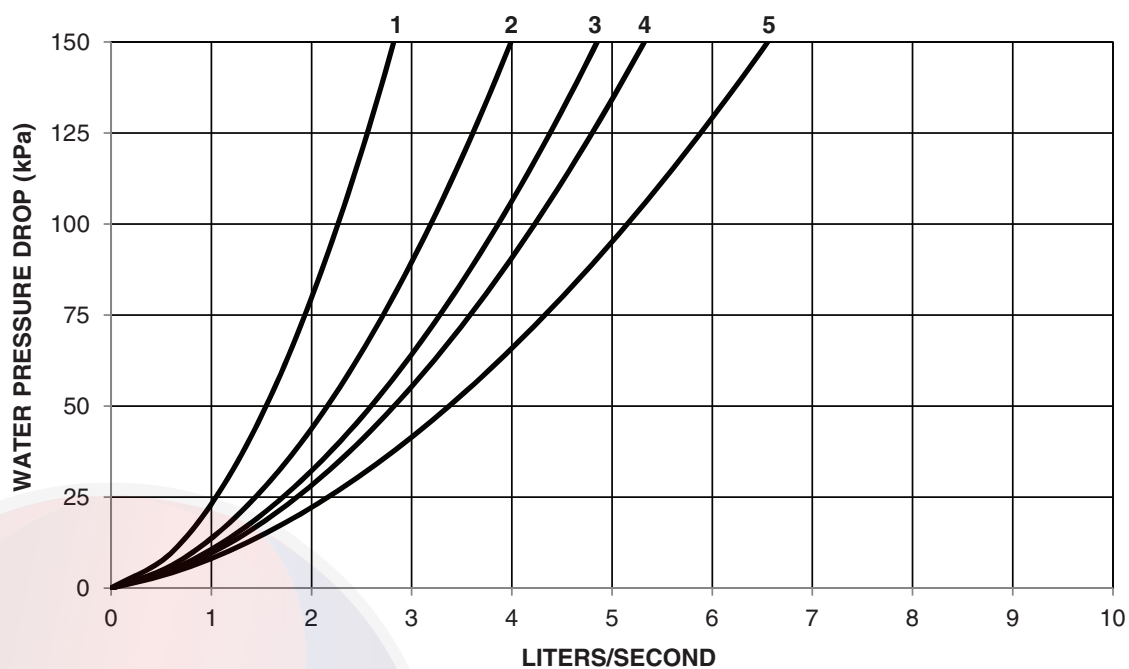

LEGEND
 1 — 30RAP011 4 — 30RAP025
 2 — 30RAP016,018 5 — 30RAP030
 3 — 30RAP020

UNIT PRESSURE DROP — SINGLE PUMP HYDRONIC PACKAGE, 60 Hz ONLY — 30RAP035-060 (SI)

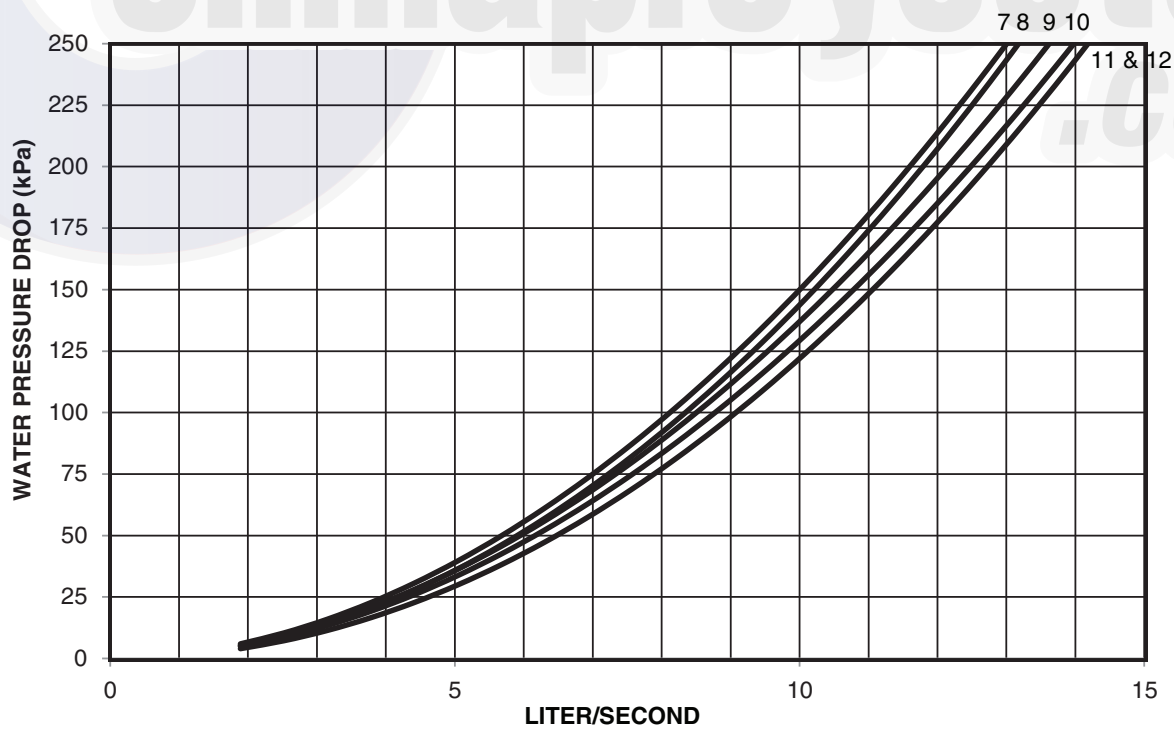

LEGEND
 7 — 30RAP035 10 — 30RAP050
 8 — 30RAP040 11 — 30RAP055
 9 — 30RAP045 12 — 30RAP060

Performance data (cont)

UNIT PRESSURE DROP — SINGLE PUMP HYDRONIC PACKAGE, 60 Hz ONLY — 30RAP070-090 (SI)

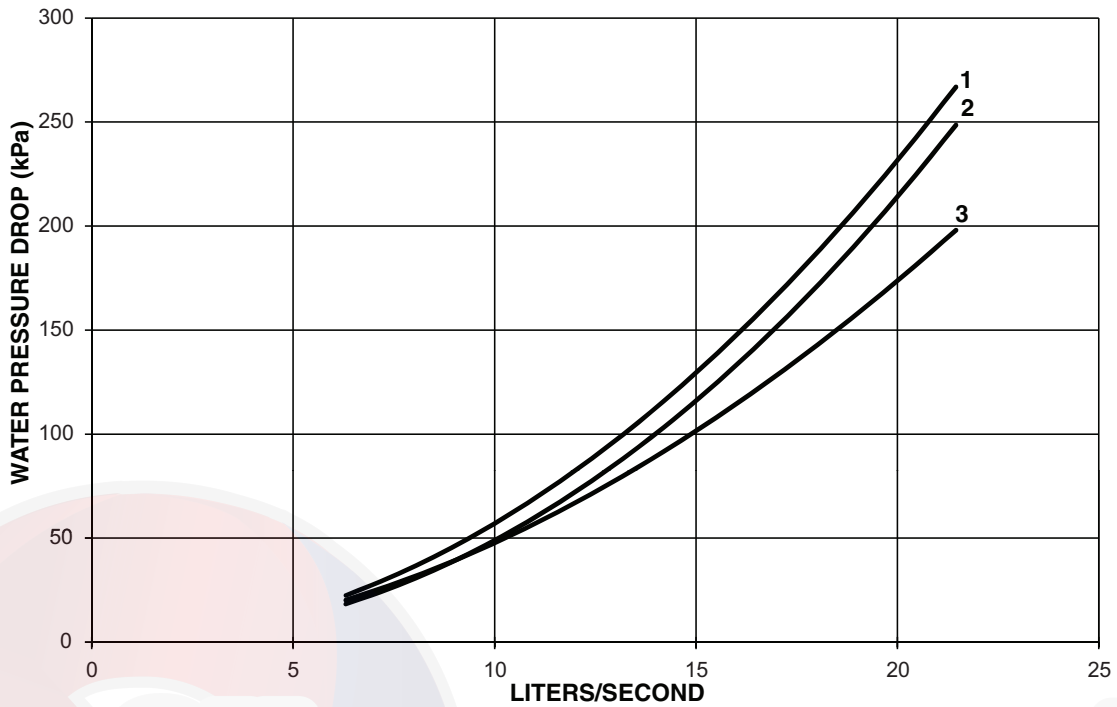

LEGEND
 1 — 30RAP070
 2 — 30RAP080

UNIT PRESSURE DROP — SINGLE PUMP HYDRONIC PACKAGE, 60 Hz ONLY — 30RAP100-150 (SI)

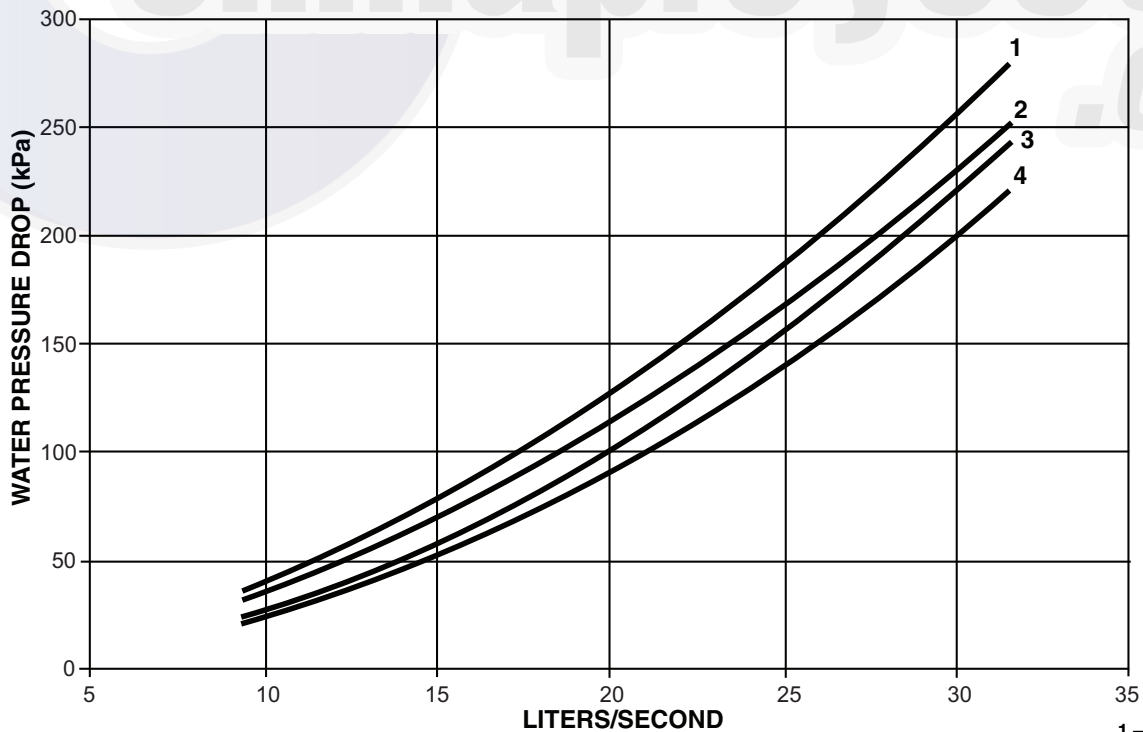

LEGEND
 1 — 30RAP100
 2 — 30RAP115
 3 — 30RAP130
 4 — 30RAP150

UNIT PRESSURE DROP — DUAL PUMP HYDRONIC PACKAGE, 60 Hz ONLY — 30RAP011-030 (ENGLISH)

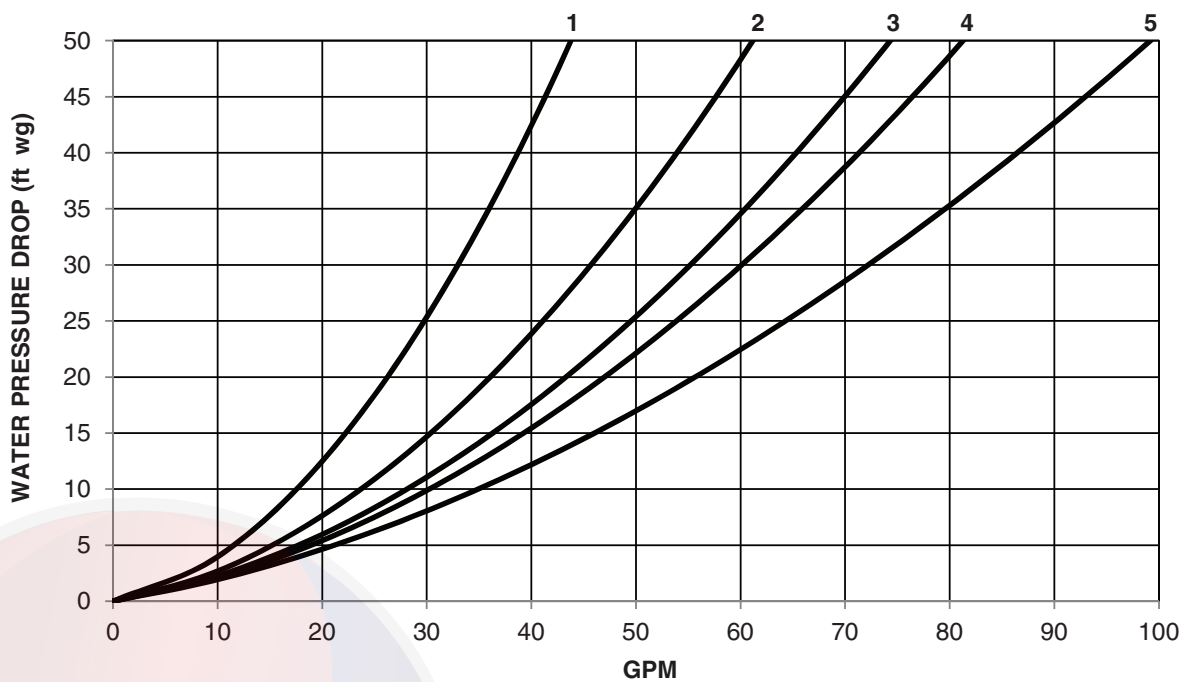

LEGEND
 1 — 30RAP011 4 — 30RAP025
 2 — 30RAP016,018 5 — 30RAP030
 3 — 30RAP020

UNIT PRESSURE DROP — DUAL PUMP HYDRONIC PACKAGE, 60 Hz ONLY — 30RAP035-060 (ENGLISH)

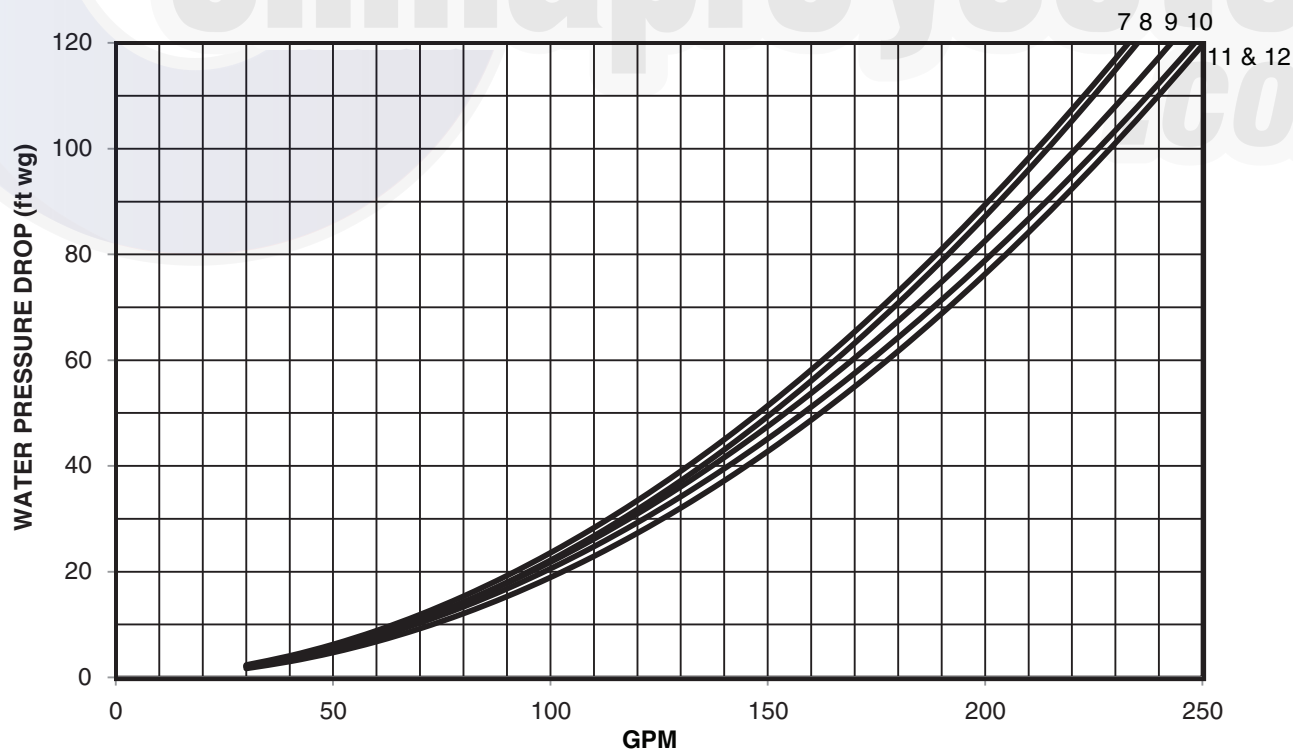

LEGEND
 7 — 30RAP035 10 — 30RAP050
 8 — 30RAP040 11 — 30RAP055
 9 — 30RAP045 12 — 30RAP060

Performance data (cont)



UNIT PRESSURE DROP — DUAL PUMP HYDRONIC PACKAGE, 60 Hz ONLY — 30RAP070-090 (ENGLISH)

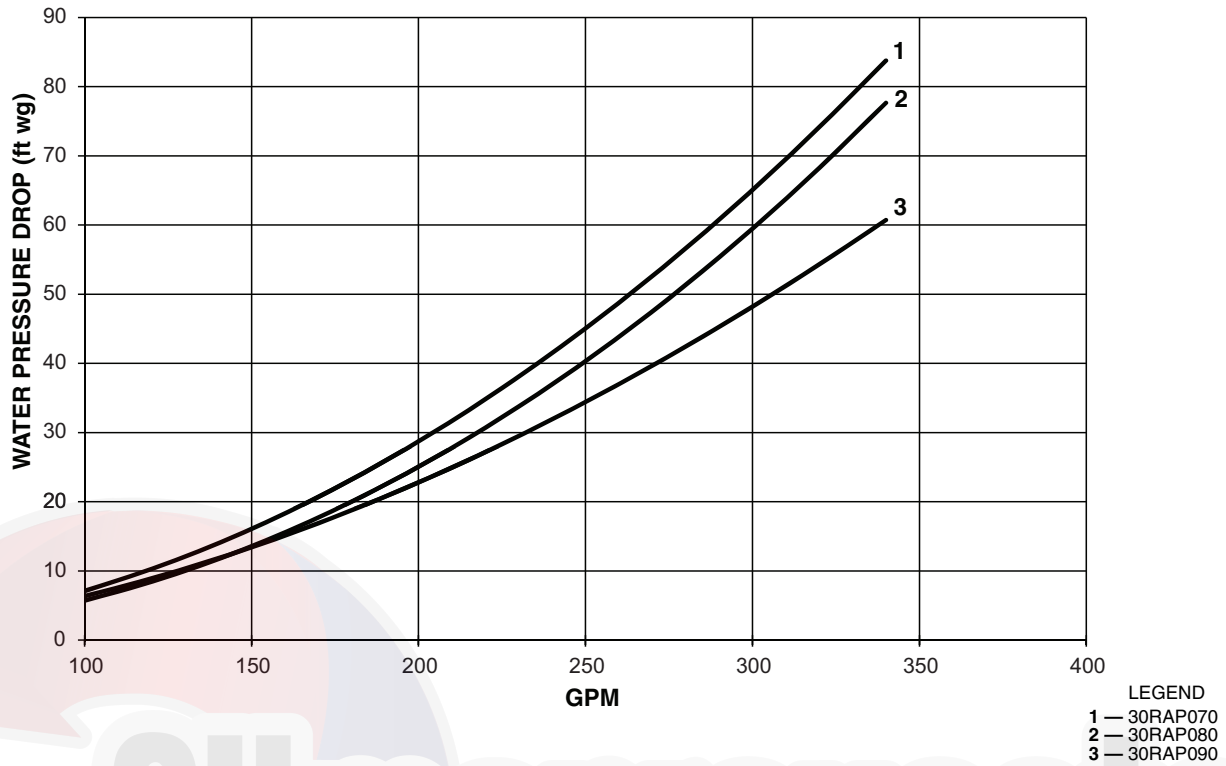

UNIT PRESSURE DROP — DUAL PUMP HYDRONIC PACKAGE, 60 Hz ONLY — 30RAP100-150 (ENGLISH)

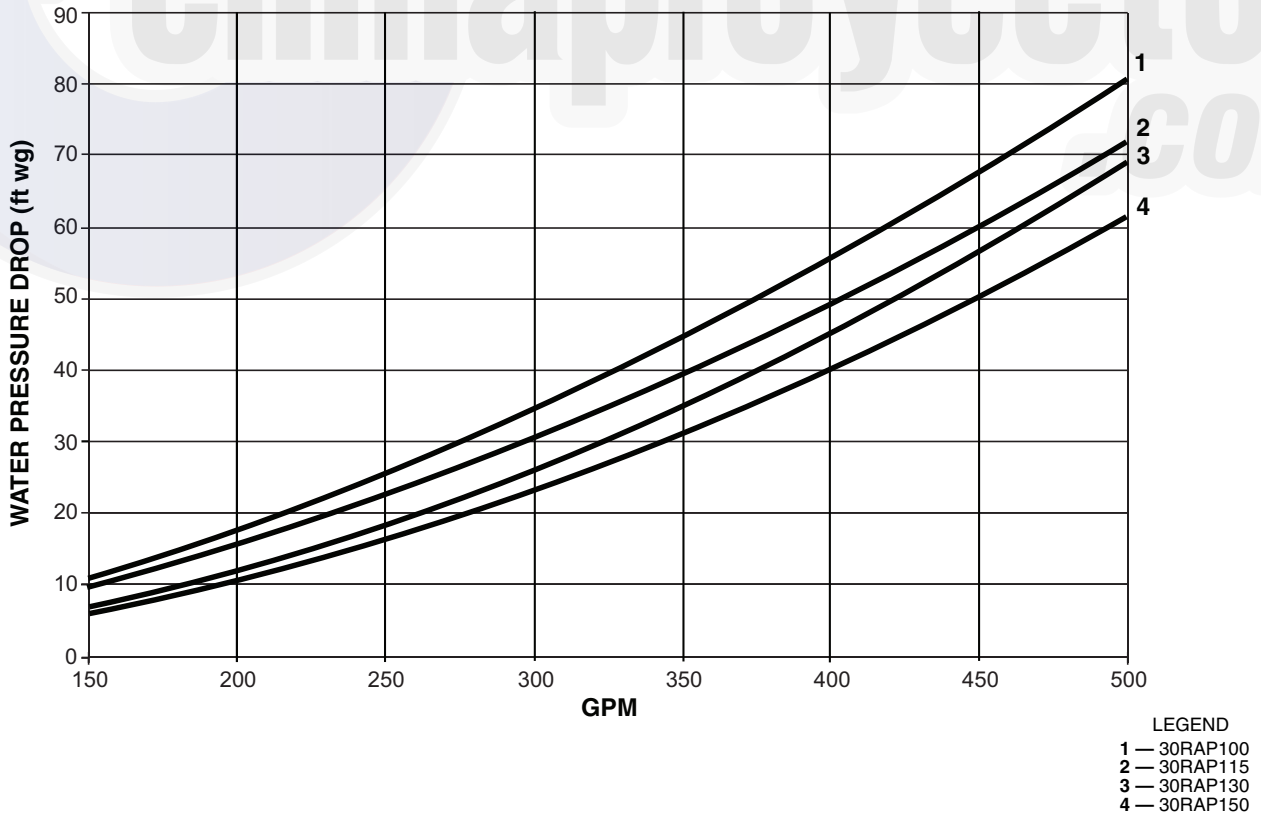

UNIT PRESSURE DROP — DUAL PUMP HYDRONIC PACKAGE, 60 Hz ONLY — 30RAP011-030 (SI)

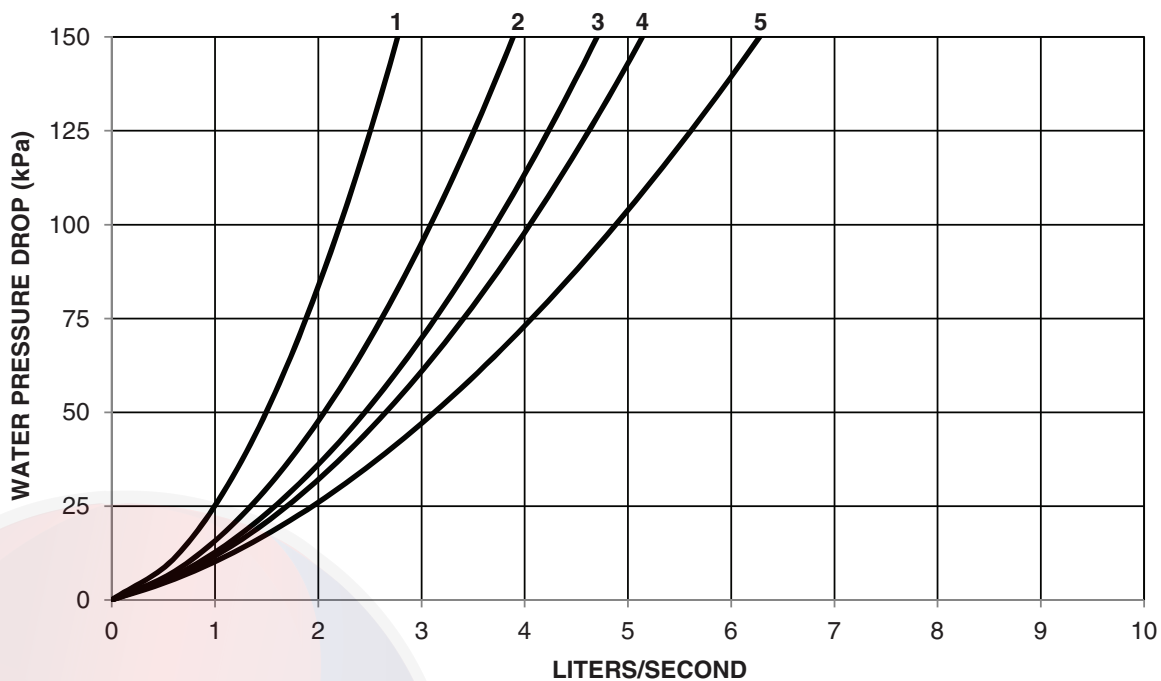

- LEGEND
- 1 — 30RAP011
 - 2 — 30RAP016,018
 - 3 — 30RAP020
 - 4 — 30RAP025
 - 5 — 30RAP030

UNIT PRESSURE DROP — DUAL PUMP HYDRONIC PACKAGE, 60 Hz ONLY — 30RAP035-060 (SI)

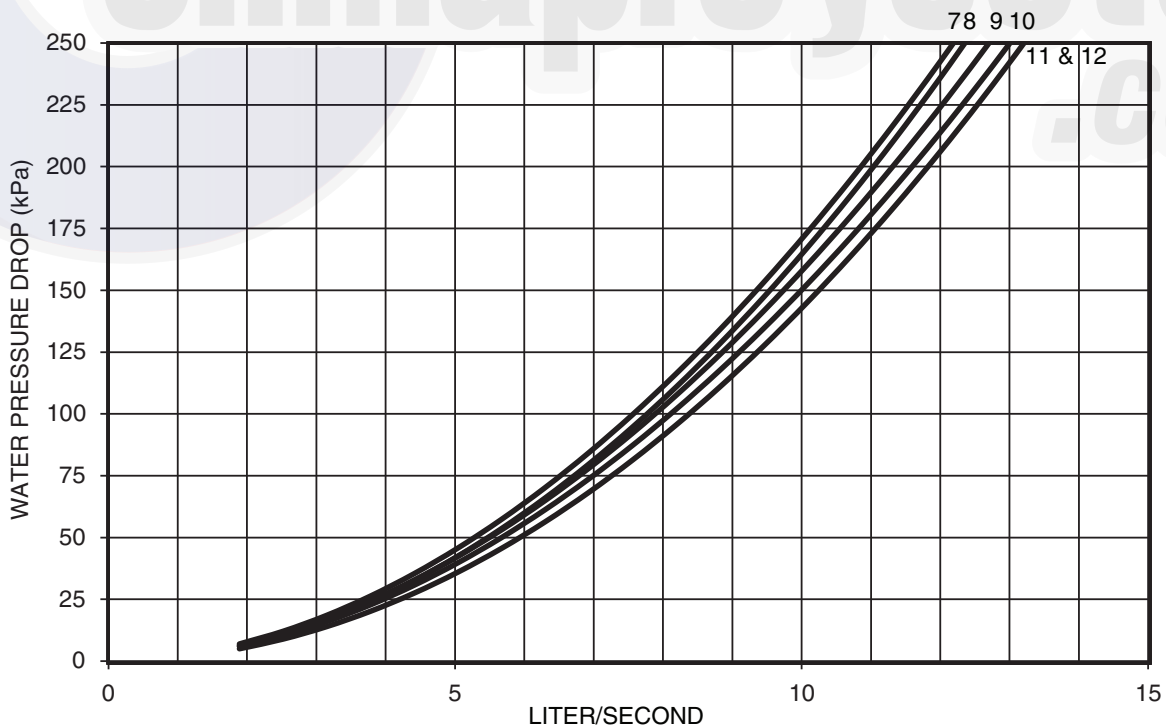

- LEGEND
- 7 — 30RAP035
 - 8 — 30RAP040
 - 9 — 30RAP045
 - 10 — 30RAP050
 - 11 — 30RAP055
 - 12 — 30RAP060

UNIT PRESSURE DROP — DUAL PUMP HYDRONIC PACKAGE, 60 Hz ONLY — 30RAP070-090 (SI)

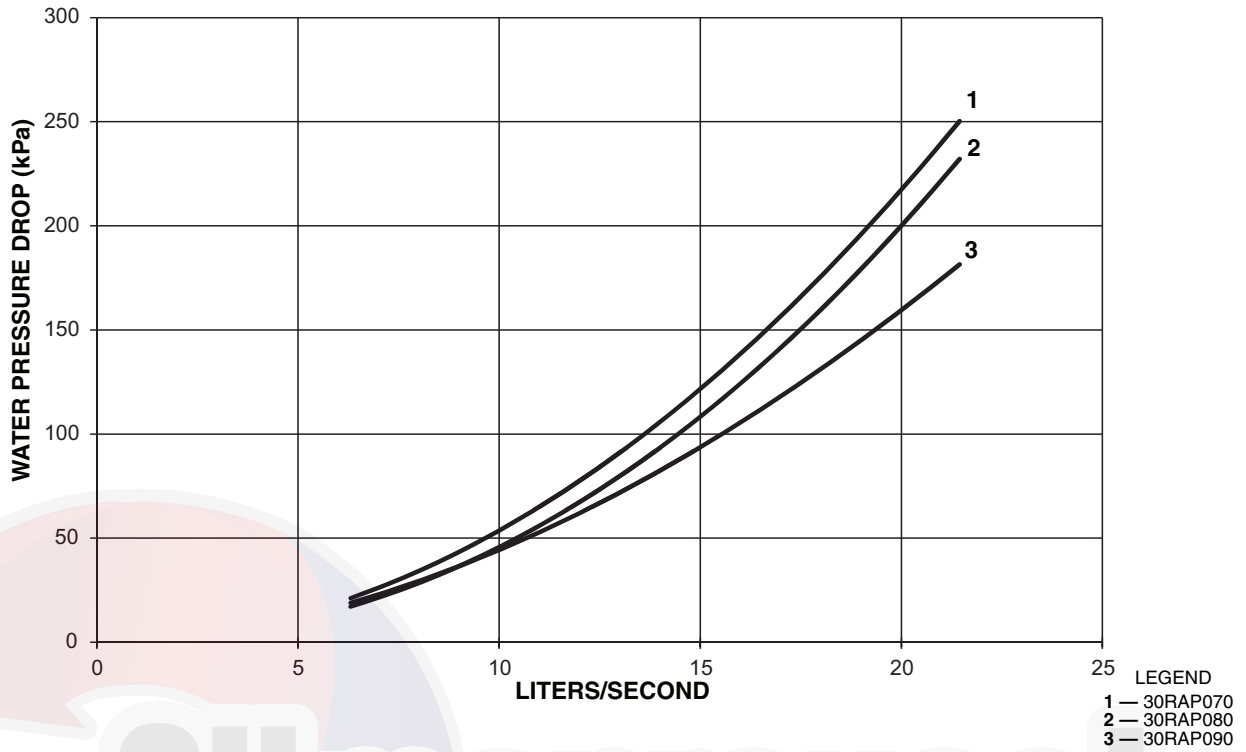

UNIT PRESSURE DROP — DUAL PUMP HYDRONIC PACKAGE, 60 Hz ONLY — 30RAP100-150 (SI)

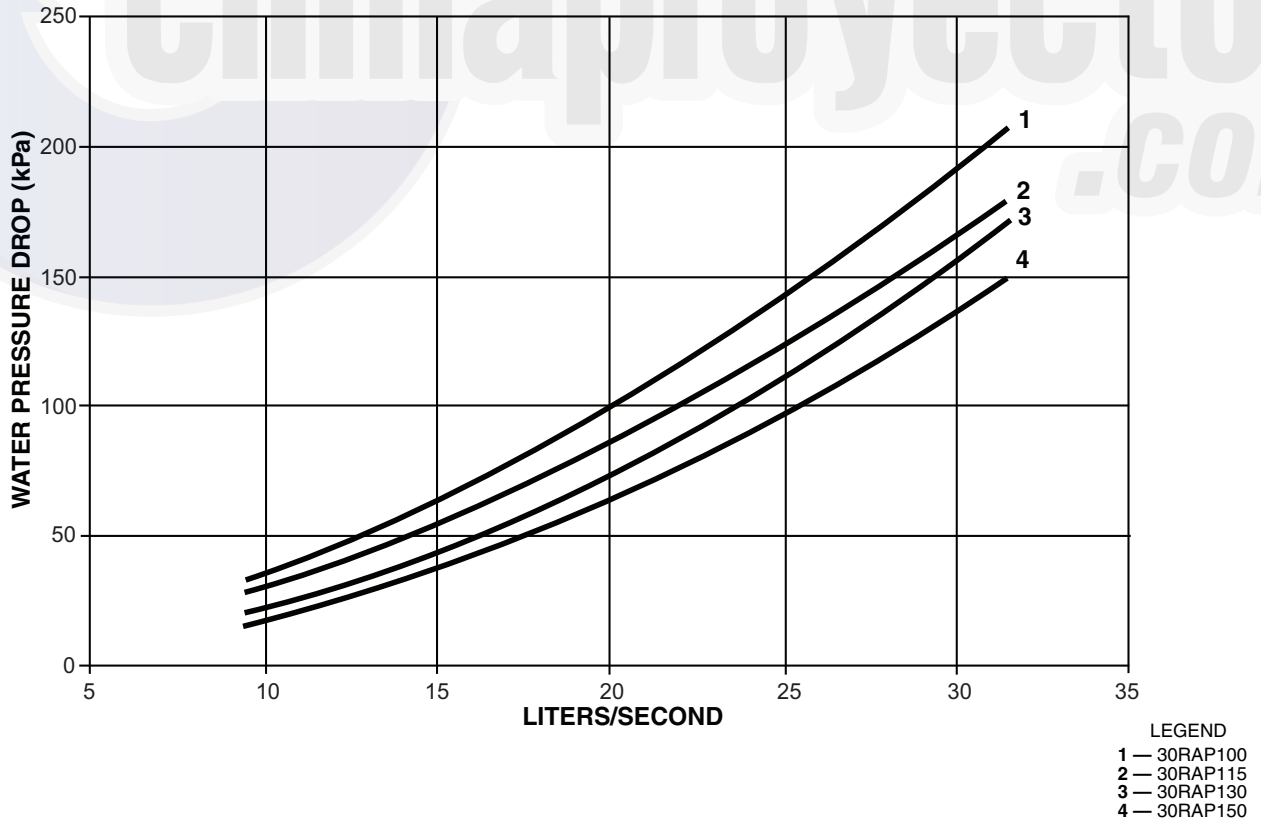

PUMP CURVE I FOR HYDRONIC PACKAGE, 60 Hz ONLY — SINGLE PUMP 1.5 Hp, DUAL PUMP 1.5 Hp, SINGLE PUMP 3.0 Hp, DUAL PUMP 3.0 Hp, SINGLE PUMP HIGH HEAD 3.0 Hp, DUAL PUMP HIGH HEAD 3.0 Hp — 30RAP011-060 UNITS

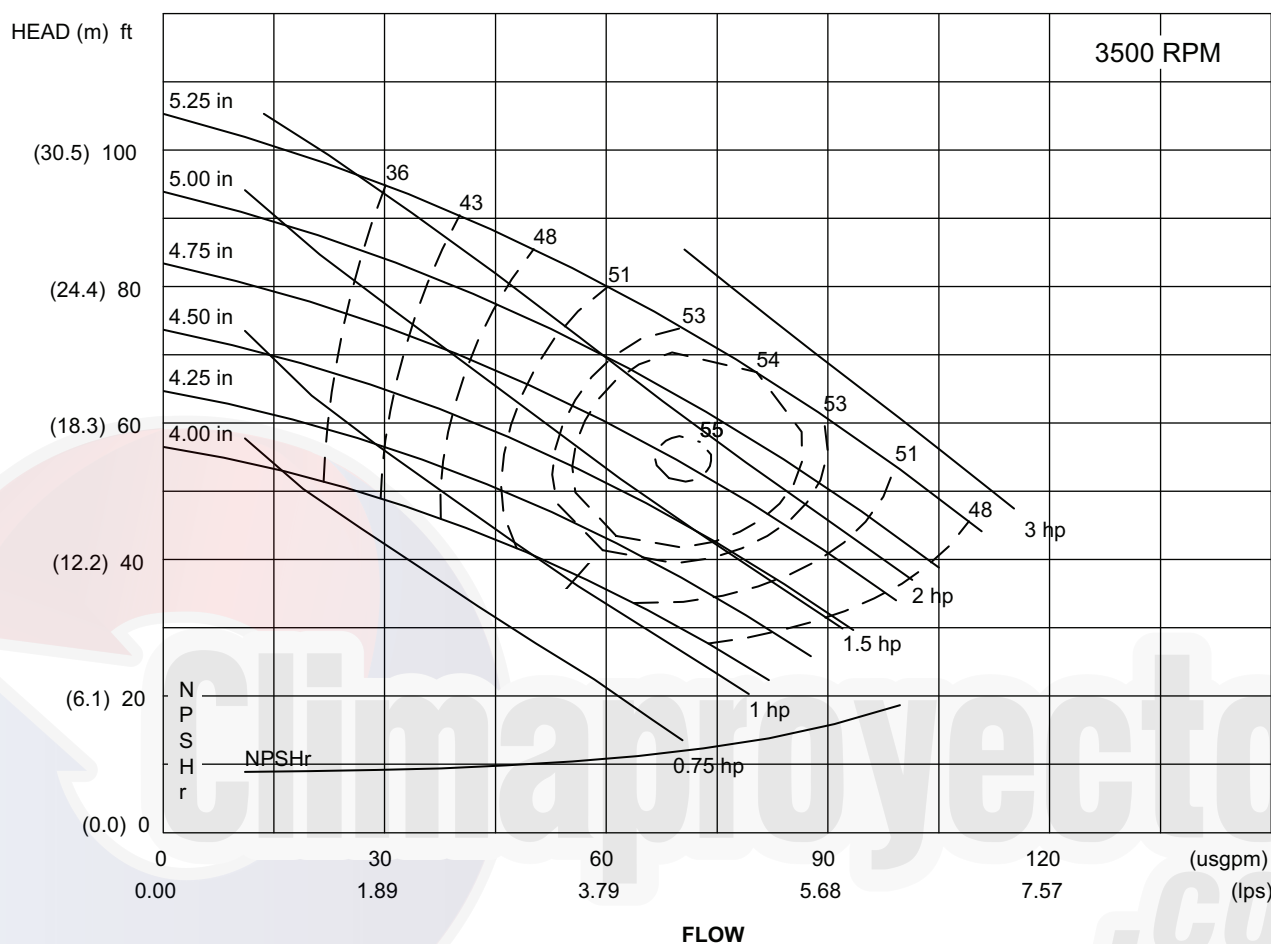

water, specific gravity = 1.00

LEGEND

NPSHr — Net Pump Suction Head Required

NOTE: Refer to the Pump Impeller Sizes chart on page 33 for proper unit size matching as well as the determination of the impeller diameter.

Performance data (cont)



**PUMP CURVE II FOR HYDRONIC PACKAGE, 60 Hz ONLY — SINGLE PUMP 5.0 Hp,
DUAL PUMP 5.0 Hp — 30RAP011-030 UNITS**

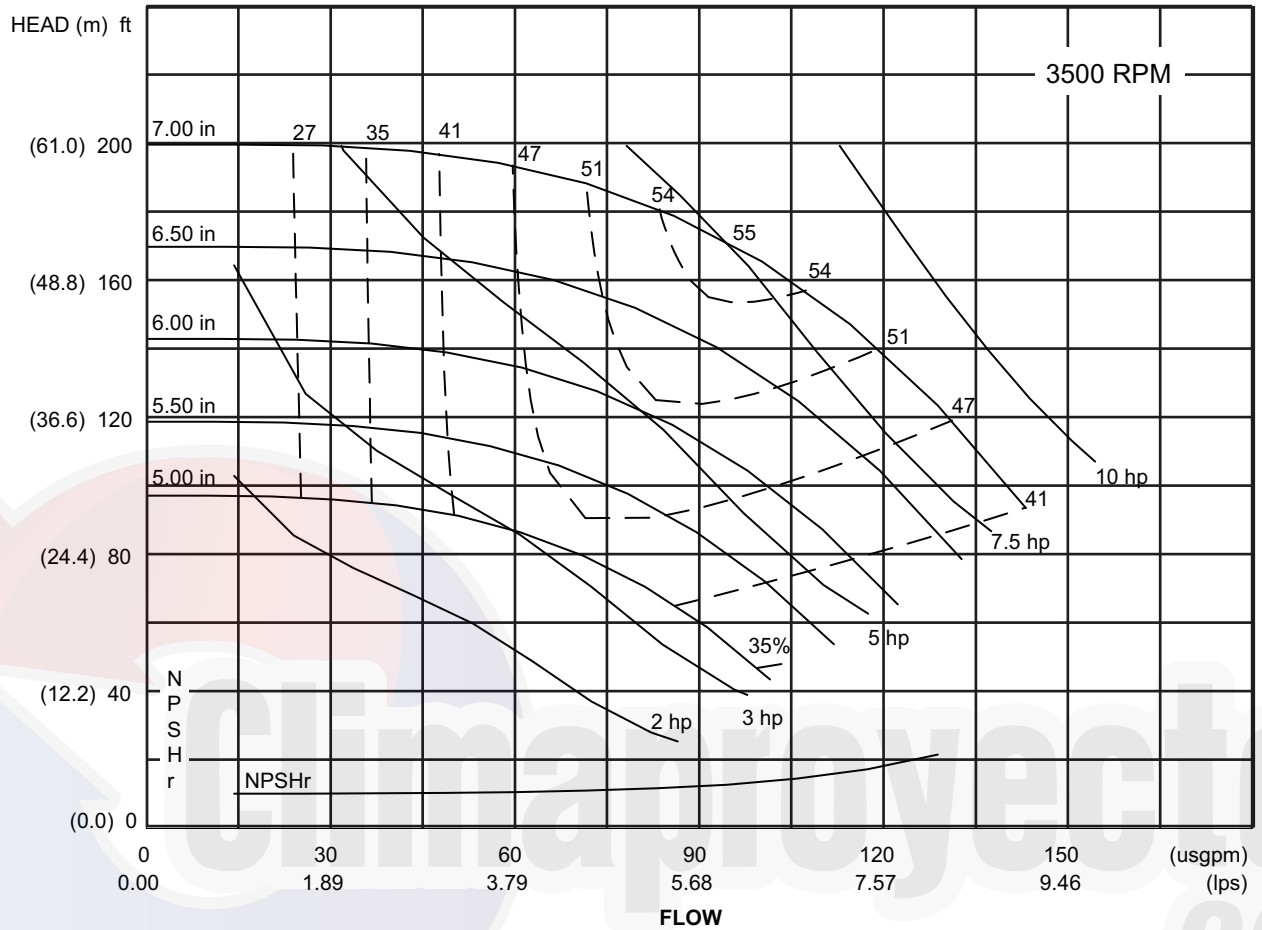

water, specific gravity = 1.00

LEGEND

NPSHr — Net Pump Suction Head Required

NOTE: Refer to the Pump Impeller Sizes chart on page 33 for proper unit size matching as well as the determination of the impeller diameter.

PUMP CURVE III FOR HYDRONIC PACKAGE, 60 Hz ONLY — SINGLE PUMP 5.0 Hp, DUAL PUMP 5.0 Hp, SINGLE PUMP HIGH HEAD 5.0 Hp, DUAL PUMP HIGH HEAD 5.0 Hp — 30RAP035-060 UNITS

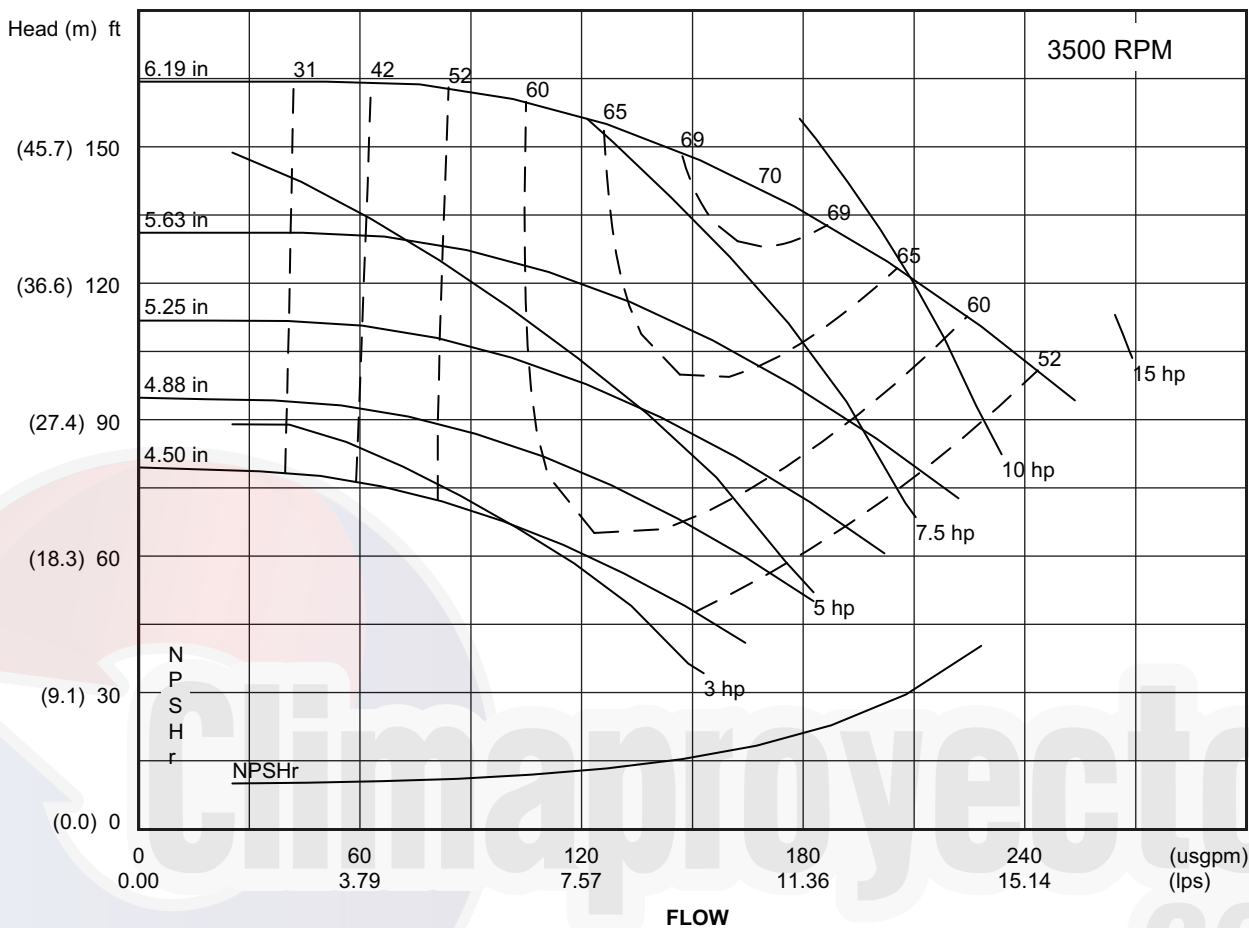

water, specific gravity = 1.00

LEGEND

NPSHr — Net Pump Suction Head Required

NOTE: Refer to the Pump Impeller Sizes chart on page 33 for proper unit size matching as well as the determination of the impeller diameter.

Performance data (cont)



PUMP CURVE IV FOR HYDRONIC PACKAGE, 60 Hz ONLY — SINGLE PUMP 7.5 Hp, DUAL PUMP 7.5 Hp, SINGLE PUMP 10.0 Hp, DUAL PUMP 10.0 Hp — 30RAP035-060 UNITS

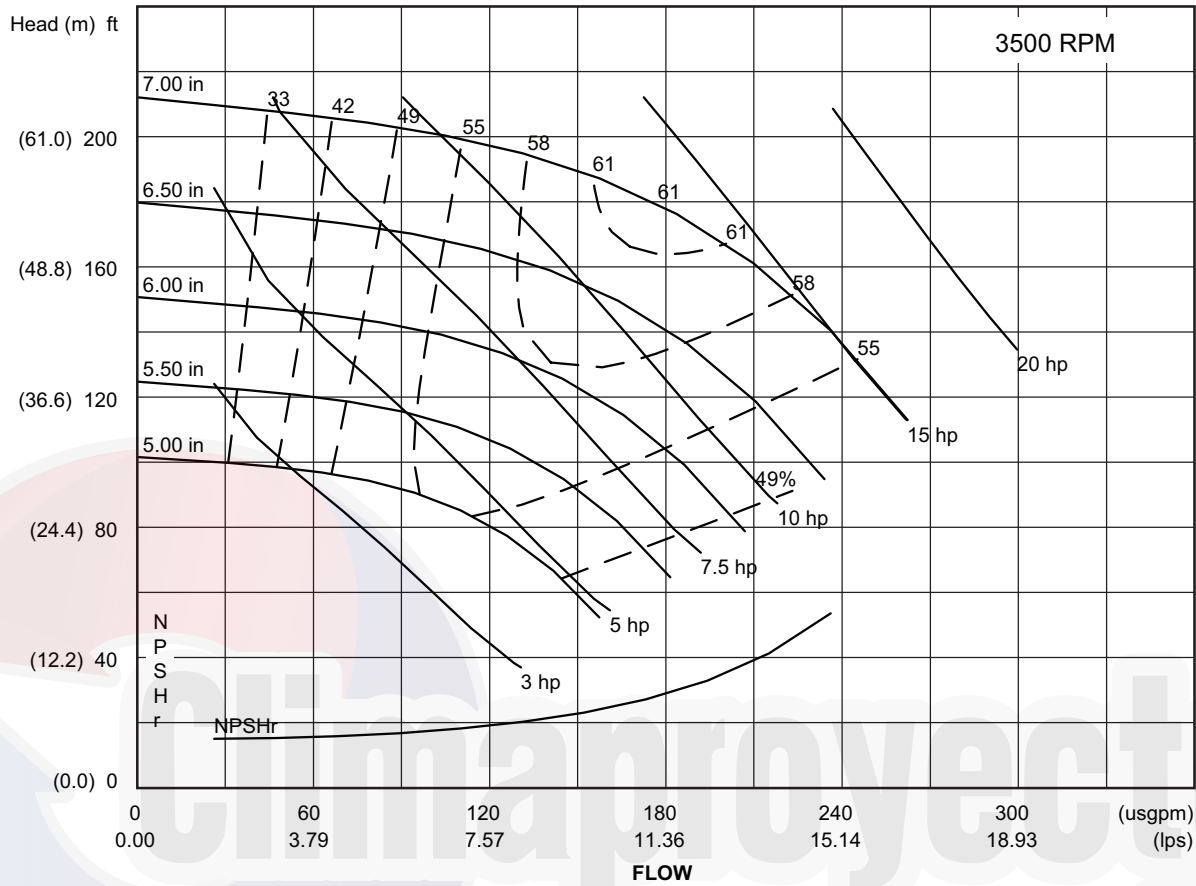

water, specific gravity = 1.00

LEGEND

NPSHr — Net Pump Suction Head Required

NOTE: Refer to the Pump Impeller Sizes chart on page 33 for proper unit size matching as well as the determination of the impeller diameter.

PUMP CURVE VI FOR HYDRONIC PACKAGE, 60 Hz ONLY — SINGLE PUMP 7.5 Hp, SINGLE PUMP 10 Hp, SINGLE PUMP 15 Hp — 30RAP070-100 UNITS

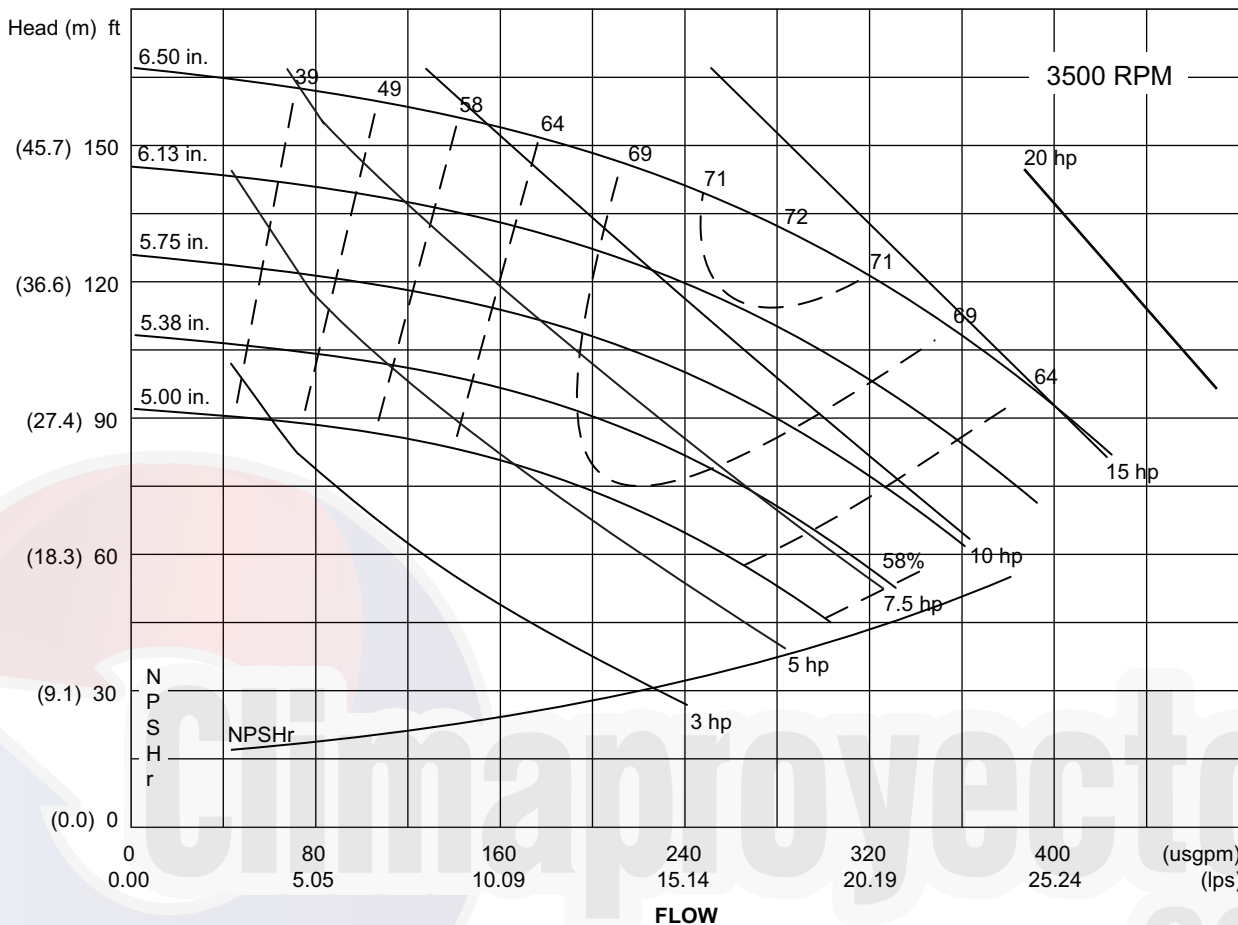

water, specific gravity = 1.00

LEGEND

NPSHr — Net Pump Suction Head Required

NOTE: Refer to the Pump Impeller Sizes chart on page 33 for proper unit size matching as well as the determination of the impeller diameter.

Performance data (cont)



PUMP CURVE VIII FOR HYDRONIC PACKAGE, 60 Hz ONLY — DUAL PUMP 5 Hp, DUAL PUMP 7.5 Hp, DUAL PUMP 10 Hp, DUAL PUMP 15 Hp — 30RAP070-150 UNITS

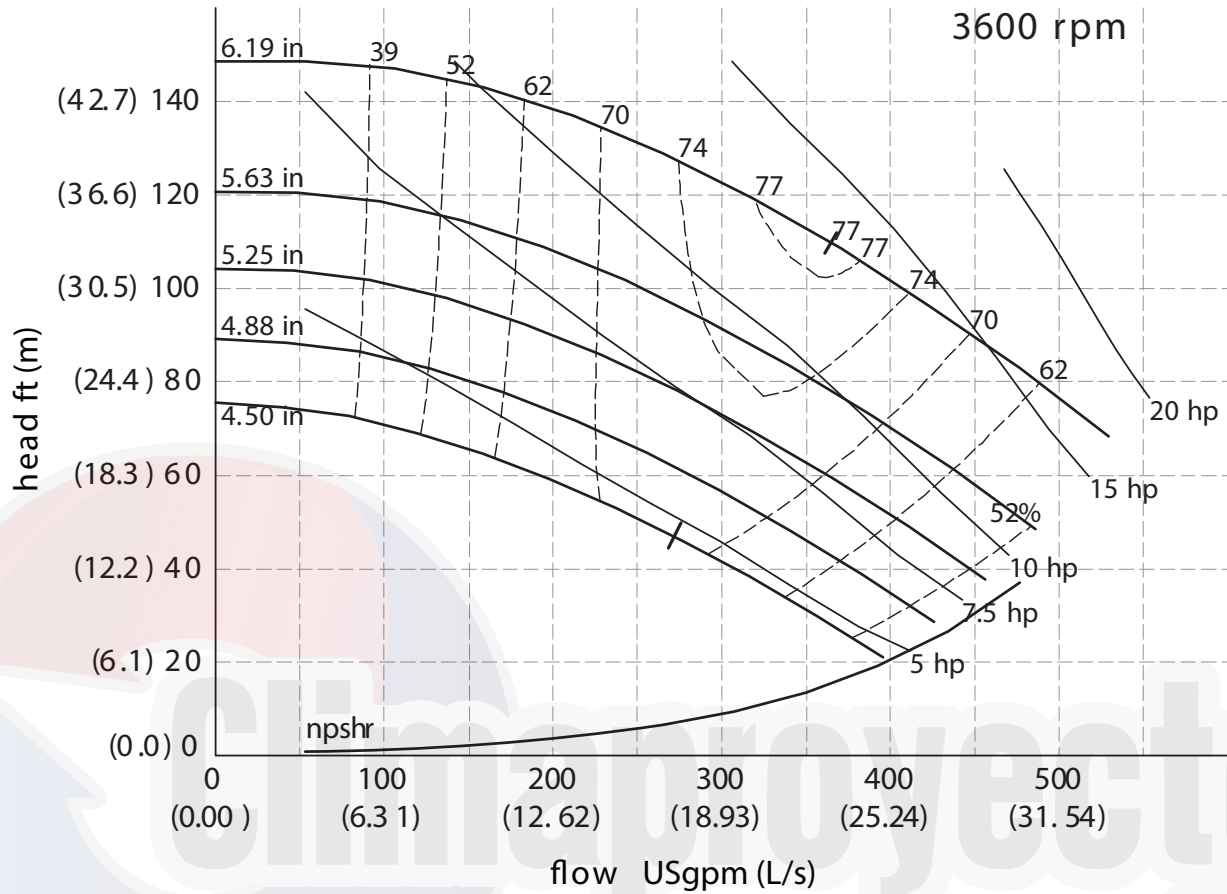

water, specific gravity = 1.00

LEGEND

NPSHr — Net Pump Suction Head Required

NOTE: Refer to the Pump Impeller Sizes chart on page 33 for proper unit size matching as well as the determination of the impeller diameter.

**PUMP CURVE IX FOR HYDRONIC PACKAGE, 60 Hz ONLY — DUAL PUMP 7.5 Hp,
DUAL PUMP 10 Hp — 30RAP070 UNITS**

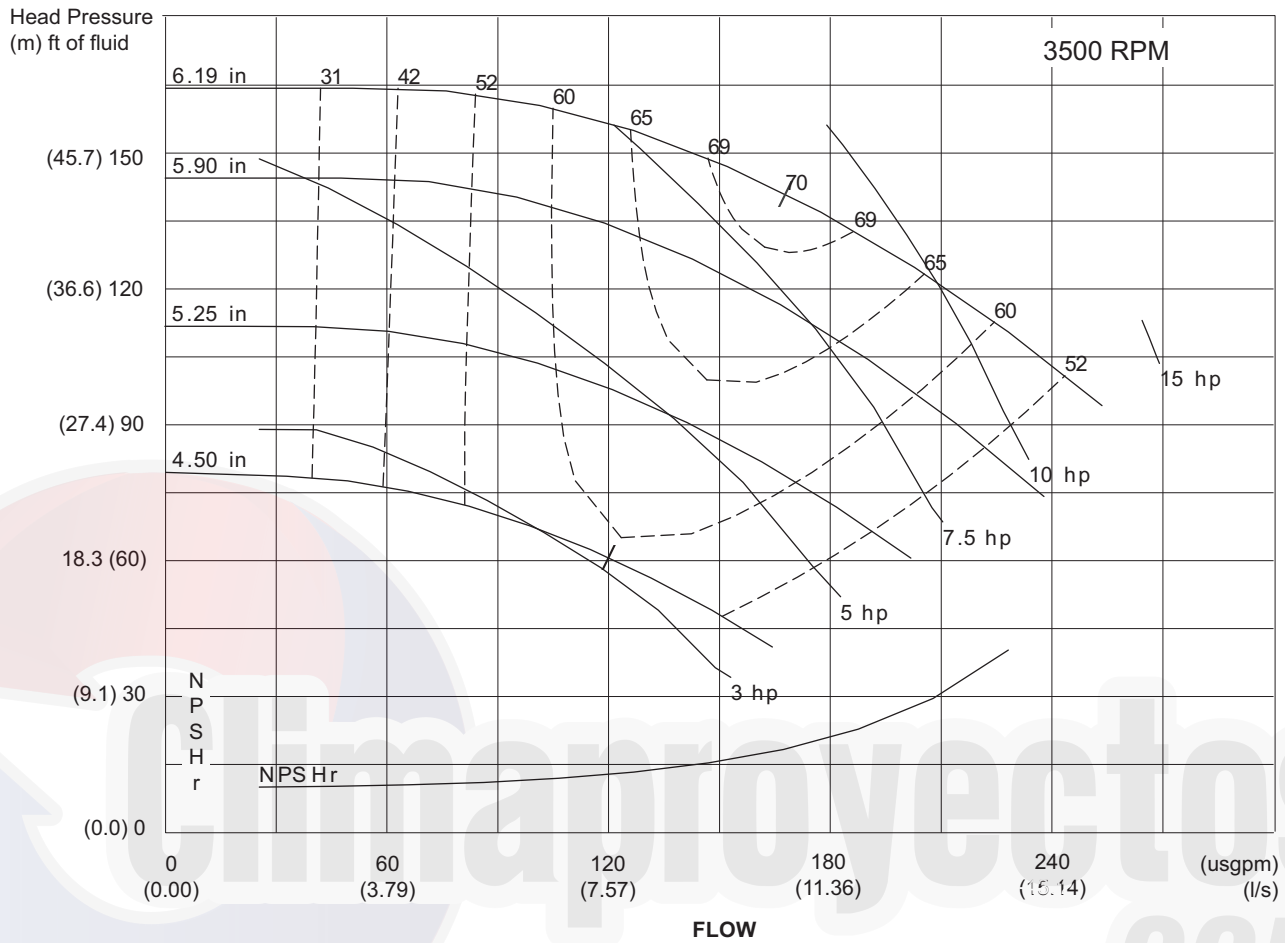

water, specific gravity = 1.00

LEGEND

NPSHr — Net Pump Suction Head Required

NOTE: Refer to the Pump Impeller Sizes chart on page 33 for proper unit size matching as well as the determination of the impeller diameter.

Performance data (cont)



PUMP CURVE X FOR HYDRONIC PACKAGE, 60 Hz ONLY — SINGLE PUMP 5 HP, SINGLE PUMP 7.5 HP, SINGLE PUMP 10 HP, SINGLE PUMP 15 HP — 30RAP115,130 UNITS

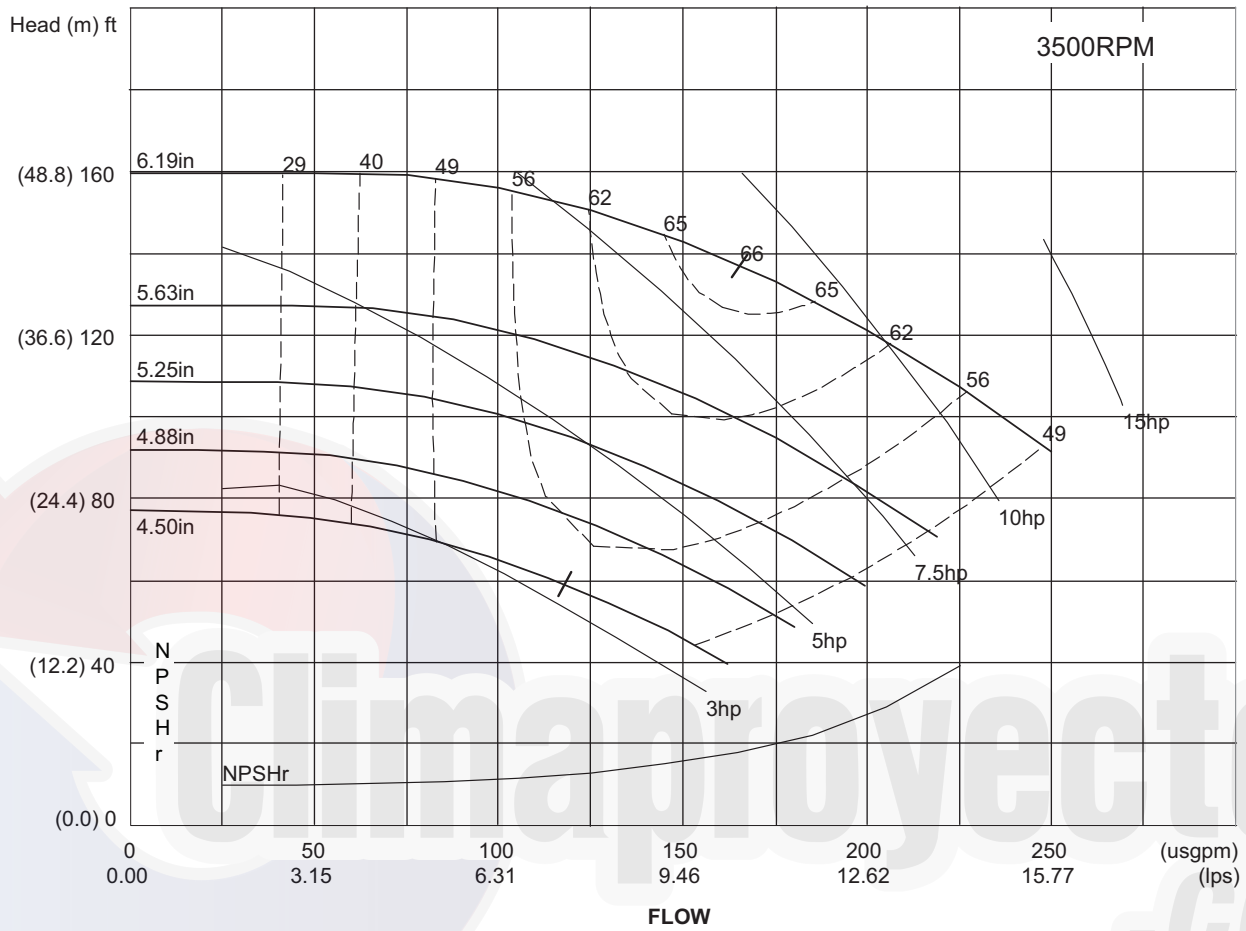

water, specific gravity = 1.00

LEGEND

NPSHr — Net Pump Suction Head Required

NOTE: Refer to the Pump Impeller Sizes chart on page 33 for proper unit size matching as well as the determination of the impeller diameter.

PUMP CURVE XI FOR HYDRONIC PACKAGE, 60 Hz ONLY — SINGLE PUMP 5 HP, SINGLE PUMP 7.5 HP — 30RAP150 UNIT

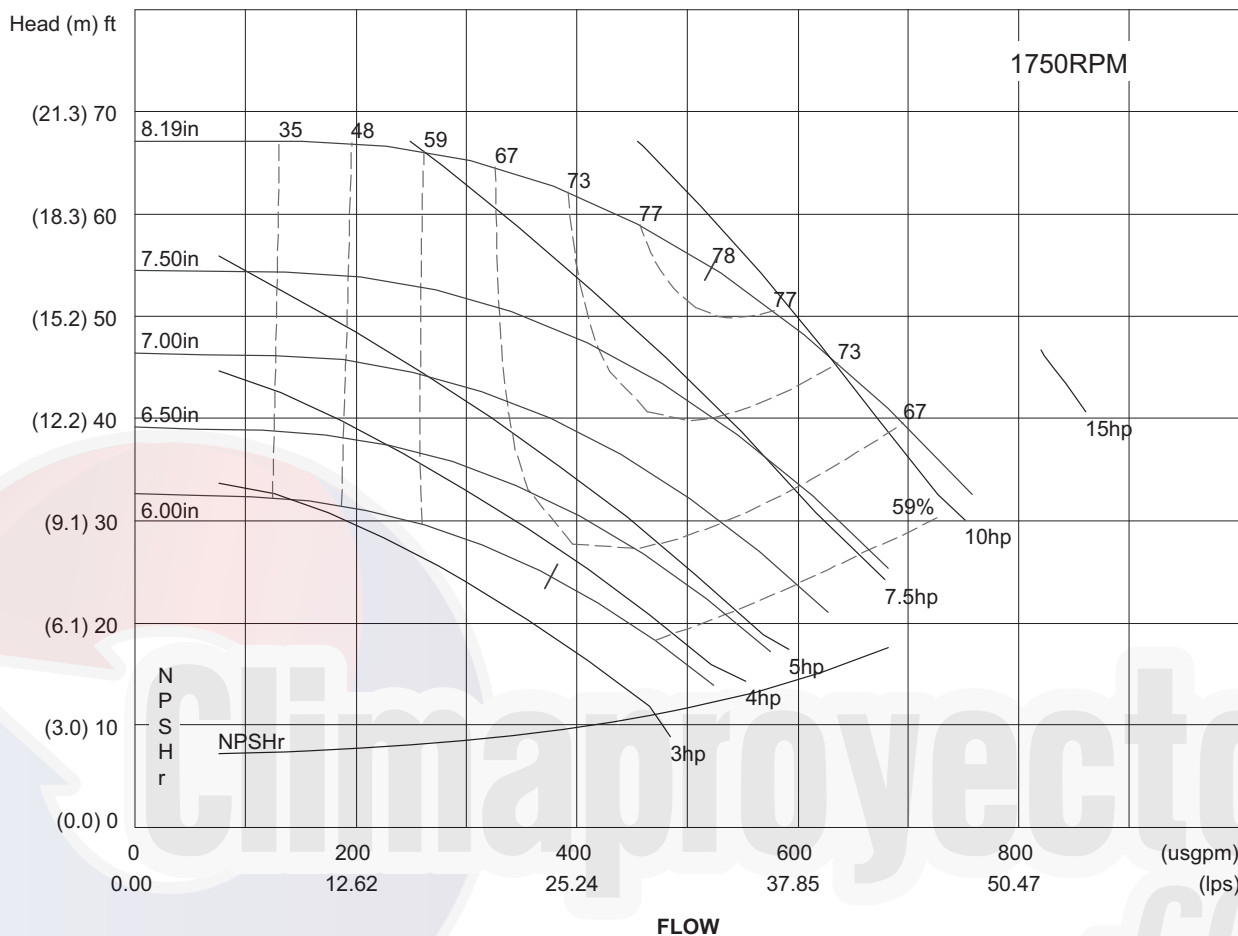

water, specific gravity = 1.00

LEGEND

NPSHr — Net Pump Suction Head Required

NOTE: Refer to the Pump Impeller Sizes chart on page 33 for proper unit size matching as well as the determination of the impeller diameter.

Performance data (cont)



**PUMP CURVE XII FOR HYDRONIC PACKAGE, 60 Hz ONLY — SINGLE PUMP 10 HP,
SINGLE PUMP 15 HP — 30RAP150 UNIT**

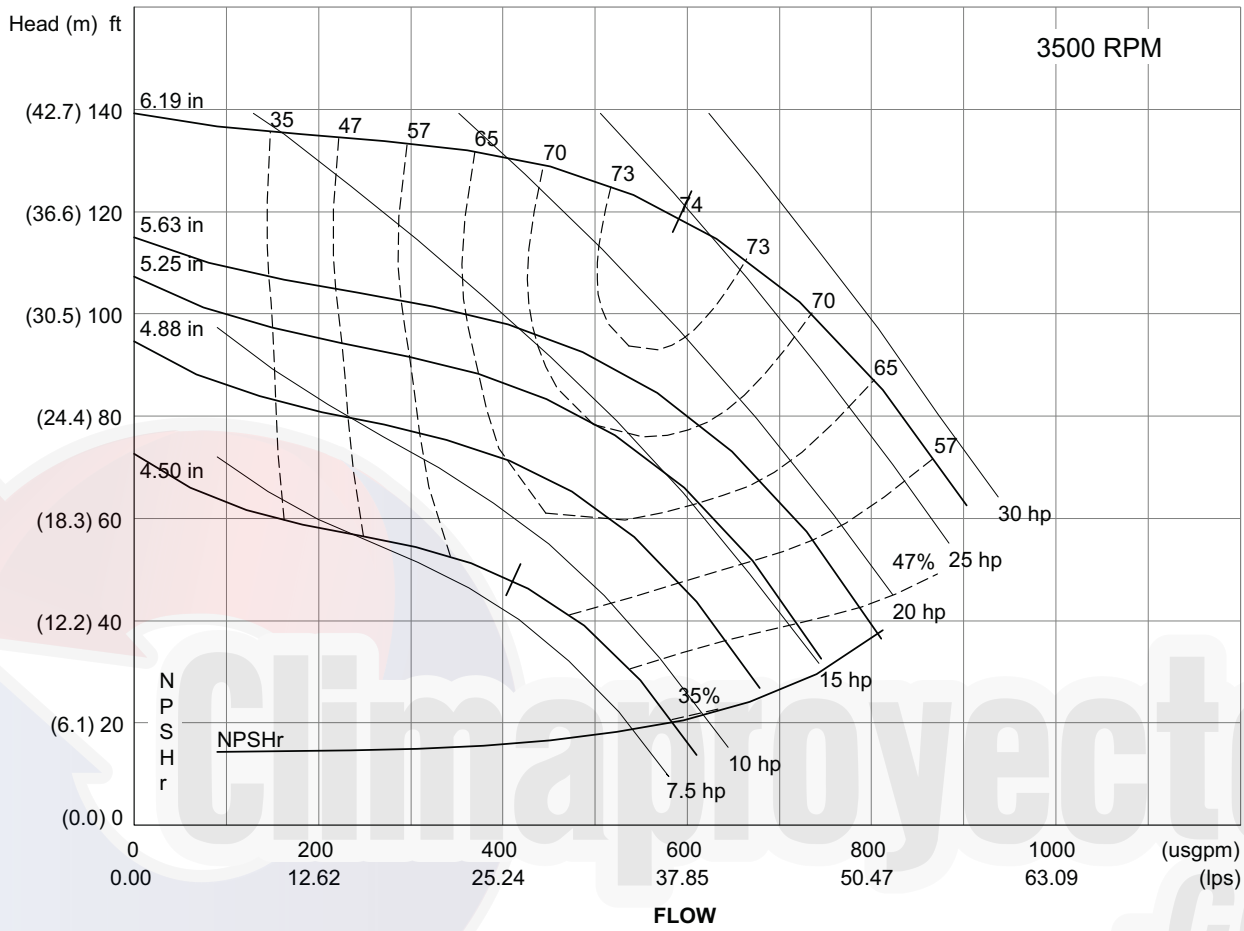

water, specific gravity = 1.00

LEGEND

NPSHr — Net Pump Suction Head Required

NOTE: Refer to the Pump Impeller Sizes chart on page 33 for proper unit size matching as well as the determination of the impeller diameter.

STORAGE TANK PRESSURE DROP CURVES

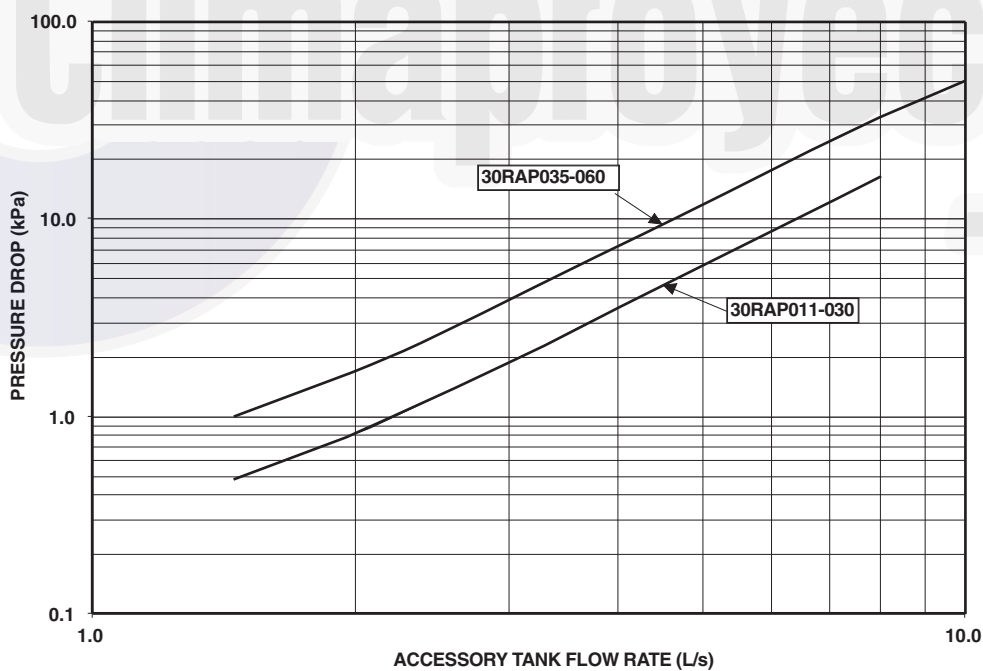
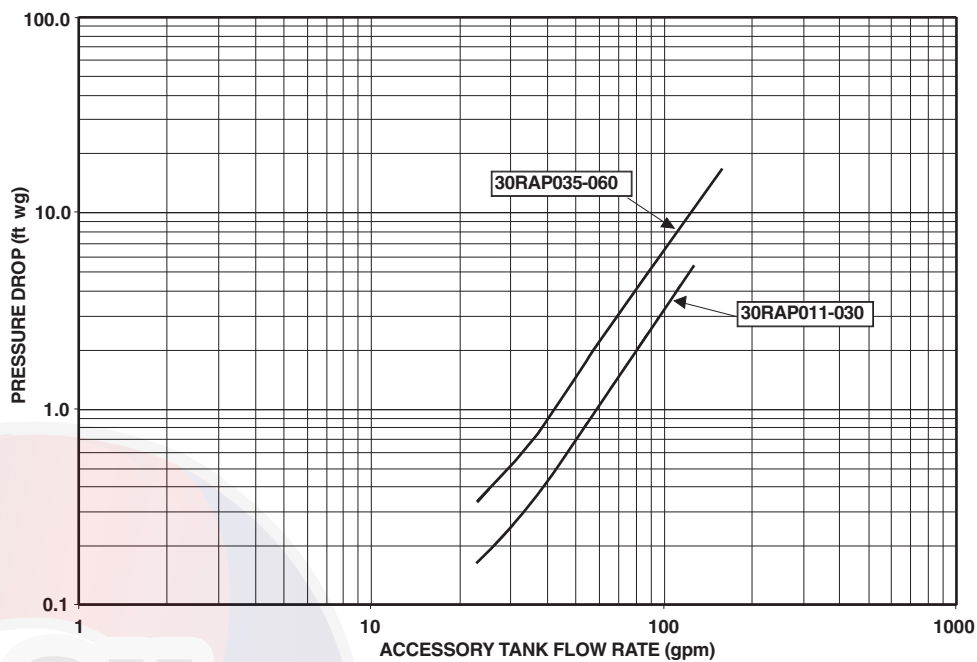

30RAP UNITS WITHOUT HYDRONIC PACKAGE (SIZE 030 SHOWN)

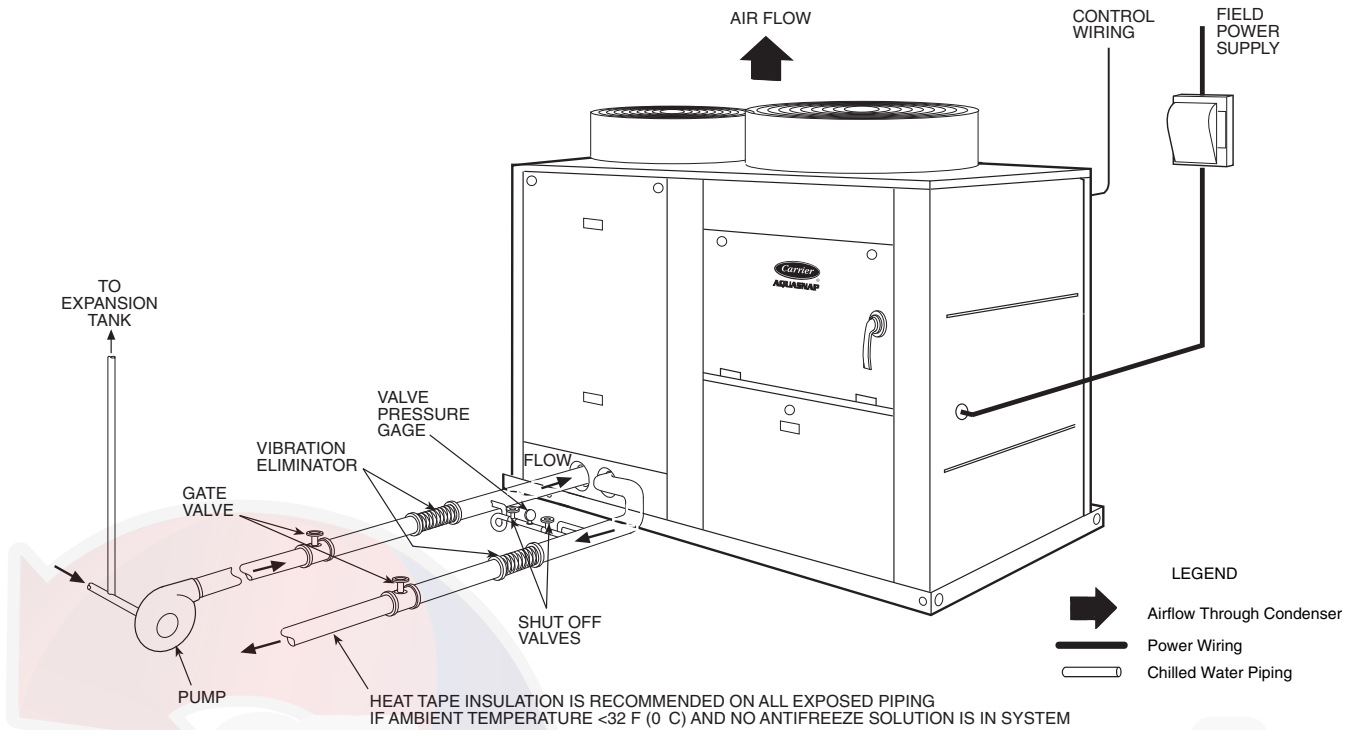

NOTES:

1. Chiller must be installed level to within $\frac{1}{8}$ in. per foot (10.4 mm per meter) to maintain proper compressor oil return and hydraulics.
2. Wiring and piping shown are general points-of-connection guides only and are not intended for a specific installation. Wiring and piping shown are for a quick overview of system and are not in accordance with recognized standards.
3. All wiring must comply with applicable local and national codes.
4. All piping must follow standard piping techniques. Refer to Carrier System Design Manual or appropriate ASHRAE (American Society of Heating, Refrigerating, and Air-Conditioning Engineers) handbook for details.

30RAP UNITS WITH HYDRONIC PACKAGE (SIZE 030 SHOWN)

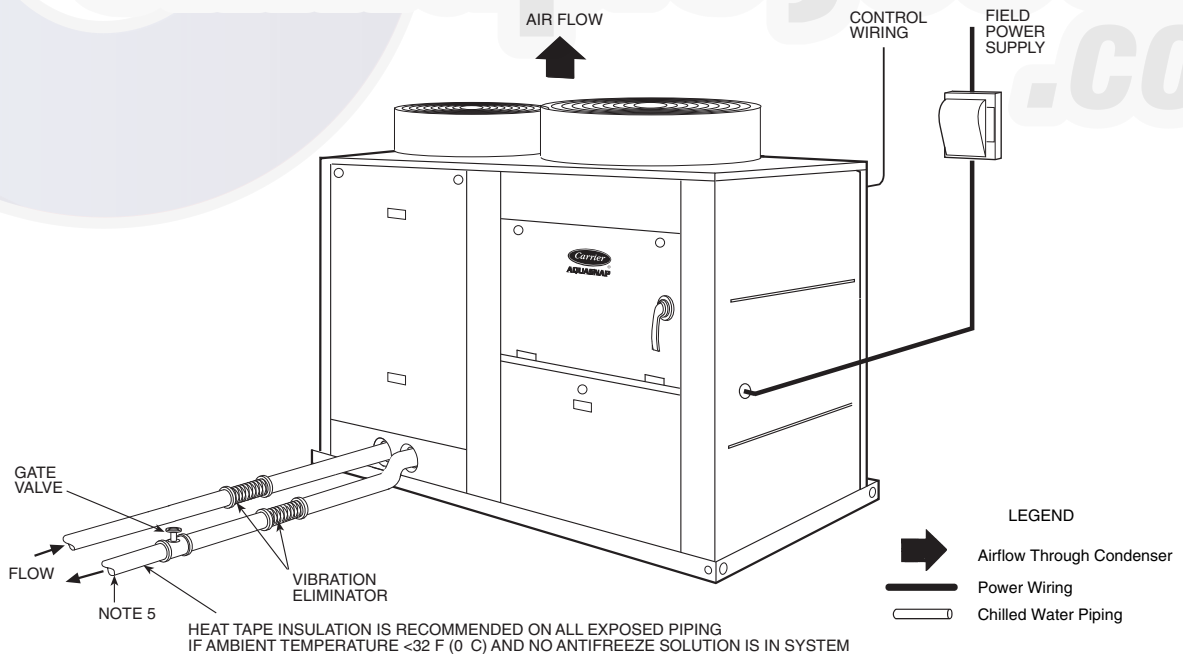

NOTES:

1. Chiller must be installed level to within $\frac{1}{8}$ in. per foot (10.4 mm per meter) to maintain proper compressor oil return and hydraulics.
2. Wiring and piping shown are general points-of-connection guides only and are not intended for a specific installation. Wiring and piping shown are for a quick overview of system and are not in accordance with recognized standards.
3. All wiring must comply with applicable local and national codes.
4. All piping must follow standard piping techniques. Refer to Carrier System Design Manual or appropriate ASHRAE (American Society of Heating, Refrigerating, and Air-Conditioning Engineers) handbook for details.
5. Air separator required as close to chiller as possible (except primary/secondary systems).

30RAP UNITS WITHOUT HYDRONIC PACKAGE (SIZE 060 SHOWN)

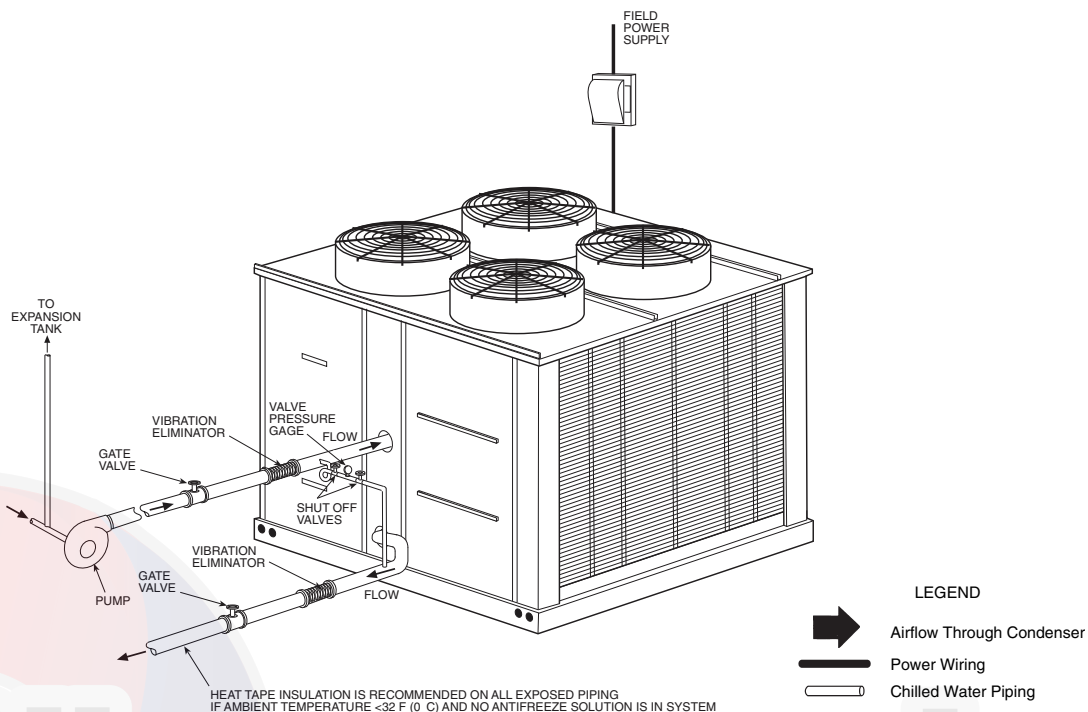

NOTES:

1. Chiller must be installed level to within 1/8 in. per foot (10.4 mm per meter) to maintain proper compressor oil return and hydraulics.
2. Wiring and piping shown are general points-of-connection guides only and are not intended for a specific installation. Wiring and piping shown are for a quick overview of system and are not in accordance with recognized standards.
3. All wiring must comply with applicable local and national codes.
4. All piping must follow standard piping techniques. Refer to Carrier System Design Manual or appropriate ASHRAE (American Society of Heating, Refrigerating, and Air-Conditioning Engineers) handbook for details.

30RAP UNITS WITH HYDRONIC PACKAGE (SIZE 060 SHOWN)

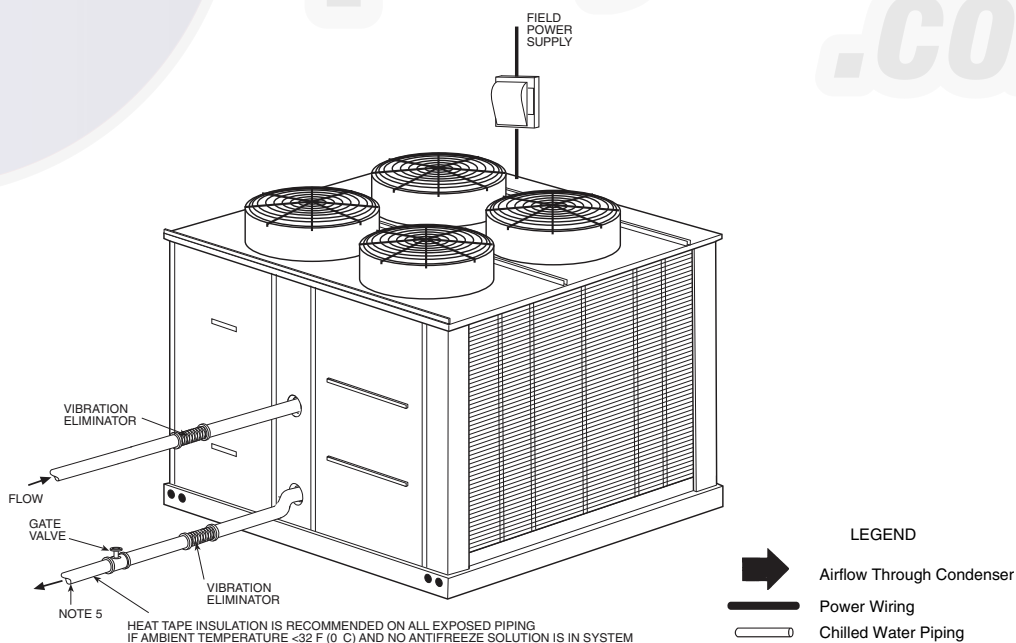

NOTES:

1. Chiller must be installed level to within 1/8 in. per foot (10.4 mm per meter) to maintain proper compressor oil return and hydraulics.
2. Wiring and piping shown are general points-of-connection guides only and are not intended for a specific installation. Wiring and piping shown are for a quick overview of system and are not in accordance with recognized standards.
3. All wiring must comply with applicable local and national codes.
4. All piping must follow standard piping techniques. Refer to Carrier System Design Manual or appropriate ASHRAE (American Society of Heating, Refrigerating, and Air-Conditioning Engineers) handbook for details.
5. Air separator required as close to chiller as possible (except primary/secondary systems).

30RAP UNITS WITHOUT HYDRONIC PACKAGE FOR SIZES 070 AND LARGER (SIZE 070-090 SHOWN)

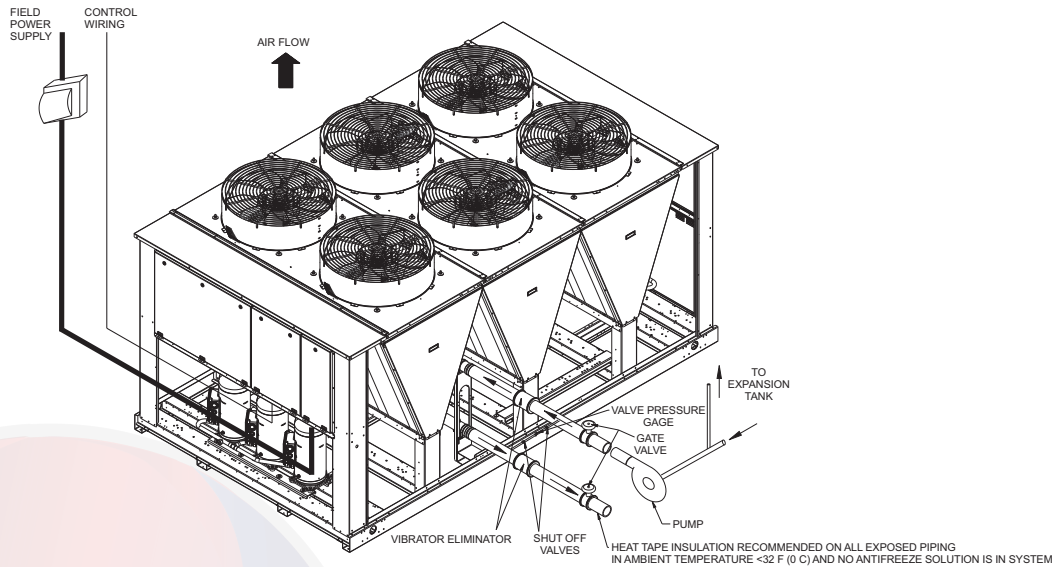

NOTES:

1. Chiller must be installed level to within $\frac{1}{8}$ in. per foot (10.4 mm per meter) to maintain proper compressor oil return and hydraulics.
2. Wiring and piping shown are general points-of-connection guides only and are not intended for a specific installation. Wiring and piping shown are for a quick overview of system and are not in accordance with recognized standards.
3. All wiring must comply with applicable local and national codes.
4. All piping must follow standard piping techniques. Refer to Carrier System Design Manual or appropriate ASHRAE (American Society of Heating, Refrigerating, and Air-Conditioning Engineers) handbook for details.
5. Air separator required as close to chiller as possible (except primary/secondary systems).

LEGEND

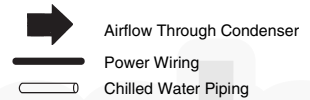

30RAP UNITS WITH HYDRONIC PACKAGE FOR SIZES 070 AND LARGER (SIZE 070-090 SHOWN)

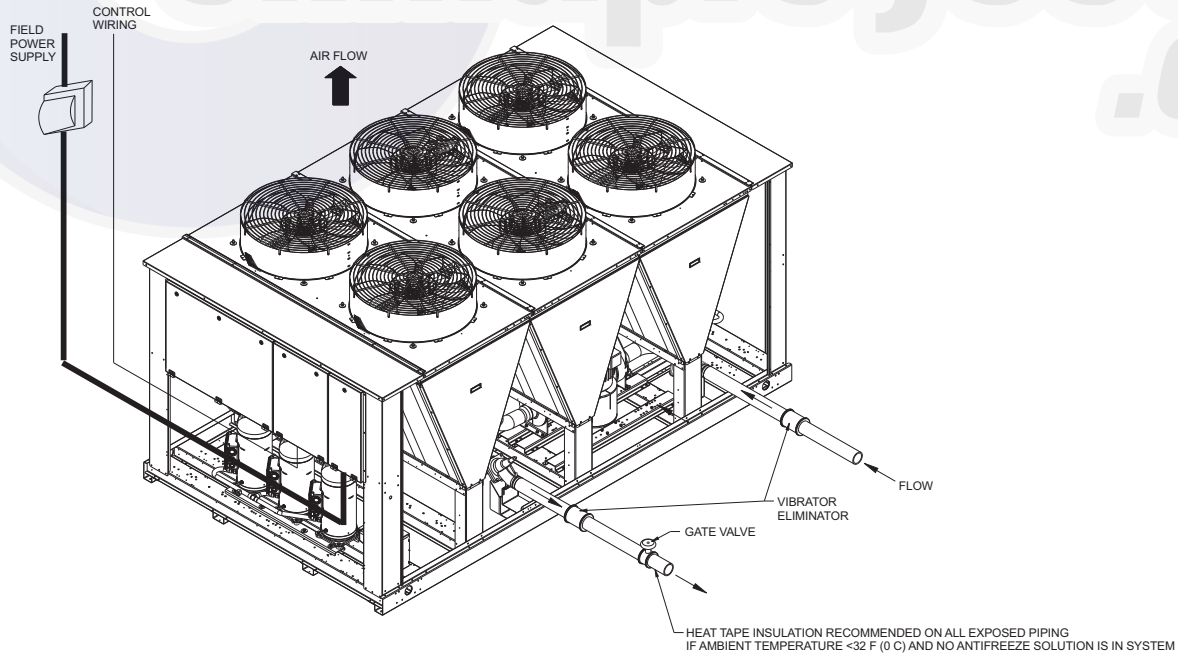

NOTES:

1. Chiller must be installed level to within $\frac{1}{8}$ in. per foot (10.4 mm per meter) to maintain proper compressor oil return and hydraulics.
2. Wiring and piping shown are general points-of-connection guides only and are not intended for a specific installation. Wiring and piping shown are for a quick overview of system and are not in accordance with recognized standards.
3. All wiring must comply with applicable local and national codes.
4. All piping must follow standard piping techniques. Refer to Carrier System Design Manual or appropriate ASHRAE (American Society of Heating, Refrigerating, and Air-Conditioning Engineers) handbook for details.

LEGEND

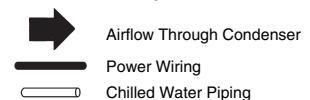

TYPICAL PIPING DIAGRAM ON 30RAP UNITS WITH HYDRONIC PACKAGE

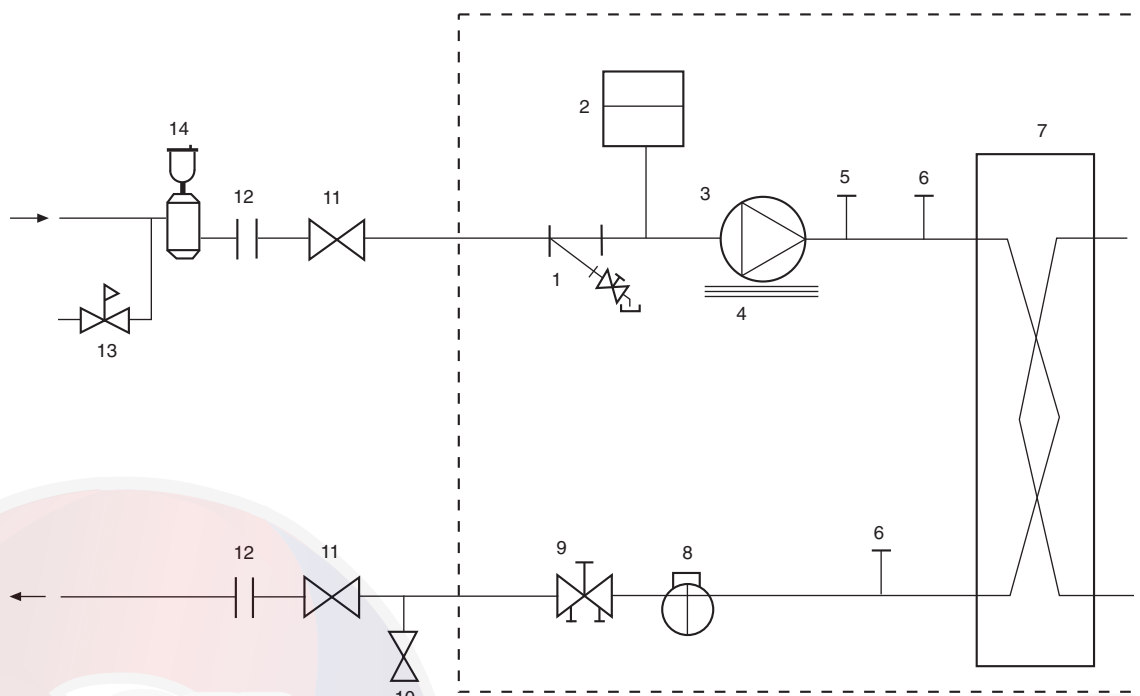

LEGEND

- | | |
|---|-----------------------------------|
| 1 — Strainer (40 Mesh)/Blow-Down Valve | 8 — Flow Switch |
| 2 — Expansion Tank (sizes 011 - 060 only) | 9 — Balance Valve/Drain Plug |
| 3 — Pump | 10 — Pressure Relief |
| 4 — Electric Heater | 11 — Isolation Valves |
| 5 — Air Vent Connection Port | 12 — Flex Connections |
| 6 — Pressure/Temperature Access Port | 13 — Pressure Reducing/Fill Valve |
| 7 — Heat Exchanger | 14 — Air Separator and Vent |
| --- | Factory Supplied |

NOTE: Hydronic packages are not available for 50 Hz applications.

30RAP ELECTRICAL DATA SINGLE POINT NO HYDRONIC PACKAGE, UNIT SIZES 011-060

UNIT 30RAP	UNIT VOLTAGE			POWER SUPPLY QTY REQD.	NO HYDRONIC PACKAGE STANDARD LOW-SOUND AEROACOUSTIC™ FAN				NO HYDRONIC PACKAGE OPTIONAL VALUE SOUND FANS			
	V-Hz (3 Ph)	Supplied			MCA	MOCP	ICF	Rec Fuse Size	MCA	MOCP	ICF	Rec Fuse Size
		Min	Max									
011	208/230-60	187	253	1	51.0	70	186.0	60	51.6	70	186.6	60
	380-60	342	418	1	27.7	35	85.4	35	27.7	35	85.4	35
	380/415-50	342	440	1	24.7	35	85.7	30	25.1	35	86.1	30
	460-60	414	506	1	24.7	35	85.7	30	25.1	35	86.1	30
	575-60	518	633	1	18.0	25	62.1	20	18.2	25	62.3	20
016	208/230-60	187	253	1	64.5	90	269.2	80	65.1	90	269.8	80
	380-60	342	418	1	36.1	50	151.1	40	36.1	50	151.1	40
	380/415-50	342	440	1	32.5	45	144.1	40	32.9	45	144.5	40
	460-60	414	506	1	32.5	45	144.1	40	32.9	45	144.5	40
	575-60	518	633	1	24.4	35	104.0	30	24.6	35	104.2	30
018	208/230-60	187	253	1	87.2	110	270.4	100	88.4	110	271.6	100
	380-60	342	418	1	51.1	70	167.0	60	51.1	70	167.0	60
	380/415-50	342	440	1	43.4	60	136.5	50	44.2	60	137.3	50
	460-60	414	506	1	43.4	60	136.5	50	44.2	60	137.3	50
	575-60	518	633	1	34.9	45	98.2	40	35.3	45	98.6	40
020	208/230-60	187	253	1	92.6	125	286.8	110	93.8	125	288.0	110
	380-60	342	418	1	61.2	80	176.5	70	61.2	80	176.5	70
	380/415-50	342	440	1	46.1	60	148.7	60	46.9	60	149.5	60
	460-60	414	506	1	46.1	60	148.7	60	46.9	60	149.5	60
	575-60	518	633	1	37.0	50	99.1	45	37.4	50	99.5	45
025	208/230-60	187	253	1	127.4	175	363.3	150	128.6	175	364.5	150
	380-60	342	418	1	68.3	90	173.7	80	68.3	90	173.7	80
	380/415-50	342	440	1	57.8	80	178.9	70	58.6	80	179.7	70
	460-60	414	506	1	57.8	80	178.9	70	58.6	80	179.7	70
	575-60	518	633	1	49.6	60	133.7	60	50.0	60	134.1	60
030	208/230-60	187	253	1	137.6	175	407.8	175	138.8	175	409.0	175
	380-60	342	418	1	84.3	110	237.8	100	84.3	110	237.8	100
	380/415-50	342	440	1	66.3	90	211.7	80	67.1	90	212.5	80
	460-60	414	506	1	66.3	90	211.7	80	67.1	90	212.5	80
	575-60	518	633	1	58.1	80	160.5	70	58.5	80	160.9	70
035	208/230-60	187	253	1	165.4	200	359.6	175	167.2	200	361.4	200
	380-60	342	418	1	103.5	125	218.9	110	103.5	125	218.9	110
	380/415-50	342	440	1	82.4	100	185.0	90	83.6	100	186.2	90
	460-60	414	506	1	82.4	100	185.0	90	83.6	100	186.2	90
	575-60	518	633	1	66.1	80	128.2	70	66.7	80	128.8	80
040	208/230-60	187	253	1	197.8	225	395.0	225	199.6	225	396.8	225
	380-60	342	418	1	112.5	125	227.8	125	112.5	125	227.8	125
	380/415-50	342	440	1	86.4	100	188.8	100	87.6	100	190.0	100
	460-60	414	506	1	86.4	100	188.8	100	87.6	100	190.0	100
	575-60	518	633	1	68.9	80	150.9	80	69.5	80	151.5	80
045	208/230-60	187	253	1	229.6	250	468.7	250	231.4	250	470.5	250
	380-60	342	418	1	119.6	125	228.2	125	119.6	125	228.8	125
	380/415-50	342	440	1	97.9	110	223.5	110	99.1	110	224.7	110
	460-60	414	506	1	97.9	110	223.5	110	99.1	110	224.7	110
	575-60	518	633	1	81.4	100	170.7	90	82.0	100	171.3	90
050	208/230-60	187	253	1	236.0	250	471.9	250	237.8	250	473.7	250
	380-60	342	418	1	126.0	150	231.4	150	126.0	150	231.4	150
	380/415-50	342	440	1	106.9	125	228.0	125	108.1	125	229.2	125
	460-60	414	506	1	106.9	125	228.0	125	108.1	125	229.2	125
	575-60	518	633	1	91.8	110	175.9	100	92.4	110	176.5	100
055	208/230-60	187	253	1	252.2	300	526.9	300	254.6	300	529.3	300
	380-60	342	418	1	145.9	175	306.5	175	145.9	175	306.5	175
	380/415-50	342	440	1	118.3	125	267.5	125	119.9	125	269.1	125
	460-60	414	506	1	118.3	125	267.5	125	119.9	125	269.1	125
	575-60	518	633	1	102.7	125	208.9	110	103.5	125	209.7	110
060	208/230-60	187	253	1	261.2	300	531.4	300	263.6	300	533.8	300
	380-60	342	418	1	160.1	175	313.6	175	160.1	175	313.6	175
	380/415-50	342	440	1	125.9	150	271.3	150	127.5	150	272.9	150
	460-60	414	506	1	125.9	150	271.3	150	127.5	150	272.9	150
	575-60	518	633	1	110.3	125	212.7	125	111.1	125	213.5	125

LEGEND

ICF — Instantaneous Current Flow
MCA — Minimum Circuit Amps
MOCP — Maximum Overcurrent Protection

NOTES:

- Units are suitable for use on electrical systems where voltage supplied to the unit terminals is not below or above the listed minimum and maximum limits. Maximum allowable phase imbalance is: voltage 2%; amps 10%.
- All units/modules have single point primary power connection. (Each unit/module requires its own power supply.) Main power must be supplied from a field-supplied disconnect.
- Cooler heater is wired into the control circuit so it is always operable as long as the power supply disconnect and heater safety device are on.

- Power draw control circuits include both crankcase heaters and cooler heaters (where used). Each compressor on sizes 070-090 has a crankcase heater which draws 90 watts of power at 60 Hz or 68 watts of power at 50 Hz, while each compressor on sizes 100-150 has a crankcase heater which draws 56 watts of power at 60 Hz or 42 watts of power at 50 Hz.

- 30RAP chillers with Greenspeed® intelligence are not available on unit sizes 070-150.



30RAP ELECTRICAL DATA (cont)
SINGLE POINT NO HYDRONIC PACKAGE, UNIT SIZES 070-150

UNIT 30RAP	UNIT VOLTAGE			POWER SUPPLY QTY REQD.	NO HYDRONIC PACKAGE STANDARD LOW-SOUND AEROACOUSTIC™ FAN				NO HYDRONIC PACKAGE OPTIONAL VALUE SOUND FANS			
	V-Hz (3 Ph)	Supplied			MCA	MOCP	ICF	Rec Fuse Size	MCA	MOCP	ICF	Rec Fuse Size
		Min	Max									
070	208/230-60	187	254	1	323.0	350	593.2	350	326.0	350	596.2	350
	380-60	342	418	1	198.0	225	351.5	225	198.0	225	351.5	225
	380/415-50	342	440	1	155.7	175	301.1	175	157.7	175	303.1	175
	460-60	414	506	1	155.7	175	301.1	175	157.7	175	303.1	175
	575-60	518	633	1	136.4	150	238.8	150	137.4	150	239.8	150
080	208/230-60	187	254	1	371.3	400	641.5	400	374.9	400	645.1	400
	380-60	342	418	1	214.6	225	368.1	225	214.6	225	368.1	225
	380/415-50	342	440	1	174.1	200	319.5	200	176.5	200	321.9	200
	460-60	414	506	1	174.1	200	319.5	200	176.5	200	321.9	200
	575-60	518	633	1	151.1	175	253.5	175	152.3	175	254.7	175
090	208/230-60	187	254	1	384.8	400	655.0	400	388.4	400	658.6	400
	380-60	342	418	1	235.9	250	389.4	250	235.9	250	389.4	250
	380/415-50	342	440	1	185.5	200	330.9	200	187.9	200	333.3	200
	460-60	414	506	1	185.5	200	330.9	200	187.9	200	333.3	200
	575-60	518	633	1	162.5	175	264.9	175	163.7	175	266.1	175
100	208/230-60	187	254	1	459.8	500	902.0	500	464.0	500	906.2	500
	380-60	342	418	1	242.5	250	495.9	250	242.5	250	495.9	250
	380/415-50	342	440	1	203.1	225	411.1	225	205.9	225	413.9	225
	460-60	414	506	1	203.1	225	411.1	225	205.9	225	413.9	225
	575-60	518	633	1	164.0	175	331.6	175	165.4	175	333.0	175
115	208/230-60	187	254	1	516.8	600	908.0	600	521.6	600	912.8	600
	380-60	342	418	1	271.2	300	483.2	300	271.2	300	483.2	300
	380/415-50	342	440	1	227.6	250	401.7	250	230.8	250	404.9	250
	460-60	414	506	1	227.6	250	401.7	250	230.8	250	404.9	250
	575-60	518	633	1	183.0	200	325.2	200	184.6	200	326.8	200
130	208/230-60	187	254	1	585.2	600	1027.4	600	590.6	600	1032.8	600
	380-60	342	418	1	310.5	350	563.9	350	310.5	350	563.9	350
	380/415-50	342	440	1	259.4	300	467.4	300	263.0	300	471.0	300
	460-60	414	506	1	259.4	300	467.4	300	263.0	300	471.0	300
	575-60	518	633	1	210.4	225	378.0	225	212.2	225	379.8	225
150	208/230-60	187	254	1	648.8	700	1091.0	700	654.8	700	1097.0	700
	380-60	342	418	1	347.1	350	600.5	350	347.1	350	600.5	350
	380/415-50	342	440	1	289.0	300	497.0	300	293.0	300	501.0	300
	460-60	414	506	1	289.0	300	497.0	300	293.0	300	501.0	300
	575-60	518	633	1	235.9	250	403.5	250	237.9	250	405.5	250

LEGEND

- ICF** — Instantaneous Current Flow
- MCA** — Minimum Circuit Amps
- MOCP** — Maximum Overcurrent Protection

NOTES:

1. Units are suitable for use on electrical systems where voltage supplied to the unit terminals is not below or above the listed minimum and maximum limits. Maximum allowable phase imbalance is: voltage 2%; amps 10%.
2. All units/modules have single point primary power connection. (Each unit/module requires its own power supply.) Main power must be supplied from a field-supplied disconnect.
3. Cooler heater is wired into the control circuit so it is always operable as long as the power supply disconnect and heater safety device are on.

4. Power draw control circuits include both crankcase heaters and cooler heaters (where used). Each compressor on sizes 070-090 has a crankcase heater which draws 90 watts of power at 60 Hz or 68 watts of power at 50 Hz, while each compressor on sizes 100-150 has a crankcase heater which draws 56 watts of power at 60 Hz or 42 watts of power at 50 Hz.
5. 30RAP chillers with Greenspeed® intelligence are not available on unit sizes 070-150.



30RAP ELECTRICAL DATA (cont) DUAL POINT LOW-SOUND AEROACOUSTIC™ FAN, NO HYDRONIC PACKAGE

UNIT 30RAP	UNIT VOLTAGE			CIRCUIT 1				CIRCUIT 2			
	V-Ph-Hz	Supplied		MCA	MOCP	ICF	Rec Fuse Size	MCA	MOCP	ICF	Rec Fuse Size
		Min	Max								
070	208/230-3-60	187	254	155.6	200	425.8	175	181.4	225	451.6	200
	380-3-60	342	418	96.0	125	249.5	110	110.5	125	264.0	125
	380/415-3-50	342	440	75.0	100	220.4	90	87.4	110	232.8	100
	460-3-60	414	506	75.0	100	220.4	90	87.4	110	232.8	100
	575-3-60	518	632	65.3	80	167.7	80	77.0	100	179.4	90
080	208/230-3-60	187	254	202.7	250	438.6	225	181.4	225	451.6	200
	380-3-60	342	418	110.8	125	216.2	125	110.5	125	264.0	125
	380/415-3-50	342	440	92.5	110	213.6	100	87.4	110	232.8	100
	460-3-60	414	506	92.5	110	213.6	100	87.4	110	232.8	100
	575-3-60	518	632	79.1	90	163.2	90	77.0	100	179.4	90
090	208/230-3-60	187	254	217.4	250	487.6	250	181.4	225	451.6	200
	380-3-60	342	418	133.9	150	287.4	150	110.5	125	264.0	125
	380/415-3-50	342	440	104.8	125	250.2	125	87.4	110	232.8	100
	460-3-60	414	506	104.8	125	250.2	125	87.4	110	232.8	100
	575-3-60	518	632	91.4	110	193.8	100	77.0	100	179.4	90
100	208/230-3-60	187	254	234.8	300	677.0	300	243.8	300	635.0	300
	380-3-60	342	418	127.3	175	380.7	150	124.8	150	336.8	150
	380/415-3-50	342	440	105.0	150	313.0	125	106.3	125	280.4	125
	460-3-60	414	506	105.0	150	313.0	125	106.3	125	280.4	125
	575-3-60	518	632	85.4	125	253.0	100	85.2	110	227.4	100
115	208/230-3-60	187	254	291.8	350	683.0	350	243.8	300	635.0	300
	380-3-60	342	418	156.0	175	368.0	175	124.8	150	336.8	150
	380/415-3-50	342	440	129.5	150	303.6	150	106.3	125	280.4	125
	460-3-60	414	506	129.5	150	303.6	150	106.3	125	280.4	125
	575-3-60	518	632	104.4	125	246.6	125	85.2	110	227.4	100
130	208/230-3-60	187	254	297.8	350	689.0	350	306.2	400	748.4	350
	380-3-60	342	418	159.9	175	371.9	175	160.2	200	413.6	175
	380/415-3-50	342	440	132.4	150	306.5	150	135.2	175	343.2	150
	460-3-60	414	506	132.4	150	306.5	150	135.2	175	343.2	150
	575-3-60	518	632	106.8	125	249.0	125	110.2	125	277.8	125
150	208/230-3-60	187	254	366.2	450	808.4	400	306.2	400	748.4	350
	380-3-60	342	418	199.2	225	452.6	225	160.2	200	413.6	175
	380/415-3-50	342	440	164.2	200	372.2	175	135.2	175	343.2	150
	460-3-60	414	506	164.2	200	372.2	175	135.2	175	343.2	150
	575-3-60	518	632	134.2	150	301.8	150	110.2	125	277.8	125

LEGEND

- ICF** — Instantaneous Current Flow
- MCA** — Minimum Circuit Amps
- MOCP** — Maximum Overcurrent Protection

NOTES:

1. Units are suitable for use on electrical systems where voltage supplied to the unit terminals is not below or above the listed minimum and maximum limits. Maximum allowable phase imbalance is: voltage 2%; amps 10%.
2. All units/modules have dual point primary power connection. (Each unit/module requires its own power supply.) Main power must be supplied from a field-supplied disconnect.
3. Cooler heater is wired into the control circuit so it is always operable as long as the power supply disconnect and heater safety device are on.

4. Power draw control circuits include both crankcase heaters and cooler heaters (where used). Each compressor on sizes 070-090 has a crankcase heater which draws 90 watts of power at 60 Hz or 68 watts of power at 50 Hz, while each compressor on sizes 100-150 has a crankcase heater which draws 56 watts of power at 60 Hz or 42 watts of power at 50 Hz.
5. 30RAP chillers with Greenspeed® intelligence are not available on unit sizes 070-150.



30RAP ELECTRICAL DATA (cont)
DUAL POINT OPTIONAL VALUE SOUND FAN, NO HYDRONIC PACKAGE

UNIT 30RAP	UNIT VOLTAGE			CIRCUIT 1				CIRCUIT 2			
	V-Ph-Hz	Supplied		MCA	MOCP	ICF	Rec Fuse Size	MCA	MOCP	ICF	Rec Fuse Size
		Min	Max								
070	208/230-3-60	187	254	158.6	200	428.8	175	181.4	225	451.6	200
	380-3-60	342	418	96.0	125	249.5	110	110.5	125	264.0	125
	380/415-3-50	342	440	77.0	100	222.4	90	87.4	110	232.8	100
	460-3-60	414	506	77.0	100	222.4	90	87.4	110	232.8	100
	575-3-60	518	632	66.3	90	168.7	80	77.0	100	179.4	90
080	208/230-3-60	187	254	206.3	250	442.2	225	181.4	225	451.6	200
	380-3-60	342	418	110.8	125	216.2	125	110.5	125	264.0	125
	380/415-3-50	342	440	94.9	110	216.0	110	87.4	110	232.8	100
	460-3-60	414	506	94.9	110	216.0	110	87.4	110	232.8	100
	575-3-60	518	632	80.3	100	164.4	90	77.0	100	179.4	90
090	208/230-3-60	187	254	221.0	250	491.2	250	181.4	225	451.6	200
	380-3-60	342	418	133.9	150	287.4	150	110.5	125	264.0	125
	380/415-3-50	342	440	107.2	125	252.6	125	87.4	110	232.8	100
	460-3-60	414	506	107.2	125	252.6	125	87.4	110	232.8	100
	575-3-60	518	632	92.6	110	195.0	100	77.0	100	179.4	90
100	208/230-3-60	187	254	239.0	300	681.2	300	243.8	300	635.0	300
	380-3-60	342	418	127.3	175	380.7	150	124.8	150	336.8	150
	380/415-3-50	342	440	107.8	125	315.8	125	106.3	125	280.4	125
	460-3-60	414	506	107.8	125	315.8	125	106.3	125	280.4	125
	575-3-60	518	632	86.8	110	254.4	100	85.2	110	227.4	100
115	208/230-3-60	187	254	296.6	350	687.8	350	243.8	300	635.0	300
	380-3-60	342	418	156.0	175	368.0	175	124.8	150	336.8	150
	380/415-3-50	342	440	132.7	150	306.8	150	106.3	125	280.4	125
	460-3-60	414	506	132.7	150	306.8	150	106.3	125	280.4	125
	575-3-60	518	632	106.0	125	248.2	125	85.2	110	227.4	100
130	208/230-3-60	187	254	303.2	350	694.4	350	306.2	400	748.4	350
	380-3-60	342	418	159.9	175	371.9	175	160.2	200	413.6	175
	380/415-3-50	342	440	136.0	150	310.1	150	135.2	175	343.2	150
	460-3-60	414	506	136.0	150	310.1	150	135.2	175	343.2	150
	575-3-60	518	632	108.6	125	250.8	125	110.2	125	277.8	125
150	208/230-3-60	187	254	372.2	450	814.4	400	306.2	400	748.4	350
	380-3-60	342	418	199.2	225	452.6	225	160.2	200	413.6	175
	380/415-3-50	342	440	168.2	200	376.2	200	135.2	175	343.2	150
	460-3-60	414	506	168.2	200	376.2	200	135.2	175	343.2	150
	575-3-60	518	632	136.2	150	303.8	150	110.2	125	277.8	125

LEGEND

- ICF** — Instantaneous Current Flow
- MCA** — Minimum Circuit Amps
- MOCP** — Maximum Overcurrent Protection

NOTES:

1. Units are suitable for use on electrical systems where voltage supplied to the unit terminals is not below or above the listed minimum and maximum limits. Maximum allowable phase imbalance is: voltage 2%; amps 10%.
2. All units/modules have dual point primary power connection. (Each unit/module requires its own power supply.) Main power must be supplied from a field-supplied disconnect.
3. Cooler heater is wired into the control circuit so it is always operable as long as the power supply disconnect and heater safety device are on.

4. Power draw control circuits include both crankcase heaters and cooler heaters (where used). Each compressor on sizes 070-090 has a crankcase heater which draws 90 watts of power at 60 Hz or 68 watts of power at 50 Hz, while each compressor on sizes 100-150 has a crankcase heater which draws 56 watts of power at 60 Hz or 42 watts of power at 50 Hz.
5. 30RAP chillers with Greenspeed® intelligence are not available on unit sizes 070-150.



30RAP ELECTRICAL DATA (cont)

SINGLE POINT HYDRONIC PACKAGE WITH STANDARD LOW-SOUND AEROACOUSTIC™ FAN (60 Hz ONLY), UNIT SIZES 011-060

30RAP UNIT SIZE	VOLTAGE V-Hz (3 Ph)	PUMP SIZE 1.5 hp				PUMP SIZE 3.0 hp				PUMP SIZE 5.0 hp			
		MCA	MOCP	ICF	REC FUSE	MCA	MOCP	ICF	REC FUSE	MCA	MOCP	ICF	REC FUSE
011	208/230-60	55.3	70	190.3	70	58.9	80	193.9	70	63.6	80	198.6	70
	380-60	30.1	40	87.8	35	32.1	40	89.8	35	34.7	45	92.4	40
	460-60	26.8	35	87.8	30	28.4	35	89.4	35	30.5	40	91.5	35
	575-60	19.6	25	63.7	25	21.0	25	65.1	25	22.6	30	66.7	25
016	208/230-60	68.8	90	273.5	80	72.4	100	277.1	80	77.1	100	281.8	90
	380-60	38.5	50	153.5	45	40.5	50	155.5	45	43.1	50	158.0	50
	460-60	34.6	45	146.2	40	36.2	50	147.8	40	38.3	50	149.9	45
	575-60	26.0	35	105.6	30	27.4	35	107.0	30	29.0	40	108.6	35
018	208/230-60	91.5	110	274.7	100	95.1	125	278.3	110	99.8	125	283.0	110
	380-60	53.5	70	169.4	60	55.5	70	171.4	70	58.1	70	174.0	70
	460-60	45.5	60	138.6	50	47.1	60	140.2	60	49.2	60	142.3	60
	575-60	36.5	45	99.8	40	37.9	50	101.2	45	39.5	50	102.8	45
020	208/230-60	96.9	125	291.1	110	100.5	125	294.7	110	105.2	125	299.4	125
	380-60	63.6	80	178.9	70	65.6	80	180.9	80	68.2	90	183.5	80
	460-60	48.2	60	150.8	60	49.8	60	152.4	60	51.9	60	154.5	60
	575-60	38.6	50	100.7	45	40.0	50	102.1	45	41.6	50	103.7	50
025	208/230-60	131.7	175	367.6	150	135.3	175	371.2	150	140.0	175	375.9	175
	380-60	70.7	90	176.1	80	72.7	90	178.1	80	75.3	100	180.7	90
	460-60	59.9	80	181.0	70	61.5	80	182.6	70	63.6	80	184.7	70
	575-60	51.2	70	135.3	60	52.6	70	136.7	60	54.2	70	138.3	60
030	208/230-60	141.9	175	412.1	175	145.5	200	415.7	175	150.2	200	420.4	175
	380-60	86.7	110	240.2	100	88.7	110	242.2	100	91.3	125	244.8	100
	460-60	68.4	90	213.8	80	70.0	90	215.4	80	72.1	90	217.5	80
	575-60	59.7	80	162.1	70	61.1	80	163.5	70	62.7	80	165.1	70
035	208/230-60	—	—	—	—	173.3	200	367.5	200	178.0	200	372.2	200
	380-60	—	—	—	—	107.9	125	223.3	125	110.5	125	225.9	125
	460-60	—	—	—	—	86.1	100	188.7	100	88.2	100	190.8	100
	575-60	—	—	—	—	69.1	80	131.2	80	70.7	80	132.8	80
040	208/230-60	—	—	—	—	205.7	250	402.9	225	210.4	250	407.6	225
	380-60	—	—	—	—	116.9	125	232.2	125	119.5	125	234.8	125
	460-60	—	—	—	—	90.1	100	192.5	100	92.2	110	194.6	100
	575-60	—	—	—	—	71.9	80	153.9	80	73.5	80	155.5	80
045	208/230-60	—	—	—	—	237.5	250	476.6	250	242.2	250	481.3	250
	380-60	—	—	—	—	124.0	150	232.6	150	126.6	150	235.2	150
	460-60	—	—	—	—	101.6	110	227.2	110	103.7	125	229.3	110
	575-60	—	—	—	—	84.4	100	173.7	90	86.0	100	175.3	100
050	208/230-60	—	—	—	—	243.9	250	479.8	250	248.6	250	484.5	250
	380-60	—	—	—	—	130.4	150	235.8	150	133.0	150	238.4	150
	460-60	—	—	—	—	110.6	125	231.7	125	112.7	125	233.8	125
	575-60	—	—	—	—	94.8	110	178.9	100	96.4	110	180.5	110
055	208/230-60	—	—	—	—	260.1	300	534.8	300	264.8	300	539.5	300
	380-60	—	—	—	—	150.3	175	310.9	175	152.9	175	313.5	175
	460-60	—	—	—	—	122.0	125	271.2	125	124.1	150	273.3	150
	575-60	—	—	—	—	105.7	125	211.9	125	107.3	125	213.5	125
060	208/230-60	—	—	—	—	269.1	300	539.3	300	273.8	300	544.0	300
	380-60	—	—	—	—	164.5	175	318.0	175	167.1	200	320.6	200
	460-60	—	—	—	—	129.6	150	275.0	150	131.7	150	277.1	150
	575-60	—	—	—	—	113.3	125	215.7	125	114.9	125	217.3	125

LEGEND

- ICF** — Instantaneous Current Flow
- MCA** — Minimum Circuit Amps
- MOCP** — Maximum Overcurrent Protection

NOTES:

1. Units are suitable for use on electrical systems where voltage supplied to the unit terminals is not below or above the listed minimum and maximum limits. Maximum allowable phase imbalance is: voltage 2%; amps 10%.
2. All units/modules have single point primary power connection. (Each unit/module requires its own power supply.) Main power must be supplied from a field-supplied disconnect.
3. Cooler heater is wired into the control circuit so it is always operable as long as the power supply disconnect and heater safety device are on.

4. Power draw control circuits include both crankcase heaters (sizes 070-150 only) and cooler heaters (where used). Each compressor on sizes 070-090 has a crankcase heater which draws 90 watts of power, while each compressor on sizes 100-150 has a crankcase heater which draws 56 watts of power.
5. 30RAP chillers with Greenspeed® intelligence are not available on unit sizes 070-150.



30RAP ELECTRICAL DATA (cont)

SINGLE POINT HYDRONIC PACKAGE WITH STANDARD LOW-SOUND AEROACOUSTIC™ FAN (60 Hz ONLY), UNIT SIZES 011-060 (cont)

30RAP UNIT SIZE	VOLTAGE V-Hz (3 Ph)	PUMP SIZE 7.5 hp				PUMP SIZE 10.0 hp				PUMP SIZE 15.0 hp			
		MCA	MOCP	ICF	REC FUSE	MCA	MOCP	ICF	REC FUSE	MCA	MOCP	ICF	REC FUSE
011	208/230-60	—	—	—	—	—	—	—	—	—	—	—	—
	380-60	—	—	—	—	—	—	—	—	—	—	—	—
	460-60	—	—	—	—	—	—	—	—	—	—	—	—
	575-60	—	—	—	—	—	—	—	—	—	—	—	—
016	208/230-60	—	—	—	—	—	—	—	—	—	—	—	—
	380-60	—	—	—	—	—	—	—	—	—	—	—	—
	460-60	—	—	—	—	—	—	—	—	—	—	—	—
	575-60	—	—	—	—	—	—	—	—	—	—	—	—
018	208/230-60	—	—	—	—	—	—	—	—	—	—	—	—
	380-60	—	—	—	—	—	—	—	—	—	—	—	—
	460-60	—	—	—	—	—	—	—	—	—	—	—	—
	575-60	—	—	—	—	—	—	—	—	—	—	—	—
020	208/230-60	—	—	—	—	—	—	—	—	—	—	—	—
	380-60	—	—	—	—	—	—	—	—	—	—	—	—
	460-60	—	—	—	—	—	—	—	—	—	—	—	—
	575-60	—	—	—	—	—	—	—	—	—	—	—	—
025	208/230-60	—	—	—	—	—	—	—	—	—	—	—	—
	380-60	—	—	—	—	—	—	—	—	—	—	—	—
	460-60	—	—	—	—	—	—	—	—	—	—	—	—
	575-60	—	—	—	—	—	—	—	—	—	—	—	—
030	208/230-60	—	—	—	—	—	—	—	—	—	—	—	—
	380-60	—	—	—	—	—	—	—	—	—	—	—	—
	460-60	—	—	—	—	—	—	—	—	—	—	—	—
	575-60	—	—	—	—	—	—	—	—	—	—	—	—
035	208/230-60	183.9	200	378.1	200	—	—	—	—	—	—	—	—
	380-60	113.9	125	229.3	125	—	—	—	—	—	—	—	—
	460-60	91.1	100	193.7	100	—	—	—	—	—	—	—	—
	575-60	73.1	80	135.2	80	—	—	—	—	—	—	—	—
040	208/230-60	216.3	250	413.5	250	—	—	—	—	—	—	—	—
	380-60	122.9	125	238.2	125	—	—	—	—	—	—	—	—
	460-60	95.1	110	197.5	100	—	—	—	—	—	—	—	—
	575-60	75.9	90	157.9	80	—	—	—	—	—	—	—	—
045	208/230-60	248.1	250	487.2	250	—	—	—	—	—	—	—	—
	380-60	130.0	150	238.6	150	—	—	—	—	—	—	—	—
	460-60	106.6	125	232.2	125	—	—	—	—	—	—	—	—
	575-60	88.4	100	177.7	100	—	—	—	—	—	—	—	—
050	208/230-60	254.5	300	490.4	300	261.0	300	496.9	300	—	—	—	—
	380-60	136.4	150	241.8	150	140.0	150	245.4	150	—	—	—	—
	460-60	115.6	125	236.7	125	118.4	125	239.5	125	—	—	—	—
	575-60	98.8	110	182.9	110	101.0	110	185.1	110	—	—	—	—
055	208/230-60	270.7	300	545.4	300	277.2	300	551.9	300	—	—	—	—
	380-60	156.3	175	316.9	175	159.9	175	320.5	175	—	—	—	—
	460-60	127.0	150	276.2	150	129.8	150	279.0	150	—	—	—	—
	575-60	109.7	125	215.9	125	111.9	125	218.1	125	—	—	—	—
060	208/230-60	279.7	300	549.9	300	286.2	300	556.4	300	—	—	—	—
	380-60	170.5	200	324.0	200	174.1	200	327.6	200	—	—	—	—
	460-60	134.6	150	280.0	150	137.4	150	282.8	150	—	—	—	—
	575-60	117.3	125	219.7	125	119.5	125	221.9	125	—	—	—	—

LEGEND

- ICF** — Instantaneous Current Flow
MCA — Minimum Circuit Amps
MOCP — Maximum Overcurrent Protection

NOTES:

- Units are suitable for use on electrical systems where voltage supplied to the unit terminals is not below or above the listed minimum and maximum limits. Maximum allowable phase imbalance is: voltage 2%; amps 10%.
- All units/modules have single point primary power connection. (Each unit/module requires its own power supply.) Main power must be supplied from a field-supplied disconnect.
- Cooler heater is wired into the control circuit so it is always operable as long as the power supply disconnect and heater safety device are on.

- Power draw control circuits include both crankcase heaters (sizes 070-150 only) and cooler heaters (where used). Each compressor on sizes 070-090 has a crankcase heater which draws 90 watts of power, while each compressor on sizes 100-150 has a crankcase heater which draws 56 watts of power.
- 30RAP chillers with Greenspeed® intelligence are not available on unit sizes 070-150.



Electrical data (cont)



30RAP ELECTRICAL DATA (cont)

SINGLE POINT HYDRONIC PACKAGE WITH STANDARD LOW-SOUND AEROACOUSTIC™ FAN (60 Hz ONLY), UNIT SIZES 070-150

30RAP UNIT SIZE	VOLTAGE V-Hz (3 Ph)	PUMP SIZE 1.5 hp				PUMP SIZE 3.0 hp				PUMP SIZE 5.0 hp			
		MCA	MOCP	ICF	REC FUSE	MCA	MOCP	ICF	REC FUSE	MCA	MOCP	ICF	REC FUSE
070	208/230-60	—	—	—	—	—	—	—	—	—	—	—	—
	380-60	—	—	—	—	—	—	—	—	—	—	—	—
	460-60	—	—	—	—	—	—	—	—	—	—	—	—
	575-60	—	—	—	—	—	—	—	—	—	—	—	—
080	208/230-60	—	—	—	—	—	—	—	—	—	—	—	—
	380-60	—	—	—	—	—	—	—	—	—	—	—	—
	460-60	—	—	—	—	—	—	—	—	—	—	—	—
	575-60	—	—	—	—	—	—	—	—	—	—	—	—
090	208/230-60	—	—	—	—	—	—	—	—	—	—	—	—
	380-60	—	—	—	—	—	—	—	—	—	—	—	—
	460-60	—	—	—	—	—	—	—	—	—	—	—	—
	575-60	—	—	—	—	—	—	—	—	—	—	—	—
100	208/230-60	—	—	—	—	—	—	—	—	—	—	—	—
	380-60	—	—	—	—	—	—	—	—	—	—	—	—
	460-60	—	—	—	—	—	—	—	—	—	—	—	—
	575-60	—	—	—	—	—	—	—	—	—	—	—	—
115	208/230-60	—	—	—	—	—	—	—	—	—	—	—	—
	380-60	—	—	—	—	—	—	—	—	—	—	—	—
	460-60	—	—	—	—	—	—	—	—	—	—	—	—
	575-60	—	—	—	—	—	—	—	—	—	—	—	—
130	208/230-60	—	—	—	—	—	—	—	—	—	—	—	—
	380-60	—	—	—	—	—	—	—	—	—	—	—	—
	460-60	—	—	—	—	—	—	—	—	—	—	—	—
	575-60	—	—	—	—	—	—	—	—	—	—	—	—
150	208/230-60	—	—	—	—	—	—	—	—	664.2	700	1106.4	700
	380-60	—	—	—	—	—	—	—	—	355.2	400	608.6	400
	460-60	—	—	—	—	—	—	—	—	296.1	300	504.1	300
	575-60	—	—	—	—	—	—	—	—	241.3	250	408.9	250

30RAP UNIT SIZE	VOLTAGE V-Hz (3 Ph)	PUMP SIZE 7.5 hp				PUMP SIZE 10.0 hp				PUMP SIZE 15.0 hp			
		MCA	MOCP	ICF	REC FUSE	MCA	MOCP	ICF	REC FUSE	MCA	MOCP	ICF	REC FUSE
070	208/230-60	341.5	350	611.7	350	348.0	400	618.2	400	—	—	—	—
	380-60	208.4	225	361.9	225	212.0	225	365.5	225	—	—	—	—
	460-60	164.4	175	309.8	175	167.2	175	312.6	175	—	—	—	—
	575-60	143.4	150	245.8	150	145.6	150	248.0	150	—	—	—	—
080	208/230-60	389.8	400	660.0	400	396.3	450	666.5	450	408.0	450	678.2	450
	380-60	225.0	250	378.5	250	228.6	250	382.1	250	235.6	250	389.1	250
	460-60	182.8	200	328.2	200	185.6	200	331.0	200	191.1	200	336.5	200
	575-60	158.1	175	260.5	175	160.3	175	262.7	175	165.1	175	267.5	175
090	208/230-60	403.3	450	673.5	450	409.8	450	680.0	450	421.5	450	691.7	450
	380-60	246.3	250	399.8	250	249.9	250	403.4	250	256.9	300	410.4	300
	460-60	194.2	200	339.6	200	197.0	200	342.4	200	202.5	225	347.9	225
	575-60	169.5	175	271.9	175	171.7	175	274.1	175	176.5	200	278.9	200
100	208/230-60	478.3	500	920.5	500	484.8	500	927.0	500	496.5	500	938.7	500
	380-60	252.9	300	506.3	300	256.5	300	509.9	300	263.5	300	516.9	300
	460-60	211.8	250	419.8	225	214.6	250	422.0	250	220.1	250	428.1	250
	575-60	171.0	200	338.6	200	173.2	200	340.8	200	178.0	200	345.6	200
115	208/230-60	535.3	600	926.5	600	541.8	600	933.0	600	553.5	600	944.7	600
	380-60	281.6	300	493.6	300	285.2	300	497.2	300	292.2	300	504.2	300
	460-60	236.3	250	410.4	250	239.1	250	413.2	250	244.6	250	418.7	250
	575-60	190.0	200	332.2	200	192.2	200	334.4	200	197.0	200	339.2	200
130	208/230-60	603.7	700	1045.9	700	610.2	700	1052.4	700	621.9	700	1064.1	700
	380-60	320.9	350	574.3	350	324.5	350	577.9	350	331.5	350	584.9	350
	460-60	268.1	300	476.1	300	270.9	300	478.9	300	276.4	300	484.4	300
	575-60	217.4	250	385.0	250	219.6	250	387.2	250	224.4	250	392.0	250
150 Dual Pump	208/230-60	667.3	700	1109.5	700	673.8	700	1116.0	700	685.5	700	1127.7	700
	380-60	357.5	400	610.9	400	361.1	400	614.5	400	368.1	400	621.5	400
	460-60	297.7	300	505.7	300	300.5	350	508.5	350	306.0	350	514.0	350
	575-60	242.9	250	410.5	250	245.1	250	412.7	250	249.9	250	417.5	250
150 Single Pump	208/230-60	670.8	700	1113.0	700	673.8	700	1116.0	700	685.5	700	1127.7	700
	380-60	359.4	400	612.8	400	361.1	400	614.5	400	368.1	400	621.5	400
	460-60	299.1	300	507.1	300	300.5	350	508.5	350	306.0	350	514.0	350
	575-60	244.0	250	411.6	250	245.1	250	412.7	250	249.9	250	417.5	250

LEGEND

- ICF** — Instantaneous Current Flow
- MCA** — Minimum Circuit Amps
- MOCP** — Maximum Overcurrent Protection

NOTES:

1. Units are suitable for use on electrical systems where voltage supplied to the unit terminals is not below or above the listed minimum and maximum limits. Maximum allowable phase imbalance is: voltage 2%; amps 10%.
2. All units/modules have single point primary power connection. (Each unit/module requires its own power supply.) Main power must be supplied from a field-supplied disconnect.
3. Cooler heater is wired into the control circuit so it is always operable as long as the power supply disconnect and heater safety device are on.

4. Power draw control circuits include both crankcase heaters (sizes 070-150 only) and cooler heaters (where used). Each compressor on sizes 070-090 has a crankcase heater which draws 90 watts of power, while each compressor on sizes 100-150 has a crankcase heater which draws 56 watts of power.
5. 30RAP chillers with Greenspeed® intelligence are not available on unit sizes 070-150.
6. All data is the same for single pump or dual pump except for size 150 with 7.5 hp pump.



30RAP ELECTRICAL DATA (cont)
DUAL POINT HYDRONIC PACKAGE WITH STANDARD LOW-SOUND AEROACOUSTIC™ FAN (60 Hz ONLY)

30RAP UNIT SIZE	VOLTAGE V-Ph-Hz	PUMP SIZE 5.0 hp, CIRCUIT 1				PUMP SIZE 5.0 hp, CIRCUIT 2			
		MCA	MOCP	ICF	REC FUSE	MCA	MOCP	ICF	REC FUSE
150	208/230-3-60	366.2	450	808.4	400	321.6	400	763.8	350
	380-3-60	199.2	225	452.6	225	168.3	200	421.7	200
	460-3-60	164.2	200	372.2	175	142.3	175	350.3	175
	575-3-60	134.2	150	301.8	150	115.6	125	283.2	125

30RAP UNIT SIZE	VOLTAGE V-Ph-Hz	PUMP SIZE 7.5 hp CIRCUIT 1				PUMP SIZE 7.5 hp CIRCUIT 2			
		MCA	MOCP	ICF	REC FUSE	MCA	MOCP	ICF	REC FUSE
070	208/230-3-60	155.6	200	425.8	175	199.9	250	470.1	225
	380-3-60	96.0	125	249.5	110	120.9	150	274.4	150
	460-3-60	75.0	100	220.4	90	96.1	110	241.5	110
	575-3-60	65.3	80	167.7	80	84.0	100	186.4	90
080	208/230-3-60	202.7	250	438.6	225	199.9	250	470.1	225
	380-3-60	110.8	125	216.2	125	120.9	150	274.4	150
	460-3-60	92.5	110	213.6	100	96.1	110	241.5	110
	575-3-60	79.1	90	163.2	90	84.0	100	186.4	90
090	208/230-3-60	217.4	250	487.6	250	199.9	250	470.1	225
	380-3-60	133.9	150	287.4	150	120.9	150	274.4	150
	460-3-60	104.8	125	250.2	125	96.1	110	241.5	110
	575-3-60	91.4	110	193.8	100	84.0	100	186.4	90
100	208/230-3-60	234.8	300	677.0	300	262.3	300	653.5	300
	380-3-60	127.3	175	380.7	150	135.2	150	347.2	150
	460-3-60	105.0	125	313.0	125	115.0	125	289.1	125
	575-3-60	85.4	110	253.0	100	92.2	110	234.4	100
115	208/230-3-60	291.8	350	683.0	350	262.3	300	653.5	300
	380-3-60	156.0	175	368.0	175	135.2	150	347.2	150
	460-3-60	129.5	150	303.6	150	115.0	125	289.1	125
	575-3-60	104.4	125	246.6	125	92.2	110	234.4	100
130	208/230-3-60	297.8	350	689.0	350	324.7	400	766.9	350
	380-3-60	159.9	175	371.9	175	170.6	200	424.0	200
	460-3-60	132.4	150	306.5	150	143.9	175	351.9	175
	575-3-60	106.8	125	249.0	125	117.2	150	284.8	150
150 Dual Pump	208/230-3-60	366.2	450	808.4	400	324.7	400	766.9	350
	380-3-60	199.2	225	452.6	225	170.6	200	424.0	200
	460-3-60	164.2	200	372.2	175	143.9	175	351.9	175
	575-3-60	134.2	150	301.8	150	117.2	150	284.8	150
150 Single Pump	208/230-3-60	366.2	450	808.4	400	328.2	400	770.4	350
	380-3-60	199.2	225	452.6	225	172.5	200	425.9	200
	460-3-60	164.2	200	372.2	175	145.3	175	353.3	175
	575-3-60	134.2	150	301.8	150	118.3	150	285.9	150

LEGEND

- ICF** — Instantaneous Current Flow
- MCA** — Minimum Circuit Amps
- MOCP** — Maximum Overcurrent Protection

NOTES:

1. Units are suitable for use on electrical systems where voltage supplied to the unit terminals is not below or above the listed minimum and maximum limits. Maximum allowable phase imbalance is: voltage 2%; amps 10%.
2. All units/modules have single point primary power connection. (Each unit/module requires its own power supply.) Main power must be supplied from a field-supplied disconnect.
3. Cooler heater is wired into the control circuit so it is always operable as long as the power supply disconnect and heater safety device are on.

4. Power draw control circuits include both crankcase heaters (sizes 070-150 only) and cooler heaters (where used). Each compressor on sizes 070-090 has a crankcase heater which draws 90 watts of power, while each compressor on sizes 100-150 has a crankcase heater which draws 56 watts of power.
5. 30RAP chillers with Greenspeed® intelligence are not available on unit sizes 070-150.



30RAP ELECTRICAL DATA (cont) DUAL POINT HYDRONIC PACKAGE WITH STANDARD LOW-SOUND AEROACOUSTIC™ FAN (60 Hz ONLY) (cont)

30RAP UNIT SIZE	VOLTAGE V-Ph-Hz	PUMP SIZE 10.0 hp CIRCUIT 1				PUMP SIZE 10.0 hp CIRCUIT 2			
		MCA	MOCP	ICF	REC FUSE	MCA	MOCP	ICF	REC FUSE
070	208/230-3-60	155.6	200	425.8	175	206.4	250	476.6	225
	380-3-60	96.0	125	249.5	110	124.5	150	278.0	150
	460-3-60	75.0	100	220.4	90	98.9	125	244.3	110
	575-3-60	65.3	80	167.7	80	86.2	100	188.6	100
080	208/230-3-60	202.7	250	438.6	225	206.4	250	476.6	225
	380-3-60	110.8	125	216.2	125	124.5	150	278.0	150
	460-3-60	92.5	110	213.6	100	98.9	125	244.3	110
	575-3-60	79.1	90	163.2	90	86.2	100	188.6	100
090	208/230-3-60	217.4	250	487.6	250	206.4	250	476.6	225
	380-3-60	133.9	150	287.4	150	124.5	150	278.0	150
	460-3-60	104.8	125	250.2	125	98.9	125	244.3	110
	575-3-60	91.4	110	193.8	100	86.2	100	188.6	100
100	208/230-3-60	234.8	300	677.0	300	268.8	300	660.0	300
	380-3-60	127.3	175	380.7	150	138.8	175	350.8	150
	460-3-60	105.0	125	313.0	125	117.8	150	291.9	150
	575-3-60	85.4	110	253.0	100	94.4	110	236.6	110
115	208/230-3-60	291.8	350	683.0	350	268.8	300	660.0	300
	380-3-60	156.0	175	368.0	175	138.8	175	350.8	150
	460-3-60	129.5	150	303.6	150	117.8	150	291.9	150
	575-3-60	104.4	125	246.6	125	94.4	110	236.6	110
130	208/230-3-60	297.8	350	689.0	350	331.2	400	773.4	400
	380-3-60	159.9	175	371.9	175	174.2	225	427.6	200
	460-3-60	132.4	150	306.5	150	146.7	175	354.7	150
	575-3-60	106.8	125	249.0	125	119.4	150	287.0	150
150	208/230-3-60	366.2	450	808.4	400	331.2	400	773.4	400
	380-3-60	199.2	225	452.6	225	174.2	225	427.6	200
	460-3-60	164.2	200	372.2	175	146.7	175	354.7	150
	575-3-60	134.2	150	301.8	150	119.4	150	287.0	150

30RAP UNIT SIZE	VOLTAGE V-Ph-Hz	PUMP SIZE 15.0 hp CIRCUIT 1				PUMP SIZE 15.0 hp CIRCUIT 2			
		MCA	MOCP	ICF	REC FUSE	MCA	MOCP	ICF	REC FUSE
070	208/230-3-60	—	—	—	—	—	—	—	—
	380-3-60	—	—	—	—	—	—	—	—
	460-3-60	—	—	—	—	—	—	—	—
	575-3-60	—	—	—	—	—	—	—	—
080	208/230-3-60	202.7	250	438.6	225	218.1	250	488.3	250
	380-3-60	110.8	125	216.2	125	131.5	150	285.0	150
	460-3-60	92.5	110	213.6	100	104.4	125	249.8	125
	575-3-60	79.1	90	163.2	90	91.0	110	193.4	100
090	208/230-3-60	217.4	250	487.6	250	218.1	250	488.3	250
	380-3-60	133.9	150	287.4	150	131.5	150	285.0	150
	460-3-60	104.8	125	250.2	125	104.4	125	249.8	125
	575-3-60	91.4	110	193.8	100	91.0	110	193.4	100
100	208/230-3-60	234.8	300	677.0	300	280.5	350	671.7	300
	380-3-60	127.3	175	380.7	150	145.8	175	357.8	175
	460-3-60	105.0	125	313.0	125	123.3	150	297.4	150
	575-3-60	85.4	110	253.0	100	99.2	125	241.4	110
115	208/230-3-60	291.8	350	683.0	350	280.5	350	671.7	300
	380-3-60	156.0	175	368.0	175	145.8	175	357.8	175
	460-3-60	129.5	150	303.6	150	123.3	150	297.4	150
	575-3-60	104.4	125	246.6	125	99.2	125	241.4	110
130	208/230-3-60	297.8	350	689.0	350	342.9	400	785.1	400
	380-3-60	159.9	175	371.9	175	181.2	225	434.6	200
	460-3-60	132.4	150	306.5	150	152.2	175	360.2	175
	575-3-60	106.8	125	249.0	125	124.2	150	291.8	150
150	208/230-3-60	366.2	450	808.4	400	342.9	400	785.1	400
	380-3-60	199.2	225	452.6	225	181.2	225	434.6	200
	460-3-60	164.2	200	372.2	175	152.2	175	360.2	175
	575-3-60	134.2	150	301.8	150	124.2	150	291.8	150

LEGEND

- ICF** — Instantaneous Current Flow
MCA — Minimum Circuit Amps
MOCP — Maximum Overcurrent Protection

NOTES:

- Units are suitable for use on electrical systems where voltage supplied to the unit terminals is not below or above the listed minimum and maximum limits. Maximum allowable phase imbalance is: voltage 2%; amps 10%.
- All units/modules have single point primary power connection. (Each unit/module requires its own power supply.) Main power must be supplied from a field-supplied disconnect.
- Cooler heater is wired into the control circuit so it is always operable as long as the power supply disconnect and heater safety device are on.

- Power draw control circuits include both crankcase heaters (sizes 070-150 only) and cooler heaters (where used). Each compressor on sizes 070-090 has a crankcase heater which draws 90 watts of power, while each compressor on sizes 100-150 has a crankcase heater which draws 56 watts of power.
- 30RAP chillers with Greenspeed® intelligence are not available on unit sizes 070-150.



30RAP ELECTRICAL DATA (cont)

SINGLE POINT HYDRONIC PACKAGE WITH OPTIONAL VALUE SOUND FANS (60 Hz ONLY), UNIT SIZES 011-060

30RAP UNIT SIZE	VOLTAGE V-Hz (3 Ph)	PUMP SIZE 1.5 hp				PUMP SIZE 3.0 hp				PUMP SIZE 5.0 hp			
		MCA	MOCP	ICF	REC FUSE	MCA	MOCP	ICF	REC FUSE	MCA	MOCP	ICF	REC FUSE
011	208/230-60	55.9	70	190.9	70	59.5	80	194.5	70	64.2	80	199.2	70
	380-60	30.1	40	87.8	35	32.1	40	89.8	35	34.7	45	92.4	40
	460-60	27.2	35	88.2	30	28.8	40	89.8	35	30.9	40	91.9	35
	575-60	19.8	25	63.9	25	21.2	25	65.3	25	22.8	30	66.9	25
016	208/230-60	69.4	90	274.1	80	73.0	100	277.7	90	77.7	100	282.4	90
	380-60	38.5	50	153.5	45	40.5	50	155.5	45	43.1	50	158.1	50
	460-60	35.0	45	146.6	40	36.6	50	148.2	45	38.7	50	150.3	45
	575-60	26.2	35	105.8	30	27.6	35	107.2	35	29.2	40	108.8	35
018	208/230-60	92.7	125	275.9	110	96.3	125	279.5	110	101.0	125	284.2	110
	380-60	53.5	70	169.4	60	55.5	70	171.4	70	58.1	70	174.0	70
	460-60	46.3	60	139.4	60	47.9	60	141.0	60	50.0	60	143.1	60
	575-60	36.9	50	100.2	45	38.3	50	101.6	45	39.9	50	103.2	45
020	208/230-60	98.1	125	292.3	110	101.7	125	295.9	125	106.4	125	300.6	125
	380-60	63.6	80	178.9	70	65.6	80	180.9	80	68.2	90	183.5	80
	460-60	49.0	60	151.6	60	50.6	60	153.2	60	52.7	70	155.3	60
	575-60	39.0	50	101.1	45	40.4	50	102.5	45	42.0	50	104.1	50
025	208/230-60	132.9	175	368.8	150	136.5	175	372.4	150	141.2	175	377.1	175
	380-60	70.7	90	176.1	80	72.7	90	178.1	80	75.3	100	180.7	90
	460-60	60.7	80	181.8	70	62.3	80	183.4	70	64.4	80	185.5	80
	575-60	51.6	70	135.7	60	53.0	70	137.1	60	54.6	70	138.7	60
030	208/230-60	143.1	175	413.3	175	146.7	200	416.9	175	151.4	200	421.6	175
	380-60	86.7	110	240.2	100	88.7	110	242.2	100	91.3	125	244.8	100
	460-60	69.2	90	214.6	80	70.8	90	216.2	80	72.9	90	218.3	80
	575-60	60.1	80	162.5	70	61.5	80	163.9	70	63.1	80	165.5	70
035	208/230-60	—	—	—	—	175.1	200	369.3	200	179.8	200	374.0	200
	380-60	—	—	—	—	107.9	125	223.2	125	110.5	125	225.9	125
	460-60	—	—	—	—	87.3	100	189.9	100	89.4	100	192.0	100
	575-60	—	—	—	—	69.7	80	131.8	80	71.3	80	133.4	80
040	208/230-60	—	—	—	—	207.5	250	404.7	225	212.2	250	409.4	225
	380-60	—	—	—	—	116.9	125	232.2	125	119.5	125	234.8	125
	460-60	—	—	—	—	91.3	100	193.7	100	93.4	110	195.8	100
	575-60	—	—	—	—	72.5	80	154.5	80	74.1	80	156.1	80
045	208/230-60	—	—	—	—	239.3	250	478.4	250	244.0	250	483.1	250
	380-60	—	—	—	—	124.0	150	232.6	150	126.6	150	235.2	150
	460-60	—	—	—	—	102.8	125	228.4	110	104.9	125	230.5	125
	575-60	—	—	—	—	85.0	100	174.3	90	86.6	100	175.9	100
050	208/230-60	—	—	—	—	245.7	250	481.6	250	250.4	300	486.3	300
	380-60	—	—	—	—	130.4	150	235.8	150	133.0	150	238.4	150
	460-60	—	—	—	—	111.8	125	232.9	125	113.9	125	235.0	125
	575-60	—	—	—	—	95.4	110	179.5	110	97.0	110	181.1	110
055	208/230-60	—	—	—	—	262.5	300	537.2	300	267.2	300	541.9	300
	380-60	—	—	—	—	150.3	175	310.9	175	152.9	175	313.5	175
	460-60	—	—	—	—	123.6	150	272.8	150	125.7	150	274.9	150
	575-60	—	—	—	—	106.5	125	212.7	125	108.1	125	214.3	125
060	208/230-60	—	—	—	—	271.5	300	541.7	300	276.2	300	546.4	300
	380-60	—	—	—	—	164.5	175	318.0	175	167.1	200	320.6	200
	460-60	—	—	—	—	131.2	150	276.6	150	133.3	150	278.7	150
	575-60	—	—	—	—	114.1	125	216.5	125	115.7	125	218.1	125

LEGEND

- ICF — Instantaneous Current Flow
MCA — Minimum Circuit Amps
MOCP — Maximum Overcurrent Protection

NOTES:

- Units are suitable for use on electrical systems where voltage supplied to the unit terminals is not below or above the listed minimum and maximum limits. Maximum allowable phase imbalance is: voltage 2%; amps 10%.
- All units/modules have single point primary power connection. (Each unit/module requires its own power supply.) Main power must be supplied from a field-supplied disconnect.
- Cooler heater is wired into the control circuit so it is always operable as long as the power supply disconnect and heater safety device are on.

- Power draw control circuits include both crankcase heaters (sizes 070-150 only) and cooler heaters (where used). Each compressor on sizes 070-090 has a crankcase heater which draws 90 watts of power, while each compressor on sizes 100-150 has a crankcase heater which draws 56 watts of power.
- 30RAP chillers with Greenspeed® intelligence are not available on unit sizes 070-150.



Electrical data (cont)



30RAP ELECTRICAL DATA (cont)

SINGLE POINT HYDRONIC PACKAGE WITH OPTIONAL VALUE SOUND FANS (60 Hz ONLY) UNIT SIZES 011-060 (cont)

30RAP UNIT SIZE	VOLTAGE V-Hz (3 Ph)	PUMP SIZE 7.5 hp				PUMP SIZE 10.0 hp				PUMP SIZE 15.0 hp			
		MCA	MOCP	ICF	REC FUSE	MCA	MOCP	ICF	REC FUSE	MCA	MOCP	ICF	REC FUSE
011	208/230-60	—	—	—	—	—	—	—	—	—	—	—	—
	380-60	—	—	—	—	—	—	—	—	—	—	—	—
	460-60	—	—	—	—	—	—	—	—	—	—	—	—
	575-60	—	—	—	—	—	—	—	—	—	—	—	—
016	208/230-60	—	—	—	—	—	—	—	—	—	—	—	—
	380-60	—	—	—	—	—	—	—	—	—	—	—	—
	460-60	—	—	—	—	—	—	—	—	—	—	—	—
	575-60	—	—	—	—	—	—	—	—	—	—	—	—
018	208/230-60	—	—	—	—	—	—	—	—	—	—	—	—
	380-60	—	—	—	—	—	—	—	—	—	—	—	—
	460-60	—	—	—	—	—	—	—	—	—	—	—	—
	575-60	—	—	—	—	—	—	—	—	—	—	—	—
020	208/230-60	—	—	—	—	—	—	—	—	—	—	—	—
	380-60	—	—	—	—	—	—	—	—	—	—	—	—
	460-60	—	—	—	—	—	—	—	—	—	—	—	—
	575-60	—	—	—	—	—	—	—	—	—	—	—	—
025	208/230-60	—	—	—	—	—	—	—	—	—	—	—	—
	380-60	—	—	—	—	—	—	—	—	—	—	—	—
	460-60	—	—	—	—	—	—	—	—	—	—	—	—
	575-60	—	—	—	—	—	—	—	—	—	—	—	—
030	208/230-60	—	—	—	—	—	—	—	—	—	—	—	—
	380-60	—	—	—	—	—	—	—	—	—	—	—	—
	460-60	—	—	—	—	—	—	—	—	—	—	—	—
	575-60	—	—	—	—	—	—	—	—	—	—	—	—
035	208/230-60	185.7	200	379.9	200	—	—	—	—	—	—	—	—
	380-60	113.9	125	229.3	125	—	—	—	—	—	—	—	—
	460-60	92.3	110	194.9	100	—	—	—	—	—	—	—	—
	575-60	73.7	80	135.8	80	—	—	—	—	—	—	—	—
040	208/230-60	218.1	250	415.3	250	—	—	—	—	—	—	—	—
	380-60	122.9	125	238.2	125	—	—	—	—	—	—	—	—
	460-60	96.3	110	198.7	110	—	—	—	—	—	—	—	—
	575-60	76.5	90	158.5	90	—	—	—	—	—	—	—	—
045	208/230-60	249.9	300	489.0	300	—	—	—	—	—	—	—	—
	380-60	130.0	150	238.6	150	—	—	—	—	—	—	—	—
	460-60	107.8	125	233.4	125	—	—	—	—	—	—	—	—
	575-60	89.0	100	178.3	100	—	—	—	—	—	—	—	—
050	208/230-60	256.3	300	492.2	300	262.8	300	498.7	300	—	—	—	—
	380-60	136.4	150	241.8	150	140.0	150	245.4	150	—	—	—	—
	460-60	116.8	125	237.9	125	119.6	125	240.7	125	—	—	—	—
	575-60	99.4	110	183.5	110	101.6	110	185.7	110	—	—	—	—
055	208/230-60	273.1	300	547.8	300	279.6	300	554.3	300	—	—	—	—
	380-60	156.3	175	316.9	175	159.9	175	320.5	175	—	—	—	—
	460-60	128.6	150	277.8	150	131.4	150	280.6	150	—	—	—	—
	575-60	110.5	125	216.7	125	112.7	125	218.9	125	—	—	—	—
060	208/230-60	282.1	300	552.3	300	288.6	300	558.8	300	—	—	—	—
	380-60	170.5	200	324.0	200	174.1	200	327.6	200	—	—	—	—
	460-60	136.2	150	281.6	150	139.0	150	284.4	150	—	—	—	—
	575-60	118.1	125	220.5	125	120.3	125	222.7	125	—	—	—	—

LEGEND

- ICF — Instantaneous Current Flow
- MCA — Minimum Circuit Amps
- MOCP — Maximum Overcurrent Protection

NOTES:

1. Units are suitable for use on electrical systems where voltage supplied to the unit terminals is not below or above the listed minimum and maximum limits. Maximum allowable phase imbalance is: voltage 2%; amps 10%.
2. All units/modules have single point primary power connection. (Each unit/module requires its own power supply.) Main power must be supplied from a field-supplied disconnect.
3. Cooler heater is wired into the control circuit so it is always operable as long as the power supply disconnect and heater safety device are on.

4. Power draw control circuits include both crankcase heaters (sizes 070-150 only) and cooler heaters (where used). Each compressor on sizes 070-090 has a crankcase heater which draws 90 watts of power, while each compressor on sizes 100-150 has a crankcase heater which draws 56 watts of power.
5. 30RAP chillers with Greenspeed® intelligence are not available on unit sizes 070-150.



30RAP ELECTRICAL DATA (cont)

SINGLE POINT HYDRONIC PACKAGE WITH OPTIONAL VALUE SOUND FANS (60 Hz ONLY), UNIT SIZES 070-150

30RAP UNIT SIZE	VOLTAGE V-Hz (3 Ph)	PUMP SIZE 1.5 hp				PUMP SIZE 3.0 hp				PUMP SIZE 5.0 hp			
		MCA	MOCP	ICF	REC FUSE	MCA	MOCP	ICF	REC FUSE	MCA	MOCP	ICF	REC FUSE
070	208/230-60	—	—	—	—	—	—	—	—	—	—	—	—
	380-60	—	—	—	—	—	—	—	—	—	—	—	—
	460-60	—	—	—	—	—	—	—	—	—	—	—	—
	575-60	—	—	—	—	—	—	—	—	—	—	—	—
080	208/230-60	—	—	—	—	—	—	—	—	—	—	—	—
	380-60	—	—	—	—	—	—	—	—	—	—	—	—
	460-60	—	—	—	—	—	—	—	—	—	—	—	—
	575-60	—	—	—	—	—	—	—	—	—	—	—	—
090	208/230-60	—	—	—	—	—	—	—	—	—	—	—	—
	380-60	—	—	—	—	—	—	—	—	—	—	—	—
	460-60	—	—	—	—	—	—	—	—	—	—	—	—
	575-60	—	—	—	—	—	—	—	—	—	—	—	—
100	208/230-60	—	—	—	—	—	—	—	—	—	—	—	—
	380-60	—	—	—	—	—	—	—	—	—	—	—	—
	460-60	—	—	—	—	—	—	—	—	—	—	—	—
	575-60	—	—	—	—	—	—	—	—	—	—	—	—
115	208/230-60	—	—	—	—	—	—	—	—	—	—	—	—
	380-60	—	—	—	—	—	—	—	—	—	—	—	—
	460-60	—	—	—	—	—	—	—	—	—	—	—	—
	575-60	—	—	—	—	—	—	—	—	—	—	—	—
130	208/230-60	—	—	—	—	—	—	—	—	—	—	—	—
	380-60	—	—	—	—	—	—	—	—	—	—	—	—
	460-60	—	—	—	—	—	—	—	—	—	—	—	—
	575-60	—	—	—	—	—	—	—	—	—	—	—	—
150	208/230-60	—	—	—	—	—	—	—	—	670.2	700	1112.4	700
	380-60	—	—	—	—	—	—	—	—	355.2	400	608.6	400
	460-60	—	—	—	—	—	—	—	—	300.1	350	508.1	350
	575-60	—	—	—	—	—	—	—	—	243.3	250	410.9	250

30RAP UNIT SIZE	VOLTAGE V-Hz (3 Ph)	PUMP SIZE 7.5 hp				PUMP SIZE 10.0 hp				PUMP SIZE 15.0 hp			
		MCA	MOCP	ICF	REC FUSE	MCA	MOCP	ICF	REC FUSE	MCA	MOCP	ICF	REC FUSE
070	208/230-60	344.5	400	614.7	400	351.0	400	621.2	400	—	—	—	—
	380-60	208.4	225	361.9	225	212.0	225	365.5	225	—	—	—	—
	460-60	166.4	175	311.8	175	169.2	175	314.6	175	—	—	—	—
	575-60	144.4	150	246.8	150	146.6	150	249.0	150	—	—	—	—
080	208/230-60	393.4	400	663.6	400	399.9	450	670.1	450	411.6	450	681.8	450
	380-60	225.0	250	378.5	250	228.6	250	382.1	250	235.6	250	389.1	250
	460-60	185.2	200	330.6	200	188.0	200	333.4	200	193.5	200	338.9	200
	575-60	159.3	175	261.7	175	161.5	175	263.9	175	166.3	175	268.7	175
090	208/230-60	406.9	450	677.1	450	413.4	450	683.6	450	425.1	450	695.3	450
	380-60	246.3	250	399.8	250	249.9	250	403.4	250	256.9	300	410.4	300
	460-60	196.6	200	342.0	200	199.4	225	344.8	225	204.9	225	350.3	225
	575-60	170.7	175	273.1	175	172.9	175	275.3	175	177.7	200	280.1	200
100	208/230-60	482.5	500	924.7	500	489.0	500	931.2	500	500.7	600	942.9	600
	380-60	252.9	300	506.3	300	256.5	300	509.9	300	263.5	300	516.9	300
	460-60	214.6	250	422.6	250	217.4	250	425.4	250	222.9	250	430.9	250
	575-60	172.4	200	340.0	200	174.6	200	342.2	200	179.4	200	347.0	200
115	208/230-60	540.1	600	931.3	600	546.6	600	937.8	600	558.3	600	949.5	600
	380-60	281.6	300	493.6	300	285.2	300	497.2	300	292.2	300	504.2	300
	460-60	239.5	250	413.6	250	242.3	250	416.4	250	247.8	250	421.9	250
	575-60	191.6	200	333.8	200	193.8	200	336.0	200	198.6	200	340.8	200
130	208/230-60	609.1	700	1051.3	700	615.6	700	1057.8	700	627.3	700	1069.5	700
	380-60	320.9	350	574.3	350	324.5	350	577.9	350	331.5	350	584.9	350
	460-60	271.7	300	479.7	300	274.5	300	482.5	300	280.0	300	488.0	300
	575-60	219.2	250	386.8	250	221.4	250	389.0	250	226.2	250	393.8	250
150 Dual Pump	208/230-60	673.3	700	1115.5	700	679.8	700	1122.0	700	691.5	700	1133.7	700
	380-60	357.5	400	610.9	400	361.1	400	614.5	400	368.1	400	621.5	400
	460-60	301.7	350	509.7	350	304.5	350	512.5	350	310.0	350	518.0	350
	575-60	244.9	250	412.5	250	247.1	250	414.7	250	251.9	300	419.5	300
150 Single Pump	208/230-60	676.8	700	1119.0	700	679.8	700	1122.0	700	691.5	700	1133.7	700
	380-60	359.4	400	612.8	400	361.1	400	614.5	400	368.1	400	621.5	400
	460-60	303.1	300	511.1	350	304.5	350	512.5	350	310.0	350	518.0	350
	575-60	246.0	250	413.6	250	247.1	250	414.7	250	251.9	300	419.5	300

LEGEND

- ICF — Instantaneous Current Flow
- MCA — Minimum Circuit Amps
- MOCP — Maximum Overcurrent Protection

NOTES:

1. Units are suitable for use on electrical systems where voltage supplied to the unit terminals is not below or above the listed minimum and maximum limits. Maximum allowable phase imbalance is: voltage 2%; amps 10%.
2. All units/modules have single point primary power connection. (Each unit/module requires its own power supply.) Main power must be supplied from a field-supplied disconnect.
3. Cooler heater is wired into the control circuit so it is always operable as long as the power supply disconnect and heater safety device are on.

4. Power draw control circuits include both crankcase heaters (sizes 070-150 only) and cooler heaters (where used). Each compressor on sizes 070-090 has a crankcase heater which draws 90 watts of power, while each compressor on sizes 100-150 has a crankcase heater which draws 56 watts of power.
5. 30RAP chillers with Greenspeed® intelligence are not available on unit sizes 070-150.



Electrical data (cont)



30RAP ELECTRICAL DATA (cont) DUAL POINT HYDRONIC PACKAGE WITH OPTIONAL VALUE SOUND FANS (60 Hz ONLY)

30RAP UNIT SIZE	VOLTAGE V-Ph-Hz	PUMP SIZE 5.0 hp, CIRCUIT 1				PUMP SIZE 5.0 hp, CIRCUIT 2			
		MCA	MOCP	ICF	REC FUSE	MCA	MOCP	ICF	REC FUSE
150	208/230-3-60	372.2	450	814.4	400	321.6	400	763.8	350
	380-3-60	199.2	225	452.6	225	168.3	200	421.7	200
	460-3-60	168.2	200	376.2	200	142.3	175	350.3	175
	575-3-60	136.2	150	303.8	150	115.6	125	283.2	125
30RAP UNIT SIZE	VOLTAGE V-Ph-Hz	PUMP SIZE 7.5 hp, CIRCUIT 1				PUMP SIZE 7.5 hp, CIRCUIT 2			
		MCA	MOCP	ICF	REC FUSE	MCA	MOCP	ICF	REC FUSE
070	208/230-3-60	158.6	200	428.8	175	199.9	250	470.1	225
	380-3-60	96.0	125	249.5	110	120.9	150	274.4	150
	460-3-60	77.0	100	222.4	90	96.1	110	241.5	110
	575-3-60	66.3	90	168.7	80	84.0	100	186.4	90
080	208/230-3-60	206.3	250	442.2	225	199.9	250	470.1	225
	380-3-60	110.8	125	216.2	125	120.9	150	274.4	150
	460-3-60	94.9	110	216.0	110	96.1	110	241.5	110
	575-3-60	80.3	100	164.4	90	84.0	100	186.4	90
090	208/230-3-60	221.0	250	491.2	250	199.9	250	470.1	225
	380-3-60	133.9	150	287.4	150	120.9	150	274.4	150
	460-3-60	107.2	125	252.6	125	96.1	110	241.5	110
	575-3-60	92.6	110	195.0	100	84.0	100	186.4	90
100	208/230-3-60	239.0	300	681.2	300	262.3	300	653.5	300
	380-3-60	127.3	175	380.7	150	135.2	150	347.2	150
	460-3-60	107.8	125	315.8	125	115.0	125	289.1	125
	575-3-60	86.8	110	254.4	100	92.2	110	234.4	100
115	208/230-3-60	296.6	350	687.8	350	262.3	300	653.5	300
	380-3-60	156.0	175	368.0	175	135.2	150	347.2	150
	460-3-60	132.7	150	306.8	150	115.0	125	289.1	125
	575-3-60	106.0	125	248.2	125	92.2	110	234.4	100
130	208/230-3-60	303.2	350	694.4	350	324.7	400	766.9	350
	380-3-60	159.9	175	371.9	175	170.6	200	424.0	200
	460-3-60	136.0	150	310.1	150	143.9	175	351.9	175
	575-3-60	108.6	125	250.8	125	117.2	150	284.8	150
150 Dual Pump	208/230-3-60	372.2	450	814.4	400	324.7	400	766.9	350
	380-3-60	199.2	225	452.6	225	170.6	200	424.0	200
	460-3-60	168.2	200	376.2	200	143.9	175	351.9	175
	575-3-60	136.2	150	303.8	150	117.2	150	284.8	150
150 Single Pump	208/230-3-60	372.2	450	814.4	400	328.2	400	770.4	400
	380-3-60	199.2	225	452.6	225	172.5	200	425.9	200
	460-3-60	168.2	200	376.2	200	145.3	175	353.3	175
	575-3-60	136.2	150	303.8	150	118.3	150	285.9	150

LEGEND

- ICF** — Instantaneous Current Flow
MCA — Minimum Circuit Amps
MOCP — Maximum Overcurrent Protection

NOTES:

- Units are suitable for use on electrical systems where voltage supplied to the unit terminals is not below or above the listed minimum and maximum limits. Maximum allowable phase imbalance is: voltage 2%; amps 10%.
- All units/modules have single point primary power connection. (Each unit/module requires its own power supply.) Main power must be supplied from a field-supplied disconnect.
- Cooler heater is wired into the control circuit so it is always operable as long as the power supply disconnect and heater safety device are on.

- Power draw control circuits include both crankcase heaters (sizes 070-150 only) and cooler heaters (where used). Each compressor on sizes 070-090 has a crankcase heater which draws 90 watts of power, while each compressor on sizes 100-150 has a crankcase heater which draws 56 watts of power.
- 30RAP chillers with Greenspeed® intelligence are not available on unit sizes 070-150.



30RAP ELECTRICAL DATA (cont)
DUAL POINT HYDRONIC PACKAGE WITH OPTIONAL VALUE SOUND FANS (60 Hz ONLY) (cont)

30RAP UNIT SIZE	VOLTAGE V-Ph-Hz	PUMP SIZE 10.0 hp CIRCUIT 1				PUMP SIZE 10.0 hp CIRCUIT 2			
		MCA	MOCP	ICF	REC FUSE	MCA	MOCP	ICF	REC FUSE
070	208/230-3-60	158.6	200	428.8	175	206.4	250	476.6	225
	380-3-60	96.0	125	249.5	110	124.5	150	278.0	150
	460-3-60	77.0	100	222.4	90	98.9	125	244.3	110
	575-3-60	66.3	90	168.7	80	86.2	100	188.6	100
080	208/230-3-60	206.3	250	442.2	225	206.4	250	476.6	225
	380-3-60	110.8	125	216.2	125	124.5	150	278.0	150
	460-3-60	94.9	110	216.0	110	98.9	125	244.3	110
	575-3-60	80.3	100	164.4	90	86.2	100	188.6	100
090	208/230-3-60	221.0	250	491.2	250	206.4	250	476.6	225
	380-3-60	133.9	150	287.4	150	124.5	150	278.0	150
	460-3-60	107.2	125	252.6	125	98.9	125	244.3	110
	575-3-60	92.6	110	195.0	100	86.2	100	188.6	100
100	208/230-3-60	239.0	300	681.2	300	268.8	300	660.0	300
	380-3-60	127.3	175	380.7	150	138.8	175	350.8	150
	460-3-60	107.8	125	315.8	125	117.8	150	291.9	150
	575-3-60	86.8	110	254.4	100	94.4	110	236.6	110
115	208/230-3-60	296.6	350	687.8	350	268.8	300	660.0	300
	380-3-60	156.0	175	368.0	175	138.8	175	350.8	150
	460-3-60	132.7	150	306.8	150	117.8	150	291.9	150
	575-3-60	106.0	125	248.2	125	94.4	110	236.6	110
130	208/230-3-60	303.2	350	694.4	350	331.2	400	773.4	400
	380-3-60	159.9	175	371.9	175	174.2	225	427.6	200
	460-3-60	136.0	150	310.1	150	146.7	175	354.7	175
	575-3-60	108.6	125	250.8	125	119.4	150	287.0	150
150	208/230-3-60	372.2	450	814.4	400	331.2	400	773.4	400
	380-3-60	199.2	225	452.6	225	174.2	225	427.6	200
	460-3-60	168.2	200	376.2	200	146.7	175	354.7	175
	575-3-60	136.2	150	303.8	150	119.4	150	287.0	150

30RAP UNIT SIZE	VOLTAGE V-Ph-Hz	PUMP SIZE 15.0 hp CIRCUIT 1				PUMP SIZE 15.0 hp CIRCUIT 2			
		MCA	MOCP	ICF	REC FUSE	MCA	MOCP	ICF	REC FUSE
070	208/230-3-60	—	—	—	—	—	—	—	—
	380-3-60	—	—	—	—	—	—	—	—
	460-3-60	—	—	—	—	—	—	—	—
	575-3-60	—	—	—	—	—	—	—	—
080	208/230-3-60	206.3	250	442.2	225	218.1	250	488.3	250
	380-3-60	110.8	125	216.2	125	131.5	150	285.0	150
	460-3-60	94.9	110	216.0	110	104.4	125	249.8	125
	575-3-60	80.3	100	164.4	90	91.0	110	193.4	100
090	208/230-3-60	221.0	250	491.2	250	218.1	250	488.3	250
	380-3-60	133.9	150	287.4	150	131.5	150	285.0	150
	460-3-60	107.2	125	252.6	125	104.4	125	249.8	125
	575-3-60	92.6	110	195.0	100	91.0	110	193.4	100
100	208/230-3-60	239.0	300	681.2	300	280.5	350	671.7	300
	380-3-60	127.3	175	380.7	150	145.8	175	357.8	175
	460-3-60	107.8	125	315.8	125	123.3	150	297.4	150
	575-3-60	86.8	110	254.4	100	99.2	125	241.4	110
115	208/230-3-60	296.6	350	687.8	350	280.5	350	671.7	300
	380-3-60	156.0	175	368.0	175	145.8	175	357.8	175
	460-3-60	132.7	150	306.8	150	123.3	150	297.4	150
	575-3-60	106.0	125	248.2	125	99.2	125	241.4	110
130	208/230-3-60	303.2	350	694.4	350	342.9	400	785.1	400
	380-3-60	159.9	175	371.9	175	181.2	225	434.6	200
	460-3-60	136.0	150	310.1	150	152.2	175	360.2	175
	575-3-60	108.6	125	250.8	125	124.2	150	291.8	150
150	208/230-3-60	372.2	450	814.4	400	342.9	400	785.1	400
	380-3-60	199.2	225	452.6	225	181.2	225	434.6	200
	460-3-60	168.2	200	376.2	200	152.2	175	360.2	175
	575-3-60	136.2	150	303.8	150	124.2	150	291.8	150

LEGEND

- ICF** — Instantaneous Current Flow
MCA — Minimum Circuit Amps
MOCP — Maximum Overcurrent Protection

NOTES:

- Units are suitable for use on electrical systems where voltage supplied to the unit terminals is not below or above the listed minimum and maximum limits. Maximum allowable phase imbalance is: voltage 2%; amps 10%.
- All units/modules have dual point primary power connection. (Each unit/module requires its own power supply.) Main power must be supplied from a field-supplied disconnect.
- Cooler heater is wired into the control circuit so it is always operable as long as the power supply disconnect is on, even if any safety device is open.

- Power draw control circuits include both crankcase heaters (sizes 070-150 only) and cooler heaters (where used). Each compressor on sizes 070-090 has a crankcase heater which draws 90 watts of power, while each compressor on sizes 100-150 has a crankcase heater which draws 56 watts of power.
- 30RAP chillers with Greenspeed® intelligence are not available on unit sizes 070-150.



FAN ELECTRICAL DATA

SINGLE POINT, STANDARD LOW-SOUND AEROACOUSTIC™ FANS UNIT SIZES 011-060

UNIT 30RAP	UNIT VOLTAGE V-Hz (3 Ph)	STANDARD CONDENSER FANS	
		Quantity	FLA (each)
011	208/230-60	1	6.0
	380-60	1	3.9
	380/415-50	1	2.9
	460-60	1	2.9
	575-60	1	2.4
016	208/230-60	1	6.0
	380-60	1	3.9
	380/415-50	1	2.9
	460-60	1	2.9
	575-60	1	2.4
018	208/230-60	2	6.0
	380-60	2	3.9
	380/415-50	2	2.9
	460-60	2	2.9
	575-60	2	2.4
020	208/230-60	2	6.0
	380-60	2	3.9
	380/415-50	2	2.9
	460-60	2	2.9
	575-60	2	2.4
025	208/230-60	2	6.0
	380-60	2	3.9
	380/415-50	2	2.9
	460-60	2	2.9
	575-60	2	2.4
030	208/230-60	2	6.0
	380-60	2	3.9
	380/415-50	2	2.9
	460-60	2	2.9
	575-60	2	2.4
035	208/230-60	3	6.0
	380-60	3	3.9
	380/415-50	3	2.9
	460-60	3	2.9
	575-60	3	2.4
040	208/230-60	3	6.0
	380-60	3	3.9
	380/415-50	3	2.9
	460-60	3	2.9
	575-60	3	2.4
045	208/230-60	3	6.0
	380-60	3	3.9
	380/415-50	3	2.9
	460-60	3	2.9
	575-60	3	2.4
050	208/230-60	3	6.0
	380-60	3	3.9
	380/415-50	3	2.9
	460-60	3	2.9
	575-60	3	2.4
055	208/230-60	4	6.0
	380-60	4	3.9
	380/415-50	4	2.9
	460-60	4	2.9
	575-60	4	2.4
060	208/230-60	4	6.0
	380-60	4	3.9
	380/415-50	4	2.9
	460-60	4	2.9
	575-60	4	2.4

SINGLE POINT, STANDARD LOW-SOUND AEROACOUSTIC™ FANS UNIT SIZES 070-150

UNIT 30RAP	UNIT VOLTAGE V-Hz (3 Ph)	STANDARD CONDENSER FANS	
		Quantity	FLA (each)
070	208/230-60	5	6.0
	380-60	5	3.9
	380/415-50	5	2.9
	460-60	5	2.9
	575-60	5	2.4
080	208/230-60	6	6.0
	380-60	6	3.9
	380/415-50	6	2.9
	460-60	6	2.9
	575-60	6	2.4
090	208/230-60	6	6.0
	380-60	6	3.9
	380/415-50	6	2.9
	460-60	6	2.9
	575-60	6	2.4
100	208/230-60	7	6.0
	380-60	7	3.9
	380/415-50	7	2.9
	460-60	7	2.9
	575-60	7	2.4
115	208/230-60	8	6.0
	380-60	8	3.9
	380/415-50	8	2.9
	460-60	8	2.9
	575-60	8	2.4
130	208/230-60	9	6.0
	380-60	9	3.9
	380/415-50	9	2.9
	460-60	9	2.9
	575-60	9	2.4
150	208/230-60	10	6.0
	380-60	10	3.9
	380/415-50	10	2.9
	460-60	10	2.9
	575-60	10	2.4

LEGEND

FLA — Full Load Amps

NOTES:

- Units are suitable for use on electrical systems where voltage supplied to the unit terminals is not below or above the listed minimum and maximum limits. Maximum allowable phase imbalance is: voltage 2%; amps 10%.
- All units/modules have single point primary power connection. (Each unit/module requires its own power supply.) Main power must be supplied from a field-supplied disconnect.
- The unit control circuit power transformer (24 v, single-phase for all voltages) is factory supplied.
- Cooler heater is wired into the control circuit so it is always operable as long as the power supply disconnect and heater safety device are on.
- 30RAP chillers with Greenspeed® intelligence are not available on unit sizes 070-150.

FAN ELECTRICAL DATA (cont)

SINGLE POINT, OPTIONAL VALUE SOUND FANS UNIT SIZES 011-060

UNIT 30RAP	UNIT VOLTAGE V-Hz (3 Ph)	OPTIONAL CONDENSER FANS	
		Quantity	FLA (each)
011	208/230-60	1	6.6
	380-60	1	3.9
	380/415-50	1	3.3
	460-60	1	3.3
	575-60	1	2.6
016	208/230-60	1	6.6
	380-60	1	3.9
	380/415-50	1	3.3
	460-60	1	3.3
	575-60	1	2.6
018	208/230-60	2	6.6
	380-60	2	3.9
	380/415-50	2	3.3
	460-60	2	3.3
	575-60	2	2.6
020	208/230-60	2	6.6
	380-60	2	3.9
	380/415-50	2	3.3
	460-60	2	3.3
	575-60	2	2.6
025	208/230-60	2	6.6
	380-60	2	3.9
	380/415-50	2	3.3
	460-60	2	3.3
	575-60	2	2.6
030	208/230-60	2	6.6
	380-60	2	3.9
	380/415-50	2	3.3
	460-60	2	3.3
	575-60	2	2.6
035	208/230-60	3	6.6
	380-60	3	3.9
	380/415-50	3	3.3
	460-60	3	3.3
	575-60	3	2.6
040	208/230-60	3	6.6
	380-60	3	3.9
	380/415-50	3	3.3
	460-60	3	3.3
	575-60	3	2.6
045	208/230-60	3	6.6
	380-60	3	3.9
	380/415-50	3	3.3
	460-60	3	3.3
	575-60	3	2.6
050	208/230-60	3	6.6
	380-60	3	3.9
	380/415-50	3	3.3
	460-60	3	3.3
	575-60	3	2.6
055	208/230-60	4	6.6
	380-60	4	3.9
	380/415-50	4	3.3
	460-60	4	3.3
	575-60	4	2.6
060	208/230-60	4	6.6
	380-60	4	3.9
	380/415-50	4	3.3
	460-60	4	3.3
	575-60	4	2.6

LEGEND

FLA — Full Load Amps

NOTES:

- Units are suitable for use on electrical systems where voltage supplied to the unit terminals is not below or above the listed minimum and maximum limits. Maximum allowable phase imbalance is: voltage 2%; amps 10%.
- All units/modules have single point primary power connection. (Each unit/module requires its own power supply.) Main power must be supplied from a field-supplied disconnect.
- The unit control circuit power transformer (24 v, single-phase for all voltages) is factory supplied.
- Cooler heater is wired into the control circuit so it is always operable as long as the power supply disconnect and heater safety device are on.
- 30RAP chillers with Greenspeed® intelligence are not available on unit sizes 070-150.

SINGLE POINT, OPTIONAL VALUE SOUND FANS UNIT SIZES 070-150

UNIT 30RAP	UNIT VOLTAGE V-Hz (3 Ph)	OPTIONAL CONDENSER FANS	
		Quantity	FLA (each)
070	208/230-60	5	6.6
	380-60	5	3.9
	380/415-50	5	3.3
	460-60	5	3.3
	575-60	5	2.6
080	208/230-60	6	6.6
	380-60	6	3.9
	380/415-50	6	3.3
	460-60	6	3.3
	575-60	6	2.6
090	208/230-60	6	6.6
	380-60	6	3.9
	380/415-50	6	3.3
	460-60	6	3.3
	575-60	6	2.6
100	208/230-60	7	6.6
	380-60	7	3.9
	380/415-50	7	3.3
	460-60	7	3.3
	575-60	7	2.6
115	208/230-60	8	6.6
	380-60	8	3.9
	380/415-50	8	3.3
	460-60	8	3.3
	575-60	8	2.6
130	208/230-60	9	6.6
	380-60	9	3.9
	380/415-50	9	3.3
	460-60	9	3.3
	575-60	9	2.6
150	208/230-60	10	6.6
	380-60	10	3.9
	380/415-50	10	3.3
	460-60	10	3.3
	575-60	10	2.6

Electrical data (cont)



PUMP ELECTRICAL DATA (60 Hz ONLY)

30RAP SIZE	PUMP OPTION	PUMP SIZE	PUMP RPM	UNIT VOLTAGE V-Hz (3 Ph)	FLA (each)
011-060	2, 9	1.5 HP	3500	208/230-60	4.3
			3500	380-60	2.4
			3500	460-60	2.1
			3500	575-60	1.6
	3, 4, B, C	3.0 HP	3500	208/230-60	7.9
			3500	380-60	4.4
			3500	460-60	3.7
			3500	575-60	3.0
	5, 6, D, F	5.0 HP	3500	208/230-60	12.6
			3500	380-60	7.0
			3500	460-60	5.8
			3500	575-60	4.6
	7, G	7.5 HP	3500	208/230-60	18.5
			3500	380-60	10.4
			3500	460-60	8.7
			3500	575-60	7.0
	Z, H	10.0 HP	3500	208/230-60	25.0
			3500	380-60	14.0
			3500	460-60	11.5
			3500	575-60	9.2
070-150	2, D	5.0 HP	1750	208/230-60	15.4
				380-60	8.1
				460-60	7.1
				575-60	5.4
	3, 8, F, L	7.5 HP	1750 - 150 ton single	208/230-60	22.0
				380-60	12.3
				460-60	10.1
				575-60	8.1
	4, 9, G, M	10.0 HP	3500	208/230-60	18.5
				380-60	10.4
				460-60	8.7
				575-60	7.0
5, B, H, N	15.0 HP	3500	208/230-60	25.0	
			380-60	14.0	
			460-60	11.5	
			575-60	9.2	
5, B, H, N	15.0 HP	3500	208/230-60	36.7	
			380-60	21.0	
			460-60	17.0	
			575-60	14.0	

LEGEND

FLA — Full Load Amps

NOTES:

- Units are suitable for use on electrical systems where voltage supplied to the unit terminals is not below or above the listed minimum and maximum limits. Maximum allowable phase imbalance is: voltage 2%; amps 10%.

- All units/modules have single point primary power connection. (Each unit/module requires its own power supply.) Main power must be supplied from a field-supplied disconnect.
- The unit control circuit power transformer (24 v, single-phase for all voltages) is factory supplied.
- Cooler heater is wired into the control circuit so it is always operable as long as the power supply disconnect and heater safety device are on.
- 30RAP chillers with Greenspeed® intelligence are not available on unit sizes 070-150.

FIELD WIRING SIZES

CONNECTION TYPE	30RAP UNIT SIZES	MCA RANGE	WIRE SIZE RANGE	MAXIMUM NUMBER OF WIRES PER PHASE	HIGH SCCR FUSE TYPE
TERMINAL BLOCK	011-060	MCA up to 175	14 AWG to 2/0 AWG	1	J, T, RK1, RK5, G, CC
		MCA 175.1 to 335	6 AWG to 400 kcmil	1	J, T, RK1, RK5, G, CC
	070-150	MCA up to 420	2 AWG to 600 kcmil	1	J, T, RK1, RK5, G, CC
		MCA 420.1 to 760	6 AWG to 500 kcmil	2	J, T, RK1, RK5, G, CC
NON-FUSED DISCONNECT	ALL	MCA up to 100	14 AWG to 3/0 AWG	1	—
		MCA 100.1 to 250	6 AWG to 350 kcmil	1	—
		MCA 250.1 to 600	3/0 AWG to 500 kcmil	2	—

LEGEND

AWG — American Wire Gage
MCA — Minimum Circuit Amps
SCCR — Short Circuit Current Rating

NOTES:

1. Wiring for main field supply must be rated 75 C. Use copper conductors only.
2. High SCCR option not available on dual point power units or with 208/230-v units at sizes 30RAP100-150.
3. 30RAP chillers with Greenspeed® intelligence are not available on unit sizes 070-150.

ACCESSORY TANK ELECTRICAL DATA FOR 30RAP011-060 ONLY

UNIT VOLTAGE (V-Hz)	ACCESSORY PART NO. 30RA-900---	FLA
208/230-60	050	11.3
	051	11.3
	052	22.6
460-60	050	5.7
	051	5.7
	052	11.3
575-60	050	7.1
	051	7.1
	052	14.1
380-60	050	4.7
	051	4.7
	052	9.3
380/415-50	050	4.9
	051	4.9
	052	9.8

LEGEND

FLA — Full Load Amps

NOTE: The storage tank obtains its power from the chiller. No separate power source is required.

COMPRESSOR ELECTRICAL DATA SINGLE/DUAL POINT — UNIT SIZES 011-060

UNIT 30RAP	NUMBER OF COMPRESSORS PER CIRCUIT	UNIT VOLTAGE V-Hz (3 Ph)	CIRCUIT*			
			CIRCUIT A		CIRCUIT B	
			RLA	LRA	RLA	LRA
011	2	208/230-60	23.2, 16.0	164, 110	—	—
		380-60	12.2, 8.5	73, 66	—	—
		380/415-50	11.2, 7.8	75, 52	—	—
		460-60	11.2, 7.8	75, 52	—	—
		575-60	7.9, 5.7	54, 39	—	—
016	2	208/230-60	28.2, 23.2	240, 164	—	—
		380-60	16.0, 12.2	135, 73	—	—
		380/415-50	14.7, 11.2	130, 75	—	—
		460-60	14.7, 11.2	130, 75	—	—
		575-60	11.3, 7.9	94, 54	—	—
018	2	208/230-60	33.4	225	—	—
		380-60	19.2	140	—	—
		380/415-50	16.7	114	—	—
		460-60	16.7	114	—	—
		575-60	13.4	80	—	—
020	2	208/230-60	35.8	239	—	—
		380-60	23.7	145	—	—
		380/415-50	17.9	125	—	—
		460-60	17.9	125	—	—
		575-60	14.3	80	—	—
025	2	208/230-60	51.3	300	—	—
		380-60	26.9	139	—	—
		380/415-50	23.1	150	—	—
		460-60	23.1	150	—	—
		575-60	19.9	109	—	—
030	2	208/230-60	55.8	340	—	—
		380-60	34.0	196	—	—
		380/415-50	26.9	179	—	—
		460-60	26.9	179	—	—
		575-60	23.7	132	—	—
035	2	208/230-60	35.8	239	33.4	225
		380-60	23.7	145	19.2	140
		380/415-50	17.9	125	16.7	114
		460-60	17.9	125	16.7	114
		575-60	14.3	80	13.4	80
040	2	208/230-60	35.8	239	48.1	245
		380-60	23.7	145	23.7	145
		380/415-50	17.9	125	18.6	125
		460-60	17.9	125	18.6	125
		575-60	14.3	80	14.7	100
045	2	208/230-60	48.1	245	51.3	300
		380-60	23.7	145	23.7	145
		380/415-50	18.6	125	23.1	150
		460-60	18.6	125	23.1	150
		575-60	14.7	100	19.9	109
050	2	208/230-60	51.3	300	51.3	300
		380-60	26.9	139	26.9	139
		380/415-50	23.1	150	23.1	150
		460-60	23.1	150	23.1	150
		575-60	19.9	109	19.9	109
055	2	208/230-60	51.3	300	55.8	340
		380-60	26.9	139	34.0	196
		380/415-50	23.1	150	26.9	179
		460-60	23.1	150	26.9	179
		575-60	19.9	109	23.7	132
060	2	208/230-60	55.8	340	55.8	340
		380-60	34.0	196	34.0	196
		380/415-50	26.9	179	26.9	179
		460-60	26.9	179	26.9	179
		575-60	23.7	132	23.7	132

LEGEND

LRA — Locked Rotor Amps
RLA — Rated Load Amps

* All data is per individual compressor. Where two values are shown for Circuit A (sizes 011, 016, and 100), first value is for compressor 1 and second value is for compressor 2.

NOTE: 30RAP chillers with Greenspeed intelligence are not available on unit sizes 070-150.

**COMPRESSOR ELECTRICAL DATA SINGLE/DUAL POINT —
UNIT SIZES 070-150**

UNIT 30RAP	NUMBER OF COMPRESSORS PER CIRCUIT	UNIT VOLTAGE V-Hz (3 Ph)	CIRCUIT*			
			CIRCUIT A		CIRCUIT B	
			RLA	LRA	RLA	LRA
070	2/3†	208/230-60	55.8	340	55.8	340
		380-60	34.0	196	34.0	196
		380/415-50	26.9	179	26.9	179
		460-60	26.9	179	26.9	179
		575-60	23.7	132	23.7	132
080	3	208/230-60	51.3	300	55.8	340
		380-60	26.9	139	34.0	196
		380/415-50	23.1	150	26.9	179
		460-60	23.1	150	26.9	179
		575-60	19.9	109	23.7	132
090	3	208/230-60	55.8	340	55.8	340
		380-60	34.0	196	34.0	196
		380/415-50	26.9	179	26.9	179
		460-60	26.9	179	26.9	179
		575-60	23.7	132	23.7	132
100	2/3†	208/230-60	94.2, 75.0	560, 485	75.0	485
		380-60	49.3, 38.4	315, 260	38.4	260
		380/415-50	41.6, 32.7	260, 215	32.7	215
		460-60	41.6, 32.7	260, 215	32.7	215
		575-60	33.9, 26.2	210, 175	26.2	175
115	3	208/230-60	75.0	485	75.0	485
		380-60	38.4	260	38.4	260
		380/415-50	32.7	215	32.7	215
		460-60	32.7	215	32.7	215
		575-60	26.2	175	26.2	175
130	3	208/230-60	75.0	485	94.2	560
		380-60	38.4	260	49.3	315
		380/415-50	32.7	215	41.6	260
		460-60	32.7	215	41.6	260
		575-60	26.2	175	33.9	210
150	3	208/230-60	94.2	560	94.2	560
		380-60	49.3	315	49.3	315
		380/415-50	32.7	260	41.6	260
		460-60	41.6	260	41.6	260
		575-60	33.9	210	33.9	210

LEGEND

LRA — Locked Rotor Amps
RLA — Rated Load Amps

* All data is per individual compressor. Where two values are shown for Circuit A (sizes 011, 016, and 100), first value is for compressor 1 and second value is for compressor 2.

† Circuit A has 2 compressors; Circuit B has 3 compressors.

NOTE: 30RAP chillers with Greenspeed intelligence are not available on unit sizes 070-150.

Microprocessor — The *ComfortLink* microprocessor controls overall unit operation. Its central executive routine controls a number of processes simultaneously. These include internal timers, reading inputs, analog to digital conversions, fan control, display control, diagnostic control, output relay control, demand limit, capacity control, head pressure control, and temperature reset. Some processes are updated almost continuously, others every 2 to 3 seconds, and some every 30 seconds. The microprocessor routine is started by switching the Emergency ON-OFF switch to ON position. Pump control of external pumps (where so configured) or optional internal pump (60 Hz only), will energize the cooler pump to the internal (or CCN) time schedule (or input occupied signal from external system).

Where dual pumps are utilized, only one pump will be used at a time. The control will start the pump with the least number of operating hours. When the unit receives a call for cooling (based on a deviation from chilled water set point), the unit stages up in capacity to maintain the cooler fluid set point. The first compressor starts 1 to 3 minutes after the call for cooling. The *ComfortLink* microprocessor controls the capacity of the chiller by cycling compressors at a rate to satisfy actual dynamic load conditions. The control maintains leaving-fluid temperature set point shown on the scrolling marquee display board through intelligent cycling of compressors. Accuracy depends on loop volume, loop flow rate, load, outdoor-air temperature, number of stages, and particular stage being cycled off. No adjustment for cooling range or cooler flow rate is required, because the control automatically compensates for cooling range by measuring both return-fluid temperature and leaving-fluid temperature. This is referred to as leaving-fluid temperature control with return-fluid temperature compensation.

The basic logic for determining when to add or remove a stage is a time band integration of deviation from set point plus rate of change of leaving-fluid temperature. When leaving-fluid temperature is close to set point and slowly moving closer, logic prevents addition of another stage.

If 1°F per minute (0.6°C per minute) pulldown control has been selected (adjustable setting), no additional steps of capacity are added as long as difference between leaving-fluid temperature and set point is greater than 4°F (2.2°C) and rate of change in leaving-fluid temperature is greater than the selected pulldown control rate. If it has been less than 90 seconds since the last capacity change, compressors will continue to run unless a safety device trips. This prevents rapid cycling and also helps return oil during short on periods.

Sensors — Thermistors are used for temperature-sensing inputs to microprocessor. Additional thermistor sensors may be used as remote temperature sensors for optional LCWT (leaving chilled fluid temperature) reset.

- Cooler leaving chilled fluid temperature
- Cooler entering fluid (return) temperature
- Outside-air temperature
- Compressor suction temperature

Two refrigerant pressure transducers are used in each circuit for sensing suction and discharge pressure. The

microprocessor uses these inputs to control capacity, the electronic expansion valve, and fan cycling.

- Saturated condensing temperature
- Cooler saturation temperature

Control sequence

Off cycle — If ambient temperature is below 36°F (2°C), cooler heaters (if equipped) are also energized.

Start-up — After control circuit switches on, the prestart process takes place, then microprocessor checks itself, starts pump (if configured) and waits for temperature to stabilize. The controlled pulldown feature limits compressor loading on start-up to reduce demand on start-up and unnecessary compressor usage. The microprocessor limits supply-fluid temperature decrease (start-up only) to 1°F (0.6°C) per minute.

Capacity control — On first call for cooling, microprocessor starts initial compressor and fan stage on lead circuit.

As additional cooling is required, additional compressors are energized.

Speed at which capacity is added or reduced is controlled by temperature deviation from set point and rate of temperature change of chilled fluid.

The Main Base Board (MBB) responds to temperature of supply chilled water to cycle the compressor(s) and to control compressor unloading and loading to match cooling load requirements.

Hot gas bypass valve is energized by the MBB. Valve allows hot gas to pass directly into the cooler circuit on the final step of unloading, maintaining constant suction pressure and permitting the unit to operate at lower loads with less compressor cycling.

On units equipped with the digital compressor option (available on sizes 011-090), the control will integrate the modulation of the digital compressor into the capacity routine to match cooling load requirements. The digital compressor option will modulate in 21 steps for sizes 011 and 016, 22 steps for sizes 018-030, 44 steps for sizes 035-060, 55 steps for size 070, and 66 steps for sizes 080 and 090.

The digital scroll option provides better capacity control by incrementally modulating capacity effectively, increasing the number of compression stages compared to chillers that are not equipped with this option. The digital scroll compressor is not a variable speed device, it modulates the capacity output by allowing the scroll sets to separate during operation, alternating between full capacity and zero capacity. Utilizing a fixed timeframe ratio, the percentage of time that the scroll set is engaged is the percentage capacity of that compressor.

There are 2 major advantages of this type of capacity control. First, there is closer capacity control operation with all the available capacity steps compared to the on/off cycling control of conventional scrolls. Second, there is much less wear factor on digital scrolls compared to standard scroll compressors because the digital scrolls are not subject to as many of the shutdown/restart cycles as conventional scrolls. Digital scrolls, rather than shutting off, tend to remain on as they vary to deliver the correct capacity step.

STANDARD CAPACITY CONTROL STEPS

UNIT 30RAP	STANDARD CAPACITY STEPS (%)
011	0, 40, 60, 100
016	0, 40, 60, 100
018	0, 50, 100
020	0, 50, 100
025	0, 50, 100
030	0, 50, 100
035	0, 23, 46, 73, 100
040	0, 23, 46, 73, 100
045	0, 24, 48, 74, 100
050	0, 25, 50, 75, 100
055	0, 23, 46, 73, 100
060	0, 25, 50, 75, 100
070	0, 20, 40, 60, 80, 100
080	0, 15, 31, 46, 64, 82, 100
090	0, 17, 33, 50, 67, 83, 100
100	0, 19, 38, 57, 76, 100
115	0, 17, 33, 50, 67, 83, 100
130	0, 15, 30, 44, 63, 81, 100
150	0, 17, 33, 50, 67, 83, 100

Additional information — Detailed information on controls and operation is available in the Controls, Operation, and Troubleshooting literature included with each unit. Packaged service training programs are also available. Contact your Carrier representative for more information.

High-efficiency variable condenser fans (30RAP chillers with Greenspeed® intelligence only) — All fans on a circuit run at the same speed and are controlled by a VFD with special CCN software to maintain SCT (saturated condensing temperature) set point. The set point is calculated from operating conditions and adjusted to the most efficient operating point. The high-efficiency variable condenser fan option uses Danfoss VLT 102 variable frequency drives, each with a display. Drives are connected to the LEN communication bus. Fan speed is determined by the chiller controller and communicated to the drive to provide excellent part load efficiency and reduced sound level operation over the life of the chiller.

Dual chiller control — The *ComfortLink* controller allows 2 chillers (piped in parallel) to operate as a single chilled water plant with standard control functions coordinated through the master chiller controller. This standard *ComfortLink* feature requires a communication link between the 2 chillers and an additional thermistor and well in the common supply line.

Dynamic *ComfortLink* controls — Dynamic *ComfortLink* controls keep the chiller on line during periods of extreme operating conditions. If the entering fluid temperature is 85°F (29°C) or higher and the saturated suction temperature is 60°F (16°C) or higher the maximum operating pressure (MOP) feature limits the suction to keep the chiller online. The control automatically starts the chiller in the unloaded state to eliminate the potential of compressor overload due to high head pressure or low suction pressure. The controller will equalize run time on each circuit through the lead/lag feature. If a circuit becomes disabled, the control will automatically set the active circuit to lead, keeping the chiller online at a reduced capacity.

Standard *ComfortLink* controls with scrolling marquee display module — A four-digit alphanumeric display shows all of the *ComfortLink* control codes (with 60-character expandable clear language), plus set points, time of day, temperatures, pressures, and superheat. Additional information can be displayed all at once with the accessory Navigator™ display.

Navigator display module — An optional 4-line, 20-character per line display is also available as a field-installed accessory.

Low-temperature override — This feature prevents LCWT (leaving chilled fluid temperature) from overshooting the set point and possibly causing a nuisance trip-out by the freeze protection.

High-temperature override — This feature allows chiller to add capacity quickly during rapid load variations.

Abnormal conditions — All control safeties in chiller operate through compressor sensor board and the microprocessor.

Loss of feedback signal to the MBB will cause the compressor(s) to shut down. For other safeties, microprocessor makes appropriate decision to shut down a compressor due to a safety trip or bad sensor reading and displays appropriate failure code on the display. Chiller holds in safety mode until reset. It then reverts to normal control when unit is reset.

Low-pressure safety — Safety cuts out if system pressure drops below minimum.

High-pressure cutout — Switch shuts down compressors if compressor discharge pressure increases to 650 psig (4482 kPa).

Compressor anti-cycling — This feature limits compressor cycling.

Loss of flow protection — Proof of flow switches are standard and installed on all 30RAP chillers.

Sensor failures — Failures are detected by the microprocessor.

Temperature reset — The energy management module (EMM) is required for 4 to 20 mA reset of LCWT in constant fluid systems. Reset by return fluid, outdoor-air temperature, or space temperature does not require this option. Reset reduces compressor power usage at part load when design LCWT is not necessary. Humidity control should be considered since higher coil temperatures resulting from reset will reduce latent heat capacity. Three reset options are offered, based on the following:

Return-fluid temperature — Increases LCWT set point as return (or entering) fluid temperature decreases (indicating load decrease). Option may be used in any application where return fluid provides accurate load indication. Limitation of return fluid reset is that LCWT may only be reset to value of design return fluid temperature.

Outdoor-air temperature — Increases LCWT as outdoor ambient temperature decreases (indicating load decrease). This reset should be applied only where outdoor ambient temperature is an accurate indication of load.

Space temperature — Increases LCWT as space temperature decreases (indicating load decrease). This reset should be applied only where space temperature is an accurate indication of load. An accessory thermistor and the energy management module accessory is required.

For details on applying a reset option, refer to unit Controls, Operation, and Troubleshooting literature. Obtain ordering part numbers for reset option from the Packaged Chiller Builder program or contact your local Carrier representative.

Accessory controls — Demand can be limited by controlling the chiller capacity through the demand limit control (the energy management module is required for this function). This FIOP (factory-installed option)/accessory interfaces with microprocessor to control unit so that chiller's kW demand does not exceed its setting. It is activated from an external switch or a 4 to 20 mA signal.

The standard *ComfortLink* controller is programmed to accept various accessory temperature reset options (based on outdoor-air temperature [standard], return-fluid temperature, or space temperature), that reset the LCWT. An accessory thermistor for space temperature reset is required. The energy management module (EMM) is only required for temperature reset that is initiated by a 4 to 20 mA signal.

Demand limit — If applied, the demand limit function limits the total power draw of unit to selected point by controlling number of operational compressors during periods of peak electrical demand.

The energy management module is required for either 2-stage or 4 to 20 mA demand limit.

Electronic expansion valve (EXV) — The EXV controls refrigerant flow to the cooler for different operating conditions by moving an orifice to increase or decrease the flow area through the valve based on microprocessor input. The orifice is positioned by a stepper motor and is monitored every 3 seconds. The EXV maintains approximately 9°F (5°C) refrigerant superheat entering the compressor.

Diagnostics — The microprocessor may be put through a service test (see Controls, Operation, and Troubleshooting literature). Service test confirms microprocessor is functional, informs observer through display the condition of each sensor and switch in chiller, and allows observer to check for proper operation of fans and compressors.

Default settings — To facilitate quick start-ups, 30RAP chillers with *ComfortLink* controls are pre-configured with a default setting that assumes stand-alone operation supplying 44°F (6.7°C) chilled water.

Configuration settings will be based on any options or accessories included with the unit at the time of manufacturing.

Date and time are set to U.S.A. Eastern Time zone and will need reconfiguring based on location and local time zone. If operation based on occupancy scheduling is desired, this will also need to be set during installation.

Ice duty — *ComfortLink* controls have the capability of reduced leaving fluid temperature operation for thermal storage, or ice duty. The optional energy management module includes input contacts for the "ice done" signal generated by the thermal storage control system. The ice duty feature may be configured to start on an external input command or by the *ComfortLink* standard internal scheduling function. Ice duty may be used in combination with any other standard features offered by the energy management module and *ComfortLink* controls.

The production of ice, which is stored for peak cooling demands, can significantly decrease energy costs. The unit produces ice (normally at night) by supplying ice storage tanks with low temperature cooling fluid. The chiller takes advantage of reduced ambient conditions at night for ice-making mode, so the capacity suffers a lower penalty for the low leaving fluid temperatures.

At peak cooling demands the chiller and the stored ice may share the cooling load to reduce operating costs. The thermal storage system may potentially reduce the size of the chiller plant required to meet demand loads.

Typical control wiring schematic

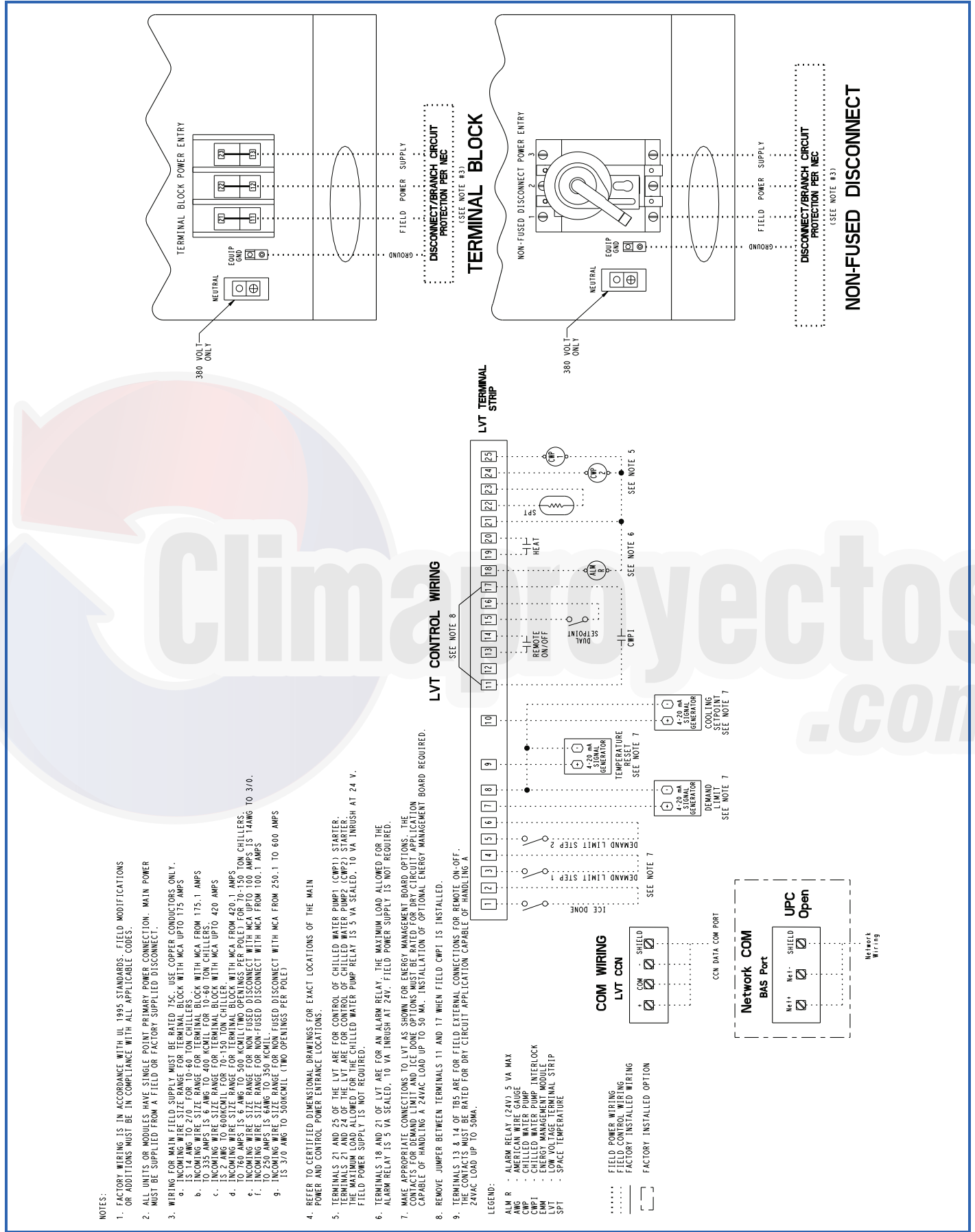

Chiller location and clearances

The 30RAP unit must be installed outdoors.

Do not locate near sound-sensitive areas without proper acoustic consideration. For applications requiring mounting a chiller on a building rooftop, consideration should be given to using rubber-in-shear or spring isolators to minimize structure-borne transmission. Unit must be level when installed to ensure proper oil return to the compressors. Clearances must be provided around chillers for airflow, service and local code requirements. See dimensional drawings for specific unit clearance requirements. Ensure adequate clearance between adjacent chillers is maintained.

For 30RAP011-060: When parallel chillers are aligned such that coils face each other, a minimum of 6 ft (1829 mm) is recommended. When the parallel arrangement has only one coil drawing air from the space between chillers, a minimum of 3.5 ft (1067 mm) is recommended. When parallel chillers have no coils facing each other (a back-to-back arrangement), be sure to maintain the larger of the recommended service clearances associated with each chiller (see the certified drawings). Due to NEC (National Electric Code, U.S.A.) regulations, a minimum clearance of 4 ft (1219 mm) must be maintained on the side of the chiller that has an electrical box. Chiller fan discharge is strongly recommended to be at least as high as adjacent solid walls. Installation in pits is not recommended.

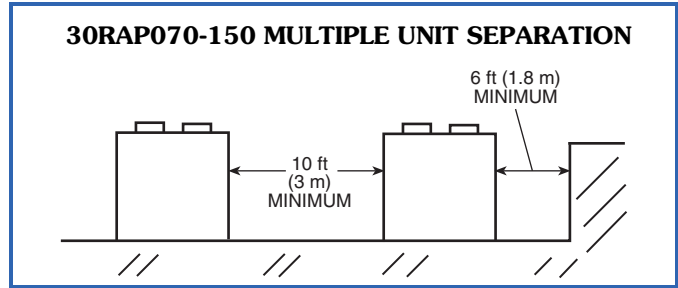
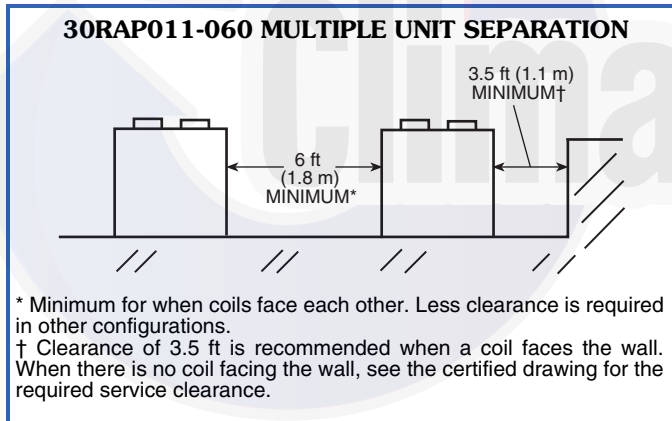

For 30RAP070-150: When chillers are arranged in parallel, a minimum of 10 ft (3048 mm) between chillers is recommended. Acceptable clearance on the cooler connection side or end opposite the control box of the unit can be reduced to 3 ft (1 m) without sacrificing performance as long as the remaining three sides are unrestricted. Acceptable clearance on the side with a control box can be reduced to 4 ft (1.3 m) due to NEC (National Electric Code, U.S.A.) regulations, without sacrificing performance as long as the remaining three sides are unrestricted. Clearances between chillers in dual chiller applications may be reduced to 6 ft (1.8 m) without sacrificing performance provided the remaining sides are unrestricted.

There are applications, however, in which recommended minimum clearances are not available. In these situations, customers request a prediction of the chiller performance within the confined space. A generalized derating factor may be insufficient to fully predict performance with various real-life physical layouts and ambient conditions.

To improve performance predictions when recommended clearances cannot be met, Carrier has developed the ExpertFit™ Software Model (for 30RAP070-150 only). An interface in the computerized chiller selection program predicts air-cooled chiller performance within a confined space, taking into account various spatial constraints and conditions, thus providing actual performance reports and not just derate guidelines.

Using this tool will provide the customer with a realistic expectation for their actual installation. The illustration below is an example of a typical installation that the software can model.

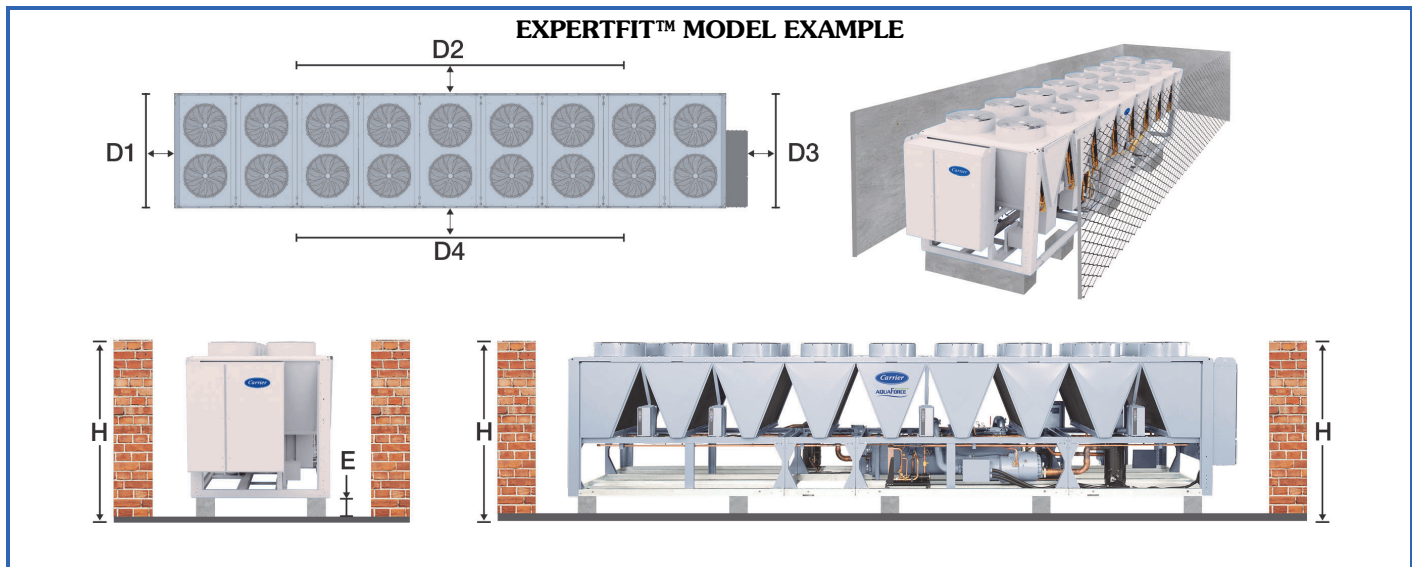

Oversizing chillers

Oversizing chillers by more than 15% at design conditions must be avoided as the system operating efficiency is adversely affected (resulting in greater or excessive electrical demand). When future expansion of equipment is anticipated, install a single chiller to meet present load requirements and add a second chiller to meet the additional load demand. It is also recommended that 2 smaller chillers be installed where operation at minimum load is critical. The operation of a smaller chiller loaded to a greater percentage over minimum is preferred to operating a single chiller at or near its minimum recommended value. Hot gas bypass should not be used as a means to allow oversizing chillers. Hot gas bypass should be given consideration where substantial operating time is anticipated below the minimum unloading step.

Multiple chillers

Where chiller capacities greater than can be supplied by a single 30RAP chiller are required, or where standby capability is desired, chillers may be installed in parallel. Units may be of the same or different sizes with this piping arrangement. However, cooler flow rates must be balanced to ensure proper flow to each chiller.

When multiple 30RAP chillers are applied in parallel, and the chillers include the optional hydronic package (60 Hz applications only) which contains expansion tanks (sizes 011-060), the individual chiller expansion tanks must be disconnected and a single field-supplied expansion tank must be installed in the common header.

Unit software is capable of controlling two parallel units as a single plant by making use of the dual chiller control feature. Refer to the Controls, Start-up, Operation, Service and Troubleshooting guide for further details. The accessory Chillervisor System Manager can be used to ensure proper staging sequence of up to 8 chillers arranged in a parallel configuration. Refer to the accessory Chillervisor System Manager installation instructions for further details.

If the dual chiller algorithm is used, and the machines are installed in parallel, one chiller must be configured as the master chiller and the other as the slave. With this configuration, an additional leaving fluid temperature thermistor must be installed as shown in the Parallel Chiller Installation figure.

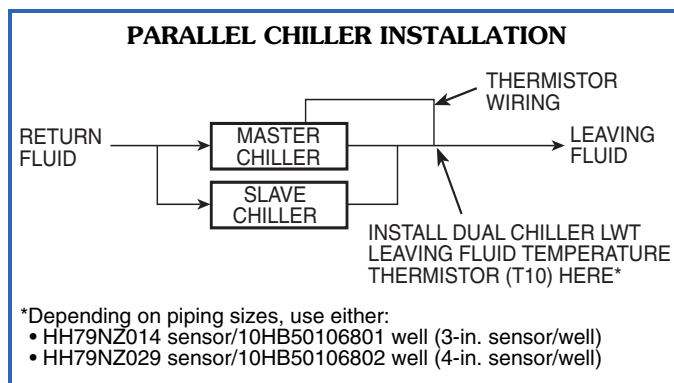

Parallel chiller control with dedicated pumps is recommended. The chiller must start and stop its own water pump located in its own piping. Check valves are required at the discharge of each pump (*when the factory hydronic*

package option is chosen [60 Hz only], and dual pumps are selected, the check valves are automatically supplied). If pumps are not dedicated for each chiller, then isolation valves are required. Each chiller must open and close its own isolation valve through the unit control (the valve must be connected to the pump outputs).

If a series application is required, the master/slave control feature cannot be used. Hydronic pump packages may not be applied in series applications.

Series chillers

Where a large temperature drop (greater than 20°F [11.1°C]) is desired, or where chiller capacities greater than what can be supplied by a single 30RAP chiller are required, or where standby capability is required, chillers may be installed in series. The leaving fluid temperature sensors need not be relocated. However, the cooler minimum entering fluid temperature limitations should be considered for the chillers located downstream of other chillers.

Cooler water temperature

1. Maximum leaving chilled water (fluid) temperature (LCWT) for the unit is 60°F (15.6°C). Unit can start and pull down with up to 95°F (35°C) entering-fluid temperature. It is recommended that entering-fluid temperature not exceed 70°F (21.1°C).
2. Minimum LCWT for fresh water applications is 40°F (4.4°C). For leaving-fluid temperatures between 14 and 39.9°F (-10.0°C and 4.4°C) an inhibited anti-freeze solution in the fluid loop is required, but no modification to the 30RAP chiller (accessory medium temperature brine, for example) is required.

NOTE: For leaving-fluid temperatures below 35°F (2°C), neither hot gas bypass nor the digital compressor option are to be employed.

NOTE: Water flowing through cooler should not exceed 100°F (38°C).

NOTE: The 30RAP011-060 chillers do not require a medium temperature brine modification at any temperature within the chiller application range which is as low as 14°F (-10°C) leaving-fluid temperature. For 30RAP070-150, the appropriate field charge adjustment is required. See Controls, Start Up, Operation, Service, and Troubleshooting Guide for details.

Strainers

A 40 mesh strainer is installed in the cooler fluid inlet line, just ahead of the cooler.

STRAINER REQUIREMENTS

APPLICATION	30RAP WITH BRAZED PLATE HEAT EXCHANGER	
	With Hydronic Package*	Without Hydronic Package
	Type of Strainer	
Closed Loop	40 Mesh (Factory Supplied)	40 Mesh (Factory Supplied)
Open Loop	See Note	See Note

* Unlike other air-cooled models, 30RAP units with a hydronic package are not shipped with (and do not require) a fine mesh start-up strainer.

NOTE: Refer to the Water Quality Characteristics and Limitations table on page 94 for water requirements. Open-loop systems do not typically meet these requirements. Water treatment must be considered to satisfy this criterion.

Cooler flow/range

Ratings and performance data in this publication are for a cooling temperature rise of 10°F (6°C). The 30RAP chillers may be operated at a different temperature rise, providing flow limits are not exceeded and corrections to system guidelines are made. For minimum and maximum cooler flow rates, see the Minimum and Maximum Cooler Flow Rates table. A high flow rate is generally limited by the maximum pressure drop that can be tolerated by the unit. The 30RAP chillers are designed for a full load temperature rise of 3° to 20°F (1.7° to 11.1°C). Use the Packaged Chiller Builder Program to obtain the rating if a temperature rise other than 10°F (6°C) is used.

Minimum cooler flow (maximum cooler temperature rise) — The minimum cooler flow for standard units is shown in Minimum and Maximum Cooler Fluid Flow Rates table. When system design conditions require a lower flow (or higher rise) than the minimum allowable cooler flow, follow the recommendations below.

- Multiple smaller chillers may be applied in series, each providing a portion of the design temperature rise.
- Cooler fluid may be recirculated to raise the flow rate to the chiller. The mixed temperature entering the cooler must be maintained to a minimum of at least 3°F (1.7°C) above the LCWT and to a maximum of no more than 20°F (11.1°C) above the LCWT.

NOTE: Recirculation flow is shown below.

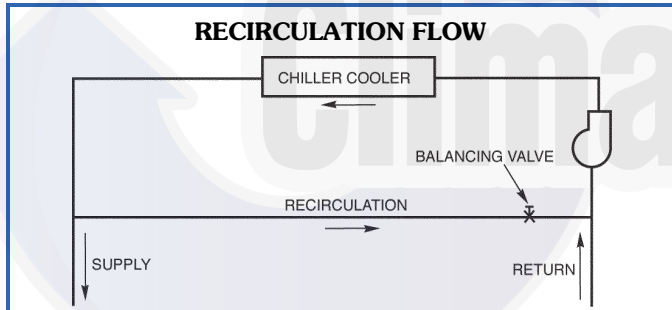

Maximum cooler flow — The maximum cooler flow (approximately 3°F [1.7°C] rise) results in a practical maximum pressure drop through cooler.

Return fluid may bypass the cooler to keep the pressure drop through the cooler within acceptable limits. This permits a higher delta T with lower fluid flow through cooler and mixing after the cooler. The mixed temperature entering the cooler must be maintained to a minimum of at least 3°F (1.7°C) above the LCWT and to a maximum of no more than 20°F (11.1°C) above the LCWT.

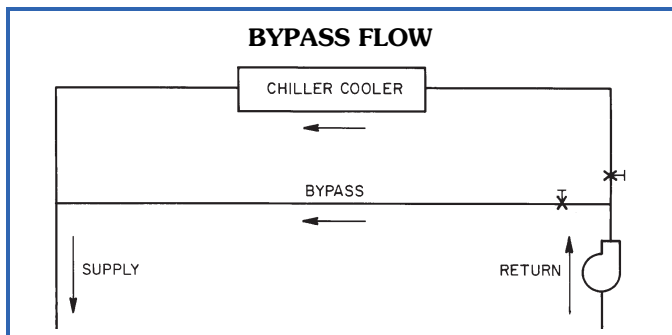

Variable cooler flow rates

Variable flow rates may be applied to a standard chiller. The unit will, however, attempt to maintain a constant leaving chilled water temperature. In such cases, minimum flow must be in excess of minimum flow given in the Minimum and Maximum Cooler Fluid Flow Rates table on page 92, and minimum fluid volume in circulation must be in excess of those values shown for normal air-conditioning applications in the Minimum Fluid Volume in Circulation table. Flow rate must change in steps of less than 10% per minute. Apply 6 gal. or more per ton (6.5 L per kW) water loop volume minimum if flow rate changes more rapidly.

All 30RAP chillers are available without a hydronic pumping package. For 60 Hz applications, a constant-speed pumping package is available on all sizes, or a pumping package with a variable-speed drive is available on sizes 070-150. Traditional pumping systems incorporate constant-speed drives and waste energy by relying upon throttling valves as the only means to control flow. A more energy-efficient approach to this issue is use a variable-speed drive.

The major cost of a pump over its lifetime will be energy consumption and maintenance, and both of these factors will be reduced using variable-speed pumping. Energy is saved by the combination of lowering the pump speed in conjunction with the resulting lowering of pumping system resistance when conditions permit. Maintenance benefits from the sensorless pumping system include the lack of the need to maintain remote sensors as well as the beneficial effects of lower speed/pressure on the pump and pump bearings.

Another advantage associated with variable-speed pumping is reduced system noise in part load operation when the pump is running at lower speeds. The 60 Hz variable-speed pump package offered on the 30RAP is offered both in single and dual-pump designs. In the dual pump case, in which one pump is the back-up of the other, each pump connection is fitted with an isolation valve which allows one pump to be isolated for service with the other pump still operating.

As already mentioned, the 30RAP variable-speed hydronic package employs sensorless technology. The term "sensorless" means that no remote sensors are required for pump operation. The sensorless pump control monitors system requirements for pump speed and power. The hydronic unit is provided with a pre-defined control curve to automatically adjust speed at all operating conditions. Pump performance and characteristic curves for multiple speeds are programmed into the speed-controller memory. The pre-programmed information includes power, pressure and flow throughout the entire range of the pump. During chiller operation, the power and speed of the pump are monitored. This enables the controller to establish the hydraulic performance, and to position the pump's head-flow characteristic. Although this curve is pre-defined, it is also fully field adjustable. The pump has a graphical user interface, and the graphic keypad can also be used to allow manual pump speed control.

This variable-speed pumping system easily connects to BMS (Building Management System) systems (BACnet is

standard, and LON can be obtained via special order). The pumps may be controlled directly by the BMS system. The sensorless feature can also be switched off to allow the use of either a 0 to 10 VDC signal or a 0 to 20 mA signal.

For multiple chiller applications employing the variable-speed pumping package, such as chillers operated in a parallel arrangement, the drives must be connected by control wiring and set up to run the same speed. This is to prevent surging or hunting of the speed set point. One drive will act as the master while the other slave drive will run at the same speed. The master drive may be controlled by a 0 to 10 VDC signal, a 0 to 20 mA signal, or a BMS. The drive must be configured to not use the sensorless function in this arrangement.

A typical example of a chiller operating with a variable-speed pumping system would be the case when the user requires the chiller to operate with a constant fluid temperature difference as the load is reduced. This can be accomplished with the 30RAP variable-speed pumping package (60 Hz only) with the understanding that the minimum allowable flow for the chiller must be respected. Once that limit is reached, the flow cannot be further reduced. To accomplish this purpose, the minimum speed of the drive is pre-set based upon the chiller size that is being employed.

As a specific example, let us say the schedule calls for a 90-ton, fresh-water chiller, and it is desired to have a constant 10-degree temperature difference in part load operation (say 54 to 44°F). The schedule calls for 216 gpm at full load based upon the desired capacity and the fluid temperature difference. A constant temperature difference in part load operation is essentially the same as providing flow in direct proportion to chiller load. In the present example, this means that 100% load will run at the scheduled 216 gpm, 90% load will be 194 gpm, etc. down to the minimum allowable flow for this unit size, which, in the case of a 30RAP090 unit, is 107 gpm. The chiller in this example will therefore be able to run down to just under 50% load while approximately maintaining a constant 10 degree fluid temperature difference, and then the flow will be held constant for all lower loads. Throughout the range in which flow is reduced (down to minimum allowable flow), the pump speed is proportionally reduced, resulting in pump energy savings.

Fluid loop volume

The minimum volume of fluid required to be in circulation is a function of the number of compressors in the chiller, the type of application, and whether or not a device providing additional unloading steps is employed. The minimum fluid in circulation must equal or exceed the values in the following table. Note that in process cooling applications, or for operation at ambient temperatures below 32°F (0°C) with low loading conditions, there should be more volume than is required for normal air-conditioning applications.

MINIMUM FLUID VOLUME IN CIRCULATION

30RAP UNIT SIZE	NORMAL AIR CONDITIONING APPLICATION gal/ton (L per kW)			PROCESS COOLING OR LOW AMBIENT OPERATION APPLICATION gal/ton (L per kW)		
	Std Unit	HGBP	Digital	Std Unit	HGBP	Digital
011-016	12 (13)	N/A	3 (3.3)	12 (13)	N/A	6 (6.5)
018-030	6 (6.5)	4 (4.3)	3 (3.3)	10 (10.8)	10 (10.8)	6 (6.5)
035-150	3 (3.3)	3 (3.3)	3 (3.3)	6 (6.5)	6 (6.5)	6 (6.5)

LEGEND

HGBP — Hot Gas Bypass

To achieve this fluid volume, it is often necessary to install a tank in the loop. The tank should be baffled to ensure there is no stratification and that water (or brine) entering the tank is adequately mixed with liquid in the tank. A fluid storage tank is available as an accessory.

The piping between the chiller and the accessory tank can be done to allow the tank to be on the return side of the chiller (tank piped to chiller inlet) or the supply side of the chiller (tank piped to the chiller outlet). However, it is recommended that the tank be piped to the return side of the chiller to buffer any changes in load to allow more stable chiller operation.

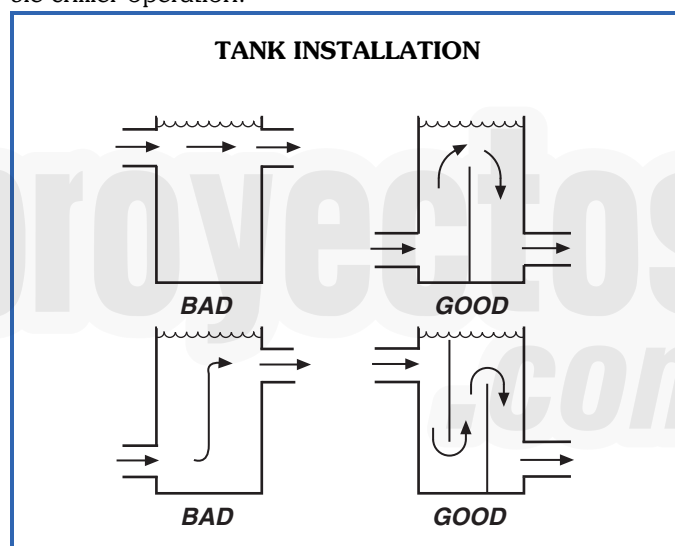

Tank volume and weight

A properly baffled storage tank is available as an accessory on 30RAP011-060 units. These tanks are designed to physically fit beneath the corresponding 30RAP unit, taking up the same footprint. Available volume is as follows:

30RAP011-016	83 gallons (314 liters)
30RAP018-030	119 gallons (450 liters)
30RAP035-060	241 gallons (912 liters)

Storage tank weight (water weight included) is as follows:

30RAP011-016	1673 lb (759 kg)
30RAP018-030	2193 lb (995 kg)
30RAP035-060	4361 lb (1978 kg)

NOTE: This tank will obtain power from the main unit. No separate power source is required.

NOTE: Units with storage tanks weigh considerably more than units without tanks.

Cooler fouling factor

The fouling factor used to calculate tabulated ratings is 0.00010 ft² • hr • °F/Btu (0.000018 m² • °C/W). As fouling factor is increased, unit capacity decreases and compressor power increases. Use the NACO (North American Commercial Operation) Packaged Chiller Builder for corrections to published ratings.

Cooler and hydronic system freeze protection

Freeze protection for down to -20°F (-28.9°C) for 60 Hz applications and -15°F (-26°C) for 50 Hz applications for the cooler and hydronic package (when available, 60 Hz only) is available as a factory-installed option. Since power is sometimes lost for extended periods during winter storms, freeze protection provided by heater tapes will be effective only if a back-up power supply can be assured for the unit's control circuit, heater and cooler pump. If not protected with an antifreeze solution, draining the cooler and outdoor piping is recommended if the system will not be used during freezing weather conditions.

Two conditions that must be considered when determining antifreeze concentration are leaving water set point and ambient freeze conditions. Both of these parameters can help determine the recommended concentration level. Higher concentration must be used to adequately protect the machine.

NOTE: Use only antifreeze solutions approved for heat exchanger duty.

For applications in which the leaving water temperature set point is less than 40°F (4.4°C), a suitable inhibited antifreeze solution must be used. The solution concentration must be sufficient to protect the chilled water loop to a freeze protection (first crystals) concentration of at least 15°F (8.3°C) below the leaving water temperature set point.

If the chiller refrigerant or fluid lines are in an area where ambient conditions fall below 34°F (1°C), it is required that an antifreeze solution be added to protect the unit and fluid piping to a temperature of 15°F (8.3°C) below the lowest anticipated ambient temperature.

Select concentration based on either burst or freeze protection as dictated by the application. If the chiller does not operate during the winter, nor is a start-up expected, a burst protection concentration is recommended. This concentration may not be high enough to pump the fluid through the unit. Burst protection is typically a lower concentration that will provide better performance from the machine. If the chiller does operate during winter, a freeze protection concentration is recommended. This concentration will be high enough to keep the fluid in a condition that it can be pumped at low ambient conditions.

IMPORTANT: Glycol anti-freeze solutions are highly recommended since heater tapes provide no protection in the event of a power failure.

Consult glycol fluid manufacturers for burst protection recommendations and fluid specifications.

High ambient temperature operation

High outdoor ambient chiller start-up and operation is possible for standard 30RAP chillers at ambient temperatures up to 120°F (50°C) at nominal voltage. The unit will additionally be able to stay running at reduced capacity up to 125°F (52°C).

Low ambient temperature operation

Units will start and operate down to -20°F (-29°C) on size 011 and 016 units, 45°F (7°C) on size 018-030 units, and 32°F (0°C) on size 035-150 units as standard.

MINIMUM AND MAXIMUM COOLER FLOW RATES

30RAP SIZE	MINIMUM COOLER FLOW RATE (gpm)*	MAXIMUM COOLER FLOW RATE (gpm)	MINIMUM COOLER FLOW RATE (l/s)*	MAXIMUM COOLER FLOW RATE (l/s)
011	13	50	0.8	3.2
016	16	64	1.0	4.1
018	20	78	1.3	4.9
020	23	91	1.5	5.7
025	28	112	1.8	7.1
030	33	133	2.1	8.4
035	42	168	2.6	10.6
040	48	192	3.0	12.1
045	53	211	3.3	13.3
050	57	228	3.6	14.4
055	63	251	4.0	15.8
060	68	270	4.3	17.0
070	87	310	5.5	19.6
080	98	350	6.2	22.1
090	107	382	6.8	24.1
100	123	444	7.8	28.0
115	140	503	8.8	31.7
130	159	574	10.0	36.1
150	175	629	11.0	39.6

* For minimum cooler flow rate with brine applications, refer to E-CAT software performance tables.

Start-up and operation down to as low as -20°F (-29°C) ambient temperature for sizes 018-150 require the inclusion of either low ambient head pressure control or high-efficiency variable condenser fans. (To achieve these low ambient temperatures, no additional option needs to be selected on unit sizes 011 and 016 since they automatically include high-efficiency variable condenser fans.) Wind baffles are also required for such low-temperature applications. Inhibited propylene glycol or other suitable corrosion-resistant anti-freeze solution must be field supplied and installed in all units for unit operation below 32°F (0°C). Solution must be added to fluid loop to protect loop down to 15°F (8°C) below minimum operating ambient temperature. Concentration should be based on expected minimum temperature and either “Burst” or “Freeze” protection levels. At least 6 gal. per ton (6.5 L per kW) of fluid volume is the recommended minimum for a moderate system load.

NOTE: In order for a chiller to operate at -20°F (-29°C) ambient temperature, the minimum load on the chiller must be above the minimum step of unloading.

NOTE: As an alternative to requiring a glycol solution, the cooler may be remotely located. Burying refrigerant lines is never permitted.

High-efficiency variable condenser fans

Highly efficient part load performance is available with variable speed condenser fan motors controlled by variable speed drives. In most applications, the chiller will run at part load conditions the vast majority of the time, and this is particularly the case if the application has a 24/7 duty cycle. This option will lower utility costs while producing a scroll compressor design that is best-in-class in part load efficiency. This is the essence of 3ORAP chillers with Greenspeed® intelligence. (High-efficiency variable condenser fans are not available with sizes 070-150.)

Altitude correction factors

Correction factors must be applied to standard ratings at altitudes above 2000 ft (610 m). Use the NACO Packaged Chiller Builder to determine the altitude effect on performance.

Water system overview (closed loop systems only)

The 3ORAP chillers are designed for use with closed systems, meaning that there is no more than one water-air interface in the water loop. Cooling tower loops, for example, have two water-air interfaces (sump and nozzles) and would thus be classified as open, whereas a correctly designed chilled water loop with the only water-air interface being in the expansion tank is closed. Since closed and open water systems behave very differently, the following assumes that the chilled water loop is closed. A system installed incorrectly such that air is not handled properly — pipe leaks, vent leaks, air in pipes, etc. — may behave as an open system and thus have unsatisfactory operation. Pump seal wear can also cause leaks that cause poor system operation.

Proper closed system design and installation procedures should be followed closely. The system must be constructed with pressure tight components and thoroughly tested for installation leaks. Factory-supplied hydronic systems are avail-

able for 60 Hz applications with single or dual (for back-up) pumps. The factory-installed system includes all of the components within the dashed lines shown in the figure on page 63.

Installation of water systems should follow sound engineering practice as well as applicable local and industry standards. Improperly designed or installed systems may cause unsatisfactory operation and/or system failure. Consult a water treatment specialist or appropriate literature for information regarding filtration, water treatment, and control devices. A typical installation with components that might be installed with the hydronic package of the 3ORAP unit is shown on pages 60-62.

It is recommended that isolation (shutoff) valves be placed exterior to the unit to allow removal and service of the entire pump assembly, if necessary. Also, if the unit is isolated with valves, a properly sized pressure relief valve should be installed in the piping between the unit and the valves, following all applicable state and local codes.

Water system cleaning

Proper water system cleaning is of vital importance. Excessive particulates in the water system can cause excessive pump seal wear, reduce or stop flow, and cause damage of other components. Water quality should be maintained within the limits indicated in the Water Quality Characteristics and Limitations table.

1. Install a temporary bypass around the chiller to avoid circulating dirty water and particulates into the pump package and chiller during the flush. Use a temporary circulating pump during the cleaning process. Also, be sure that there is capability to drain the system fully after cleaning.
2. Be sure to use a cleaning agent that is compatible with all system materials. Be especially careful if the system contains any galvanized or aluminum components. Both detergent-dispersant and alkaline-dispersant cleaning agents are available.
3. It is a good idea to fill the system through a water meter. This provides a reference point for the future for loop volume readings, but it also establishes the correct quantity of cleaner needed in order to get the required concentration.
4. Use a feeder/transfer pump to mix the solution and fill the system. Circulate the cleaning system for the length of time recommended by the cleaning agent manufacturer.
 - a. After cleaning, drain the cleaning fluid and flush the system with fresh water.
 - b. A slight amount of cleaning residue in the system can help keep the desired, slightly alkaline, water pH of 8 to 9. Avoid a pH greater than 10, since this will adversely affect pump seal components.
 - c. A side stream filter is recommended during the cleaning process. Filter side flow rate should be enough to filter the entire water volume every 3 to 4 hours. Change filters as often as necessary during the cleaning process.
 - d. Remove temporary bypass when cleaning is complete.

WATER QUALITY CHARACTERISTICS AND LIMITATIONS

WATER CHARACTERISTIC	QUALITY LIMITATION
Alkalinity (HCO ₃)	70 – 300 ppm
Sulfate (SO ₄ ²⁻)	Less than 70 ppm
HCO ₃ /SO ₄ ²⁻	Greater than 1.0
Electrical Conductivity	10 – 500 µS/cm
pH	7.5 – 9.0
Ammonium (NH ₃)	Less than 2 ppm
Chlorides (Cl ⁻)	Less than 300 ppm
Free Chlorine (Cl ₂)	Less than 1 ppm
Hydrogen Sulfide (H ₂ S)*	Less than 0.05 ppm
Free (aggressive) Carbon Dioxide (CO ₂)†	Less than 5 ppm
Total Hardness (dH)	4.0 – 8.5
Nitrate (NO ₃)	Less than 100 ppm
Iron (Fe)	Less than 0.2 ppm
Aluminum (Al)	Less than 0.2 ppm
Manganese (Mn)	Less than 0.1 ppm

*Sulfides in the water quickly oxidize when exposed to air, requiring that no agitation occur as the sample is taken. Unless tested immediately at the site, the sample will require stabilization with a few drops of one Molar zinc acetate solution, allowing accurate sulfide determination up to 24 hours after sampling. A low pH and high alkalinity cause system problems, even when both values are within the ranges shown. The term pH refers to the acidity, basicity, or neutrality of the water supply. Below 7.0, the water is considered to be acidic. Above 7.0, water is considered to be basic. Neutral water contains a pH of 7.0.

†Dissolved carbon dioxide can either be calculated from the pH and total alkalinity values, shown below, or measured on the site using a test kit. Dissolved Carbon Dioxide, PPM = TA x 2^[(6.3-pH)/0.3] where TA = Total Alkalinity, PPM as CaCO₃.

A 40 mesh strainer with a blow-down valve is standard on all 3ORAP units, both with and without hydronic packages. The blow-down valve allows removal of particulates caught in the strainer without complete removal of the screen. A female NPT connection is provided on the valve, allowing hose connection for drainage outside the unit.

The *ComfortLink* controls provided have a built-in feature to remind building owners or operators to clean the strainer by discharging the blow-down valve at a pre-set time interval. Properly installed and cleaned systems will rarely need the strainer cleaned after the initial fill. This time interval is user-configurable.

Condenser coil protection (*Enviro-Shield*™)

Refer to the environmental selection guides for more information. If the standard Novation® (microchannel) coil does not meet the corrosion requirements for a given application, additional coil options are available. For specific geographical recommendations, please refer to the NACO (North American Commercial Operations) Packaged Chiller Builder program.

Aluminum fin/copper tube coils are constructed of seamless copper tubes mechanically bonded to aluminum fins. The fins have wavy enhancements. These condenser coils are recommended with remote cooler applications. These coils are not recommended for corrosive environments.

Pre-coated aluminum-fin coils have a durable epoxy-phenolic coating applied to the fin prior to the fin stamping process to provide protection in mildly corrosive coastal environments. Pre-coated coils have an inert barrier between the aluminum fin and copper tube. This barrier electrically disconnects the dissimilar metals to minimize

the potential for galvanic corrosion. This economical option provides substantial corrosion protection beyond the standard uncoated coil construction.

Copper-fin coils provide increased corrosion resistance compared to aluminum fin coils. All-copper coils eliminate bimetallic construction to eliminate the potential for galvanic corrosion. Application in industrial environments is not recommended due to potential attack from sulfur, sulfur oxide, nitrogen oxides, carbon and several other industrial airborne contaminants.

E-coated Novation® coils have an extremely flexible and durable epoxy coating uniformly applied to all coil surfaces. Unlike brittle phenolic dip and bake coatings, e-coat provides superior protection with unmatched flexibility, edge coverage, metal adhesion, thermal performance and most importantly, corrosion resistance. E-coated coils provide this protection since all coil surfaces are completely encapsulated from environmental contamination. This option provides the best protection for Novation coil technology. E-coated aluminum microchannel coils shall be capable of withstanding an 8,000-hour salt spray test in accordance with the ASTM (American Society for Testing and Materials) B-117 Standard.

E-coated aluminum-fin coils have the same flexible and durable epoxy coating as e-coated Novation coils. This option provides better protection compared to standard or pre-coated aluminum-fin coils in many environments.

E-coated copper-fin coils have the same flexible and durable epoxy coating as other e-coated coils. However, this option combines the natural salt and environmental resistance of all-copper construction with the highest level of corrosion protection within the round-tube, plate-fin type of coils.

Electrical/utility interests

Energy management — Use of energy management practices can significantly reduce operating costs, especially during off-peak modes of operation. Demand limiting and temperature reset are 2 techniques for accomplishing efficient energy management. See Demand Limiting (also called load shedding) section on this page for further details.

Demand limiting (load shedding) — When a utility's demand for electricity exceeds a certain level, loads are shed to keep electricity demand below a prescribed maximum level. Typically, this happens on hot days when air conditioning is most needed. The energy management module (EMM) can be added to accomplish this reduction. Demand may be limited on unit by resetting the fluid temperature, or by unloading the chiller to a given predetermined percentage of the load. Demand limit may also be driven by an external 4 to 20 mA signal. These features require a signal from an intelligent central control. Do not cycle demand limiter for less than 10 minutes on and 5 minutes off. Duty cycling cycles electrical loads at regular intervals regardless of need. This reduces the electrical operating costs of building by "fooling" demand indicating devices. Duty cycling of compressors or fans is not recommended since motor winding and bearing life will suffer from constant cycling.

Remote on-off control

Remote on-off control may be applied by hard-wired connection (see Controls and Troubleshooting literature) or by connection to a Carrier Comfort Network® (CCN) system.

Optional hydronic system selection (60 Hz applications only)

Select pump gpm from resulting chiller selection and total pressure loss in the system plus the chiller internal pressure loss.

NOTE: Maximum gpm (L/s), pressure and pump hp must not exceed maximum on pump curve.

NOTE: Optional hydronic system is available in constant-speed configuration on all models. It is also available in VFD configuration on sizes 070-150, as described in Variable Cooler Flow Rates section.

Pump flow can be reduced by using the factory-supplied triple-duty valve up to 10%. Beyond that, impeller trimming is recommended to reduce energy consumption. Follow local codes or ASHRAE 90.1 recommendations. Contact your Carrier representative for specific amount of trim required.

Expansion tank supplied (sizes 011-060 only) will allow loop expansion due to ambient fluctuations for loop volumes of up to the values in the table below. If loop volume exceeds the maximum loop volume, a larger expansion tank must be field supplied.

The supplied expansion tanks have the following specifications: 30RAP011-030 — 4.4 total gal. (17.0 L) and 3.2 gal. (12.4 L) acceptance volume, 30RAP035-060 — 10.3 total gal. (39.0 L) and 10.3 gal. (39.0 L) acceptance volume.

Maximum loop volume is based on typical system pressure of 12 psig (83 kPa) and 30 psig (207 kPa) of minimum and maximum pressures, and 100°F (37.8°C) mean temperature.

MAXIMUM LOOP VOLUME

CONCENTRATION	30RAP011-030		30RAP035-060	
	GAL.	L	GAL.	L
PURE WATER	412	1560	1356	5131
10% EG	239	906	795	3009
20% EG	233	880	767	2902
30% EG	206	781	692	2620
40% EG	200	755	655	2478
10% PG	233	880	767	2902
20% PG	200	755	655	2478
30% PG	170	645	561	2124
40% PG	157	595	514	1947

LEGEND

EG — Ethylene Glycol
PG — Propylene Glycol

Parallel chillers with hydronic packages require that pump inlets be equalized to prevent pump cavitation. Pump expansion tanks must be removed and located together in the common pump suction header. All materials needed for expansion tank relocation are field supplied. Appropriate measures must be taken for freeze protection.

Air separation

For proper system operation, it is essential that water loops be installed with proper means to manage air in the system. This is typically done by the installing contractor. Free air in the system can cause noise, reduce terminal output, stop flow, or even cause pump failure due to pump cavitation. For closed systems, equipment should be provided to eliminate all air from the system.

The amount of air that water can hold in solution depends on the pressure and temperature of the water/air mixture. Air is less soluble at higher temperatures and at lower pressures. Therefore, separation can best be done at the point of highest water temperature and lowest pressure. Typically, this point would be on the suction side of the pump as the water is returning from the system or terminals. Generally speaking, this is the best place to install an air separator, if possible.

1. Install automatic air vents at all high points in the system. (If the 30RAP unit is located at the high point of the system, a vent can be installed on the piping entering the heat exchanger on the 1/4-in. NPT female port.)
2. Install an air separator in the water loop, at the place where the water is at higher temperatures and lower pressures — usually in the chilled water return piping. On a primary-secondary system, the highest temperature water is normally in the secondary loop, close to the decoupler. Preference should be given to that point on the system. In-line or centrifugal air separators are readily available in the field.

It may not be possible to install air separators at the place of lowest pressure and highest temperature. In such cases, preference should be given to the points of highest temperature. It is important that pipe be sized correctly so that free air can be moved to the point of separation. Generally, a water velocity of at least 2 ft per second (0.6 m per second) will keep free air entrained and prevent it from forming air pockets.

Automatic vents should be installed at all physically elevated points in the system so that air can be eliminated during system operation. Provision should also be made for manual venting during the water loop fill. It is important that the automatic vents be located in accessible locations for maintenance purposes, and that they be located where they can be prevented from freezing.

Minimum time to power chiller before start-up

In order to ensure that the crankcase heaters are provided sufficient time to raise the crankcase temperature to the required operating point, power must be applied to the chiller and the compressor circuit breakers must be on a minimum of 24 hours before chiller start-up. This requirement applies to sizes 070-150. It is also applicable to all remote cooler applications (all sizes).

TYPICAL MULTIPLE CHILLER CONFIGURATION WITH AIR ELIMINATOR AND EXPANSION TANK LOCATION

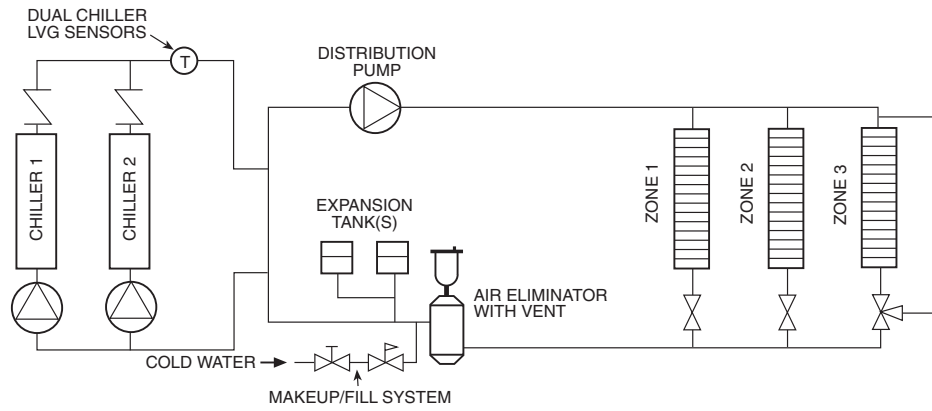

Outdoor 50/60 Hz Air-Cooled Liquid Chiller

HVAC Guide Specifications

Size Range: **18 to 150 Tons**
(63 to 528 kW) Nominal
11 to 60 Tons
(39 to 211 kW) Nominal with
Greenspeed® Intelligence

Carrier Model Number: **30RAP**

Part 1 — General

1.01 SYSTEM DESCRIPTION

Microprocessor controlled, air-cooled liquid chiller for outdoor installation, utilizing scroll compressors, low sound fans, electronic expansion valve, optional hydronic pump system (60 Hz only), and fluid storage tank (storage tank on models 011-060 only).

For units that incorporate Greenspeed intelligence, all fans are controlled with variable speed fan drive motors. Chiller software shall be specifically developed to coordinate optimal fan speed for application conditions and provide refrigerant circuit optimization, resulting in higher part load efficiency and reduced acoustic levels.

1.02 QUALITY ASSURANCE

- A. Unit shall be rated in accordance with AHRI (Air-Conditioning, Heating and Refrigeration Institute) Standard 550/590, latest edition (U.S.A.) and all units shall be ASHRAE (American Society of Heating, Refrigerating and Air-Conditioning Engineers) 90.1-2013 compliant.
- B. Unit construction shall comply with ASHRAE 15 Safety Code, UL (Underwriters Laboratories) latest edition, and ASME (American Society of Mechanical Engineers) applicable codes (U.S.A. codes).
- C. The management system governing the manufacture of this product is ISO (International Organization for Standardization) 9001:2008 certified.
- D. Unit shall be full load run tested at the factory.

1.03 DELIVERY, STORAGE AND HANDLING

- A. Unit controls shall be capable of withstanding 150°F (66°C) storage temperatures in the control compartment.
- B. Unit shall be stored and handled per unit manufacturer's recommendations.

Part 2 — Products

2.01 EQUIPMENT

A. General:

Factory assembled, single-piece chassis, air-cooled liquid chiller. Contained within the unit cabinet shall be all factory wiring, piping, controls, refrigerant charge (R-410A), and special features required prior to field start-up.

B. Materials of Construction:

1. Frame shall be of heavy-gage, galvanized steel.
2. Exterior panels shall be galvanized steel with a baked enamel powder or pre-painted finish.

3. Cabinet shall be capable of withstanding 500-hour salt spray test in accordance with the ASTM (American Society for Testing and Materials, U.S.A.) B-117 standard.
4. All units 60 tons and below shall conform to Florida Building Code 5th Edition requirements for installation including High Velocity Hurricane Zone (HVHZ) Risk Category IV (V [Velocity] = 186 mph), exposure category "C" and installation height up to and including 100 feet above grade.

C. Fans:

1. Standard condenser fans shall be direct-driven (VFD [variable frequency drive] controlled on units with Greenspeed intelligence), 9-blade air-foil cross-section, reinforced polymer construction, shrouded-axial type, and shall be statically and dynamically balanced with inherent corrosion resistance.
2. The variable speed drives for the condenser fans on 30RAP units with Greenspeed intelligence shall include a DC link reactor.
3. Fan operation shall allow reduced sound levels during scheduled unoccupied operating periods. Manufacturers without unoccupied reduced sound capability shall submit 1/3 octave band data and sound power data as measured according to AHRI 370 as confirmation of unit sound characteristics.
4. Air shall be discharged vertically upward.
5. Fans shall be protected by coated steel wire safety guards.

D. Compressor/Compressor Assembly:

1. Fully hermetic, direct-drive, scroll-type compressors.
2. Compressor motors shall be cooled by refrigerant gas passing through motor windings and shall have either internal line break thermal and current overload protection or external current overload modules with compressor temperature sensors.
3. Compressors shall be mounted on rubber in shear vibration isolators.
4. Staging of compressors shall provide unloading capability. Digital compressor unloading control shall be available as an option (sizes 011-090 only).
5. Each compressor (sizes 070-150 only) shall be equipped with crankcase heaters to minimize oil dilution. Crankcase heaters are not required on sizes 011-060 due to very low refrigerant charge.

E. Cooler:

1. Cooler shall be rated for a refrigerant working-side pressure of 505 psig (3482 kPa) on sizes 011-025, 565 psig (3896 kPa) on sizes 030-060, and 450 psig (3103 kPa) on sizes 070-150 and shall be tested for a maximum water-side pressure of 300 psig (2068 kPa) or 150 psig

(1034 kPa) when optional hydronic package is installed.

2. Shall be single-pass, ANSI (American National Standards Institute) type 316 stainless steel, brazed plate construction.
3. Shell shall be insulated with $\frac{3}{4}$ -in. (19 mm) closed-cell, polyvinyl-chloride foam with a maximum K factor of 0.28.
4. Shall incorporate 2 independent refrigerant circuits on sizes 035 to 150; sizes 011 to 030 shall have one independent refrigerant circuit.
5. Cooler shall have optional factory-installed heater, to protect cooler from ambient temperature freeze down to -20°F (-29°C) for 60 Hz applications and -15°F (-26°C) for 50 Hz applications.
6. Unit shall be provided with a factory-installed flow switch.
7. All connections shall use standard Victaulic-type fittings.
8. Cooler fluid inlet line shall have a 40 mesh strainer just ahead of the cooler.

F. Condenser:

1. Coil shall be air-cooled Novation® heat exchanger technology with microchannel (MCHX) coils and shall have a series of flat tubes containing a series of multiple, parallel flow microchannels layered between the refrigerant manifolds.
2. Coils shall consist of a two-pass arrangement. Coil construction shall consist of aluminum alloys for fins, tubes, and manifolds in combination with a corrosion-resistant coating.
3. Tubes shall be cleaned, dehydrated, and sealed.
4. Assembled condenser coils shall be leak tested and pressure tested at 656 psig (4522 kPa).
5. To plan the chiller installation and for ease of maintenance/coil removal on unit sizes 30RAP070-150, all refrigerant piping entering and leaving the condenser coils shall be located on only one side of the chiller so the coils can be removed (when needed) from the side free of piping. This is important to consider because removing the coils from the header side, although possible, involves extra labor due to extra bending and brazing of the coil headers.

G. Refrigeration Components:

Refrigerant circuit components shall include filter drier, moisture indicating sight glass, electronic expansion device, discharge and liquid service valves (sizes 070-150 only) and complete operating charge of both refrigerant R-410A and compressor oil.

H. Controls, Safeties, and Diagnostics:

1. Unit controls shall include the following minimum components:
 - a. Microprocessor with non-volatile memory. Battery backup system shall not be accepted.

- b. Separate terminal block for power and controls.
 - c. Control transformer to serve all controllers, relays, and control components.
 - d. ON/OFF control switch.
 - e. Replaceable solid-state controllers.
 - f. Pressure sensors shall be installed to measure suction and discharge pressure for each circuit. Thermistors shall be installed to measure cooler entering and leaving fluid temperatures, outdoor ambient temperature, and suction temperature. Provision for field installation of accessory sensor to measure compressor return gas temperature.
2. Unit controls shall include the following functions:
 - a. Automatic circuit lead/lag for dual circuit chillers.
 - b. Hermetic scroll compressors are maintenance free and protected by an auto-adaptive control that minimizes compressor wear.
 - c. Capacity control based on leaving chilled fluid temperature and compensated by rate of change of return-fluid temperature with temperature set point accuracy to 0.1°F (0.06°C).
 - d. Limiting the chilled fluid temperature pull-down rate at start-up to an adjustable range of 0.2°F to 2°F (0.11°C to 1.1°C) per minute to prevent excessive demand spikes at start-up.
 - e. Seven-day time schedule.
 - f. Leaving chilled fluid temperature reset from return fluid and outside air temperature.
 - g. Chilled water pump start/stop control and primary/standby sequencing to ensure equal pump run time.
 - h. Dual chiller control for parallel chiller applications without addition of hardware modules and control panels (additional thermistors and wells are required).
 - i. Timed maintenance scheduling to signal maintenance activities for pumps, condenser coil cleanings, strainer maintenance and user-defined maintenance activities.
 - j. Boiler enable signal to initiate system heating mode.
 - k. Low ambient protection to energize cooler and hydronic system heaters.
 - l. Periodic pump start to ensure pump seals are properly maintained during off-season periods.
 - m. Single step demand limit control activated by remote contact closure.
 - n. Nighttime sound mode to reduce the sound of the machine by a user-defined schedule.
 3. Diagnostics:
 - a. The control panel shall include, as standard, a scrolling marquee display capable of indicating the safety lockout condition by displaying

a code for which an explanation may be scrolled at the display.

b. Information included for display shall be:

- 1) Compressor lockout.
- 2) Loss of charge.
- 3) Low fluid flow.
- 4) Cooler freeze protection.
- 5) Cooler set point.
- 6) Chilled water reset parameters.
- 7) Thermistor and transducer malfunction.
- 8) Entering and leaving-fluid temperature.
- 9) Compressor suction temperature.
- 10) Cooler and condenser pressure.
- 11) System refrigerant temperatures.
- 12) Chiller run hours.
- 13) Compressor run hours.
- 14) Compressor number of starts.
- 15) Low superheat.
- 16) Time of day:

- a) Display module, in conjunction with the microprocessor, must also be capable of displaying the output (results) of a service test. Service test shall verify operation of every switch, thermistor, fan, and compressor before chiller is started.
- b) Diagnostics shall include the ability to review a list of the 20 most recent alarms with clear language descriptions of the alarm event. Display of alarm codes without the ability for clear language descriptions shall be prohibited.
- c) An alarm history buffer shall allow the user to store no less than 20 alarm events with clear language descriptions, time and date stamp event entry.
- d) The chiller controller shall include multiple connection ports for communicating with the local equipment network, the Carrier Comfort Network® (CCN) system and access to chiller control functions from any point on the chiller.
- e) The control system shall allow software upgrade without the need for new hardware modules.

4. Safeties:

a. Unit shall be equipped with thermistors and all necessary components in conjunction with the control system to provide the unit with the following protections:

- 1) Loss of refrigerant charge.
- 2) Reverse rotation.
- 3) Low chilled fluid temperature.
- 4) Thermal overload.
- 5) High pressure.
- 6) Electrical overload.

b. Factory pump motors (available in 60 Hz only) shall have external overcurrent protection.

I. Operating Characteristics:

1. Unit shall be capable of starting and operating down to -20°F (-29°C) on size 011 and 016 units, 45°F (7°C) on size 018-030 units, and 32°F (0°C) on size 035-150 units as standard.
2. Unit shall be capable of starting and running at outdoor ambient temperatures up to 120°F (50°C) for all sizes. Unit shall additionally be able to stay online when running with a 125°F (52°C) ambient temperature.
3. Unit shall be capable of starting up with 95°F (35°C) entering fluid temperature to the cooler.

J. Fan Motors:

1. Condenser fans shall be direct-drive AeroAcoustic™ type, discharging air vertically upward.
2. All condenser fan motors shall be totally enclosed 3-phase type with permanently lubricated ball bearings, Class F insulation and internal, automatic reset thermal overload protection or manual reset calibrated circuit breakers.
3. Shafts shall have inherent corrosion resistance.
4. Fan blades shall be statically and dynamically balanced.
5. Condenser fan openings shall be equipped with PVC coated steel wire safety guards.

K. Electrical Requirements:

1. Unit/module primary electrical power supply shall enter the unit at a single electrical box (includes option for dual point connection on sizes 070-150).
2. Unit shall operate on 3-phase power at the voltage shown in the equipment schedule.
3. Control points shall be accessed through terminal block.
4. Unit shall be shipped with factory control and power wiring installed.

L. Chilled Water Circuit:

1. Chilled water circuit shall be rated for 300 psig (2068 kPa). Units with optional pump package (60 Hz only) are rated for 150 psig (1034 kPa) working pressure.
2. Solid-state flow monitor with integral relay shall be factory installed and wired.
3. Brass body strainer with 40 mesh screen and ball type blow down.
4. Optional hydronic package (60 Hz only, applies to all unit sizes except as noted, with or without the use of a VFD [variable frequency drive]):
 - a. Field pipe connections shall be carbon steel Victaulic type.

- b. Optional single or primary/stand-by operation pump systems. Dual pump systems shall have a pump discharge check valve.
 - c. For dual-pump packages, the equipment shall have one pump operating, and a simple transition to the back-up pump shall be accomplished by means of a valve which shall be supplied with this configuration.
 - d. For dual-pump packages, when servicing is required, the pump removal/installation process shall require neither the chiller to be drained nor the installation of a blank flange to replace the pump being removed/installed.
 - e. Pumps shall be single stage design, capable of being serviced without disturbing piping connections.
 - 1) Pump casing shall be of class 30 cast iron.
 - 2) The impeller shall be of cast bronze, closed type, dynamically balanced, keyed to the shaft and secured by locking cap screw.
 - 3) The hydronic kit will be provided with a flush line connection to ensure lubrication at the seal face and allow for positive venting of the seal chamber.
 - 4) Pump shall be rated for 150 psig (1034 kPa) working pressure.
 - 5) The pump case shall have gage tappings at the suction and discharge nozzles and include drain ports.
 - 6) Motors shall totally enclosed 3-phase type with grease lubricated ball bearings.
 - 7) Each pump shall be factory tested per Hydraulic Institute Standards.
 - 8) Pump motors shall be VFD compatible.
 - f. Fluid expansion tank (sizes 011-060) shall be factory installed within the chiller cabinet insulates, pre-charged and rated for a maximum working pressure of 150 psig (1034 kPa).
 - g. Water pressure taps (2) shall be factory installed across the cooler and rated for 150 psig (1034 kPa).
 - h. Balancing valve shall be factory installed to set flow gage ports shall be factory-installed and rated for 300 psig (2068 kPa).
 - i. Hydronic assembly shall have factory-supplied electric freeze protection to -20°F (-29°C) when optional heaters are used.
 - j. Piping shall be type-L seamless copper tubing.
5. With VFD (60 Hz only) (these comments are applicable in addition to the comments in section L.4 when the VFD hydronic package is employed [30RAP070-150 only]):
- a. The drive shall be of the VVC-PWM (voltage vector control - pulse with modulation) type, providing near unity displacement power factor without the need for external power factor correction capacitors at all loads and speeds.
 - b. The drive and motor protection shall include; motor phase to ground fault, loss of supply phase, over voltage, under voltage, motor overtemperature, inverter overload, and overcurrent. Overcurrent is not allowed, ensuring hydronic units will not overload the motor at any point in the operating range of the unit.
 - c. Sensorless control software shall be available in the hydronic unit to provide automatic speed control without the need for pump mounted (internal/external) or remotely mounted differential pressure system feed-back sensors. Control mode setting and minimum/maximum head set points shall be set at the factory and be user adjustable via the programming interface.
 - d. The integrated control shall incorporate an integrated graphical user interface that shall provide running and diagnostic information and identify faults and status in clear English language. Faults shall be logged and/or recorded for review at a later date. It shall be possible to upload parameters from one drive into the non-volatile memory of a computer and download the parameters into other drives requiring the same settings. The keypad shall incorporate Hand-Off-Auto pushbuttons to enable switching between BMS (Building Management System) and manual control. The drive shall incorporate a USB port for direct connection to a PC and an RS485 connection with Modbus¹ RTU protocol. Optional protocols available should include BACnet² and LonWorks³.
 - e. The control shall have the following additional features: Sensorless override for BMS, manual pump control or closed loop PID (proportional/integral/derivative) control; programmable skip frequencies and adjustable switching frequency for noise/vibration control; auto alarm reset; motor pre-heat function; six programmable digital inputs; two analog inputs; one programmable analog/digital output; two volt-free contacts.
 - f. The hydronic unit shall be capable of operating in any of the following control modes:
 - 1) Duty pump and standby pumps with sensorless control.
 - 2) Duty pump and standby pumps with remote sensor or building automation system (BAS) control.

1. Modbus is a registered trademark of Schneider Electric.
2. BACnet is a registered trademark of ASHRAE (American Society of Heating, Refrigerating, and Air-Conditioning Engineers).
3. LonWorks is a registered trademark of Echelon Corporation.

M. Special Features:

Certain standard features are not applicable when the features designated by * are specified. For assistance in amending the specifications, contact your Carrier representative.

1. High-efficiency variable condenser fans:

All fans on the unit shall have variable speed fan motors to provide higher part load efficiency and reduced acoustic levels. Each fan circuit shall have a factory-installed, independent variable speed drive with display. Variable speed drives are rated IP-55 enclosures and UL Listed. The use of this option, with the addition of antifreeze in the cooler circuit and wind baffles, shall allow running with outdoor ambient temperatures down to -20°F (-28.9°C). This option is a standard feature on sizes 011 and 016, is not available on sizes 070-150, and is not available in combination with low ambient head pressure control.

* 2. Low-Ambient Operation:

Unit shall be capable of starting and operating down to -20°F (-29°C) with the addition of either the field or factory-installed solid-state low ambient head pressure control or high-efficiency variable condenser fans. In addition, adequate field-supplied antifreeze with suitable corrosion inhibitor protection shall be field-installed in the cooler circuit. Field-installed wind baffles shall also be required. If significant low-load operation is anticipated, then hot gas bypass is recommended. High-efficiency variable condenser fans are standard on sizes 011 and 016.

NOTE: The motors associated with low ambient head pressure control will be open type and shall have class B insulation.

3. Unit-Mounted Non-Fused Disconnect:

Unit shall be supplied with factory-installed, non-fused electrical disconnect for main power supply. For unit sizes 070 and larger, this option is available only with single-point power. Additionally, on sizes 100-150, this option is not available with 208/230 volts. This option is included with the high SCCR option.

4. Optional Condenser Coil Materials:

a. E-coated microchannel coils:

E-coated aluminum microchannel coil shall have a flexible epoxy polymer coating uniformly applied to all coil external surface areas without material bridging between fins or louvers. Coating process shall ensure complete coil encapsulation, including all exposed fin edges. E-coat shall have a thickness of 0.8 to 1.2 mil with top coat having a uniform dry film thickness from 1.0 to 2.0 mil on all external coil surface areas including fin edges. E-coated coils

shall have superior hardness characteristics of 2H per ASTM D3363-00 and cross hatch adhesion of 4B-5B per ASTM D3359-02. Impact resistance shall be up to 160 in./lb (ASTM D2794-93). E-coated coil shall have superior impact resistance with no cracking, chipping, or peeling per NSF/ANSI 51-2002 Method 10.2. E-coated aluminum microchannel coils shall be capable of withstanding 8,000-hour salt spray test in accordance with the ASTM (American Society for Testing and Materials) B-117 Standard.

b. Aluminum fin/copper tube coils:

Coil shall be constructed of seamless copper tubes mechanically bonded to aluminum fins. Fins shall have wavy enhancements. These condenser coils are recommended with remote cooler applications. These coils are not recommended for corrosive environments.

c. Pre-coated aluminum-fin coils:

Coil shall have a durable epoxy-phenolic coating to provide protection in mildly corrosive coastal environments. Coating shall be applied to the aluminum fin stock prior to the fin stamping process to create an inert barrier between the aluminum fin and copper tube. Epoxy-phenolic barrier shall minimize galvanic action between dissimilar metals.

d. Copper-fin coils:

Coil shall be constructed of copper fins mechanically bonded to copper tubes and copper tube sheets. Galvanized steel tube sheets shall not be acceptable. A polymer strip shall prevent coil assembly from contacting sheet metal coil pan to minimize potential for galvanic corrosion between the coil and pan. All-copper construction shall provide protection in moderate coastal applications.

e. E-coated aluminum-fin coils:

Coil shall have a flexible epoxy polymer coating uniformly applied to all coil surface areas without material bridging between fins. Coating process shall ensure complete coil encapsulation. Color shall be high gloss black with gloss; 60° of 65 to 90% per ASTM ID523-89. Uniform dry film thickness from 0.8 to 1.2 mil on all surface areas including fin edges. Superior hardness characteristics of 2H per ASTM D3363-92A and cross hatch adhesion of 4B-5B per ASTM D3359-93. Impact resistance shall be up to 160 in./lb (ASTM D2794-93). Humidity and water immersion resistance shall be up to minimum 1000 and 250 hours respectively (ASTM D2247-92 and ASTM D870-92). Corrosion durability shall be confirmed through testing

to no less than 3000 hours salt spray per ASTM B117-90. Coil construction shall be aluminum fins mechanically bonded to copper tubes.

- f. E-coated copper-fin coils:
Coil shall have a flexible epoxy polymer coating uniformly applied to all coil surface areas without material bridging between fins. Coating process shall ensure complete coil encapsulation. Color shall be high gloss black with gloss; 60° of 65 to 90% per ASTM D523-89. Uniform dry film thickness from 0.8 to 1.2 mil on all surface areas including fin edges. Superior hardness characteristics of 2H per ASTM D3363-92A and cross hatch adhesion of 4B-5B per ASTM D3359-93. Impact resistance shall be up to 160 in./lb (ASTM D2794-93). Humidity and water immersion resistance shall be up to minimum 1000 and 250 hours respectively (ASTM D2247-92 and ASTM D870-92). Corrosion durability shall be confirmed through testing to no less than 3000 hours salt spray per ASTM B117-90. Coil construction shall be copper-fins mechanically bonded to copper tube sheets. Galvanized steel tube sheets shall not be acceptable. A polymer strip shall prevent coil assembly from contacting sheet metal coil pan to maintain coating integrity and minimize corrosion potential between the coil and pan.
5. Remote Enhanced Display:
Unit shall be supplied with indoor-mounted, remote, 40-character per line, 16-line display panel for field installation.
6. Chillervisor System Manager III Multi-Unit Control:
Field-installed control shall sequence between 2 and 8 chillers in parallel in a single system.
7. Hot Gas Bypass:
Unit shall be equipped with factory or field-installed, microprocessor-controlled, hot gas bypass that shall permit unit operation down below the minimum standard step of capacity. The factory option is not available on sizes 011 and 016 or on any application with a leaving fluid temperature below 35°F (2°C). Option and accessory not available on units with the digital compressor option.
8. Energy Management Module:
A factory or field-installed module shall provide the following energy management capabilities: 4 to 20 mA signals for leaving fluid temperature reset, cooling set point or demand limit control; 2-point demand limit control (from 15% to 100%) activated by a remote contact closure;

and discrete input for “Ice Done” indication for ice storage system interface.

9. Security Grilles/Hail Guards:
Unit shall be supplied with factory or field-installed, louvered, sheet metal panels which securely fasten to the chiller and provide condenser coil protection against hail and other physical damage. This option or accessory directly covers the coil(s) on sizes 011 to 060. On sizes 070 and larger, the louvered panels are only on the ends of the chiller, with a wire guard entirely covering the sides of the chiller.
10. Vibration Isolation:
Vibration isolation pads shall be supplied for field installation at unit mounting points. Pads shall help to reduce vibration transmission into the occupied space.
11. Chilled Water Storage Tank (Sizes 011-060 only):
- Fluid storage tank shall be rated for a maximum of 150 psig (1034 kPa).
 - Shall provide a minimum 4 gallon per ton (3.7 L per kW) fluid storage capacity.
 - Shall fit under the chiller to minimize system footprint requirements. Tanks fitted outside of chiller footprint shall not be acceptable.
 - Tank shall be constructed a cold rolled carbon steel shell.
 - Tank shall be insulated with $\frac{3}{4}$ -in. (19 mm) closed-cell, polyvinyl-chloride foam with a maximum K factor of 0.28.
 - Tank shall be baffled to prevent temperature stratification.
 - Tank shall have Victaulic connections.
 - Tank shall have vent and drain plugs accessible from outside tank enclosure.
 - Internal heaters shall provide freeze protection to -20°F (-29°C). The included heater thermostat prevents overheating of the fluid.
12. BACnet Communication Option:
Shall provide pre-programmed factory-installed communication capability with a BACnet MS/TP network. Allows integration with i-Vu® Open control system or a third-party BACnet building automation system. No field programming shall be required.
13. BACnet/Modbus Translator Control:
Unit shall be supplied with field-installed interface between the chiller and a BACnet Local Area Network (LAN, i.e., MS/TP EIA-485). Field programming shall be required.
14. LON Translator control:
Unit shall be supplied with field-installed interface between the chiller and a Local Operating Network (LON, i.e., LonWorks FT-10A ANSI/EIA-709.1). Field programming shall be required.

15. Navigator™ Hand-Held Display:
 - a. Portable hand held display module with a minimum of 4 lines and 20 characters per line, of clear English, Spanish, Portuguese or French language.
 - b. Display menus shall provide clear language descriptions of all menu items, operating modes, configuration points and alarm diagnostics. Reference to factory codes shall not be accepted.
 - c. RJ-14 connection plug shall allow display module to be connected to factory-installed receptacle.
 - d. Industrial grade coiled extension cord shall allow the display module to be moved around the chiller.
 - e. Magnets shall hold the display module to any sheet metal panel to allow hands-free operation.
 - f. Display module shall have NEMA 4x housing suitable for use in outdoor environments.
 - g. Display shall have back light and contrast adjustment for easy viewing in bright sunlight or night conditions.
 - h. Raised surface buttons with positive tactile response.
16. Touch Pilot™ Display:

Unit shall be supplied with a remote mount touch screen display for network attachment to the chiller.
17. GFI Convenience Outlet (60 Hz Only):

Shall be factory or field installed to provide the chiller with a 4 amp GFI receptacle. The receptacle shall have independent fuse protection. The convenience outlet is a 115-v female receptacle.
18. Freeze Protection Cooler Heaters:

Cooler heaters shall provide protection from cooler freeze-up to -20°F (-29°C) 60 Hz and -15°F (-26°C) 50 Hz.
19. Value Sound Fans:

Shall provide propeller-type fans for applications that are not highly sound-sensitive. These fans shall have Class F insulation and internal, automatic-reset thermal overload protection or manual reset calibrated circuit breakers.
20. Ultra-Low Sound:

Shall provide sound blankets around each compressor in conjunction with low-sound AeroAcoustic™ fans to provide significant chiller sound reduction.
21. High SCCR (Short Circuit Current Rating):

The optional high SCCR (short circuit current rating) device shall allow the chiller to tolerate a 65 kA (208/230, 380, 380/415, and 460-v units) or 25 kA (575-v units) short circuit current for a brief period of time while protecting the downstream components. The high SCCR option shall provide a higher level of protection than the standard unit. This is not available with dual point power at any size, or with 208/230-v units in the size range of 100-150. The selection of this option includes a non-fused disconnect.
22. Compressor Suction Service Valves (Sizes 070-150 only):

Shall provide a suction service valve per circuit, which is in addition to the standard discharge service valve.
23. Digital Compressor Option (Sizes 011-090 only):

Shall provide a factory-installed digital compressor to provide incremental steps for tighter temperature control (not available on any application with a leaving fluid temperature below 35°F [2°C]).
24. Remote Cooler Kit:

Field-installed remote cooler kit shall provide the additional hardware required to remotely mount the cooler from the unit. There are limits to total separation of the unit to the cooler as well as vertical separation limits, and these shall be delineated in the accessory installation instructions. Never bury refrigerant piping on these or any other applications.
25. Wind Baffles:

Wind baffles facilitate operation down to -20°F (-29°C) when used in conjunction with either low ambient temperature head pressure control or high-efficiency variable condenser fans.
26. Low Sound Compressor Blankets:

Accessory low sound compressor blankets shall reduce unit the sound levels by providing an acoustic blanket on each compressor.
27. Seismic Certification:

A seismic kit is available. Its use will result in a unit SDS (seismic design acceleration parameter) level of 2.5 for 30RAP011-060 units, or a unit SDS level of 2.1 for 30RAP070-150 units.

