

**38MGQ / 40MAQ/40MBC/40MBD/40MBF
538TR / 619PB/619RC/619RD/619RF
Multi-Zone Ductless Split System
Sizes 18 to 48**

Service Manual

TABLE OF CONTENTS

	PAGE
SAFETY CONSIDERATIONS	1
INTRODUCTION	1
MODEL NUMBER NOMENCLATURE	2
STANDARD FEATURES AND ACCESSORIES	4
COMBINATION TABLE	5
PHYSICAL DATA - OUTDOOR	6
DIMENSIONS - OUTDOOR	7
CLEARANCES - OUTDOOR	11
ELECTRICAL DATA	12
CONNECTION DIAGRAM	14
WIRING DIAGRAM	24
REFRIGERATION CYCLE DIAGRAMS	28
REFRIGERANT LINES	30
SYSTEM EVACUATION AND CHARGING	31
TROUBLESHOOTING	32
APPENDIX	66

SAFETY CONSIDERATIONS

Installing, starting up, and servicing air-conditioning equipment can be hazardous due to system pressures, electrical components, and equipment location (roofs, elevated structures, etc.).

Only trained, qualified installers and service mechanics should install, start-up, and service this equipment.

Untrained personnel can perform basic maintenance functions such as cleaning coils. All other operations should be performed by trained service personnel.

When working on the equipment, observe precautions in the literature and on tags, stickers, and labels attached to the equipment.

Follow all safety codes. Wear safety glasses and work gloves. Keep quenching cloth and fire extinguisher nearby when brazing. Use care in handling, rigging, and setting bulky equipment.

Read this manual thoroughly and follow all warnings or cautions included in literature and attached to the unit. Consult local building codes and National Electrical Code (NEC) for special requirements.

Recognize safety information. This is the safety-alert symbol . When you see this symbol on the unit and in instructions or manuals, be alert to the potential for personal injury. Understand these signal words: DANGER, WARNING, and CAUTION.

These words are used with the safety-alert symbol. DANGER identifies the most serious hazards which **will** result in severe personal injury or death. WARNING signifies hazards which **could** result in personal injury or death. CAUTION is used to identify unsafe practices which **may** result in minor personal injury or product and property damage. NOTE is used to highlight suggestions which **will** result in enhanced installation, reliability, or operation.



WARNING

ELECTRICAL SHOCK HAZARD

Failure to follow this warning could result in personal injury or death.

Before installing, modifying, or servicing system, main electrical disconnect switch must be in the OFF position. There may be more than 1 disconnect switch. Lock out and tag switch with a suitable warning label.



WARNING



EXPLOSION HAZARD

Failure to follow this warning could result in death, serious personal injury, and/or property damage.

Never use air or gases containing oxygen for leak testing or operating refrigerant compressors. Pressurized mixtures of air or gases containing oxygen can lead to an explosion.



CAUTION

EQUIPMENT DAMAGE HAZARD

Failure to follow this caution may result in equipment damage or improper operation.

Do not bury more than 36 in. (914 mm) of refrigerant pipe in the ground. If any section of pipe is buried, there must be a 6 in. (152 mm) vertical rise to the valve connections on the outdoor units. If more than the recommended length is buried, refrigerant may migrate to the cooler buried section during extended periods of system shutdown. This causes refrigerant slugging and could possibly damage the compressor at start-up.

INTRODUCTION

This Service Manual provides the necessary information to service, repair, and maintain the multi-zone family of heat pumps. Section 2 of this manual has an appendix with data required to perform troubleshooting. Use the Table of Contents to locate a desired topic.

MODEL NUMBER NOMENCLATURE

INDOOR UNIT

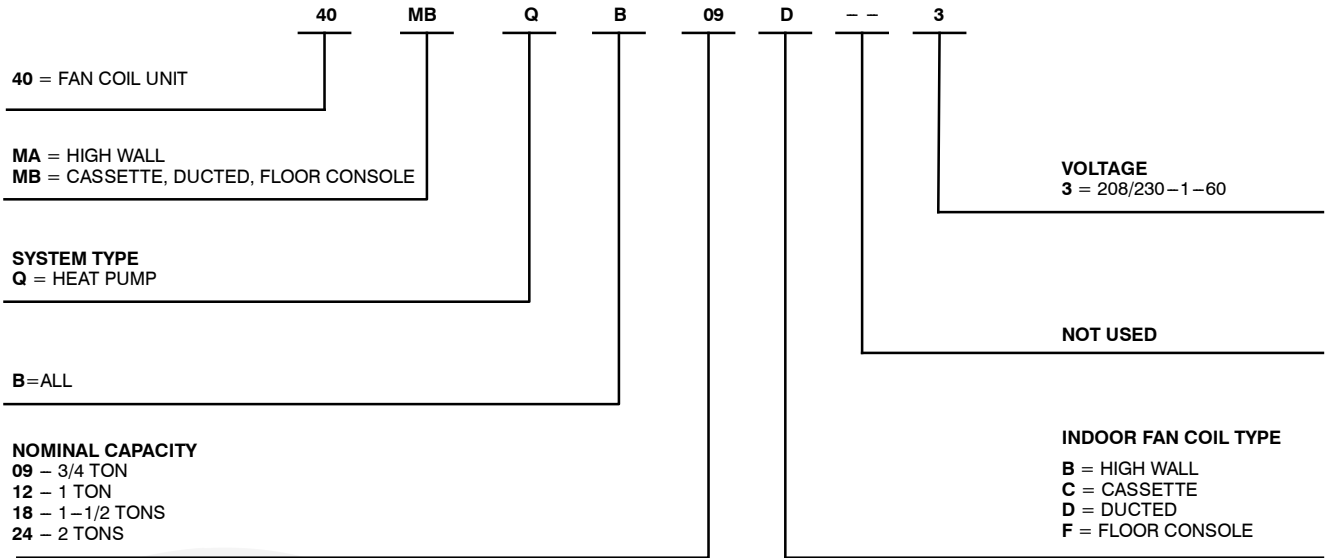

OUTDOOR UNIT

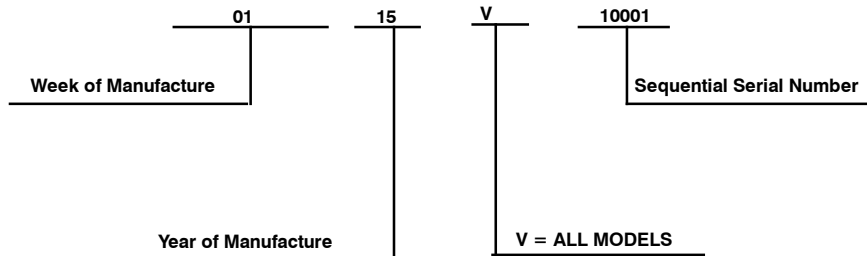
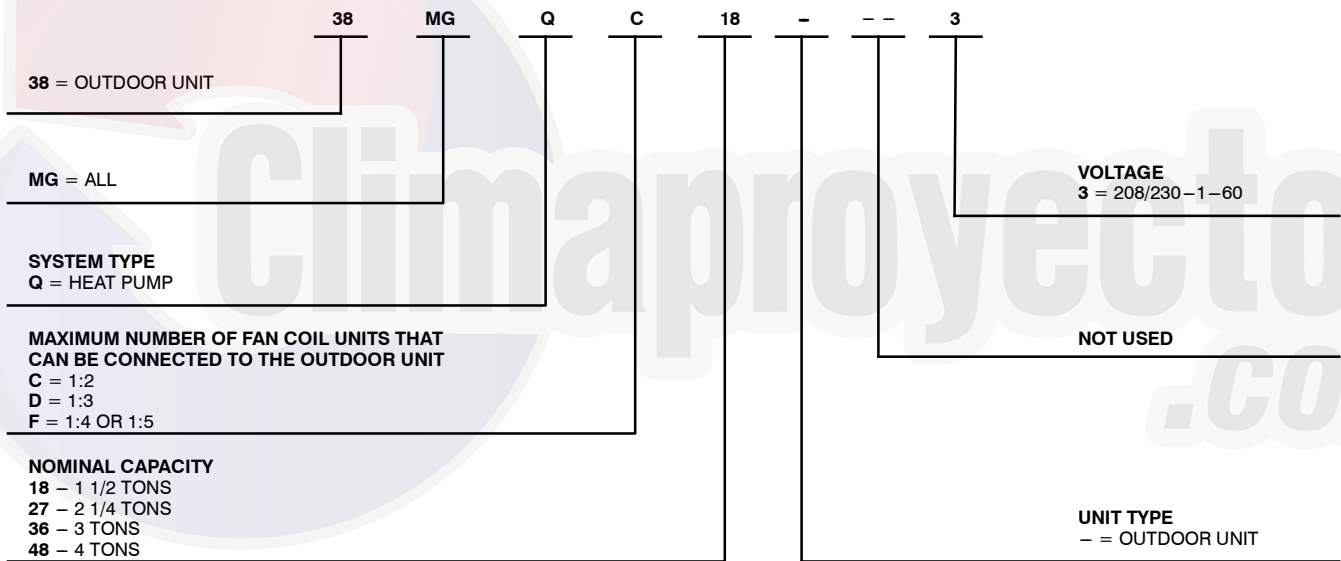

Use of the AHRI Certified TM Mark indicates a manufacturer's participation in the program. For verification of certification for individual products, go to www.ahridirectory.org.



INDOOR UNIT

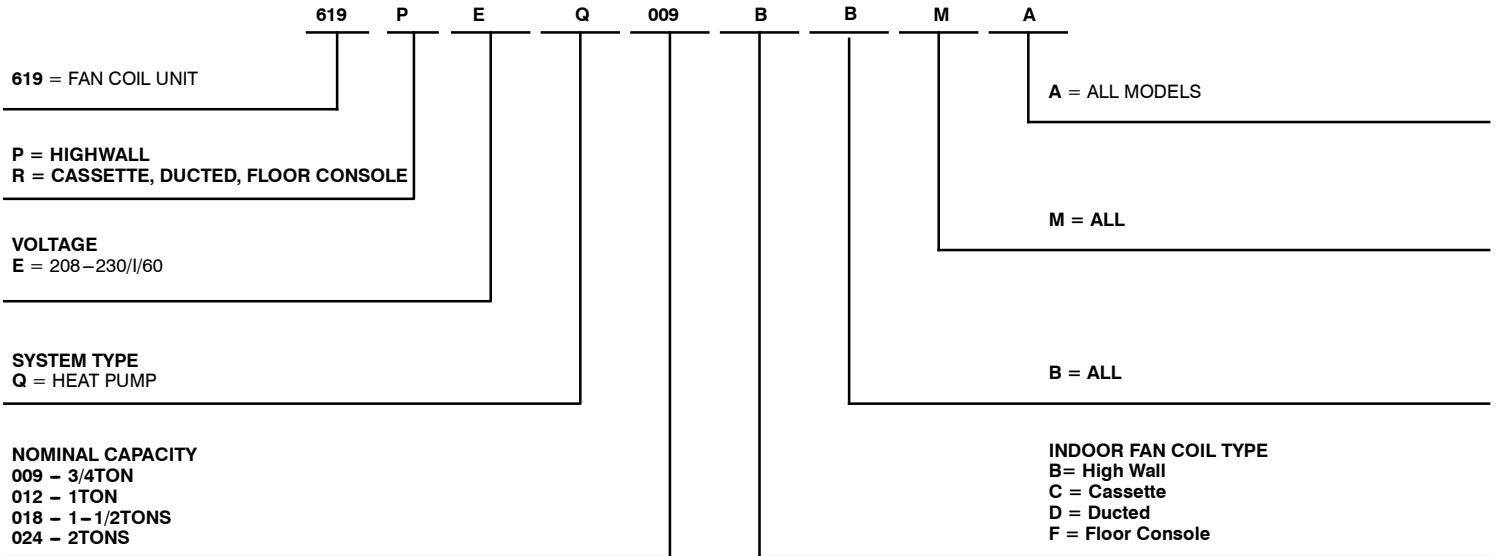

OUTDOOR UNIT

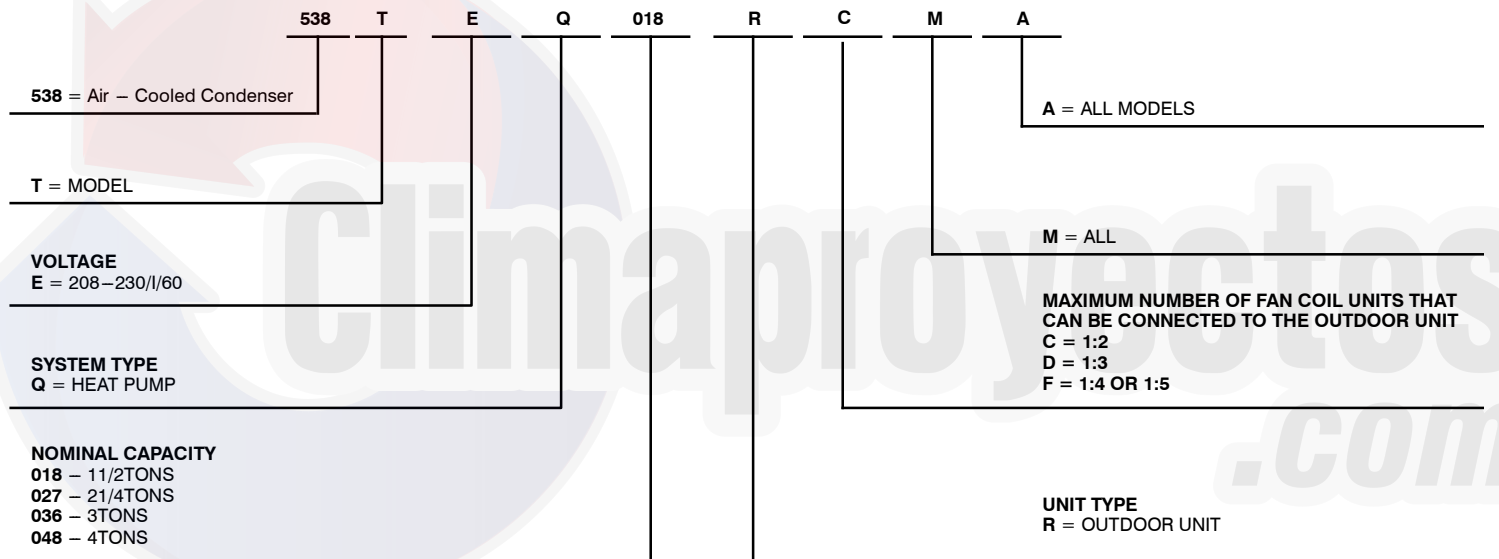

Use of the AHRI Certified TM Mark indicates a manufacturer's participation in the program For verification of certification for individual products, go to www.ahridirectory.org.



STANDARD FEATURES AND ACCESSORIES

Ease of Installation	
Mounting Bracket	S
Low Voltage Controls	S
Comfort Features	
Microprocessor Control	S
Wired Remote Control for High Walls, Cassette and Floor Console	A
Wired Remote Control for Ducted	S
Wireless Remote Control	S
Rapid Cooling and Heating	S
Automatic Air Sweep	S
Cold Blow Prevention	S
Continuous Fan	S
Auto Restart Function	S
Auto Changeover	S
Follow Me	S
Energy Saving Features	
Inverter Driven Compressor	S
Sleep Mode	S
24 Hour Stop/Start Timer	S
46° F Heating Mode (Heating Setback)	S
Safety And Reliability	
Indoor Coil Freeze Protection	S
3 Minute Time Delay For Compressor	S
High Compressor Discharge Temperature	S
Low Voltage Protection	S
Compressor Overload Protection	S
Compressor Over Current Protection	S
IPM Module Protection	S
Ease of Service	
Cleanable Filters	S
Diagnostic	S
Error Messages Displayed On Front Panel	S
Application Flexibility	
Condensate Pumps For High Walls and Floor Console	A
Condensate Pump For Cassette and Ducted	S
Crankcase Heater	S
Basepan Heater	S

Legend
S Standard
A Accessory

INDOOR UNITS

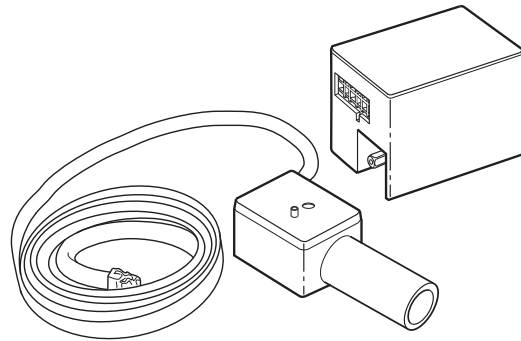

Fig. 1 – Condensate Pump Accessory

On high wall fan coils, the condensate pump has a lift capability of 12 ft. (3.6 m) on the discharge side with the pump mounted in the fan coil or 6 ft (1.8 m) on the suction side if the pump is remote mounted. The pump is recommended when adequate drain line pitch cannot be provided, or when the condensate must move up to exit.

OUTDOOR UNITS

Crankcase Heater

Standard on all unit sizes. Heater clamps around compressor oil stump.

COMBINATION TABLE

Table 1—Combinations Table Size 18

Indoor Unit	Nominal Unit Btuh	Indoor Model Number	Indoor Model Number	Outdoor Model Number	Outdoor Model Number
High Wall	9,000	40MAQB09B--3	619PEQ009BBMA	38MGQC18---3	538TEQ018RCMA
	12,000	40MAQB12B--3	619PEQ012BBMA		
Cassette	9,000	40MBQB09C--3	619REQ009CBMA		
	12,000	40MBQB12C--3	619REQ012CBMA		
Ducted	9,000	40MBQB09D--3	619REQ009DBMA		
	12,000	40MBQB12D--3	619REQ012DBMA		
Floor Console	9,000	40MBQB09F--3	619REQ009FBMA		
	12,000	40MBQB12F--3	619REQ012FBMA		

Table 2—Combinations Table Size 27

Indoor Unit	Nominal Unit Btuh	Indoor Model Number	Indoor Model Number	Outdoor Model Number	Outdoor Model Number
High Wall	9,000	40MAQB09B--3	619PEQ009BBMA	38MGQD27---3	538TEQ027RDMA
	12,000	40MAQB12B--3	619PEQ012BBMA		
	18,000	40MAQB18B--3	619PEQ018BBMA		
Cassette	9,000	40MBQB09C--3	619REQ009CBMA		
	12,000	40MBQB12C--3	619REQ012CBMA		
	18,000	40MBQB18C--3	619REQ018CBMA		
Ducted	9,000	40MBQB09D--3	619REQ009DBMA		
	12,000	40MBQB12D--3	619REQ012DBMA		
	18,000	40MBQB18D--3	619REQ018DBMA		
Floor Console	9,000	40MBQB09F--3	619REQ009FBMA		
	12,000	40MBQB12F--3	619REQ012FBMA		

Table 3—Combinations Table Size 36 and 48

Indoor Unit	Nominal Unit Btuh	Indoor Model Number	Indoor Model Number	Outdoor Model Number	Outdoor Model Number
High Wall	9,000	40MAQB09B--3	619PEQ009BBMA	38MGQF36---3 38MGQF48---3	538TEQ036RFMA 538TEQ048RFMA
	12,000	40MAQB12B--3	619PEQ012BBMA		
	18,000	40MAQB18B--3	619PEQ018BBMA		
	24,000	40MAQB24B--3	619PEQ024BBMA		
Cassette	9,000	40MBQB09C--3	619REQ009CBMA		
	12,000	40MBQB12C--3	619REQ012CBMA		
	18,000	40MBQB18C--3	619REQ018CBMA		
Ducted	9,000	40MBQB09D--3	619REQ009DBMA		
	12,000	40MBQB12D--3	619REQ012DBMA		
	18,000	40MBQB18D--3	619REQ018DBMA		
	24,000	40MBQB24D--3	619REQ024DBMA		
Floor Console	9,000	40MBQB09F--3	619REQ009FBMA		
	12,000	40MBQB12F--3	619REQ012FBMA		

PHYSICAL DATA - OUTDOOR

Table 4—Outdoor

System	Size		18	27	36	48
	Outdoor Model		38MGQC18---3 538TEQ018RCMA	38MGQD27---3 538TEQ027RDMA	38MGQF36---3 538TEQ036RFMA	38MGQF48---3 538TEQ048RFMA
Max Number of Zones			2	3	4	5
Energy Star			YES	YES	NO	YES
Performance Non-Ducted	Cooling Rated Capacity	Btu/h	18,000	25,000	36,000	42,000
	Cooling Cap. Range Min - Max	Btu/h	8,500~20,000	9,000~30,000	9,500~37,000	10,000~50,000
	SEER		21	22	18	20
	EER		12.5	12.5	8.8	12.5
	Heating Rated Capacity	Btu/h	18,500	32,000	36,000	49,000
	Heating Cap. Range Min - Max	Btu/h	9,000~22,000	9,500~32,000	10,000~39,000	10,500~55,000
Performance Combination Ducted and Non-Ducted	HSPF		9.6	9.6	10.0	10.0
	Cooling Rated Capacity	Btu/h	17,500	26,000	35,000	42,000
	Cooling Cap. Range Min - Max	Btu/h	8,500~20,000	9,000~30,000	9,500~36,500	10,000~50,000
	SEER		19.5	19.25	16.5	19
	EER		12.5	11	8.5	11.75
	Heating Rated Capacity	Btu/h	18,250	32,000	36,000	50,000
Performance Ducted	Heating Cap. Range Min - Max	Btu/h	9,000~22,000	9,500~32,000	10,000~39,000	10,500~55,000
	HSPF		9.1	9.2	9.7	9.8
	Cooling Rated Capacity	Btu/h	17,000	27,000	34,000	42,000
	Cooling Cap. Range Min - Max	Btu/h	8,500~20,000	9,000~30,000	9,500~36,000	10000~50000
	SEER		18	16.5	15	18
	EER		12.5	9.5	8.2	11
Operating Range	Heating Rated Capacity	Btu/h	18,000	32,000	36,000	51,000
	Heating Cap. Range Min - Max	Btu/h	9000~22000	9500~32000	10,000~39,000	10,500~55,000
	HSPF		8.5	8.8	9.3	9.5
	Cooling Outdoor DB Min - Max	F	4~122	4~122	4~122	4~122
	Heating Outdoor DB Min - Max	F	4~86	4~86	4~86	4~86
	Piping	Total Piping Length	Ft.	98	147	196
Piping to furthest FCU		Ft.	98	98	98	98
Drop (OD above ID)		Ft.	32	32	32	32
Lift (OD below ID)		Ft.	32	32	32	32
Pipe Connection Size - Liquid		In.	1/4*2	1/4*3	1/4*4	1/4*5
Pipe Connection Size - Suction		In.	3/8*2	3/8*3	1/2+3/8*3	1/2*2+3/8*3
Electrical	Voltage, Phase, Cycle	V/Ph/Hz	208/230-1-60	208/230-1-60	208/230-1-60	208/230-1-60
	Power Supply		Indoor unit powered from outdoor unit			
	MCA	A.	15	19	27	29
Outdoor	MOCP - Fuse Rating	A.	20	25	40	50
	Unit Width	In.	33.3	37.2	37.2	36.9
	Unit Height	In.	27.6	31.9	31.9	53.9
	Unit Depth	In.	12.6	15.6	15.6	15.4
	Net Weight	Lbs.	114.6	154.8	169.8	255.5
	Airflow	CFM	1,390	2,130	2,130	3,500
Sound Pressure	dB(A)	60	63	63	64	

DIMENSIONS - OUTDOOR

Table 5—Outdoor

Unit Size		18	27	36	48
Height	in (mm)	27.56(700)	31.89(810)	31.89(810)	36.93(1369)
Width	in (mm)	33.27(845)	37.20(945)	37.20(945)	53.9(938)
Depth	in (mm)	12.60(320)	15.55(395)	15.55(395)	15.43(392)
Weight - Net	lbs (kg)	114.63(52)	154.76(70.2)	169.75(77)	255.50(115.9)

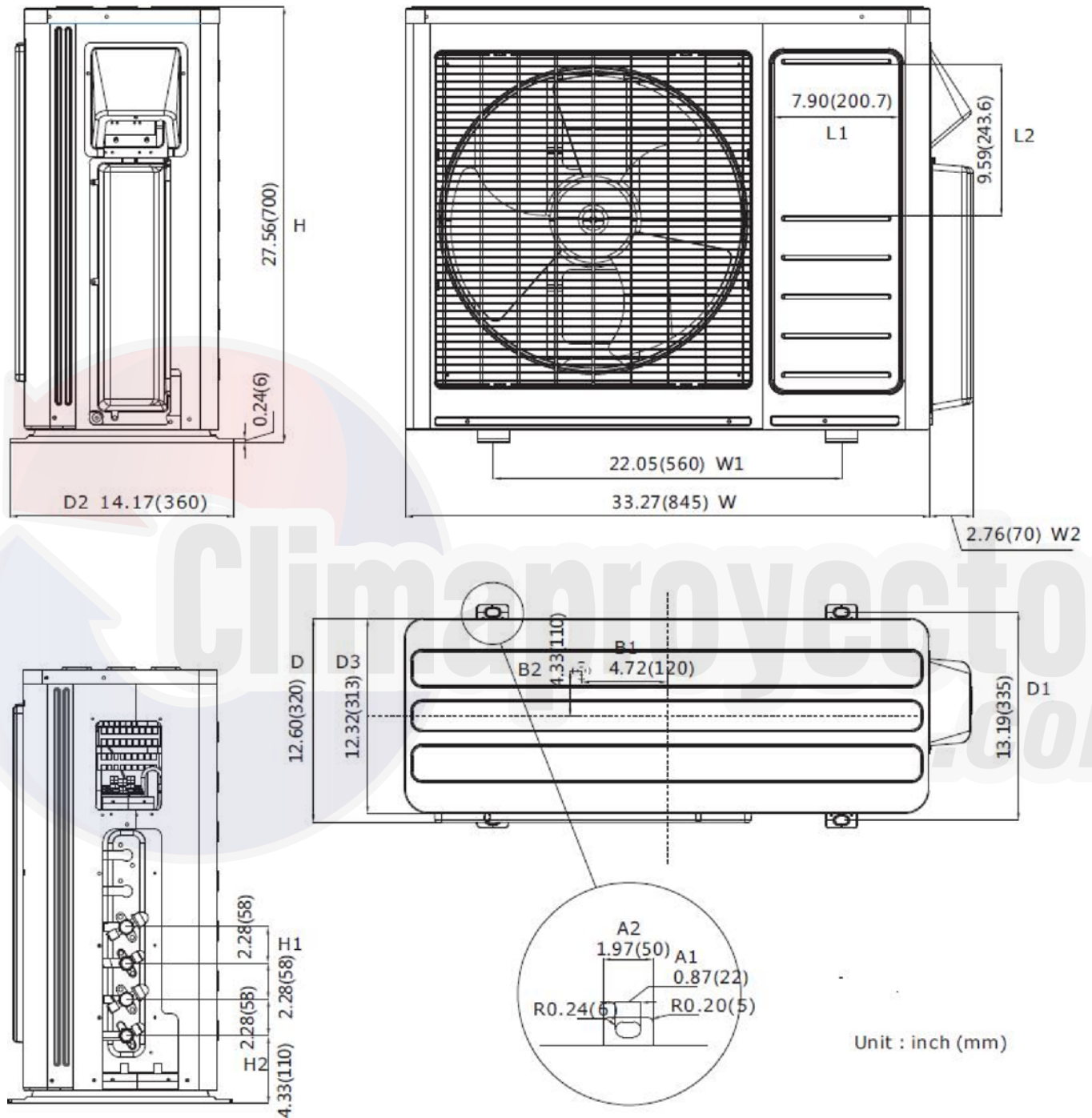

Fig. 2 – Outdoor Dimensions Size 18

DIMENSIONS - OUTDOOR (CONTINUED)

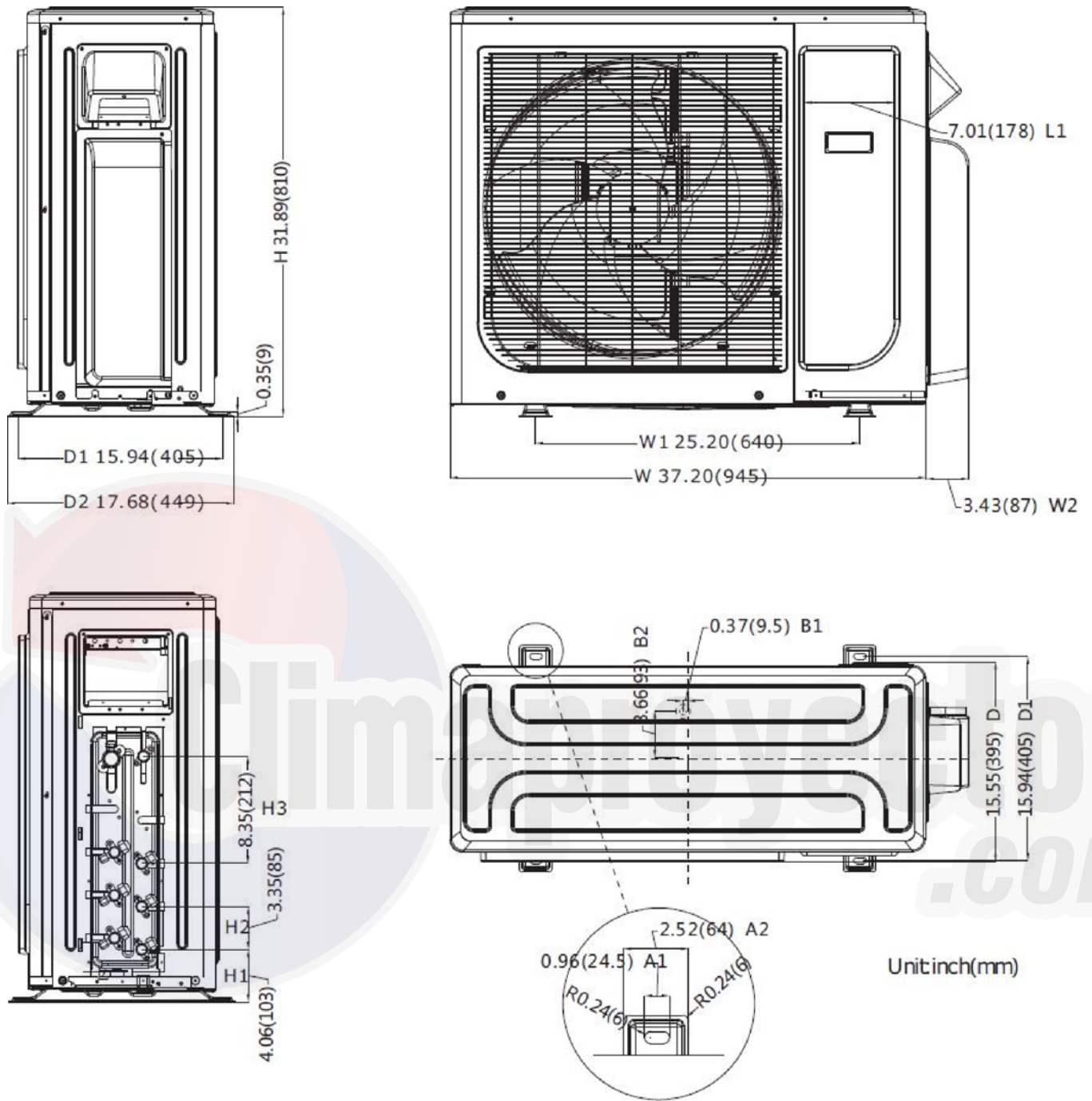

Fig. 3 – Outdoor Dimensions Size 27

DIMENSIONS - OUTDOOR (CONTINUED)

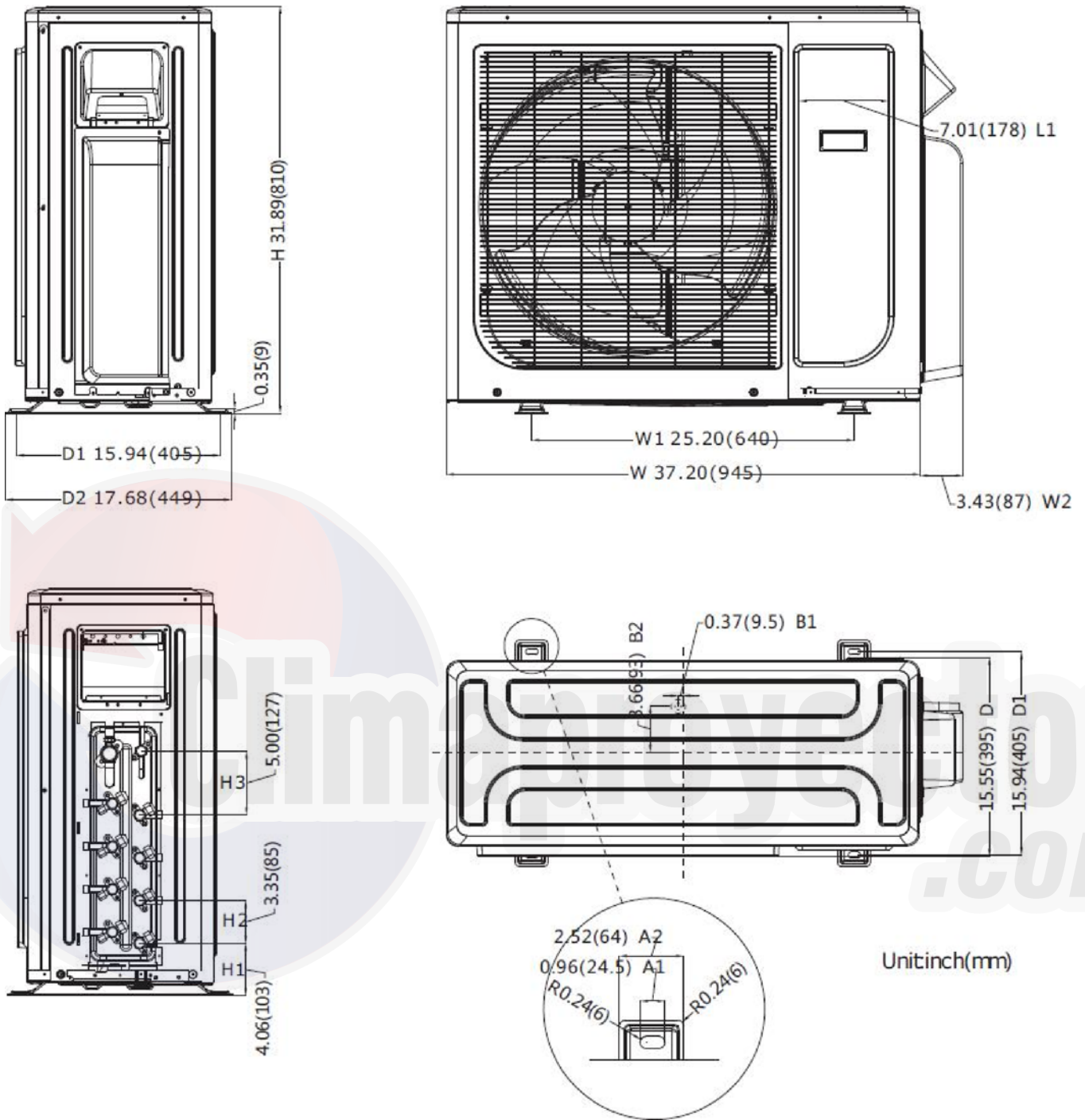

Fig. 4 – Outdoor Dimensions Size 36

DIMENSIONS - OUTDOOR (CONTINUED)

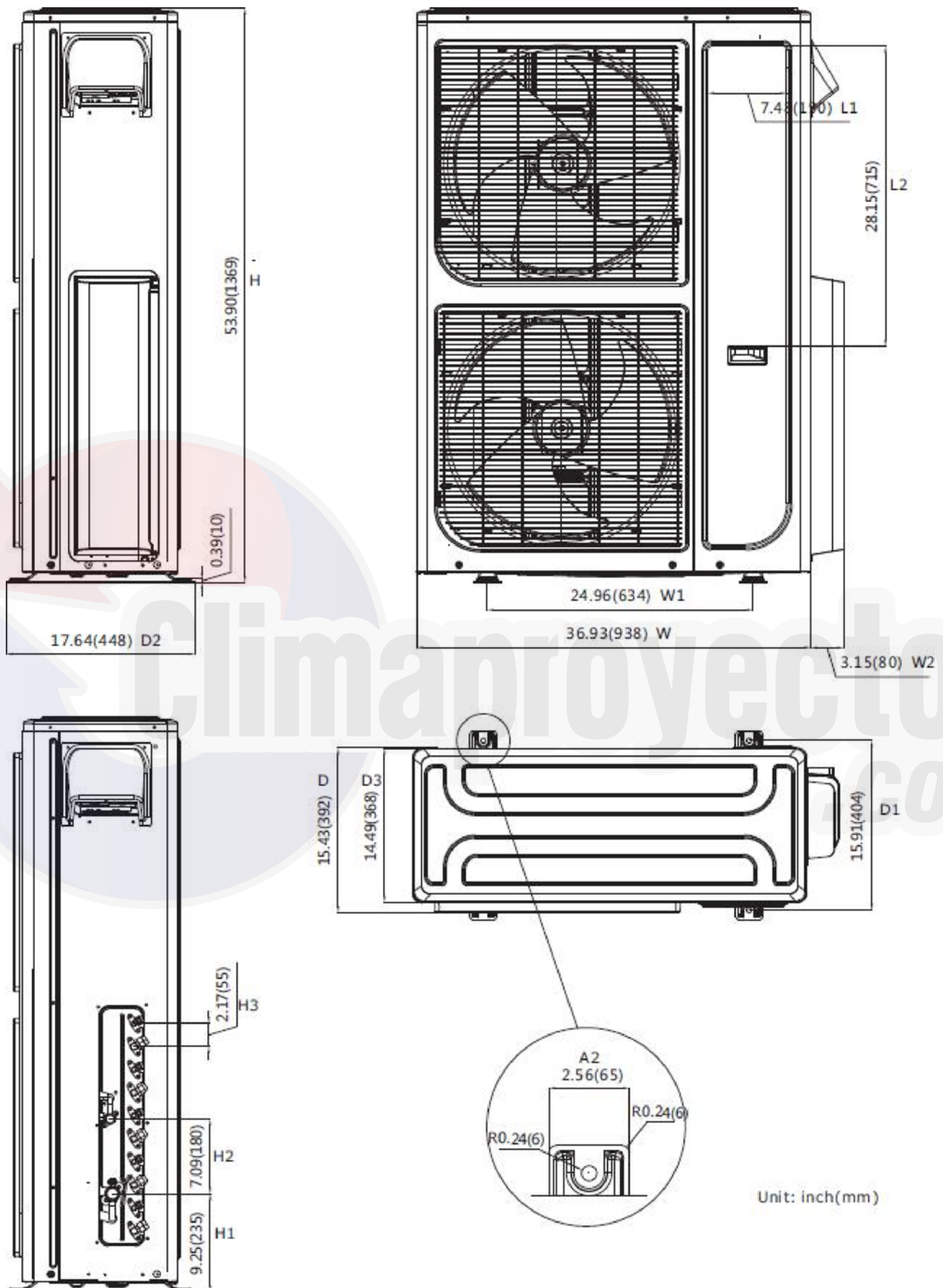

Fig. 5 – Outdoor Dimensions Size 48

CLEARANCES - OUTDOOR

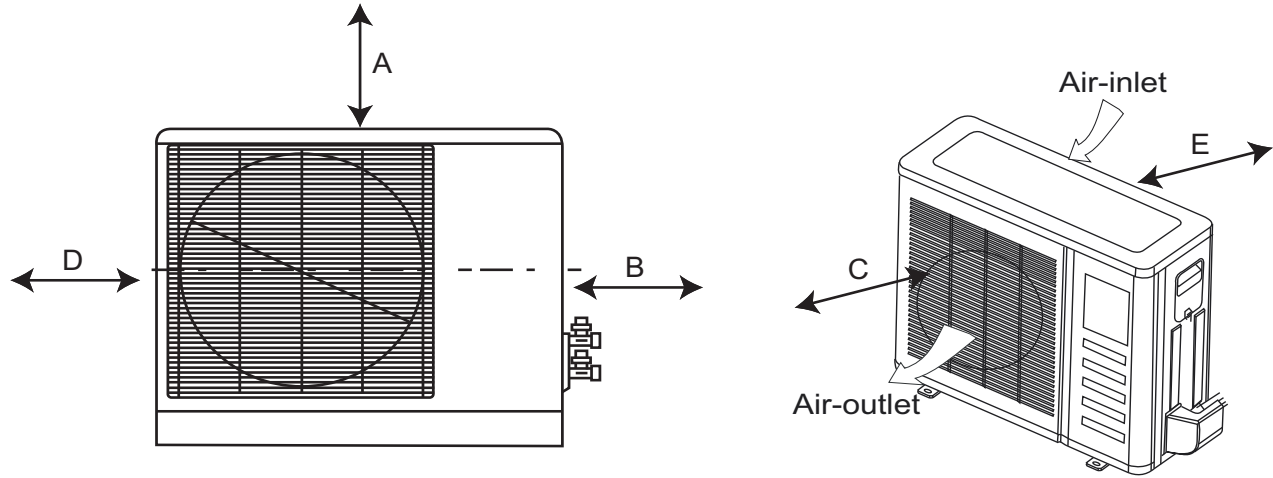
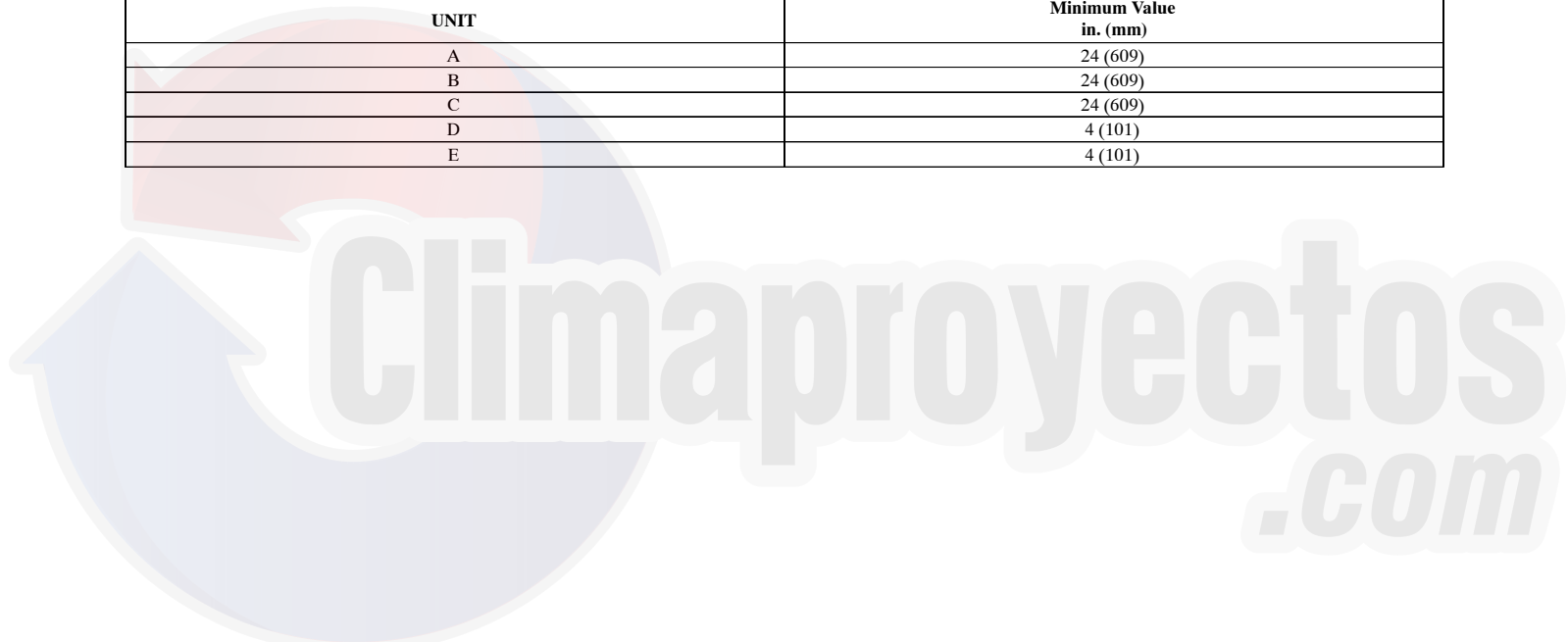

Fig. 6 – Outdoor Unit Clearance

Table 6—Outdoor

UNIT	Minimum Value in. (mm)
A	24 (609)
B	24 (609)
C	24 (609)
D	4 (101)
E	4 (101)



ELECTRICAL DATA

Table 7—High Wall

UNIT SIZE	System Voltage	OPERATING VOLTAGE	INDOOR FAN			
	VOLT / PHASE / HZ	MAX / MIN	V-PH-HZ	FLA	HP	W
9	208-230/1/60	253 / 187	208-230/1/60	0.07	0.027	20
12				0.07	0.027	20
18				0.17	0.077	58
24				0.23	0.08	60
30				0.23	0.08	60

Table 8—Ducted

UNIT SIZE	System Voltage	OPERATING VOLTAGE	INDOOR FAN		
	VOLT / PHASE / HZ	MAX / MIN	FLA	HP	W
9	208-230/1/60	253 / 187	1.03	0.073	55
12			1.03	0.073	55
18			0.83	0.12	90
24			0.83	0.12	90
36			1.263	0.2	150
48			2.23	0.32	240

Table 9—Cassette

Cassette						
UNIT SIZE	System Voltage	OPERATING VOLTAGE	INDOOR FAN			
	VOLT / PHASE / HZ	MAX / MIN	V-PH-HZ	FLA	HP	W
9	208-230/1/60	253 / 187	208-230/1/60	0.146	0.061	46
12				0.146	0.061	46
18				0.146	0.061	46

Table 10—Floor Console

UNIT SIZE	System Voltage	OPERATING VOLTAGE	INDOOR FAN			
	VOLT / PHASE / HZ	MAX / MIN	V-PH-HZ	FLA	HP	W
9	208-230/1/60	253 / 187	208-230/1/60	0.21	0.027	20
12				0.21	0.027	20

Table 11—Multi Zone Outdoor Unit

UNIT SIZE	System Voltage	OPERATING VOLTAGE	COMPRESSOR	OUTDOOR FAN			MCA	MAX FUSE/CB AMP
	VOLT / PHASE / HZ	MAX / MIN	RLA	FLA	HP	W		
18	208-230/1/60	253 / 187	9.7	3	0.16	50	15	20
27			8.85	3	0.16	120	19	25
36			13.4	3	0.16	120	27	40
48			13.5	3	0.11	85	29	50

*Permissible limits of the voltage range at which the unit will operate satisfactorily.

LEGEND

FLA - Full Load Amps

MCA - Minimum Circuit Amps

RLA - Rated Load Amps

WIRING

All wires must be sized per NEC (National Electrical Code) or CEC (Canadian Electrical Code) and local codes. Use Electrical Data table MCA (minimum circuit amps) and MOCP (maximum over current protection) to correctly size the wires and the disconnect fuse or breakers respectively.

Per caution note, only copper conductors with a minimum 300 volt rating and 2/64-inch thick insulation must be used.

The use of BX cable is not recommended.

Recommended Connection Method for Power and Communication Wiring - Power and Communication Wiring:

The main power is supplied to the outdoor unit. The field supplied 14/3 power/communication wiring from the outdoor unit to indoor unit consists of four (4) wires and provides the power for the indoor unit. Two wires are high voltage AC power, one is communication wiring and the other is a ground wire.

Recommended Connection Method for Power and Communication Wiring (To minimize communication wiring interference)

Power Wiring:

The main power is supplied to the outdoor unit. The field supplied power wiring from the outdoor unit to indoor unit consists of three (3) wires and provides the power for the indoor unit. Two wires are high voltage AC power and one is a ground wire.

To minimize voltage drop, the factory recommended wire size is 14/2 stranded with a ground.

Communication Wiring:

A separate shielded copper conductor only, with a minimum 300 volt rating and 2/64-inch thick insulation, must be used as the communication wire from the outdoor unit to the indoor unit.

Please use a separate shielded 16GA stranded control wire.



CAUTION

EQUIPMENT DAMAGE HAZARD

Failure to follow this caution may result in equipment damage or improper operation.

- Wires should be sized based on NEC and local codes.
- Use copper conductors only with a minimum 300 volt rating and 2/64 inch thick insulation.



CAUTION

EQUIPMENT DAMAGE HAZARD

Failure to follow this caution may result in equipment damage or improper operation.

- Be sure to comply with local codes while running wire from indoor unit to outdoor unit.
- Every wire must be connected firmly. Loose wiring may cause terminal to overheat or result in unit malfunction. A fire hazard may also exist. Therefore, be sure all wiring is tightly connected.
- No wire should be allowed to touch refrigerant tubing compressor or any moving parts.
- Disconnecting means must be provided and shall be located within sight and readily accessible from the air conditioner.
- Connecting cable with conduit shall be routed through hole in the conduit panel.

Climaproyectos.com

CONNECTION DIAGRAMS

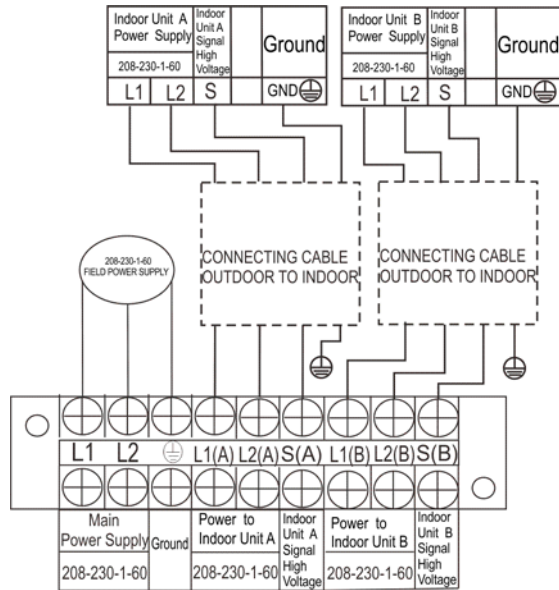

Fig. 7 – Connection Diagram Size 18

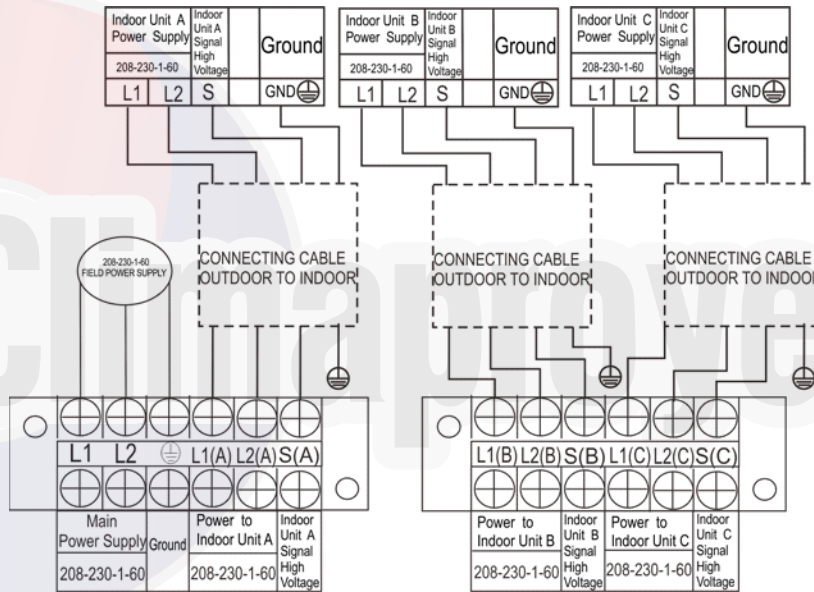

Fig. 8 – Connection Diagram Size 27

CONNECTION DIAGRAMS CONTINUED

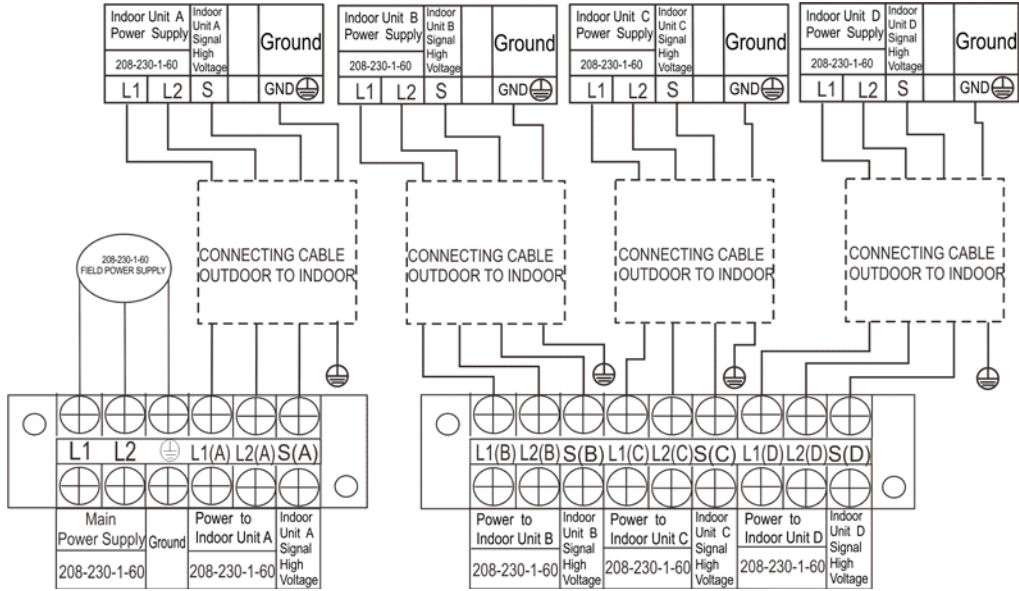

Fig. 9 – Connection Diagram Size 36

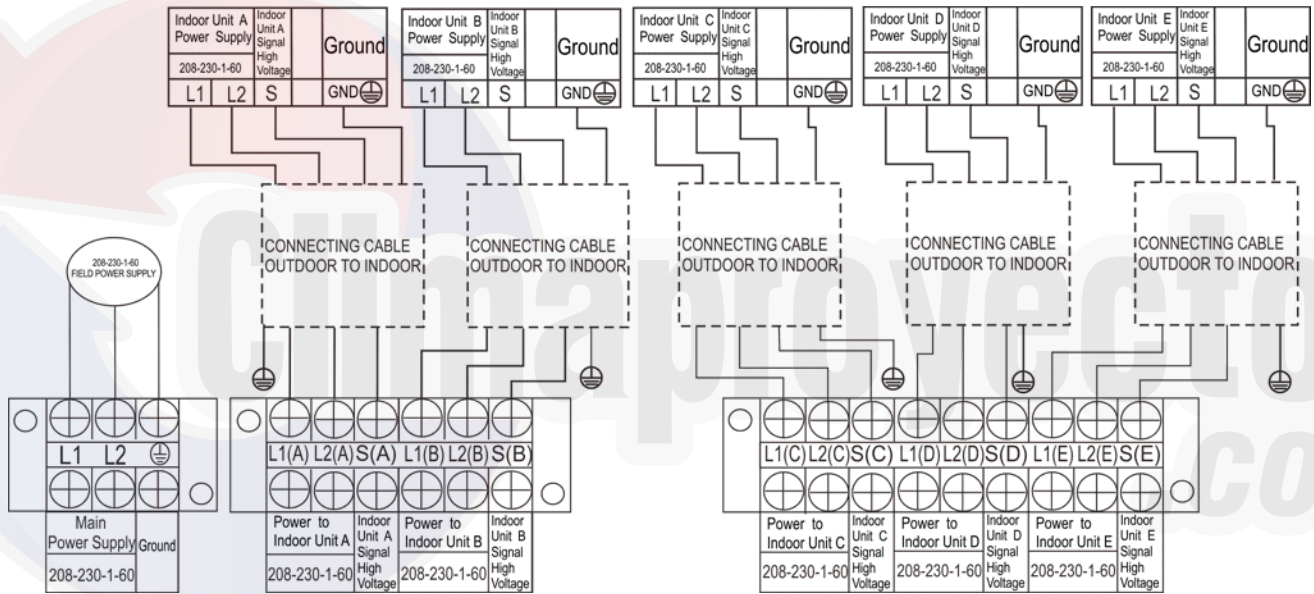

Fig. 10 – Connection Diagram Size 48

Notes:

1. Do not use thermostat wire for any connection between indoor and outdoor units.
2. All connections between indoor and outdoor units must be as shown. **The connections are sensitive to polarity and will result in a fault code.**

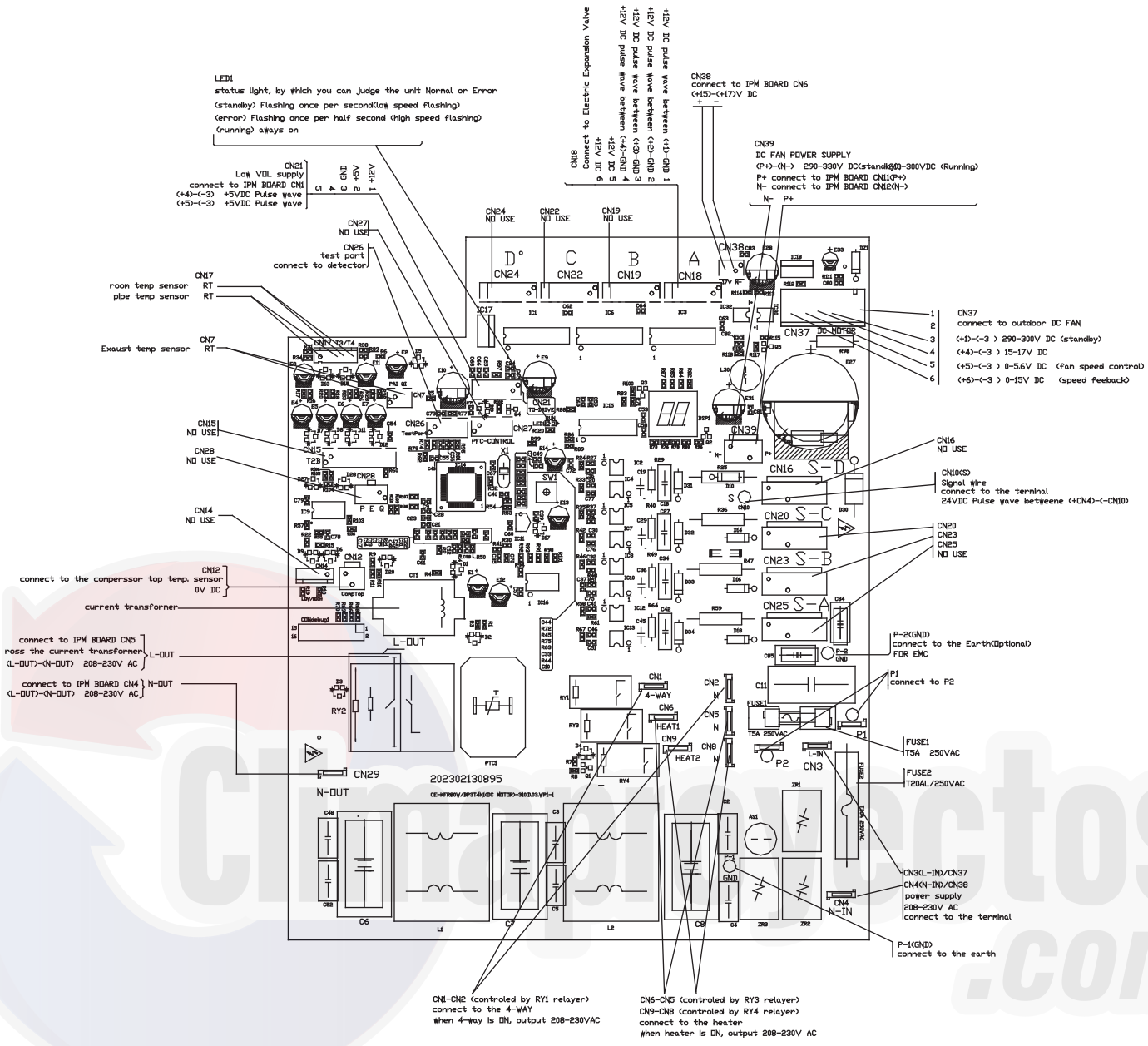

Fig. 11 – PCB Board Size 18

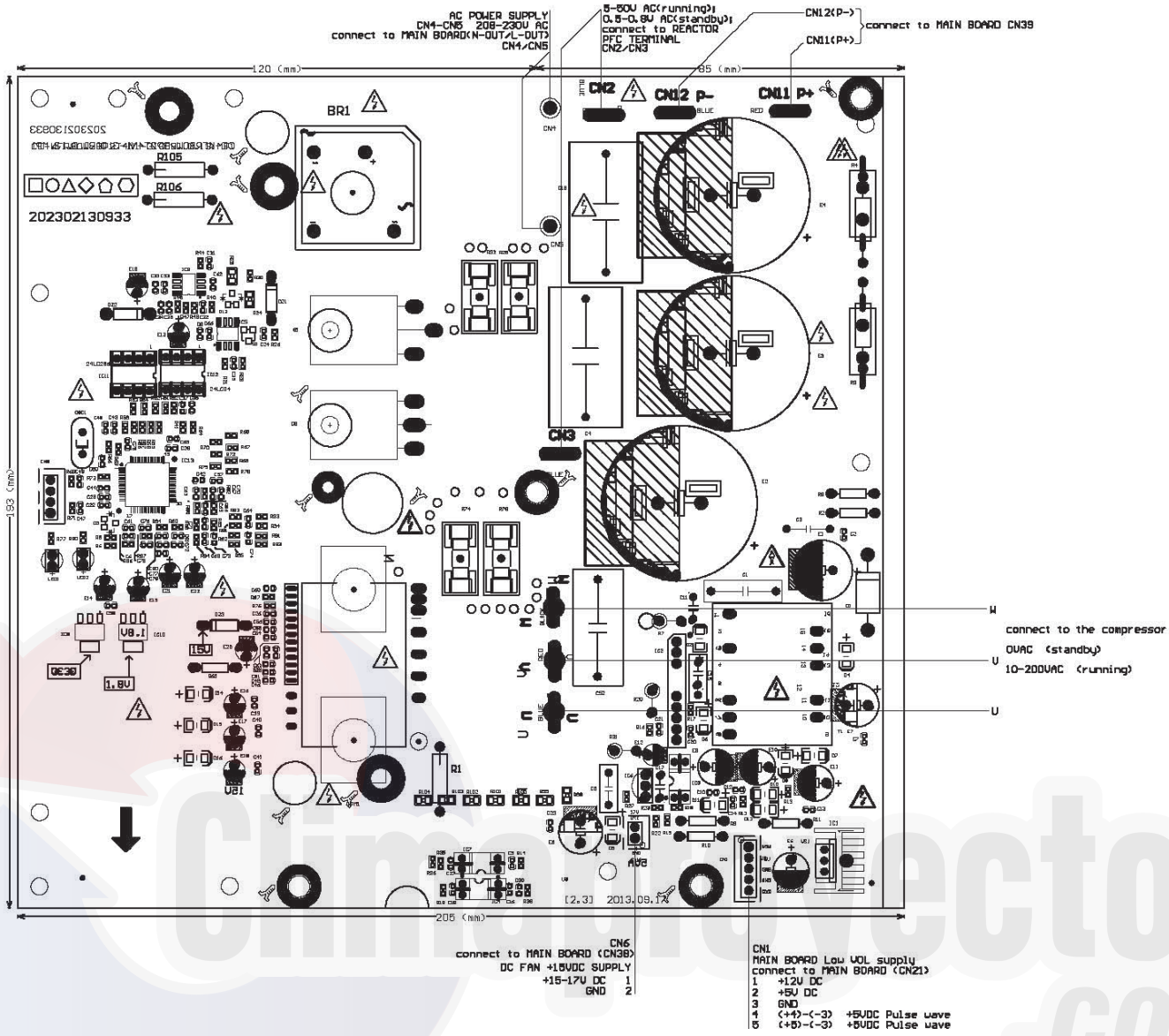

Fig. 12 – IPM Board Size 18

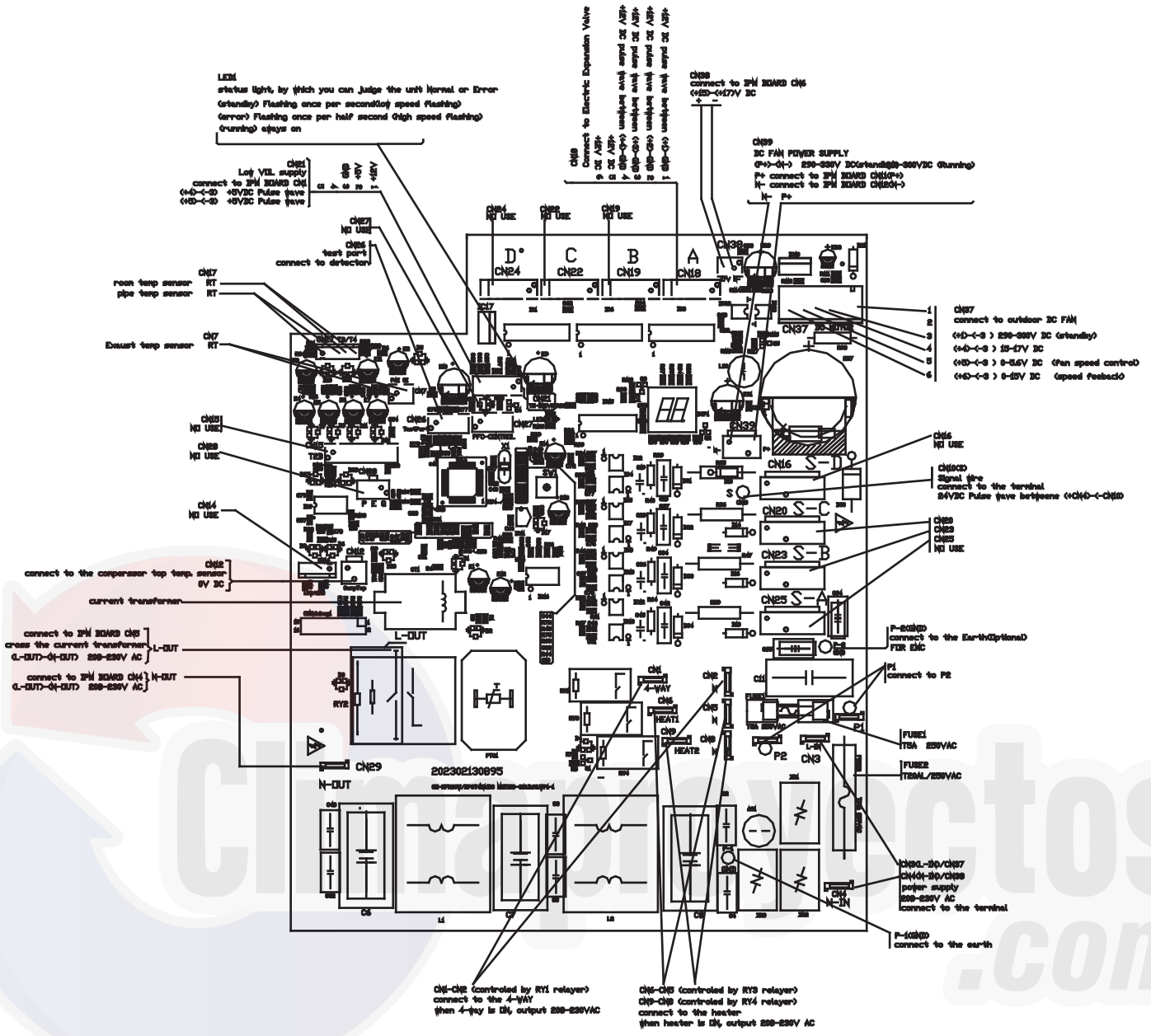

Fig. 13 – PCB Board Size 27

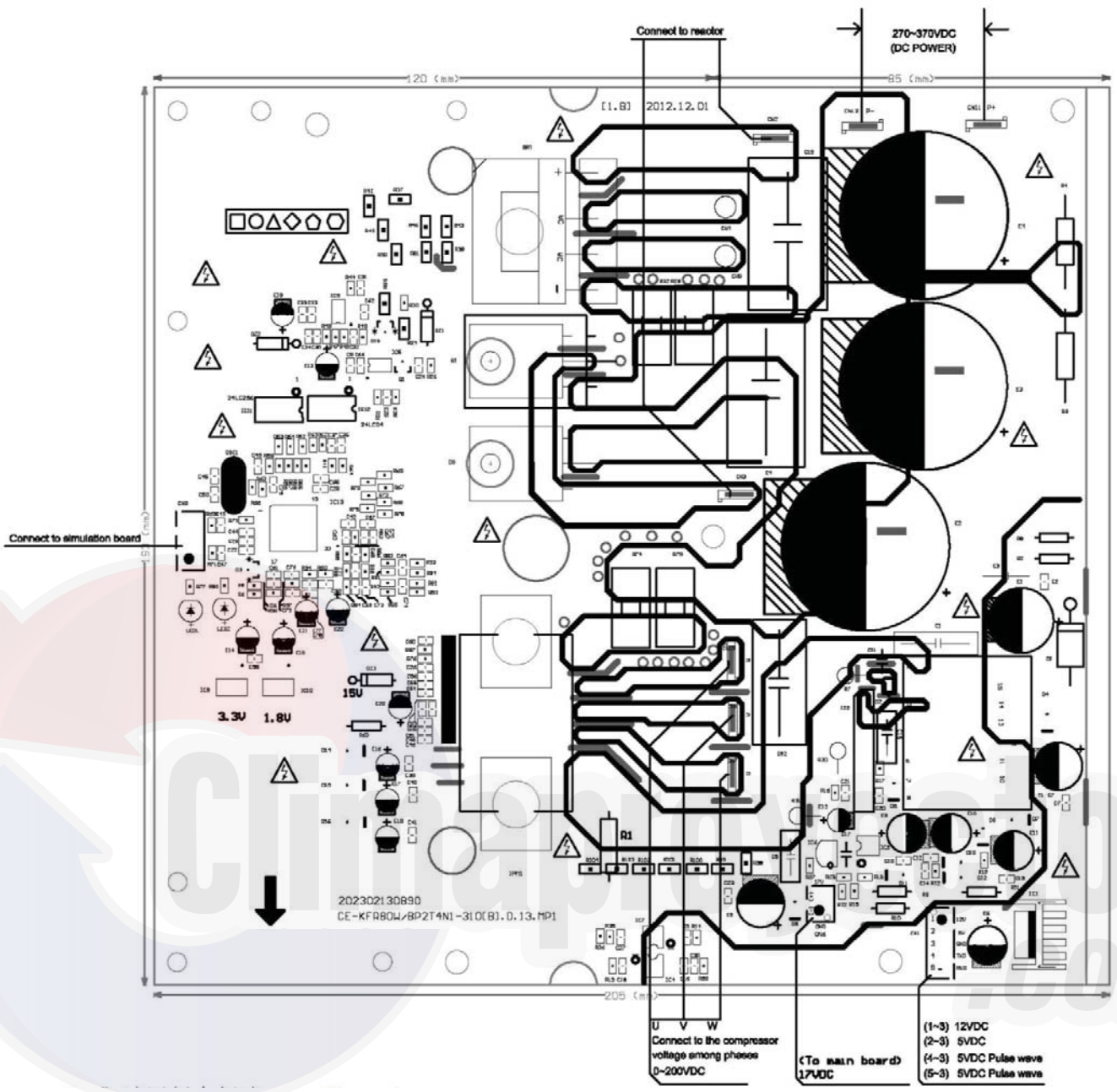

Fig. 14 – IPM Board Size 27

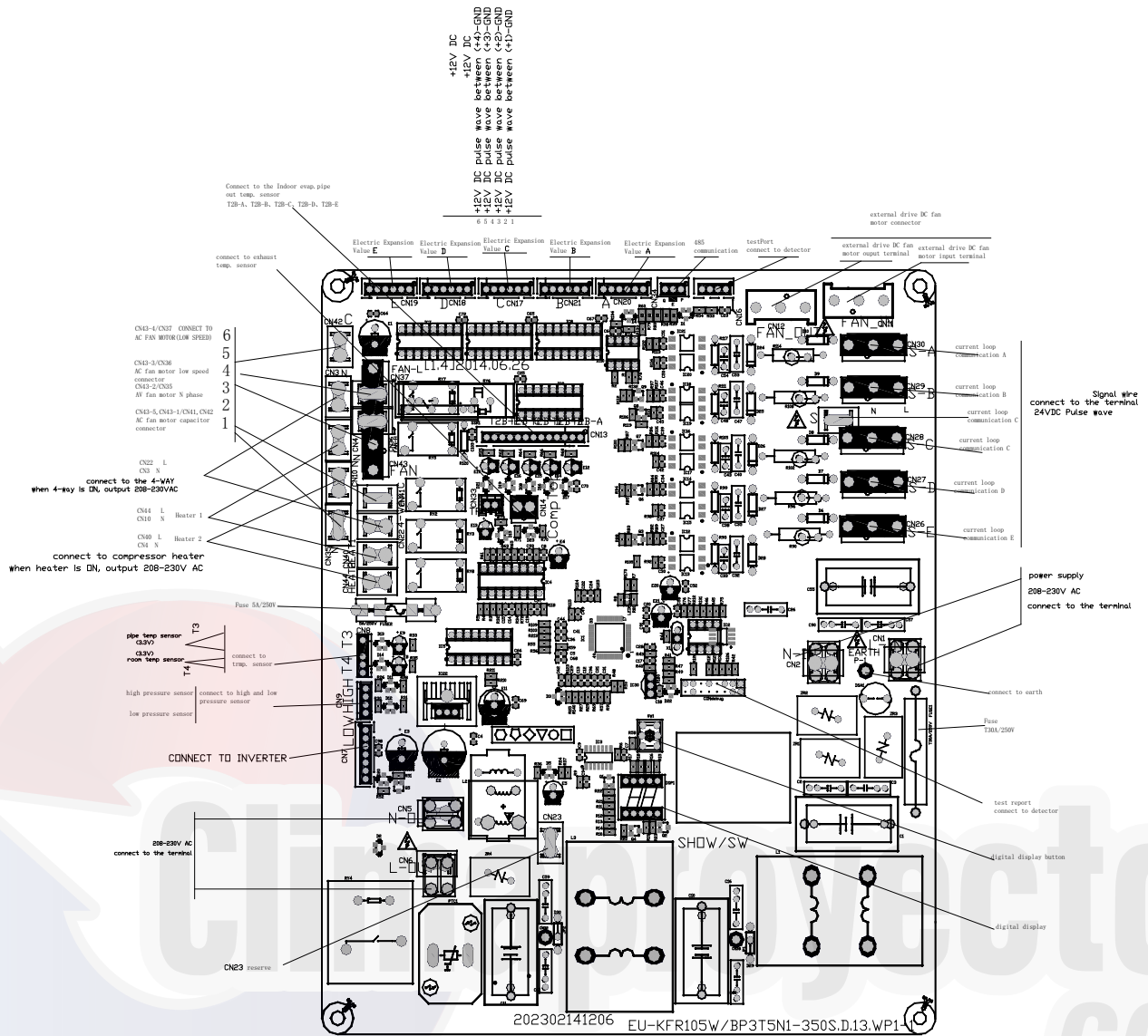

Fig. 15 – PCB Board Size 36

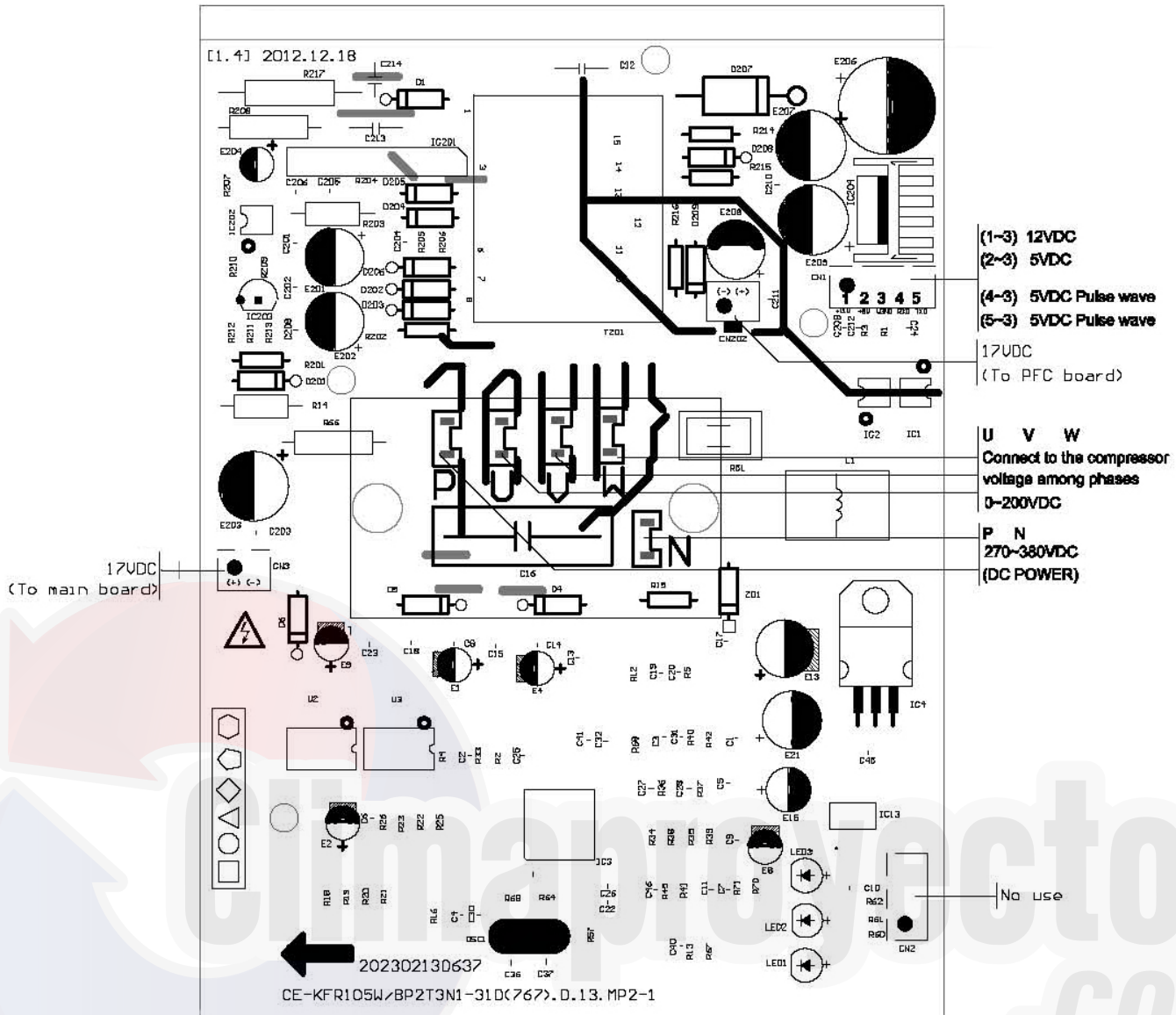

Fig. 16 – IPM Board Size 36

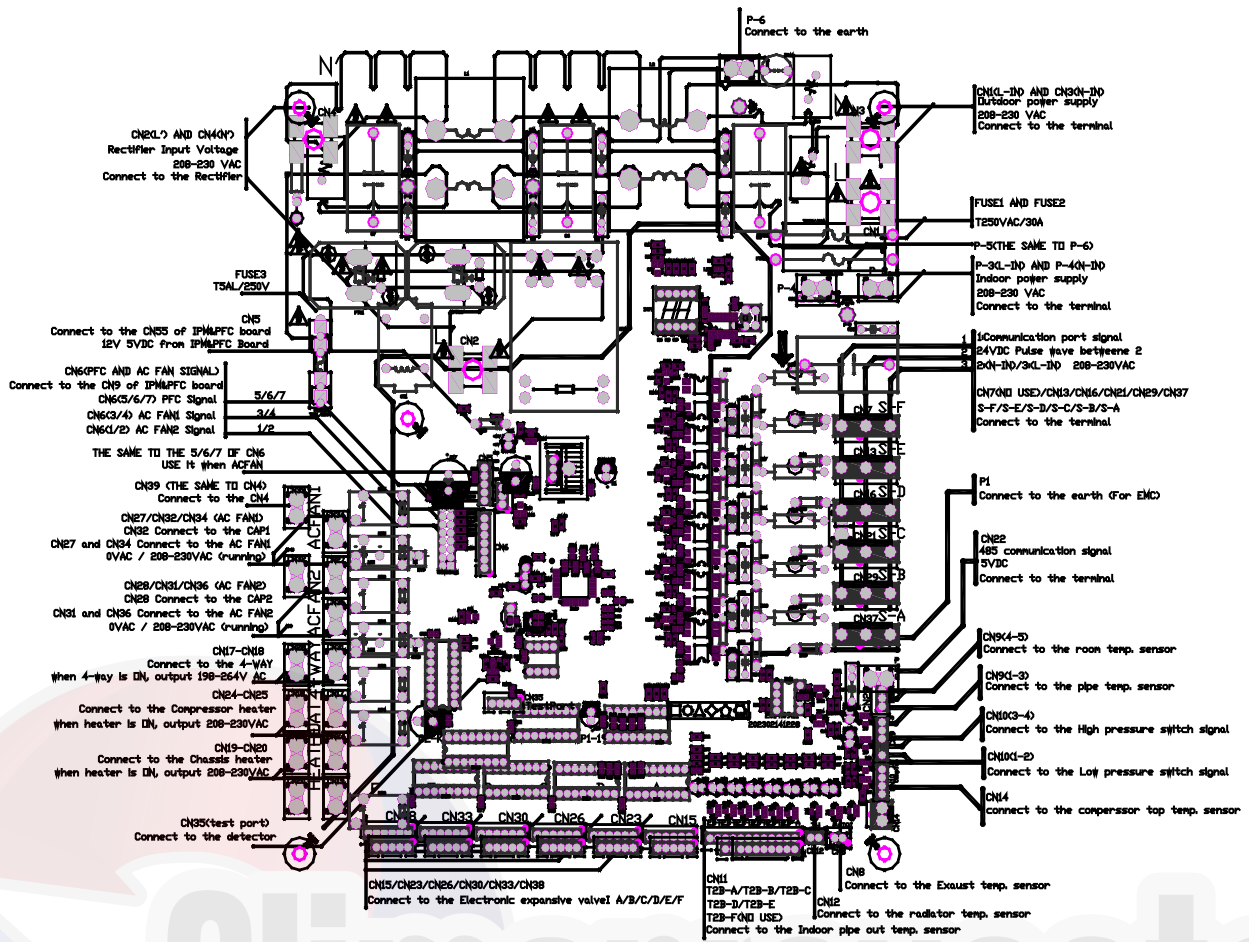

Fig. 17 – PCB Board Size 48

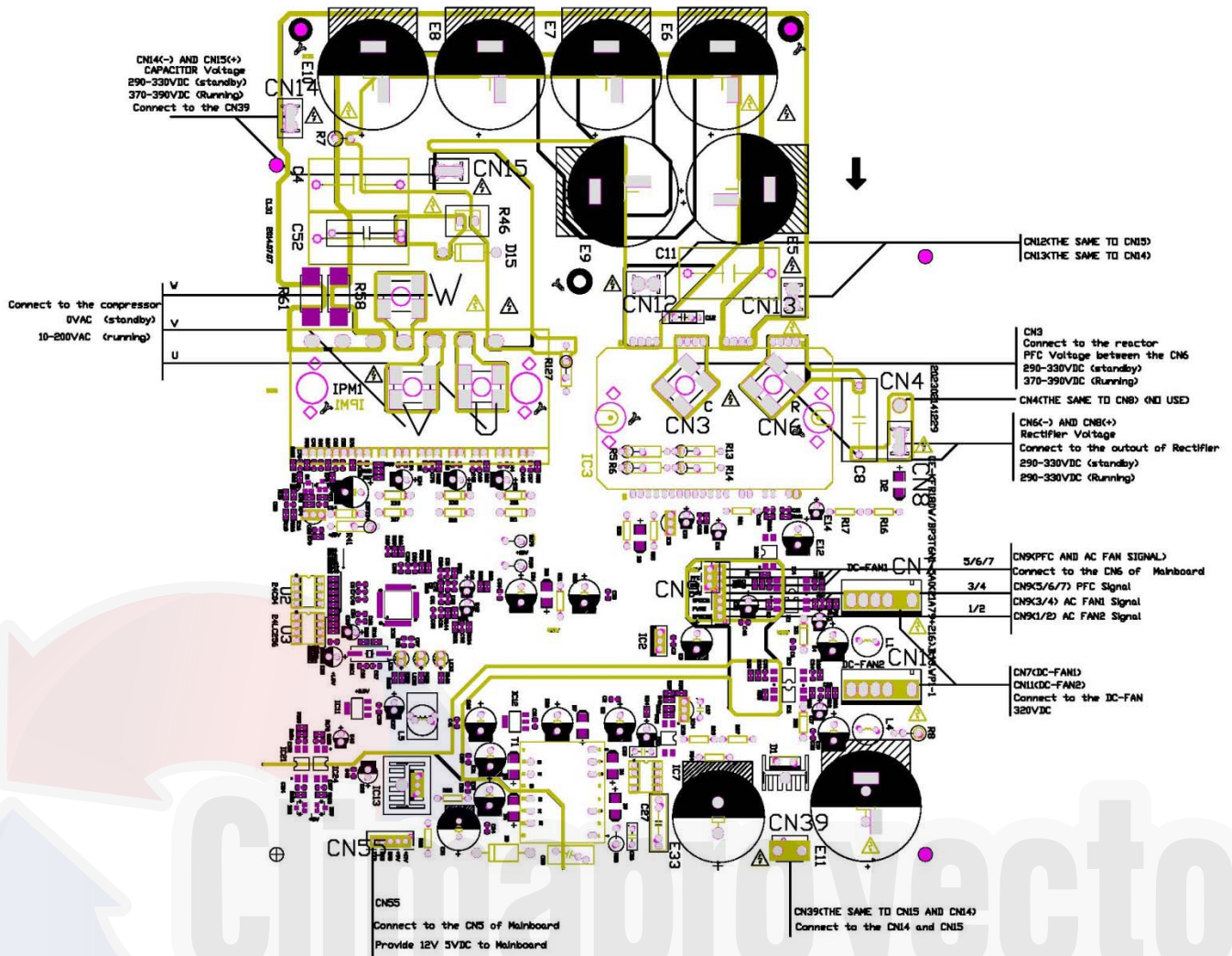

Fig. 18 – IPM and PFC Board Size 48

WIRING DIAGRAMS

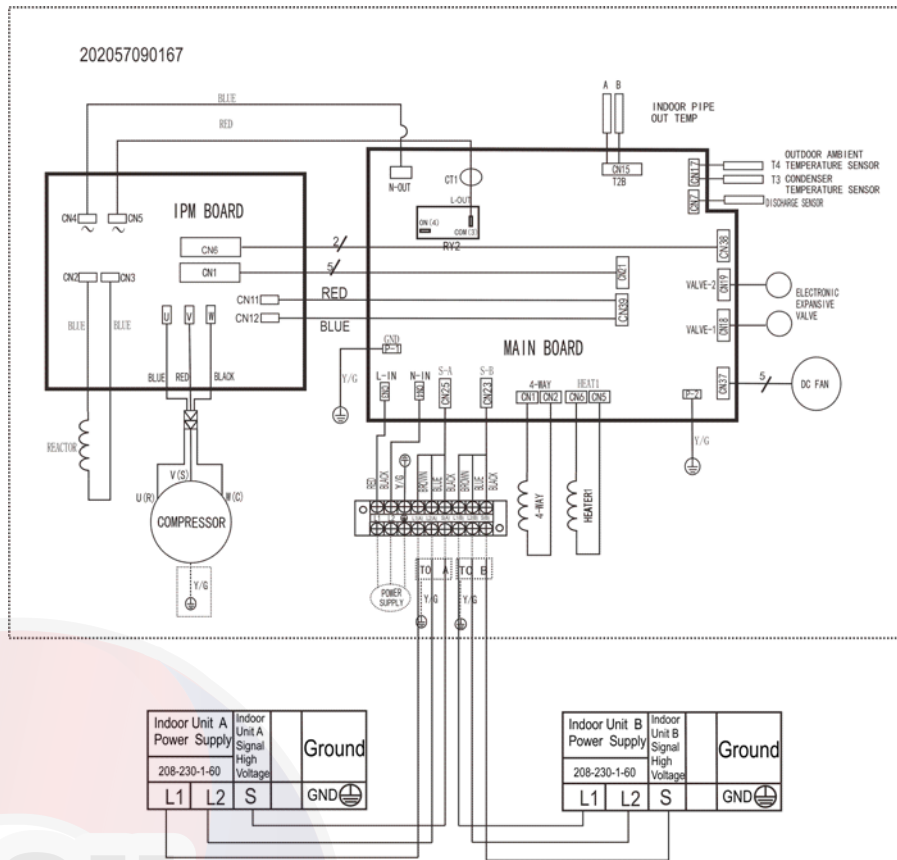

Fig. 19 – Wiring Diagrams 18k

Table 12—Outdoor Unit Control Board Size 18

CODE	PART NAME
CN18/CN19/CN22	Output:Pin5&6(12V) Pin1-Pin4:Pulse waveform,(0-12V)
CN17	Input:Pin3-4 (5V) Pin2(0V),Pin1,Pin5(0-5V)
CN7	Input:Pin1 (0-5V) Pin2(5V)
CN1~CN2, CN5~CN6	Output: CN1~CN2, CN5~CN6 (230VAC High voltage)
P1~P2	Output: Connection of the high voltage
CN3~CN4	Input:230VAC High voltage
CN14	Input: Pin1,Pin3(0V), Pin2,Pin4 (0-5V)
P-1,P-2	Connection to the earth
CN20,CN23,CN25	Output: Pin1 (Connection of the high voltage) , Pin2~Pin3 (230VAC High voltage)
CN15	Input: Pin1,Pin3,Pin5(5V), Pin2,Pin4,Pin6 (0-5V)
CN37	Output: Pulse(0-320VDC) for DC FAN
CN38	Input: Pin1~Pin2 (17VDC)
N-OUT~L-OUT	Output: 230VAC High voltage
CN21	input: Pin1~Pin3 (12VDC) , Pin2~Pin3 (5VDC) , Pin4~Pin3 (0~5VDC) , Pin5~Pin3 (0~5VDC)
CN39	Input: 270~370VDC High voltage
OUTDOOR UNIT IPM BOARD	
CN4~CN5	Output: 230VAC High voltage
CN2,CN3	Connect to Reactor, (270~370VDC)
CN6	Output: Pin1~Pin2 (17VDC)
CN1	Output: Pin1~Pin3 (12VDC) , Pin2~Pin3 (5VDC) , Pin4~Pin3 (0~5VDC) , Pin5~Pin3 (0~5VDC) ,
CN11~CN12	Output: 270~370VDC High voltage
U~V~W	Connect to compressor voltage among phases 0~200VAC

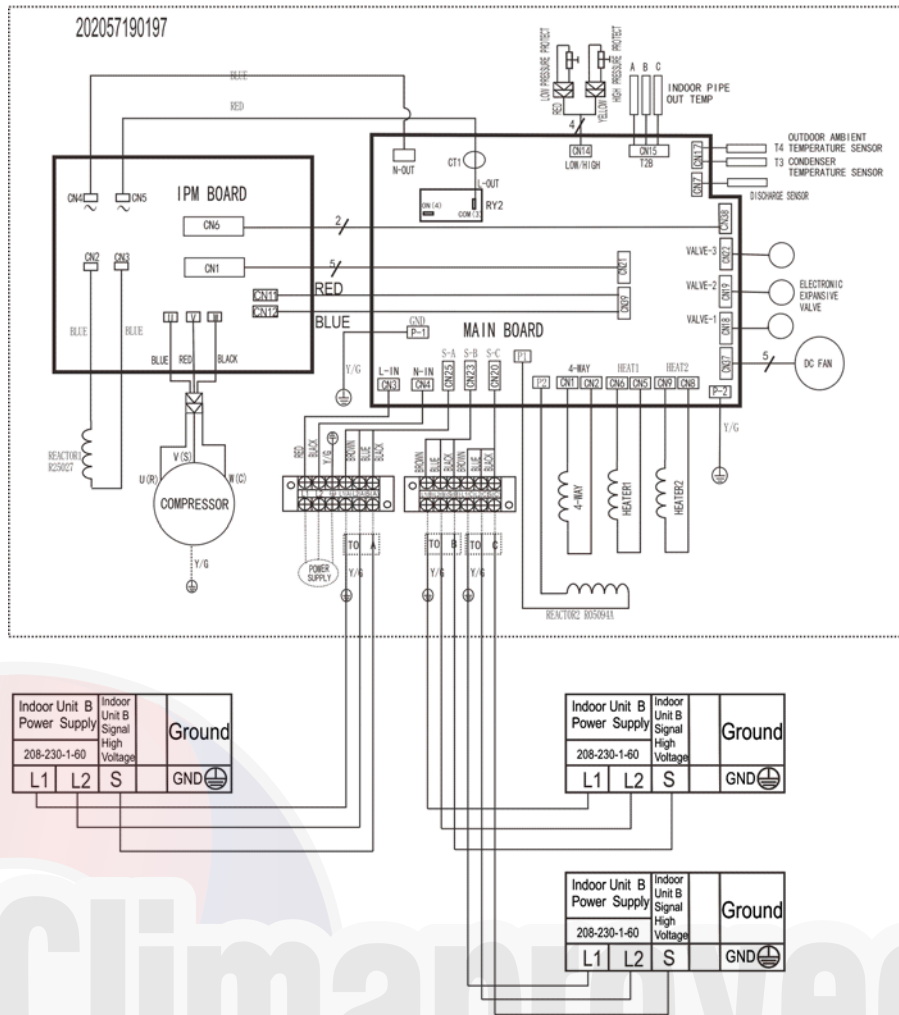

Fig. 20 – Wiring Diagrams 27k

Table 13—Outdoor Unit Control Board Size 27

CODE	PART NAME
CN18/CN19/CN22	Output:Pin5&6(12V) Pin1-Pin4:Pulse waveform,(0-12V)
CN17	Input:Pin3~4 (5V) Pin2(0V),Pin1,Pin5(0-5V)
CN7	Input:Pin1 (0-5V) Pin2(5V)
CN1~CN2, CN5~CN6	Output: CN1~CN2, CN5~CN6 (230VAC High voltage)
P1~P2	Output: Connection of the high voltage
CN3~CN4	Input:230VAC High voltage
CN14	Input: Pin1,Pin3(0V), Pin2,Pin4 (0~5V)
P-1,P-2	Connection to the earth
CN20,CN23,CN25	Output: Pin1 (Connection of the high voltage) , Pin2~Pin3 (230VAC High voltage)
CN15	Input: Pin1,Pin3,Pin5(5V), Pin2,Pin4,Pin6 (0~5V)
CN37	Output: Pulse(0-320VDC) for DC FAN
CN38	Input: Pin1~Pin2 (17VDC)
N-OUT~L-OUT	Output: 230VAC High voltage
CN21	input: Pin1~Pin3 (12VDC) , Pin2~Pin3 (5VDC) , Pin4~Pin3 (0~5VDC) , Pin5~Pin3 (0~5VDC)
CN39	Input: 270~370VDC High voltage
OUTDOOR UNIT IPM BOARD	
CN4~CN5	Output: 230VAC High voltage
CN2,CN3	Connect to Reactor, (270~370VDC)
CN6	Output: Pin1~Pin2 (17VDC)
CN1	Output: Pin1~Pin3 (12VDC) , Pin2~Pin3 (5VDC) , Pin4~Pin3 (0~5VDC) , Pin5~Pin3 (0~5VDC) ,
CN11~CN12	Output: 270~370VDC High voltage
U~V~W	Connect to compressor voltage among phases 0~200VAC

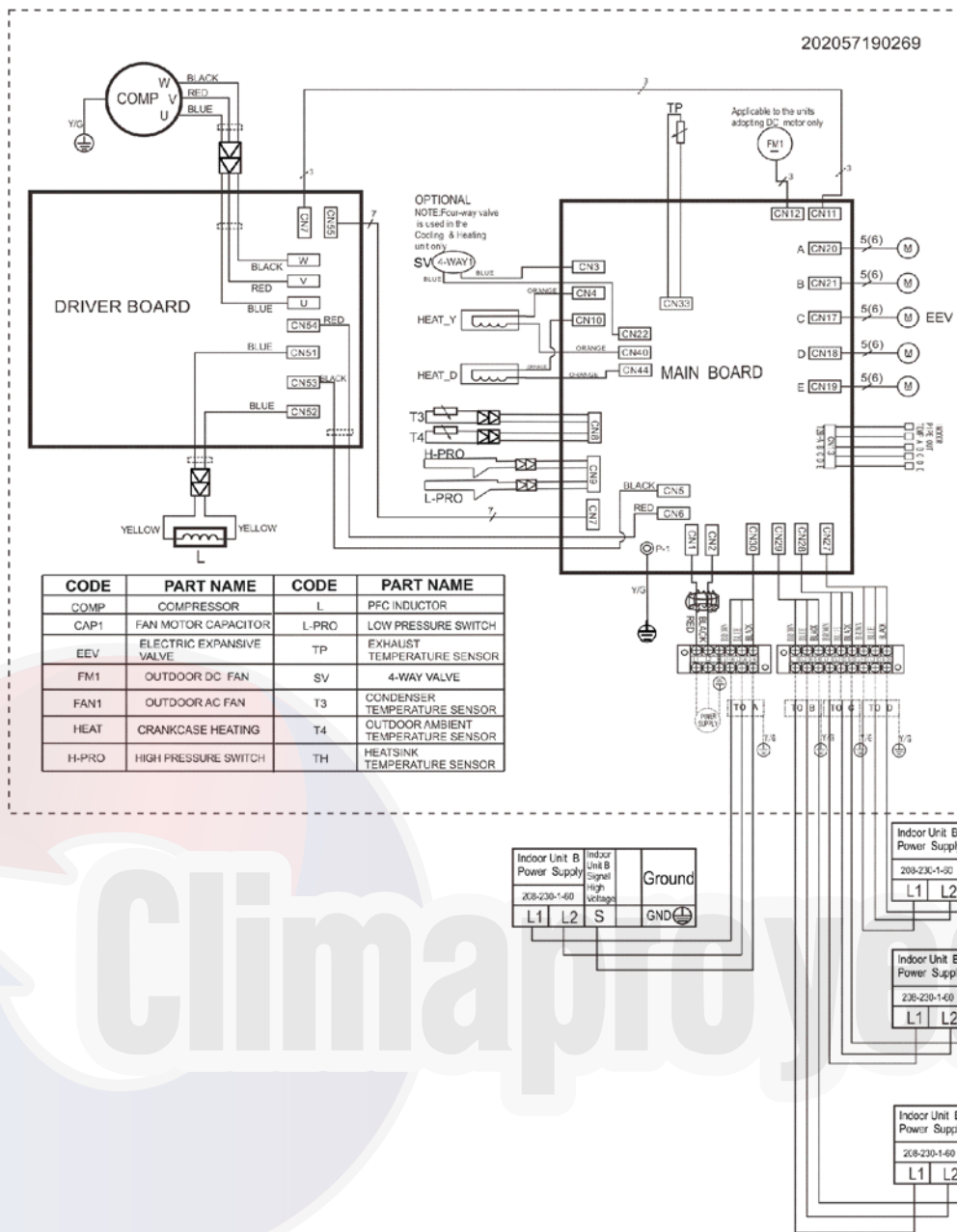

Fig. 21 – Wiring Diagram 36k

Table 14—Outdoor Unit Control Board Size 36

CODE	PART NAME
CN17/CN18/CN19/CN20/CN21	Output:Pin5&6(12V) Pin1-Pin4:Pulse waveform,(0-12V)
CN8	Input:Pin3~4 (5V) Pin2(0V),Pin1,Pin5(0-5V)
CN33	Input:Pin1 (0-5V) Pin2(5V)
CN4~CN40, CN10~CN44	Output: CN4~CN40, CN10~CN44 (230VAC High voltage)
CN3~CN22	Output: High voltage for 4-way control
CN1~CN2	Input:230VAC High voltage
CN9	Input: Pin1,Pin3(0V), Pin2,Pin4 (0~5V)
P-1	Connection to the earth
CN27,CN28,CN29,CN30	Output: Pin1 (Connection of the high voltage) , Pin2~Pin3 (230VAC High voltage)
CN13	Input: Pin1,Pin3,Pin5(5V), Pin2,Pin4,Pin6 (0~5V)
CN12	Output: Pulse(0-200VAC) for DC FAN
CN11	Output: Pulse(0-200VAC) for DC FAN
CN5~CN6	Output: 230VAC High voltage
CN7	input: Pin1~Pin3 (12VDC) , Pin2~Pin3 (5VDC) , Pin4~Pin3 (0~5VDC) , Pin5~Pin3 (0~5VDC) , Pin6~Pin3 (0~5VDC) , Pin7~Pin3 (0~5VDC)
OUTDOOR UNIT IPM BOARD	
CN4~CN5	Output: 230VAC High voltage
CN2,CN3	Connect to Reactor, (270~370VDC)
CN6	Output: Pin1~Pin2 (17VDC)
CN1	Output: Pin1~Pin3 (12VDC) , Pin2~Pin3 (5VDC) , Pin4~Pin3 (0~5VDC) , Pin5~Pin3 (0~5VDC) ,
CN11~CN12	Output: 270~370VDC High voltage
U~V~W	Connect to compressor voltage among phases 0~200VAC

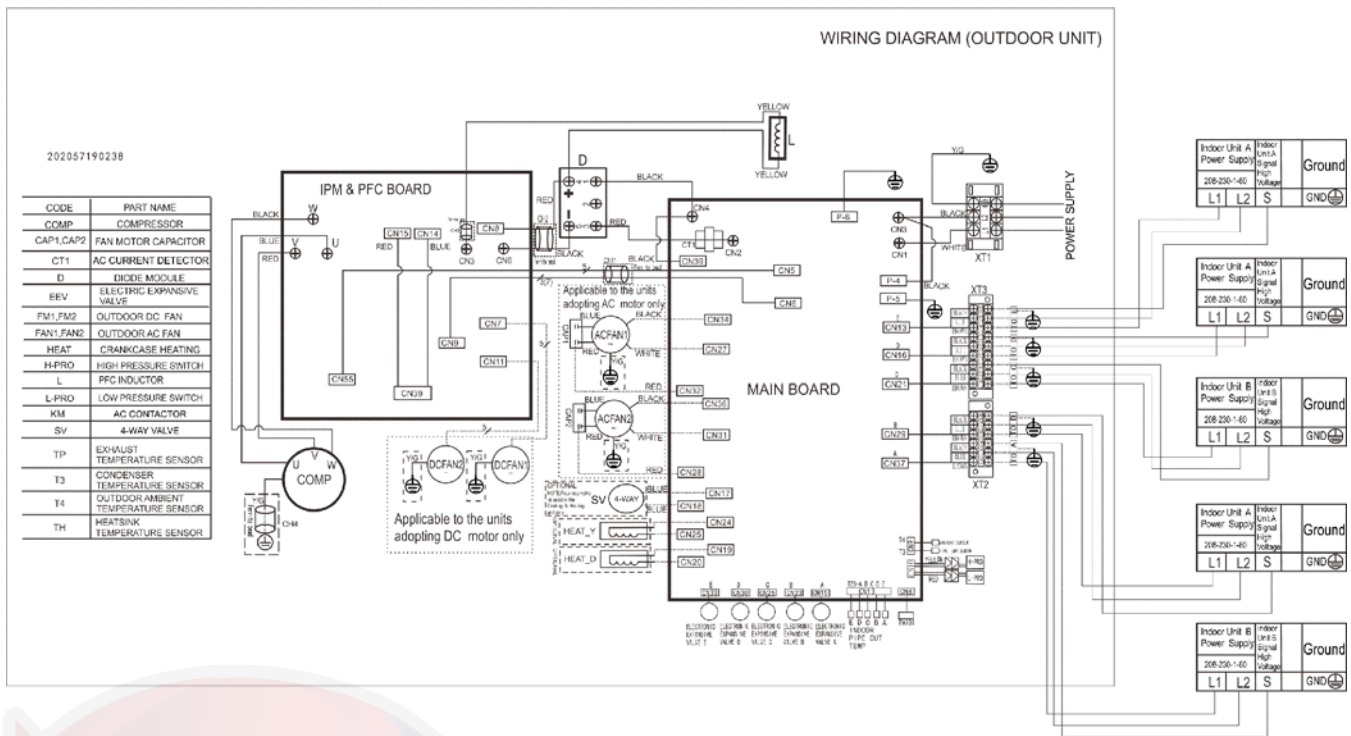

Fig. 22 – Wiring Diagrams 48K

Table 15—Outdoor Unit Control Board Size 48

CODE	PART NAME
CN1,CN3、P-1	Power input: 230V AC
CN2,CN4	Output: Power output for DRIVER BOARD (230V AC)
CN5	Input: Communication Main board and IPM Board ,Pin1(5V DC)
CN6	Input: DC FAN motor1 and DC FAN motor2 control, (Pin7 5V DC)
CN8,CN9	Input: Temperature sensor(5V DC)
CN10	Input: Pressure test (5V DC)
CN13	Input: Indoor pipe Temperature sensor,Pin1&Pin3&Pin5&Pin7&Pin9&Pin11 (5V DC)
CN15,CN23,CN26, CN30,CN33	Output: PMV control, Pin5(12V DC),Pin6(12V DC)
CN17,CN18	Output: High voltage for 4-way(SV) control (230V AC)
CN19,CN20	Output: High voltage for HEAT_D control (230V AC)
CN13,CN16,CN21, CN29,CN37	Output: Communication to indoor unit,Pin2 and Pin3 (230V AC),Pin1 (S, connection to high voltage)
CN24,CN25	Output: High voltage for HEAT_Y control(230V AC)
CN27、CN32、CN34, CN28、CN31、CN36	Output: Power output for AC FAN motor1 and AC FAN motor2 (230V AC)
CN39	Output: L2 for AC FAN、SV and HEAT ,High voltage (AC)
P-5,P-6	Connection to the earth

OUTDOOR UNIT IPM BOARD	
U V W	Output: Pulse(0-380VDC) for COMPRESSOR
CN3	Output: Connect PFC Inductance, high DC voltage
CN6 ,CN8	Input: Power input for DRIVER BOARD (200-320V DC)
CN7,CN11	Output: DC FAN motor1 and DC FAN motor2 -control (Pin1 310V or 380V DC)
CN9	Output: Communication Main board and IPM Board Pin7(5V DC)
CN55	Output: Communication IPM Board and Main board Pin1(12V DC)
CN14、CN15-- CN39,	Output: High DC voltage (310V or 380V DC)

REFRIGERATION CYCLE DIAGRAMS

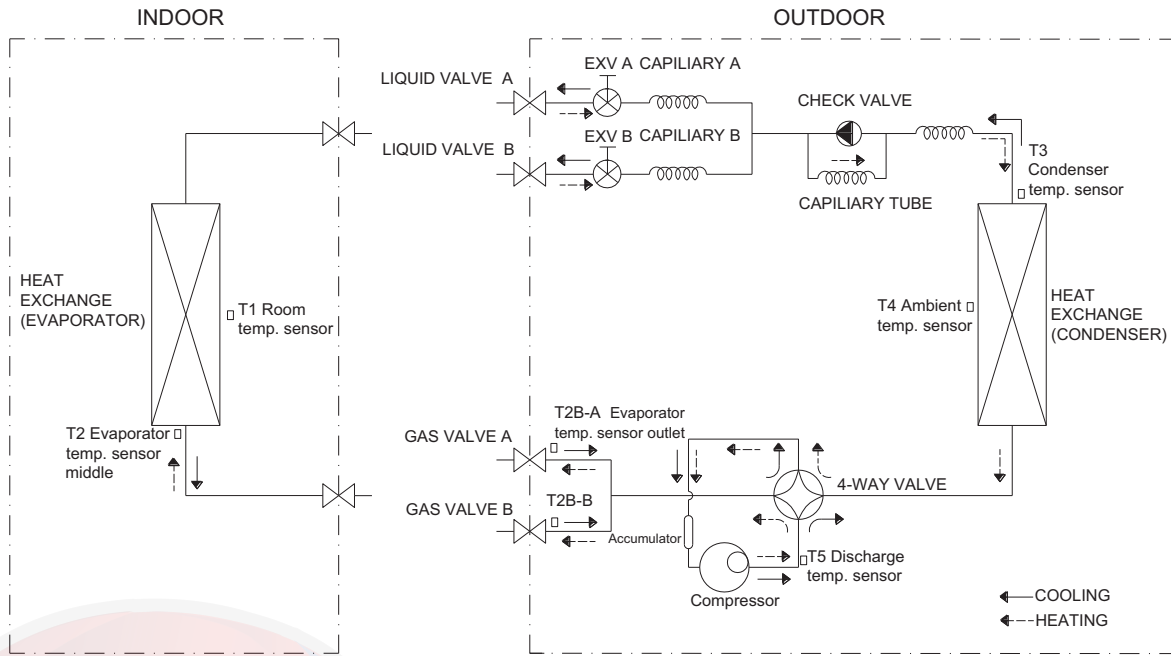

Fig. 23 – Refrigeration Cycle Diagram Size 18

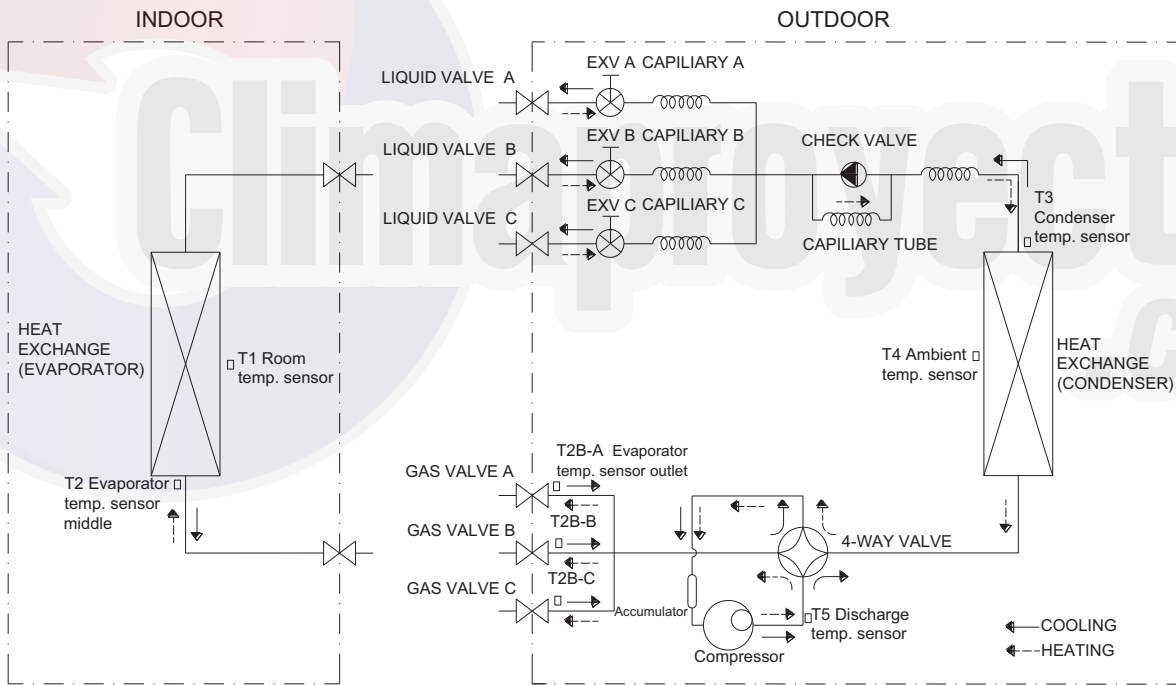

Fig. 24 – Refrigeration Cycle Diagram Size 27

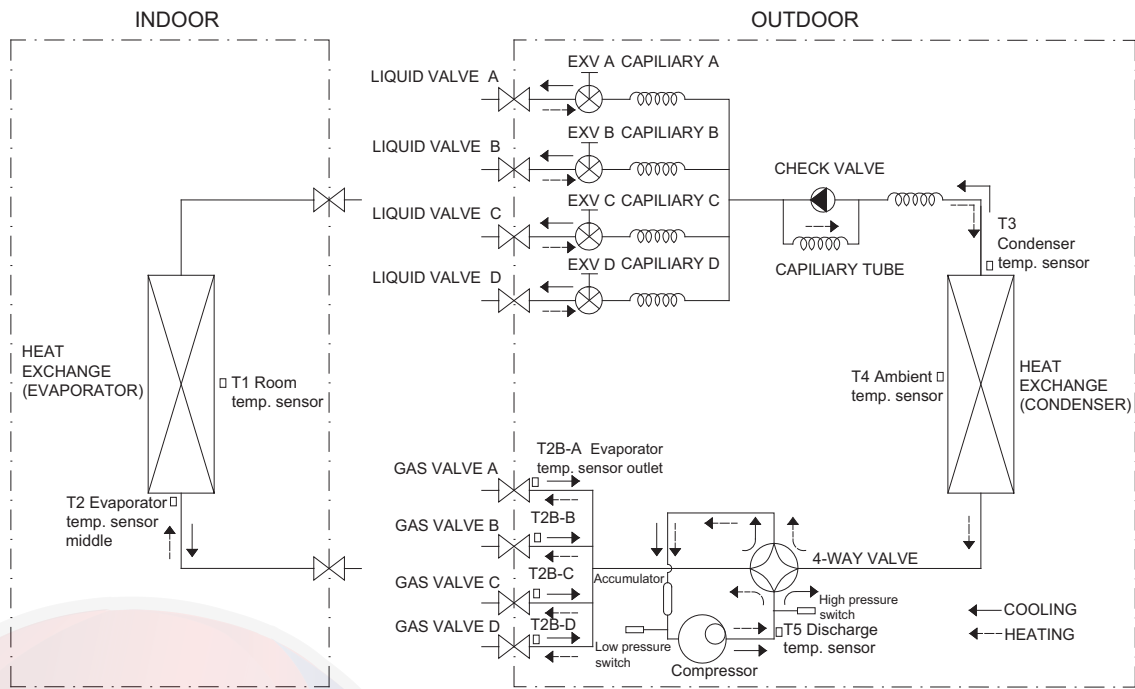

Fig. 25 – Refrigeration Cycle Diagram Size 36

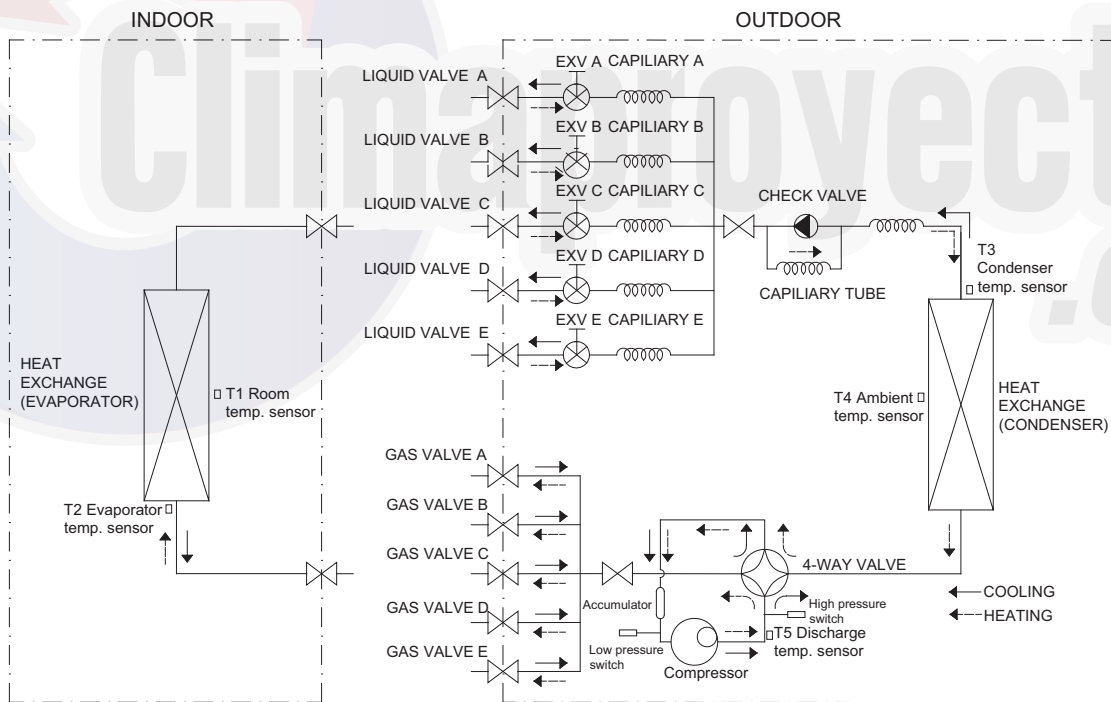

Fig. 26 – Refrigeration Cycle Diagram Size 48

REFRIGERANT LINES

General refrigerant line sizing:

- 1 The outdoor units are shipped with a full charge of R410A refrigerant. All charges, line sizing, and capacities are based on runs of 25 ft (7.6 m) per number of zones. For runs over 25 ft (7.6 m), consult long-line section on this page for proper charge adjustments.
- 2 Minimum refrigerant line length between the indoor and outdoor units is 10 ft. (3 m).

- 3 Refrigerant lines should not be buried in the ground. If it is necessary to bury the lines, not more than 36-in (914 mm) should be buried. Provide a minimum 6-in (152 mm) vertical rise to the service valves to prevent refrigerant migration.
- 4 Both lines must be insulated. Use a minimum of 1/2-in. (12.7 mm) thick insulation. Closed-cell insulation is recommended in all long-line applications.
- 5 Special consideration should be given to isolating interconnecting tubing from the building structure. Isolate the tubing so that vibration or noise is not transmitted into the structure.

IMPORTANT: Both refrigerant lines must be insulated separately.

- The following maximum lengths are allowed:

Table 16—Refrigerant Lines

System size			18K	27K	36K	48K
Piping	Min. Piping Length	ft (m)	10 (3)	10 (3)	10 (3)	10 (3)
	Standard Piping Length	ft (m)	25 (7.5)	25 (7.5)	25 (7.5)	25 (7.5)
	Max. outdoor-indoor height difference (OU higher than IU)	ft (m)	32(10)	32(10)	32(10)	32(10)
	Max. outdoor-indoor height difference (IU higher than OU)	ft (m)	49(15)	49(15)	49(15)	49(15)
	Max. Piping Length with no additional refrigerant charge per zone.	ft (m)	24.6(7.5)	24.6(7.5)	24.6(7.5)	24.6(7.5)
	Max. Length for one indoor unit	ft (m)	65.6(20)	82(25)	98(30)	98(30)
	Max. height different between indoor units	ft (m)	32(10)	32(10)	32(10)	32(10)
	Total Maximum Piping Length	Ft. (m)	98(2*15=30)	147(3*15=45)	196(4*15=60)	245(5*15=75)
	Additional refrigerant charge (between Standard – Max piping length)	Oz/ft (g/m)	0.16(15)	0.16(15)	0.16(15)	0.16(15)
	Gas Pipe	in	3/8*2	3/8*3	1/2+3/8*3	1/2+3/8*3
Liquid Pipe	in	1/4*2	1/4*3	1/4*4	1/4*5	
Refrigerant	Refrigerant Type		R410A	R410A	R410A	R410A
	Heat Pump Models Charge Amount	Lbs (kg)	4.19 (1.9)	6.17 (2.8)	7.94 (3.6)	10.14 (4.6)

NOTE: The refrigerant charge included is adequate for the number of zones multiplied by the max. piping length with no additional refrigerant.

Long Line Applications.:

- 1 No change in line sizing is required.
- 2 Add refrigerant per Table 17.

Table 17—Additional Charge Table Per Zone

Unit Size	Total Line Length ftper indoor unit		Additional Charge, oz/ft. ft (m)			
	Min	Max	10 - 25 (3 - 8)	>25 - 66 (8 - 20)	>66 - 82 (20 - 25)	>82 - 98 (25 - 30)
18	10	66	None	0.16	0.16	0.16
27		82				
36		98				
48						

SYSTEM EVACUATION AND CHARGING

⚠ CAUTION

UNIT DAMAGE HAZARD

Failure to follow this caution may result in equipment damage or improper operation.

Never use the system compressor as a vacuum pump.

Refrigerant tubes and indoor coil should be evacuated using the recommended deep vacuum method of 500 microns. Always break a vacuum with dry nitrogen.

SYSTEM VACUUM AND CHARGE

Using Vacuum Pump

- 1 Completely tighten all flare nuts and connect manifold gage charge hose to a charge port of the low side service valve. (See Fig. 27.)
- 2 Connect charge hose to vacuum pump.
- 3 Fully open the low side of manifold gage (see Fig. 28).
- 4 Start vacuum pump
- 5 Evacuate using the triple evacuation method.
- 6 After evacuation is complete, fully close the low side of manifold gage and stop operation of vacuum pump.
- 7 The factory charge contained in the outdoor unit is good for up to 25ft. (8 m) of line length. For refrigerant lines longer than 25ft. (8 m), add refrigerant as specified in the *ADDITIONAL REFRIGERANT CHARGE* table in this document.
- 8 Disconnect charge hose from charge connection of the low side service valve.
- 9 Fully open service valves B and A.
- 10 Securely tighten caps of service valves.

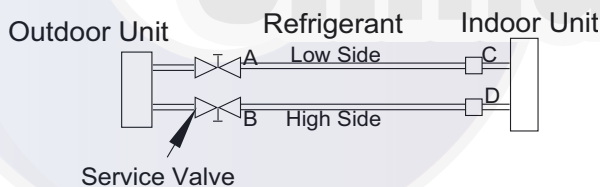

Fig. 27 – Service Valve

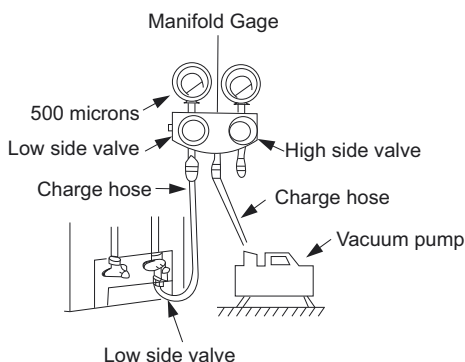

Fig. 28 – Manifold

Deep Vacuum Method

The deep vacuum method requires a vacuum pump capable of pulling a vacuum of 500 microns and a vacuum gage capable of accurately measuring this vacuum depth. The deep vacuum method is the most positive way of assuring a system is free of air and liquid water (see Fig. 29).

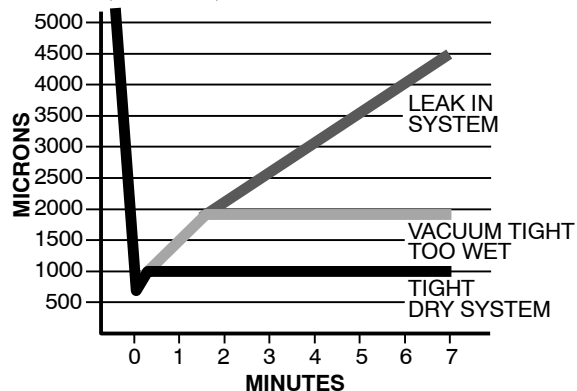

Fig. 29 – Deep Vacuum Graph

Triple Evacuation Method

The triple evacuation method should be used. Refer to Fig. 30 and proceed as follows:

- 1 Pump system down to 500 MICRONS of mercury and allow pump to continue operating for an additional 15 minutes. Unit must maintain 500 microns or less for 30 minutes or more to ensure a dry system.
- 2 Close service valves and shut off vacuum pump.
- 3 Connect a nitrogen cylinder and regulator to system and open until system pressure is 2 psig.
- 4 Close service valve and allow system to stand for 10 minutes. During this time, dry nitrogen will be able to diffuse throughout the system absorbing moisture.
- 5 Repeat this procedure as indicated in Fig. 30. System will then be free of any contaminants and water vapor.

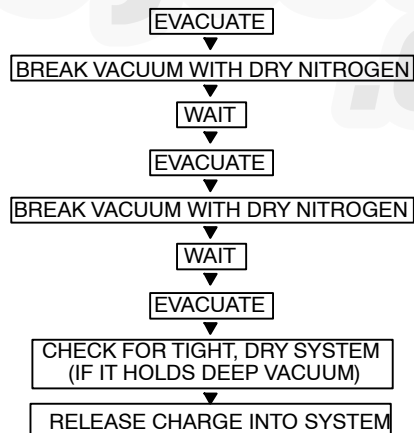

Fig. 30 – Triple Evacuation Method

Final Tubing Check

IMPORTANT: Check to be certain factory tubing on both indoor and outdoor unit has not shifted during shipment. Ensure tubes are not rubbing against each other or any sheet metal. Pay close attention to feeder tubes, making sure wire ties on feeder tubes are secure and tight.

Electronic Expansion Valve (EXV) Control

- 1 EXV will be fully closed when turning on the power. Then EXV will be standby with 350P open and will open to target angle after compressor starts.
- 2 EXV will close with - 160P when compressor stops. Then EXV will standby with 350P open and then opens to target angle after compressor starts.
- 3 The action priority of the EXVs is A-B-C-D.
- 4 Compressor and outdoor fan start operation only after EXV is initialized.

Cooling mode

- 1 The initial open angle of EXV is 250P, adjustment range is 100-350p. When the unit start to work for 3 minutes, the outdoor will receive indoor units (of capacity demand) T2B information and calculate the average of them. After comparing each indoor's T2B with the average. the outdoor gives the following modification commands: If the $T2B > \text{average}$, the relevant valve needs more 16p open. If the $T2B = \text{average}$, the relevant valve's open range remains. If the $T2B < \text{average}$, the relevant valve needs more 16p close. This modification will be carried out every 2 minutes.

6.4.4.2 Heating mode

The initial open angle of EXV is 250P, adjustment range is 100-350p. When the unit start to work for 3 minutes, the outdoor will receive indoor units (of capacity demand) T2 information and calculate the average of them. After comparing each indoor units' T2 with the average, the outdoor unit gives the following modification commands. If the $T2 < \text{average} + 2$, the relevant valve needs more 16p close. If $\text{average} + 2 \geq T2 \geq \text{average} - 2$, the relevant valve's open range remains. If the $T2 < \text{average} - 2$, the relevant valve needs more 16p open. This modification will be carried out every 2 minutes.

6.4.5 Four-way valve control

In heating mode, four-way valve is opened. In defrosting, the four-way valve operates in according to defrosting action. In other modes, the four-way valve is closed. When the heating mode to other modes, the four-way valve is off after compressor is off for 2 minutes. Failure or protection (not including discharge temperature protection, high and low pressure protection), four-way valve immediately shuts down.

TROUBLESHOOTING

This section provides the required flow charts to troubleshoot problems that may arise.

NOTE: Information required in the diagnoses can be found either on the wiring diagrams or in the appendix.

Required Tools:

The following tools are needed when diagnosing the units:

- Digital multimeter
- Screw drivers (Phillips and straight head)
- Needle-nose pliers
- Refrigeration gauges

Recommended Steps

- 1 Refer to the diagnostic hierarchy charts below and determine the problem at hand.
- 2 Go to the chart listed in the diagnostic hierarchy and follow the steps in the chart for the selected problem.

For the ease of service, the systems are equipped with diagnostic code display LED's on both the indoor and outdoor units. The outdoor diagnostic display is on the outdoor unit board and is limited to very few errors. The indoor diagnostic display is a combination of flashing LED's on the display panel on the front of the unit. If possible always check the diagnostic codes displayed on the indoor unit first.

The diagnostic codes for the indoor and outdoor units are listed in the appendix.

Problems may occur that are not covered by a diagnostic code, but are covered by the diagnostic flow charts. These problems are typical air conditioning mechanical or electrical issues that can be corrected using standard air conditioning repair techniques.

For problems requiring measurements at the control boards, note the following:

- 1 Always disconnect the main power.
- 2 When possible check the outdoor board first.
- 3 Start by removing the outdoor unit top cover.
- 4 Reconnect the main power
- 5 Probe the outdoor board inputs and outputs with a digital multi-meter referring to the wiring diagrams.
- 6 Connect the red probe to hot signal and the black probe to the ground or negative.
- 7 Note that some of the DC voltage signals are pulsating voltages for signal. this pulse should be rapidly moving at all times when there is a signal present.
- 8 If it is necessary to check the indoor unit board you must start by disconnecting the main power.
- 9 Next remove the front cover of the unit and then control box cover.
- 10 Carefully remove the indoor board from the control box, place it face up on a plastic surface (not metal).
- 11 Reconnect the main power and repeat steps 5, 6, and 7.
- 12 Disconnect main power before reinstalling board to avoid shock hazard and board damage.

Indoor Unit Diagnostic Guides

Table 18—Diagnostic Codes

Display	LED STATUS	IDU Error	IDU Error
E0	Outdoor EEPROM malfunction	F4	E6
E2	Communication malfunction between indoor and outdoor units	E1	E2
E3	Communication malfunction between IPM board and outdoor main board	—	—
E4	Open or short circuit of outdoor temperature sensor (T3、T4、T5、T2B)	F2	E6
E5	Voltage protection	P1	P0
E6	PFC module protection	—	—
E8	Outdoor fan speed has been out of control(Only for DC fan motor models)	F5	—
E9	Wrong wiring connection of 24K indoor unit	—	—
F1	No A Indoor unit coil outlet temp. sensor or connector of sensor is defective	—	—
F2	No B Indoor unit coil outlet temp. sensor or connector of sensor is defective	—	—
F3	No C Indoor unit coil outlet temp. sensor or connector of sensor is defective	—	—
F4	No D Indoor unit coil outlet temp. sensor or connector of sensor is defective	—	—
F5	No E Indoor unit coil outlet temp. sensor or connector of sensor is defective	—	—
F6	No F Indoor unit coil outlet temp. sensor or connector of sensor is defective	—	—
P0	Temperature protection of compressor top	P2	P3(P1)
P1	High pressure protection	—	—
P2	Low pressure protection	—	—
P3	Current protection of compressor	—	—(P2)
P4	Temperature protection of compressor discharge	—	—
P5	High temperature protection of condenser	—	—
P6	IPM module protection	P0	E5

Climaproyectos
.com

Diagnosis and Solution

EEPROM parameter error - diagnosis and solution (E0/F4)

Error Code	E0/F4
Malfunction decision conditions	Indoor or outdoor PCB main chip does not receive feedback from EEPROM chip.
Supposed Causes	<ul style="list-style-type: none">• Installation mistake• PCB faulty

Trouble shooting:

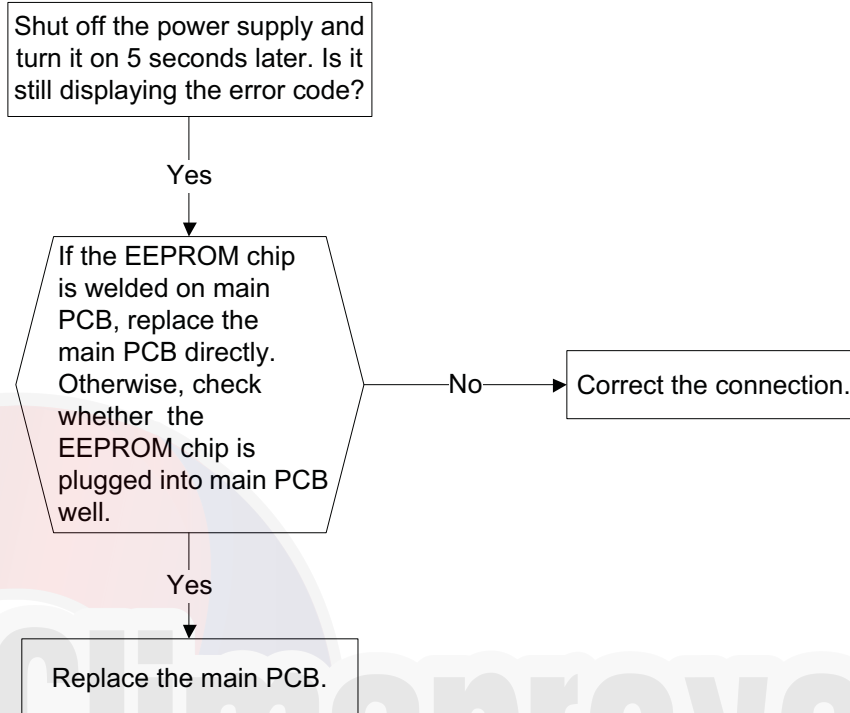

EEPROM: a read-only memory whose contents can be erased and reprogrammed using a pulsed voltage.

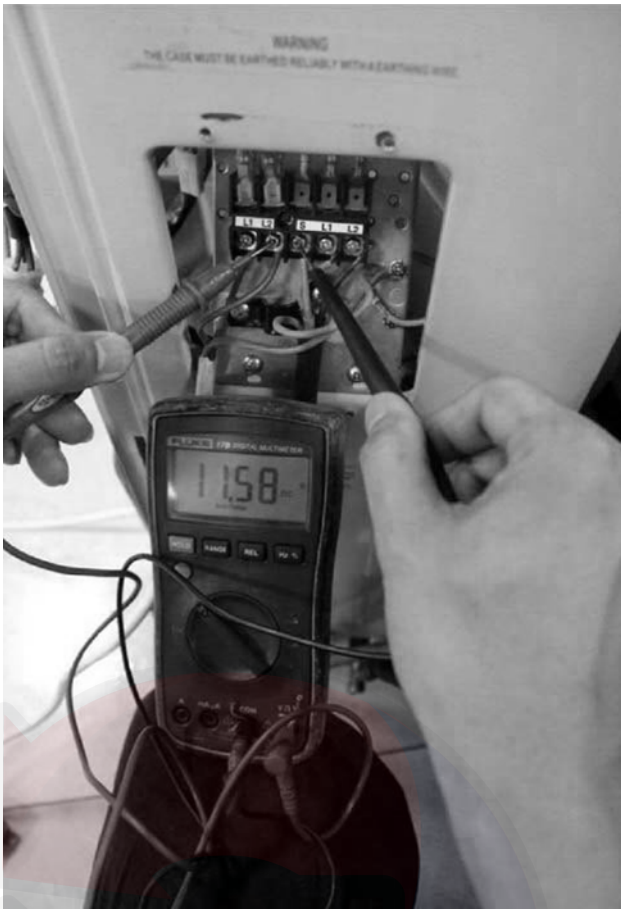

Fig. 31 – DC voltage test

Remark

Use a multimeter to test the DC voltage between the L2 port and S ports of the outdoor unit. (Fig. 31) The red pin of multimeter connects with the L2 port while the black pin is for the S port.

When the AC is running normally, the voltage will move alternatively between -50V to 50V.

If the outdoor unit has a malfunction, the voltage moves alternatively with a positive value.

If the indoor unit has a malfunction, the voltage will be a certain value. Example: 10-13VDC small fluctuating amounts indicates indoor unit malfunction.



Fig. 32 – Reactor resistance test

Remark

Use a multimeter to test the resistance of the reactor which does not connect with the capacitor (Fig. 32).

The normal values should be around zero ohm.

Otherwise, the reactor must have a malfunction and must be replaced.

Zero crossing detection error diagnosis and solution (E2)

Error Code	E2
Malfunction decision conditions	When PCB does not receive zero crossing signal feedback for 4 minutes or the zero crossing signal interval is abnormal
Supposed Causes	<ul style="list-style-type: none">• Connection mistake• PCB faulty

Troubleshooting:

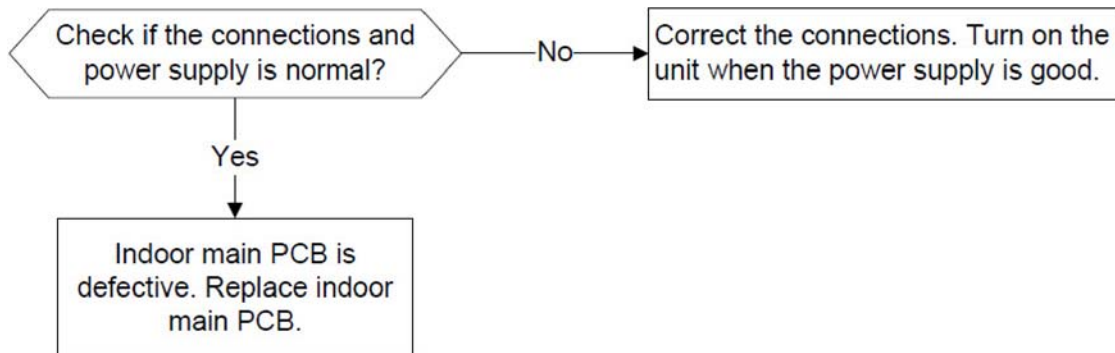

E1, E2 (Communication malfunction between indoor and outdoor units) error diagnosis and solution.

Error Code	E2
Malfunction decision conditions	Indoor unit does not receive the feedback from outdoor unit during 120 seconds or outdoor unit does not receive the feedback from any one indoor unit during 180 seconds.
Supposed Causes	<ul style="list-style-type: none"> • Wiring mistake • Indoor or outdoor PCB faulty

Troubleshooting

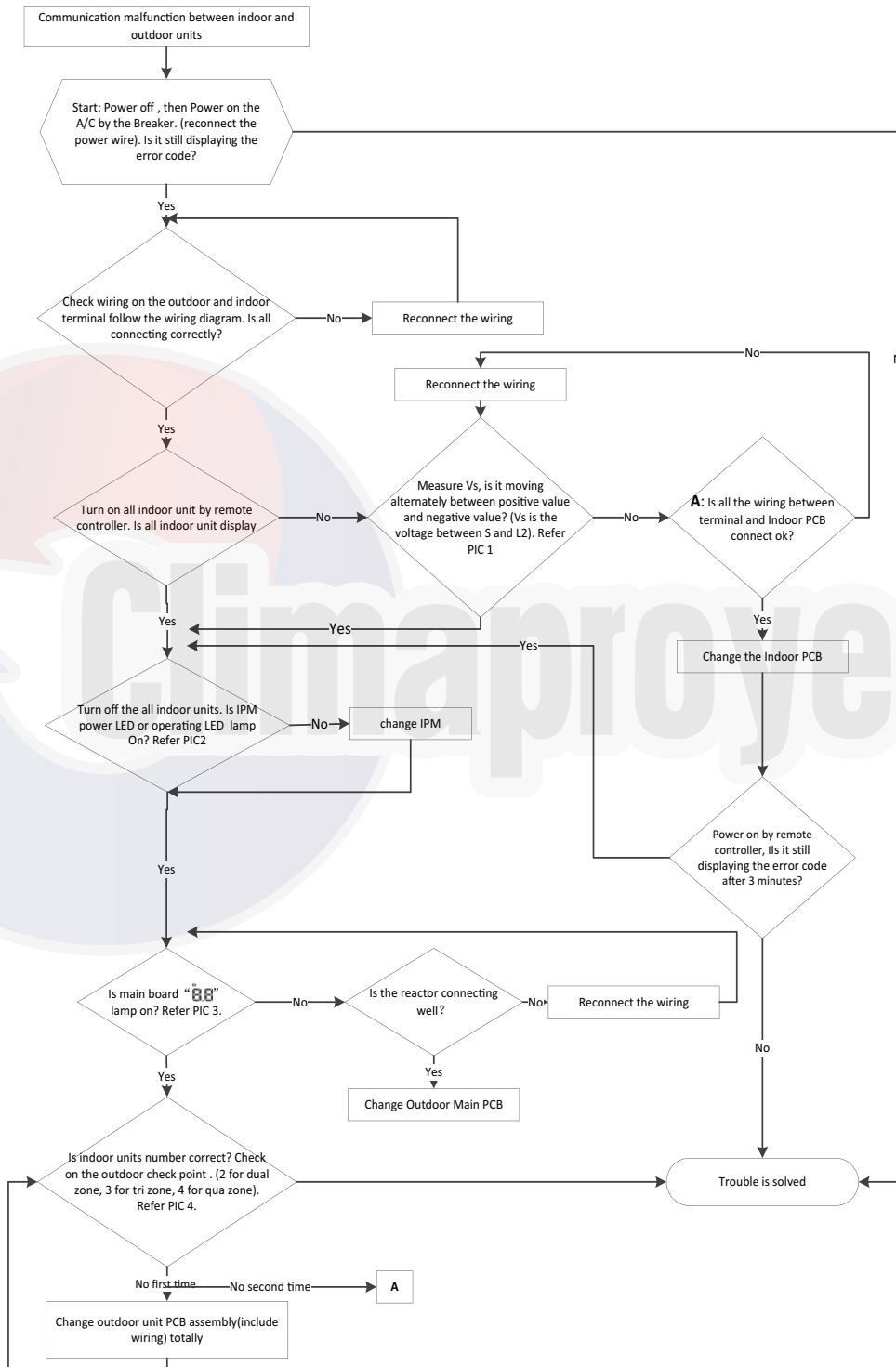

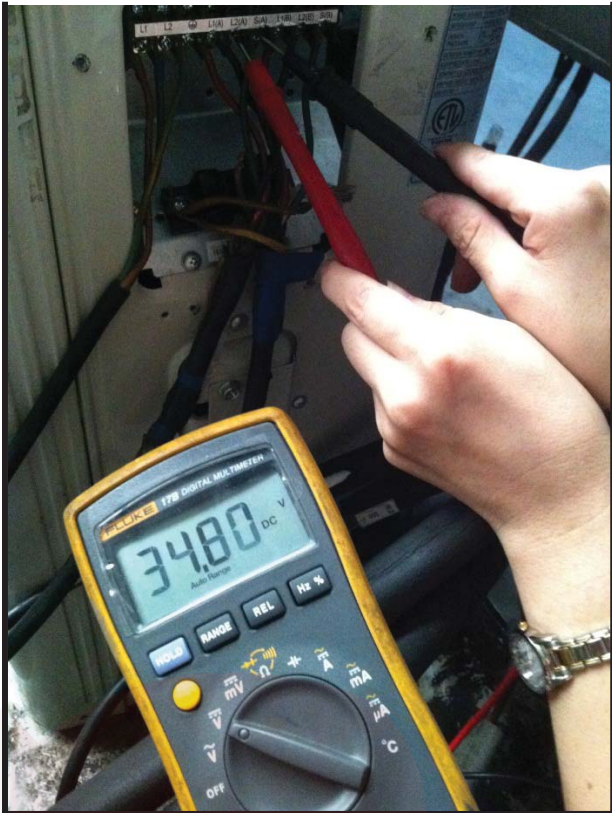

Pic 1: Use a multimeter to test the DC voltage between L2 port and S port of outdoor unit. The red pin of multimeter connects with L2 port while the black pin is for S port.

When AC is normal running, the voltage will move alternately between positive value and negative value.

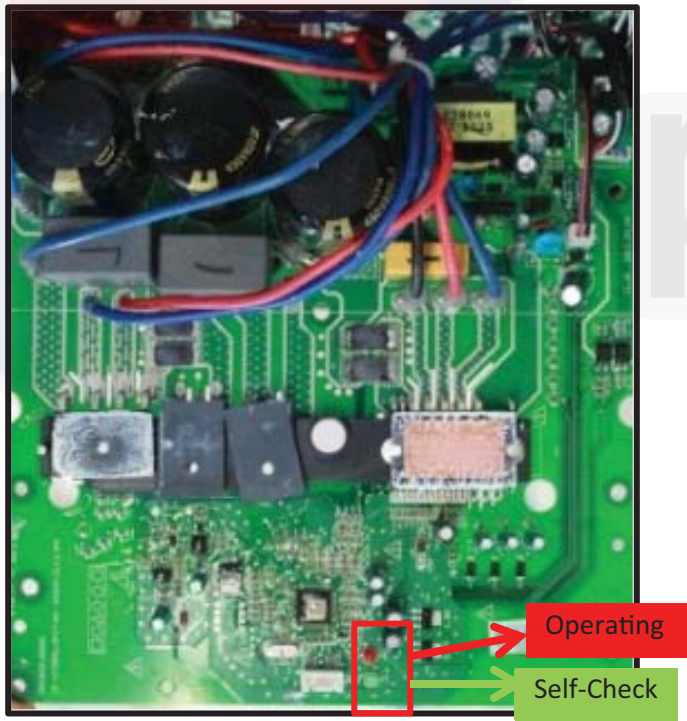

Pic 2: :IPM (For dual/tri-zone)

proyectos.com

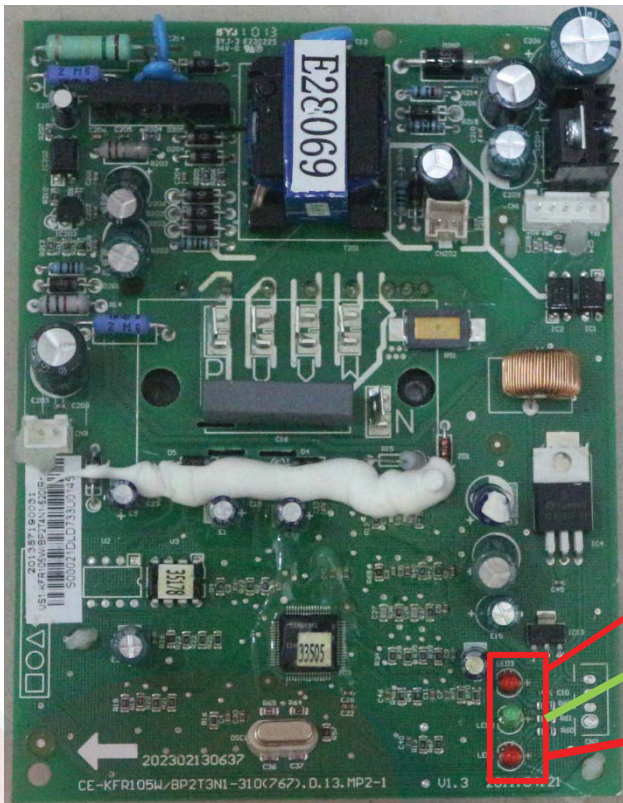

Pic 2: :IPM (For qua-zone)

- Power,
- Self-Check
- Operating

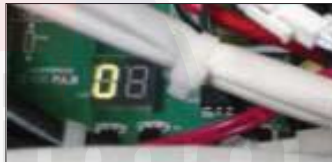

PIC3 :Main board LED when power on and unit standby.

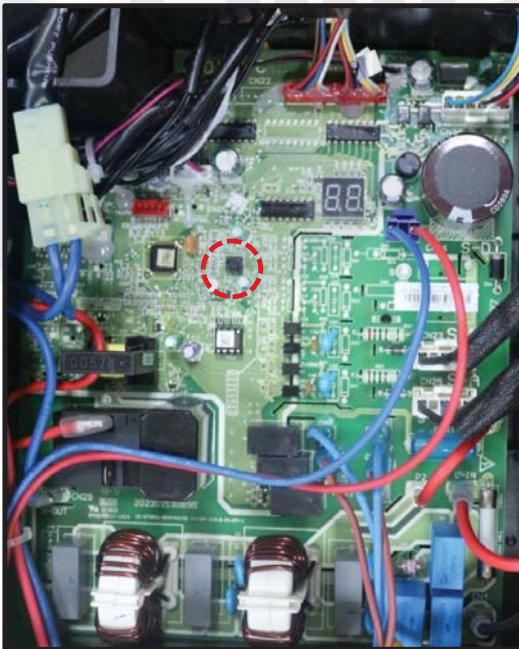

PIC 4: Check point button, press 1 time for check how many indoor units are connected.

E3(Communication malfunction between IPM board and outdoor main board) error diagnosis

Error Code	E3
Malfunction decision conditions	PCB main chip does not receive feedback from IPM module during 60 seconds.
Supposed causes	<ul style="list-style-type: none"> • Wiring mistake • PCB faulty

Troubleshooting

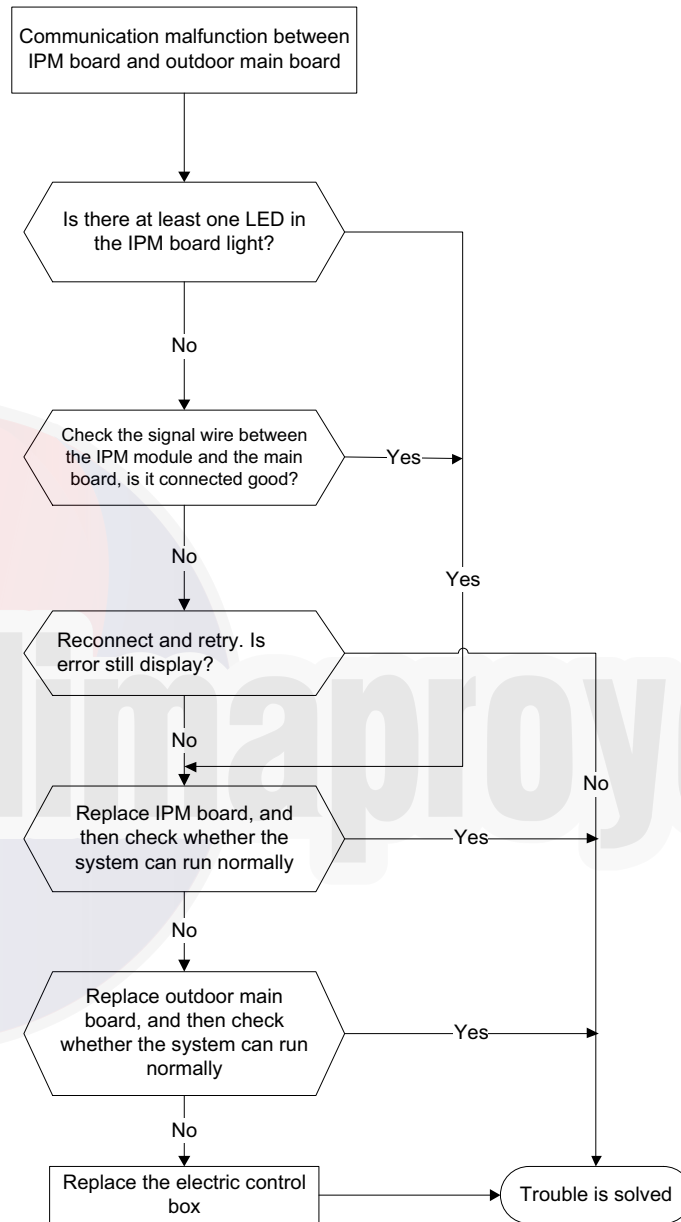

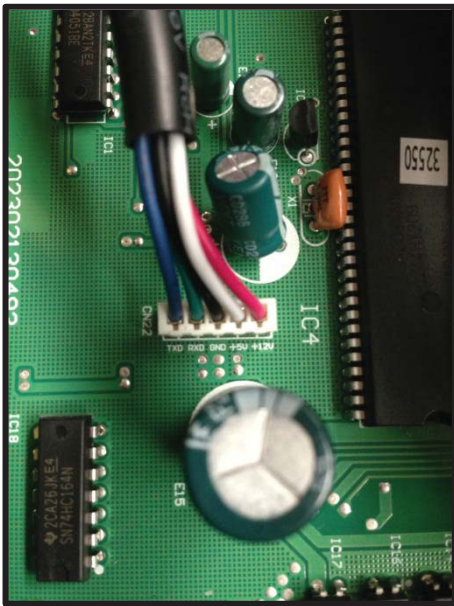

Remark:

Use a multimeter to test the DC voltage between black pin and white pin of signal wire. The normal value should be around 5V.

Use a multimeter to test the DC voltage between black pin and red pin of signal wire. The normal value should be around 12V.

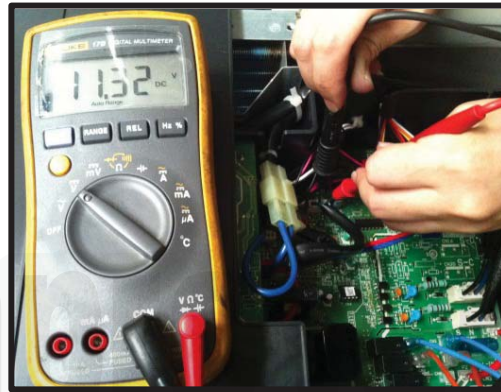
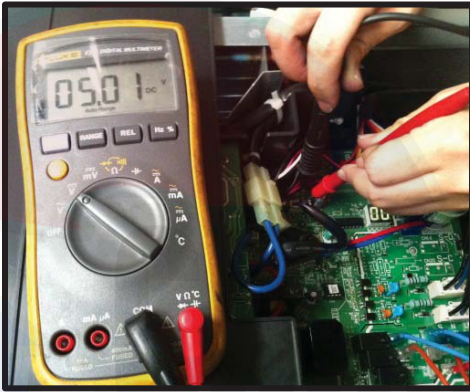

E4 (open or short circuit of outdoor temperature sensor) diagnosis and solution F1/F2/F3/F4/F5 (open or short circuit of indoor coil temperature sensor) diagnosis and solution.

Error Code	E4/F1/F2/F3/F4/F5
Malfunction decision conditions	If the sampling voltage is lower than 0.06V or higher than 4.94V, the LED displays the failure.
Supposed causes	<ul style="list-style-type: none"> • Wiring mistake • Sensor faulty • PCB faulty

Troubleshooting

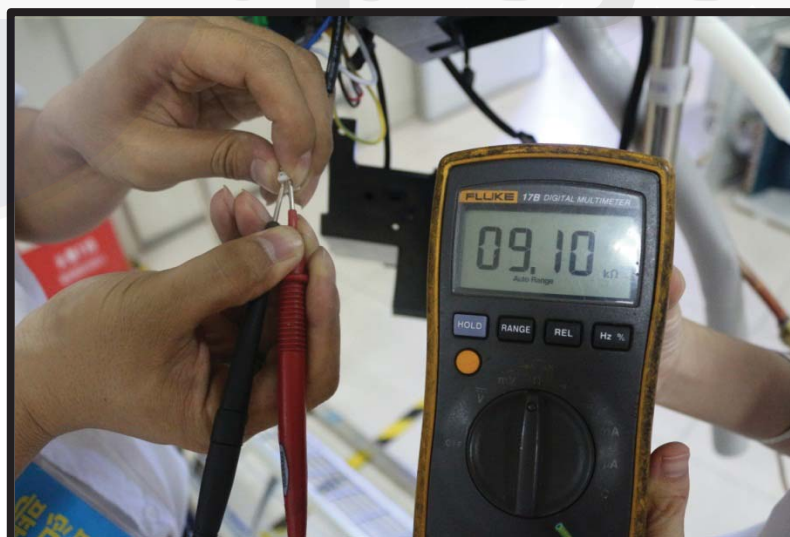
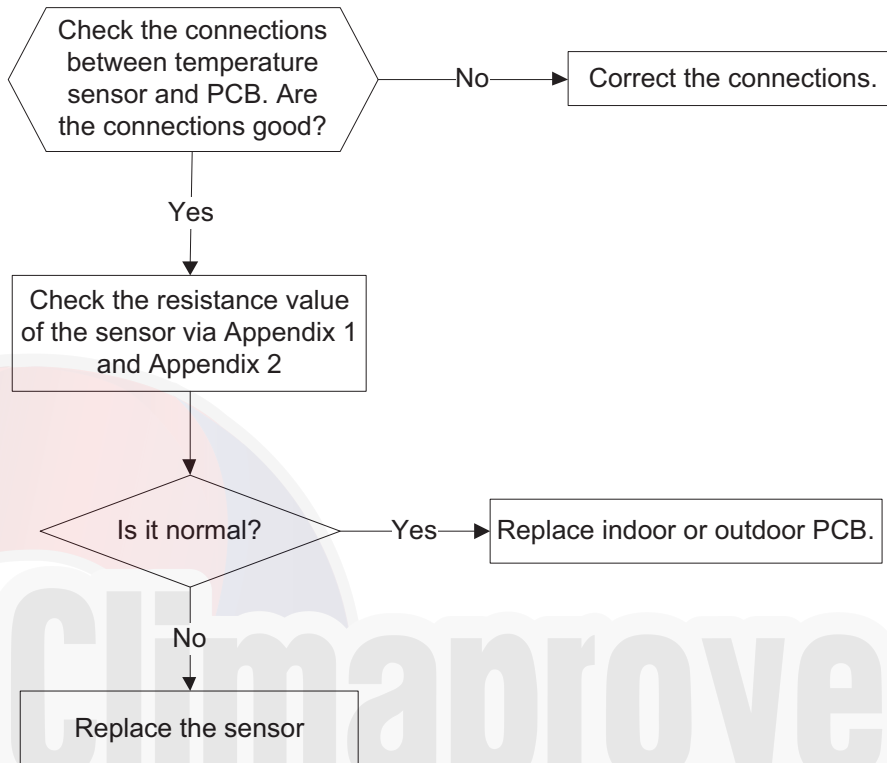

E5(Voltage protection) error diagnosis and solution.

Error Code	E5
Malfunction decision conditions	An abnormal voltage rise or drop is detected by checking the specified voltage detection circuit.
Supposed causes	<ul style="list-style-type: none"> • Power supply problems • System leakage or block • PCB faulty

Troubleshooting

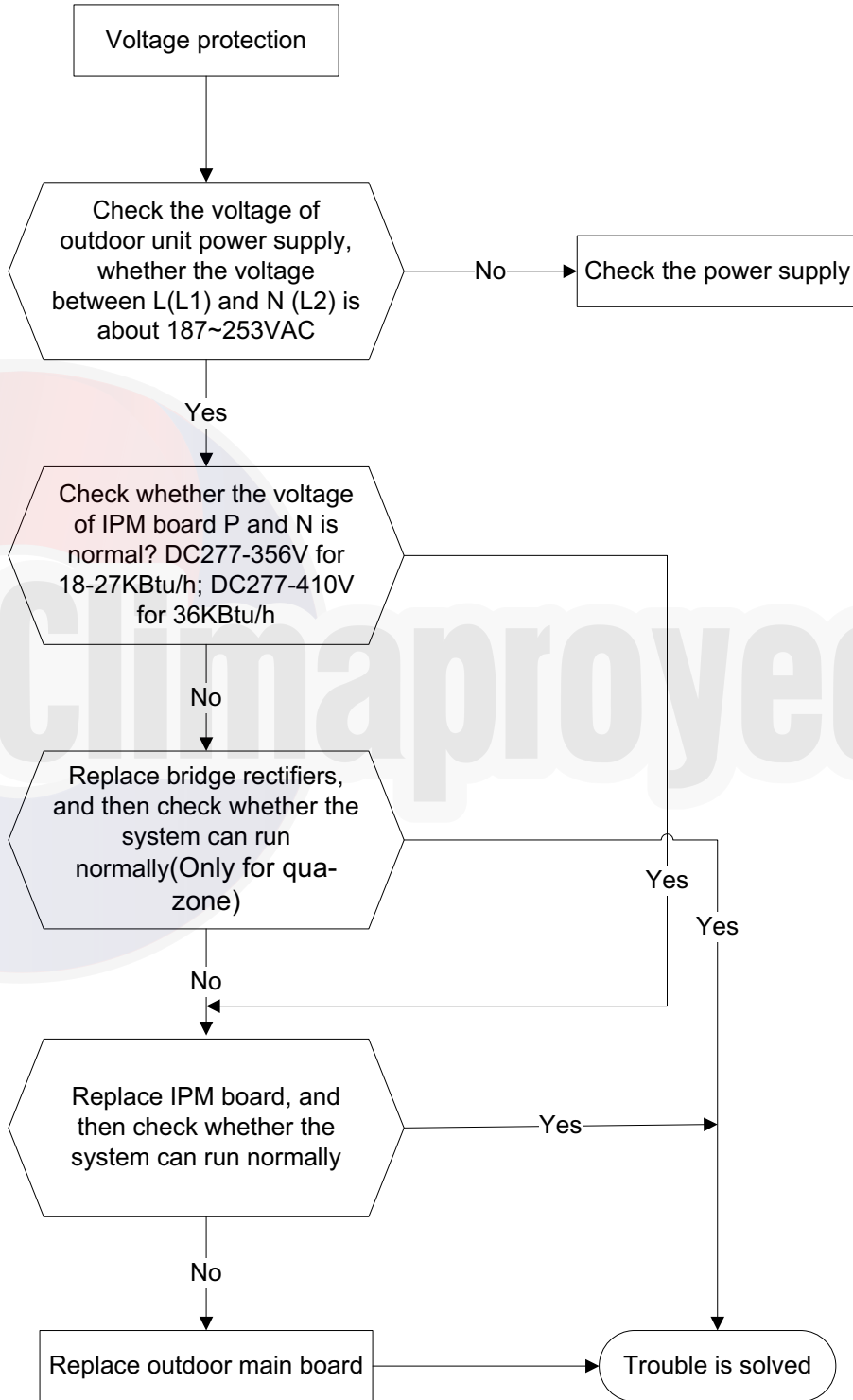

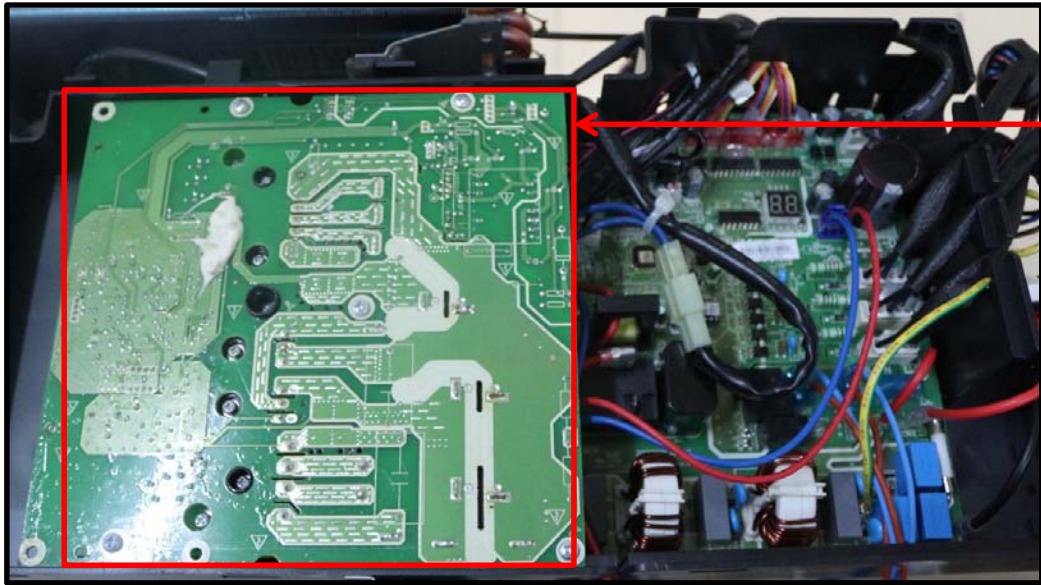

IPM (for dual/tri-zone)

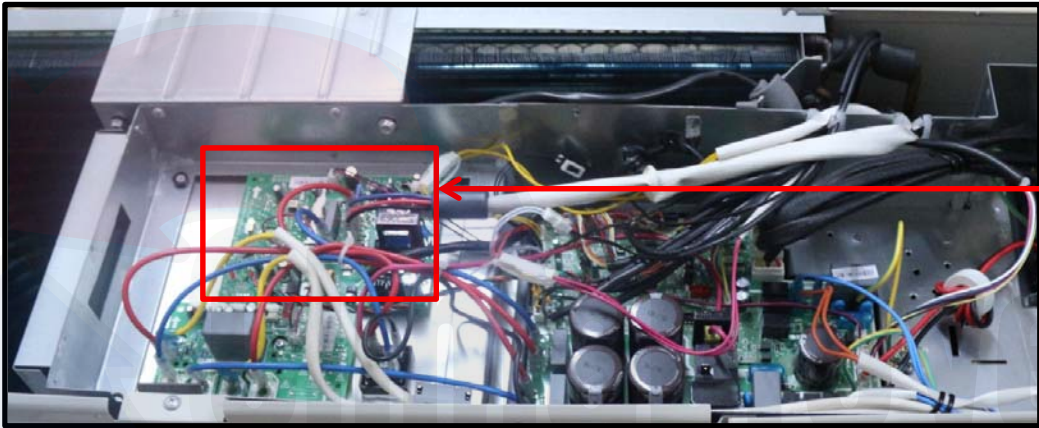

IPM (for qua-zone)



P-N (for dual/tri-zone)

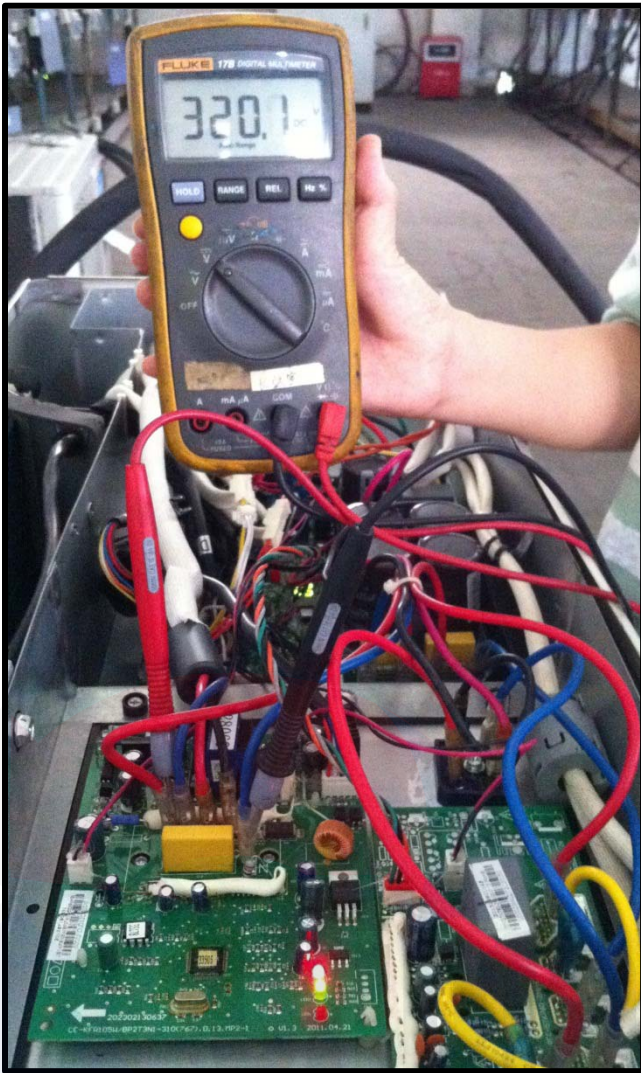

P-N (for qua-zone)

proyectos
.com



bridge rectifier
(for dual/tri-zone)

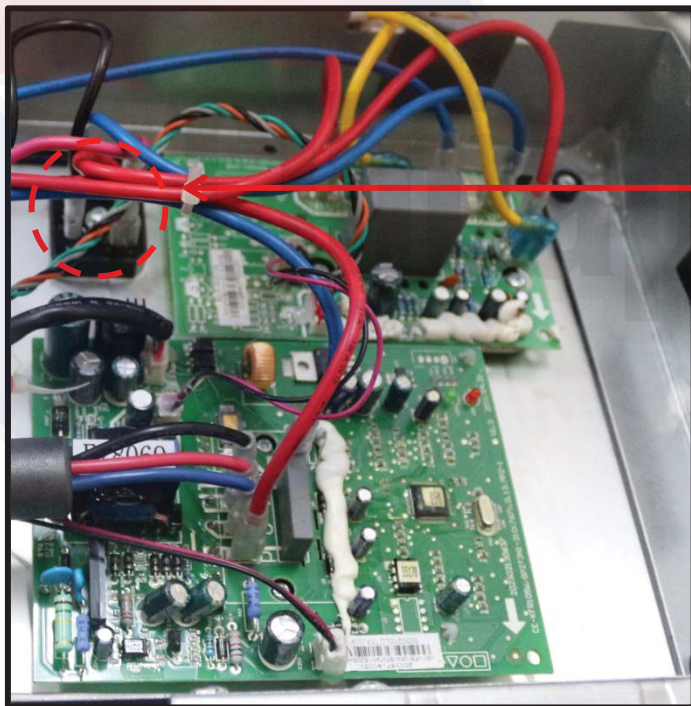

bridge rectifier
(for qua-zone)

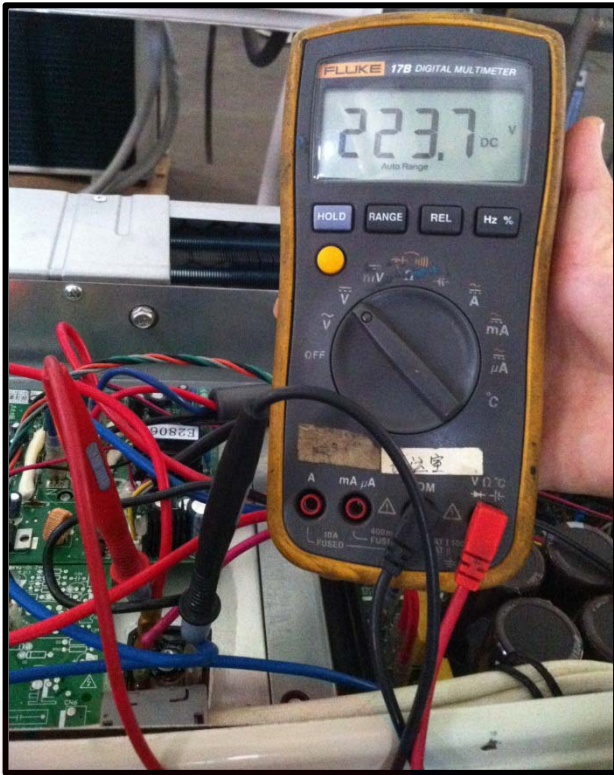

Remark:

Measure the DC voltage between + and - port. The normal value should be 190V~250V.

Climaproyectos
.com

E6(PFC module protection) error diagnosis and solution.

Error Code	E6
Malfunction decision conditions	When the voltage signal that PFC sends to main control board is abnormal, the display LED displays "E6" and the AC turns off.
Supposed causes	<ul style="list-style-type: none"> • Wiring mistake • Outdoor PCB faulty • Inductance of PFC module faulty • PFC module malfunction

Troubleshooting

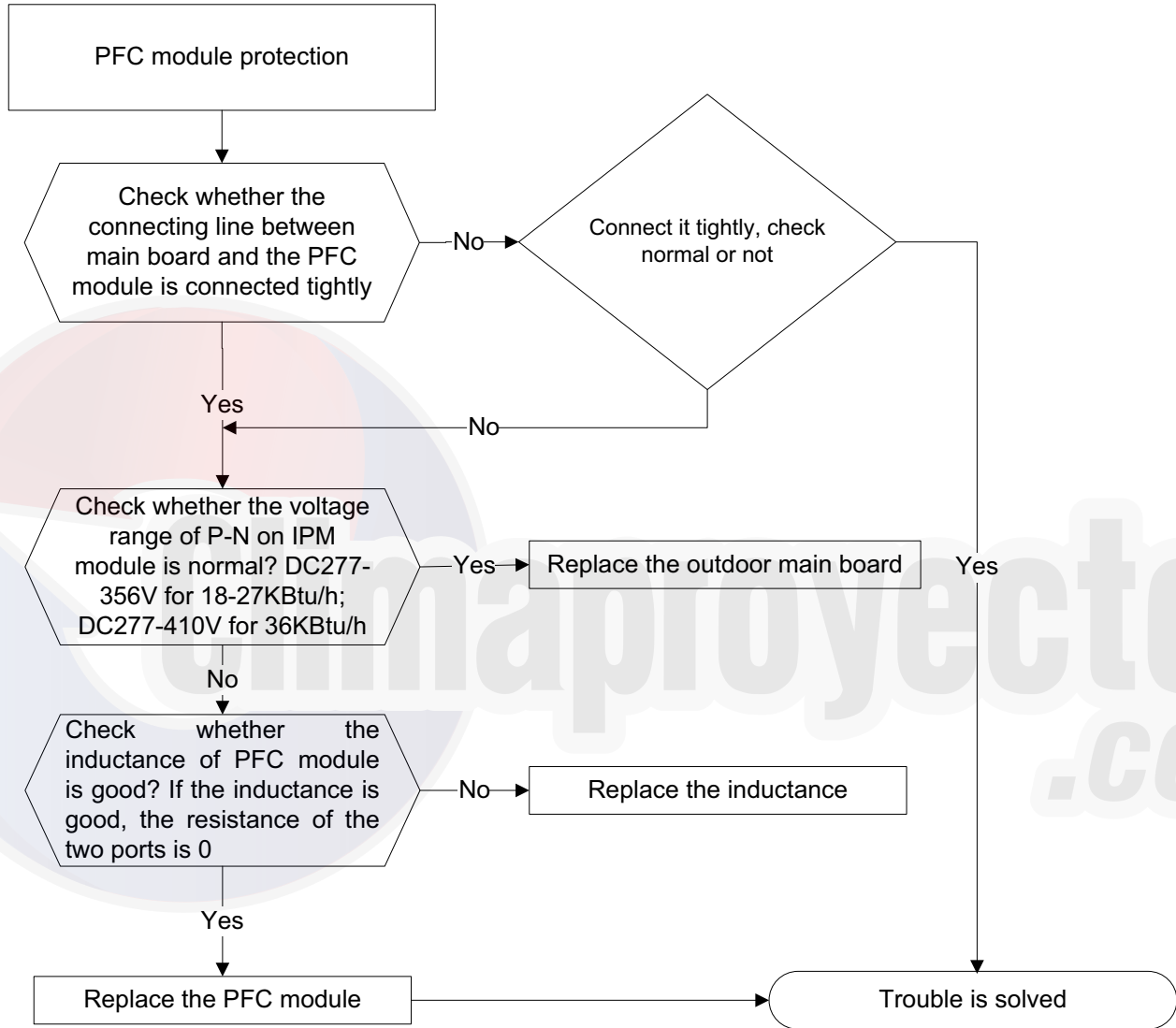



Inductance

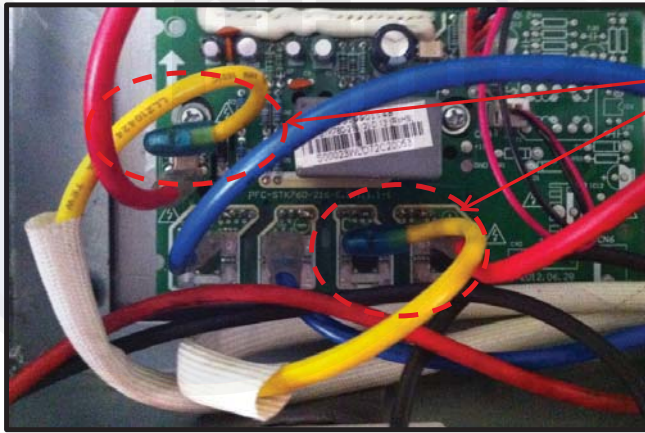

Two ports of the inductance



E8(Outdoor fan speed has been out of control) diagnosis and solution

Error Code	E8
Malfunction decision conditions	When outdoor fan speed keeps too low (300RPM) or too high(2400RPM) for certain time, the unit stops and the LED displays the failure.
Supposed causes	<ul style="list-style-type: none"> • Wiring mistake • Fan ass'y faulty • Fan motor faulty • PCB faulty

Troubleshooting

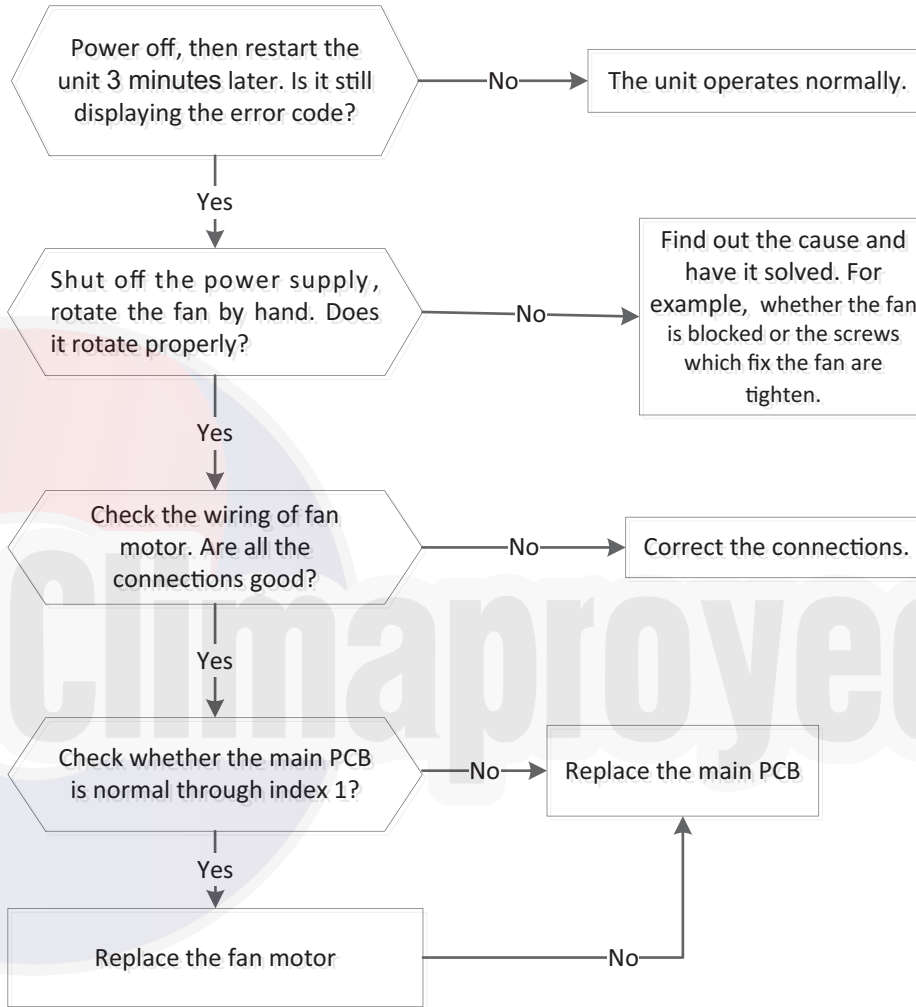

Index 1:

DC fan motor (control chip is inside fan motor)

Power on and when the unit is in standby, measure the voltage of pin1-pin3, pin4-pin3 in fan motor connector. If the value of the voltage is not in the range showing in below table, the PCB must have problems and need to be replaced.

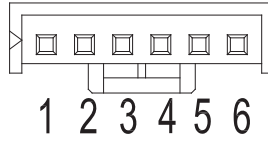
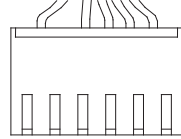

DC motor voltage input and output

NO.	Color	Signal	Voltage
1	Red	Vs/Vm	200~380V
2	---	---	---
3	Black	GND	0V
4	White	Vcc	13.5~16.5V
5	Yellow	Vsp	0~6.5V
6	Blue	FG	13.5~16.5V

Vs



Vcc

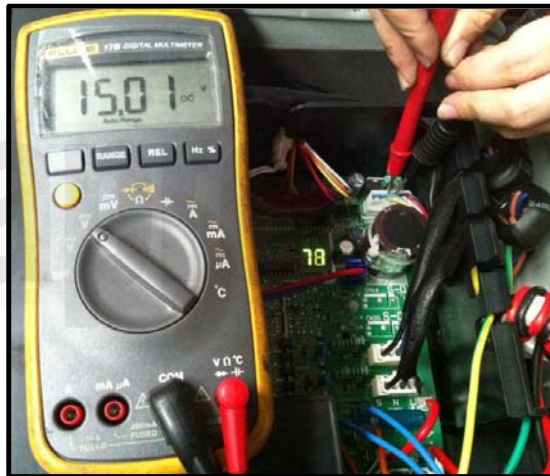

Vsp

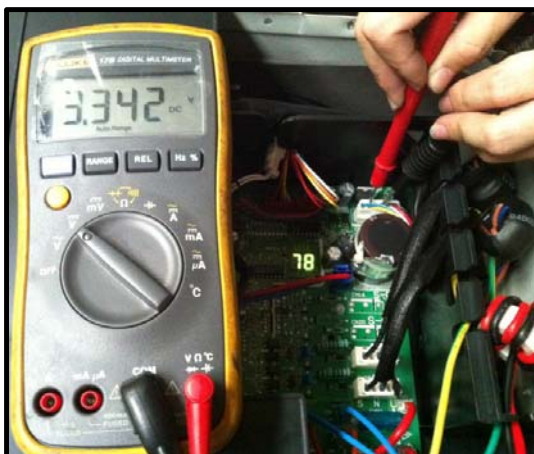

FG

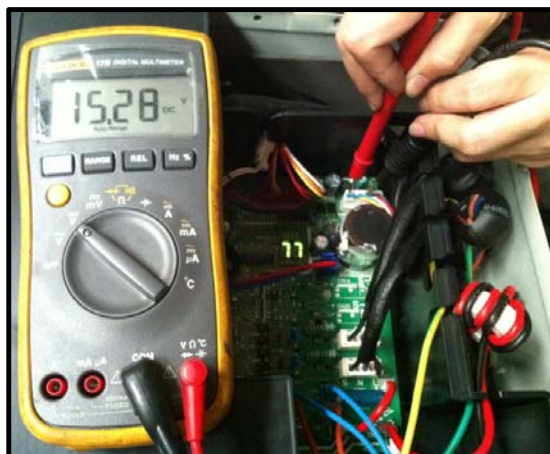

P0(Temperature protection of compressor top) error diagnosis and solution.

Error Code	P0
Malfunction decision conditions	If the sampling voltage is not 5V, the LED displays the failure.
Supposed causes	<ul style="list-style-type: none"> • Wiring mistake • Over load protector faulty • System block • Outdoor PCB faulty

Troubleshooting

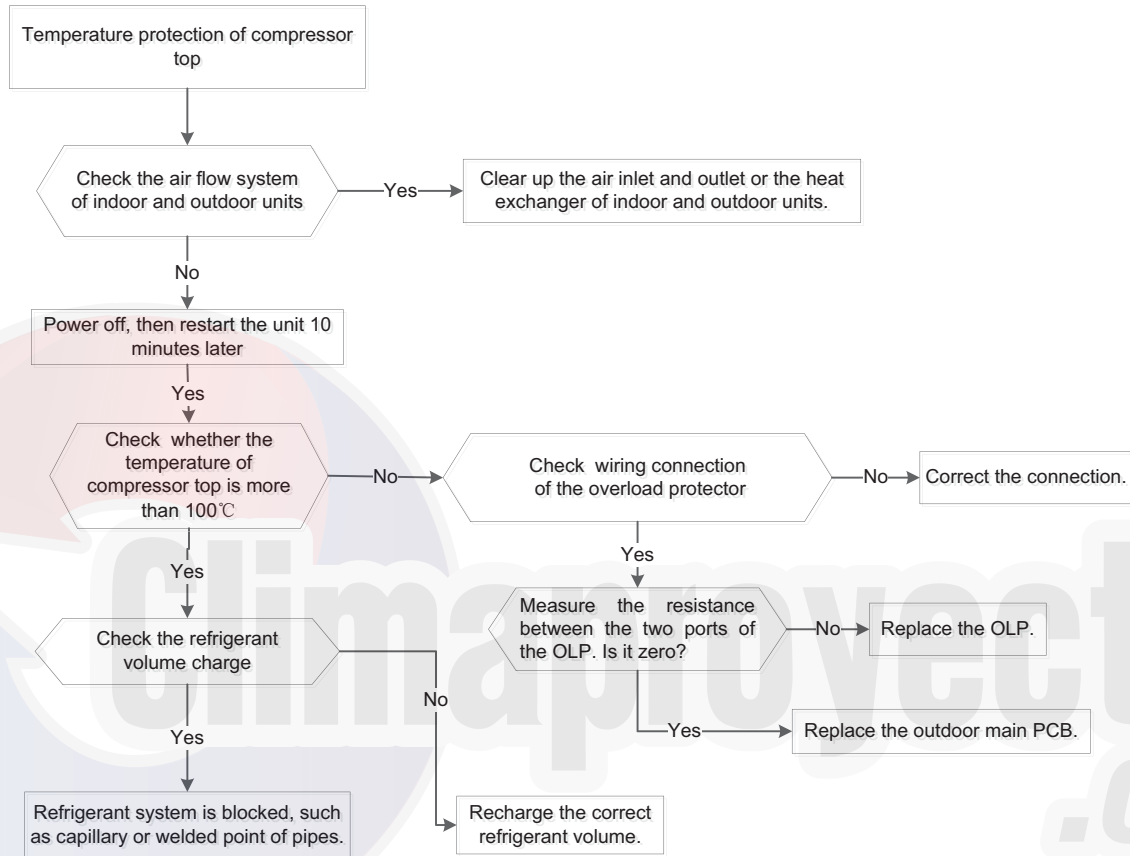

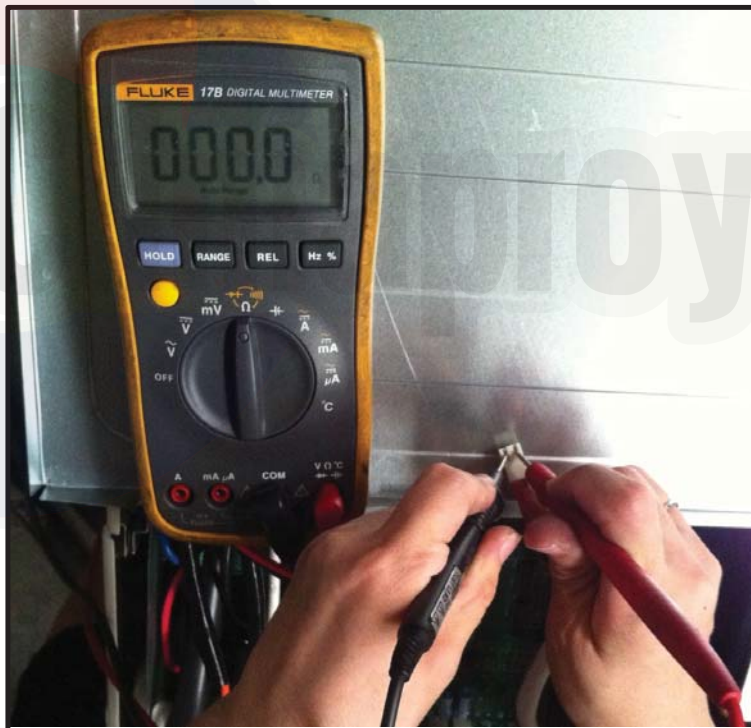
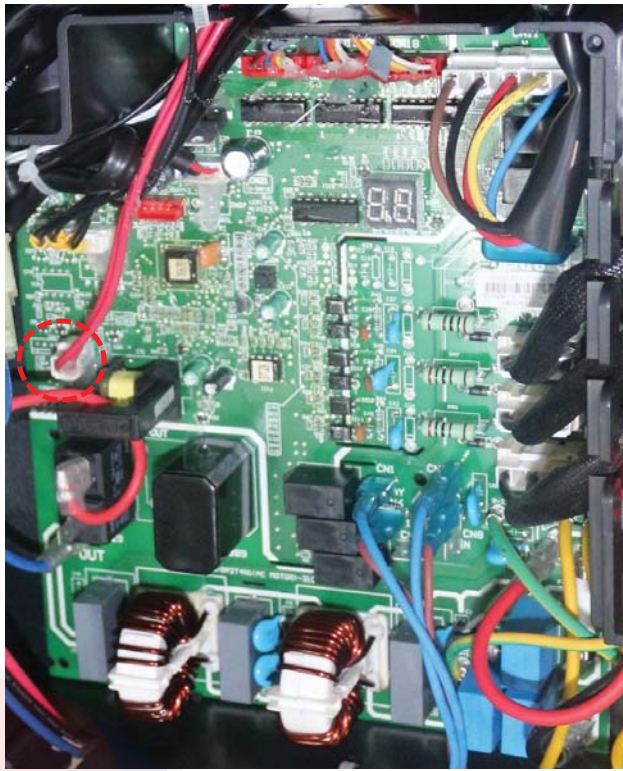

P1(High pressure protection) error diagnosis and solution.

Error Code	P1
Malfunction decision conditions	If the sampling voltage is not 5V, the LED displays the failure.
Supposed causes	<ul style="list-style-type: none"> • Wiring mistake • Over load protector faulty • System block • Outdoor PCB faulty

Troubleshooting

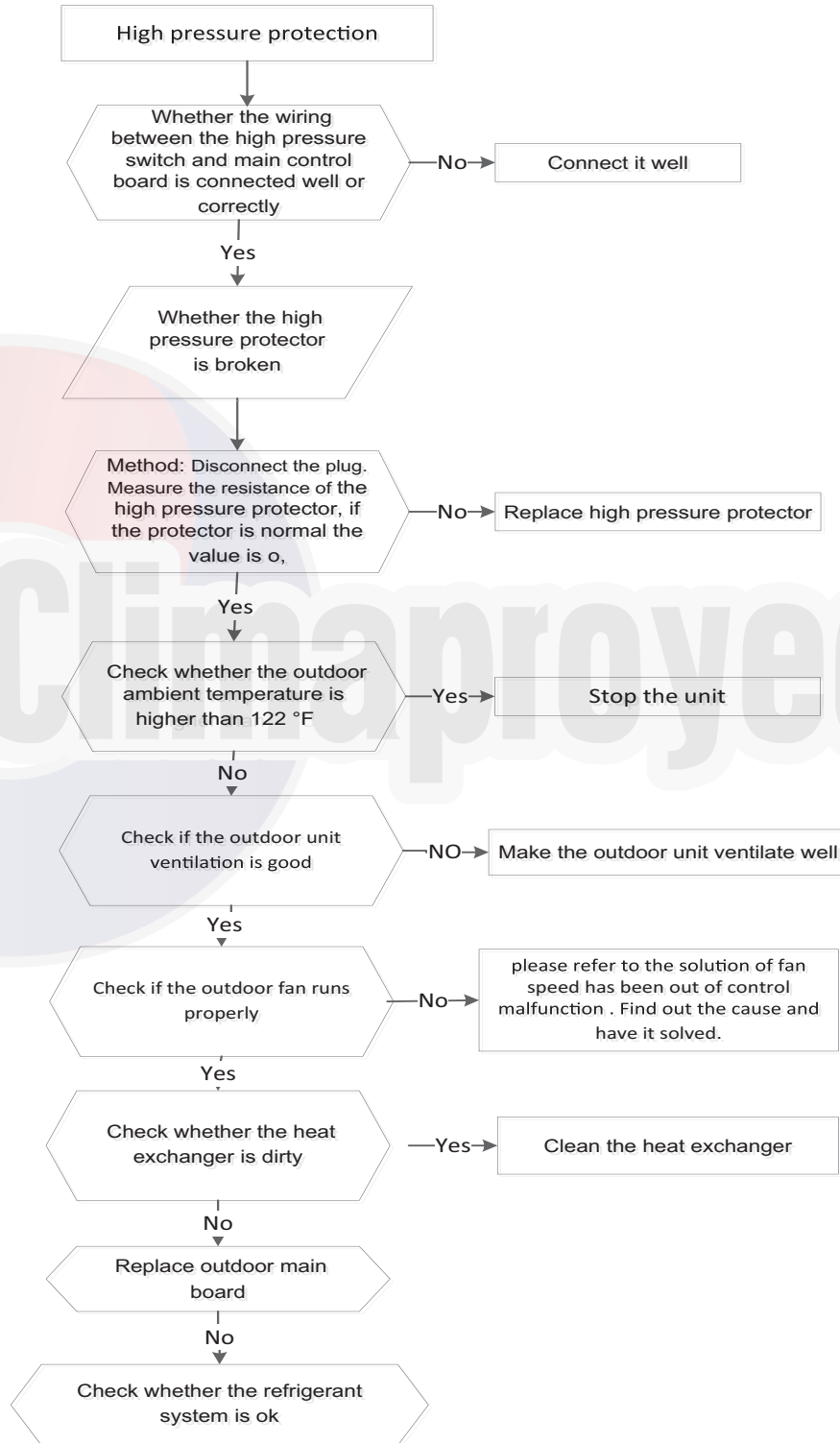

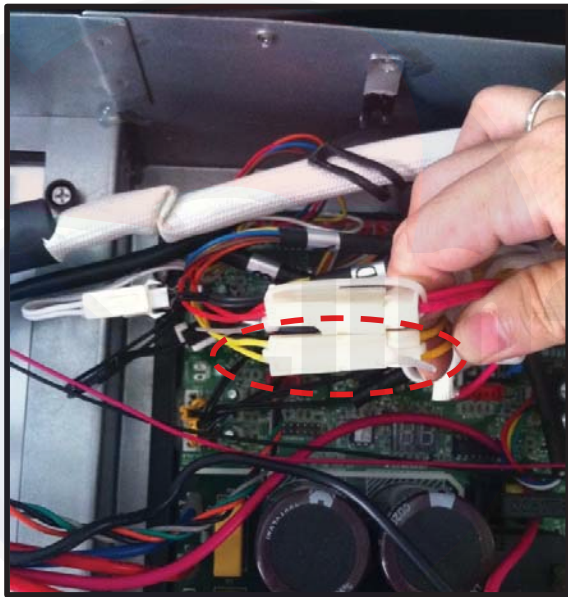
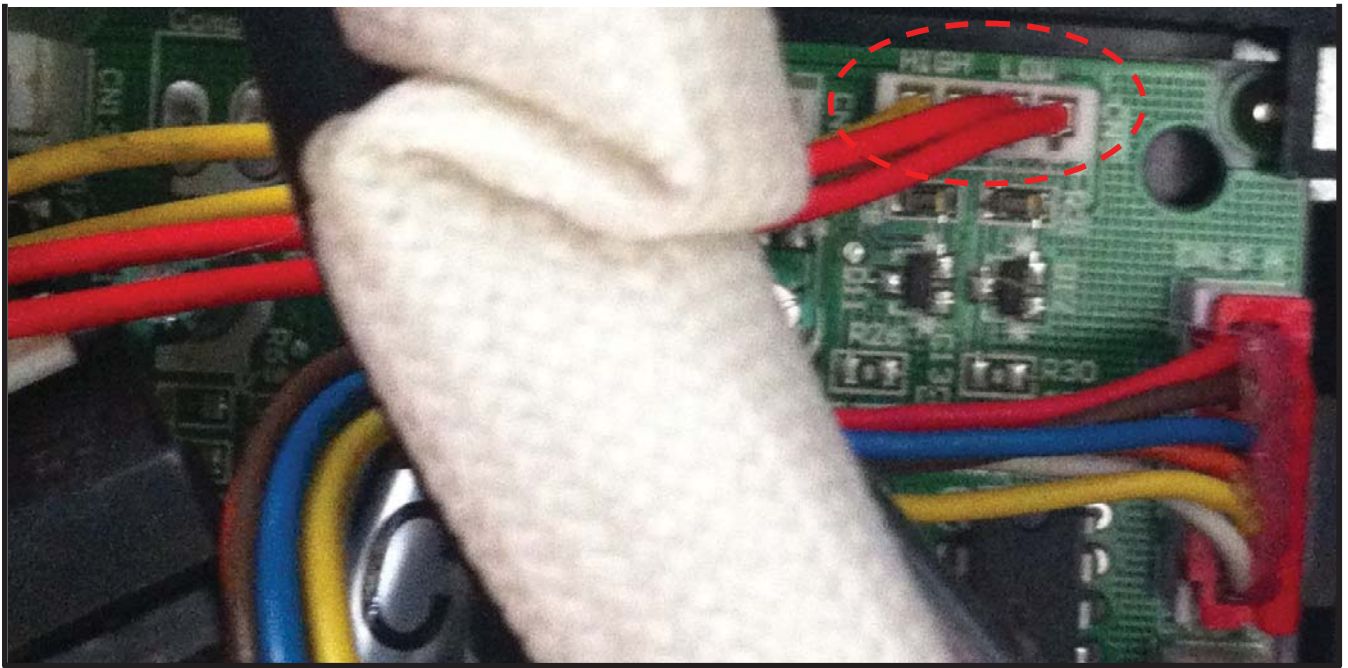

P2 (Low pressure protection) error diagnosis and solution

Error Code	P2
Malfunction decision conditions	If the sampling voltage is not 5V, the LED displays the failure.
Supposed causes	<ul style="list-style-type: none"> • Wiring mistake • Over load protector faulty • System block • Outdoor PCB faulty

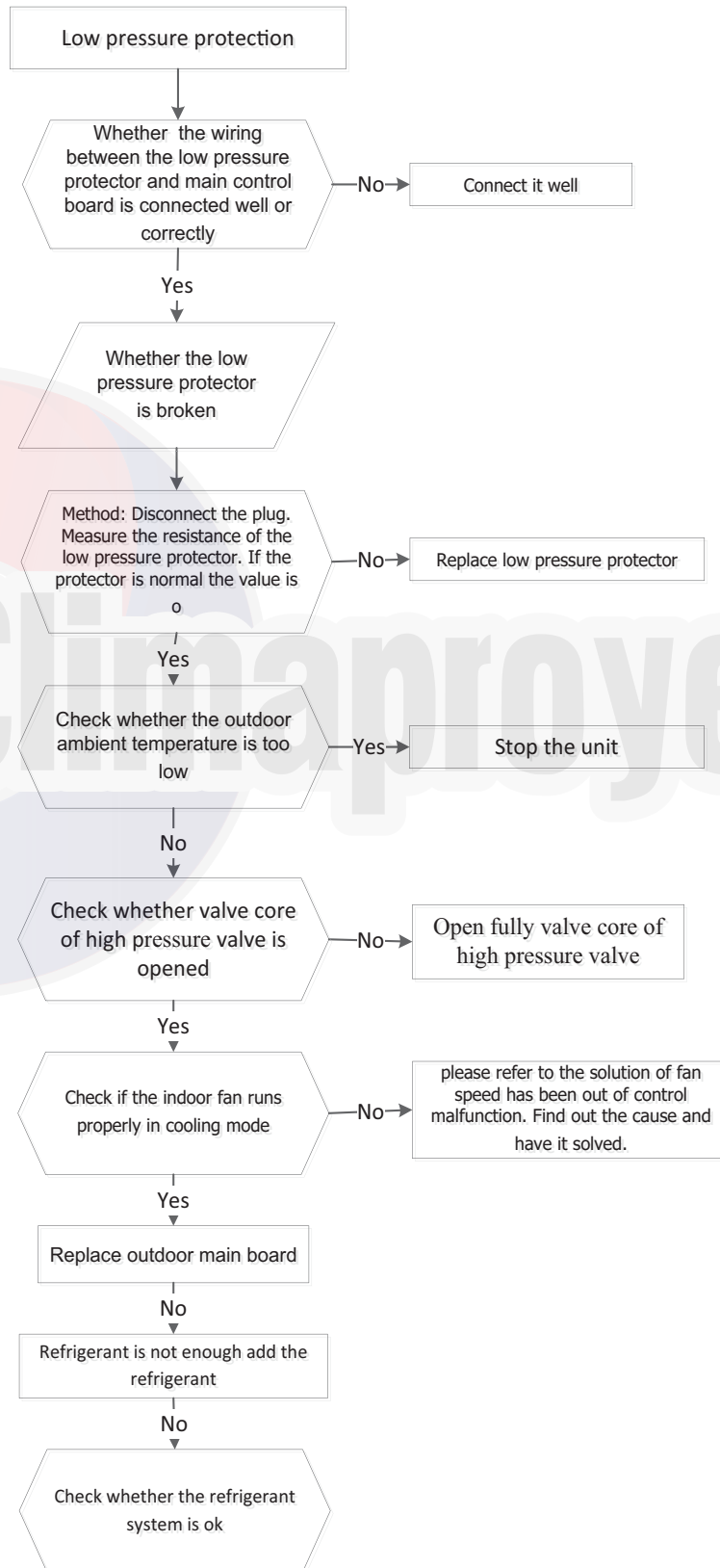

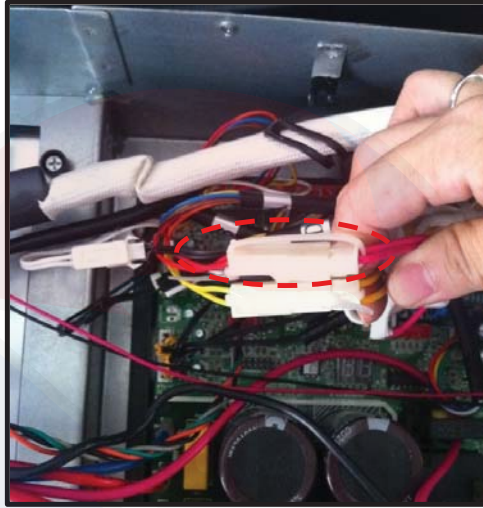
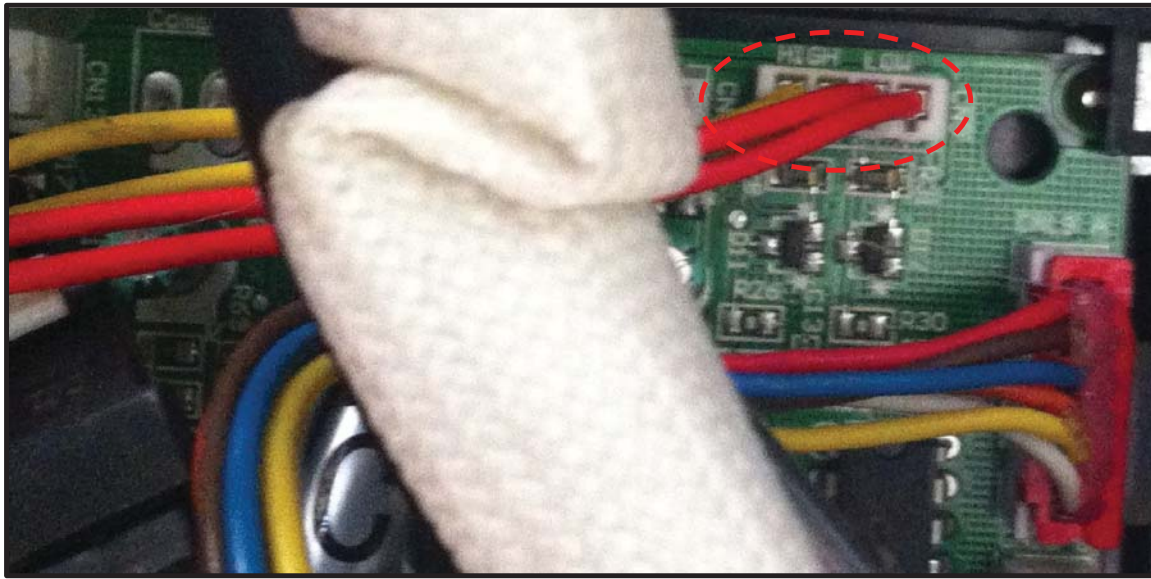

tos
.com

P3 (Current protection of compressor) error diagnosis and solution.

Error Code	P3
Malfunction decision conditions	If the outdoor current exceeds the current limit value, the LED displays the failure.
Supposed causes	<ul style="list-style-type: none"> • Wiring mistake • Over load protector faulty • System block • Outdoor PCB faulty

Troubleshooting

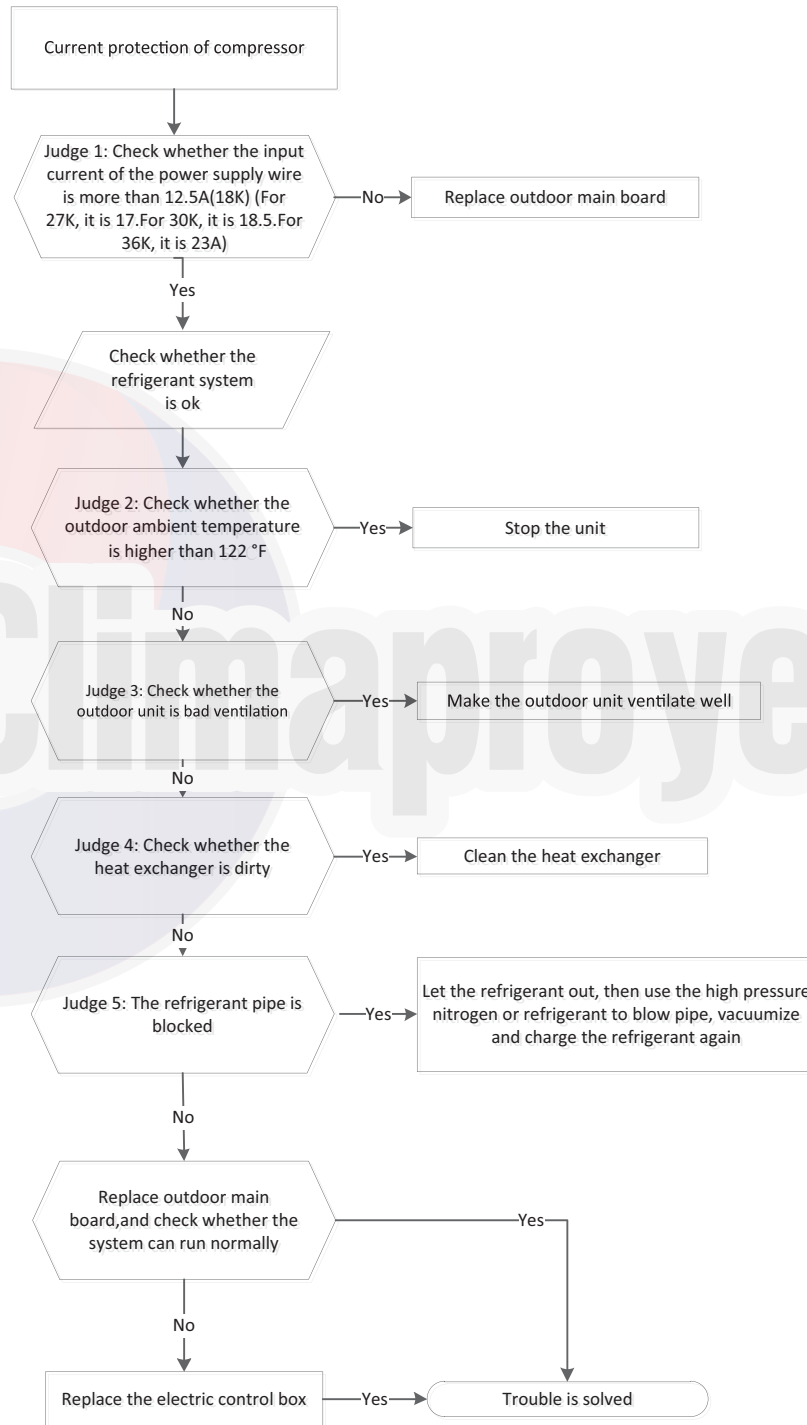



P4(Temperature protection of compressor discharge) error diagnosis and solution.

Error Code	P4
Malfunction decision conditions	When the compressor discharge temperature(T5) is more than 239°F for 10 seconds, the compressor stops and restarts when T5 is less than 194°F.
Supposed causes	<ul style="list-style-type: none"> • Refrigerant leakage • Wiring mistake • The discharge temperature sensor faulty • Outdoor PCB faulty

Troubleshooting

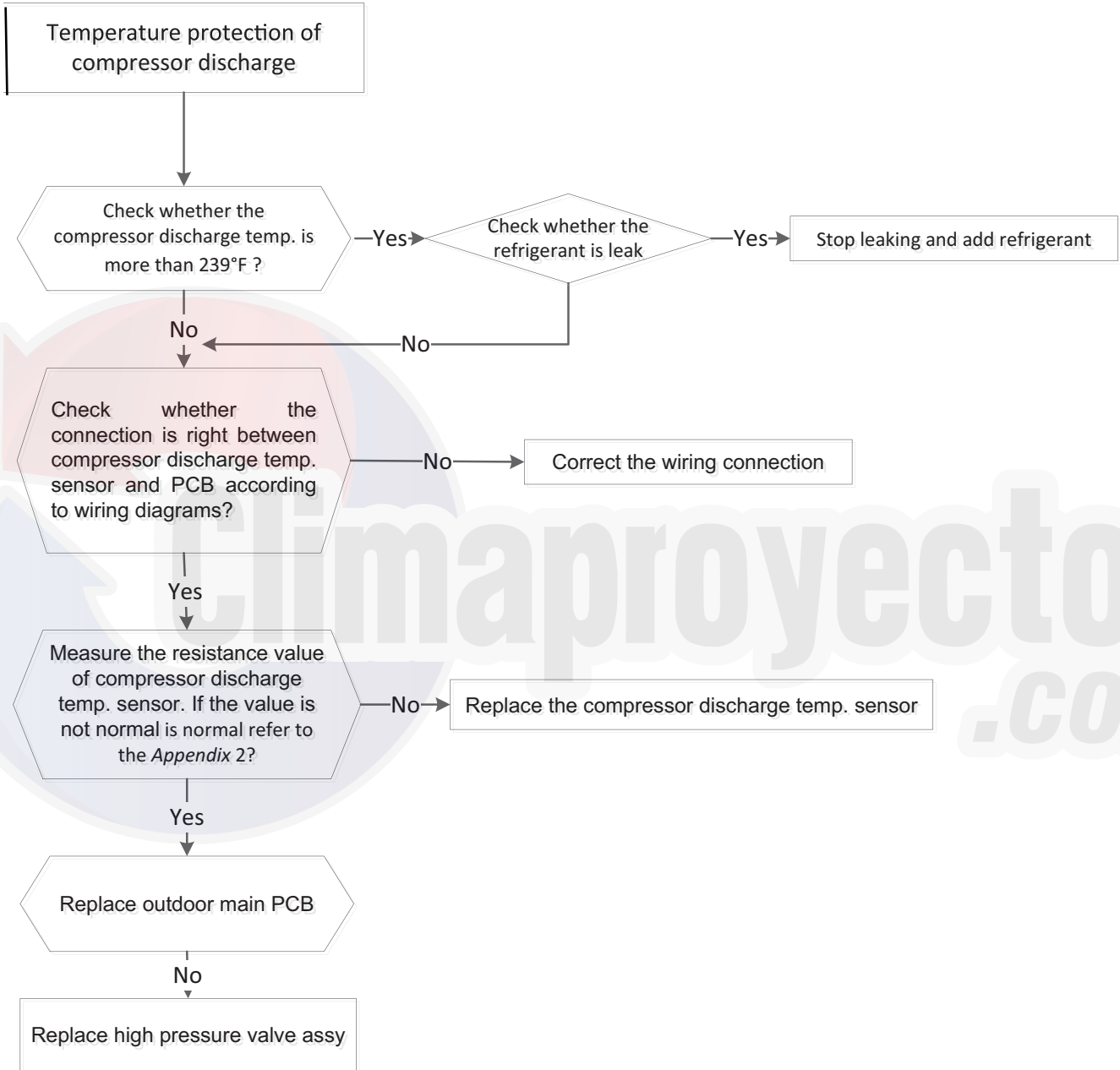

P5 (High temperature protection of condenser) error diagnosis and solution

Error Code	P5
Malfunction decision conditions	When outdoor pipe temperature is more than 149°F, the unit stops, and unit runs again when the outdoor pipe temperature is less than 125°F.
Supposed causes	<ul style="list-style-type: none"> • The condenser temperature sensor faulty • Heat exchanger dirty • System block

Troubleshooting

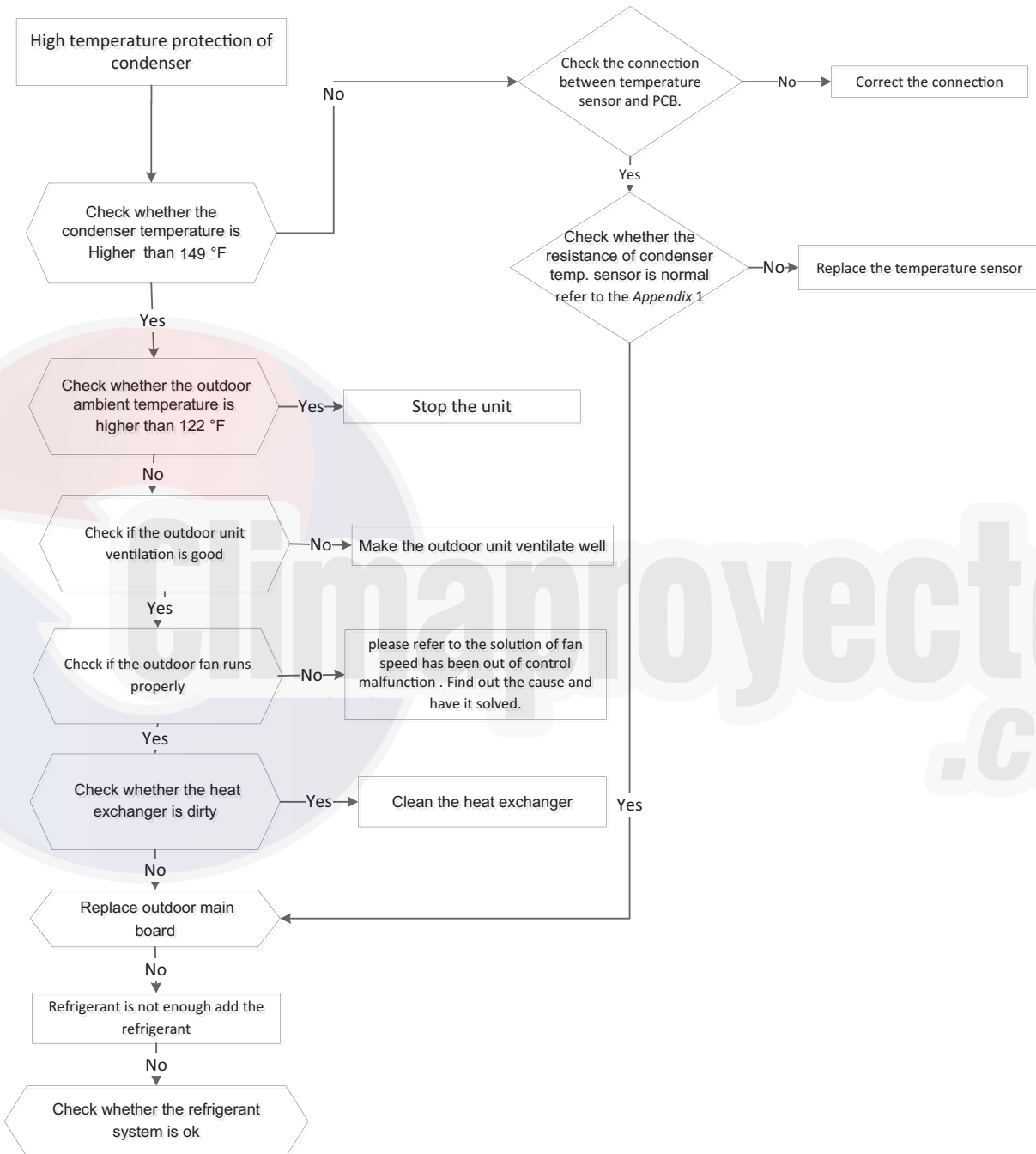

P6 (IPM module protection) error diagnosis and solution

Error Code	P6
Malfunction decision conditions	When the voltage signal that IPM send to compressor drive chip is abnormal, the display LED shows "P6" and the AC turns off.
Supposed causes	<ul style="list-style-type: none"> • Wiring mistake • IPM malfunction • Outdoor fan ass'y faulty • Compressor malfunction • Outdoor PCB faulty

Troubleshooting

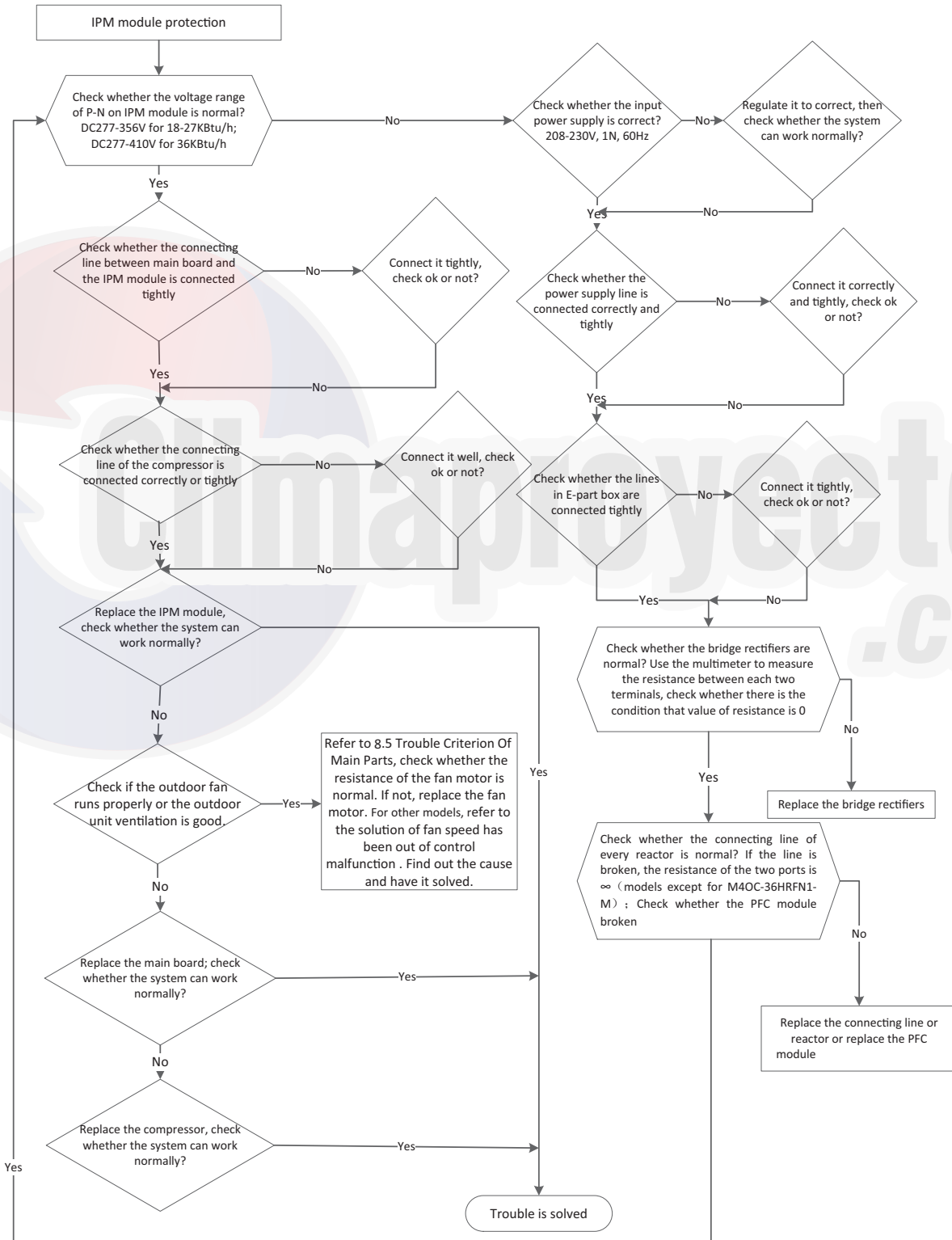

The cooling operation or heating operation does not operate.

Supposed causes

- 4-way valve faulty

Check the 4-way valve. Refer to part 5 in 9.5.

When cooling, heat exchanger of non-operating indoor unit frosts.

When heating, non-operating indoor unit gets warm.

Supposed causes:

- EXV faulty
- Wire and tubing connected in reverse

Check the EXV. Refer to part 6 in 9.5 *Trouble Criterion Of Main Parts.*

IMPORTANT: If you replace outdoor main PCB, you need to check whether the PCB is produced before Apr. 2013. If yes, you need to short connect OLP connector. Otherwise, the outdoor LED displays “P0”.

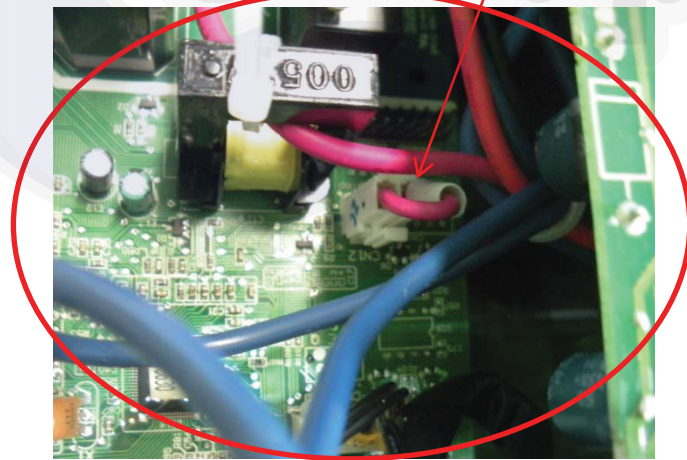
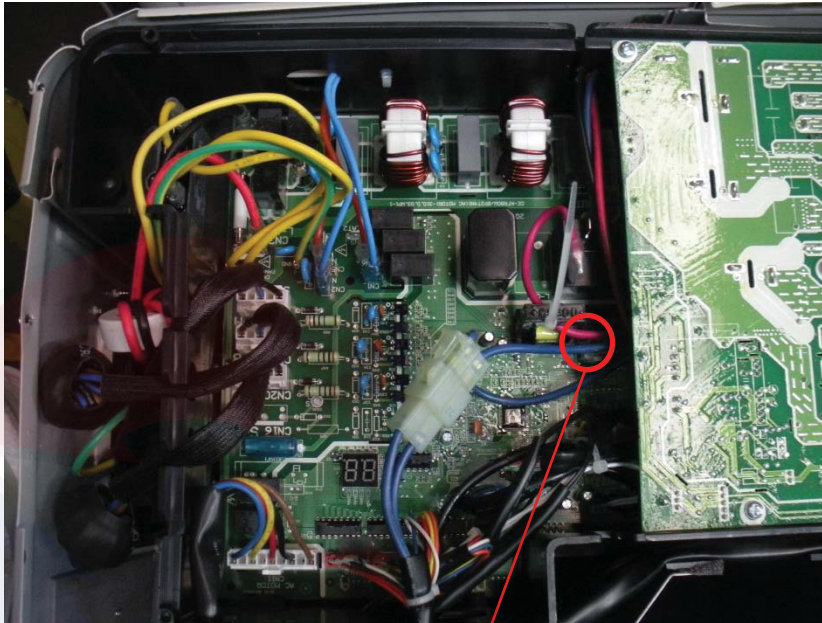

Temperature sensor checking

Disconnect the temperature sensor from PCB, measure the resistance value with a tester.

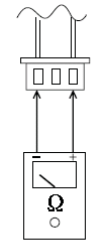

Tester

Temperature Sensors

Room temp.(T1) sensor,

Indoor coil temp.(T2) sensor,

Outdoor coil temp.(T3) sensor,

Outdoor ambient temp.(T4) sensor,

Compressor discharge temp.(T5) sensor.

Measure the resistance value of each winding by using the multi-meter.



APPENDIX 1 TEMPERATURE SENSOR RESISTANCE VALUE TABLE (°C-K)

°C	K Ohm	°C	K Ohm	°C	K Ohm	°C	K Ohm
-20	115.266	20	12.6431	60	2.35774	100	0.62973
-19	108.146	21	12.0561	61	2.27249	101	0.61148
-18	101.517	22	11.5000	62	2.19073	102	0.59386
-17	96.3423	23	10.9731	63	2.11241	103	0.57683
-16	89.5865	24	10.4736	64	2.03732	104	0.56038
-15	84.2190	25	10.000	65	1.96532	105	0.54448
-14	79.3110	26	9.55074	66	1.89627	106	0.52912
-13	74.5360	27	9.12445	67	1.83003	107	0.51426
-12	70.1698	28	8.71983	68	1.76647	108	0.49989
-11	66.0898	29	8.33566	69	1.70547	109	0.48600
-10	62.2756	30	7.97078	70	1.64691	110	0.47256
-9	58.7079	31	7.62411	71	1.59068	111	0.45957
-8	56.3694	32	7.29464	72	1.53668	112	0.44699
-7	52.2438	33	6.98142	73	1.48481	113	0.43482
-6	49.3161	34	6.68355	74	1.43498	114	0.42304
-5	46.5725	35	6.40021	75	1.38703	115	0.41164
-4	44.0000	36	6.13059	76	1.34105	116	0.40060
-3	41.5878	37	5.87359	77	1.29078	117	0.38991
-2	39.8239	38	5.62961	78	1.25423	118	0.37956
-1	37.1988	39	5.39689	79	1.21330	119	0.36954
0	35.2024	40	5.17519	80	1.17393	120	0.35982
1	33.3269	41	4.96392	81	1.13604	121	0.35042
2	31.5635	42	4.76253	82	1.09958	122	0.3413
3	29.9058	43	4.57050	83	1.06448	123	0.33246
4	28.3459	44	4.38736	84	1.03069	124	0.32390
5	26.8778	45	4.21263	85	0.99815	125	0.31559
6	25.4954	46	4.04589	86	0.96681	126	0.30754
7	24.1932	47	3.88673	87	0.93662	127	0.29974
8	22.5662	48	3.73476	88	0.90753	128	0.29216
9	21.8094	49	3.58962	89	0.87950	129	0.28482
10	20.7184	50	3.45097	90	0.85248	130	0.27770
11	19.6891	51	3.31847	91	0.82643	131	0.27078
12	18.7177	52	3.19183	92	0.80132	132	0.26408
13	17.8005	53	3.07075	93	0.77709	133	0.25757
14	16.9341	54	2.95896	94	0.75373	134	0.25125
15	16.1156	55	2.84421	95	0.73119	135	0.24512
16	15.3418	56	2.73823	96	0.70944	136	0.23916
17	14.6181	57	2.63682	97	0.68844	137	0.23338
18	13.9180	58	2.53973	98	0.66818	138	0.22776
19	13.2631	59	2.44677	99	0.64862	139	0.22231

APPENDIX 2

Unit: °C-K - Discharge Temperature Sensor Table							
-20	542.7	20	68.66	60	13.59	100	3.702
-19	511.9	21	65.62	61	13.11	101	3.595
-18	483	22	62.73	62	12.65	102	3.492
-17	455.9	23	59.98	63	12.21	103	3.392
-16	430.5	24	57.37	64	11.79	104	3.296
-15	406.7	25	54.89	65	11.38	105	3.203
-14	384.3	26	52.53	66	10.99	106	3.113
-13	363.3	27	50.28	67	10.61	107	3.025
-12	343.6	28	48.14	68	10.25	108	2.941
-11	325.1	29	46.11	69	9.902	109	2.86
-10	307.7	30	44.17	70	9.569	110	2.781
-9	291.3	31	42.33	71	9.248	111	2.704
-8	275.9	32	40.57	72	8.94	112	2.63
-7	261.4	33	38.89	73	8.643	113	2.559
-6	247.8	34	37.3	74	8.358	114	2.489
-5	234.9	35	35.78	75	8.084	115	2.422
-4	222.8	36	34.32	76	7.82	116	2.357
-3	211.4	37	32.94	77	7.566	117	2.294
-2	200.7	38	31.62	78	7.321	118	2.233
-1	190.5	39	30.36	79	7.086	119	2.174
0	180.9	40	29.15	80	6.859	120	2.117
1	171.9	41	28	81	6.641	121	2.061
2	163.3	42	26.9	82	6.43	122	2.007
3	155.2	43	25.86	83	6.228	123	1.955
4	147.6	44	24.85	84	6.033	124	1.905
5	140.4	45	23.89	85	5.844	125	1.856
6	133.5	46	22.89	86	5.663	126	1.808
7	127.1	47	22.1	87	5.488	127	1.762
8	121	48	21.26	88	5.32	128	1.717
9	115.2	49	20.46	89	5.157	129	1.674
10	109.8	50	19.69	90	5	130	1.632
11	104.6	51	18.96	91	4.849		
12	99.69	52	18.26	92	4.703		
13	95.05	53	17.58	93	4.562		
14	90.66	54	16.94	94	4.426		
15	86.49	55	16.32	95	4.294	B(25/50)=3950K	
16	82.54	56	15.73	96	4.167	R(90°C)=5KΩ±3%	
17	78.79	57	15.16	97	4.045		
18	75.24	58	14.62	98	3.927		
19	71.86	59	14.09	99	3.812		

APPENDIX 3

°C	10	11	12	13	14	15	16	17	18	19	20	21	22
°F	48	50	52	54	56	58	60	62	64	66	68	70	72
°C	23	24	25	26	27	28	29	30	31	32	33	34	35
°F	74	76	78	80	82	84	86	88	90	92	94	96	98

Compressor Check

Measure the resistance value of each winding by using the tester.

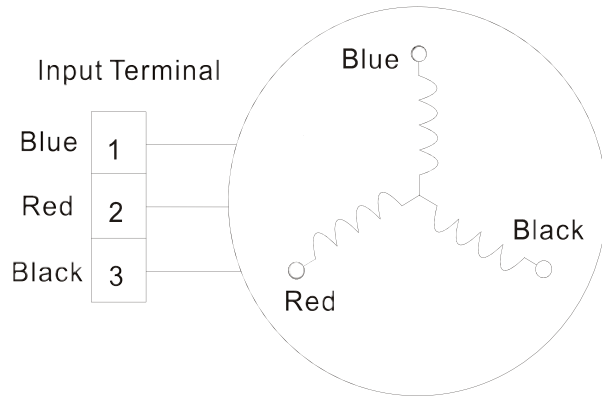

Position	Resistance Value			
Blue - Red	0.95Ω (20°C/68°F)	0.55Ω (20°C/68°F)	0.53Ω (20°C/68°F)	0.44Ω (20°C/68°F)



IPM continuity check

Turn off the power, let the large capacity electrolytic capacitors discharge completely, and dismount the IPM. Use a digital tester to measure the resistance between P and UVWN; UVW and N.

Digital tester		Normal resistance value	Digital tester		Normal resistance value
(+)Red	(-)Black	∞ (Several M Ω)	(+)Red	(-)Black	∞ (Several M Ω)
P	N		N	U	
	U			V	
	V			W	
	W			(+)Red	

AC Fan Motor

Measure the resistance value of each winding by using the tester.

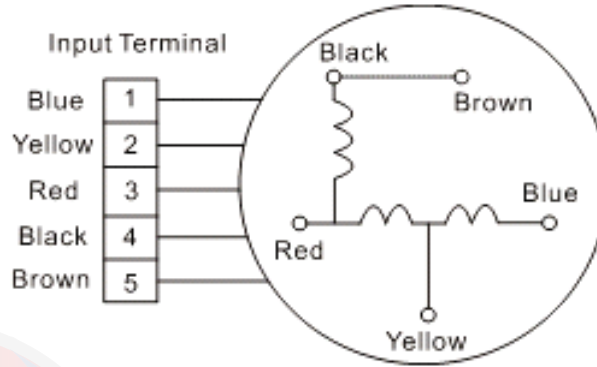

Position	Resistance Value			
	RPG20B		RPG28H	
Black - Red	381 Ω ±8% (68 °F)	342 Ω ±8% (68 °F)	183.6 Ω ±8% (68 °F)	180 Ω ±8% (68 °F)
White - Black	267 Ω ±8% (68 °F)	253 Ω ±8% (68 °F)	206 Ω ±8% (68 °F)	190 Ω ±8% (68 °F)

Measure the resistance value of each winding by using the tester.

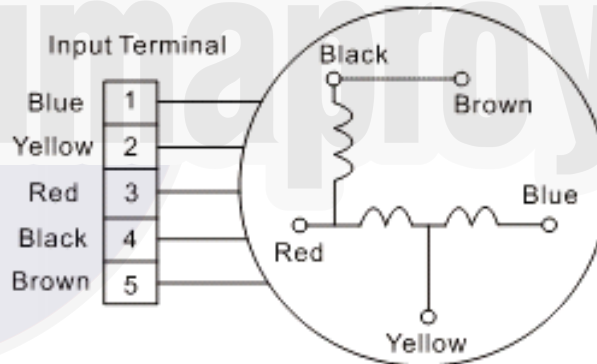

Position	Resistance Value						
	Black-Red (68°F)	56 Ω ±8%	24.5 Ω ±8%	317 Ω ±8%	145 Ω ±8%	345 Ω ±8%	627 Ω ±8%
Red-Yellow (68°F)	76 Ω ±8%	19 Ω ±8%	252 Ω ±8%	88 Ω ±8%	150 Ω ±8%	374.3 Ω ±8%	138 Ω ±8%
Yellow-Blue (68°F)	76 Ω ±8%	19 Ω ±8%	252 Ω ±8%	88 Ω ±8%	150 Ω ±8%	374.3 Ω ±8%	138 Ω ±8%

4-Way Valve

1 Power on, use a digital tester to measure the voltage, when the unit operates in cooling, it is 0V. When the unit operates in heating, it is about 230VAC. If the value of the voltage is not in the range, the PCB must have problems and need to be replaced.

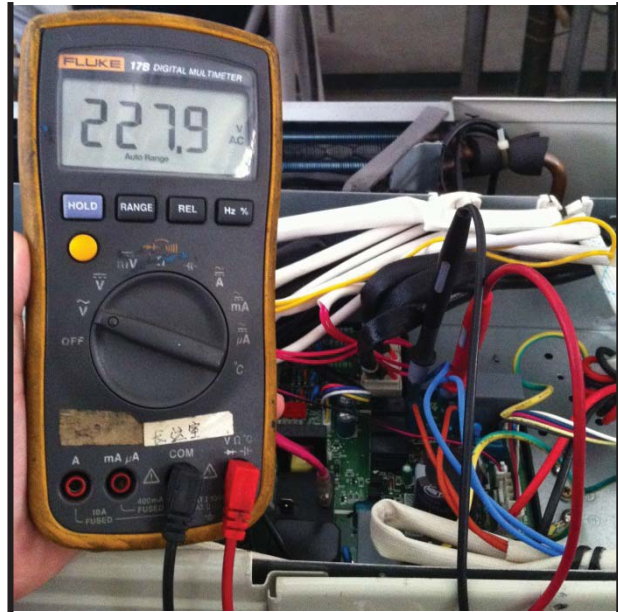

2 Turn off the power, use a digital tester to measure the resistance. The value should be 1.8~2.5 K Ω .

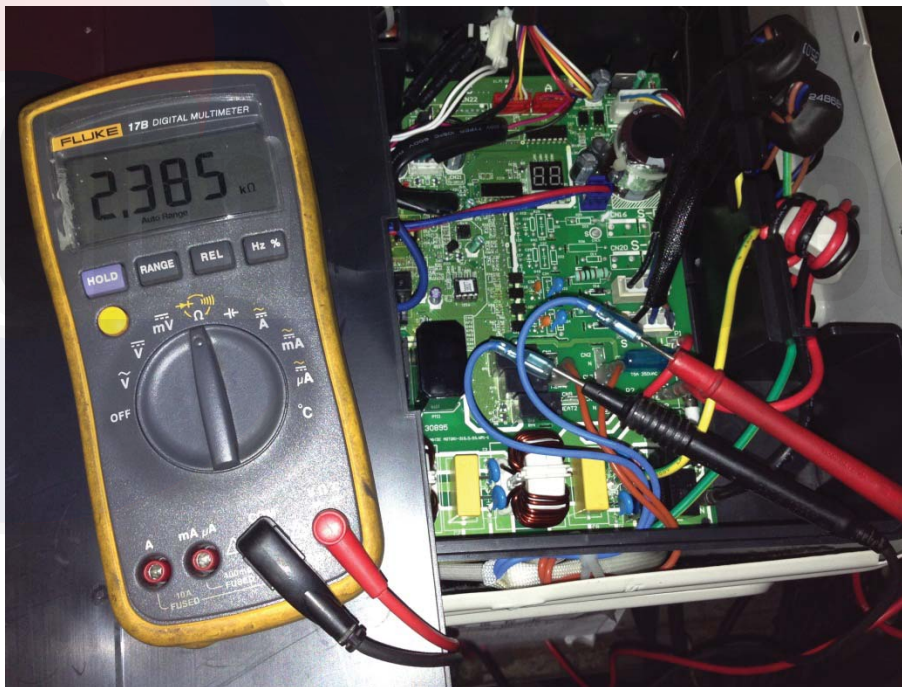

EXV check
 Disconnect the connectors.

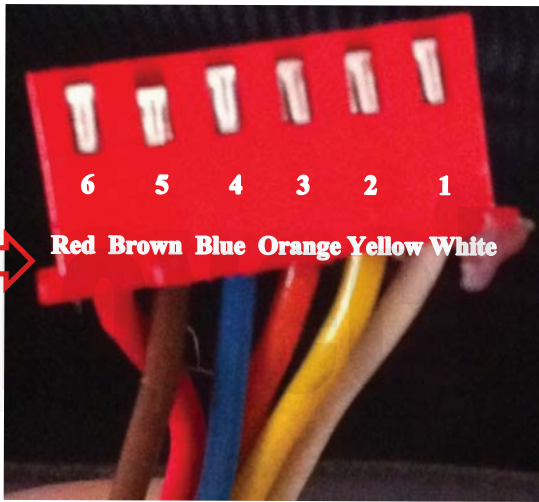
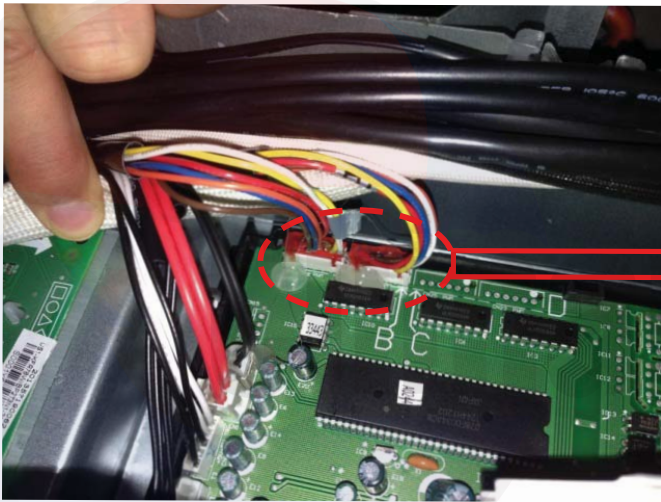
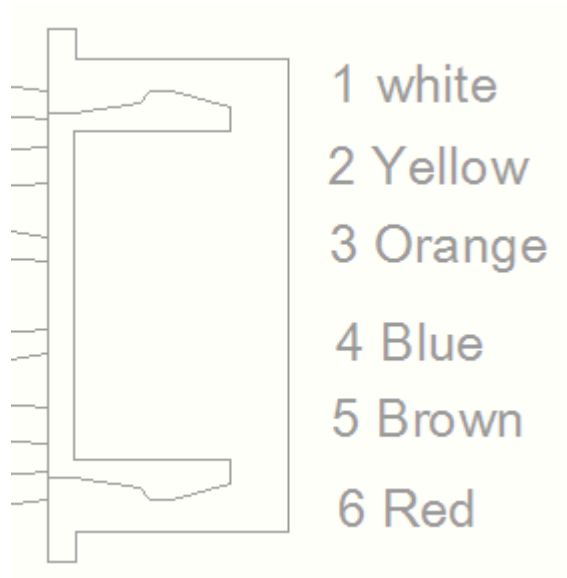

Resistance to EXV coil

Color of lead wire	Normal Value
Red- Blue	About 50Ω
Red - Yellow	
Brown-Orange	
Brown-White	

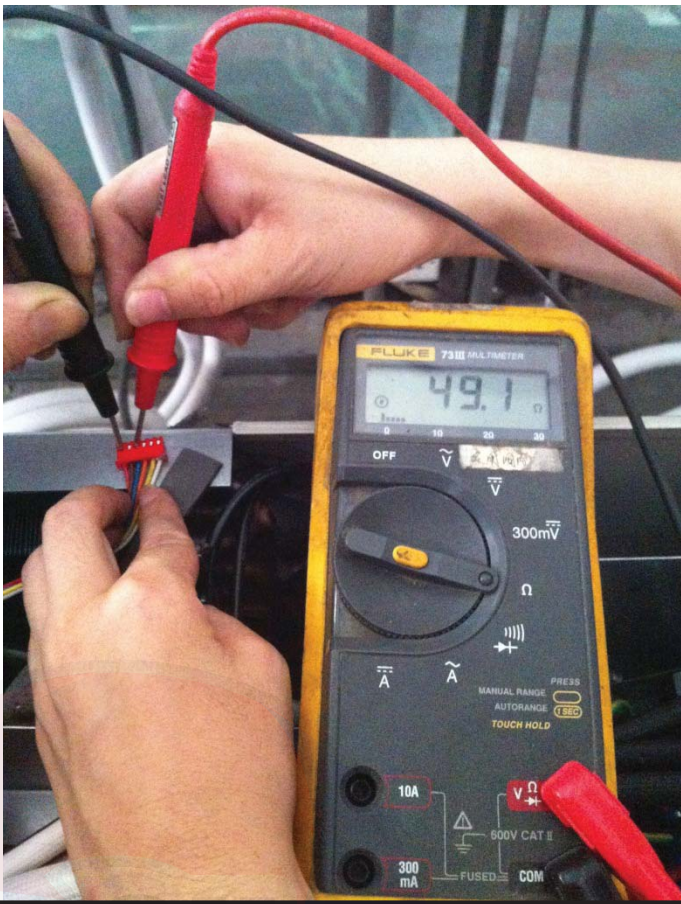

Red- Blue

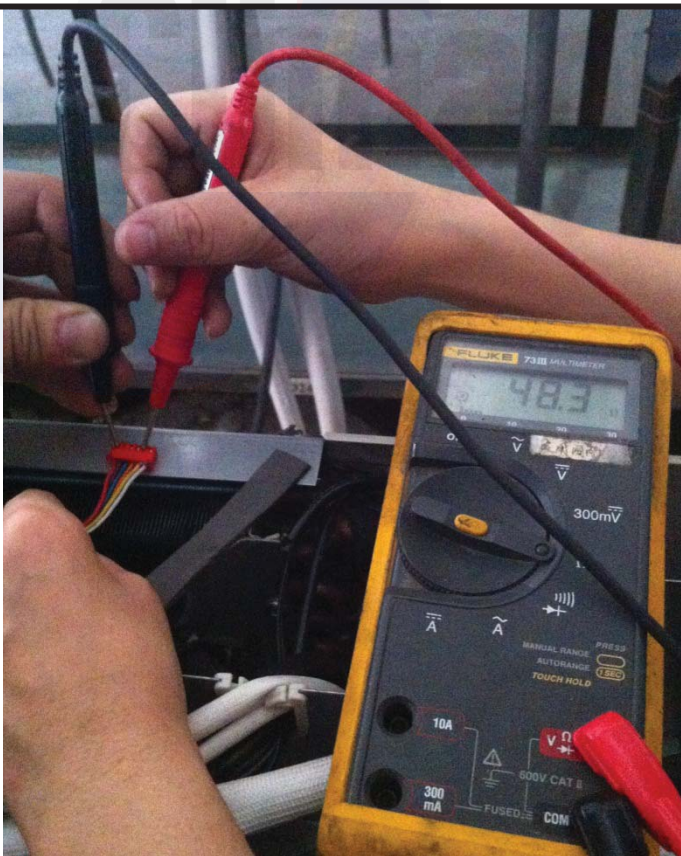

Red - Yellow

oyectos.com

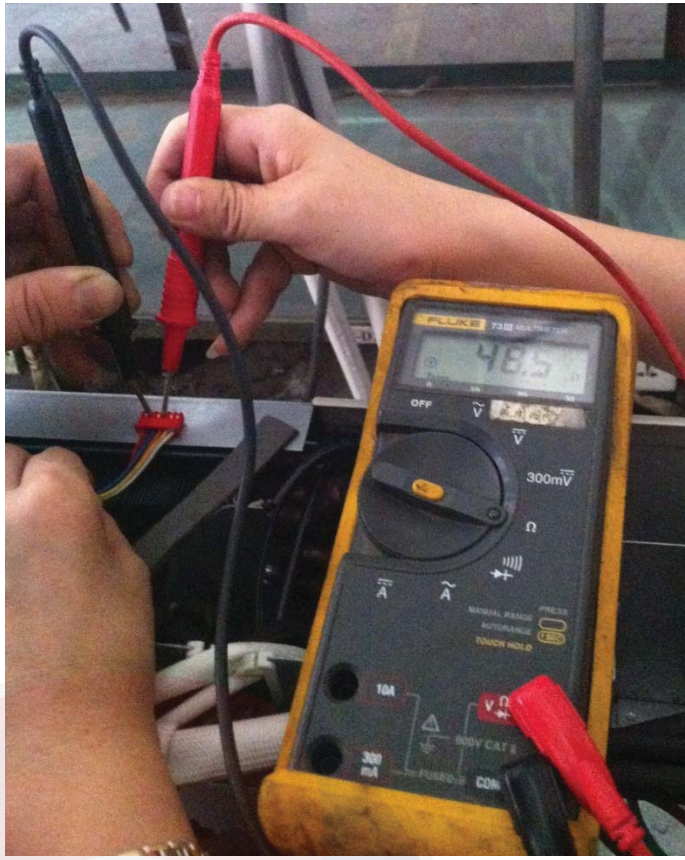

Brown-Orange

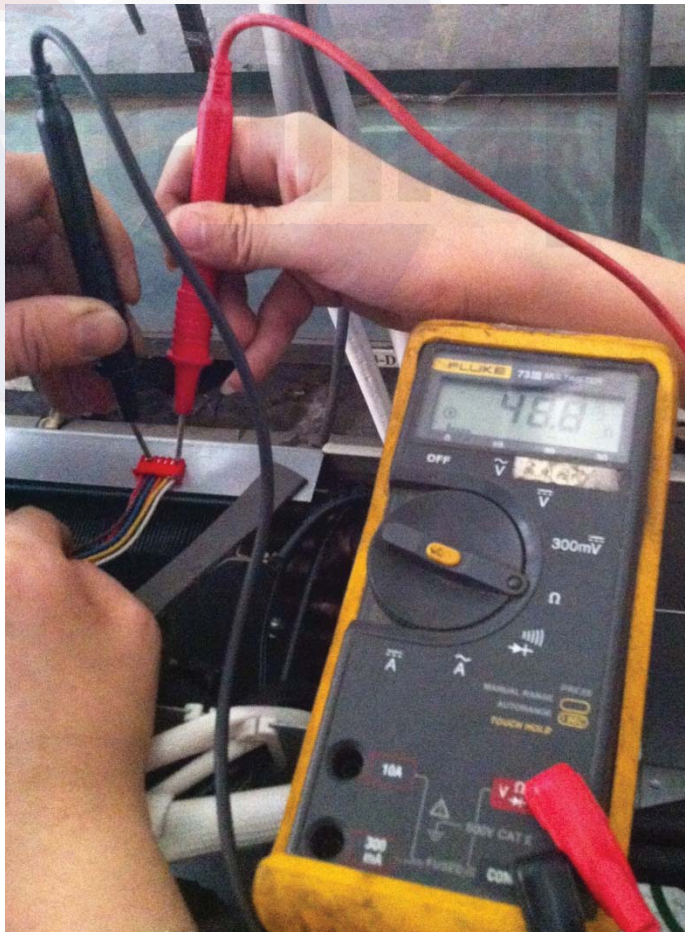

Brown-White

oyectos.com

DISASSEMBLY INSTRUCTIONS

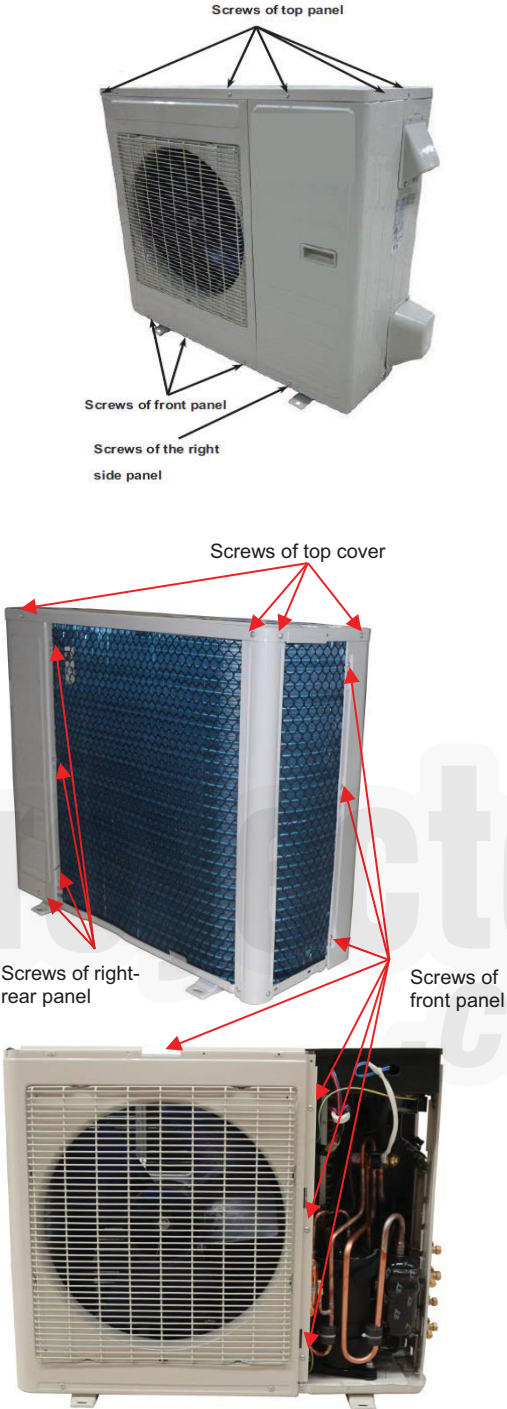
No.	Part name	Procedures	Remarks
1	Panel plate	<p>How to remove the panel plate.</p> <p>1) Stop operation of the air conditioner and turn "OFF" the power breaker.</p> <p>2) Remove the screws of top cover, and remove the top cover. (9 screws)</p> <p>3) Remove the screws of right front side panel, and remove the right front side panel (2 screws)</p> <p>4) Remove the screws of front panel, and remove the front panel. (9 screws)</p>	 <p>The 'Remarks' column contains three photographs illustrating the disassembly process. The top photograph shows the outdoor unit with black arrows pointing to screws on the top panel, front panel, and right side panel. The middle photograph shows the unit with the top cover removed, revealing the blue condenser coils; red arrows point to screws on the top cover, right-rear panel, and front panel. The bottom photograph shows the unit with the front panel removed, exposing the fan and internal components; red arrows point to screws on the front panel.</p>

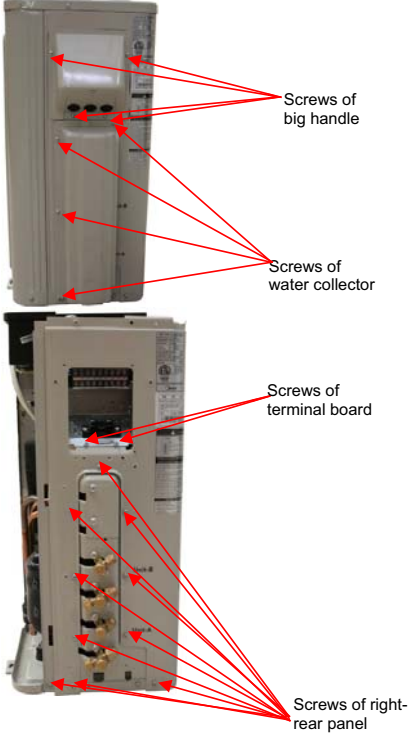
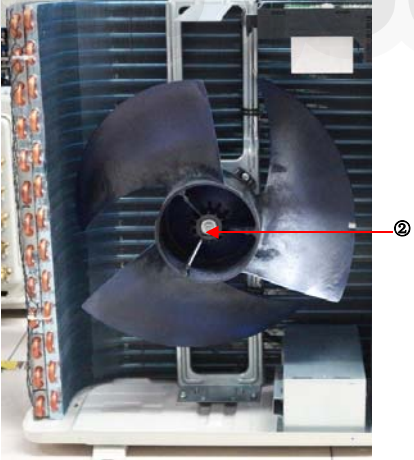
		<p>5) Remove the screws of big handle, and remove the big handle.(4 screws)</p> <p>6) Remove two screws of terminal board, four screws of water collector and fourteen screws of right-rear panel, and remove the right-rear panel.</p>	 <p>Screws of big handle</p> <p>Screws of water collector</p> <p>Screws of terminal board</p> <p>Screws of right-rear panel</p>
2	Fan ass'y	<p>How to remove the fan ass'y.</p> <p>1) Remove the top cover, right front side panel and front panel from item 1.step 1~4</p> <p>2) Remove the hex nut fixing the fan.</p> <p>3) Remove the fan.</p>	 <p>②</p>

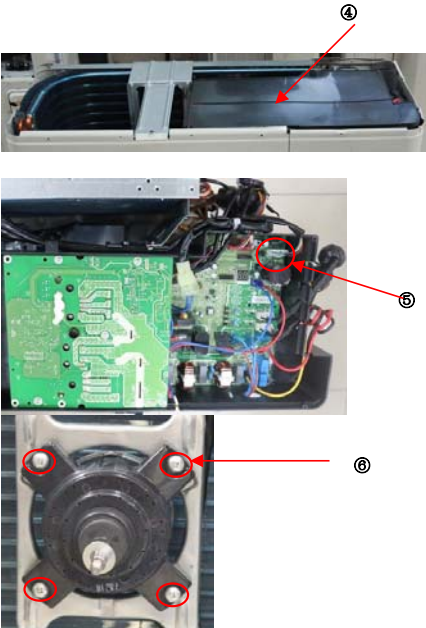
		<p>4) Remove the electrical control box cover.</p> <p>5) Disconnect the fan motor connector CN37(5p,white) from the PCB board.</p> <p>6) Remove the fan motor after unfastening four fixing screws.</p>	
3	Electrical parts	<p>How to remove the electrical parts.</p> <p>1) Perform work of item 1,2.</p> <p>2) Remove the ten screws fixing the IPM board.</p> <p>3) Unfasten the connector of the reactor.</p> <p>4) Unfasten the connector of the compressor.</p> <p>5) Disconnect following 5 pieces of connection wires and connectors between IPM and PCB.</p>	