

**48KC**

**Gas Heat/Electric Cooling**

**Single Packaged Rooftop**

**14 SEER**

**3 to 5 Nominal Tons**



United Technologies  
turn to the experts 

## Product Data



**WeatherMaker®**

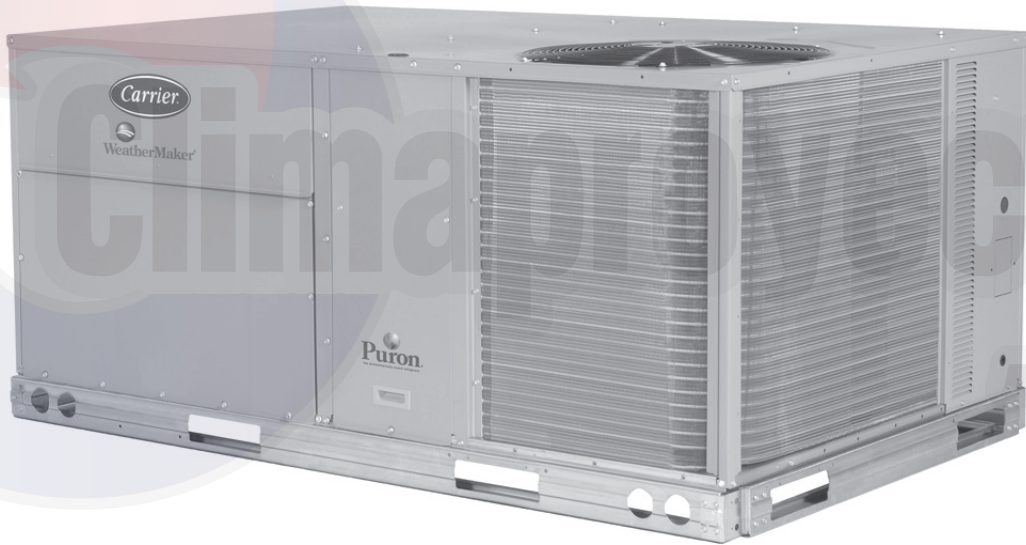

C08613



**ASHRAE  
90.1  
COMPLIANT**

# TABLE OF CONTENTS

	PAGE		PAGE
FEATURES AND BENEFITS .....	3	APPLICATION DATA .....	19
MODEL NUMBER NOMENCLATURE .....	4	COOLING TABLES .....	21
FACTORY OPTIONS AND/OR ACCESSORIES .....	5	STATIC PRESSURE ADDERS .....	27
AHRI COOLING RATING TABLES .....	8	FAN PERFORMANCE .....	29
HEAT RATING TABLE .....	8	ELECTRICAL INFORMATION .....	39
SOUND PERFORMANCE TABLE .....	9	SEQUENCE OF OPERATION .....	42
PHYSICAL DATA .....	11	GUIDE SPECIFICATIONS .....	45
CURBS, WEIGHTS & DIMENSIONS .....	14		

48KC



Turn to the Experts™

The Carrier rooftop unit (RTU) was designed by customers for customers. With “no-strip screw” collars, handled access panels, and more we’ve made your unit easy to install, easy to maintain and easy to use.

### Easy to install:

All WeatherMaker® units are field-convertible to horizontal air flow which makes it easy to adjust to unexpected job site complications. Lighter units make easy replacement. Carrier 48KC rooftops fit on existing Carrier curbs dating back to 1989. Also, our large control box gives you room to work and room to mount Carrier accessory controls.

### Easy to maintain:

Easy access handles by Carrier provide quick and easy access to all normally serviced components. Our “no-strip” screw system has superior holding power and guides screws into position while preventing the screw from stripping the unit’s metal. Take accurate pressure readings by reading condenser pressure with panels on. Simply remove the black, composite plug, route your gauge line(s) through the hole, and connect them to the refrigeration service valve(s).

### Easy to use:

The newly designed, central terminal board by Carrier puts all your connections and troubleshooting points in one convenient place, standard. Most low voltage connections are made to the same board and make it easy to find what you’re looking for and easy to access it. Carrier rooftops have high and low pressure switches, a filter drier, and 2-in (51mm) filters standard.

## FEATURES AND BENEFITS

- Single cooling stage models are available from 3 - 5 ton.
- SEER up to 14.1.
- EER's up to 12.0.
- Up to 28% lighter than similar industry units. Lighter rooftops make easier replacement jobs.
- Utility connections are the same because 3 - 5 ton units fit on existing Carrier rooftop curbs. This saves time and money on replacement jobs.
- Standardized components and layout. Standardized components and controls make service and stocking parts easier.
- Scroll compressors on all units. This makes service, stocking parts, replacement, and troubleshooting easier.
- Field convertible airflow. Being able to convert a unit from vertical airflow to horizontal makes it easy to overcome job site complications.
- Standard Direct Drive - ECM indoor motor with optional belt drive system to meet nearly all applications.
- Provisions for bottom or side condensate drain.
- Capable of thru-the-base or thru-the-curb gas line routing.
- Single-point gas / electrical connection.
- Sloped, composite drain pan sheds water; and won't rust.
- Standardized controls & control box layout. Standardized components & controls make stocking parts & service easier.
- Tool-less filter access door.
- Clean, large, easy to use control box.
- Color-coded wiring.
- Large, laminated wiring and power wiring drawings which are affixed to unit make troubleshooting easy.
- Single, central terminal board for test and wiring connections.
- Fast-access, handled, panels for easy access on normally accessed service panels.
- "No-strip" screw system guides screws into the panel & captures them tightly without stripping the screw, the panel, or the unit.
- Mechanical cooling (115°F to 40°F or 46°C to 4°C) standard on all models. Winter Start Kit allows cooling operation down to 25°F (-4°C) and MotorMaster to -20°F (-29°C).
- High efficiency, gas heat with induced-draft flue exhaust design.
- Induced draft motor ensures no flue gas can escape into the indoor air stream.
- Carrier designed naturally draining heat exchanger, unlike positive pressure heat exchangers, do not need to be periodically, manually drained. This saves labor and maintenance expense.
- 2-in (51mm) disposable filters on all units.
- Refrigerant filter-drier on each circuit.
- Each circuit is protected with a high and low pressure switch.
- Many factory-installed options ranging from air management economizers, 2 position dampers, plus convenience outlets, disconnect switches and smoke detectors.
- Standard (parts only) Warranty: 15 yr. Stainless steel, 10 yr. aluminized heat exchanger, 5 yr. compressor, 1 yr. parts.
- Factory-installed Humidi-MiZer® adaptive dehumidification system on all sizes with round tube / plate fin condenser coils, includes MotorMaster I controller.

# MODEL NUMBER NOMENCLATURE

Position:	1	2	3	4	5	6	7	8	9	10	11	12	13	14	15	16	17	18
Example:	4	8	K	C	D	A	0	4	A	0	A	5	-	0	A	0	A	0

48KC

**Unit Heat Type**  
48 - Gas Heat Packaged Rooftop

**Model Series - WeatherMaker®**  
KC - Standard 14 SEER Efficiency

**Heat Options**  
 D = Low Gas Heat  
 E = Medium Gas Heat  
 F = High Gas Heat  
 L = Low Nox — Low Gas Heat  
 M = Low Nox — Medium Gas Heat  
 N = Low Nox — High Gas Heat  
 S = Low Heat w/ Stainless Steel Exchanger  
 R = Medium Heat w/ Stainless Steel Exchanger  
 T = High Heat w/ Stainless Steel Exchanger  
 (Low Nox models include — Stainless Steel HX)

**Refrig. Systems Options**  
 A = Standard One Stage Cooling Models  
 B = Standard One Stage Cooling Models with Humidi-MiZer®

**Cooling Tons**  
 04 - 3 ton  
 05 - 4 ton  
 06 - 5 ton

**Sensor Options**  
 A = None  
 B = RA Smoke Detector  
 C = SA Smoke Detector  
 D = RA + SA Smoke Detector  
 E = CO<sub>2</sub>  
 F = RA Smoke Detector and CO<sub>2</sub>  
 G = SA Smoke Detector and CO<sub>2</sub>  
 H = RA + SA Smoke Detector and CO<sub>2</sub>

**Indoor Fan Options**  
 0 = Direct Drive ECM  
 2 = Medium Static Option  
 3 = High Static Option

**Coil Options - Round Tube/Plate Fin Condenser Coil (Outdoor - Indoor - Hail Guard)**  
 A = Al/Cu - Al/Cu  
 B = Precoat Al/Cu - Al/Cu  
 C = E-coat Al/Cu - Al/Cu  
 D = E-coat Al/Cu - E-coat Al/Cu  
 E = Cu/Cu - Al/Cu  
 F = Cu/Cu - Cu/Cu  
 M = Al/Cu -Al/Cu — Louvered Hail Guard  
 N = Precoat Al/Cu - Al/Cu — Louvered Hail Guard  
 P = E-coat Al/Cu - Al/Cu — Louvered Hail Guard  
 Q = E-coat Al/Cu - E-coat Al/Cu — Louvered Hail Guard  
 R = Cu/Cu - Al/Cu — Louvered Hail Guard  
 S = Cu/Cu - Cu/Cu — Louvered Hail Guard

**Factory Assigned**  
 0 = Standard  
 1 = LTL

**Electrical Options**  
 A = None  
 C = Non-Fused Disconnect  
 D = Thru-The-Base Connections  
 F = Non-Fused Disconnect and Thru-The-Base Connections

**Service Options**  
 0 = None  
 1 = Unpowered Convenience Outlet  
 2 = Powered Convenience Outlet  
 3 = Hinged Access Panels  
 4 = Hinged Access Panels and Unpowered Convenience Outlet  
 5 = Hinged Panels and Powered Convenience Outlet

**Intake / Exhaust Options**  
 A = None  
 B = Temperature Economizer w/ Barometric Relief  
 F = Enthalpy Economizer w/ Barometric Relief  
 K = 2-Position Damper  
 U = Temperature Ultra Low Leak Economizer w/ Barometric Relief  
 W = Enthalpy Ultra Low Leak Economizer w/ Barometric Relief

**Base Unit Controls**  
 0 = Electro-mechanical Controls can be used with W7212 EconoMi\$er IV (Non-Fault Detection and Diagnostic)  
 1 = PremierLink Controller  
 2 = RTU Open Multi-Protocol Controller  
 6 = Electro-mechanical with W7220 Economizer controller Controls. Can be used with W7220 EconoMi\$er X (with Fault Detection and Diagnostic)

**Design Revision**  
 - = Factory Design Revision

**Voltage**  
 1 = 575/3/60  
 3 = 208-230/1/60  
 5 = 208-230/3/60  
 6 = 460/3/60

**Note: On single phase (-3 voltage code) models, the following are not available as a factory installed option:**  
 - Humidi-MiZer  
 - Coated Coils or Cu Fin Coils  
 - Louvered Hail Guards  
 - Economizer or 2 Position Damper  
 - Powered 115 Volt Convenience Outlet

**Table 1 – FACTORY-INSTALLED OPTIONS AND FIELD-INSTALLED ACCESSORIES**

CATEGORY	ITEM	FACTORY INSTALLED OPTION	FIELD INSTALLED ACCESSORY
<b>Cabinet</b>	Thru–the–base electrical or gas–line connections	X	X
	Hinged Access Panels	X	
<b>Coil Options</b>	Cu/Cu indoor and/or outdoor coils <sup>5</sup>	X	
	Pre–coated outdoor coils <sup>5</sup>	X	
	Premium, E–coated outdoor coils <sup>5</sup>	X	
<b>Humidity Control</b>	Humidi–MiZer Adaptive Dehumidification System <sup>5</sup>	X	
<b>Condenser Protection</b>	Condenser coil hail guard (louvered design) <sup>5</sup>	X	X
<b>Controls</b>	Thermostats, temperature sensors, and subbases		X
	PremierLink DDC communicating controller	X	X
	RTU Open multi–protocol controller	X	
	Smoke detector (supply and/or return air)	X	
	Time Guard II compressor delay control circuit		X
	Phase Monitor		X
<b>Economizers &amp; Outdoor Air Dampers</b>	EconoMi\$er IV for electro–mechanical controls – Non FDD (Standard air leak damper models) <sup>5, 6</sup>	X	X
	EconoMi\$er2 for DDC controls, complies with FDD (Standard and Ultra Low Leak air damper models) <sup>5, 7</sup>	X	X
	Motorized 2 position outdoor air damper <sup>5</sup>	X	X
	Manual outdoor air damper (25% and 50%)		X
	Barometric relief <sup>1</sup>	X	X
	Power exhaust		X
	EconoMi\$er X for electro–mechanical controls, complies with FDD. (Standard and Ultra Low Leak air damper models) <sup>5, 6</sup>	X	X
<b>Economizer Sensors &amp; IAQ Devices</b>	Single dry bulb temperature sensors <sup>2</sup>	X	X
	Differential dry bulb temperature sensors <sup>2</sup>		X
	Single enthalpy sensors <sup>2</sup>	X	X
	Differential enthalpy sensors <sup>2</sup>		X
	Wall or duct mounted CO <sub>2</sub> sensor <sup>2</sup>		X
	Unit mounted CO <sub>2</sub> sensor <sup>2</sup>	X	
<b>Gas Heat</b>	Propane conversion kit		X
	Stainless steel heat exchanger	X	
	High altitude conversion kit		X
	Flue Shield		X
	Flue Discharge Deflector		X
<b>Indoor Motor &amp; Drive</b>	Multiple motor and drive packages	X	
<b>Low Ambient Control</b>	Winter start kit <sup>3</sup>		X
	Motormaster® head pressure controller <sup>3</sup>		X
<b>Power Options</b>	Convenience outlet (powered) <sup>5</sup>	X	
	Convenience outlet (un–powered)	X	
	Non–fused disconnect <sup>4</sup>	X	
<b>Roof Curbs</b>	Roof curb 14–in (356mm)		X
	Roof curb 24–in (610mm)		X

**NOTES:**

- Included with economizer.
- Sensors used to optimize economizer performance.
- See application data for assistance.
- Available on units with MOCP's of 80 amps or less.
- Not available as factory installed option on single phase (208/230/1/60) models. Use field–installed accessory where available.
- FDD (Fault Detection and Diagnostic) capability per California Title 24 section 120.2.
- Models with RTU Open DDC controls comply with California Title 24 Fault Detection and Diagnostic (FDD). PremierLink is non FDD.

48KC

# FACTORY OPTIONS AND/OR ACCESSORIES

## Economizer

Economizers save energy, money and improve comfort levels in the conditioned space. They bring in fresh, outside air for ventilation; and provide cool outside air to cool your building. This also is the preferred method of low ambient cooling. When integrated with CO<sub>2</sub> sensors, economizers can provide even more savings by coupling the ventilation air to only that amount required based on space occupancy. Economizers are available, installed and tested by the factory, with either enthalpy or temperature dry-bulb inputs. There are also models for electromechanical and direct digital controllers. Additional sensors are available as accessories to optimize the economizer. Economizers include gravity controlled barometric relief that helps equalize building pressure and ambient air pressures. This can be a cost effective solution to prevent building pressurization. Economizers are available in Ultra Low Leak and standard low leak versions.

## CO<sub>2</sub> Sensor

Improves productivity and saves money by working with the economizer to intake only the correct amount of outside air for ventilation. As occupants fill your building, the CO<sub>2</sub> sensor detects their presence through increasing CO<sub>2</sub> levels, and opens the economizer appropriately.

When the occupants leave, the CO<sub>2</sub> levels decrease, and the sensor appropriately closes the economizer. This intelligent control of the ventilation air, called Demand Control Ventilation (DCV) reduces the overall load on the rooftop, saving money.

## Smoke Detectors

Trust the experts. Smoke detectors make your application safer and your job easier. Carrier smoke detectors immediately shut down the rooftop unit when smoke is detected. They are available, installed by the factory, for supply air, return air, or both.

## Louvered Hail Guards

Sleek, louvered panels protect the condenser coil from hail damage, foreign objects, and incidental contact.

## Convenience Outlet (powered or un-powered)

Reduce service and/or installation costs by including a convenience outlet in your specification. Carrier will install this service feature at our factory. Provides a convenient, 15 amp, 115v GFCI receptacle with “Wet in Use” cover. The “powered” option allows the installer to power the outlet from the line side of the disconnect or load side as required by code. The “un-powered” option is to be powered from a separate 115/120v power source.

## Non-fused Disconnect

This OSHA-compliant, factory installed, safety switch allows a service technician to locally secure power to the rooftop.

## Power Exhaust with Barometric Relief

Superior internal building pressure control. This field installed accessory may eliminate the need for costly, external pressure control fans.

## PremierLink, DDC Controller

This CCN controller regulates your rooftop’s performance to tighter tolerances and expanded limits, as well as facilitates zoning systems and digital accessories. It also unites your Carrier HVAC equipment together on one, coherent CCN network. The PremierLink can be factory installed, or easily field installed.

## RTU Open, Multi-Protocol Controller

Connect the rooftop to an existing BAS without needing complicated translators or adapter modules using the RTU Open controller. This new controller speaks the 4 most common building automation system languages (Bacnet, Modbus, N2, and Lonworks). Use this controller when you have an existing BAS.

## Time Guard II Control Circuit

This accessory protects your compressor by preventing short-cycling in the event of some other failure, prevents the compressor from restarting for 30 seconds after stopping. Not required with PremierLink, RTU Open, or authorized commercial thermostats.

## Motorized 2-Position Damper

The new Carrier 2-position, motorized outdoor air damper admits up to 100% outside air. Using reliable, gear-driven technology, the 2-position damper opens to allow ventilation air and closes when the rooftop stops, stopping unwanted infiltration.

## Manual OA Damper

Manual outdoor air dampers are an economical way to bring in ventilation air. The dampers are available in 25% and 50% versions.

## Optional Humidi-MiZer Adaptive Dehumidification System

Carrier’s Humidi-MiZer Adaptive Dehumidification System is an all-inclusive factory installed option that can be ordered with any WeatherMaker 48KC\*B04-06 rooftop unit.

This system expands the envelope of operation of Carrier’s WeatherMaker rooftop products to provide unprecedented flexibility to meet year round comfort conditions.

The Humidi-MiZer adaptive dehumidification system has the industry’s only dual dehumidification mode setting. The Humidi-MiZer system includes two new modes of operation.



## FACTORY OPTIONS AND/OR ACCESSORIES (cont.)

### Opt. Humidi-MiZer Adap. Dehum. Sys. (cont.)

The WeatherMaker 48KC\*B04-06 rooftop coupled with the Humidi-MiZer system is capable of operating in normal design cooling mode, subcooling mode, and hot gas reheat mode. Normal design cooling mode is when the unit will operate under its normal sequence of operation by cycling compressors to maintain comfort conditions.

Subcooling mode will operate to satisfy part load type conditions when the space requires combined sensible and a higher proportion of latent load control. Hot Gas Reheat mode will operate when outdoor temperatures diminish and the need for latent capacity is required for sole humidity control. Hot Gas Reheat mode will provide neutral air for maximum dehumidification operation.

### Motormaster Head Pressure Controller

The Motormaster motor controller is a low ambient, head pressure controller kit that is designed to maintain the unit's condenser head pressure during periods of low ambient cooling operation. This device should be used as an alternative to economizer free cooling when economizer usage is either not appropriate or desired. The Motormaster will either cycle the outdoor fan motors or operate them at reduced speed to maintain the unit operation, depending on the model.

### Winter Start Kit

The winter start kit by Carrier extends the low ambient limit of your rooftop to 25°F (-4°C). The kit bypasses the low pressure switch, preventing nuisance tripping of the low pressure switch. Other low ambient precautions may still be prudent.

### Propane Heating

Convert your gas heat rooftop from standard natural gas operation to propane using this field installed kit.

### High Altitude Heating

High altitudes have less oxygen, which means heat exchangers need less fuel. The new gas orifices in this field installed kit make the necessary adjustment for high altitude applications. They restore the optimal fuel to air mixture and maintain healthy combustion at altitudes above 2000 ft (610m). Kits may not be required in all areas.

### Hinged Access Panels

Allows access to unit's major components with specifically designed hinged access panels. Panels are: filter, control box, fan motor, and compressor.

### Flue Discharge Deflector

The flue discharge deflector is a useful accessory when flue gas recirculation is a concern. By venting the flue discharge upwards, the deflector minimizes the chance for a neighboring unit to intake the flue exhaust.

### Optional Stainless Steel Heat Exchanger

The stainless steel heat exchanger option provides the tubular heat exchanger be made out of a minimum 20 gauge type 409 stainless steel for applications where the mixed air to the heat exchanger is expected to drop below 45°F (7°C). Stainless steel may be specified on applications where the presence of airborne contaminants require its use (applications such as paper mills) or in areas with very high outdoor humidity that may result in severe condensation in the heat exchanger during cooling operation.

### Flue Discharge Heat Shield

The flue discharge heat shield keeps people from touching the rooftop unit's potentially hot flue discharge. This is especially useful for ground level applications, where more, untrained people could have access to the unit's exterior.

### Alternate Motors and Drives

Some applications need larger horsepower motors, some need more airflow, and some need both. Regardless of the case, your Carrier expert has a factory installed combination to meet your application. A wide selection of motors and pulleys (drives) are available, factory installed, to handle nearly any application.

### Thru-the-Base Connections

Thru-the-base connections, available as either an accessory or as a factory option, are necessary to ensure proper connection and seal when routing wire and piping through the rooftop's basepan and curb. These couplings eliminate roof penetration and should be considered for gas lines, main power lines, as well as control power.

**Table 2 – AHRI COOLING RATING TABLE**

UNIT	COOLING STAGES	NOM. CAPACITY (TONS)	NET COOLING CAPACITY (MBH)	TOTAL POWER (KW)	SEER	EER
48KC**04	1	3	35.4	3.0	14.0	12.00
48KC**05	1	4	47.5	4.0	14.0	12.00
48KC**06	1	5	58.5	4.9	14.1	12.00

**LEGEND**

- AHRI – Air Conditioning, Heating and Refrigeration Institute Test Standard
- ASHRAE – American Society of Heating, Refrigerating and Air Conditioning, Inc.
- EER – Energy Efficiency Ratio
- SEER – Seasonal Energy Efficiency Ratio

**NOTES:**

1. Rated in accordance with AHRI Standard 210/240.
2. Ratings are based on:  
**Cooling Standard:** 80°F (27°C) db, 67°F (19°C) wb indoor air temp and 95°F (35°C) db outdoor air temp.
3. All 48KC units comply with ASHRAE 90.1 and Department of Energy (DOE) Energy Standard for minimum SEER and EER requirements.
4. 48KC units comply with US Energy Policy Act (2005). To evaluate code compliance requirements, refer to state and local codes.

48KC



Use of the AHRI Certified TM Mark indicates a manufacturer's participation in the program. For verification of certification for individual products, go to [www.ahridirectory.org](http://www.ahridirectory.org).



**Table 3 – HEATING RATING TABLE - NATURAL GAS & PROPANE**

UNITS	GAS HEAT	AL/SS HEAT EXCHANGER		TEMP RISE (DEG F)	THERMAL EFFICIENCY (%)	AFUE (%)	
		INPUT / OUTPUT STAGE 1 (MBH)	INPUT / OUTPUT STAGE 2 (MBH)				
Single Phase	04	LOW	–	65 / 50	25 – 55	82.0%	81.0%
		MED	–	90 / 73	45 – 85	82.0%	81.2%
		HIGH	–	–	–	–	–
	05	LOW	–	65 / 50	20 – 55	82.0%	81.0%
		MED	–	90 / 73	30 – 65	82.0%	81.2%
		HIGH	–	130 / 105	45 – 80	82.0%	81.0%
	06	LOW	–	65 / 50	15 – 55	82.0%	81.0%
		MED	–	90 / 73	25 – 65	82.0%	81.2%
		HIGH	–	130 / 105	35 – 80	82.0%	81.0%
Three Phase	04	LOW	–	72 / 56	25 – 55	82.0%	N/A
		MED	82 / 66	115 / 89	55 – 85	80.0%	N/A
		HIGH	–	–	–	–	–
	05	LOW	–	72 / 56	25 – 55	82.0%	N/A
		MED	–	115 / 90	35 – 65	81.0%	N/A
		HIGH	120 / 96	150 / 117	50 – 80	80.0%	N/A
	06	LOW	–	72 / 56	20 – 55	82.0%	N/A
		MED	–	115 / 90	30 – 65	81.0%	N/A
		HIGH	120 / 96	150 / 117	40 – 80	80.0%	N/A

**NOTES:**

Heat ratings are for natural gas heat exchangers operated at or below 2000 ft (610 m). For information on propane or altitudes above 2000 ft (610 m), see the Application Data section of this book. Accessory Propane/High Altitude kits are also available.

In the USA the input rating for altitudes above 2000 ft (610m) must be derated by 4% for each 1000 ft (305 m) above sea level. In Canada, the input rating must be derated by 10% for altitudes of 2000 ft (610 m) to 4500 ft (1372 m) above sea level.



**Table 4 – HEATING RATING TABLE - LOW NO<sub>x</sub><sup>1</sup>**

UNIT	GAS HEAT	LOW NO <sub>x</sub> HEAT EXCHANGER		TEMP RISE (DEG F)	THERMAL EFFICIENCY (%)	AFUE (%)	
		INPUT / OUTPUT STAGE 1 (MBH)	INPUT / OUTPUT STAGE 2 (MBH)				
Single /Three Phase	04	LOW	-	60 / 47	20 – 50	82.0%	81.3%
		MED	-	90 / 72	30 – 60	82.0%	81.5%
		HIGH	-	-	-	-	-
	05	LOW	-	60 / 47	20 – 50	82.0%	81.3%
		MED	-	90 / 72	30 – 60	82.0%	81.5%
		HIGH	-	120 / 97	40 – 70	82.0%	81.3%
	06	LOW	-	60 / 47	15 – 50	82.0%	81.3%
		MED	-	90 / 72	25 – 60	82.0%	81.5%
		HIGH	-	120 / 97	35 – 70	82.0%	81.3%

**NOTE:**

- Units meet California’s South Coast Air Quality Management District (SCAQMD) Low–NO<sub>x</sub> emissions requirement of 40 nanograms per joule or less.
- Not Applicable

**Table 5 – SOUND PERFORMANCE TABLE**

UNIT	COOLING STAGES	OUTDOOR SOUND (dB) @60HZ								
		A–WEIGHTED	63	125	250	500	1000	2000	4000	8000
A04	1	76	78.2	78.0	74.2	73.3	70.6	66.0	62.4	56.9
A05	1	81	90.9	84.6	79.5	77.9	76.5	71.1	66.9	62.5
A06	1	77	87.5	82.5	76.1	73.6	71.3	67.1	64.1	60.0

**LEGEND**

dB – Decibel

**NOTES:**

- Outdoor sound data is measure in accordance with AHRI standard 270.
- Measurements are expressed in terms of sound power. Do not compare these values to sound pressure values because sound pressure depends on specific environmental factors which normally do not match individual applications. Sound power values are independent of the environment and therefore more accurate.
- A–weighted sound ratings filter out very high and very low frequencies, to better approximate the response of “average” human ear. A–weighted measurements for Carrier units are taken in accordance with AHRI standard 270.9



48KC

**Table 6 – MINIMUM - MAXIMUM AIRFLOW RATINGS - NATURAL GAS & PROPANE**

VOLTAGE	UNIT	HEAT LEVEL	COOLING		AL HX HEATING		SS HX HEATING	
			MINIMUM	MAXIMUM	MINIMUM	MAXIMUM	MINIMUM	MAXIMUM
SINGLE PHASE	48KC**04	LOW	900	1500	900	1970	900	1970
		MED			800	1520	800	1520
		HIGH			-	-	-	-
	48KC**05	LOW	1200	2000	900	2470	900	2470
		MED			1050	2280	1050	2280
		HIGH			1230	2190	1230	2190
	48KC**06	LOW	1500	2500	900	3290	900	3290
		MED			1050	2730	1050	2730
		HIGH			1230	2820	1230	2820
THREE PHASE	48KC**04	LOW	900	1500	990	2190	990	2190
		MED			1000	1550	1000	1550
		HIGH			-	-	-	-
	48KC**05	LOW	1200	2000	990	2190	990	2190
		MED			1330	2460	1330	2460
		HIGH			1390	2220	1390	2220
	48KC**06	LOW	1500	2500	990	2730	990	2730
		MED			1330	2880	1330	2880
		HIGH			1390	2780	1390	2780

48KC



**Table 7 – PHYSICAL DATA**

**(COOLING)**

**3 - 5 TONS**

		48KC*A/B04	48KC*A/B05	48KC*A/B06
<b>Refrigeration System</b>				
	# Circuits / # Comp. / Type	1 / 1 / Scroll	1 / 1 / Scroll	1 / 1 / Scroll
	Puron® refrig. (R-410A) 1 phase (lbs-oz)	7-2	10-8	16-0
	Puron® refrig. (R-410A) 3 phase (lbs-oz)	7-2	10-8	14-8
	Humidi-MiZer Puron® refrig. charge (lbs - oz)	10-6	15-5	26-0
	Metering Device (A)	Acutrol	Acutrol	Acutrol
	Humidi-MiZer Metering Device (B)	Acutrol + TXV	Acutrol + TXV	Acutrol + TXV
	High-press. Trip / Reset (psig)	630 / 505	630 / 505	630 / 505
	Low-press. Trip / Reset (psig)	54 / 117	54 / 117	54 / 117
	Compressor Capacity Staging (%)	100%	100%	100%
<b>Evap. Coil</b>				
	Material (Tube/Fin)	Cu / Al	Cu / Al	Cu / Al
	Coil type	3/8-in RTPPF	3/8-in RTPPF	3/8-in RTPPF
	Rows / FPI	3 / 15	3 / 15	4 / 15
	Total Face Area (ft <sup>2</sup> )	5.5	5.5	7.3
	Condensate Drain Conn. Size	3/4-in	3/4-in	3/4-in
<b>Humidi-MiZer® Coil</b>				
	Material (Tube/Fin)	Cu / Al	Cu / Al	Cu / Al
	Coil type	3/8-in RTPPF	3/8-in RTPPF	3/8-in RTPPF
	Rows / FPI	1 / 17	2 / 17	2 / 17
	Total Face Area (ft <sup>2</sup> )	3.9	3.9	5.2
<b>Evap. Fan and Motor</b>				
<b>Standard Static 1 phase</b>	Motor Qty / Drive Type	1 / Direct	1 / Direct	1 / Direct
	Max BHP	1	1	1
	RPM Range	600-1200	600-1200	600-1200
	Motor Frame Size	48	48	48
	Fan Qty / Type	1 / Centrifugal	1 / Centrifugal	1 / Centrifugal
	Fan Diameter (in)	10 x 10	10 x 10	10 x 10
<b>Medium Static 1 phase</b>	Motor Qty / Drive Type	1 / Belt	1 / Belt	1 / Belt
	Max BHP	1.2	1.2	1.5
	RPM Range	770-1175	770-1175	1035-1466
	Motor Frame Size	48	48	56
	Fan Qty / Type	1 / Centrifugal	1 / Centrifugal	1 / Centrifugal
	Fan Diameter (in)	10 x 10	10 x 10	10 x 10
<b>High Static 1 phase</b>	Motor Qty / Drive Type	1 / Belt	1 / Belt	N/A
	Max BHP	1.5	1.5	N/A
	RPM Range	1035-1466	1035-1466	N/A
	Motor Frame Size	56	56	N/A
	Fan Qty / Type	1 / Centrifugal	1 / Centrifugal	N/A
	Fan Diameter (in)	10 x 10	10 x 10	N/A
<b>Standard Static 3 phase</b>	Motor Qty / Drive Type	1 / Direct	1 / Direct	1 / Direct
	Max BHP	1	1	1
	RPM Range	600-1200	600-1200	600-1200
	Motor Frame Size	48	48	48
	Fan Qty / Type	1 / Centrifugal	1 / Centrifugal	1 / Centrifugal
	Fan Diameter (in)	10 x 10	10 x 10	11 x 10
<b>Medium Static 3 phase</b>	Motor Qty / Drive Type	1 / Belt	1 / Belt	1 / Belt
	Max BHP	1.7	1.7	2.9
	RPM Range	770-1175	920-1303	1035-1466
	Motor Frame Size	48	56	56
	Fan Qty / Type	1 / Centrifugal	1 / Centrifugal	1 / Centrifugal
	Fan Diameter (in)	10 x 10	10 x 10	10 x 10
<b>High Static 3 phase</b>	Motor Qty / Drive Type	1 / Belt	1 / Belt	1 / Belt
	Max BHP	2.9	2.9	2.9
	RPM Range	1035-1466	1208-1639	1303-1687
	Motor Frame Size	56	56	56
	Fan Qty / Type	1 / Centrifugal	1 / Centrifugal	1 / Centrifugal
	Fan Diameter (in)	10 x 10	10 x 10	10 x 10
<b>Cond. Coil 1 phase</b>				
	Material (Tube/Fin)	Cu / Al	Cu / Al	Cu / Al
	Coil type	3/8-in RTPPF	3/8-in RTPPF	3/8-in RTPPF
	Rows / FPI	1 / 17	2 / 17	2 / 17
	Total Face Area (ft <sup>2</sup> )	16.5	16.5	21.3
<b>3 phase</b>				
	Material (Tube/Fin)	Cu / Al	Cu / Al	Cu / Al
	Coil type	3/8-in RTPPF	3/8-in RTPPF	3/8-in RTPPF
	Rows..Fins/in.	1 / 17	2 / 17	2 / 17
	Total Face Area (ft <sup>2</sup> )	16.5	14.6	18.8
<b>Cond. fan / motor</b>				
	Qty / Motor Drive Type	1/ Direct	1/ Direct	1/ Direct
	Motor HP / RPM	1/8 / 825	1/4 / 1100	1/4 / 1100
	Fan diameter (in)	22	22	22
<b>Filters</b>				
	RA Filter # / Size (in)	2 / 16 x 25 x 2	2 / 16 x 25 x 2	4 / 16 x 25 x 2
	OA inlet screen # / Size (in)	1 / 20 x 24 x 1	1 / 20 x 24 x 1	1 / 20 x 24 x 1

**48KC**

N/A – Not Available

**Table 8 – PHYSICAL DATA**

**(HEATING - SINGLE PHASE UNITS)**

**3 - 5 TONS**

**48KC**

		<b>48KC**04</b>	<b>48KC**05</b>	<b>48KC**06</b>
<b>Electrical</b>		Single Phase	Single Phase	Single Phase
<b>Gas Connection</b>				
	# of Gas Valves	1	1	1
	Nat. gas supply line press (in. w.g.)/ (PSIG)	4 -13 / 0.18 - 0.47	4 -13 / 0.18 - 0.47	4 -13 / 0.18 - 0.47
	LP supply line press (in. w.g.) / (PSIG)	11 -13 / 0.40 - 0.47	11 -13 / 0.40 - 0.47	11 -13 / 0.40 - 0.47
<b>Heat Anticipator setting (Amps)</b>				
	1st stage	0.14	0.14	0.14
	2nd stage	0.14	0.14	0.14
<b>Natural Gas Heat</b>				
<b>LOW</b>	# of stages / # of burners (total)	1 / 2	1 / 2	1 / 2
	Connection Size	1/2-in NPT	1/2-in NPT	1/2-in NPT
	Rollout switch opens / closes	195 / 115	195 / 115	195 / 115
	Temperature Rise	25 - 55	20 - 55	15 - 55
<b>MED</b>	# of stages / # of burners (total)	1 or 2 / 3	1 / 3	1 / 3
	Connection Size	1/2-in NPT	1/2-in NPT	1/2-in NPT
	Rollout switch opens / closes	195 / 115	195 / 115	195 / 115
	Temperature Rise	45 - 85	30 - 65	25 - 65
<b>HIGH</b>	# of stages / # of burners (total)	-	1 or 2 / 3	1 or 2 / 3
	Connection Size	-	1/2-in NPT	1/2-in NPT
	Rollout switch opens / closes	-	195 / 115	195 / 115
	Temperature Rise	-	45 - 80	35 - 80
<b>Liquid Propane Heat</b>				
<b>LOW</b>	# of stages / # of burners (total)	1 / 2	1 / 2	1 / 2
	Connection Size	1/2-in NPT	1/2-in NPT	1/2-in NPT
	Rollout switch opens / closes	195 / 115	195 / 115	195 / 115
	Temperature Rise	25 - 55	20 - 55	15 - 55
<b>MED</b>	# of stages / # of burners (total)	1 or 2 / 3	1 / 3	1 / 3
	Connection Size	1/2-in NPT	1/2-in NPT	1/2-in NPT
	Rollout switch opens / closes	195 / 115	195 / 115	195 / 115
	Temperature Rise	45 - 85	30 - 65	25 - 65
<b>HIGH</b>	# of stages / # of burners (total)	-	1 or 2 / 3	1 or 2 / 3
	Connection Size	-	1/2-in NPT	1/2-in NPT
	Rollout switch opens / closes	-	195 / 115	195 / 115
	Temperature Rise	-	45 - 80	35 - 80
<b>Low NOx Gas Heat</b>				
<b>LOW</b>	# of stages / # of burners (total)	1 / 2	1 / 2	1 / 2
	Connection Size	1/2-in NPT	1/2-in NPT	1/2-in NPT
	Rollout switch opens / closes	195 / 115	195 / 115	195 / 115
	Temperature Rise	20 - 50	20 - 50	15 - 50
<b>MED</b>	# of stages / # of burners (total)	1 / 3	1 / 3	1 / 3
	Connection Size	1/2-in NPT	1/2-in NPT	1/2-in NPT
	Rollout switch opens / closes	195 / 115	195 / 115	195 / 115
	Temperature Rise	30 - 60	30 - 60	25 - 60
<b>HIGH</b>	# of stages / # of burners (total)	-	1 / 3	1 / 3
	Connection Size	-	1/2-in NPT	1/2-in NPT
	Rollout switch opens / closes	-	195 / 115	195 / 115
	Temperature Rise	-	40 - 70	35 - 70

- Not applicable

**Table 9 – PHYSICAL DATA**

**(HEATING - THREE PHASE UNITS)**

**3 - 5 TONS**

		48KC**04	48KC**05	48KC**06
<b>Electrical</b>		Three Phase	Three Phase	Three Phase
<b>Gas Connection</b>				
	# of Gas Valves	1	1	1
	Nat. gas supply line press (in. w.g.) / (PSIG)	4 -13 / 0.18 - 0.47	4 -13 / 0.18 - 0.47	4 -13 / 0.18 - 0.47
	LP supply line press (in. w.g.) / (PSIG)	11 -13 / 0.40 - 0.47	11 -13 / 0.40 - 0.47	11 -13 / 0.40 - 0.47
<b>Heat Anticipator setting (Amps)</b>				
	1st stage	0.14	0.14	0.14
	2nd stage	0.14	0.14	0.14
<b>Natural Gas Heat</b>				
LOW	# of stages / # of burners (total)	1 / 2	1 / 2	1 / 2
	Connection Size	1/2-in NPT	1/2-in NPT	1/2-in NPT
	Rollout switch opens / closes	195 / 115	195 / 115	195 / 115
	Temperature Rise	25 - 55	25 - 55	20 - 55
MED	# of stages / # of burners (total)	1 or 2 / 3	1 / 3	1 / 3
	Connection Size	1/2-in NPT	1/2-in NPT	1/2-in NPT
	Rollout switch opens / closes	195 / 115	195 / 115	195 / 115
	Temperature Rise	55 - 85	35 - 65	30 - 65
HIGH	# of stages / # of burners (total)	-	1 or 2 / 3	1 or 2 / 3
	Connection Size	-	1/2-in NPT	1/2-in NPT
	Rollout switch opens / closes	-	195 / 115	195 / 115
	Temperature Rise	-	50 - 80	40 - 80
<b>Liquid Propane Heat</b>				
LOW	# of stages / # of burners (total)	1 / 2	1 / 2	1 / 2
	Connection Size	1/2-in NPT	1/2-in NPT	1/2-in NPT
	Rollout switch opens / closes	195 / 115	195 / 115	195 / 115
	Temperature Rise	25 - 55	25 - 55	20 - 55
MED	# of stages / # of burners (total)	1 or 2 / 3	1 / 3	1 / 3
	Connection Size	1/2-in NPT	1/2-in NPT	1/2-in NPT
	Rollout switch opens / closes	195 / 115	195 / 115	195 / 115
	Temperature Rise	55 - 85	35 - 65	30 - 65
HIGH	# of stages / # of burners (total)	-	1 or 2 / 3	1 or 2 / 3
	Connection Size	-	1/2-in NPT	1/2-in NPT
	Rollout switch opens / closes	-	195 / 115	195 / 115
	Temperature Rise	-	50 - 80	40 - 80
<b>Low NOx Gas Heat</b>				
LOW	# of stages / # of burners (total)	1 / 2	1 / 2	1 / 2
	Connection Size	1/2-in NPT	1/2-in NPT	1/2-in NPT
	Rollout switch opens / closes	195 / 115	195 / 115	195 / 115
	Temperature Rise	20 - 50	20 - 50	15 - 50
MED	# of stages / # of burners (total)	1 / 3	1 / 3	1 / 3
	Connection Size	1/2-in NPT	1/2-in NPT	1/2-in NPT
	Rollout switch opens / closes	195 / 115	195 / 115	195 / 115
	Temperature Rise	30 - 60	30 - 60	25 - 60
HIGH	# of stages / # of burners (total)	-	1 / 3	1 / 3
	Connection Size	-	1/2-in NPT	1/2-in NPT
	Rollout switch opens / closes	-	195 / 115	195 / 115
	Temperature Rise	-	40 - 70	35 - 70

48KC

- Not applicable





# CURBS, WEIGHTS & DIMENSIONS (cont.)

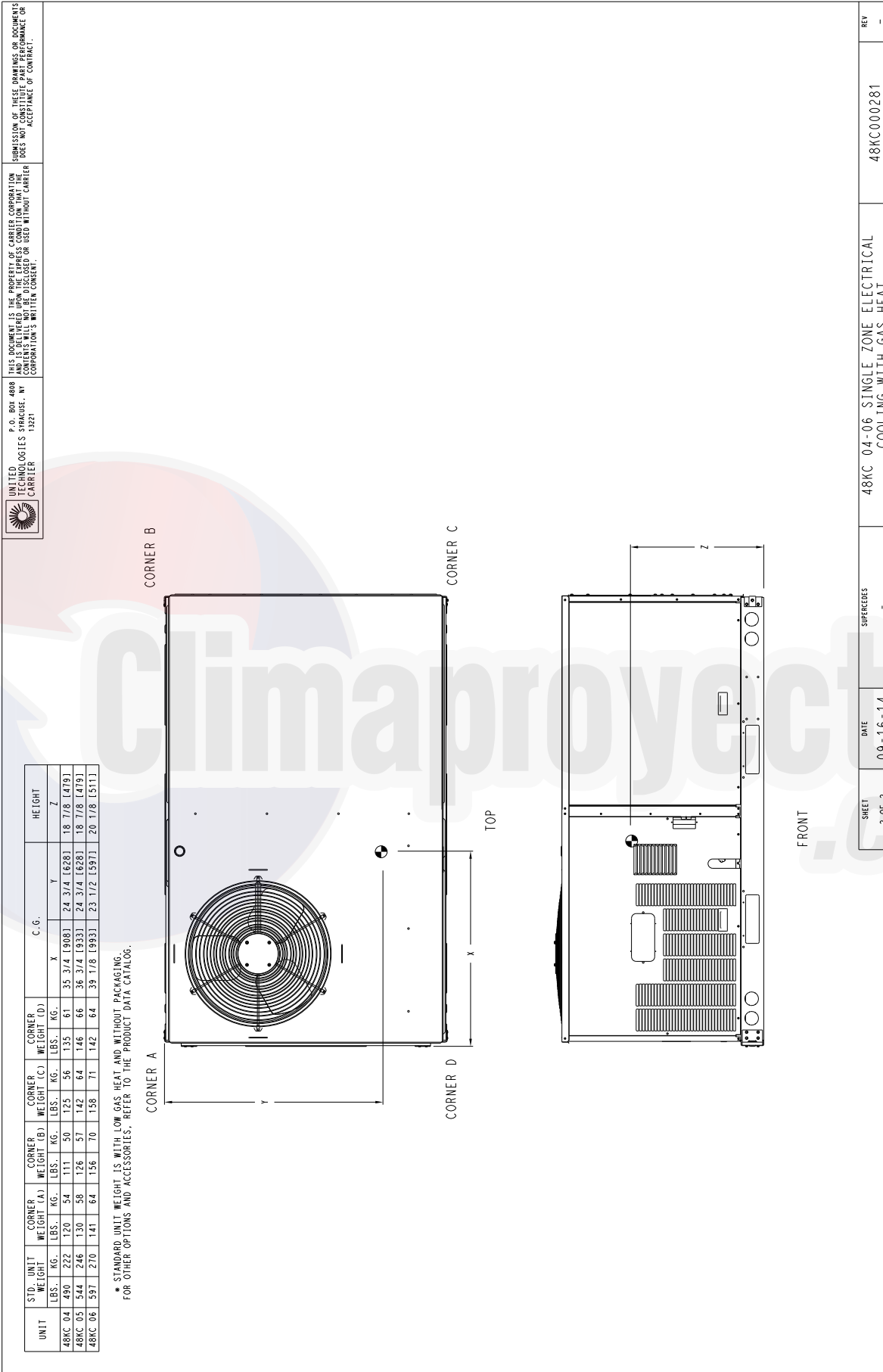
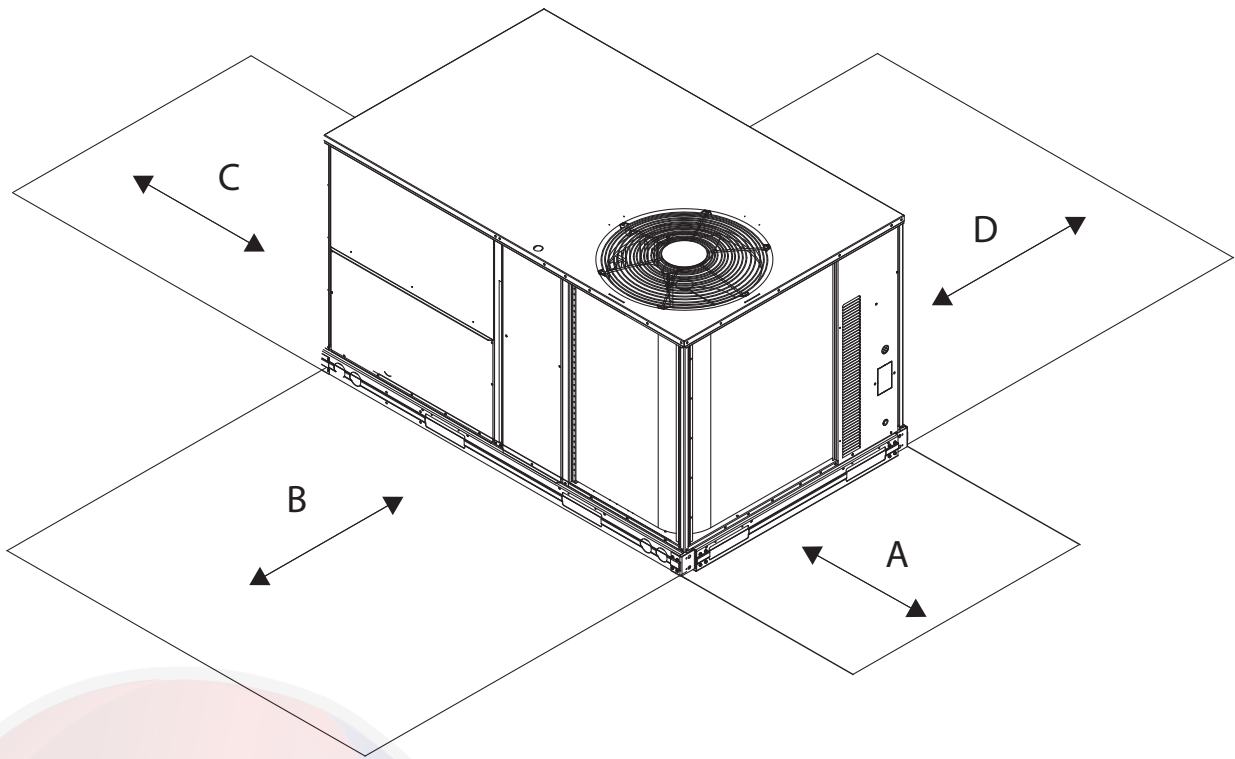

Fig. 2 - Dimension 48KC 04-06 (sheet 2 of 2)



C08337

LOCATION	DIMENSION	CONDITION
A	48-in (1219 mm) 18-in (457 mm) 18-in (457 mm) 12-in (305 mm)	Unit disconnect is mounted on panel No disconnect, convenience outlet option Recommended service clearance Minimum clearance
B	42-in (1067 mm) 36-in (914 mm) Special	Surface behind servicer is grounded (e.g., metal, masonry wall) Surface behind servicer is electrically non-conductive (e.g., wood, fiberglass) Check sources of flue products within 10-ft of unit fresh air intake hood
C	36-in (914 mm) 18-in (457 mm)	Side condensate drain is used Minimum clearance
D	48-in (1219 mm) 42-in (1067 mm) 36-in (914 mm) Special	No flue discharge accessory installed, surface is combustible material Surface behind servicer is grounded (e.g., metal, masonry wall, another unit) Surface behind servicer is electrically non-conductive (e.g., wood, fiberglass) Check for adjacent units or building fresh air intakes within 10-ft (3 m) of this unit's flue outlet

**NOTE:** Unit not designed to have overhead obstruction. Contact Application Engineering for guidance on any application planning overhead obstruction or for vertical clearances.

**Fig. 3 - Service Clearance Dimensional Drawing**

# CURBS, WEIGHTS & DIMENSIONS (cont.)

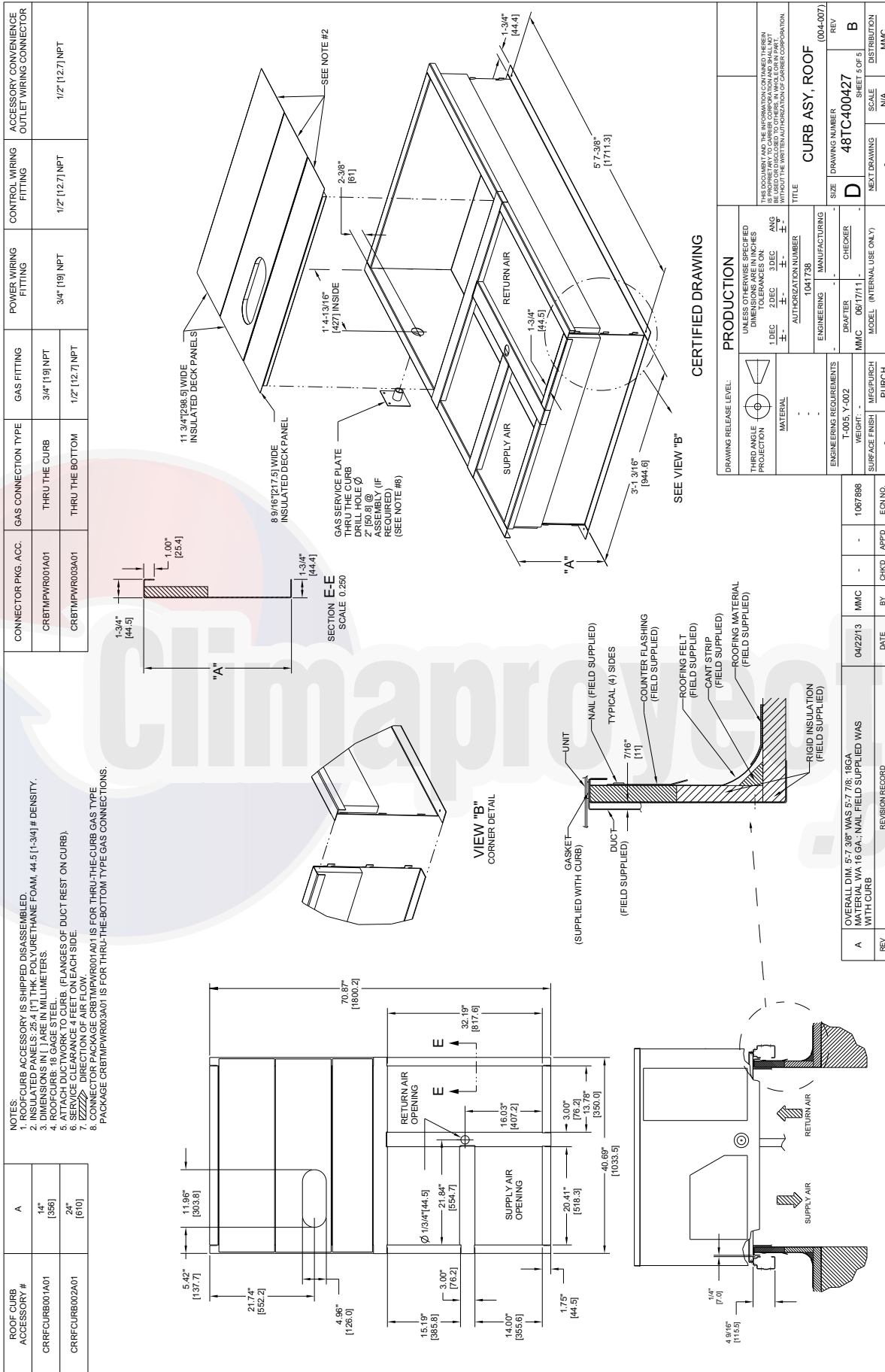

**Fig. 4 - Roof Curb Details - 48TC 04-06**

**48KC**

## OPTIONS & ACCESSORY WEIGHTS

OPTION / ACCESSORY	OPTION / ACCESSORY WEIGHTS					
	04		05		06	
	lb	kg	lb	kg	lb	kg
Humidi-MiZer <sup>1</sup>	50	23	50	23	55	25
Power Exhaust – vertical	45	20	45	20	45	20
Power Exhaust – horizontal	30	14	30	14	30	14
EconoMi\$er (IV, X or 2)	35	16	35	16	35	16
Two Position damper	39	18	39	18	39	18
Manual Dampers	12	5	12	5	12	5
Medium Gas Heat	12	5	9	4	9	4
High Gas Heat	–	–	17	8	17	8
Hail Guard (louvered)	13	6	13	6	17	8
Cu/Cu Condenser Coil <sup>2</sup>	37	17	74	34	95	43
Cu/Cu Condenser and Evaporator Coils <sup>2</sup>	75	34	112	51	165	75
Roof Curb (14-in. curb)	115	52	115	52	115	52
Roof Curb (24-in. curb)	197	89	197	89	197	89
CO <sub>2</sub> sensor	2	1	2	1	2	1
Flue Discharge Deflector	7	3	7	3	7	3
Optional Indoor Motor/Drive	6	3	6	3	17	8
Motor Master Controller	9	4	9	4	9	4
Return Smoke Detector	7	3	7	3	7	3
Supply Smoke Detector	7	3	7	3	7	3
Non-Fused Disconnect	5	2	5	2	5	2
Powered Convenience outlet	36	16	36	16	36	16
Non-Powered Convenience outlet	4	2	4	2	4	2
Enthalpy Sensor	2	1	2	1	2	1
Differential Enthalpy Sensor	3	1	3	1	3	1

**NOTE:** Where multiple variations are available, the heaviest combination is listed.

– Not Available

<sup>1</sup> For Humidi-MiZer add MotorMaster Controller.

<sup>2</sup> Where available.

48KC

## APPLICATION DATA

### Min operating ambient temp (cooling):

In mechanical cooling mode, your Carrier rooftop unit can safely operate down to an outdoor ambient temperature of 40°F (4°C) and 25°F (-4°C), with an accessory winter start kit. It is possible to provide cooling at lower outdoor ambient temperatures by using less outside air, economizers, and/or accessory low ambient kits.

### Max operating ambient temp (cooling):

The maximum operating ambient temperature for cooling mode is 115°F (46°C). While cooling operation above 115°F (46°C) may be possible, it could cause either a reduction in performance, reliability, or a protective action by the unit's internal safety devices.

### Min mixed air temp (heating):

Using the factory settings, the minimum temperatures for the mixed air (the combined temperature of the warm return air and the cold outdoor air) entering the dimpled, gas heat exchangers are:

<u>Aluminized</u>	<u>Stainless Steel</u>
50°F (10°C) continuous	40°F (4°C) continuous
45°F (7°C) intermittent	35°F (2°C) intermittent

Operating at lower mixed-air temperatures may be possible, if a field supplied, outdoor air thermostat initiates both heat stages when the temperature is less than the minimum temperatures listed above. Please contact your local Carrier representative for assistance.

### Min and max airflow (heating and cooling):

To maintain safe and reliable operation of your rooftop, operate within the heating airflow limits during heating mode and cooling airflow limits during cooling mode. Operating above the max may cause blow-off, undesired airflow noise, or airflow related problems with the rooftop unit. Operating below the min may cause problems with coil freeze-up and unsafe heating operation. Heating and cooling limitations differ when evaluating operating cfm, the minimum value is the HIGHER of the cooling and heating minimum cfm values published in Table 6 and the maximum value is the LOWER of the cooling and heating maximum values published in Table 6.

### Heating-to-cooling changeover:

Your unit will automatically change from heating to cooling mode when using a thermostat with an auto-changeover feature.

### Airflow:

All units are draw-through in cooling mode and blow-through in heating mode.

### Outdoor air application strategies:

Economizers reduce operating expenses and compressor run time by providing a free source of cooling and a means of ventilation to match application changing needs. In fact, they should be considered for most applications. Also, consider the various economizer control methods and their benefits, as well as sensors required to accomplish your application goals. Please contact your local Carrier representative for assistance.

### Motor limits, Brake horsepower (BHP):

Due to internal design of Carrier units, the air path, and specially designed motors, the full horsepower (maximum continuous BHP) band, as listed in Table 8 and 10, can be used with the utmost confidence. There is no need for extra safety factors, as Carrier motors are designed and rigorously tested to use the entire, listed BHP range without either nuisance tripping or premature motor failure.

### Propane heating:

Propane has different physical qualities than natural gas. As a result, propane requires different fuel to air mixture. To optimize the fuel/air mixture for propane, Carrier sells different burner orifices in an easy to install accessory kit. To select the correct burner orifices or determine the heat capacity for a propane application, use either the selection software, or the unit's service manual.

### High altitude heating:

High altitudes have less oxygen, which affects the fuel/air mixture in heat exchangers. In order to maintain a proper fuel/air mixture, heat exchangers operating in altitudes above 2000 ft (610 m) require different orifices. To select the correct burner orifices or determine the heat capacity for a high altitude application, use either the selection software, or the unit's service manual.

High altitudes have less oxygen, which means heat exchangers need less fuel. The new gas orifices in this field installed kit make the necessary adjustment for high altitude applications. They restore the optimal fuel to air mixture and maintain healthy combustion on altitudes above 2000 ft (610 m).

**NOTE:** Typical natural gas heating value ranges from 975 to 1050 Btu/ft<sup>3</sup> at sea level nationally. The heating value goes down approximately 1.7% per every thousand feet elevation. Standard factory orifices can typically be used up to 2000 ft (610m) elevation without any operational issues.

**NOTE:** For installations in Canada, the input rating should be derated by 10% for altitudes from 2000 ft (610m) to 4500 ft (1372m) above sea level.

## APPLICATION DATA (cont.)

### Sizing a rooftop

Bigger isn't necessarily better. While an air conditioner needs to have enough capacity to meet the design loads, it doesn't need excess capacity. In fact, excess capacity typically results in very poor part load performance and humidity control.

Using higher design temperatures than ASHRAE recommends for your location, adding "safety factors" to the calculated load, are all signs of oversizing air conditioners. Oversizing the air conditioner leads to poor humidity control, reduced efficiency, higher utility bills, larger indoor temperature swings, excessive noise, and increased wear and tear on the air conditioner.

Rather than oversizing an air conditioner, engineers should "right size" or even slightly undersize air conditioners. Correctly sizing an air conditioner controls humidity better; promotes efficiency; reduces utility bills; extends equipment life, and maintains even, comfortable temperatures. Please contact your local Carrier representative for assistance.

### Low ambient applications

The optional Carrier economizer can adequately cool your space by bringing in fresh, cool outside air. In fact, when so equipped, accessory low ambient kit may not be necessary. In low ambient conditions, unless the outdoor air is excessively humid or contaminated, economizer based "free cooling" is the preferred less costly and energy conscious method.

In low ambient applications where outside air might not be desired (such as contaminated or excessively humid outdoor environments), your Carrier rooftop can operate at ambient temperatures down to -20°F (-29°C) using the recommended accessory Motormaster low ambient controller.

48KC

Climaproyectos  
.com



Table 10 – COOLING CAPACITIES

1-STAGE COOLING

3 TONS

48KC*A04				Ambient Temperature											
				85			95			105			115		
				EA (dB)			EA (dB)			EA (dB)			EA (dB)		
				75	80	85	75	80	85	75	80	85	75	80	85
900 Cfm	EAT (wb)	58	TC	28.7	28.7	32.6	25.1	25.1	28.6	22.2	22.2	25.3	19.5	19.5	22.2
			SHC	24.8	28.7	32.6	21.7	25.1	28.6	19.1	22.2	25.3	16.7	19.5	22.2
		62	TC	31.8	31.8	32.4	26.0	26.0	29.5	22.3	22.3	26.4	19.5	19.5	23.2
			SHC	23.3	27.9	32.4	20.6	25.0	29.5	18.1	22.3	26.4	15.8	19.5	23.2
		67	TC	36.5	36.5	36.5	34.2	34.2	34.2	29.2	29.2	29.2	23.7	23.7	23.7
			SHC	19.4	24.0	28.5	18.4	22.9	27.4	16.2	20.8	25.3	14.1	18.6	23.1
		72	TC	40.3	40.3	40.3	38.2	38.2	38.2	35.6	35.6	35.6	32.4	32.4	32.4
			SHC	14.9	19.5	24.1	13.9	18.5	23.1	12.9	17.4	22.0	11.6	16.2	20.7
		76	TC	-	43.1	43.1	-	41.0	41.0	-	38.6	38.6	-	35.9	35.9
			SHC	-	15.7	20.6	-	14.8	19.8	-	13.9	18.8	-	12.8	17.6
1050 Cfm	EAT (wb)	58	TC	31.8	31.8	36.2	28.3	28.3	32.1	24.9	24.9	28.4	21.9	21.9	24.9
			SHC	27.5	31.8	36.2	24.4	28.3	32.1	21.5	24.9	28.4	18.8	21.9	24.9
		62	TC	33.8	33.8	36.1	28.9	28.9	33.4	25.0	25.0	29.6	21.9	21.9	26.0
			SHC	25.7	30.9	36.1	23.2	28.3	33.4	20.4	25.0	29.6	17.8	21.9	26.0
		67	TC	37.8	37.8	37.8	35.5	35.5	35.5	31.7	31.7	31.7	25.8	25.8	26.2
			SHC	20.7	25.9	31.1	19.7	24.9	30.1	18.1	23.3	28.6	15.8	21.0	26.2
		72	TC	41.5	41.5	41.5	39.3	39.3	39.3	36.8	36.8	36.8	33.6	33.6	33.6
			SHC	15.4	20.6	25.8	14.5	19.7	24.9	13.5	18.7	23.9	12.2	17.5	22.7
		76	TC	-	44.2	44.2	-	42.0	42.0	-	39.6	39.6	-	36.9	36.9
			SHC	-	16.4	22.1	-	15.5	21.1	-	14.5	20.0	-	13.5	18.9
1200 Cfm	EAT (wb)	58	TC	34.1	34.1	38.8	31.3	31.3	35.6	27.5	27.5	31.2	24.1	24.1	27.4
			SHC	29.5	34.1	38.8	27.0	31.3	35.6	23.7	27.5	31.2	20.7	24.1	27.4
		62	TC	34.9	34.9	39.1	32.9	32.9	35.5	27.5	27.5	32.6	24.1	24.1	28.6
			SHC	27.5	33.3	39.1	25.2	30.3	35.5	22.5	27.5	32.6	19.6	24.1	28.6
		67	TC	38.8	38.8	38.8	36.4	36.4	36.4	33.3	33.3	33.3	27.7	27.7	29.2
			SHC	21.9	27.7	33.5	20.9	26.7	32.6	19.6	25.5	31.4	17.4	23.3	29.2
		72	TC	42.4	42.4	42.4	40.1	40.1	40.1	37.7	37.7	37.7	34.5	34.5	34.5
			SHC	15.8	21.6	27.4	14.9	20.7	26.5	13.9	19.8	25.6	12.7	18.7	24.6
		76	TC	-	44.9	44.9	-	42.7	42.7	-	40.3	40.3	-	37.7	37.7
			SHC	-	16.8	23.1	-	15.9	22.1	-	15.0	21.1	-	14.0	20.1
1350 Cfm	EAT (wb)	58	TC	35.6	35.6	40.4	33.6	33.6	38.1	29.8	29.8	33.9	26.2	26.2	29.8
			SHC	30.8	35.6	40.4	29.0	33.6	38.1	25.7	29.8	33.9	22.5	26.2	29.8
		62	TC	36.3	36.3	39.9	33.7	33.7	39.7	29.9	29.9	35.3	26.2	26.2	31.0
			SHC	28.2	34.1	39.9	27.6	33.7	39.7	24.4	29.9	35.3	21.4	26.2	31.0
		67	TC	39.5	39.5	39.5	37.2	37.2	37.2	34.0	34.0	34.0	29.3	29.3	32.0
			SHC	22.9	29.4	35.8	22.0	28.5	34.9	20.8	27.3	33.9	18.9	25.4	32.0
		72	TC	43.0	43.0	43.0	40.7	40.7	40.7	38.3	38.3	38.3	35.2	35.2	35.2
			SHC	16.2	22.5	28.9	15.3	21.7	28.1	14.3	20.8	27.2	13.2	19.7	26.3
		76	TC	-	45.5	45.5	-	43.3	43.3	-	40.8	40.8	-	38.1	38.1
			SHC	-	17.3	24.0	-	16.4	23.1	-	15.4	22.1	-	14.5	21.1
1500 Cfm	EAT (wb)	58	TC	36.8	36.8	41.8	34.8	34.8	39.5	32.0	32.0	36.4	28.1	28.1	31.9
			SHC	31.9	36.8	41.8	30.1	34.8	39.5	27.7	32.0	36.4	24.2	28.1	31.9
		62	TC	36.9	36.9	43.5	35.4	35.4	38.8	32.1	32.1	37.9	28.1	28.1	33.3
			SHC	30.2	36.9	43.5	27.4	33.1	38.8	26.2	32.1	37.9	22.9	28.1	33.3
		67	TC	40.1	40.1	40.1	37.7	37.7	37.7	34.7	34.7	36.2	30.7	30.7	34.6
			SHC	23.9	31.0	38.0	23.0	30.1	37.2	21.9	29.0	36.2	20.3	27.5	34.6
		72	TC	43.6	43.6	43.6	41.3	41.3	41.3	38.7	38.7	38.7	35.7	35.7	35.7
			SHC	16.5	23.4	30.2	15.6	22.5	29.5	14.7	21.7	28.6	13.6	20.8	27.9
		76	TC	-	46.0	46.0	-	43.7	43.7	-	41.2	41.2	-	38.5	38.5
			SHC	-	17.6	24.8	-	16.7	23.9	-	15.8	22.9	-	14.8	22.0

48KC

LEGEND:

- Do not operate
- Cfm - Cubic feet per minute (supply air)
- EAT(db) - Entering air temperature (dry bulb)
- EAT(wb) - Entering air temperature (wet bulb)
- SHC - Sensible heat capacity
- TC - Total capacity

48KC

48KC*B04 (3 TONS) – UNIT WITH HUMIDI-MIZER SYSTEM IN SUBCOOLING MODE										
TEMP (F) AIR ENT CONDENSER (Edb)		AIR ENTERING EVAPORATOR – SCFM								
		900			1200			1500		
		Air Entering Evaporator – Ewb (F)								
		72	67	62	72	67	62	72	67	62
75	TC	30.9	32.0	31.9	30.7	33.5	34.3	34.8	31.8	27.6
	SHC	15.1	20.0	26.3	25.1	20.4	15.4	14.0	18.2	21.9
	kW	2.51	2.49	2.42	2.82	2.74	2.68	3.09	3.01	2.88
85	TC	32.8	28.4	23.4	18.7	23.8	29.3	24.5	18.8	13.6
	SHC	11.0	14.6	17.9	13.4	10.3	7.1	2.6	5.6	8.6
	kW	3.36	3.23	3.06	3.62	3.41	3.24	3.79	3.58	3.39
95	TC	31.3	32.0	31.9	30.7	33.5	34.3	34.8	31.8	27.6
	SHC	15.3	20.0	26.3	25.1	20.4	15.4	14.0	18.2	21.9
	kW	2.53	2.49	2.41	2.82	2.74	2.68	3.09	3.01	2.88
105	TC	32.8	28.4	23.4	18.7	23.8	29.3	24.5	18.8	13.6
	SHC	11.0	14.6	17.9	13.4	10.3	7.1	2.6	5.6	8.6
	kW	3.36	3.23	3.06	3.62	3.41	3.24	3.79	3.58	3.39
115	TC	31.3	32.0	31.9	30.7	33.5	34.3	34.8	31.8	27.6
	SHC	15.3	20.0	26.3	25.1	20.4	15.4	14.0	18.2	21.9
	kW	2.53	2.49	2.41	2.82	2.74	2.68	3.09	3.01	2.88

48KC*B04 (3 TONS) – UNIT WITH HUMIDI-MIZER SYSTEM IN HOT GAS REHEAT MODE										
TEMP (F) AIR ENT CONDENSER (Edb)		AIR ENTERING EVAPORATOR – Ewb (F)								
		75 Dry Bulb 62.5 Wet Bulb (50% Relative)			75 Dry Bulb 64 Wet Bulb (56% Relative)			75 Dry Bulb 65.3 Wet Bulb (60% Relative)		
		Air Entering Evaporator – Cfm								
		900	1200	1500	900	1200	1500	900	1200	1500
80	TC	12.26	13.13	13.65	13.53	14.48	15.00	14.73	15.63	16.20
	SHC	1.76	3.87	6.09	0.75	2.48	4.33	-0.06	1.30	2.81
	kW	1.92	1.93	1.94	1.96	1.98	2.00	2.00	2.01	2.02
75	TC	14.64	15.64	16.30	15.84	16.73	17.32	16.80	17.38	17.91
	SHC	3.87	6.09	8.38	2.88	4.59	6.29	2.03	3.14	4.39
	kW	1.87	1.88	1.88	1.89	1.90	1.91	1.91	1.92	1.93
70	TC	16.72	17.62	18.01	17.42	18.17	18.62	18.02	18.69	18.87
	SHC	5.89	7.85	9.40	4.65	6.08	7.35	3.71	5.09	5.59
	kW	1.78	1.80	1.82	1.81	1.83	1.84	1.82	1.82	1.86
60	TC	17.43	18.50	18.28	18.09	19.03	19.41	18.32	18.29	19.33
	SHC	7.75	10.06	9.51	7.08	8.34	9.60	6.29	6.94	7.88
	kW	1.66	1.62	1.70	1.67	1.69	1.68	1.69	1.70	1.71
50	TC	17.82	18.59	19.72	18.31	19.73	20.26	18.76	20.21	20.73
	SHC	6.40	7.99	10.05	4.79	6.71	7.97	3.40	5.11	6.16
	kW	1.98	2.03	1.94	2.01	1.94	1.97	2.03	1.96	1.99
40	TC	17.70	19.38	19.85	19.10	20.30	20.34	19.53	20.76	21.26
	SHC	6.30	8.74	10.17	5.54	7.26	8.05	4.13	5.64	6.67
	kW	2.07	1.95	1.99	1.93	1.91	2.02	1.96	1.94	1.97

**LEGEND**

- Edb – Entering Dry–Bulb
- Ewb – Entering Wet–Bulb
- kW – Compressor Motor Power Input
- ldb – Leaving Dry–Bulb
- lwb – Leaving Wet–Bulb
- SHC – Sensible Heat Capacity (1000 Btuh) Gross
- TC – Total Capacity (1000 Btuh) Gross

**NOTES:**

1. Direct interpolation is permissible. Do not extrapolate.
2. The following formulas may be used:
 
$$t_{ldb} = t_{edb} - \frac{\text{sensible capacity (Btuh)}}{1.10 \times \text{cfm}}$$

$$t_{lwb} = \text{Wet-bulb temperature corresponding to enthalpy of air leaving evaporator coil } (h_{lwb})$$

$$h_{lwb} = h_{ewb} - \frac{\text{total capacity (Btuh)}}{4.5 \times \text{cfm}}$$
 Where:  $h_{ewb}$  = Enthalpy of air entering evaporator coil

Table 12 – COOLING CAPACITIES

1-STAGE COOLING

4 TONS

48KC*A05				Ambient Temperature											
				85			95			105			115		
				EA (dB)			EA (dB)			EA (dB)			EA (dB)		
				75	80	85	75	80	85	75	80	85	75	80	85
1200 Cfm	EAT (wb)	58	TC	41.5	41.5	47.0	38.9	38.9	44.0	36.2	36.2	41.0	33.4	33.4	37.8
			SHC	36.1	41.5	47.0	33.8	38.9	44.0	31.4	36.2	41.0	28.9	33.4	37.8
		62	TC	44.9	44.9	44.9	41.4	41.4	42.6	37.8	37.8	40.8	34.0	34.0	38.8
			SHC	32.6	38.5	44.3	30.9	36.8	42.6	29.2	35.0	40.8	27.3	33.1	38.8
		67	TC	49.7	49.7	49.7	46.8	46.8	46.8	43.1	43.1	43.1	39.2	39.2	39.2
			SHC	26.5	32.4	38.2	25.3	31.1	37.0	23.7	29.6	35.5	22.1	27.9	33.8
		72	TC	53.4	53.4	53.4	51.3	51.3	51.3	48.5	48.5	48.5	44.7	44.7	44.7
			SHC	19.8	25.7	31.6	19.0	24.8	30.7	17.8	23.7	29.6	16.4	22.3	28.1
		76	TC	-	55.3	55.3	-	53.3	53.3	-	51.6	51.6	-	48.6	48.6
			SHC	-	20.1	26.7	-	19.4	26.0	-	18.7	25.3	-	17.5	23.8
1400 Cfm	EAT (wb)	58	TC	44.4	44.4	50.2	41.6	41.6	47.0	38.7	38.7	43.8	35.7	35.7	40.5
			SHC	38.6	44.4	50.2	36.1	41.6	47.0	33.6	38.7	43.8	31.0	35.7	40.5
		62	TC	46.6	46.6	48.6	43.1	43.1	46.9	39.4	39.4	44.9	35.8	35.8	42.1
			SHC	35.2	41.9	48.6	33.5	40.2	46.9	31.7	38.3	44.9	29.4	35.8	42.1
		67	TC	51.2	51.2	51.2	48.5	48.5	48.5	44.7	44.7	44.7	40.7	40.7	40.7
			SHC	28.0	34.6	41.2	26.9	33.6	40.3	25.4	32.2	38.9	23.8	30.6	37.3
		72	TC	54.4	54.4	54.4	52.3	52.3	52.3	49.9	49.9	49.9	46.2	46.2	46.2
			SHC	20.2	26.7	33.2	19.4	25.9	32.5	18.5	25.2	31.9	17.1	23.8	30.6
		76	TC	-	55.9	55.9	-	53.9	53.9	-	52.1	52.1	-	49.7	49.7
			SHC	-	20.8	28.5	-	20.0	27.6	-	19.2	26.5	-	18.1	25.3
1600 Cfm	EAT (wb)	58	TC	46.6	46.6	52.7	43.8	43.8	49.6	40.8	40.8	46.2	37.7	37.7	42.7
			SHC	40.5	46.6	52.7	38.1	43.8	49.6	35.4	40.8	46.2	32.7	37.7	42.7
		62	TC	47.9	47.9	52.3	44.6	44.6	50.7	40.9	40.9	48.1	37.8	37.8	44.4
			SHC	37.5	44.9	52.3	35.9	43.3	50.7	33.7	40.9	48.1	31.1	37.8	44.4
		67	TC	51.5	51.5	51.5	48.7	48.7	48.7	44.9	44.9	44.9	40.7	40.7	42.0
			SHC	30.9	38.3	45.7	30.0	37.5	45.0	28.5	36.1	43.7	26.9	34.5	42.0
		72	TC	55.0	55.0	55.0	52.9	52.9	52.9	50.9	50.9	50.9	47.3	47.3	47.3
			SHC	20.4	27.5	34.6	19.6	26.8	33.9	18.9	26.3	33.8	17.6	25.2	32.7
		76	TC	-	56.3	56.3	-	54.3	54.3	-	52.3	52.3	-	50.3	50.3
			SHC	-	21.1	29.4	-	20.2	28.3	-	19.4	27.3	-	18.6	26.5
1800 Cfm	EAT (wb)	58	TC	48.4	48.4	54.7	45.7	45.7	51.7	42.7	42.7	48.3	39.4	39.4	44.6
			SHC	42.1	48.4	54.7	39.7	45.7	51.7	37.0	42.7	48.3	34.2	39.4	44.6
		62	TC	49.1	49.1	55.6	45.9	45.9	53.7	42.7	42.7	50.2	39.5	39.5	46.4
			SHC	39.5	47.6	55.6	37.8	45.8	53.7	35.2	42.7	50.2	32.5	39.5	46.4
		67	TC	53.0	53.0	53.0	50.6	50.6	50.6	47.0	47.0	47.0	42.7	42.7	43.7
			SHC	30.2	38.2	46.1	29.5	37.7	45.8	28.5	36.8	45.2	26.9	35.3	43.7
		72	TC	55.5	55.5	55.5	53.4	53.4	53.4	51.5	51.5	51.5	48.1	48.1	48.1
			SHC	20.6	28.2	35.7	19.8	27.5	35.2	19.2	27.3	35.4	18.1	26.4	34.6
		76	TC	-	56.6	56.6	-	54.6	54.6	-	52.5	52.5	-	50.8	50.8
			SHC	-	21.2	29.9	-	20.4	28.9	-	19.6	28.0	-	18.9	27.4
2000 Cfm	EAT (wb)	58	TC	49.9	49.9	56.4	47.4	47.4	53.6	44.3	44.3	50.1	40.9	40.9	46.3
			SHC	43.4	49.9	56.4	41.2	47.4	53.6	38.4	44.3	50.1	35.5	40.9	46.3
		62	TC	50.1	50.1	58.3	47.5	47.5	55.7	44.3	44.3	52.1	41.0	41.0	48.2
			SHC	41.1	49.7	58.3	39.2	47.5	55.7	36.5	44.3	52.1	33.8	41.0	48.2
		67	TC	53.5	53.5	53.5	51.3	51.3	51.3	47.8	47.8	48.1	43.5	43.5	46.6
			SHC	31.2	39.7	48.3	30.6	39.4	48.1	29.9	39.0	48.1	28.3	37.5	46.6
		72	TC	55.8	55.8	55.8	53.7	53.7	53.7	51.9	51.9	51.9	48.8	48.8	48.8
			SHC	20.7	28.7	36.7	19.9	28.1	36.2	19.4	28.0	36.7	18.5	27.4	36.4
		76	TC	-	56.9	56.9	-	54.8	54.8	-	52.7	52.7	-	51.1	51.1
			SHC	-	21.3	30.4	-	20.5	29.4	-	19.7	28.6	-	19.1	28.2

LEGEND:

- Do not operate
- Cfm - Cubic feet per minute (supply air)
- EAT(db) - Entering air temperature (dry bulb)
- EAT(wb) - Entering air temperature (wet bulb)
- SHC - Sensible heat capacity
- TC - Total capacity

48KC



48KC

48KC*B05 (4 TONS) – UNIT WITH HUMIDI-MIZER SYSTEM IN SUBCOOLING MODE										
TEMP (F) AIR ENT CONDENSER (Edb)		AIR ENTERING EVAPORATOR – SCFM								
		1200			1600			2000		
		Air Entering Evaporator – Ewb (F)								
		72	67	62	72	67	62	72	67	62
75	TC	35.4	37.1	41.2	40.7	43.2	41.0	44.3	42.2	35.7
	SHC	16.4	21.6	31.5	31.3	24.3	16.9	16.0	22.4	26.9
	kW	3.06	3.07	3.06	3.44	3.43	3.41	3.84	3.82	3.72
85	TC	43.4	36.8	29.6	22.8	30.1	37.9	31.0	23.1	15.6
	SHC	13.0	17.6	21.5	15.5	11.7	7.8	2.0	5.7	9.2
	kW	4.28	4.20	4.05	4.77	4.57	4.42	5.17	4.99	4.81
95	TC	34.5	34.9	35.6	42.8	40.4	37.8	42.4	43.8	39.3
	SHC	16.3	20.9	27.7	36.7	23.8	16.2	16.4	26.1	34.3
	kW	3.25	3.25	3.24	3.63	3.63	3.61	4.04	4.02	4.00
105	TC	44.0	40.3	33.3	26.2	33.7	41.0	34.2	26.1	18.6
	SHC	15.1	22.9	28.9	22.6	17.2	11.1	5.0	10.6	15.8
	kW	4.49	4.47	4.32	4.99	4.87	4.69	5.50	5.28	5.09
115	TC	33.2	33.5	38.3	39.8	37.3	35.4	40.3	42.0	41.3
	SHC	15.6	20.3	31.2	34.7	22.3	15.3	15.9	26.2	39.6
	kW	3.53	3.51	3.46	3.89	3.89	3.88	4.31	4.30	4.26

48KC*B05 (4 TONS) – UNIT WITH HUMIDI-MIZER SYSTEM IN HOT GAS REHEAT MODE										
TEMP (F) AIR ENT CONDENSER (Edb)		AIR ENTERING EVAPORATOR – Ewb (F)								
		75 Dry Bulb 62.5 Wet Bulb (50% Relative)			75 Dry Bulb 64 Wet Bulb (56% Relative)			75 Dry Bulb 65.3 Wet Bulb (60% Relative)		
		Air Entering Evaporator – Cfm								
		1200	1600	2000	1200	1600	2000	1200	1600	2000
80	TC	15.33	16.26	16.40	17.32	18.21	18.24	18.97	19.72	19.66
	SHC	0.84	3.06	4.94	-0.09	1.62	2.93	-0.90	0.33	1.18
	kW	2.41	2.42	2.42	2.43	2.43	2.43	2.44	2.44	2.44
75	TC	19.17	20.36	20.57	20.97	21.94	21.95	22.30	23.03	22.88
	SHC	4.46	6.89	8.60	3.50	5.31	6.45	2.61	3.93	4.64
	kW	2.76	2.75	2.75	2.76	2.75	2.74	2.76	2.76	2.75
70	TC	22.63	23.67	23.55	23.97	24.55	24.19	24.87	25.09	24.52
	SHC	7.91	10.13	11.21	6.83	8.40	9.04	5.88	7.04	7.39
	kW	2.80	2.78	2.77	2.80	2.77	2.76	2.81	2.80	2.78
60	TC	27.32	28.34	21.46	27.68	16.17	25.05	28.38	18.51	20.56
	SHC	13.66	15.45	13.04	11.75	4.46	12.58	11.21	10.82	10.87
	kW	2.85	2.86	2.86	2.89	2.80	2.91	2.88	2.84	2.88
50	TC	11.00	11.31	12.76	14.48	13.83	13.72	15.32	15.18	17.14
	SHC	7.10	9.20	11.20	5.13	6.46	9.10	4.21	4.49	6.19
	kW	2.95	2.94	2.93	2.94	2.92	2.92	2.94	2.93	2.92
40	TC	9.73	9.83	9.75	12.40	12.60	12.20	15.23	15.45	15.13
	SHC	8.46	9.50	9.20	7.57	8.47	9.50	7.64	8.14	8.80
	kW	3.04	3.04	3.03	3.03	3.01	3.01	3.03	3.02	3.02

**LEGEND**

- Edb – Entering Dry–Bulb
- Ewb – Entering Wet–Bulb
- kW – Compressor Motor Power Input
- ldb – Leaving Dry–Bulb
- lwb – Leaving Wet–Bulb
- SHC – Sensible Heat Capacity (1000 Btuh) Gross
- TC – Total Capacity (1000 Btuh) Gross

**NOTES:**

1. Direct interpolation is permissible. Do not extrapolate.
2. The following formulas may be used:
 
$$t_{ldb} = t_{edb} - \frac{\text{sensible capacity (Btuh)}}{1.10 \times \text{cfm}}$$

$$t_{lwb} = \text{Wet-bulb temperature corresponding to enthalpy of air leaving evaporator coil } (h_{lwb})$$

$$h_{lwb} = h_{ewb} - \frac{\text{total capacity (Btuh)}}{4.5 \times \text{cfm}}$$
 Where:  $h_{ewb}$  = Enthalpy of air entering evaporator coil

Table 14 – COOLING CAPACITIES

1-STAGE COOLING

5 TONS

48KC*A06				Ambient Temperature											
				85			95			105			115		
				EA (dB)			EA (dB)			EA (dB)			EA (dB)		
				75	80	85	75	80	85	75	80	85	75	80	85
1500 Cfm	EAT (wb)	58	TC	53.0	53.0	60.2	50.0	50.0	56.8	46.9	46.9	53.4	44.4	44.4	50.4
			SHC	45.9	53.0	60.2	43.1	50.0	56.8	40.3	46.9	53.4	38.4	44.4	50.4
		62	TC	56.0	56.0	57.5	52.2	52.2	55.4	48.2	48.2	53.3	44.7	44.7	52.1
			SHC	41.4	49.5	57.5	39.3	47.4	55.4	37.2	45.2	53.3	36.2	44.2	52.1
		67	TC	62.4	62.4	62.4	58.8	58.8	58.8	54.8	54.8	54.8	51.0	51.0	51.0
			SHC	33.5	41.4	49.4	31.7	39.7	47.7	29.6	37.7	45.7	28.6	36.6	44.6
		72	TC	67.5	67.5	67.5	64.3	64.3	64.3	60.7	60.7	60.7	55.4	55.4	55.4
			SHC	25.0	32.4	39.8	23.3	31.0	38.6	21.5	29.3	37.0	19.8	27.2	34.7
		76	TC	-	71.1	71.1	-	68.3	68.3	-	64.8	64.8	-	58.4	58.4
			SHC	-	25.6	32.7	-	24.2	31.3	-	22.5	29.9	-	20.3	27.7
1750 Cfm	EAT (wb)	58	TC	56.7	56.7	64.3	53.5	53.5	60.8	50.2	50.2	57.2	47.4	47.4	53.9
			SHC	49.1	56.7	64.3	46.2	53.5	60.8	43.3	50.2	57.2	41.0	47.4	53.9
		62	TC	58.3	58.3	63.9	54.4	54.4	61.8	51.8	51.8	56.4	47.5	47.5	56.1
			SHC	45.3	54.6	63.9	43.2	52.5	61.8	39.6	48.0	56.4	38.9	47.5	56.1
		67	TC	64.0	64.0	64.0	60.6	60.6	60.6	56.6	56.6	56.6	52.3	52.3	52.3
			SHC	35.5	44.5	53.6	33.9	43.1	52.4	32.0	41.3	50.6	30.6	39.7	48.8
		72	TC	68.9	68.9	68.9	65.9	65.9	65.9	62.2	62.2	62.2	56.6	56.6	56.6
			SHC	25.5	33.9	42.2	24.0	32.7	41.4	22.2	31.1	40.1	20.2	28.7	37.1
		76	TC	-	72.4	72.4	-	69.7	69.7	-	66.1	66.1	-	59.5	59.5
			SHC	-	26.4	34.9	-	24.9	33.2	-	23.2	31.7	-	21.0	29.5
2000 Cfm	EAT (wb)	58	TC	59.8	59.8	67.8	56.5	56.5	64.2	53.1	53.1	60.4	50.0	50.0	56.8
			SHC	51.8	59.8	67.8	48.9	56.5	64.2	45.8	53.1	60.4	43.3	50.0	56.8
		62	TC	60.2	60.2	69.7	57.0	57.0	66.0	53.2	53.2	62.9	50.1	50.1	59.2
			SHC	48.8	59.3	69.7	46.1	56.0	66.0	43.4	53.2	62.9	41.1	50.1	59.2
		67	TC	65.3	65.3	65.3	61.8	61.8	61.8	56.7	56.7	57.6	52.4	52.4	55.7
			SHC	37.3	47.4	57.4	35.9	46.2	56.6	36.4	47.0	57.6	34.9	45.3	55.7
		72	TC	70.2	70.2	70.2	67.0	67.0	67.0	63.2	63.2	63.2	57.3	57.3	57.3
			SHC	26.1	35.4	44.8	24.5	34.1	43.7	22.8	32.7	42.6	20.6	30.1	39.5
		76	TC	-	73.4	73.4	-	70.6	70.6	-	67.1	67.1	-	60.3	60.3
			SHC	-	27.0	36.5	-	25.5	35.0	-	23.8	33.3	-	21.5	31.0
2250 Cfm	EAT (wb)	58	TC	62.2	62.2	70.5	59.0	59.0	66.9	55.5	55.5	63.0	52.1	52.1	59.1
			SHC	54.0	62.2	70.5	51.1	59.0	66.9	47.9	55.5	63.0	45.0	52.1	59.1
		62	TC	63.4	63.4	70.9	59.1	59.1	69.7	55.5	55.5	65.6	52.1	52.1	61.5
			SHC	50.2	60.5	70.9	48.5	59.1	69.7	45.4	55.5	65.6	42.7	52.1	61.5
		67	TC	66.3	66.3	66.3	62.4	62.4	62.4	58.9	58.9	59.6	54.1	54.1	56.3
			SHC	38.9	50.0	61.0	39.2	50.8	62.3	36.2	47.9	59.6	34.0	45.2	56.3
		72	TC	71.1	71.1	71.1	68.0	68.0	68.0	64.1	64.1	64.1	57.9	57.9	57.9
			SHC	26.5	36.8	47.1	25.0	35.5	46.1	23.3	34.1	45.0	21.0	31.3	41.7
		76	TC	-	74.0	74.0	-	71.4	71.4	-	67.8	67.8	-	61.0	61.0
			SHC	-	27.3	37.6	-	26.0	36.5	-	24.3	34.9	-	21.8	32.2
2500 Cfm	EAT (wb)	58	TC	64.0	64.0	72.4	60.9	60.9	69.1	57.4	57.4	65.2	53.3	53.3	60.5
			SHC	55.5	64.0	72.4	52.8	60.9	69.1	49.6	57.4	65.2	46.1	53.3	60.5
		62	TC	64.0	64.0	75.3	61.0	61.0	71.9	57.4	57.4	67.9	53.4	53.4	63.0
			SHC	52.7	64.0	75.3	50.1	61.0	71.9	47.0	57.4	67.9	43.8	53.4	63.0
		67	TC	67.3	67.3	67.3	63.7	63.7	64.5	59.5	59.5	64.2	54.6	54.6	59.3
			SHC	40.6	52.5	64.5	39.6	52.0	64.5	38.7	51.5	64.2	35.4	47.3	59.3
		72	TC	71.7	71.7	71.7	68.8	68.8	68.8	64.9	64.9	64.9	58.4	58.4	58.4
			SHC	26.7	37.9	49.1	25.4	37.0	48.5	23.7	35.5	47.3	21.2	32.4	43.6
		76	TC	-	74.5	74.5	-	72.1	72.1	-	68.4	68.4	-	61.6	61.6
			SHC	-	27.4	38.5	-	26.3	37.7	-	24.7	36.3	-	22.1	33.3

48KC



LEGEND:

- Do not operate
- Cfm - Cubic feet per minute (supply air)
- EAT(db) - Entering air temperature (dry bulb)
- EAT(wb) - Entering air temperature (wet bulb)
- SHC - Sensible heat capacity
- TC - Total capacity

48KC

48KC*B06 (5 TONS) – UNIT WITH HUMIDI-MIZER SYSTEM IN SUBCOOLING MODE										
TEMP (F) AIR ENT CONDENSER (Edb)		AIR ENTERING EVAPORATOR – SCFM								
		1750			2000			2250		
		Air Entering Evaporator – Ewb (F)								
		72	67	62	72	67	62	72	67	62
75	TC	51.1	56.4	57.9	47.8	49.9	57.3	49.6	48.9	53.8
	SHC	25.5	36.1	50.4	24.6	31.3	50.3	25.8	32.0	44.8
	kW	3.20	3.30	3.19	3.25	3.18	3.13	3.22	3.13	3.25
85	TC	54.1	60.4	61.0	56.4	60.4	60.5	56.7	60.7	58.2
	SHC	47.2	38.7	28.0	52.3	40.6	28.8	27.2	42.6	56.5
	kW	3.59	3.67	3.79	3.81	3.70	3.60	3.70	3.74	3.61
95	TC	62.4	56.6	48.4	62.7	58.6	50.5	62.8	60.0	52.6
	SHC	26.3	34.9	41.9	27.8	38.7	46.9	29.0	42.1	51.5
	kW	4.20	4.09	3.92	3.97	4.10	4.25	4.28	4.12	4.03
105	TC	58.8	49.9	41.6	60.5	51.9	43.6	61.6	53.5	47.6
	SHC	22.0	29.0	35.8	24.4	32.9	40.7	26.5	36.6	42.3
	kW	4.64	4.46	4.28	4.33	4.52	4.66	4.69	4.57	4.41
115	TC	51.4	41.9	33.8	53.3	43.7	35.9	54.7	45.3	39.2
	SHC	15.7	22.2	29.0	18.1	26.0	33.9	20.4	29.7	35.3
	kW	5.08	4.83	4.63	4.69	4.88	5.14	5.19	4.92	4.77

48KC*B06 (5 TONS) – UNIT WITH HUMIDI-MIZER SYSTEM IN HOT GAS REHEAT MODE										
TEMP (F) AIR ENT CONDENSER (Edb)		AIR ENTERING EVAPORATOR – Ewb (F)								
		75 Dry Bulb 62.5 Wet Bulb (50% Relative)			75 Dry Bulb 64 Wet Bulb (56% Relative)			75 Dry Bulb 65.3 Wet Bulb (60% Relative)		
		Air Entering Evaporator – Cfm								
		1750	2000	2250	1750	2000	2250	1750	2000	2250
80	TC	13.19	12.95	12.70	14.56	14.30	14.00	15.70	15.44	15.05
	SHC	-2.38	-1.55	-0.65	-4.75	-4.25	-3.69	-6.74	-6.49	-6.21
	kW	3.15	3.16	3.16	3.19	3.20	3.20	3.22	3.23	3.23
75	TC	16.14	15.95	15.71	17.36	17.20	16.84	18.30	18.20	17.81
	SHC	0.44	1.23	2.03	-1.92	-1.36	-0.96	-3.90	-3.50	-3.31
	kW	3.04	3.05	3.06	3.07	3.08	3.09	3.10	3.12	3.12
70	TC	18.90	18.68	18.52	19.97	19.85	19.50	20.86	20.62	20.17
	SHC	3.13	3.80	4.51	0.85	1.39	1.70	-0.97	-0.69	-0.63
	kW	2.92	2.93	2.95	2.96	2.97	2.98	2.98	2.99	3.00
60	TC	23.71	23.48	23.16	24.05	23.98	23.52	24.79	24.47	26.99
	SHC	8.11	8.63	8.88	5.97	6.46	6.58	4.65	4.87	5.94
	kW	3.17	3.23	3.15	3.21	3.26	3.18	3.23	3.12	3.10
50	TC	21.91	16.69	16.62	16.81	16.98	16.92	17.08	17.24	17.17
	SHC	11.51	10.04	9.64	9.77	9.43	8.95	9.30	8.88	8.35
	kW	3.01	3.07	3.11	3.04	3.10	3.15	3.07	3.14	3.18
40	TC	21.91	16.69	16.62	16.81	16.98	16.92	17.08	17.24	17.17
	SHC	11.51	10.04	9.64	9.77	9.43	8.95	9.30	8.88	8.35
	kW	3.39	3.32	3.24	3.14	3.23	3.15	3.18	3.27	3.08

**LEGEND**

- Edb – Entering Dry–Bulb
- Ewb – Entering Wet–Bulb
- kW – Compressor Motor Power Input
- ldb – Leaving Dry–Bulb
- lwb – Leaving Wet–Bulb
- SHC – Sensible Heat Capacity (1000 Btuh) Gross
- TC – Total Capacity (1000 Btuh) Gross

**NOTES:**

1. Direct interpolation is permissible. Do not extrapolate.
2. The following formulas may be used:
 
$$t_{ldb} = t_{edb} - \frac{\text{sensible capacity (Btuh)}}{1.10 \times \text{cfm}}$$

$$t_{lwb} = \text{Wet-bulb temperature corresponding to enthalpy of air leaving evaporator coil } (h_{lwb})$$

$$h_{lwb} = h_{ewb} - \frac{\text{total capacity (Btuh)}}{4.5 \times \text{cfm}}$$
 Where:  $h_{ewb}$  = Enthalpy of air entering evaporator coil



**Table 16 – STATIC PRESSURE ADDERS (IN. WG) (FACTORY OPTIONS AND/OR ACCESSORIES)**

<b>3-5-TONS</b>									
<b>CFM</b>	600	800	1000	1250	1500	1750	2000	2250	2500
<b>Vertical Economizer</b>	0.012	0.020	0.030	0.046	0.066	0.089	0.115	0.145	0.179
<b>Horizontal Economizer</b>	0.018	0.026	0.037	0.053	0.073	0.096	0.124	0.154	0.189

All above data for both standard and ultra low leak models, where available.

<b>3-5-TONS</b>									
<b>CFM</b>	600	800	1000	1250	1500	1750	2000	2250	2500
<b>Humidi-MiZer</b>	0.023	0.033	0.042	0.054	0.067	0.080	0.093	0.106	0.120

<b>3-5-TONS</b>						
<b>Power Exhaust Performance</b>						
<b>Return Duct Static Pressure (in wg)</b>	0.0	0.1	0.2	0.3	0.4	0.5
<b>Vertical Power Exhaust CFM</b>	3239	2974	2642	2244	1780	1249

**Table 17 – STATIC PRESSURE DEDUCTIONS (IN. WG) (GAS HEAT OPTIONS)**

<b>3-5-TONS</b>									
<b>CFM</b>	600	800	1000	1250	1500	1750	2000	2250	2500
<b>Medium Gas Heat Deduction</b>	0.005	0.009	0.014	0.023	0.034	0.046	0.061	0.077	0.096
<b>Low Gas Heat Deduction</b>	0.012	0.023	0.037	0.060	0.088	0.122	0.161	0.206	0.256

**48KC**

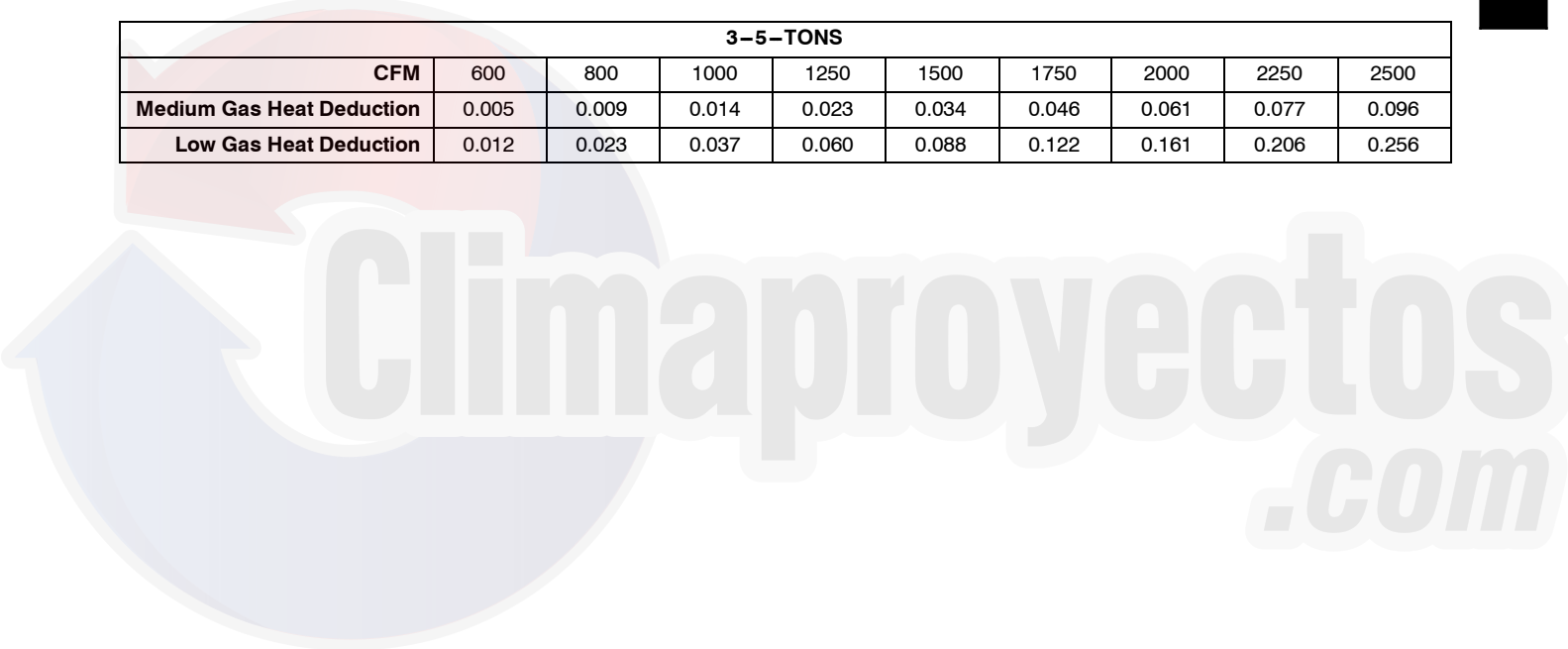

## GENERAL FAN PERFORMANCE NOTES

1. Interpolation is permissible. Do not extrapolate.
2. External static pressure is the static pressure difference between the return duct and the supply duct plus the static pressure caused by any FIOPs or accessories.
3. Tabular data accounts for pressure loss due to clean filters, unit casing, and wet coils. Factory options and accessories may add static pressure losses. Selection software is available, through your salesperson, to help you select the best motor/drive combination for your application.
4. The Fan Performance tables offer motor/drive recommendations. In cases when two motor/drive combinations would work, Carrier recommended the lower horsepower option.
5. For information on the electrical properties of Carrier motors, please see the Electrical information section of this book.
6. For more information on the performance limits of Carrier motors, see the application data section of this book.
7. The EPACT (Energy Policy Act of 1992) regulates energy requirements for specific types of indoor fan motors. Motors regulated by EPACT include any general purpose, T-frame (three-digit, 143 and larger), single-speed, foot mounted, polyphase, squirrel cage induction motors of NEMA (National Electrical Manufacturers Association) design A and B, manufactured for use in the United States. Ranging from 1 to 200 Hp, these continuous-duty motors operate on 230 and 460 volt, 60 Hz power. If a motor does not fit into these specifications, the motor does not have to be replaced by an EPACT compliant energy efficient motor. Variable speed motors are exempt from EPACT compliance requirements. Therefore, the indoor fan motors for Carrier 48KC\*\*04-06 units are exempt from these requirements.

48KC



## FAN PERFORMANCE (DIRECT DRIVE)

**Table 18 – 48KC\*04 Vertical Unit - Direct Drive**

Speed (Torque) tap	CFM	ESP	BHP
1	900	0.28	0.18
	975	0.16	0.17
	1050	0.05	0.15
	1125	-	-
	1200	-	-
	1275	-	-
	1350	-	-
	1425	-	-
	1500	-	-
2	900	0.34	0.20
	975	0.21	0.19
	1050	0.09	0.17
	1125	-	-
	1200	-	-
	1275	-	-
	1350	-	-
	1425	-	-
	1500	-	-
3	900	0.48	0.25
	975	0.34	0.23
	1050	0.20	0.22
	1125	0.07	0.20
	1200	-	-
	1275	-	-
	1350	-	-
	1425	-	-
	1500	-	-
4	900	1.06	0.46
	975	0.98	0.48
	1050	0.90	0.50
	1125	0.82	0.52
	1200	0.72	0.54
	1275	0.61	0.53
	1350	0.49	0.53
	1425	0.37	0.53
	1500	0.24	0.53
5	900	1.10	0.47
	975	1.02	0.49
	1050	0.93	0.51
	1125	0.85	0.54
	1200	0.81	0.56
	1275	0.74	0.58
	1350	0.67	0.61
	1425	0.60	0.63
	1500	0.52	0.66

**Table 19 – 48KC\*04 Horizontal Unit - Direct Drive**

Speed (Torque) tap	CFM	ESP	BHP
1	900	0.44	0.22
	975	0.32	0.21
	1050	0.21	0.20
	1125	0.11	0.18
	1200	0.04	0.16
	1275	-	-
	1350	-	-
	1425	-	-
	1500	-	-
2	900	0.50	0.25
	975	0.38	0.23
	1050	0.26	0.22
	1125	0.16	0.20
	1200	0.07	0.19
	1275	0.00	0.16
	1350	-	-
	1425	-	-
	1500	-	-
3	900	0.66	0.30
	975	0.52	0.28
	1050	0.39	0.27
	1125	0.27	0.26
	1200	0.16	0.24
	1275	0.05	0.24
	1350	-	-
	1425	-	-
	1500	-	-
4	900	1.17	0.48
	975	1.10	0.49
	1050	1.04	0.51
	1125	0.97	0.53
	1200	0.89	0.55
	1275	0.81	0.56
	1350	0.72	0.57
	1425	0.62	0.58
	1500	0.52	0.58
5	900	1.20	0.49
	975	1.14	0.51
	1050	1.04	0.53
	1125	0.97	0.55
	1200	0.95	0.57
	1275	0.90	0.60
	1350	0.84	0.62
	1425	0.78	0.65
	1500	0.72	0.68

48KC

## FAN PERFORMANCE (DIRECT DRIVE) (cont.)

**Table 20 – 48KC\*05 Vertical Unit - Direct Drive**

Speed (Torque) tap	CFM	ESP	BHP
1	1200	0.35	0.36
	1300	0.17	0.34
	1400	0.01	0.32
	1500	–	–
	1600	–	–
	1700	–	–
	1800	–	–
	1900	–	–
	2000	–	–
2	1200	0.47	0.42
	1300	0.28	0.39
	1400	0.10	0.36
	1500	–	–
	1600	–	–
	1700	–	–
	1800	–	–
	1900	–	–
	2000	–	–
3	1200	0.77	0.55
	1300	0.66	0.58
	1400	0.54	0.60
	1500	0.40	0.61
	1600	0.25	0.60
	1700	0.07	0.60
	1800	–	–
	1900	–	–
	2000	–	–
4	1200	0.78	0.55
	1300	0.68	0.58
	1400	0.58	0.61
	1500	0.46	0.64
	1600	0.35	0.66
	1700	0.22	0.68
	1800	0.09	0.70
	1900	–	–
	2000	–	–
5	1200	0.81	0.56
	1300	0.72	0.59
	1400	0.66	0.62
	1500	0.55	0.66
	1600	0.41	0.69
	1700	0.29	0.73
	1800	0.17	0.76
	1900	0.05	0.80
	2000	–	0.83

**Table 21 – 48KC\*05 Horizontal Unit - Direct Drive**

Speed (Torque) tap	CFM	ESP	BHP
1	1200	0.57	0.41
	1300	0.40	0.39
	1400	0.24	0.37
	1500	0.08	0.35
	1600	–	–
	1700	–	–
	1800	–	–
	1900	–	–
	2000	–	–
2	1200	0.69	0.46
	1300	0.52	0.45
	1400	0.36	0.43
	1500	0.18	0.40
	1600	0.00	0.39
	1700	–	–
	1800	–	–
	1900	–	–
	2000	–	–
3	1200	0.91	0.56
	1300	0.83	0.59
	1400	0.74	0.62
	1500	0.64	0.64
	1600	0.52	0.66
	1700	0.39	0.66
	1800	0.22	0.63
	1900	0.03	0.62
	2000	–	–
4	1200	0.92	0.56
	1300	0.83	0.60
	1400	0.75	0.63
	1500	0.67	0.66
	1600	0.58	0.69
	1700	0.49	0.72
	1800	0.39	0.74
	1900	0.26	0.76
	2000	0.12	0.76
5	1200	0.95	0.57
	1300	0.88	0.61
	1400	0.80	0.64
	1500	0.72	0.68
	1600	0.64	0.71
	1700	0.55	0.75
	1800	0.46	0.79
	1900	0.37	0.83
	2000	0.27	0.87

48KC

## FAN PERFORMANCE (DIRECT DRIVE) (cont.)

**Table 22 – 48KC\*06 Vertical Unit - Direct Drive**

Speed (Torque) tap	CFM	ESP	BHP
1	1500	0.24	0.43
	1625	0.05	0.41
	1750	-	-
	1875	-	-
	2000	-	-
	2125	-	-
	2250	-	-
	2375	-	-
	2500	-	-
2	1500	0.44	0.54
	1625	0.21	0.52
	1750	0.05	0.50
	1875	-	-
	2000	-	-
	2125	-	-
	2250	-	-
	2375	-	-
	2500	-	-
3	1500	0.89	0.81
	1625	0.69	0.80
	1750	0.48	0.78
	1875	0.26	0.75
	2000	0.06	0.73
	2125	-	-
	2250	-	-
	2375	-	-
	2500	-	-
4	1500	0.97	0.85
	1625	0.81	0.88
	1750	0.65	0.91
	1875	0.47	0.87
	2000	0.29	0.89
	2125	0.09	0.86
	2250	-	-
	2375	-	-
	2500	-	-
5	1500	1.00	0.87
	1625	0.86	0.91
	1750	0.77	0.95
	1875	0.65	0.98
	2000	0.41	1.01
	2125	0.25	0.88
	2250	0.06	1.01
	2375	-	-
	2500	-	-

**Table 23 – 48KC\*06 Horizontal Unit - Direct Drive**

Speed (Torque) tap	CFM	ESP	BHP
1	1500	0.36	0.48
	1625	0.17	0.45
	1750	0.01	0.43
	1875	-	-
	2000	-	-
	2125	-	-
	2250	-	-
	2375	-	-
	2500	-	-
2	1500	0.57	0.60
	1625	0.35	0.57
	1750	0.15	0.54
	1875	0.02	0.51
	2000	-	-
	2125	-	-
	2250	-	-
	2375	-	-
	2500	-	-
3	1500	1.02	0.86
	1625	0.85	0.87
	1750	0.65	0.85
	1875	0.44	0.82
	2000	0.23	0.80
	2125	0.02	0.80
	2250	-	-
	2375	-	-
	2500	-	-
4	1500	1.09	0.90
	1625	0.95	0.93
	1750	0.80	0.97
	1875	0.62	0.92
	2000	0.43	0.97
	2125	0.23	0.93
	2250	0.00	0.91
	2375	-	-
	2500	-	-
5	1500	1.12	0.92
	1625	1.00	0.96
	1750	0.86	1.00
	1875	0.72	1.04
	2000	0.56	1.08
	2125	0.39	0.95
	2250	0.19	1.09
	2375	-	-
	2500	-	-

48KC

# FAN PERFORMANCE (BELT DRIVE) (cont.)

Table 24 – 48KC\*\*04

1 PHASE

3 TON VERTICAL SUPPLY

CFM	AVAILABLE EXTERNAL STATIC PRESSURE (in. wg)									
	0.2		0.4		0.6		0.8		1.0	
	RPM	BHP	RPM	BHP	RPM	BHP	RPM	BHP	RPM	BHP
900	<b>592</b>	<b>0.14</b>	<b>721</b>	<b>0.25</b>	826	0.38	916	0.53	997	0.69
975	<b>616</b>	<b>0.17</b>	<b>744</b>	<b>0.28</b>	847	0.41	936	0.56	1016	0.72
1050	<b>641</b>	<b>0.19</b>	<b>766</b>	<b>0.30</b>	868	0.44	957	0.59	1036	0.76
1125	<b>667</b>	<b>0.22</b>	790	0.33	890	0.47	978	0.63	1056	0.80
1200	<b>693</b>	<b>0.25</b>	813	0.37	913	0.51	999	0.67	1077	0.84
1275	<b>720</b>	<b>0.29</b>	837	0.41	935	0.55	1021	0.71	1098	0.88
1350	<b>747</b>	<b>0.33</b>	862	0.45	958	0.60	1043	0.76	1119	0.94
1425	775	0.37	887	0.50	982	0.65	1066	0.81	1141	0.99
1500	802	0.42	912	0.55	1006	0.70	1088	0.87	1163	1.05

CFM	AVAILABLE EXTERNAL STATIC PRESSURE (in. wg)									
	1.2		1.4		1.6		1.8		2.0	
	RPM	BHP	RPM	BHP	RPM	BHP	RPM	BHP	RPM	BHP
900	1070	0.88	1137	1.07	1201	1.29	-	-	-	-
975	1089	0.91	1156	1.11	1219	1.32	-	-	-	-
1050	1108	0.94	1175	1.14	1238	1.36	-	-	-	-
1125	1128	0.98	1195	1.18	1257	1.40	-	-	-	-
1200	1148	1.03	1214	1.23	1276	1.44	-	-	-	-
1275	1169	1.07	1235	1.28	1296	1.50	-	-	-	-
1350	1190	1.13	1255	1.33	-	-	-	-	-	-
1425	1211	1.19	1276	1.39	-	-	-	-	-	-
1500	1232	1.25	1297	1.46	-	-	-	-	-	-

**NOTE:** For more information, see General Fan Performance Notes.  
**Boldface** indicates field-supplied drive is required.

Medium static 770–1175 RPM, 1.2 BHP max  
 High static 1035–1466 RPM, 1.5 BHP max

Table 25 – 48KC\*\*04

1 PHASE

3 TON HORIZONTAL SUPPLY

CFM	AVAILABLE EXTERNAL STATIC PRESSURE (in. wg)									
	0.2		0.4		0.6		0.8		1.0	
	RPM	BHP	RPM	BHP	RPM	BHP	RPM	BHP	RPM	BHP
900	<b>582</b>	<b>0.14</b>	<b>715</b>	<b>0.24</b>	825	0.35	921	0.48	1007	0.63
975	<b>606</b>	<b>0.16</b>	<b>735</b>	<b>0.26</b>	843	0.38	938	0.51	1023	0.66
1050	<b>630</b>	<b>0.18</b>	<b>756</b>	<b>0.29</b>	862	0.41	955	0.55	1040	0.70
1125	<b>655</b>	<b>0.21</b>	778	0.32	882	0.45	974	0.58	1057	0.74
1200	<b>681</b>	<b>0.24</b>	800	0.35	902	0.48	992	0.63	1074	0.78
1275	<b>708</b>	<b>0.27</b>	823	0.39	923	0.53	1012	0.67	1093	0.83
1350	<b>735</b>	<b>0.31</b>	847	0.43	945	0.57	1032	0.72	1112	0.88
1425	<b>762</b>	<b>0.35</b>	871	0.48	967	0.62	1053	0.77	1131	0.94
1500	790	0.40	896	0.53	990	0.67	1074	0.83	1151	1.00

CFM	AVAILABLE EXTERNAL STATIC PRESSURE (in. wg)									
	1.2		1.4		1.6		1.8		2.0	
	RPM	BHP	RPM	BHP	RPM	BHP	RPM	BHP	RPM	BHP
900	1086	0.79	1159	0.96	1228	1.14	1293	1.33	-	-
975	1101	0.82	1174	0.99	1242	1.18	1306	1.37	-	-
1050	1117	0.86	1189	1.03	1256	1.22	1320	1.41	-	-
1125	1133	0.90	1204	1.08	1271	1.26	1335	1.46	-	-
1200	1150	0.95	1221	1.13	1287	1.31	-	-	-	-
1275	1168	1.00	1237	1.18	1303	1.37	-	-	-	-
1350	1186	1.05	1255	1.24	1320	1.43	-	-	-	-
1425	1204	1.11	1272	1.30	1337	1.49	-	-	-	-
1500	1223	1.18	1291	1.36	-	-	-	-	-	-

**NOTE:** For more information, see General Fan Performance Notes.  
**Boldface** indicates field-supplied drive is required.

Medium static 770–1175 RPM, 1.2 BHP max  
 High static 1035–1466 RPM, 1.5 BHP max

48KC



## FAN PERFORMANCE (BELT DRIVE) (cont.)

Table 26 – 48KC\*\*04

3 PHASE

3 TON VERTICAL SUPPLY

CFM	AVAILABLE EXTERNAL STATIC PRESSURE (in. wg)									
	0.2		0.4		0.6		0.8		1.0	
	RPM	BHP	RPM	BHP	RPM	BHP	RPM	BHP	RPM	BHP
900	<b>592</b>	<b>0.14</b>	<b>721</b>	<b>0.25</b>	826	0.38	916	0.53	997	0.69
975	<b>616</b>	<b>0.17</b>	<b>744</b>	<b>0.28</b>	847	0.41	936	0.56	1016	0.72
1050	<b>641</b>	<b>0.19</b>	<b>766</b>	<b>0.30</b>	868	0.44	957	0.59	1036	0.76
1125	<b>667</b>	<b>0.22</b>	790	0.33	890	0.47	978	0.63	1056	0.80
1200	<b>693</b>	<b>0.25</b>	813	0.37	913	0.51	999	0.67	1077	0.84
1275	<b>720</b>	<b>0.29</b>	837	0.41	935	0.55	1021	0.71	1098	0.88
1350	<b>747</b>	<b>0.33</b>	862	0.45	958	0.60	1043	0.76	1119	0.94
1425	<b>775</b>	<b>0.37</b>	887	0.50	982	0.65	1066	0.81	1141	0.99
1500	802	0.42	912	0.55	1006	0.70	1088	0.87	1163	1.05

CFM	AVAILABLE EXTERNAL STATIC PRESSURE (in. wg)									
	1.2		1.4		1.6		1.8		2.0	
	RPM	BHP	RPM	BHP	RPM	BHP	RPM	BHP	RPM	BHP
900	1070	0.88	1137	1.07	1201	1.29	1260	1.51	1317	1.75
975	1089	0.91	1156	1.11	1219	1.32	1279	1.54	1335	1.78
1050	1108	0.94	1175	1.14	1238	1.36	1297	1.58	1353	1.82
1125	1128	0.98	1195	1.18	1257	1.40	1316	1.62	1372	1.86
1200	1148	1.03	1214	1.23	1276	1.44	1335	1.67	1391	1.91
1275	1169	1.07	1235	1.28	1296	1.50	1354	1.72	1410	1.97
1350	1190	1.13	1255	1.33	1316	1.55	1374	1.78	1429	2.03
1425	1211	1.19	1276	1.39	1337	1.61	1394	1.85	1449	2.09
1500	1232	1.25	1297	1.46	1357	1.68	1415	1.91	<b>1469</b>	<b>2.16</b>

**NOTE:** For more information, see General Fan Performance Notes.  
**Boldface** indicates field – supplied drive is required.

Medium static 770 – 1175 RPM, 1.7 BHP max  
 High static 1035 – 1466 RPM, 2.9 BHP max

48KC

Table 27 – 48KC\*\*04

3 PHASE

3 TON HORIZONTAL SUPPLY

CFM	AVAILABLE EXTERNAL STATIC PRESSURE (in. wg)									
	0.2		0.4		0.6		0.8		1.0	
	RPM	BHP	RPM	BHP	RPM	BHP	RPM	BHP	RPM	BHP
900	<b>582</b>	<b>0.14</b>	<b>715</b>	<b>0.24</b>	825	0.35	921	0.48	1007	0.63
975	<b>606</b>	<b>0.16</b>	<b>735</b>	<b>0.26</b>	843	0.38	938	0.51	1023	0.66
1050	<b>630</b>	<b>0.18</b>	<b>756</b>	<b>0.29</b>	862	0.41	955	0.55	1040	0.70
1125	<b>655</b>	<b>0.21</b>	778	0.32	882	0.45	974	0.58	1057	0.74
1200	<b>681</b>	<b>0.24</b>	800	0.35	902	0.48	992	0.63	1074	0.78
1275	<b>708</b>	<b>0.27</b>	823	0.39	923	0.53	1012	0.67	1093	0.83
1350	<b>735</b>	<b>0.31</b>	847	0.43	945	0.57	1032	0.72	1112	0.88
1425	<b>762</b>	<b>0.35</b>	871	0.48	967	0.62	1053	0.77	1131	0.94
1500	790	0.40	896	0.53	990	0.67	1074	0.83	1151	1.00

CFM	AVAILABLE EXTERNAL STATIC PRESSURE (in. wg)									
	1.2		1.4		1.6		1.8		2.0	
	RPM	BHP	RPM	BHP	RPM	BHP	RPM	BHP	RPM	BHP
900	1086	0.79	1159	0.96	1228	1.14	1293	1.33	1354	1.53
975	1101	0.82	1174	0.99	1242	1.18	1306	1.37	1367	1.57
1050	1117	0.86	1189	1.03	1256	1.22	1320	1.41	1381	1.62
1125	1133	0.90	1204	1.08	1271	1.26	1335	1.46	1395	1.67
1200	1150	0.95	1221	1.13	1287	1.31	1350	1.51	1410	1.72
1275	1168	1.00	1237	1.18	1303	1.37	1365	1.57	1425	1.78
1350	1186	1.05	1255	1.24	1320	1.43	1382	1.63	1441	1.84
1425	1204	1.11	1272	1.30	1337	1.49	1398	1.70	1457	1.91
1500	1223	1.18	1291	1.36	1355	1.56	1415	1.77	<b>1473</b>	<b>1.99</b>

**NOTE:** For more information, see General Fan Performance Notes.  
**Boldface** indicates field – supplied drive is required.

Medium static 770 – 1175 RPM, 1.7 BHP max  
 High static 1035 – 1466 RPM, 2.9 BHP max

# FAN PERFORMANCE (BELT DRIVE) (cont.)

Table 28 – 48KC\*\*05

1 PHASE

4 TON VERTICAL SUPPLY

CFM	AVAILABLE EXTERNAL STATIC PRESSURE (in. wg)									
	0.2		0.4		0.6		0.8		1.0	
	RPM	BHP	RPM	BHP	RPM	BHP	RPM	BHP	RPM	BHP
1200	<b>693</b>	<b>0.25</b>	813	0.37	913	0.51	999	0.67	1077	0.84
1300	<b>729</b>	<b>0.30</b>	846	0.42	943	0.57	1028	0.73	1105	0.90
1400	<b>765</b>	<b>0.35</b>	879	0.48	974	0.63	1058	0.79	1134	0.97
1500	802	0.42	912	0.55	1006	0.70	1088	0.87	1163	1.05
1600	840	0.49	947	0.63	1038	0.78	1119	0.95	1193	1.14
1700	878	0.57	982	0.71	1071	0.87	1151	1.05	1224	1.24
1800	917	0.65	1017	0.81	1105	0.97	1183	1.15	1255	1.35
1900	956	0.75	1053	0.91	1139	1.08	1216	1.27	1287	1.47
2000	995	0.86	1090	1.02	1173	1.20	1249	1.39	-	-

48KC

CFM	AVAILABLE EXTERNAL STATIC PRESSURE (in. wg)									
	1.2		1.4		1.6		1.8		2.0	
	RPM	BHP	RPM	BHP	RPM	BHP	RPM	BHP	RPM	BHP
1200	1148	1.03	1214	1.23	1276	1.44	-	-	-	-
1300	1176	1.09	1241	1.30	-	-	-	-	-	-
1400	1204	1.17	1269	1.37	-	-	-	-	-	-
1500	1232	1.25	1297	1.46	-	-	-	-	-	-
1600	1262	1.34	-	-	-	-	-	-	-	-
1700	1291	1.44	-	-	-	-	-	-	-	-
1800	-	-	-	-	-	-	-	-	-	-
1900	-	-	-	-	-	-	-	-	-	-
2000	-	-	-	-	-	-	-	-	-	-

**NOTE:** For more information, see General Fan Performance Notes.  
**Boldface** indicates field-supplied drive is required.

Medium static 770–1175 RPM, 1.2 BHP max  
 High static 1035–1466 RPM, 1.5 BHP max

Table 29 – 48KC\*\*05

1 PHASE

4 TON HORIZONTAL SUPPLY

CFM	AVAILABLE EXTERNAL STATIC PRESSURE (in. wg)									
	0.2		0.4		0.6		0.8		1.0	
	RPM	BHP	RPM	BHP	RPM	BHP	RPM	BHP	RPM	BHP
1200	<b>681</b>	<b>0.24</b>	800	0.35	902	0.48	992	0.63	1074	0.78
1300	<b>717</b>	<b>0.29</b>	831	0.41	930	0.54	1019	0.69	1099	0.85
1400	<b>753</b>	<b>0.34</b>	863	0.46	959	0.60	1046	0.75	1125	0.92
1500	790	0.40	896	0.53	990	0.67	1074	0.83	1151	1.00
1600	828	0.46	930	0.60	1021	0.75	1103	0.91	1179	1.09
1700	866	0.54	964	0.68	1053	0.84	1133	1.01	1207	1.18
1800	905	0.62	1000	0.77	1085	0.94	1164	1.11	1238	1.29
1900	944	0.71	1036	0.87	1119	1.04	1195	1.22	1266	1.41
2000	984	0.82	1072	0.98	1153	1.15	1227	1.34	-	-

CFM	AVAILABLE EXTERNAL STATIC PRESSURE (in. wg)									
	1.2		1.4		1.6		1.8		2.0	
	RPM	BHP	RPM	BHP	RPM	BHP	RPM	BHP	RPM	BHP
1200	1150	0.95	1221	1.13	1287	1.31	-	-	-	-
1300	1173	1.02	1243	1.20	1309	1.39	-	-	-	-
1400	1198	1.09	1266	1.28	1331	1.47	-	-	-	-
1500	1223	1.18	1291	1.36	-	-	-	-	-	-
1600	1249	1.27	1316	1.46	-	-	-	-	-	-
1700	1277	1.37	-	-	-	-	-	-	-	-
1800	1305	1.48	-	-	-	-	-	-	-	-
1900	-	-	-	-	-	-	-	-	-	-
2000	-	-	-	-	-	-	-	-	-	-

**NOTE:** For more information, see General Fan Performance Notes.  
**Boldface** indicates field-supplied drive is required.

Medium static 770–1175 RPM, 1.2 BHP max  
 High static 1035–1466 RPM, 1.5 BHP max

## FAN PERFORMANCE (BELT DRIVE) (cont.)

Table 30 – 48KC\*\*05

3 PHASE

4 TON VERTICAL SUPPLY

CFM	AVAILABLE EXTERNAL STATIC PRESSURE (in. wg)									
	0.2		0.4		0.6		0.8		1.0	
	RPM	BHP	RPM	BHP	RPM	BHP	RPM	BHP	RPM	BHP
1200	<b>693</b>	<b>0.25</b>	<b>813</b>	<b>0.37</b>	<b>913</b>	<b>0.51</b>	999	0.67	1077	0.84
1300	<b>729</b>	<b>0.30</b>	<b>846</b>	<b>0.42</b>	943	0.57	1028	0.73	1105	0.90
1400	<b>765</b>	<b>0.35</b>	<b>879</b>	<b>0.48</b>	974	0.63	1058	0.79	1134	0.97
1500	<b>802</b>	<b>0.42</b>	<b>912</b>	<b>0.55</b>	1006	0.70	1088	0.87	1163	1.05
1600	<b>840</b>	<b>0.49</b>	947	0.63	1038	0.78	1119	0.95	1193	1.14
1700	<b>878</b>	<b>0.57</b>	982	0.71	1071	0.87	1151	1.05	1224	1.24
1800	<b>917</b>	<b>0.65</b>	1017	0.81	1105	0.97	1183	1.15	1255	1.35
1900	956	0.75	1053	0.91	1139	1.08	1216	1.27	1287	1.47
2000	995	0.86	1090	1.02	1173	1.20	1249	1.39	1319	1.59

CFM	AVAILABLE EXTERNAL STATIC PRESSURE (in. wg)									
	1.2		1.4		1.6		1.8		2.0	
	RPM	BHP	RPM	BHP	RPM	BHP	RPM	BHP	RPM	BHP
1200	1148	1.03	1214	1.23	1276	1.44	1335	1.67	1391	1.91
1300	1176	1.09	1241	1.30	1303	1.51	1361	1.74	1416	1.98
1400	1204	1.17	1269	1.37	1330	1.59	1388	1.82	1442	2.07
1500	1232	1.25	1297	1.46	1357	1.68	1415	1.91	1469	2.16
1600	1262	1.34	1325	1.55	1385	1.78	1442	2.01	1496	2.26
1700	1291	1.44	1354	1.66	1414	1.89	1470	2.12	1524	2.37
1800	1322	1.55	1384	1.77	1443	2.00	1499	2.25	1552	2.50
1900	1352	1.68	1414	1.90	1472	2.13	1528	2.38	1580	2.63
2000	1384	1.81	1445	2.04	1502	2.27	1557	2.52	1609	2.78

**NOTE:** For more information, see General Fan Performance Notes.

**Boldface** indicates field – supplied drive is required.

Medium static 920 – 1303 RPM, 1.7 BHP max

High static 1208 – 1639 RPM, 2.9 BHP max

48KC

Table 31 – 48KC\*\*05

3 PHASE

4 TON HORIZONTAL SUPPLY

CFM	AVAILABLE EXTERNAL STATIC PRESSURE (in. wg)									
	0.2		0.4		0.6		0.8		1.0	
	RPM	BHP	RPM	BHP	RPM	BHP	RPM	BHP	RPM	BHP
1200	<b>681</b>	<b>0.24</b>	<b>800</b>	<b>0.35</b>	<b>902</b>	<b>0.48</b>	992	0.63	1074	0.78
1300	<b>717</b>	<b>0.29</b>	<b>831</b>	<b>0.41</b>	930	0.54	1019	0.69	1099	0.85
1400	<b>753</b>	<b>0.34</b>	<b>863</b>	<b>0.46</b>	959	0.60	1046	0.75	1125	0.92
1500	<b>790</b>	<b>0.40</b>	<b>896</b>	<b>0.53</b>	990	0.67	1074	0.83	1151	1.00
1600	<b>828</b>	<b>0.46</b>	930	0.60	1021	0.75	1103	0.91	1179	1.09
1700	<b>866</b>	<b>0.54</b>	964	0.68	1053	0.84	1133	1.01	1207	1.18
1800	<b>905</b>	<b>0.62</b>	1000	0.77	1085	0.94	1164	1.11	1236	1.29
1900	944	0.71	1036	0.87	1119	1.04	1195	1.22	1266	1.41
2000	984	0.82	1072	0.98	1153	1.15	1227	1.34	1297	1.53

CFM	AVAILABLE EXTERNAL STATIC PRESSURE (in. wg)									
	1.2		1.4		1.6		1.8		2.0	
	RPM	BHP	RPM	BHP	RPM	BHP	RPM	BHP	RPM	BHP
1200	1150	0.95	1221	1.13	1287	1.31	1350	1.51	1410	1.72
1300	1173	1.02	1243	1.20	1309	1.39	1371	1.59	1430	1.80
1400	1198	1.09	1266	1.28	1331	1.47	1393	1.68	1451	1.89
1500	1223	1.18	1291	1.36	1355	1.56	1415	1.77	1473	1.99
1600	1249	1.27	1316	1.46	1379	1.66	1439	1.87	1496	2.09
1700	1277	1.37	1342	1.57	1404	1.77	1463	1.99	1520	2.21
1800	1305	1.48	1369	1.68	1430	1.89	1489	2.11	1545	2.34
1900	1333	1.60	1397	1.81	1457	2.02	1514	2.25	1570	2.48
2000	1363	1.73	1425	1.94	1484	2.16	1541	2.39	1596	2.63

**NOTE:** For more information, see General Fan Performance Notes.

**Boldface** indicates field – supplied drive is required.

Medium static 920 – 1303 RPM, 1.7 BHP max v

High static 1035 – 1208 – 1639 RPM, 2.9 BHP max

# FAN PERFORMANCE (BELT DRIVE) (cont.)

Table 32 – 48KC\*\*06

1 PHASE

5 TON VERTICAL SUPPLY

CFM	AVAILABLE EXTERNAL STATIC PRESSURE (in. wg)									
	0.2		0.4		0.6		0.8		1.0	
	RPM	BHP	RPM	BHP	RPM	BHP	RPM	BHP	RPM	BHP
1500	<b>847</b>	<b>0.41</b>	<b>966</b>	<b>0.55</b>	1067	0.68	1158	0.81	1240	0.93
1625	<b>896</b>	<b>0.50</b>	<b>1010</b>	<b>0.65</b>	1109	0.79	1198	0.93	1278	1.07
1750	<b>947</b>	<b>0.59</b>	1056	0.76	1152	0.92	1238	1.07	1318	1.22
1875	<b>998</b>	<b>0.70</b>	1103	0.88	1196	1.05	1280	1.22	1358	1.38
2000	1049	0.82	1151	1.02	1241	1.20	1323	1.38	-	-
2125	1102	0.96	1199	1.17	1287	1.37	-	-	-	-
2250	1154	1.11	1248	1.33	-	-	-	-	-	-
2375	1208	1.28	1298	1.52	-	-	-	-	-	-
2500	1261	1.47	-	-	-	-	-	-	-	-

CFM	AVAILABLE EXTERNAL STATIC PRESSURE (in. wg)									
	1.2		1.4		1.6		1.8		2.0	
	RPM	BHP	RPM	BHP	RPM	BHP	RPM	BHP	RPM	BHP
1500	1316	1.05	1387	1.17	1454	1.28	<b>1517</b>	<b>1.39</b>	<b>1578</b>	<b>1.50</b>
1625	1353	1.20	1423	1.33	<b>1489</b>	<b>1.46</b>	-	-	-	-
1750	1391	1.36	1460	1.51	-	-	-	-	-	-
1875	-	-	-	-	-	-	-	-	-	-
2000	-	-	-	-	-	-	-	-	-	-
2125	-	-	-	-	-	-	-	-	-	-
2250	-	-	-	-	-	-	-	-	-	-
2375	-	-	-	-	-	-	-	-	-	-
2500	-	-	-	-	-	-	-	-	-	-

**NOTE:** For more information, see General Fan Performance Notes.

Medium static 1035–1466 RPM, 1.5 BHP max

**Boldface** indicates field-supplied drive is required.

Table 33 – 48KC\*\*06

1 PHASE

5 TON HORIZONTAL SUPPLY

CFM	AVAILABLE EXTERNAL STATIC PRESSURE (in. wg)									
	0.2		0.4		0.6		0.8		1.0	
	RPM	BHP	RPM	BHP	RPM	BHP	RPM	BHP	RPM	BHP
1500	<b>798</b>	<b>0.41</b>	<b>906</b>	<b>0.55</b>	<b>1002</b>	<b>0.71</b>	1088	0.87	1167	1.05
1625	<b>845</b>	<b>0.50</b>	<b>949</b>	<b>0.65</b>	1041	0.81	1125	0.98	1202	1.17
1750	<b>893</b>	<b>0.60</b>	<b>993</b>	<b>0.76</b>	1081	0.93	1163	1.11	1238	1.30
1875	<b>942</b>	<b>0.71</b>	1037	0.88	1123	1.06	1202	1.25	1275	1.44
2000	<b>992</b>	<b>0.84</b>	1083	1.02	1166	1.21	1242	1.40	-	-
2125	1043	0.98	1129	1.17	1209	1.37	-	-	-	-
2250	1093	1.14	1177	1.34	-	-	-	-	-	-
2375	1145	1.32	1225	1.53	-	-	-	-	-	-
2500	1196	1.51	-	-	-	-	-	-	-	-

CFM	AVAILABLE EXTERNAL STATIC PRESSURE (in. wg)									
	1.2		1.4		1.6		1.8		2.0	
	RPM	BHP	RPM	BHP	RPM	BHP	RPM	BHP	RPM	BHP
1500	1241	1.23	1310	1.42	-	-	-	-	-	-
1625	1274	1.36	-	-	-	-	-	-	-	-
1750	1308	1.50	-	-	-	-	-	-	-	-
1875	-	-	-	-	-	-	-	-	-	-
2000	-	-	-	-	-	-	-	-	-	-
2125	-	-	-	-	-	-	-	-	-	-
2250	-	-	-	-	-	-	-	-	-	-
2375	-	-	-	-	-	-	-	-	-	-
2500	-	-	-	-	-	-	-	-	-	-

**NOTE:** For more information, see General Fan Performance Notes.

Medium static 1035–1466 RPM, 1.5 BHP max

48KC

## FAN PERFORMANCE (BELT DRIVE) (cont.)

Table 34 – 48KC\*\*06

3 PHASE

5 TON VERTICAL SUPPLY

CFM	AVAILABLE EXTERNAL STATIC PRESSURE (in. wg)									
	0.2		0.4		0.6		0.8		1.0	
	RPM	BHP	RPM	BHP	RPM	BHP	RPM	BHP	RPM	BHP
1500	<b>847</b>	<b>0.41</b>	966	0.55	1067	0.68	1158	0.81	1240	0.93
1625	<b>896</b>	<b>0.50</b>	1010	0.65	1109	0.79	1198	0.93	1278	1.07
1750	<b>947</b>	<b>0.59</b>	1056	0.76	1152	0.92	1238	1.07	1318	1.22
1875	<b>998</b>	<b>0.70</b>	1103	0.88	1196	1.05	1280	1.22	1358	1.38
2000	1049	0.82	1151	1.02	1241	1.20	1323	1.38	1399	1.56
2125	1102	0.96	1199	1.17	1287	1.37	1367	1.56	1441	1.75
2250	1154	1.11	1248	1.33	1333	1.55	1411	1.75	1484	1.96
2375	1208	1.28	1298	1.52	1381	1.74	1457	1.96	1528	2.18
2500	1261	1.47	1349	1.72	1429	1.96	1503	2.19	1572	2.42

CFM	AVAILABLE EXTERNAL STATIC PRESSURE (in. wg)									
	1.2		1.4		1.6		1.8		2.0	
	RPM	BHP	RPM	BHP	RPM	BHP	RPM	BHP	RPM	BHP
1500	1316	1.05	1387	1.17	1454	1.28	1517	1.39	1578	1.50
1625	1353	1.20	1423	1.33	1489	1.46	1552	1.58	1611	1.70
1750	1391	1.36	1460	1.51	1525	1.65	1587	1.78	1646	1.91
1875	1430	1.54	1498	1.70	1562	1.85	1623	2.00	1681	2.14
2000	1470	1.73	1537	1.90	1600	2.06	1660	2.23	<b>1718</b>	<b>2.38</b>
2125	1511	1.93	1576	2.12	1639	2.29	<b>1698</b>	<b>2.47</b>	<b>1755</b>	<b>2.64</b>
2250	1552	2.15	1617	2.35	1678	2.54	<b>1737</b>	<b>2.73</b>	–	–
2375	1595	2.39	1658	2.60	<b>1718</b>	<b>2.80</b>	–	–	–	–
2500	1638	2.64	<b>1700</b>	<b>2.87</b>	–	–	–	–	–	–

**NOTE:** For more information, see General Fan Performance Notes.  
**Boldface** indicates field – supplied drive is required.

Medium static 1035 – 1466 RPM, 2.9 BHP max  
 High static 1303 – 1687 RPM, 2.9 BHP max

48KC

Table 35 – 48KC\*\*06

3 PHASE

5 TON HORIZONTAL SUPPLY

CFM	AVAILABLE EXTERNAL STATIC PRESSURE (in. wg)									
	0.2		0.4		0.6		0.8		1.0	
	RPM	BHP	RPM	BHP	RPM	BHP	RPM	BHP	RPM	BHP
1500	<b>798</b>	<b>0.41</b>	906	0.55	1002	0.71	1088	0.87	1167	1.05
1625	<b>845</b>	<b>0.50</b>	949	0.65	1041	0.81	1125	0.98	1202	1.17
1750	<b>893</b>	<b>0.60</b>	993	0.76	1081	0.93	1163	1.11	1238	1.30
1875	<b>942</b>	<b>0.71</b>	1037	0.88	1123	1.06	1202	1.25	1275	1.44
2000	<b>992</b>	<b>0.84</b>	1083	1.02	1166	1.21	1242	1.40	1313	1.61
2125	1043	0.98	1129	1.17	1209	1.37	1283	1.57	1353	1.79
2250	1093	1.14	1177	1.34	1254	1.55	1325	1.76	1393	1.98
2375	1145	1.32	1225	1.53	1299	1.74	1369	1.97	1434	2.20
2500	1196	1.51	1273	1.73	1345	1.96	1413	2.19	1477	2.43

CFM	AVAILABLE EXTERNAL STATIC PRESSURE (in. wg)									
	1.2		1.4		1.6		1.8		2.0	
	RPM	BHP	RPM	BHP	RPM	BHP	RPM	BHP	RPM	BHP
1500	1241	1.23	1310	1.42	1375	1.63	1438	1.84	1497	2.06
1625	1274	1.36	1342	1.56	1406	1.77	1467	1.98	1526	2.21
1750	1308	1.50	1375	1.70	1438	1.92	1498	2.14	1555	2.37
1875	1344	1.65	1409	1.86	1471	2.09	1530	2.32	1586	2.55
2000	1380	1.82	1444	2.04	1505	2.27	1563	2.51	1619	2.75
2125	1418	2.01	1481	2.24	1540	2.47	1597	2.72	<b>1652</b>	<b>2.97</b>
2250	1457	2.21	1518	2.45	1576	2.69	<b>1632</b>	<b>2.94</b>	<b>1686</b>	<b>3.20</b>
2375	1497	2.43	1556	2.68	<b>1614</b>	<b>2.93</b>	<b>1669</b>	<b>3.19</b>	–	–
2500	1538	2.68	<b>1596</b>	<b>2.93</b>	<b>1652</b>	<b>3.19</b>	–	–	–	–

**NOTE:** For more information, see General Fan Performance Notes.  
**Boldface** indicates field – supplied drive is required.

Medium static 1035 – 1466 RPM, 2.9 BHP max  
 High static 1303 – 1687 RPM, 2.9 BHP max

## FAN PERFORMANCE (cont.)

**Table 36 – PULLEY ADJUSTMENT - BELT DRIVE**

UNIT		MOTOR/DRIVE COMBO	MOTOR PULLEY TURNS OPEN										
			0	0.5	1	1.5	2	2.5	3	3.5	4	4.5	5
04	1 phase	Medium Static	1175	1135	1094	1054	1013	973	932	892	851	811	770
		High Static	1466	1423	1380	1337	1294	1251	1207	1164	1121	1078	1035
05		Medium Static	1175	1135	1094	1054	1013	973	932	892	851	811	770
		High Static	1466	1423	1380	1337	1294	1251	1207	1164	1121	1078	1035
06		Medium Static	1466	1423	1380	1337	1294	1251	1207	1164	1121	1078	1035
		High Static	N/A	N/A	N/A	N/A	N/A	N/A	N/A	N/A	N/A	N/A	N/A
04	3 phase	Medium Static	1175	1135	1094	1054	1013	973	932	892	851	811	770
		High Static	1466	1423	1380	1337	1294	1251	1207	1164	1121	1078	1035
05		Medium Static	1303	1265	1226	1188	1150	1112	1073	1035	997	958	920
		High Static	1639	1596	1553	1510	1467	1424	1380	1337	1294	1251	1208
06		Medium Static	1466	1423	1380	1337	1294	1251	1207	1164	1121	1078	1035
		High Static	1687	1649	1610	1572	1533	1495	1457	1418	1380	1341	1303

**NOTE:** Do not adjust pulley further than 5 turns open.

■ – Factory settings

N/A – Not Available

48KC

Climaproyectos  
.com

# ELECTRICAL INFORMATION

**Table 37 – 48KC\*\*04 SINGLE STAGE COOLING WITH SINGLE SPEED INDOOR FAN MOTOR 3 TONS**

V-Ph-Hz	UNIT VOLTAGE		COMP 1		OFM (ea)		IFM		
	RANGE		RLA	LRA	WATTS	FLA	TYPE	EFF at Full Load	FLA
	MIN	MAX							
208-1-60	187	253	16.6	79	190	1.0	DD-STD	78%	7.4
					190	1.0	MED	67%	4.9
					190	1.0	HIGH	76%	7.0
230-1-60	187	253	16.6	79	190	1.0	DD-STD	78%	7.4
					190	1.0	MED	67%	4.9
					190	1.0	HIGH	76%	7.0
208-3-60	187	253	10.4	73	190	1.0	DD-STD	78%	7.4
					190	1.0	MED	87%	5.2
					190	1.0	HIGH	89%	8.4
230-3-60	187	253	10.4	73	190	1.0	DD-STD	78%	7.4
					190	1.0	MED	87%	4.9
					190	1.0	HIGH	89%	8.3
460-3-60	414	506	5.8	38	190	0.5	DD-STD	78%	4.0
					190	0.5	MED	87%	2.5
					190	0.5	HIGH	89%	4.2
575-3-60	518	633	3.8	37	190	0.5	DD-STD	78%	4.0
					190	0.5	MED	72%	1.6
					190	0.5	HIGH	77%	2.8

48KC

**Table 38 – 48KC\*\*05 SINGLE STAGE COOLING WITH SINGLE SPEED INDOOR FAN MOTOR 4 TONS**

V-Ph-Hz	UNIT VOLTAGE		COMP 1		OFM (ea)		IFM		
	RANGE		RLA	LRA	WATTS	FLA	TYPE	EFF at Full Load	FLA
	MIN	MAX							
208-1-60	187	253	21.8	117	325	1.5	DD-STD	78%	7.4
					325	1.5	MED	67%	4.9
					325	1.5	HIGH	76%	7.0
230-1-60	187	253	21.8	117	325	1.5	DD-STD	78%	7.4
					325	1.5	MED	67%	4.9
					325	1.5	HIGH	76%	7.0
208-3-60	187	253	13.7	83	325	1.5	DD-STD	78%	7.4
					325	1.5	MED	87%	5.2
					325	1.5	HIGH	89%	8.4
230-3-60	187	253	13.7	83	325	1.5	DD-STD	78%	7.4
					325	1.5	MED	87%	4.9
					325	1.5	HIGH	89%	8.3
460-3-60	414	506	6.2	41	325	0.8	DD-STD	78%	4.0
					325	0.8	MED	87%	2.5
					325	0.8	HIGH	89%	4.2
575-3-60	518	633	4.8	33	325	0.6	DD-STD	78%	4.0
					325	0.6	MED	72%	1.6
					325	0.6	HIGH	77%	2.8

**Table 39 – 48KC\*\*06 SINGLE STAGE COOLING WITH SINGLE SPEED INDOOR FAN MOTOR 5 TONS**

V-Ph-Hz	UNIT VOLTAGE		COMP 1		OFM (ea)		IFM		
	RANGE		RLA	LRA	WATTS	FLA	TYPE	EFF at Full Load	FLA
	MIN	MAX							
208-1-60	187	253	25.0	134	325	1.4	DD-STD	78%	7.4
					325	1.4	MED	76%	7.0
230-1-60	187	253	25.0	134	325	1.4	DD-STD	78%	7.4
					325	1.4	MED	76%	7.0
208-3-60	187	253	15.9	110	325	1.4	DD-STD	78%	7.4
					325	1.4	MED	89%	8.4
					325	1.4	HIGH	89%	8.4
230-3-60	187	253	15.9	110	325	1.4	DD-STD	78%	7.4
					325	1.4	MED	89%	8.3
					325	1.4	HIGH	89%	8.3
460-3-60	414	506	7.0	52	325	0.9	DD-STD	78%	4.0
					325	0.9	MED	89%	4.2
					325	0.9	HIGH	89%	4.2
575-3-60	518	633	5.1	40	325	0.9	DD-STD	78%	4.0
					325	0.9	MED	77%	2.8
					325	0.9	HIGH	77%	2.8



Table 40 – UNIT WIRE/FUSE OR HACR BREAKER SIZING DATA

UNIT	NOM. V-Ph-Hz	IFM TYPE	NO C.O. or UNPWR C.O.						w/ PWRD C.O.											
			NO PE.			w/ PE. (pwrdr fr/ unit)			NO PE.			w/ PE. (pwrdr fr/ unit)								
			MCA	MAX FUSE or HACR BRKR	DISC. SIZE FLA LRA	MCA	MAX FUSE or HACR BRKR	DISC. SIZE FLA LRA	MCA	MAX FUSE or HACR BRKR	DISC. SIZE FLA LRA	MCA	MAX FUSE or HACR BRKR	DISC. SIZE FLA LRA						
48KC**04	208/230-1-60	DD-STD	30	45	29	88	32	45	31	90	-	-	-	-	-	-	-	-	-	-
		MED	27	40	26	93	29	45	28	95	-	-	-	-	-	-	-	-	-	-
		HIGH	29	45	28	118	31	45	30	120	-	-	-	-	-	-	-	-	-	-
48KC**04	208/230-3-60	DD-STD	22	30	22	82	24	30	24	84	27	30	27	87	29	35	29	89	29	89
		MED	20/19	25/25	19/19	111	22/21	30/30	21/21	113	24/24	30/30	25/24	116	26/26	30/30	27/26	118	26/26	118
		HIGH	23/23	30/30	23/23	147	25/25	30/30	25/25	149	28/28	30/30	28/28	152	30/29	35/35	30/30	154	30/29	154
48KC**04	460-3-60	DD-STD	12	15	12	43	13	15	13	44	14	20	14	45	15	20	16	46	15	46
		MED	11	15	10	57	12	15	11	58	13	15	13	59	14	15	14	60	14	60
		HIGH	12	15	12	75	13	15	13	76	15	20	15	77	16	20	16	78	16	78
48KC**04	575-3-60	DD-STD	10	15	10	42	12	15	12	44	11	15	12	44	13	15	14	46	13	46
		MED	7	15	7	45	9	15	9	47	9	15	9	47	11	15	11	49	11	49
		HIGH	9	15	8	60	10	15	10	62	10	15	10	62	12	15	12	64	12	64
48KC**05	208/230-1-60	DD-STD	37	50	35	128	39	50	37	130	-	-	-	-	-	-	-	-	-	-
		MED	34	50	32	133	36	50	35	135	-	-	-	-	-	-	-	-	-	-
		HIGH	36	50	35	158	38	50	37	160	-	-	-	-	-	-	-	-	-	-
48KC**05	208/230-3-60	DD-STD	26	30	26	94	28	40	28	96	31	40	32	99	33	45	34	101	33	101
		MED	24/24	30/30	23/23	123	26/26	30/30	26/25	125	29/29	40/40	29/29	128	31/31	40/40	31/31	130	31/31	130
		HIGH	27/27	40/40	27/27	159	29/29	40/40	29/29	161	32/32	45/45	33/33	164	34/34	45/45	35/35	166	34/34	166
48KC**05	460-3-60	DD-STD	13	15	13	47	14	20	14	48	15	20	15	49	16	20	16	50	16	50
		MED	12	15	11	61	13	15	12	62	14	15	13	63	15	20	15	64	15	64
		HIGH	13	15	13	79	14	20	14	80	15	20	15	81	16	20	17	82	16	82
48KC**05	575-3-60	DD-STD	11	15	11	39	13	15	13	41	13	15	13	41	15	20	15	43	15	43
		MED	9	15	8	42	11	15	10	44	10	15	10	44	12	15	12	46	12	46
		HIGH	10	15	9	57	12	15	12	59	12	15	11	59	13	15	14	61	13	61

See "Legend and Notes for Table 40 on page 42."

**TABLE 40 – UNIT WIRE/FUSE OR HACR BREAKER SIZING DATA (CONT)**

UNIT	NOM. V-Ph-Hz	IFM TYPE	NO C.O. or UNPWR C.O.						w/ PWRD C.O.										
			NO P.E.			w/ P.E. (pwrd fr/ unit)			NO P.E.			w/ P.E. (pwrd fr/ unit)							
			MAX FUSE or HACR BRKR	DISC. SIZE FLA LRA	MCA	MAX FUSE or HACR BRKR	DISC. SIZE FLA LRA	MCA	MAX FUSE or HACR BRKR	DISC. SIZE FLA LRA	MCA	MAX FUSE or HACR BRKR	DISC. SIZE FLA LRA	MCA					
48KC*06	208/230-1-60	DD-STD	60	39	144	42	60	41	146	-	-	-	-	-	-	-	-	-	
		MED	60	38	174	42	60	41	176	-	-	-	-	-	-	-	-	-	
	208/230-3-60	DD-STD	40	28	120	31	45	31	122	34	45	34	45	34	36	50	36	36	127
		MED	45/45	30/29	185	32/32	45/45	32/32	187	35/35	50/50	35/35	50/50	35/35	37/37	50/50	37/37	37/37	192
	460-3-60	HIGH	30/30	30/29	185	32/32	45/45	32/32	187	35/35	50/50	35/35	50/50	35/35	37/37	50/50	37/37	37/37	192
		DD-STD	20	14	58	15	20	15	59	16	20	16	20	16	17	20	17	17	61
575-3-60	MED	20	14	90	15	20	15	91	17	20	17	20	17	18	20	18	18	93	
	HIGH	20	14	90	15	20	15	91	17	20	17	20	17	18	20	18	18	93	
48KC*06	DD-STD	MED	15	12	46	14	15	14	48	13	15	13	15	13	15	13	15	13	50
		HIGH	15	10	64	12	15	12	66	12	15	12	15	12	14	15	14	68	
		HIGH	15	10	64	12	15	12	66	12	15	12	15	12	14	15	14	68	

See "Legend and Notes for Table 40 on page 42.



48KC

**Legend and Notes for Table 40**

**LEGEND:**

- BRKR – Circuit breaker
- CO – Convenient outlet
- DD – Direct drive (indoor fan motor)
- DISC – Disconnect
- FLA – Full load amps
- IFM – Indoor fan motor
- LRA – Locked rotor amps
- MCA – Minimum circuit amps
- MOCP – MAX FUSE or HACR Breaker
- PE – Power exhaust
- PWRD CO – Powered convenient outlet
- UNPWR CO – Unpowered convenient outlet

**NOTES:**

1. In compliance with NEC requirements for multimotor and combination load equipment (refer to NEC Articles 430 and 440), the overcurrent protective device for the unit shall be fuse or HACR breaker. Canadian units may be fuse or circuit breaker.
2. **Unbalanced 3-Phase Supply Voltage**  
Never operate a motor where a phase imbalance in supply voltage is greater than 2%. Use the following formula to determine the percentage of voltage imbalance.

$$\% \text{ Voltage Imbalance} = 100 \times \frac{\text{max voltage deviation from average voltage}}{\text{average voltage}}$$

Example: Supply voltage is 230-3-60



- AB = 224 v
- BC = 231 v
- AC = 226 v

$$\begin{aligned} \text{Average Voltage} &= \frac{(224 + 231 + 226)}{3} = \frac{681}{3} \\ &= 227 \end{aligned}$$

Determine maximum deviation from average voltage.

(AB) 227 – 224 = 3 v

(BC) 231 – 227 = 4 v

(AC) 227 – 226 = 1 v

Maximum deviation is 4 v.

Determine percent of voltage imbalance.

$$\begin{aligned} \% \text{ Voltage Imbalance} &= 100 \times \frac{4}{227} \\ &= 1.76\% \end{aligned}$$

This amount of phase imbalance is satisfactory as it is below the maximum allowable 2%.

**IMPORTANT:** If the supply voltage phase imbalance is more than 2%, contact your local electric utility company immediately.

## SEQUENCE OF OPERATION

### General

The sequence below describes the sequence of operation for an electromechanical unit with and without a factory installed EconoMi\$er IV and X (called “economizer” in this sequence). For information regarding a direct digital controller, see the start-up, operations, and troubleshooting manual for the applicable controller.

### Electromechanical units with no economizer

#### Cooling (Single speed indoor fan motor) —

When the thermostat calls for cooling, terminals G and Y1 are energized. As a result, the indoor fan contactor (IFC) and the compressor contactor (C1) are energized, causing the indoor fan motor (IFM), compressor #1, and outdoor fan to start. If the unit has 2 stages of cooling, the thermostat will additionally energize Y2. The Y2 signal will energize compressor contactor #2 (C2), causing compressor #2 to start. Regardless of the number of stages, the outdoor fan motor runs continuously while unit is cooling. When SAV system is utilized, indoor fan motor runs at design CFM (full speed) during the heating operation.

#### Heating (Single speed indoor fan motor) —

When the thermostat calls for heating, power is sent to W on the Integrated Gas Controller (IGC) board. An LED (light-emitting diode) on the IGC board turns on and remains on during normal operation. A check is made to ensure that the rollout switch and limit switch are closed. If the check was successful, the induced-draft motor is energized, and when its speed is satisfactory, as proven by the “hall effect” sensor, the ignition activation period begins. The burners will ignite within 5 seconds. If the burners do not light, there is a 22-second delay before another 5-second attempt. This sequence is repeated for 15 minutes

or until the burners light. If, after the 15 minutes, the burners still have not lit, heating is locked out. To reset the control, break 24-v power to the thermostat.

When ignition occurs, the IGC board will continue to monitor the condition of the rollout switch, the limit switches, the “hall effect” sensor, as well as the flame sensor. 45 seconds after ignition occurs, assuming the unit is controlled through a room thermostat set for fan auto, the indoor fan motor will energize (and the outdoor air dampers will open to their minimum position). If, for some reason, the over-temperature limit opens prior to the start of the indoor fan blower, the unit will shorten the 45-second delay to 5 seconds less than the time from initiation of heat to when the limit tripped. Gas will not be interrupted to the burners and heating will continue. Once the fan-on delay has been modified, it will not change back to 45 seconds until power is reset to the control.

On units with 2 stages of heat, when additional heat is required, W2 closes and initiates power to the second stage of the main gas valve. When the thermostat is satisfied, W1 and W2 open and the gas valve closes, interrupting the flow of gas to the main burners.

If the call for W1 lasted less than 1 minute, the heating cycle will not terminate until 1 minute after W1 became active. If the unit is controlled through a room thermostat set for fan auto, the indoor fan motor will continue to operate for an additional 45 seconds then stop. If the over-temperature limit opens after the indoor motor is stopped, but within 10 minutes of W1 becoming inactive, on the next cycle the time will be extended by 15 seconds. The maximum delay is 3 minutes. Once modified, the fan off delay will not change back to 45 seconds unless power is reset to the control. A LED indicator is provided on the IGC to monitor operation.

## SEQUENCE OF OPERATION (cont.)

### Electromechanical units with an economizer

#### Cooling —

When free cooling is not available, the compressors will be controlled by the zone thermostat. When free cooling is available, the outdoor air damper is modulated by the EconoMi\$er IV and X control to provide a 50°F (10°C) to 55°F (13°C) mixed air temperature into the zone. As the mixed air temperature fluctuates above 55°F (13°C) or below 50°F (10°C) dampers will be modulated (open or close) to bring the mixed air temperature back within control. If mechanical cooling is utilized with free cooling, the outdoor air damper will maintain its current position at the time the compressor is started. If the increase in cooling capacity causes the mixed air temperature to drop below 45°F (7°C), then the outdoor air damper position will be decreased to the minimum position. If the mixed air temperature continues to fall, the outdoor air damper will close. Control returns to normal once the mixed air temperature rises above 48°F (9°C). The power exhaust fans will be energized and de-energized, if installed, as the outdoor air damper opens and closes.

If field installed accessory CO<sub>2</sub> sensors are connected to the EconoMi\$er IV and X control, a demand controlled ventilation strategy will begin to operate. As the CO<sub>2</sub> level in the zone increases above the CO<sub>2</sub> setpoint, the minimum position of the damper will be increased proportionally. As the CO<sub>2</sub> level decreases because of the increase in fresh air, the outdoor air damper will be proportionally closed. For EconoMi\$er IV and X operation, there must be a thermostat call for the fan (G).

If the unit is occupied and the fan is on, the damper will operate at minimum position. Otherwise, the damper will be closed.

If field installed accessory CO<sub>2</sub> sensors are connected to the EconoMi\$er IV and X control, a demand controlled ventilation strategy will begin to operate. As the CO<sub>2</sub> level in the zone increases above the CO<sub>2</sub> setpoint, the minimum position of the damper will be increased proportionally. As the CO<sub>2</sub> level decreases because of the increase in fresh air, the outdoor air damper will be proportionally closed. For EconoMi\$er IV and X operation, there must be a thermostat call for the fan (G). If the unit is occupied and the fan is on, the damper will operate at minimum position. Otherwise, the damper will be closed.

When the EconoMi\$er IV and X control is in the occupied mode and a call for cooling exists (Y1 on the thermostat), the control will first check for indoor fan operation. If the fan is not on, then cooling will not be activated. If the fan is on, then the control will open the EconoMi\$er IV and X damper to the minimum position.

On the initial power to the EconoMi\$er IV and X control, it will take the damper up to 2 1/2 minutes before it begins to position itself. After the initial power-up, further changes in damper position can take up to 30 seconds to initiate. Damper movement from full closed to full open (or vice versa) will take between 1 1/2 and 2 1/2 minutes. If free cooling can be used as determined from the appropriate changeover command (switch, dry bulb, enthalpy curve, differential dry bulb, or differential enthalpy), then the control will modulate the dampers open to maintain the mixed air temperature setpoint at 50°F (10°C) to 55°F (13°C). If there is a further demand for cooling (cooling second stage - Y2 is energized), then the control will bring on compressor stage 1 to maintain the mixed air temperature setpoint. The EconoMi\$er IV and X damper will be open at maximum position.

#### Heating

The sequence of operation for the heating is the same as an electromechanical unit with no economizer. The only difference is how the economizer acts. The economizer will stay at the Economizer Minimum Position while the evaporator fan is operating. The outdoor air damper is closed when the indoor fan is not operating.

#### Optional Humidi-MiZer Dehumidification System

Units with the factory equipped Humidi-MiZer option are capable of providing multiple modes of improved dehumidification as a variation of the normal cooling cycle. The Humidi-MiZer option includes additional valves in the liquid line and discharge line of each refrigerant circuit, a small reheat condenser coil downstream of the evaporator, and Motormaster variable-speed control of some or all outdoor fans. Operation of the revised refrigerant circuit for each mode is described below.

The Humidi-MiZer system provides three sub-modes of operation: Cool, Reheat1, and Reheat2.

**Cool mode** - provides a normal ratio of Sensible and Latent Cooling effect from the evaporator coil.

**Reheat1** - provides increased Latent Cooling while slightly reducing the Sensible Cooling effect.

**Reheat2** - provides normal Latent Cooling but with null or minimum Sensible Cooling effect delivered to the space.

The Reheat1 and Reheat2 modes are available when the unit is not in a Heating mode and when the Low Ambient Lockout switch is closed.

The following diagrams depict piping for Single Stage cooling units.

## SEQUENCE OF OPERATION (cont.)

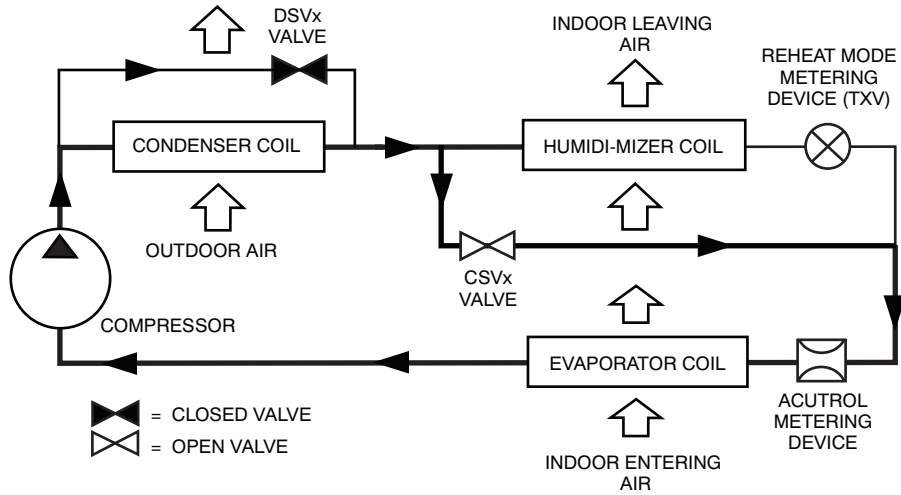

**Fig. 5 - Normal Cooling Mode - Humidi-MiZer System with Single Stage Cooling**

C12647

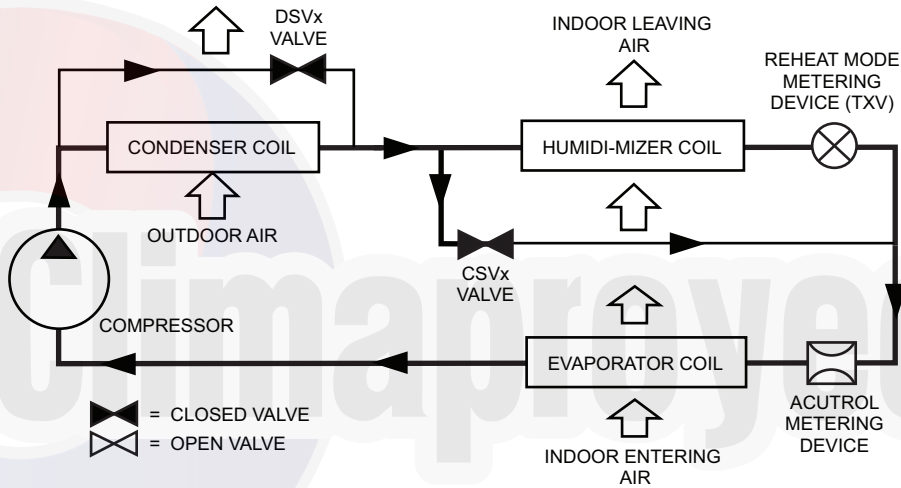

**Fig. 6 - Subcooling Mode (Reheat 1) - Humidi-MiZer System with Single Stage Cooling**

C12648

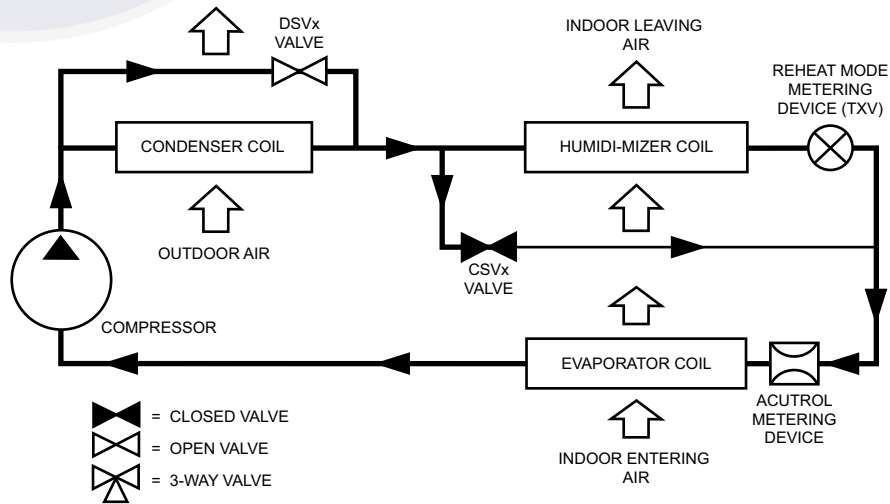

**Fig. 7 - Hot Gas Reheat Mode (Reheat 2) - Humidi-MiZer System with Single Stage Cooling**

C12649

## Gas Heat/Electric Cooling Packaged Rooftop

### HVAC Guide Specifications

Size Range: 3 to 5 Nominal Tons



<u>Section</u>	<u>Description</u>
----------------	--------------------

<b>23 06 80</b>	<b>Schedules for Decentralized HVAC Equipment</b>
-----------------	---

- |                |   |
|----------------|---|
| 23 06 80.13    | Decentralized Unitary HVAC Equipment Schedule           |
| 23 06 80.13.A. | Rooftop unit schedule                                   |
| 1.             | Schedule is per the project specification requirements. |

<b>23 07 16</b>	<b>HVAC Equipment Insulation</b>
-----------------	----------------------------------

- |                |   |
|----------------|---|
| 23 07 16.13    | Decentralized, Rooftop Units:   |
| 23 07 16.13.A. | Evaporator fan compartment:   |
| 1.             | Interior cabinet surfaces shall be insulated with a minimum 1/2-in. thick, minimum 1 1/2 lb density, flexible fiberglass insulation bonded with a phenolic binder, neoprene coated on the air side. |
| 2.             | Insulation and adhesive shall meet NFPA 90A requirements for flame spread and smoke generation.   |
| 23 07 16.13.B. | Gas heat compartment:   |
| 1.             | Aluminum foil-faced fiberglass insulation shall be used.  |
| 2.             | Insulation and adhesive shall meet NFPA 90A requirements for flame spread and smoke generation.   |

<b>23 09 13</b>	<b>Instrumentation and Control Devices for HVAC</b>
-----------------	---

- |                |  |
|----------------|--|
| 23 09 13.23    | Sensors and Transmitters   |
| 23 09 13.23.A. | Thermostats  |
| 1.             | Thermostat must  |
| a.             | energize both "W" and "G" when calling for heat.                                   |
| b.             | have capability to energize 1 stage of cooling, and 2 different stages of heating. |
| c.             | include capability for occupancy scheduling.                                       |

<b>23 09 23</b>	<b>Direct-digital Control system for HVAC</b>
-----------------	---

- |                |   |
|----------------|---|
| 23 09 23.13    | Decentralized, Rooftop Units:   |
| 23 09 23.13.A. | PremierLink controller  |
| 1.             | Shall be ASHRAE 62 compliant.   |
| 2.             | Shall accept 18-32 VAC input power.   |
| 3.             | Shall have an operating temperature range from -40°F (-40°C) to 158°F (70°C), 10% - 95% RH (non-condensing).  |
| 4.             | Shall include an integrated economizer controller to support an economizer with 4 to 20 mA actuator input and no microprocessor controller.   |
| 5.             | Controller shall accept the following inputs: space temperature, setpoint adjustment, outdoor air temperature, indoor air quality, outdoor air quality, indoor relative humidity, compressor lock-out, fire shutdown, enthalpy, fan status, remote time clock/door switch.                        |
| 6.             | Shall accept a CO <sub>2</sub> sensor in the conditioned space, and be Demand Control Ventilation (DCV) ready.  |
| 7.             | Shall provide the following outputs: economizer, fan, cooling stage 1, cooling stage 2, heat stage 1, heat stage 2, heat stage 3/ exhaust/ reversing valve/ dehumidify/ occupied.   |
| 8.             | Unit shall provide surge protection for the controller through a circuit breaker.   |
| 9.             | Shall be Internet capable, and communicate at a Baud rate of 38.4K or faster  |
| 10.            | Shall have an LED display independently showing the status of activity on the communication bus, and processor operation.   |
| 11.            | Shall include an RS-485 protocol communication port, an access port for connection of either a computer or a Carrier technician tool, an RS-485 port for network communication to intelligent space sensors and displays, and a port to connect an optional LonWorks plug-in communications card. |
| 12.            | Shall have built-in Carrier Comfort Network™ (CCN) protocol, and be compatible with other CCN devices, including ComfortLink™ and ComfortVIEW™ controllers.   |
| 13.            | Shall have built-in support for Carrier technician tool.  |



14. Software upgrades will be accomplished by local download. Software upgrades through chip replacements are not allowed.
  15. Shall be shock resistant in all planes to 5G peak, 11ms during operation, and 100G peak, 11ms during storage.
  16. Shall be vibration resistant in all planes to 1.5G @ 20-300 Hz.
  17. Shall support a bus length of 4000 ft (1219m) max, 60 devices per 1000 ft (305m) section, and 1 RS-485 repeater per 1000 ft (305m) sections.
- 23 09 23.13.B. RTU Open - Open protocol, direct digital controller:
1. Shall be ASHRAE 62 compliant.
  2. Shall accept 18-30VAC, 50-60Hz, and consumer 15VA or less power.
  3. Shall have an operating temperature range from -40°F (-40°C) to 130°F (54°C), 10% - 90% RH (non-condensing).
  4. Shall include built-in protocol for BACNET (MS/TP and PTP modes), Modbus (RTU and ASCII), Johnson N2 and LonWorks. LonWorks Echelon processor required for all Lon applications shall be contained in separate communication board.
  5. Shall allow access of up to 62 network variables (SNVT). Shall be compatible with all open controllers.
  6. Baud rate Controller shall be selectable using a dipswitch.
  7. Shall have an LED display independently showing the status of serial communication, running, errors, power, all digital outputs, and all analog inputs.
  8. Shall accept the following inputs: space temperature, setpoint adjustment, outdoor air temperature, indoor air quality, outdoor air quality, compressor lock-out, fire shutdown, enthalpy switch, and fan status/filter status/humidity/ remote occupancy.
  9. Shall provide the following outputs: economizer, variable frequency drive, fan, cooling stage 1, cooling stage 2, heat stage 1, heat stage 2, exhaust reversing valve/high fan speed.
  10. Shall have built-in surge protection circuitry through solid state polyswitches. Polyswitches shall be used on incoming power and network connections. Polyswitches will return to normal when the "trip" condition clears.
  11. Shall have a battery back-up capable of a minimum of 10,000 hours of data and time clock retention during power outages.
  12. Shall have built-in support for Carrier technician tool.
  13. Shall include an RS-485 protocol communication port, an access port for connection of either a computer or a Carrier technician tool, an RS-485 port for network communication to intelligent space sensors and displays, and a port to connect an optional LonWorks communications card.
  14. Software upgrades will be accomplished by either local or remote download. No software upgrades through chip replacements are allowed.

### 23 09 33 Electric and Electronic Control System for HVAC

23 09 33.13 Decentralized, Rooftop Units:

23 09 33.13.A. General:

1. Shall be complete with self-contained low-voltage control circuit protected by a resettable circuit breaker on the 24-v transformer side. Transformer shall have 75VA capability.
2. Shall utilize color-coded wiring.
3. Shall include a central control terminal board to conveniently and safely provide connection points for vital control functions such as: smoke detectors, phase monitor, gas controller, economizer, thermostat, DDC control options, and low and high pressure switches.
4. The heat exchanger shall be controlled by an integrated gas controller (IGC) microprocessor. See heat exchanger section of this specification.
5. Unit shall include a minimum of one 8-pin screw terminal connection board for connection of control wiring.

23 09 33.23.B. Safeties:

1. Compressor over-temperature, over-current. High internal pressure differential.
2. Low pressure switch.
  - a. Low pressure switch shall use different color wire than the high pressure switch. The purpose is to assist the installer and service technician to correctly wire and or troubleshoot the rooftop unit.
3. High pressure switch.
  - a. High pressure switch shall use different color wire than the low pressure switch. The purpose is to assist the installer and service technician to correctly wire and or troubleshoot the rooftop unit.
4. Automatic reset, motor thermal overload protector.
5. Heating section shall be provided with the following minimum protections:
  - a. High temperature limit switches.



- b. Induced draft motor speed sensor.
- c. Flame rollout switch.
- d. Flame proving controls.

**23 09 93 Sequence of Operations for HVAC Controls**

- 23 09 93.13 Decentralized, Rooftop Units:
- 23 09 93.13 INSERT SEQUENCE OF OPERATION

**23 40 13 Panel Air Filters**

- 23 40 13.13 Decentralized, Rooftop Units:
- 23 40 13.13.A. Standard filter section
  1. Shall consist of factory installed, low velocity, disposable 2-in. thick fiberglass filters of commercially available sizes.
  2. Unit shall use only one filter size. Multiple sizes are not acceptable.
  3. Filters shall be accessible through an access panel with “no-tool” removal as described in the unit cabinet section of this specification (23 81 19.13.G).

**23 81 19 Self-Contained Air Conditioners**

- 23 81 19.13 Small-Capacity Self-Contained Air Conditioners (48KC\*\*04-06)
- 23 81 19.13.A. General
  1. Outdoor, rooftop mounted, electrically controlled, heating and cooling unit utilizing a fully hermetic scroll compressor(s) for cooling duty and gas combustion for heating duty.
  2. Factory assembled, single-piece heating and cooling rooftop unit. Contained within the unit enclosure shall be all factory wiring, piping, controls, and special features required prior to field start-up.
  3. Unit shall use Puron refrigerant.
  4. Unit shall be installed in accordance with the manufacturer’s instructions.
  5. Unit must be selected and installed in compliance with local, state, and federal codes.

23 81 19.13.B. Quality Assurance

1. Unit meets ASHRAE 90.1 minimum efficiency requirements.
2. Unit shall be rated in accordance with AHRI Standards 210/240.
3. Unit shall be designed to conform to ASHRAE 15.
4. Unit shall be UL-tested and certified in accordance with ANSI Z21.47 Standards and UL-listed and certified under Canadian standards as a total package for safety requirements.
5. Insulation and adhesive shall meet NFPA 90A requirements for flame spread and smoke generation.
6. Unit casing shall be capable of withstanding 500-hour salt spray exposure per ASTM B117 (scribed specimen).
7. Unit shall be designed in accordance with ISO 9001, and shall be manufactured in a facility registered by ISO 9001.
8. Roof curb shall be designed to conform to NRCA Standards.
9. Unit shall be subjected to a completely automated run test on the assembly line. The data for each unit will be stored at the factory, and must be available upon request.
10. Unit shall be designed in accordance with UL Standard 1995, including tested to withstand rain.
11. Unit shall be constructed to prevent intrusion of snow and tested to prevent snow intrusion into the control box up to 40 mph.
12. Unit shake tested to assurance level 1, ASTM D4169 to ensure shipping reliability.

23 81 19.13.C. Delivery, Storage, and Handling

1. Unit shall be stored and handled per manufacturer’s recommendations.
2. Lifted by crane requires either shipping top panel or spreader bars.
3. Unit shall only be stored or positioned in the upright position.

23 81 19.13.D. Project Conditions

1. As specified in the contract.

23 81 19.13.E. Operating Characteristics

1. Unit shall be capable of starting and running at 115°F (46°C) ambient outdoor temperature, meeting maximum load criteria of AHRI Standard 210/240 at ± 10% voltage.
2. Compressor with standard controls shall be capable of operation down to 40°F (4°C), ambient outdoor temperatures. Accessory winter start kit is necessary if mechanically cooling at ambient temperatures down to 25°F (-4°C).
3. Unit shall discharge supply air vertically or horizontally as shown on contract drawings.
4. Unit shall be factory configured for vertical supply & return configurations.
5. Unit shall be field convertible from vertical to horizontal airflow on all models. No special kit required.

48KC

6. Unit shall be capable of mixed operation: vertical supply with horizontal return or horizontal supply with vertical return.

23 81 19.13.F. Electrical Requirements

1. Main power supply voltage, phase, and frequency must match those required by the manufacturer.

23 81 19.13.G. Unit Cabinet

1. Unit cabinet shall be constructed of galvanized steel, and shall be bonderized and coated with a prepainted baked enamel finish on all externally exposed surfaces.
2. Unit cabinet exterior paint shall be: film thickness, (dry) 0.003 inches minimum, gloss (per ASTM D523, 60°F / 16°C): 60, Hardness: H-2H Pencil hardness.
3. Evaporator fan compartment interior cabinet insulation shall conform to AHRI Standards 210/240 minimum exterior sweat criteria. Interior surfaces shall be insulated with a minimum 1/2-in. thick, 1 lb density, flexible fiberglass insulation, neoprene coated on the air side. Aluminum foil-faced fiberglass insulation shall be used in the gas heat compartment.
4. Base of unit shall have a minimum of four locations for thru-the-base gas and electrical connections (factory installed or field installed), standard.

5. Base Rail

- a. Unit shall have base rails on a minimum of 2 sides.
- b. Holes shall be provided in the base rails for rigging shackles to facilitate maneuvering and overhead rigging.
- c. Holes shall be provided in the base rail for moving the rooftop by fork truck.
- d. Base rail shall be a minimum of 16 gauge thickness.

6. Condensate pan and connections:

- a. Shall be a sloped condensate drain pan made of a non-corrosive material.
- b. Shall comply with ASHRAE Standard 62.
- c. Shall use a 3/4" -14 NPT drain connection, possible either through the bottom or side of the drain pan. Connection shall be made per manufacturer's recommendations.

7. Top panel:

- a. Shall be a single piece top panel on all sizes.

8. Gas Connections:

- a. All gas piping connecting to unit gas valve shall enter the unit cabinet at a single location on side of unit (horizontal plane).
- b. Thru-the-base capability
  - (1.) Standard unit shall have a thru-the-base gas-line location using a raised, embossed portion of the unit basepan.
  - (2.) Optional, factory approved, water-tight connection method must be used for thru-the-base gas connections.
  - (3.) No basepan penetration, other than those authorized by the manufacturer, is permitted.

9. Electrical Connections

- a. All unit power wiring shall enter unit cabinet at a single, factory prepared, knockout location.
- b. Thru-the-base capability.
  - (1.) Standard unit shall have a thru-the-base electrical location(s) using a raised, embossed portion of the unit basepan.
  - (2.) Optional, factory approved, water-tight connection method must be used for thru-the-base electrical connections.
  - (3.) No basepan penetration, other than those authorized by the manufacturer, is permitted.

10. Component access panels (standard)

- a. Cabinet panels shall be easily removable for servicing.
- b. Unit shall have one factory installed, tool-less, removable, filter access panel.
- c. Panels covering control box, indoor fan, indoor fan motor, gas components (where applicable), and compressors shall have molded composite handles.
- d. Handles shall be UV modified, composite. They shall be permanently attached, and recessed into the panel.
- e. Screws on the vertical portion of all removable access panel shall engage into heat resistant, molded composite collars.
- f. Collars shall be removable and easily replaceable using manufacturer recommended parts.

23 81 19.13.H. Gas Heat

1. General

- a. Heat exchanger shall be an induced draft design. Positive pressure heat exchanger designs shall not be allowed.
- b. Shall incorporate a direct-spark ignition system and redundant main gas valve.

- c. Gas supply pressure at the inlet to the rooftop unit gas valve must match that required by the manufacturer.
2. The heat exchanger shall be controlled by an integrated gas controller (IGC) microprocessor.
  - a. IGC board shall notify users of fault using an LED (light-emitting diode).
  - b. The LED shall be visible without removing the control box access panel.
  - c. IGC board shall contain algorithms that modify evaporator fan operation to prevent future cycling on high temperature limit switch.
  - d. Unit shall be equipped with anti-cycle protection with one short cycle on unit flame rollout switch or 4 continuous short cycles on the high temperature limit switch. Fault indication shall be made using an LED.
3. Standard Heat Exchanger construction
  - a. Heat exchanger shall be of the tubular-section type constructed of a minimum of 20-gauge steel coated with a nominal 1.2 mil aluminum-silicone alloy for corrosion resistance.
  - b. Burners shall be of the in-shot type constructed of aluminum-coated steel.
  - c. Burners shall incorporate orifices for rated heat output up to 2000 ft (610m) elevation. Additional accessory kits may be required for applications above 2000 ft (610m) elevation, depending on local gas supply conditions.
  - d. Each heat exchanger tube shall contain multiple dimples for increased heating effectiveness.
4. Optional Stainless Steel Heat Exchanger construction
  - a. Use energy saving, direct-spark ignition system.
  - b. Use a redundant main gas valve.
  - c. Burners shall be of the in-shot type constructed of aluminum-coated steel.
  - d. All gas piping shall enter the unit cabinet at a single location on side of unit (horizontal plane).
  - e. The optional stainless steel heat exchanger shall be of the tubular-section type, constructed of a minimum of 20-gauge type 409 stainless steel.
  - f. Type 409 stainless steel shall be used in heat exchanger tubes and vestibule plate.
  - g. Complete stainless steel heat exchanger allows for greater application flexibility.
5. Optional Low NO<sub>x</sub> Heat Exchanger construction
  - a. Low NO<sub>x</sub> reduction shall be provided to reduce nitrous oxide emissions to meet California's Air Quality Management District (SCAQMD) low-NO<sub>x</sub> emissions requirement of 40 nanograms per joule or less.
  - b. Primary tubes and vestibule plates on low NO<sub>x</sub> units shall be 409 stainless steel. Other components shall be aluminized steel.
6. Induced draft combustion motor and blower
  - a. Shall be a direct-drive, single inlet, forward-curved centrifugal type.
  - b. Shall be made from steel with a corrosion-resistant finish.
  - c. Shall have permanently lubricated sealed bearings.
  - d. Shall have inherent thermal overload protection.
  - e. Shall have an automatic reset feature.

#### 23 81 19.13.I. Coils

1. Standard Aluminum Fin - Copper Tube Coils:
  - a. Standard evaporator and condenser coils shall have aluminum lanced plate fins mechanically bonded to seamless internally grooved copper tubes with all joints brazed.
  - b. Evaporator coils shall be leak tested to 150 psig, pressure tested to 450 psig, and qualified to UL 1995 burst test at 1775 psig.
  - c. Condenser coils shall be leak tested to 150 psig, pressure tested to 650 psig, and qualified to UL 1995 burst test at 1980 psig.
2. Optional Pre-coated aluminum-fin condenser coils (3 Phase Models Only):
  - a. Shall have a durable epoxy-phenolic coating to provide protection in mildly corrosive coastal environments.
  - b. Coating shall be applied to the aluminum fin stock prior to the fin stamping process to create an inert barrier between the aluminum fin and copper tube.
  - c. Epoxy-phenolic barrier shall minimize galvanic action between dissimilar metals.
3. Optional Copper-fin evaporator and condenser coils (3 Phase Models Only):
  - a. Shall be constructed of copper fins mechanically bonded to copper tubes and copper tube sheets.
  - b. Galvanized steel tube sheets shall not be acceptable.
  - c. A polymer strip shall prevent coil assembly from contacting the sheet metal coil pan to minimize potential for galvanic corrosion between coil and pan.
4. Optional E-coated aluminum-fin evaporator and condenser coils (3 Phase Models Only):

- a. Shall have a flexible epoxy polymer coating uniformly applied to all coil surface areas without material bridging between fins.
- b. Coating process shall ensure complete coil encapsulation of tubes, fins and headers.
- c. Color shall be high gloss black with gloss per ASTM D523-89.
- d. Uniform dry film thickness from 0.8 to 1.2 mil on all surface areas including fin edges.
- e. Superior hardness characteristics of 2H per ASTM D3363-92A and cross-hatch adhesion of 4B-5B per ASTM D3359-93.
- f. Impact resistance shall be up to 160 in.-lb (ASTM D2794-93).
- g. Humidity and water immersion resistance shall be up to minimum 1000 and 250 hours respectively (ASTM D2247-92 and ASTM D870-92).
- h. Corrosion durability shall be confirmed through testing to be no less than 1000 hours salt spray per ASTM B117-90.

#### 23 81 19.13.J. Refrigerant Components

1. Refrigerant circuit shall include the following control, safety, and maintenance features:
  - a. Fixed orifice metering system shall prevent mal-distribution of two-phase refrigerant by including multiple fixed orifice devices in each refrigeration circuit. Each orifice is to be optimized to the coil circuit it serves.
  - b. Refrigerant filter drier - Solid core design.
  - c. Service gauge connections on suction and discharge lines.
  - d. Pressure gauge access through a specially designed access port in the top panel of the unit.
2. There shall be gauge line access port in the skin of the rooftop, covered by a black, removable plug.
  - a. The plug shall be easy to remove and replace.
  - b. When the plug is removed, the gauge access port shall enable maintenance personnel to route their pressure gauge lines.
  - c. This gauge access port shall facilitate correct and accurate condenser pressure readings by enabling the reading with the compressor access panel on.
  - d. The plug shall be made of a leak proof, UV-resistant, composite material.
3. Compressors
  - a. Unit shall use fully hermetic, scroll compressor for each independent refrigeration circuit.
  - b. Compressor motors shall be cooled by refrigerant gas passing through motor windings.
  - c. Compressors shall be internally protected from high discharge temperature conditions.
  - d. Compressors shall be protected from an over-temperature and over-amperage conditions by an internal, motor overload device.
  - e. Compressor shall be factory mounted on rubber grommets.
  - f. Compressor motors shall have internal line break thermal, current overload and high pressure differential protection.
  - g. Crankcase heaters shall not be required for normal operating range, unless required by compressor manufacturer due to refrigerant charge limits.

#### 23 81 19.13.K. Filter Section

1. Filters access is specified in the unit cabinet section of this specification.
2. Filters shall be held in place by a pivoting filter tray, facilitating easy removal and installation.
3. Shall consist of factory installed, low velocity, throw-away 2-in. thick fiberglass filters.
4. Filters shall be standard, commercially available sizes.
5. Only one size filter per unit is allowed.

#### 23 81 19.13.L. Evaporator Fan and Motor

1. Evaporator fan motor:
  - a. Shall have permanently lubricated bearings.
  - b. Shall have inherent automatic-reset thermal overload protection or circuit breaker.
  - c. Shall have a maximum continuous bhp rating for continuous duty operation; no safety factors above that rating shall be required.
2. Direct Drive ECM X13 - Evaporator Fan Standard:
  - a. Multi-speed motor with easy quick adjustment settings.
  - b. Blower fan shall be double-inlet type with forward-curved blades.
  - c. Shall be constructed from steel with a corrosion resistant finish and dynamically balanced.
3. Belt-driven Evaporator Fan Factory Optional:
  - a. Belt drive shall include an adjustable pitch motor pulley.

- b. Shall use sealed, permanently lubricated ball-bearing type.
- c. Blower fan shall be double-inlet type with forward-curved blades.
- d. Shall be constructed from steel with a corrosion resistant finish and dynamically balanced.

23 81 19.13.M. Condenser Fans and Motors

- 1. Condenser fan motors:
  - a. Shall be a totally enclosed motor.
  - b. Shall use permanently lubricated bearings.
  - c. Shall have inherent thermal overload protection with an automatic reset feature.
  - d. Shall use a shaft-down design on all sizes.
- 2. Condenser Fans:
  - a. Shall be a direct-driven propeller type fan.
  - b. Shall have galvalum blades riveted to corrosion-resistant steel spiders and shall be dynamically balanced.

23 81 19.13.N. Special Features Options and Accessories

- 1. Integrated EconoMi\$er IV, EconoMi\$er2, and EconoMi\$er X standard leak rate models. (Factory installed on 3 phase models only. Field installed on all 3 and 1 phase models)
  - a. Integrated, gear driven opposing modulating blade design type capable of simultaneous economizer and compressor operation.
  - b. Independent modules for vertical or horizontal return configuration shall be available. Vertical return modules shall be available as a factory installed option.
  - c. Damper blades shall be galvanized steel with composite gears. Plastic or composite blades on intake or return shall not be acceptable.
  - d. Shall include all hardware and controls to provide free cooling with outdoor air when temperature and/or humidity are below setpoints.
  - e. Shall be equipped with gear driven dampers for both the outdoor ventilation air and the return air for positive air stream control.
  - f. Standard leak rate shall be equipped with dampers not to exceed 2% leakage at 1 in. wg pressure differential.
  - g. Economizer controller on EconoMi\$er IV models shall be Honeywell W7212 that provides:
    - (1.) Combined minimum and DCV maximum damper position potentiometers with compressor staging relay.
    - (2.) Functions with solid state analog enthalpy or dry bulb changeover control sensing.
    - (3.) Contain LED indicates for:
      - when free cooling is available, when module is in DCV mode, when exhaust fan contact is closed.
  - h. Economizer controller on EconoMi\$er X models shall be the Honeywell W7220 that provides:
    - (1.) 2-line LCD interface screen for setup, configuration and troubleshooting.
    - (2.) On-board Fault Detection and Diagnostics (FDD) that senses and alerts when the economizer is not operating properly, per California Title 24.
    - (3.) Sensor failure loss of communication identification
    - (4.) Automatic sensor detection
    - (5.) Capabilities for use with multiple-speed indoor fan systems
    - (6.) Utilize digital sensors: Dry bulb and Enthalpy
  - i. Economizer controller on EconoMi\$er 2 models with PremierLink shall be 4-20mA design and controlled by the PremierLink controller. PremierLink does not comply with California Title 24 Fault Detection & Diagnostic (FDD) requirements.
  - j. Economizer controller on EconoMi\$er 2 models with RTU Open models shall be a 4-20mA design controlled directly by the RTU Open controller. RTU Open meets California Title 24 Fault Detection & Diagnostic (FDD) requirements.
  - k. Shall be capable of introducing up to 100% outdoor air.
    - l. Shall be equipped with a barometric relief damper capable of relieving up to 100% return air and contain seals that meet ASHRAE 90.1 requirements.
  - m. Shall be designed to close damper(s) during loss-of-power situations with spring return built into motor.
  - n. Dry bulb outdoor air temperature sensor shall be provided as standard. Enthalpy sensor is also available on factory installed only. Outdoor air sensor setpoint shall be adjustable and shall range from 40 to 100°F /4 to 38°C. Additional sensor options shall be available as accessories.
  - o. The economizer controller shall also provide control of an accessory power exhaust unit function. Factory set at 100%, with a range of 0% to 100%.



- p. The economizer shall maintain minimum airflow into the building during occupied period and provide design ventilation rate for full occupancy.
  - q. Dampers shall be completely closed when the unit is in the unoccupied mode.
  - r. Economizer controller shall accept a 2-10 Vdc CO<sub>2</sub> sensor input for IAQ/DCV control. In this mode, dampers shall modulate the outdoor air damper to provide ventilation based on the sensor input.
  - s. Compressor lockout temperature on W7220 is adjustable from -45°F to 80°F, set at a factory default of 32°F. Others shall open at 35°F (2°C) and closes at 50°F (10°C).
  - t. Actuator shall be direct coupled to economizer gear. No linkage arms or control rods shall be acceptable.
  - u. Economizer controller shall provide indications when in free cooling mode, in the DCV mode, or the exhaust fan contact is closed.
2. Integrated EconoMiSer2, and EconoMiSer X Ultra Low Leak rate models. (Factory installed on 3 phase models only. Field installed on all 3 and 1 phase models)
- a. Integrated, gear driven opposing modulating blade design type capable of simultaneous economizer and compressor operation.
  - b. Independent modules for vertical or horizontal return configuration shall be available. Vertical return modules shall be available as a factory installed option.
  - c. Damper blades shall be galvanized steel with composite gears. Plastic or composite blades on intake or return shall not be acceptable.
  - d. Shall include all hardware and controls to provide free cooling with outdoor air when temperature and/or humidity are below setpoints.
  - e. Shall be equipped with gear driven dampers for both the outdoor ventilation air and the return air for positive air stream control
  - f. Ultra Low Leak design meets California Title 24 section 140.4 and ASHRAE90.1 requirements for 4 cfm per sq.ft. on the outside air dampers and 10 cfm per sq. ft. on the return dampers.
  - g. Economizer controller on EconoMiSer X models shall be the Honeywell W7220 that provides:
    - (1.) 2-line LCD interface screen for setup, configuration and troubleshooting
    - (2.) On-board Fault Detection and Diagnostics (FDD) that senses and alerts when the economizer is not operating properly, per California Title 24.
    - (3.) Sensor failure loss of communication identification
    - (4.) Automatic sensor detection
    - (5.) Capabilities for use with multiple-speed indoor fan systems
    - (6.) Utilize digital sensors: Dry bulb and Enthalpy
  - h. Economizer controller on EconoMiSer 2 models with RTU Open models shall be a 4-20mA design controlled directly by the RTU Open controller. RTU Open meets California Title 24 Fault Detection & Diagnostic (FDD) requirements.
  - i. Shall be capable of introducing up to 100% outdoor air.
  - j. Shall be equipped with a barometric relief damper capable of relieving up to 100% return air and contain seals that meet ASHRAE 90.1 requirements.
  - k. Shall be designed to close damper(s) during loss-of-power situations with spring return built into motor.
    - l. Dry bulb outdoor air temperature sensor shall be provided as standard. Enthalpy sensor is also available on factory installed only. Outdoor air sensor setpoint shall be adjustable and shall range from 40 to 100° F / 4 to 38° C. Additional sensor options shall be available as accessories.
  - m. The economizer controller shall also provide control of an accessory power exhaust unit function. Factory set at 100%, with a range of 0% to 100%.
  - n. The economizer shall maintain minimum airflow into the building during occupied period and provide design ventilation rate for full occupancy.
  - o. Dampers shall be completely closed when the unit is in the unoccupied mode.
  - p. Economizer controller shall accept a 2-10 Vdc CO<sub>2</sub> sensor input for IAQ/DCV control. In this mode, dampers shall modulate the outdoor air damper to provide ventilation based on the sensor input.
  - q. Compressor lockout temperature on W7220 is adjustable from -45° F to 80° F, set at a factory default of 32° F. Others shall open at 35°F (2°C) and closes at 50°F (10°C).
  - r. Actuator shall be direct coupled to economizer gear. No linkage arms or control rods shall be acceptable.
  - s. Economizer controller shall provide indications when in free cooling mode, in the DCV mode, or the exhaust fan contact is closed.
3. Two-Position Damper (Factory installed on 3 Phase Models Only. Field installed on all 3 and 1 Phase Models)

- a. Damper shall be a Two-Position Damper. Damper travel shall be from the full closed position to the field adjustable %-open setpoint.
  - b. Damper shall include adjustable damper travel from 25% to 100% (full open).
  - c. Damper shall include single or dual blade, gear driven dampers and actuator motor.
  - d. Actuator shall be direct coupled to damper gear. No linkage arms or control rods shall be acceptable.
  - e. Damper will admit up to 100% outdoor air for applicable rooftop units.
  - f. Damper shall close upon indoor (evaporator) fan shutoff and/or loss of power.
  - g. The damper actuator shall plug into the rooftop unit's wiring harness plug. No hard wiring shall be required.
  - h. Outside air hood shall include aluminum water entrainment filter.
4. Manual damper
- a. Manual damper package shall consist of damper, air inlet screen, and rain hood which can be preset to admit up to 25 or 50% outdoor air for year round ventilation.
5. Humidi-MiZer Adaptive Dehumidification System (3 Phase Models Only):
- a. The Humidi-MiZer Adaptive Dehumidification System shall be factory installed and shall provide greater dehumidification of the occupied space by two modes of dehumidification operations in addition to its normal design cooling mode:
    - (1.) Subcooling mode further sub cools the hot liquid refrigerant leaving the condenser coil when both temperature and humidity in the space are not satisfied.
    - (2.) Hot gas reheat mode shall mix a portion of the hot gas from the discharge of the compressor with the hot liquid refrigerant leaving the condenser coil to create a two-phase heat transfer in the system, resulting in a neutral leaving air temperature when only humidity in the space is not satisfied.
    - (3.) Includes head pressure controller.
6. Head Pressure Control Package
- a. Controller shall control coil head pressure by condenser fan speed modulation or condenser fan cycling and wind baffles.
  - b. Shall consist of solid-state control and condenser coil temperature sensor to maintain condensing temperature between 90°F (32°C) and 110°F (43°C) at outdoor ambient temperatures down to -20°F (-29°C).
7. Propane Conversion Kit
- a. Package shall contain all the necessary hardware and instructions to convert a standard natural gas unit for use with liquefied propane, up to 2000 ft (610m) elevation.
  - b. Additional accessory kits may be required for applications above 2000 ft (610m) elevation.
8. Flue Shield
- a. Flue shield shall provide protection from the hot sides of the gas flue hood.
9. Condenser Coil Hail Guard Assembly (Factory installed on 3 Phase Models Only. Field installed on all 3 and 1 Phase Models)
- a. Shall protect against damage from hail.
  - b. Shall be either hood style or louvered.
10. Unit-Mounted, Non-Fused Disconnect Switch (Available on units with MOCP's of 80 amps or less):
- a. Switch shall be factory installed, internally mounted.
  - b. National Electric Code (NEC) and UL approved non-fused switch shall provide unit power shutoff.
  - c. Shall be accessible from outside the unit.
  - d. Shall provide local shutdown and lockout capability.
11. Convenience Outlet:
- a. Powered convenience outlet. (3 Phase Models Only)
    - (1.) Outlet shall be powered from main line power to the rooftop unit.
    - (2.) Outlet shall be powered from line side or load side of disconnect by installing contractor, as required by code. If outlet is powered from load side of disconnect, unit electrical ratings shall be UL certified and rated for additional outlet amperage.
    - (3.) Outlet shall be factory installed and internally mounted with easily accessible 115-v female receptacle.
    - (4.) Outlet shall include 15 amp GFI receptacles with independent fuse protection.
    - (5.) Voltage required to operate convenience outlet shall be provided by a factory installed step-down transformer.
    - (6.) Outlet shall be accessible from outside the unit.
    - (7.) Outlet shall include a field installed "Wet in Use" cover.
  - b. Non-Powered convenience outlet.



- (1.) Outlet shall be powered from a separate 115/120v power source.
  - (2.) A transformer shall not be included.
  - (3.) Outlet shall be factory installed and internally mounted with easily accessible 115-v female receptacle.
  - (4.) Outlet shall include 15 amp GFI receptacles with independent fuse protection.
  - (5.) Outlet shall be accessible from outside the unit.
  - (6.) Outlet shall include a field installed "Wet in Use" cover.
12. Flue Discharge Deflector:
  - a. Flue discharge deflector shall direct unit exhaust vertically instead of horizontally.
  - b. Deflector shall be defined as a "natural draft" device by the National Fuel and Gas (NFG) code.
13. Thru-the-Base Connectors:
  - a. Kits shall provide connectors to permit gas and electrical connections to be brought to the unit through the unit basepan.
  - b. Minimum of four connection locations per unit.
14. Propeller Power Exhaust:
  - a. Power exhaust shall be used in conjunction with an integrated economizer.
  - b. Independent modules for vertical or horizontal return configurations shall be available.
  - c. Horizontal power exhaust is shall be mounted in return ductwork.
  - d. Power exhaust shall be controlled by economizer controller operation. Exhaust fans shall be energized when dampers open past the 0-100% adjustable setpoint on the economizer control.
15. Roof Curbs (Vertical):
  - a. Full perimeter roof curb with exhaust capability providing separate air streams for energy recovery from the exhaust air without supply air contamination.
  - b. Formed galvanized steel with wood nailer strip and shall be capable of supporting entire unit weight.
  - c. Permits installation and securing of ductwork to curb prior to mounting unit on the curb.
16. High Altitude Gas Conversion Kit:
  - a. Package shall contain all the necessary hardware and instructions to convert a standard natural gas unit to operate from 2000-7000 ft (610 to 2134m) elevation with natural gas or from 0-7000 ft (90-2134m) elevation with liquefied propane.
17. Outdoor Air Enthalpy Sensor:
  - a. The outdoor air enthalpy sensor shall be used to provide single enthalpy control. When used in conjunction with a return air enthalpy sensor, the unit will provide differential enthalpy control. The sensor allows the unit to determine if outside air is suitable for free cooling.
18. Return Air Enthalpy Sensor:
  - a. The return air enthalpy sensor shall be used in conjunction with an outdoor air enthalpy sensor to provide differential enthalpy control.
19. Indoor Air Quality (CO<sub>2</sub>) Sensor:
  - a. Shall be able to provide demand ventilation indoor air quality (IAQ) control.
  - b. The IAQ sensor shall be available in duct mount, wall mount, or wall mount with LED display. The setpoint shall have adjustment capability.
20. Smoke detectors (factory installed only):
  - a. Shall be a Four-Wire Controller and Detector.
  - b. Shall be environmental compensated with differential sensing for reliable, stable, and drift-free sensitivity.
  - c. Shall use magnet-activated test/reset sensor switches.
  - d. Shall have tool-less connection terminal access.
  - e. Shall have a recessed momentary switch for testing and resetting the detector.
  - f. Controller shall include:
    - (1.) One set of normally open alarm initiation contacts for connection to an initiating device circuit on a fire alarm control panel.
    - (2.) Two Form-C auxiliary alarm relays for interface with rooftop unit or other equipment.
    - (3.) One Form-C supervision (trouble) relay to control the operation of the Trouble LED on a remote test/reset station.
    - (4.) Capable of direct connection to two individual detector modules.
    - (5.) Can be wired to up to 14 other duct smoke detectors for multiple fan shutdown applications
21. Winter start kit
  - a. Shall contain a bypass device around the low pressure switch.
  - b. Shall be required when mechanical cooling is required down to 25°F (-4°C).

- c. Shall not be required to operate on an economizer when below an outdoor ambient of 40°F (4°C).
- 22. Time Guard
  - a. Shall prevent compressor short-cycling by providing a 5-minute delay ( $\pm 2$  minutes) before restarting a compressor after shutdown for any reason.
  - b. One device shall be required per compressor.
- 23. Hinged Access Panels
  - a. Shall provide easy access through integrated quarter turn latches.
  - b. Shall be on major panels of: filter, control box, fan motor, and compressor.



48KC

