

50ZHB
13 SEER Single Packaged Heat Pump System
with Puron® (R-410A) Refrigerant
Single Phase
2 to 5 Nominal Tons (024–060)



Product Data

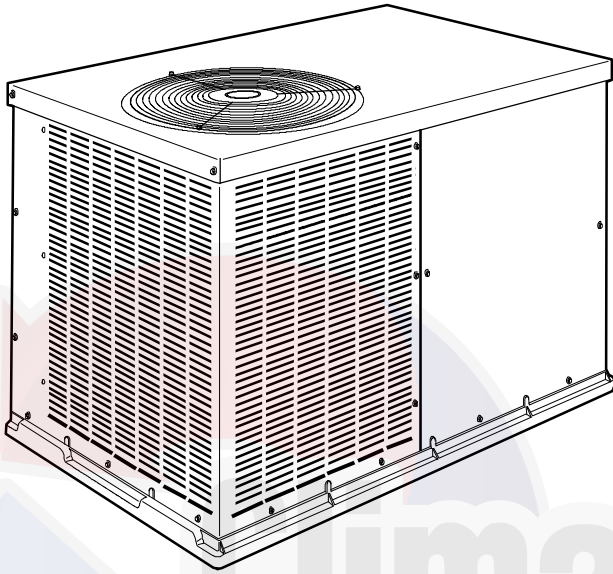

Fig. 1 - Unit 50ZHB

A10165

Single-Packaged Heat Pump Units with:

- easy installation design
- corrosion-proof unit base
- class leading sound ratings
- sloped drain for improved indoor air quality
- scroll compressors
- front and side service access
- louvered panel coil protection

FEATURES/BENEFITS

The 50ZHB unit is a packaged heat pump for manufactured housing, residential, and light commercial applications. Factory assembled package is a compact, horizontal supply and return unit, combining easy installation and maintenance with efficient performance.

EASY TO INSTALL—The 50ZHB units are lightweight, compact single package units that are easy to handle. Every size unit has an identical 32 by 51-in. (813 by 1295 mm) footprint to make job site planning simple. The efficient design uses less sheet metal and makes the 50ZHB units lighter than competitive units. The unit can be easily positioned on the job site with the hand-holds built into the unit basepan.

AERODYNAMIC FAN BLADE DESIGN reduces overall sound by up to 3dBA; low as 73dBA.

SERVICE ACCESS—The 50ZHB units are designed to be serviced from both front and side. Routine maintenance tasks, such as coil cleaning, are sped up with the multiple side panels design.

CORROSION PROOF UNIT BASE—The 50ZHB unit features a tough, high-tech, single-piece composite material unit base with an integrated drain. The composite material eliminates the potential problem of rust and premature replacement which are common with standard metal pans. Each 50ZHB unit base is sloped to eliminate standing water. This feature minimizes the amount of standing water inside the unit, which limits mold and mildew growth.

DURABLE STEEL CABINET—The watertight construction and corrosion-resistant finish of the 50ZHB unit will keep it looking like new for years. A specialized paint treatment process ensures quality protection against the elements. A compact, low-profile design utilizes a louvered coil enclosure for maximum protection against hail damage and vandalism.

SCROLL COMPRESSORS—Each 50ZHB unit comes standard with a scroll compressor. Each scroll compressor is hermetically sealed against contamination to help promote longer life and dependable operation. All scroll compressors have internal high-pressure and overcurrent protection.

COIL EFFICIENCY—Indoor and outdoor coils are computer designed for optimum heat transfer and cooling efficiency.

DEFROST SYSTEM—The system provides time/temperature-based defrost cycles to maintain unit efficiency. This highly reliable system monitors coil temperature and initiates a defrost cycle only if it is required. The defrost cycle ends as soon as defrosting is complete.

ACCESSORY ELECTRIC HEATERS—A variety of accessory electric heaters are available for the 50ZHB units. These heaters are comprised of a separate heater module mounted on the blower inlet and remote mounted controls located in the unit control box. Single point electrical connections are provided for powering both the heater and the unit.

START COLLARS—Start collars are provided with each unit to provide easy connection to the structure ductwork.

DEPENDABLE COMPONENTS—Direct-drive, multi-speed blower motor is standard on all models.

DIRECT-DRIVE, PSC OUTDOOR-FAN MOTORS are designed to help reduce energy consumption and provide for cooling operation down to 40°F (4.4°C). It's high efficiency design ensures high performance with most duct systems.

REFRIGERANT SYSTEM is designed to provide dependability. Liquid refrigerant filter driers are used to promote clean, unrestricted operation. Each unit leaves the factory with a full refrigerant charge and is fully run tested. Refrigerant service connections make checking operating pressure easier.

MODEL NUMBER NOMENCLATURE

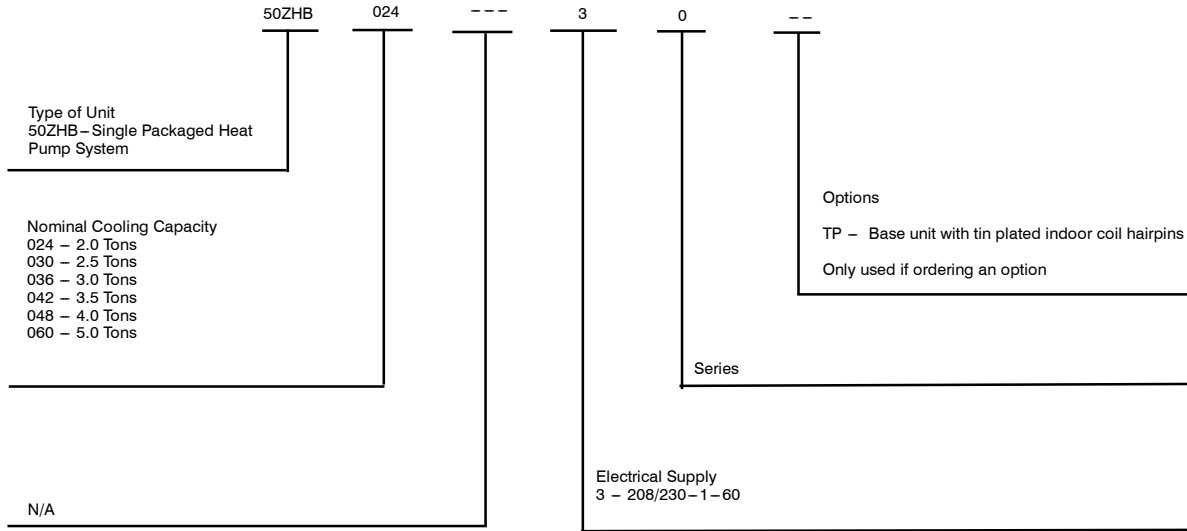

50ZHB

TABLE OF CONTENTS

	PAGE
FEATURES/BENEFITS	1
MODEL NUMBER NOMENCLATURE	2
AHRI CAPACITY RATINGS	3
PHYSICAL DATA	4
ACCESSORIES	5
DIMENSIONAL DRAWINGS	6-7
SELECTION PROCEDURE	8
PERFORMANCE DATA	9-18
TYPICAL WIRING SCHEMATICS	20
CONTROLS	21
APPLICATION DATA	21
GUIDE SPECIFICATIONS	22-23

AHRI* CAPACITIES

Cooling Capacities and Efficiencies

UNIT 50ZHB	NOMINAL TONS	STANDARD CFM	NET COOLING CAPACITY AT 95° F (35° C) (Btuh)	EER†	SEER**
024	2	800	24,000	11.50	13.50
030	2.5	1000	28,800	11.50	13.50
036	3	1200	36,000	11.50	13.50
042	3.5	1400	41,500	11.50	13.50
048	4	1600	46,500	11.50	13.50
060	5	1750	55,000	11.00	13.00

Heat Pump Heating Capacities and Efficiencies

UNIT 50ZHB	NET HEATING CAPACITY AT 47° F (8.3° C) (Btuh)	COP @ 17° F (-8.3° C)	NET HEATING CAPACITY AT 17° F (-8.3° C) (Btuh)	COP @ 17° F (-8.3° C)	HSPF**
024	23,800	3.7	13,200	2.3	7.7
030	28,600	3.7	15,600	2.3	7.7
036	34,400	3.5	18,800	2.2	7.7
042	41,000	3.6	23,200	2.3	7.7
048	46,500	3.6	27,000	2.3	7.7
060	55,000	3.4	31,800	2.2	7.7

LEGEND

dB---Sound Levels (decibels)

db—Dry Bulb

SEER—Seasonal Energy Efficiency Ratio

wb—Wet Bulb

COP---Coefficient of Performance

* Air Conditioning Heating & Refrigeration Institute

† At "A" conditions--80°F (26.7°C) indoor db/67°F (19.4°C) indoor wb & 95°F (35°C) outdoor db.

** Rated in accordance with U.S. Government DOE Department of Energy) test procedures and/or AHRI Standards 210/240.

Notes:

1. Ratings are net values, reflecting the effects of circulating fan heat.

Ratings are based on:

Cooling Standard: 80°F (26.7°C) db, 67°F wb (19.4°C) indoor entering---air temperature and 95°F db (35°C) outdoor entering---air temperature.

2. Before purchasing this appliance, read important energy cost and efficiency information available from your retailer.

50ZHB



Use of the AHRI Certified TM Mark indicates a manufacturer's participation in the program. For verification of certification for individual products, go to www.ahridirectory.org.



A-Weighted Sound Power Level (dBA)

UNIT 50ZHB	STANDARD RATING (dBA)	TYPICAL OCTAVE BAND SPECTRUM (dBA without tone adjustment)						
		125	250	500	1000	2000	4000	8000
024	73	61	63.5	68	65.5	59	52	46
030	74	65.5	63	65	64.5	61	56.5	53.5
036	75	64.5	68.5	69.5	69	64.5	59	51.5
042	77	70.5	67	72	70.5	65	60	51.5
048	76	68.5	70	70	70	65.5	60.5	53.5
060	79	66	71.5	72.5	74	70.5	65.5	57.5

PHYSICAL DATA

UNIT SIZE	024	030	036	042	048	060
NOMINAL CAPACITY (ton)	2	2.5	3	3.5	4	5
SHIPPING WEIGHT (lb)	312	314	334	388	407	420
(kg)	142	143	152	177	185	191
COMPRESSOR TYPE	SCROLL					
REFRIGERANT	R-410A					
REFRIGERANT QUANTITY (lb)	5.50	6.70	5.85	7.00	7.50	8.50
QUANTITY (kg)	2.49	3.04	2.65	3.18	3.40	3.86
OUTDOOR METERING DEVICE	Piston					
ORIFICE OD (in.)	0.049	0.049	0.057	0.061	0.067	0.073
(mm)	1.245	1.245	1.448	1.549	1.702	1.854
OUTDOOR COIL						
ROWS...FINS/in.	2...20	2...20	2...20	2...20	2...20	2...20
FACE AREA (sq. ft)	9.1	9.1	10.2	13.0	15.5	15.5
OUTDOOR FAN						
NOMINAL AIRFLOW (cfm)	2000	2000	2800	3100	2900	3200
DIAMETER (in.)	20	20	20	20	20	20
DIAMETER (mm)	508	508	508	508	508	508
MOTOR HP (RPM)	1/8 (825)	1/8 (825)	1/4 (1100)	1/4 (1100)	1/4 (1100)	1/3 (1110)
INDOOR METERING DEVICE	Piston					TXV
ORIFICE OD (in.)	0.059	0.059	0.067	0.073	0.080	N/A
(mm)	1.499	1.499	1.702	1.854	2.032	
INDOOR COIL						
ROWS...FINS/in.	3...12	3...12	3...12	3...12	3...12	3...12
FACE AREA (sq. ft)	4.3	4.3	4.9	4.9	4.9	6.1
INDOOR BLOWER						
NOMINAL COOLING AIRFLOW (cfm)	800	1000	1200	1400	1600	1750
NOMINAL SIZE D x L (in.)	10 x 8	10 x 8	11 x 9	11 x 9	11 x 10	11 x 10
(mm)	254 x 203	254 x 203	279 x 229	279 x 229	279 x 254	279 x 254
MOTOR (HP)	1/3	1/3	1/2	1/2	3/4	1
HIGH-PRESSURE SWITCH (psig)	650 +/- 15					
CUTOUT	420 +/- 25					
RESET (AUTO)						
LOW-PRESSURE SWITCH (psig)	20 +/- 5					
CUTOUT	45 +/- 10					
RESET (AUTO)						
RETURN-AIR FILTERS						
THROWAWAY (in.)	20x20x1	20x24x1	24x30x1		24x36x1	
(mm)	508x508x25	508x610x25	610x762x25		610x914x25	

*Required filter sizes shown are based on the AHRI (Air Conditioning Heating & Refrigeration Institute) rated airflow at a velocity of 300 ft/min (91 m) for throw-away type or 450 ft/min (137 m) for high capacity type. Recommended filters are 1-in. (25 mm) thick.

50ZHB

OPTIONS AND ACCESSORIES

ITEM	DESCRIPTION	FACTORY INSTALLED OPTION	FIELD INSTALLED ACCESSORY
Coil Options	Base unit with tin plated indoor coil hairpins	X	
Compressor Start Kit	Compressor Start Kit assists compressor start-up by providing additional starting torque.		X
Corporate Thermostats	Thermostats provide control for the system heating and cooling functions.		X
Crankcase Heater	Crankcase Heater provides anti-floodback protection for low-load cooling applications.		X*
Electric Heaters	Electric Heat Supplement		X
Low Ambient Kit	Low Ambient Kit (Motormaster II Control) allows the use of mechanical cooling down to outdoor temperatures as low as 0°F (-18° C) when properly installed.		X
Time Guard II	Automatically prevents the compressor from restarting for at least 4 minutes and 45 seconds after shutdown of the compressor. Not required when a corporate programmable thermostat is applied.		X

Refer to Price Pages for available accessories.

Accessory Electric Heater Usage

CATALOG ORDERING NO.	NOMINAL CAPACITY (kW)	CIRCUIT BREAKER (Yes/No)	STAGES	USED WITH SIZES					
				024	030	036	042	048	060
CPHEATER125A00	3.8 / 5.0	No	1	√	√	√	√		
CPHEATER126A00	3.8 / 5.0	Yes	1	√	√	√	√	√	√
CPHEATER127A00	5.6 / 7.5	No	2	√					
CPHEATER128A00	5.6 / 7.5	Yes	2	√	√	√	√	√	√
CPHEATER129A00	7.5 / 10.0	No	2	NONE					
CPHEATER130A00	7.5 / 10.0	Yes	2	√	√	√	√	√	√
CPHEATER131A00	11.3 / 15.0	Yes	2			√	√	√	√
CPHEATER132A00	15.0 / 20.0	Yes	2					√	√

√ Approved combination

50ZHB

Multiplication Factors

HEATER kW RATING	VOLTAGE DISTRIBUTION	MULTIPLICATION FACTOR
240	200	.69
	208	.75
	230	.92
	240	1.00

Example: 15.0 kW (at 240v) heater on 208v
 = 15.0 (.75 mult factor)
 = 11.25 capacity at 208v

BASE UNIT DIMENSIONS—50ZHB024-036

50ZHB

UNIT	ELECTRICAL CHARACTERISTICS		UNIT HEIGHT				CENTER OF GRAVITY IN (MM)					
	50ZHB024-...30	50ZHB030-...30	50ZHB036-...30	A	X	Y	Z	LBS.	KG.	X	Y	Z
50ZHB024-...30	208/230-1-60	208/230-1-60	208/230-1-60	30-1/8 (765)	14 (356)	19 (483)	14 (356)	263	120	14 (356)	19 (483)	14 (356)
50ZHB030-...30	208/230-1-60	208/230-1-60	208/230-1-60	30-1/8 (765)	14 (356)	19 (483)	14 (356)	264	120	14 (356)	19 (483)	14 (356)
50ZHB036-...30	208/230-1-60	208/230-1-60	208/230-1-60	34-1/8 (867)	14 (356)	19 (483)	16 (406)	285	130	14 (356)	19 (483)	16 (406)

REQUIRED CLEARANCES TO COMBUSTIBLE MATL.

TOP OF UNIT..... INCHES (MM) 0
 BOTTOM OF UNIT..... INCHES (MM) 0
 SIDE OF UNIT WITH DUCT OPENINGS..... INCHES (MM) 0
 SIDE OF UNIT OPPOSITE DUCT OPENINGS..... INCHES (MM) 0

NEC. REQUIRED CLEARANCES.

BETWEEN UNITS, POWER ENTRY SIDE..... INCHES (MM) 42.0 (1067)
 UNIT AND UNGROUND SURFACES, POWER ENTRY SIDE..... INCHES (MM) 36.0 (914)
 UNIT AND UNGROUND SURFACES, POWER ENTRY SIDE, OTHER..... INCHES (MM) 36.0 (914)
 GROUND SURFACES, POWER ENTRY SIDE..... INCHES (MM) 42.0 (1067)

REQUIRED CLEARANCE FOR SERVICING

TOP OF UNIT..... INCHES (MM) 30.0 (762)
 SIDE OF UNIT OPPOSITE DUCT OPENINGS..... INCHES (MM) 30.0 (762)
 SIDE OF UNIT WITH POWER ENTRY..... INCHES (MM) 30.0 (762)
 (EXCEPT FOR NEC REQUIREMENTS)

NOTE: CLEARANCES MUST BE MAINTAINED TO PREVENT RECIRCULATION OF AIR FROM OUTDOOR FAN DISCHARGE. A REMOVABLE FENCE OR BARRICADE REQUIRES NO CLEARANCE.

DIMENSIONS IN () ARE IN MM

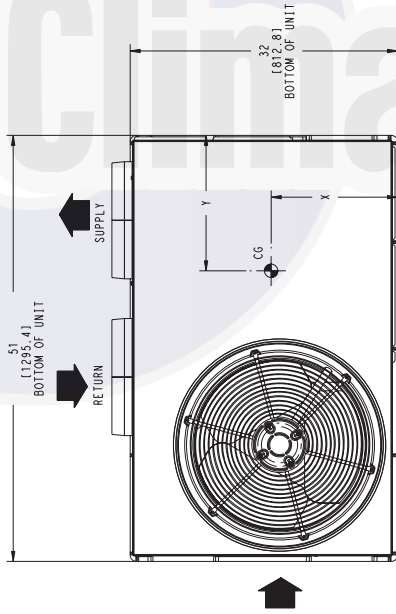

TOP VIEW

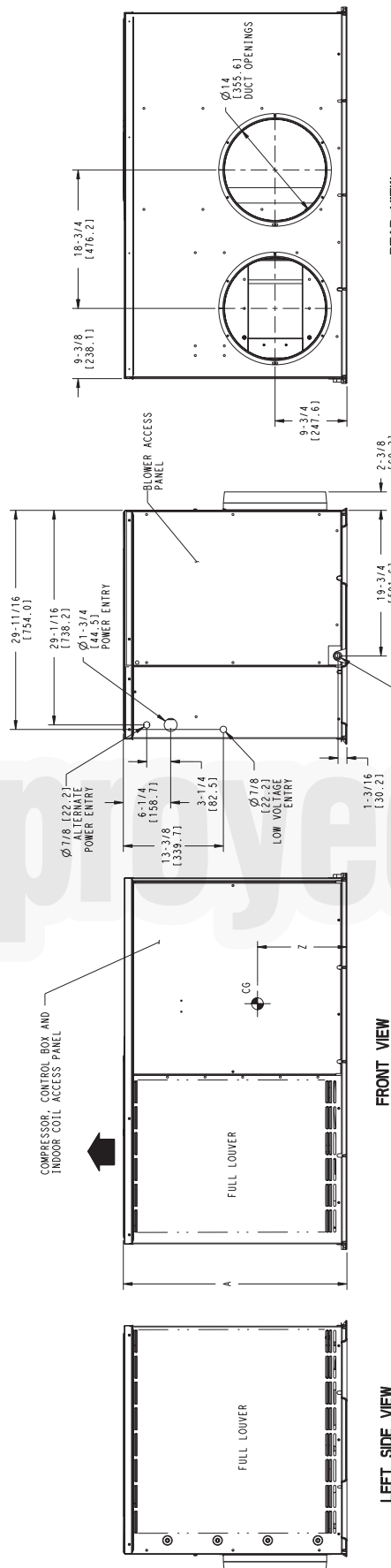

FRONT VIEW

LEFT SIDE VIEW

RIGHT SIDE VIEW

REAR VIEW

50ZHB500516	REV A
-------------	----------

BASE UNIT DIMENSIONS—50ZHB042-060

UNIT	ELECTRICAL CHARACTERISTICS		UNIT HEIGHT			CENTER OF GRAVITY IN [MM]		
	LBS.	KG.	A	X	Y	Z		
50ZHB042-...-30	339	154	42-1/8 (1070)	14 (356)	19 (483)	19-3/4 (503)		
50ZHB048-...-30	358	163	42-1/8 (1070)	14 (356)	19 (483)	19-3/4 (503)		
50ZHB060-...-30	371	169	42-1/8 (1070)	14 (356)	19 (483)	19-3/4 (503)		

REQUIRED CLEARANCES TO COMBUSTIBLE MATL.

TOP OF UNIT..... 0 INCHES (0MM)
 BOTTOM OF UNIT..... 0 INCHES (0MM)
 SIDE OF UNIT WITH DUCT OPENINGS..... 0 INCHES (0MM)
 SIDE OF UNIT OPPOSITE DUCT OPENINGS..... 0 INCHES (0MM)

NEC. REQUIRED CLEARANCES.

BETWEEN UNITS, POWER ENTRY SIDE..... 42.0 (1067) INCHES (MM)
 FROM COMBUSTIBLE SURFACES..... 42.0 (1067) INCHES (MM)
 UNIT AND BLOCK OF CONCRETE WALLS AND OTHER GROUND SURFACES, POWER ENTRY SIDE..... 42.0 (1067) INCHES (MM)

REQUIRED CLEARANCE FOR SERVICING

TOP OF UNIT..... 36.0 (914) INCHES (MM)
 SIDE OF UNIT OPPOSITE DUCT OPENINGS..... 30.0 (762) INCHES (MM)
 SIDE OF UNIT WITH POWER ENTRY..... 30.0 (762) INCHES (MM)
 (EXCEPT FOR NEC REQUIREMENTS)

NOTE: CLEARANCES MUST BE MAINTAINED TO PREVENT RECIRCULATION OF AIR FROM OUTDOOR FAN DISCHARGE. A REMOVABLE FENCE OR BARRICADE REQUIRES NO CLEARANCE.

DIMENSIONS IN [] ARE IN MM

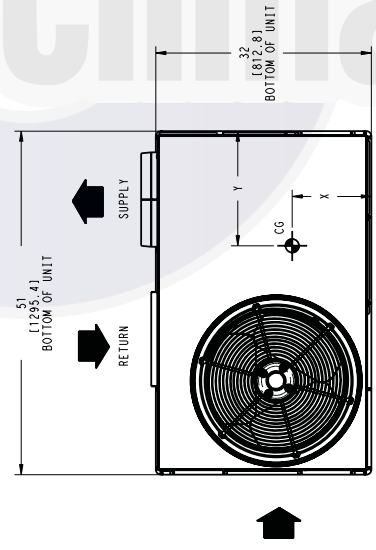

TOP VIEW

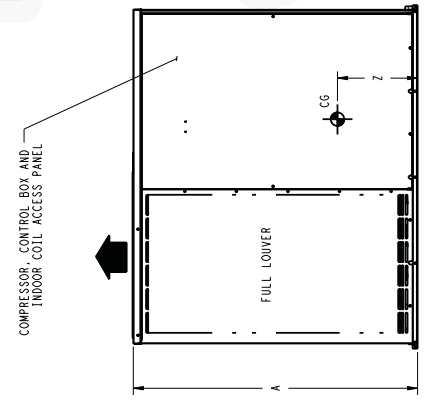

FRONT VIEW

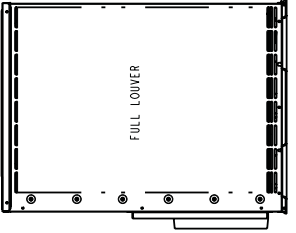

LEFT SIDE VIEW

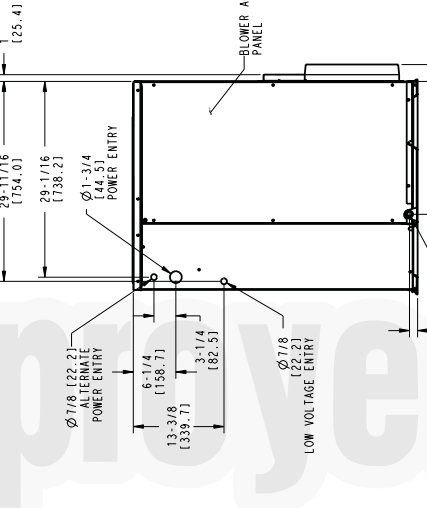

RIGHT SIDE VIEW

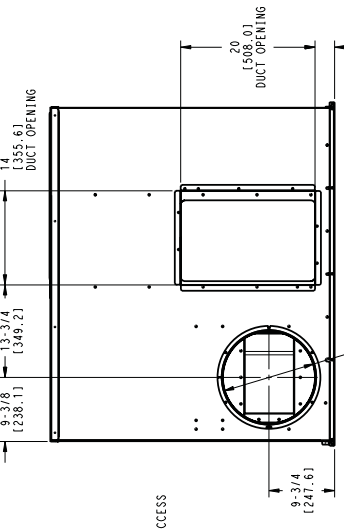

REAR VIEW

REV	A
50ZHB000473	

50ZHB

SELECTION PROCEDURE

I. DETERMINE COOLING AND HEATING REQUIREMENTS AT DESIGN CONDITIONS

Given:

- Required Cooling Capacity (TC) 28,000 Btuh
- Sensible Heat Capacity (SHC) 20,500 Btuh
- Required Heating Capacity 28,550 Btuh
- Outdoor Entering-Air Temperature 95°F (35°C)
- Outdoor-Air Winter Design Temperature 20°F (-6.7°C)
- Indoor-Air Winter Design Temperature 70°F (21.1°C)
- Indoor Entering-Air Temperature 80°F (26.7°C) edb, 67°F ewb (19.4°C)
- Indoor-Air Quantity 1000 CFM
- External Static Pressure 0.20 IN. W.C.
- Electrical Characteristics (V-Ph-Hz) 230-1-60 edb — entering dry bulb
ewb — entering wet bulb

II. SELECT UNIT BASED ON REQUIRED COOLING CAPACITY

Enter Cooling Capacities table at condenser entering temperature of 95°F (35°C), indoor air entering at 1000 cfm and 67°F (19.4°C) ewb (entering wet bulb). The 50ZHB030 unit will provide a total cooling capacity of 28,800 Btuh and a sensible heat capacity of 21,600 Btuh.

For indoor-air temperature other than 80°F edb (entering dry bulb), calculate sensible heat capacity correction, as required, using the formula found in Note 3 following the cooling capacities tables.

NOTE: Unit ratings are net capacities.

III. SELECT ELECTRIC HEAT

Enter the 50ZHB030 Heating Capacities table at 1000 CFM. At 70°F (21.1°C) return indoor air and 20°F (-6.7°C) air entering outdoor coil, the integrated heating capacity is 16,740 Btuh. (Select integrated heating capacity value since deductions for outdoor-coil frost and defrosting have already been made. No correction is required.)

The required heating capacity is 28,550 Btuh. Therefore, 11,810 Btuh (28,550 - 16,740) additional electric heat is required.

Determine additional electric heat capacity in kW.

$$\frac{11,810 \text{ Btuh}}{3414 \text{ Btuh/kW}} = 3.46 \text{ kW of heat required}$$

Enter the Accessory Electric Heater Usage table on page 4 for 208/240v. single-phase, 50ZHB030 unit. The 5-kW heater at 240v most closely satisfies the heating required. To calculate kW at 230v, multiply the heater kW by multiplication factor 0.92 found in the Multiplication Factors table on page 4.

$$5 \text{ kW} \times 0.92 = 4.6 \text{ kW}$$

$$4.6 \times 3414 = 15,704 \text{ Btuh}$$

To calculate kW at 208 v, see Multiplication Factors table on page 4.

Total unit heating capacity is 32,444 Btuh (16,740 +15,704).

IV. DETERMINE FAN SPEED AND POWER REQUIREMENTS AT DESIGN CONDITIONS

Before entering the air delivery tables, calculate the total static pressure required. From the given, the Accessory Electric Heat Pressure Drop table, and the Filter Pressure Drop table, find:

External static pressure	0.20 IN. W.C.
Filter	0.09 IN. W.C.
Electric heat	<u>0.04</u> IN. W.C.
Total static pressure	0.33 IN. W.C.

Enter the table for Dry Coil Air Delivery — Horizontal Discharge at 1000 CFM and 230v high speed. The blower will deliver 1036 CFM @ 0.40 IN W.C. static pressure. This will adequately handle job requirements.

BALANCE POINT WORKSHEET

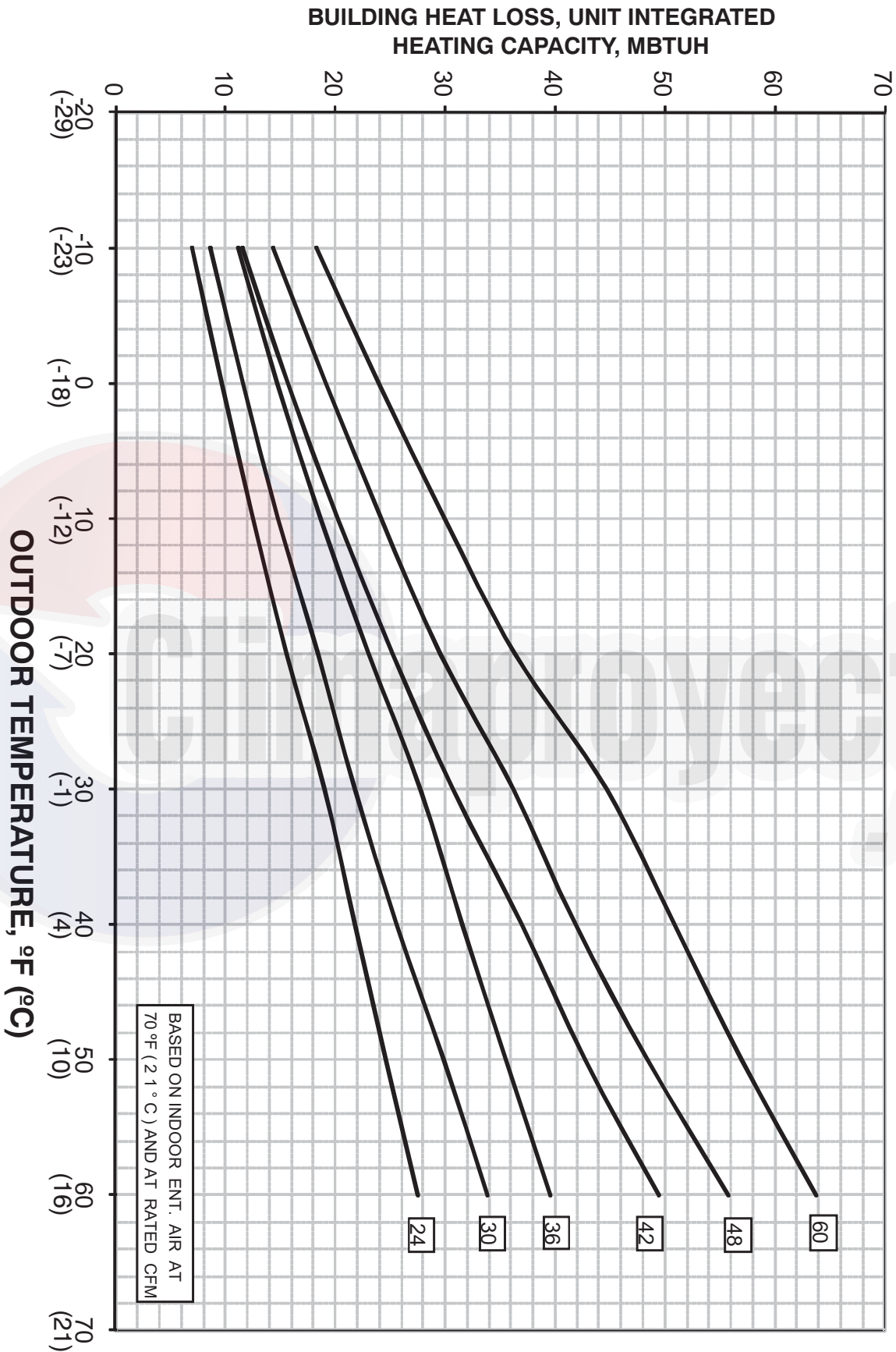

**PERFORMANCE DATA
COOLING CAPACITY
50ZHB024**

EVAPORATOR AIR		CONDENSER ENTERING AIR TEMPERATURES °F (°C)																	
		75 (24)			85 (29)			95 (35)			105 (41)			115 (46)			125 (52)		
		CFM / BF	EWB °F (°C)	Capacity MBtuh		Total Sys KW	Capacity MBtuh		Total Sys KW	Capacity MBtuh		Total Sys KW	Capacity MBtuh		Total Sys KW	Capacity MBtuh		Total Sys KW	
Total	Sens			Total	Sens		Total	Sens		Total	Sens		Total	Sens		Total	Sens		
700 / 0.08	57 (14)	22.96	22.96	1.61	22.41	22.41	1.82	21.85	21.85	2.05	20.67	20.67	2.30	19.14	19.14	2.58	17.50	17.50	2.90
	62 (17)	23.69	21.83	1.61	22.96	21.68	1.82	22.18	21.56	2.06	20.80	21.27	2.30	19.18	19.18	2.58	17.53	17.53	2.90
	63* (17)	24.01	17.90	1.62	23.29	17.65	1.83	22.50	17.48	2.06	21.20	17.16	2.30	19.18	16.18	2.58	16.93	15.19	2.89
800 / 0.10	67 (19)	25.13	17.88	1.62	24.56	17.79	1.84	23.72	17.60	2.07	22.89	17.60	2.33	21.31	19.11	2.61	19.11	16.34	2.91
	72 (22)	26.32	14.26	1.63	25.98	14.21	1.85	25.12	13.86	2.09	24.29	13.62	2.35	23.47	13.52	2.64	21.77	13.02	2.96
	57 (14)	23.63	23.63	1.63	23.07	23.07	1.84	22.46	22.46	2.07	21.68	21.68	2.33	20.19	20.19	2.61	18.49	18.49	2.92
900 / 0.11	62 (17)	24.06	22.94	1.63	23.37	22.84	1.84	22.60	22.82	2.07	21.71	21.71	2.33	20.22	20.22	2.61	18.53	18.53	2.92
	63 (17)	24.35	18.61	1.63	23.64	18.46	1.84	22.84	18.37	2.08	21.72	18.34	2.33	19.71	17.50	2.60	17.41	16.44	2.91
	67 (19)	25.41	18.51	1.64	24.88	18.54	1.86	24.00	18.38	2.09	23.13	18.35	2.35	21.77	18.42	2.63	19.57	17.63	2.93
50ZHB024	72 (22)	26.54	14.57	1.65	26.23	14.57	1.87	25.38	14.26	2.10	24.52	14.04	2.36	23.60	13.86	2.66	22.15	13.70	2.94
	57 (14)	24.11	23.60	1.64	23.60	23.60	1.86	22.95	22.95	2.09	22.34	22.34	2.35	21.00	21.00	2.63	19.26	19.26	2.94
	62 (17)	24.35	23.89	1.65	23.70	23.84	1.86	22.96	22.96	2.09	22.37	22.37	2.35	21.03	21.03	2.63	19.29	19.29	2.95
50ZHB024	63 (17)	24.59	19.25	1.65	23.92	19.21	1.86	23.08	19.15	2.09	22.09	19.38	2.34	20.12	18.68	2.62	17.82	17.62	2.93
	67 (19)	25.62	19.06	1.66	25.12	19.22	1.87	24.22	19.09	2.10	23.35	19.14	2.36	22.12	19.49	2.65	19.95	18.82	2.96
	72 (22)	26.70	14.83	1.66	26.39	14.85	1.89	25.57	14.60	2.12	24.68	14.39	2.38	23.72	14.27	2.67	22.41	14.30	3.00

See page 16 for cooling notes.

**HEATING CAPACITY
50ZHB024**

INDOOR AIR		OUTDOOR COIL ENTERING AIR TEMPERATURES °F (°C)																							
		-10 (-23)			0 (-18)			10 (-12)			20 (-7)			30 (-1)			40 (4)			50 (10)			60 (16)		
		Return Air db °F (°C)	CFM	Capacity MBtuh		Total Sys kW	Capacity MBtuh		Total Sys kW	Capacity MBtuh		Total Sys kW	Capacity MBtuh		Total Sys kW	Capacity MBtuh		Total Sys kW	Capacity MBtuh		Total Sys kW	Capacity MBtuh		Total Sys kW	
Total	Integ			Total	Integ		Total	Integ		Total	Integ		Total	Integ		Total	Integ		Total	Integ		Total	Integ		Total
65 (18)	700	7.28	6.89	1.47	9.83	9.14	1.58	12.73	11.69	1.65	15.77	14.31	1.71	19.17	16.80	1.76	22.00	22.00	1.80	24.93	24.93	1.86	28.00	28.00	1.93
	800	7.38	6.79	1.47	10.06	9.26	1.57	12.89	11.83	1.64	16.00	14.51	1.69	19.24	16.86	1.73	22.03	22.03	1.76	24.89	24.89	1.80	27.83	27.83	1.86
	900	7.47	6.88	1.48	10.19	9.37	1.57	13.05	11.98	1.63	16.17	14.67	1.67	19.28	16.90	1.70	22.02	22.02	1.73	24.80	24.80	1.76	27.58	27.58	1.80
70 (21)	700	6.86	6.31	1.54	9.53	8.77	1.65	12.35	11.33	1.73	15.38	13.95	1.79	18.97	16.62	1.85	21.76	21.76	1.90	24.66	24.66	1.96	27.67	27.67	2.03
	800	6.97	6.42	1.54	9.68	8.91	1.65	12.52	11.49	1.72	15.59	14.14	1.77	19.05	16.69	1.82	21.81	21.81	1.85	24.65	24.65	1.90	27.55	27.55	1.96
	900	7.08	6.51	1.55	9.80	9.02	1.65	12.67	11.63	1.71	15.77	14.30	1.76	19.10	16.73	1.79	21.82	21.82	1.82	24.59	24.59	1.86	27.34	27.34	1.90
75 (24)	700	6.38	5.87	1.61	9.11	8.38	1.73	11.94	10.96	1.81	14.96	13.57	1.88	18.68	16.37	1.96	21.53	21.53	2.00	24.41	24.41	2.06	27.35	27.35	2.14
	800	6.50	5.98	1.61	9.25	8.51	1.73	12.11	11.12	1.80	15.18	13.76	1.86	18.85	16.51	1.92	21.58	21.58	1.95	24.41	24.41	2.00	27.27	27.27	2.06
	900	6.62	6.09	1.62	9.38	8.63	1.72	12.26	11.25	1.79	15.35	13.92	1.84	18.92	16.57	1.89	21.60	21.60	1.92	24.34	24.34	1.96	27.07	27.07	2.01

PERFORMANCE DATA (CONT)

COOLING CAPACITY

50ZHB030

EVAPORATOR AIR		CONDENSER ENTERING AIR TEMPERATURES °F (°C)																	
		75 (24)			85 (29)			95 (35)			105 (41)			115 (46)			125 (52)		
		CFM / BF	EWB °F (°C)	Capacity MBtuh		Total Sys kW	Capacity MBtuh		Total Sys kW	Capacity MBtuh		Total Sys kW	Capacity MBtuh		Total Sys kW	Capacity MBtuh		Total Sys kW	
Total	Sens			Total	Sens		Total	Sens		Total	Sens		Total	Sens					
875 / 0.08	57 (14)	27.82	27.82	1.97	27.30	27.30	2.20	26.53	26.53	2.45	25.50	25.50	2.75	24.19	24.19	3.08	22.57	22.57	3.47
	62 (17)	28.38	25.57	1.98	27.75	25.67	2.20	26.84	25.54	2.46	25.09	25.09	2.75	24.24	24.24	3.08	22.60	22.60	3.47
	63 (17)	28.69	20.76	1.98	28.06	20.76	2.21	27.16	20.58	2.46	20.16	20.16	2.75	24.37	19.46	3.08	22.28	18.53	3.45
	67 (19)	29.82	20.56	1.99	29.31	20.71	2.22	28.51	20.67	2.48	20.44	20.44	2.77	26.01	20.06	3.10	24.38	19.55	3.48
	72 (22)	31.10	16.25	2.00	30.75	16.22	2.24	30.03	16.06	2.50	15.79	15.79	2.80	27.80	15.42	3.13	26.20	14.93	3.51
	57 (14)	28.43	28.43	2.00	27.96	27.96	2.23	27.26	27.26	2.49	26.29	26.29	2.78	25.07	25.07	3.11	23.66	23.66	3.49
	62 (17)	28.74	26.78	2.00	28.15	27.00	2.23	27.28	27.28	2.49	26.31	26.31	2.78	25.10	25.10	3.11	23.69	23.69	3.49
	63 (17)	28.99	21.57	2.00	28.39	21.71	2.23	27.51	21.66	2.49	26.30	21.37	2.78	24.79	20.84	3.11	22.73	19.92	3.49
	67 (19)	30.09	21.27	2.01	29.60	21.54	2.24	28.80	21.60	2.50	21.48	21.48	2.80	26.31	21.22	3.13	24.66	20.78	3.51
	72 (22)	31.31	16.55	2.02	30.99	16.61	2.26	30.28	16.51	2.52	16.30	16.30	2.82	28.04	15.98	3.16	26.45	15.54	3.54
	57 (14)	28.85	28.85	2.02	28.44	28.44	2.25	27.77	27.77	2.51	26.82	26.82	2.81	25.64	25.64	3.14	24.25	24.25	3.52
	62 (17)	29.02	27.77	2.02	28.45	28.45	2.25	27.79	27.79	2.51	26.84	26.84	2.81	25.66	25.66	3.14	24.27	24.27	3.52
	63 (17)	29.21	22.27	2.03	28.63	22.55	2.26	27.76	22.62	2.51	26.56	22.44	2.80	25.09	22.04	3.13	23.18	21.25	3.51
	67 (19)	30.29	21.86	2.04	29.82	22.26	2.27	29.01	22.42	2.53	27.91	22.42	2.82	26.53	22.26	3.16	24.87	21.88	3.53
	72 (22)	31.49	16.86	2.05	31.16	16.94	2.28	30.46	16.89	2.55	16.74	16.74	2.84	28.22	16.46	3.18	26.63	16.08	3.56

See page 16 for cooling notes.

HEATING CAPACITY

50ZHB030

INDOOR AIR		OUTDOOR COIL ENTERING AIR TEMPERATURES °F (°C)																							
		-10 (-23)			0 (-18)			10 (-12)			20 (-7)			30 (-1)			40 (4)			50 (10)			60 (16)		
		Return Air °F (°C)	CFM	Capacity MBtuh		Total Sys kW	Capacity MBtuh		Total Sys kW	Capacity MBtuh		Total Sys kW	Capacity MBtuh		Total Sys kW	Capacity MBtuh		Total Sys kW	Capacity MBtuh		Total Sys kW	Capacity MBtuh		Total Sys kW	
Total	Integ			Total	Integ		Total	Integ		Total	Integ		Total	Integ		Total	Integ		Total	Integ		Total	Integ		
875	8.92	8.21	1.74	11.84	10.90	1.81	15.00	13.77	1.88	18.52	16.80	1.96	21.87	19.17	2.03	25.66	25.66	2.12	29.97	29.97	2.24	34.48	34.48	2.34	
1000	9.05	8.32	1.74	11.99	11.03	1.81	15.17	13.93	1.87	18.67	16.93	1.94	22.07	19.34	2.01	25.91	25.91	2.09	30.27	30.27	2.18	34.10	34.10	2.27	
1125	9.16	8.43	1.75	12.12	11.15	1.81	15.34	14.08	1.87	18.80	17.05	1.93	22.24	19.48	1.99	26.12	26.12	2.07	30.15	30.15	2.14	33.52	33.52	2.21	
875	8.51	7.83	1.82	11.47	10.55	1.90	14.63	13.42	1.97	18.30	16.60	2.06	21.60	18.93	2.14	25.33	25.33	2.23	29.56	29.56	2.34	34.13	34.13	2.46	
1000	8.65	7.96	1.83	11.63	10.70	1.89	14.81	13.59	1.96	18.45	16.74	2.04	21.80	19.10	2.11	25.59	25.59	2.19	29.89	29.89	2.30	33.85	33.85	2.38	
1125	8.77	8.07	1.84	11.77	10.83	1.90	14.97	13.74	1.96	18.58	16.85	2.03	21.97	19.25	2.09	25.80	25.80	2.17	29.95	29.95	2.25	33.38	33.38	2.33	
875	8.05	7.41	1.90	11.06	10.17	1.99	14.23	13.06	2.07	18.03	16.35	2.17	21.33	18.69	2.25	25.00	25.00	2.34	29.16	29.16	2.46	33.79	33.79	2.58	
1000	8.19	7.54	1.91	11.22	10.32	1.99	14.41	13.23	2.06	18.20	16.51	2.15	21.52	18.86	2.22	25.25	25.25	2.30	29.48	29.48	2.41	33.58	33.58	2.50	
1125	8.31	7.65	1.92	11.36	10.45	1.99	14.57	13.38	2.05	18.35	16.64	2.14	21.69	19.00	2.20	25.47	25.47	2.28	29.68	29.68	2.36	33.18	33.18	2.44	

PERFORMANCE DATA (CONT)
COOLING CAPACITY
50ZHB036

EVAPORATOR AIR		CONDENSER ENTERING AIR TEMPERATURES °F (°C)																	
		75 (24)			85 (29)			95 (35)			105 (41)			115 (46)			125 (52)		
		CFM / BF	EWB °F (°C)	Capacity MBtuh		Total Sys kW	Capacity MBtuh		Total Sys kW	Capacity MBtuh		Total Sys kW	Capacity MBtuh		Total Sys kW	Capacity MBtuh		Total Sys kW	
Total	Sens			Total	Sens		Total	Sens		Total	Sens		Total	Sens		Total	Sens		
1050/ 0.07	57 (14)	34.80	34.80	2.48	33.68	33.68	2.76	32.36	32.36	3.07	30.96	30.96	3.42	29.36	29.36	3.81	27.11	27.11	4.25
	62 (17)	35.83	32.61	2.49	34.48	32.11	2.77	32.91	31.40	3.07	30.68	30.68	3.42	29.40	29.40	3.81	27.15	27.15	4.25
	63* (17)	36.36	26.67	2.50	34.99	26.14	2.77	33.37	25.44	3.08	31.59	24.73	3.42	29.44	24.21	3.81	26.40	22.91	4.24
1200/ 0.08	67 (19)	38.38	26.96	2.51	37.11	26.57	2.79	35.50	25.95	3.10	33.63	25.17	3.45	31.66	24.52	3.84	29.23	24.13	4.28
	72 (22)	40.73	21.67	2.53	39.62	21.27	2.81	38.08	20.69	3.12	36.22	19.95	3.48	34.03	19.09	3.87	31.85	18.32	4.33
	57 (14)	35.86	35.86	2.52	34.74	34.74	2.80	33.39	33.39	3.11	31.88	31.88	3.46	30.41	30.41	3.85	28.30	28.30	4.30
1350/ 0.10	62 (17)	36.46	34.39	2.52	35.13	33.99	2.80	33.57	33.21	3.11	31.90	31.90	3.46	30.44	30.44	3.85	28.33	28.33	4.30
	63 (17)	36.90	27.87	2.53	35.55	27.41	2.80	33.90	26.75	3.11	32.04	26.02	3.46	30.02	25.74	3.85	27.04	24.67	4.28
	67 (19)	38.89	28.05	2.54	37.62	27.77	2.82	36.00	27.20	3.13	34.09	26.44	3.48	32.05	25.78	3.88	29.71	25.67	4.32
1350/ 0.10	72 (22)	41.16	22.23	2.56	40.07	21.90	2.84	38.52	21.34	3.16	36.64	20.63	3.51	34.40	19.76	3.91	32.17	18.97	4.36
	57 (14)	36.64	36.64	2.55	35.54	35.54	2.83	34.17	34.17	3.14	32.57	32.57	3.49	30.97	30.97	3.89	29.13	29.13	4.34
	62 (17)	36.96	35.90	2.55	35.68	35.46	2.83	34.18	34.18	3.14	32.60	32.60	3.49	31.00	31.00	3.89	29.16	29.16	4.34
1350/ 0.10	63 (17)	37.33	28.93	2.56	35.96	28.55	2.83	34.29	27.93	3.14	32.38	27.19	3.49	30.42	27.02	3.88	27.54	26.23	4.31
	67 (19)	39.26	29.02	2.57	38.01	28.83	2.85	36.36	28.31	3.16	34.43	27.58	3.51	32.34	26.90	3.91	30.07	26.98	4.36
	72 (22)	41.47	22.69	2.59	40.40	22.43	2.87	38.85	21.91	3.19	36.95	21.25	3.54	34.68	20.35	3.94	32.39	19.54	4.39

See page 16 for cooling notes.

HEATING CAPACITY
50ZHB036

INDOOR AIR		OUTDOOR COIL ENTERING AIR TEMPERATURES °F (°C)																							
		-10 (-23)			0 (-18)			10 (-12)			20 (-7)			30 (-1)			40 (4)			50 (10)			60 (16)		
		Return Air db °F (°C)	CFM	Capacity MBtuh		Total Sys kW	Capacity MBtuh		Total Sys kW	Capacity MBtuh		Total Sys kW	Capacity MBtuh		Total Sys kW	Capacity MBtuh		Total Sys kW	Capacity MBtuh		Total Sys kW	Capacity MBtuh		Total Sys kW	
Total	Integ			Total	Integ		Total	Integ		Total	Integ		Total	Integ		Total	Integ		Total	Integ		Total	Integ		Total
65 (18)	1050	11.54	10.82	2.30	15.05	13.85	2.39	18.95	17.89	2.49	23.38	21.20	2.60	27.98	24.52	2.70	31.92	31.92	2.79	36.05	36.05	2.88	40.34	40.34	2.99
	1200	11.73	10.79	2.31	15.27	14.05	2.39	19.21	17.63	2.48	23.78	21.56	2.58	28.06	24.59	2.66	31.92	31.92	2.74	35.94	35.94	2.82	40.00	40.00	2.90
	1350	11.90	10.95	2.32	15.46	14.23	2.40	19.42	17.83	2.48	24.29	22.03	2.59	28.07	24.59	2.64	31.86	31.86	2.71	35.73	35.73	2.78	39.47	39.47	2.84
70 (21)	1050	10.95	10.08	2.41	14.50	13.34	2.51	18.42	16.90	2.61	22.76	20.64	2.71	27.71	24.28	2.83	31.59	31.59	2.92	35.66	35.66	3.02	39.91	39.91	3.13
	1200	11.15	10.25	2.42	14.72	13.55	2.51	18.67	17.14	2.60	23.07	20.92	2.69	27.78	24.34	2.79	31.61	31.61	2.87	35.59	35.59	2.96	39.62	39.62	3.04
	1350	11.31	10.41	2.44	14.91	13.72	2.52	18.89	17.34	2.60	23.35	21.17	2.69	27.83	24.38	2.77	31.57	31.57	2.84	35.43	35.43	2.91	39.19	39.19	2.98
75 (24)	1050	10.32	9.49	2.54	13.90	12.79	2.63	17.85	16.38	2.73	22.18	20.12	2.84	27.45	24.05	2.98	31.26	31.26	3.07	35.27	35.27	3.17	39.45	39.45	3.28
	1200	10.51	9.67	2.55	14.12	13.00	2.63	18.11	16.62	2.73	22.49	20.40	2.82	27.54	24.13	2.94	31.29	31.29	3.01	35.23	35.23	3.10	39.24	39.24	3.19
	1350	10.67	9.82	2.56	14.31	13.17	2.64	18.33	16.82	2.72	22.75	20.63	2.81	27.60	24.18	2.91	31.28	31.28	2.98	35.11	35.11	3.06	38.87	38.87	3.13

PERFORMANCE DATA (CONT)
COOLING CAPACITY
50ZHB042

EVAPORATOR AIR		CONDENSER ENTERING AIR TEMPERATURES °F (°C)																	
		75 (24)			85 (29)			95 (35)			105 (41)			115 (46)			125 (52)		
		CFM / BF	EWB °F (°C)	Capacity MBtuh		Total Sys kW	Capacity MBtuh		Total Sys kW	Capacity MBtuh		Total Sys kW	Capacity MBtuh		Total Sys kW	Capacity MBtuh		Total Sys kW	
Total	Sens			Total	Sens		Total	Sens		Total	Sens		Total	Sens		Total	Sens		
1225 / 0.11	57 (14)	39.44	39.44	2.86	37.89	37.89	3.16	35.26	35.26	3.49	32.83	32.83	3.86	30.29	30.29	4.29	27.53	27.53	4.77
	62 (17)	40.83	36.35	2.87	38.87	35.37	3.17	35.71	33.63	3.49	32.88	32.88	3.86	30.33	30.33	4.29	27.57	27.57	4.77
	63* (17)	41.77	29.61	2.87	39.75	28.75	3.18	36.73	27.48	3.50	33.21	26.03	3.87	29.73	24.59	4.28	25.94	22.96	4.74
1400 / 0.12	67 (19)	45.20	30.87	2.90	43.07	30.03	3.21	40.81	29.14	3.56	37.31	27.80	3.92	33.36	26.29	4.33	29.48	24.79	4.80
	72 (22)	50.06	25.07	2.95	47.76	24.23	3.26	45.31	23.37	3.61	42.72	22.45	4.01	39.72	21.41	4.44	34.69	19.71	4.89
	57 (14)	40.99	40.99	2.91	39.36	39.36	3.22	37.54	37.54	3.56	34.31	34.31	3.92	31.63	31.63	4.35	28.76	28.76	4.83
1575 / 0.14	62 (17)	41.70	38.58	2.91	39.63	39.63	3.22	37.60	37.60	3.56	34.36	34.36	3.92	31.67	31.67	4.35	28.79	28.79	4.83
	63 (17)	42.59	31.37	2.92	40.50	30.50	3.23	38.19	29.53	3.57	33.90	27.77	3.92	30.31	26.24	4.33	26.48	24.45	4.79
	67 (19)	46.07	32.76	2.95	43.87	31.91	3.26	41.50	31.00	3.61	38.85	29.98	3.99	34.05	28.14	4.38	30.05	26.52	4.85
1575 / 0.14	72 (22)	51.04	26.26	3.00	48.65	25.41	3.32	46.10	24.53	3.67	43.42	23.60	4.06	40.39	22.57	4.50	35.44	20.92	4.95
	57 (14)	42.35	42.35	2.96	40.65	40.65	3.27	38.82	38.82	3.62	35.74	35.74	3.98	32.82	32.82	4.41	29.82	29.82	4.89
	62 (17)	42.53	42.53	2.96	40.70	40.70	3.27	38.86	38.86	3.62	35.78	35.78	3.98	32.86	32.86	4.41	29.85	29.85	4.89
1575 / 0.14	63 (17)	43.27	33.10	2.97	41.11	32.21	3.27	38.76	31.24	3.62	34.51	29.44	3.96	30.83	27.78	4.38	26.99	26.99	4.84
	67 (19)	46.80	34.63	3.00	44.50	33.75	3.31	42.09	32.83	3.66	39.37	31.78	4.04	34.65	29.90	4.44	30.55	28.07	4.90
72 (22)	51.83	27.42	3.05	49.36	26.56	3.36	46.75	25.67	3.72	43.98	24.73	4.11	40.93	23.70	4.55	36.05	22.10	5.00	

See page 16 for cooling notes.

HEATING CAPACITY
50ZHB042

INDOOR AIR		OUTDOOR COIL ENTERING AIR TEMPERATURES °F (°C)																							
		-10 (-23)			0 (-18)			10 (-12)			20 (-7)			30 (-1)			40 (4)			50 (10)			60 (16)		
		Return Air db °F (°C)	CFM	Capacity MBtuh		Total Sys kW	Capacity MBtuh		Total Sys kW	Capacity MBtuh		Total Sys kW	Capacity MBtuh		Total Sys kW	Capacity MBtuh		Total Sys kW	Capacity MBtuh		Total Sys kW	Capacity MBtuh		Total Sys kW	
Total	Integ			Total	Integ		Total	Integ		Total	Integ		Total	Integ		Total	Integ		Total	Integ		Total	Integ		Total
65 (18)	1225	12.14	11.17	2.54	16.20	14.90	2.65	20.68	18.98	2.77	25.59	23.21	2.90	31.13	27.28	3.05	37.09	37.09	3.24	42.85	42.85	3.42	49.49	49.49	3.66
	1400	12.39	11.40	2.56	16.49	15.17	2.66	21.02	19.29	2.78	25.98	23.56	2.89	31.77	27.84	3.04	37.47	37.47	3.20	43.38	43.38	3.37	50.17	50.17	3.58
	1575	12.62	11.61	2.58	16.72	15.38	2.68	21.29	19.54	2.78	26.30	23.86	2.89	32.51	28.49	3.04	37.84	37.84	3.17	43.84	43.84	3.33	50.78	50.78	3.53
70 (21)	1225	11.34	10.44	2.65	15.44	14.20	2.77	19.93	18.30	2.90	24.86	22.84	3.03	30.27	26.52	3.18	36.59	36.59	3.40	42.22	42.22	3.58	48.72	48.72	3.83
	1400	11.56	10.63	2.67	15.69	14.43	2.79	20.24	18.58	2.90	25.22	22.87	3.02	30.70	26.90	3.16	36.98	36.98	3.36	42.72	42.72	3.52	49.41	49.41	3.75
	1575	11.77	10.83	2.70	15.95	14.67	2.80	20.54	18.85	2.91	25.57	23.19	3.02	31.12	27.27	3.15	37.32	37.32	3.33	43.18	43.18	3.48	49.98	49.98	3.89
75 (24)	1225	10.50	9.68	2.78	14.61	13.45	2.90	19.14	17.57	3.03	24.09	21.85	3.17	29.48	25.63	3.32	36.02	36.02	3.56	41.59	41.59	3.76	47.96	47.96	4.00
	1400	10.74	9.88	2.80	14.89	13.70	2.92	19.48	17.88	3.03	24.48	22.20	3.16	29.93	26.23	3.30	36.44	36.44	3.52	42.07	42.07	3.70	48.62	48.62	3.92
	1575	10.95	10.08	2.83	15.16	13.95	2.93	19.78	18.16	3.04	24.81	22.50	3.16	30.33	26.57	3.29	36.81	36.81	3.49	42.52	42.52	3.65	49.20	49.20	3.87

PERFORMANCE DATA (CONT)
COOLING CAPACITY
50ZHB048

EVAPORATOR AIR		CONDENSER ENTERING AIR TEMPERATURES °F (°C)																	
		75 (24)			85 (29)			95 (35)			105 (41)			115 (46)			125 (52)		
		CFM / BF	EWB °F (°C)	Total Sys kW	Capacity MBtuh	Total Sys kW	Capacity MBtuh	Total Sys kW	Capacity MBtuh	Total Sys kW	Capacity MBtuh	Total Sys kW	Capacity MBtuh	Total Sys kW	Capacity MBtuh	Total Sys kW	Capacity MBtuh	Total Sys kW	
		57 (14)	45.20	3.18	43.33	43.33	41.34	3.95	38.12	38.12	4.35	35.13	35.13	4.81	32.15	32.15	5.34		
		62 (17)	46.71	3.18	44.37	40.56	41.96	3.95	38.15	38.15	4.35	35.19	35.19	4.81	32.20	32.20	5.34		
		63* (17)	47.53	3.18	45.11	32.92	42.59	3.96	38.58	29.94	4.36	34.57	28.26	4.80	30.67	26.63	5.30		
		67 (19)	50.36	3.19	48.45	34.13	45.76	3.99	42.98	31.89	4.43	38.86	30.18	4.90	34.57	28.52	5.40		
		72 (22)	55.43	3.21	52.74	27.63	49.88	4.04	46.91	25.38	4.49	43.79	24.21	4.97	39.86	22.94	5.50		
		57 (14)	47.06	3.22	45.06	45.06	42.96	4.01	40.20	40.20	4.44	36.87	36.87	4.90	33.65	33.65	5.42		
		62 (17)	47.78	3.22	45.42	43.39	42.99	4.01	40.27	40.27	4.45	36.93	36.93	4.90	33.71	33.71	5.42		
		63 (17)	48.45	3.22	45.95	34.89	43.34	4.01	39.68	32.11	4.43	35.40	30.31	4.86	31.36	28.61	5.36		
		67 (19)	51.88	3.23	49.26	36.11	46.50	4.04	43.61	33.83	4.48	39.76	32.48	4.95	35.41	30.72	5.47		
		72 (22)	56.33	3.25	53.54	28.78	50.61	4.09	47.54	26.48	4.54	44.33	25.28	5.02	40.46	24.19	5.55		
		57 (14)	48.51	3.26	46.40	46.40	44.19	4.06	41.80	41.80	4.50	38.40	38.40	4.98	35.00	35.00	5.50		
		62 (17)	48.74	3.26	46.43	46.43	44.24	4.06	41.85	41.85	4.50	38.45	38.45	4.98	35.05	35.05	5.50		
		63 (17)	49.16	3.27	46.57	36.66	43.90	4.06	40.60	34.14	4.49	36.11	32.25	4.92	31.98	30.41	5.42		
		67 (19)	52.56	3.28	49.88	37.94	47.03	4.09	44.10	35.61	4.53	40.41	34.58	5.01	36.05	32.74	5.53		
		72 (22)	57.00	3.30	54.15	29.81	51.17	4.14	48.00	27.47	4.59	44.74	26.23	5.07	40.90	25.30	5.60		

See page 16 for cooling notes.

HEATING CAPACITY
50ZHB048

INDOOR AIR		OUTDOOR COIL ENTERING AIR TEMPERATURES °F (°C)																							
		-10 (-23)			0 (-18)			10 (-12)			20 (-7)			30 (-1)			40 (4)			50 (10)			60 (16)		
		Return Air db °F (°C)	CFM	Capacity MBtuh	Total Sys kW	Capacity MBtuh	Total Sys kW	Capacity MBtuh	Total Sys kW	Capacity MBtuh	Total Sys kW	Capacity MBtuh	Total Sys kW	Capacity MBtuh	Total Sys kW	Capacity MBtuh	Total Sys kW	Capacity MBtuh	Total Sys kW						
		1400	14.74	13.56	2.91	19.51	17.95	3.03	24.50	22.49	3.16	29.84	27.08	3.30	36.36	31.86	3.49	42.03	36.5	48.56	38.3	56.09	4.03		
		1600	14.97	13.78	2.93	19.78	18.20	3.05	24.81	22.77	3.17	30.21	27.40	3.29	36.69	32.15	3.47	42.45	36.1	49.14	37.7	56.41	4.03		
		1800	15.18	13.97	2.96	20.01	18.42	3.07	25.09	23.02	3.18	30.54	27.69	3.30	36.97	32.40	3.46	42.85	35.9	49.61	37.4	56.58	3.87		
		1400	14.15	13.01	3.03	18.92	17.41	3.16	23.91	21.85	3.29	29.23	26.51	3.44	35.88	31.44	3.65	41.47	31.47	41.47	37.90	47.90	4.22		
		1600	14.38	13.23	3.06	19.20	17.66	3.17	24.23	22.24	3.30	29.61	26.85	3.43	36.25	31.76	3.62	41.91	31.77	48.47	37.9	55.82	4.12		
		1800	14.58	13.42	3.09	19.44	17.89	3.19	24.51	22.49	3.31	29.91	27.12	3.44	36.54	32.02	3.61	42.30	32.02	48.94	37.9	56.01	4.06		
		1400	13.47	12.39	3.17	18.27	16.81	3.30	23.28	21.37	3.44	28.57	25.91	3.59	34.52	30.25	3.77	40.95	30.98	47.26	41.9	54.69	4.42		
		1600	13.71	12.61	3.20	18.55	17.07	3.31	23.59	21.66	3.44	28.95	26.25	3.58	35.67	31.25	3.78	41.38	31.25	47.82	41.3	55.19	4.32		
		1800	13.93	12.81	3.23	18.80	17.30	3.33	23.86	21.92	3.45	29.27	26.95	3.58	36.05	31.59	3.77	41.73	31.59	48.28	40.9	55.43	4.25		

PERFORMANCE DATA (CONT)
COOLING CAPACITY
50ZHB060

EVAPORATOR AIR		CONDENSER ENTERING AIR TEMPERATURES ° F (° C)																	
		75 (24)			85 (29)			95 (35)			105 (41)			115 (46)			125 (52)		
		Capacity MBTuh		Total Sys kW	Capacity MBTuh		Total Sys kW	Capacity MBTuh		Total Sys kW	Capacity MBTuh		Total Sys kW	Capacity MBTuh		Total Sys kW	Capacity MBTuh		Total Sys kW
CFM / BF	EWB ° F (° C)	Total	Sens	Total	Sens	Total	Sens	Total	Sens	Total	Sens	Total	Sens	Total	Sens	Total	Sens	Total	
1750 / 0.07	57 (14)	54.52	54.52	4.20	52.33	52.33	4.64	49.95	49.95	5.15	47.38	47.38	5.72	44.60	44.60	6.38	41.59	41.59	7.12
	62 (17)	56.27	50.77	4.22	53.60	49.30	4.66	50.80	47.71	5.16	47.84	45.93	5.73	44.67	44.67	6.38	41.64	41.64	7.13
	63* (17)	56.95	41.26	4.23	54.26	39.89	4.67	51.36	38.44	5.17	48.25	36.89	5.74	44.95	44.95	6.38	41.42	33.45	7.12
2000 / 0.08	67 (19)	61.09	42.88	4.29	58.15	41.49	4.74	55.00	40.00	5.24	51.65	38.45	5.80	48.09	36.78	6.45	44.32	35.00	7.18
	72 (22)	66.41	34.97	4.38	63.15	33.61	4.83	59.71	32.21	5.33	56.05	30.72	5.89	52.18	29.13	6.53	48.10	27.45	7.26
	57 (14)	56.68	56.68	4.29	54.29	54.29	4.73	51.73	51.73	5.24	48.97	48.97	5.81	46.00	46.00	6.47	42.79	42.79	7.21
2250 / 0.09	62 (17)	57.54	54.21	4.30	54.80	52.58	4.74	51.96	50.72	5.24	49.03	49.03	5.81	46.05	46.05	6.47	42.84	42.84	7.21
	63 (17)	58.11	43.67	4.31	55.28	42.25	4.75	52.24	40.72	5.24	49.00	39.11	5.81	45.56	37.39	6.45	41.91	35.53	7.19
	67 (19)	62.22	45.44	4.37	59.12	43.99	4.82	55.82	42.46	5.31	52.33	40.83	5.88	48.65	39.10	6.52	44.74	37.24	7.24
2250 / 0.09	72 (22)	67.55	36.49	4.46	64.13	35.07	4.91	60.55	33.62	5.40	56.77	32.08	5.97	52.77	30.45	6.60	48.56	28.71	7.32
	57 (14)	58.41	58.41	4.38	55.86	55.86	4.82	53.14	53.14	5.32	50.22	50.22	5.90	47.08	47.08	6.55	43.72	43.72	7.28
	62 (17)	58.68	57.16	4.38	55.91	55.91	4.82	53.20	53.20	5.33	50.28	50.28	5.90	47.13	47.13	6.55	43.76	43.76	7.28
2250 / 0.09	63 (17)	58.96	45.93	4.38	56.01	44.46	4.82	52.86	42.90	5.32	49.50	41.22	5.88	45.99	39.43	6.52	42.28	37.49	7.25
	67 (19)	63.00	47.85	4.44	59.77	46.34	4.89	56.38	44.78	5.38	52.77	43.10	5.94	49.00	41.30	6.58	45.05	39.36	7.30
	72 (22)	68.37	37.89	4.53	64.84	36.45	4.98	61.16	34.96	5.48	57.25	33.36	6.04	53.15	31.67	6.67	48.87	29.89	7.39

See page 16 for cooling notes.

HEATING CAPACITY
50ZHB060

INDOOR AIR		OUTDOOR COIL ENTERING AIR TEMPERATURES ° F (° C)																							
		-10 (-23)			0 (-18)			10 (-12)			20 (-7)			30 (-1)			40 (4)			50 (10)			60 (16)		
		Capacity MBTuh		Total Sys kW	Capacity MBTuh		Total Sys kW	Capacity MBTuh		Total Sys kW	Capacity MBTuh		Total Sys kW	Capacity MBTuh		Total Sys kW	Capacity MBTuh		Total Sys kW	Capacity MBTuh		Total Sys kW	Capacity MBTuh		Total Sys kW
Return Air db ° F (° C)	CFM	Total	Integ	Total	Sens	Total	Integ	Total	Sens	Total	Integ	Total	Sens	Total	Integ	Total	Sens	Total	Integ	Total	Sens	Total	Integ	Total	
65 (18)	1750	18.85	17.34	3.59	24.42	22.47	3.74	30.31	27.82	3.89	36.67	33.26	4.05	44.81	39.26	4.27	51.11	51.11	4.41	57.40	57.40	4.57	64.43	64.43	4.76
	2000	19.17	17.64	3.63	24.78	22.80	3.77	30.70	28.18	3.90	37.14	33.68	4.05	45.15	39.56	4.24	51.28	51.28	4.36	57.44	57.44	4.50	64.37	64.37	4.67
	2250	19.46	17.90	3.67	25.09	23.09	3.80	31.05	28.49	3.93	37.55	34.05	4.06	45.29	39.68	4.23	51.40	51.40	4.34	57.42	57.42	4.47	64.21	64.21	4.61
70 (21)	1750	17.97	16.54	3.74	23.63	21.75	3.91	29.57	27.14	4.07	35.90	32.56	4.23	44.24	38.77	4.48	50.62	50.62	4.62	56.88	56.88	4.79	63.78	63.78	4.99
	2000	18.29	16.83	3.78	23.99	22.07	3.93	29.96	27.50	4.08	36.36	32.98	4.22	44.70	39.17	4.44	50.85	50.85	4.57	56.96	56.96	4.72	63.74	63.74	4.89
	2250	18.58	17.10	3.82	24.31	22.37	3.96	30.31	27.82	4.10	36.76	33.34	4.23	44.98	39.41	4.42	50.96	50.96	4.55	56.97	56.97	4.68	63.66	63.66	4.83
75 (24)	1750	17.07	15.71	3.90	22.79	20.97	4.08	28.78	26.41	4.25	35.10	31.83	4.42	42.45	37.20	4.63	50.18	50.18	4.84	56.35	56.35	5.02	63.13	63.13	5.22
	2000	17.37	15.98	3.94	23.15	21.30	4.10	29.18	26.78	4.26	35.55	32.24	4.41	43.17	37.83	4.61	50.40	50.40	4.79	56.46	56.46	4.94	63.14	63.14	5.12
	2250	17.65	16.24	3.96	23.47	21.59	4.13	29.53	27.10	4.28	35.95	32.60	4.42	44.25	38.77	4.64	50.52	50.52	4.76	56.49	56.49	4.90	63.12	63.12	5.06

PERFORMANCE DATA (CONT)

LEGEND

BF— Bypass Factor
 db — Dry Bulb
 edb— Entering Dry –Bulb
 Ewb— Entering Wet–Bulb
 kW — Total Unit Power Input
 ldb— Leaving Dry –Bulb
 lwb— Leaving Wet–Bulb
 SHC — Sensible Heat Capacity (1000 Btuh)
 TC — Total Capacity (1000 Btuh) (net)

*At 75° F (23.9° C) entering dry bulb (Tennessee Valley Authority [TVA] rating conditions); all other at 80° F (26.75° C) entering dry bulb.

COOLING NOTES:

1. Ratings are net; they account for the effects of the evaporator—fan motor power and heat.
2. Direct interpolation is permissible. Do not extrapolate.
3. The following formulas may be used:

$$t_{db} = t_{edb} - \frac{\text{Sensible capacity (Btuh)}}{1.10 \times \text{CFM}}$$

$$t_{lwb} = \text{Wet-bulb temperature corresponding to enthalpy air leaving evaporator coil } (h_{lwb})$$

$$h_{lwb} = \frac{\text{total capacity (Btuh)}}{4.5 \times \text{CFM}}$$

Where: h_{lwb} = Enthalpy of air entering evaporator coil

4. The SHC is based on 80° F (26.7° C) edb temperature of air entering evaporator coil. Below 80° F (26.7° C) edb, subtract (corr factor x CFM) from SHC. Above 80° F (26.7° C) edb, add (corr factor x CFM) to SHC.
 Correction Factor = $1.10 \times (1 - \text{BF}) \times (\text{edb} - 80)$.

PERFORMANCE DATA (CONT)

Filter Pressure Drop (IN. W.C.)

FILTER SIZE in. (mm)	CFM																	
	500	600	700	800	900	1000	1100	1200	1300	1400	1500	1600	1700	1800	1900	2000	2100	2200
20X20X1 (508X508X25)	0.05	0.07	0.08	0.10	0.12	0.13	0.14	0.15	—	—	—	—	—	—	—	—	—	—
20X24X1 (508X610x25)	—	—	—	0.08	0.09	0.10	0.11	0.13	0.14	0.15	0.16	—	—	—	—	—	—	—
24X30X1 (610X762x25)	—	—	—	0.04	0.05	0.06	0.07	0.07	0.08	0.09	0.10	—	—	—	—	—	—	—
24X36X1 (610X914X25)	—	—	—	—	—	—	—	0.06	0.07	0.07	0.08	0.09	0.09	0.10	0.11	0.12	0.13	0.14

Accessory Electric Heat Pressure Drop (IN. W.C.)

HEATER kW	CFM							
	800	1000	1200	1400	1600	1800	2000	2200
5-20	0.033	0.037	0.042	0.047	0.052	0.060	0.067	0.075

Wet Coil Air Delivery*

(Deduct 10 percent for 208 Volt Operation)

230 VOLT HORIZONTAL DISCHARGE												
UNIT SIZE	SPEED TAP	AIR DELIVERY ²	EXTERNAL STATIC PRESSURE (IN. W.C.)									
			0.1	0.2	0.3	0.4	0.5	0.6	0.7	0.8	0.9	1.0
024	1	SCFM	933	799	758	707	675	608	549	497	435	394
	2	SCFM	1016	921	882	854	809	761	711	668	599	552
	3	SCFM	1079	1041	1003	970	944	909	866	810	764	724
030	1	SCFM	1052	1018	984	943	914	879	833	795	732	678
	2	SCFM	1141	1107	1069	1036	1006	974	932	899	856	784
	3	SCFM	1246	1213	1181	1144	1108	1078	1043	1015	973	931
036	1	SCFM	1311	1253	1195	1136	1083	1023	958	895	818	729
	2	SCFM	1413	1364	1313	1256	1203	1148	1084	1022	969	882
	3	SCFM	1571	1525	1473	1423	1364	1313	1261	1210	1156	1090
042	1	SCFM	1499	1434	1394	1349	1307	1273	1232	1169	1108	1038
	2	SCFM	1568	1532	1497	1459	1407	1381	1346	1304	1252	1185
	3	SCFM	1635	1593	1560	1523	1484	1439	1406	1369	1335	1264
048	1	SCFM	1657	1625	1590	1554	1517	1486	1448	1417	1381	1340
	2	SCFM	1707	1673	1644	1614	1586	1549	1515	1479	1449	1407
	3	SCFM	1931	1900	1870	1840	1809	1778	1749	1714	1683	1646
060	1	SCFM	1837	1798	1753	1716	1677	1637	1590	1549	1497	1445
	2	SCFM	1910	1872	1835	1795	1748	1711	1673	1623	1568	1525
	3	SCFM	2098	2065	2032	1996	1956	1917	1877	1839	1798	1753

*Air delivery values are based on operating voltage of 230v, wet coil, without filter or electric heater. Deduct filter and electric heater pressure drops to obtain static pressure available for ducting.

NOTES:

1. Do not operate the unit at a cooling airflow that is less than 350 cfm for each 12,000 Btu/h of rated cooling capacity. Evaporator coil frosting may occur at airflows below this point.
2. Standard Cubic Feet per Minute

ELECTRICAL DATA

50ZHB

UNIT	NOMINAL V-PH-HZ	VOLTAGE RANGE		COMPRESSOR		OFM	IFM	ELECTRIC HEAT			POWER SUPPLY		
		MIN	MAX	RLA	LRA	FLA	FLA	NOMINAL	FLA		MCA		MOCP
								kW *	208	240	208	230	**
50ZHB024---30	208/230-1-60	197	253	12.8	58.3	0.9	2.8	-/-	-	-	19.7	19.7	30
								3.8/5	18.0	20.8	42.2	45.7	45/50
								5.6/7.5	27.0	31.3	53.5	58.8	60/60
								7.5/10	36.1	41.7	64.8	71.8	70/80
50ZHB030---30	208/230-1-60	197	253	14.1	73.0	0.9	2.8	-/-	-	-	21.3	21.3	30
								3.8/5	18.0	20.8	43.8	47.3	45/50
								5.6/7.5	27.0	31.3	55.1	60.5	60/70
								7.5/10	36.1	41.7	66.5	73.5	70/80
50ZHB036---30	208/230-1-60	197	253	16.7	79.0	1.5	4.1	-/-	-	-	26.5	26.5	40
								3.8/5	18.0	20.8	49.0	52.5	50/60
								5.6/7.5	27.0	31.3	60.2	65.6	70/70
								7.5/10	36.1	41.7	71.6	78.6	80/80
50ZHB042---30	208/230-1-60	197	253	18.2	112.0	1.5	4.1	-/-	-	-	28.3	28.3	40
								3.8/5	18.0	20.8	50.8	54.3	60/60
								5.6/7.5	27.0	31.3	62.0	67.4	70/70
								7.5/10	36.1	41.7	73.4	80.4	80/90
50ZHB048---30	208/230-1-60	197	253	22.3	117.0	1.5	6.0	-/-	-	-	35.4	35.4	50
								3.8/5	18.0	20.8	57.9	61.4	60/70
								5.6/7.5	27.0	31.3	69.1	74.5	70/80
								7.5/10	36.1	41.7	80.5	87.5	90/90
50ZHB060---30	208/230-1-60	197	253	26.4	134.0	1.9	7.6	-/-	-	-	42.5	42.5	60
								3.8/5	18.0	20.8	65.0	68.5	70/70
								5.6/7.5	27.0	31.3	76.3	81.6	80/90
								7.5/10	36.1	41.7	87.6	94.6	90/100
								11.3/15	54.1	62.5	110.1	120.6	125/125
								15.0/20.0	72.1	83.3	132.6	146.6	150/150

*kW @ 208/240

** HACR Type Circuit Breaker

LEGEND

FLA – Full Load Amps

LRA – Locked Rotor Amps

MCA – Minimum Circuit Amps

MOCP – Maximum Overcurrent Protection

RLA – Rated Load Amps

NOTES:

1. In compliance with NEC (National Electrical Code) requirements for multimotor and combination load equipment (refer to NEC Articles 430 and 440), the overcurrent protective device for the unit shall be Power Supply fuse or circuit breaker.
2. Minimum wire size is based on 60°C copper wire. If other than 60°C wire is used, or if length exceeds wire length in table, determine size from NEC.

*Heater capacity (kW) based on heater voltage of 208v & 240v. If power distribution voltage to unit varies from rated heater voltage, heater kW will vary accordingly.

TYPICAL INSTALLATION

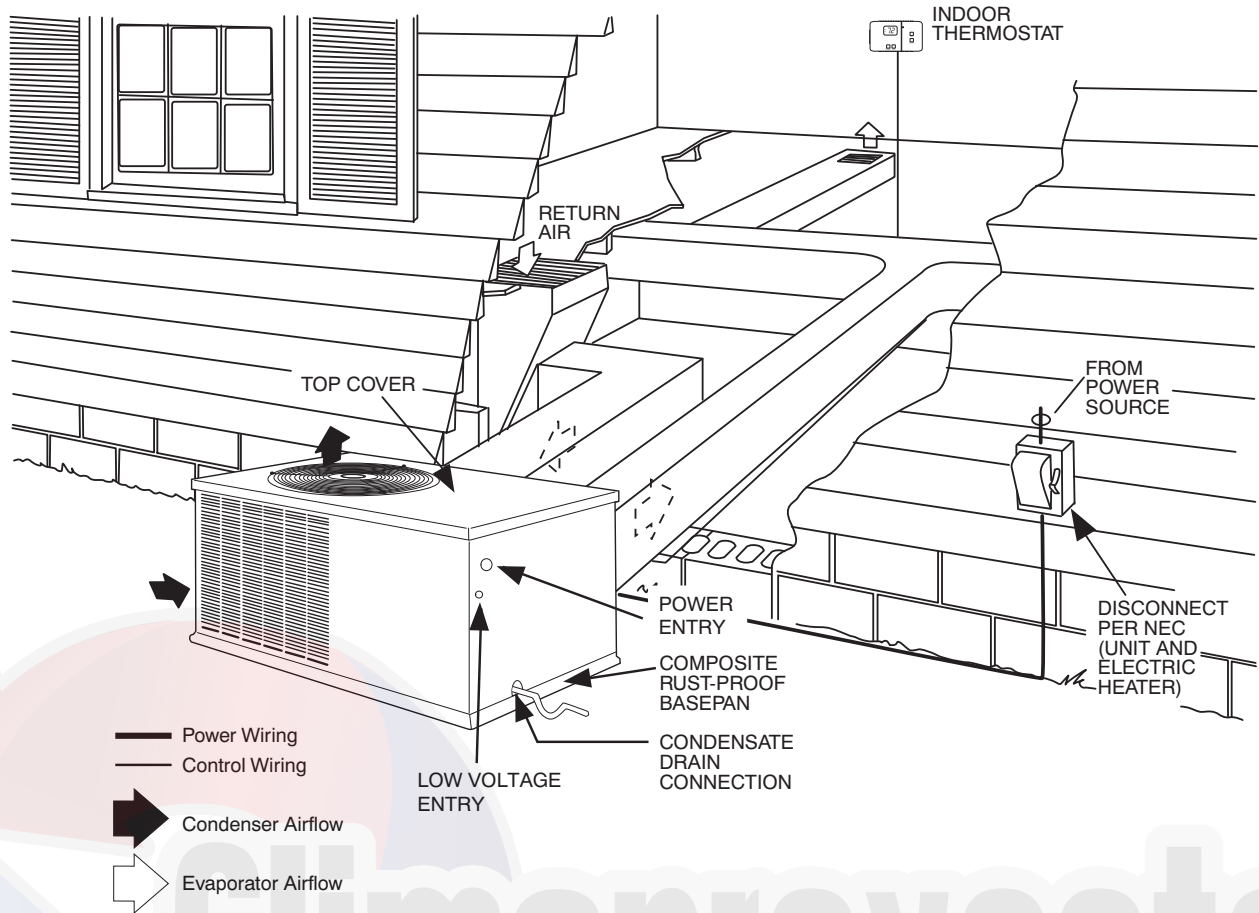

50ZHB

A10135

Climaproyectos.com

50ZHB

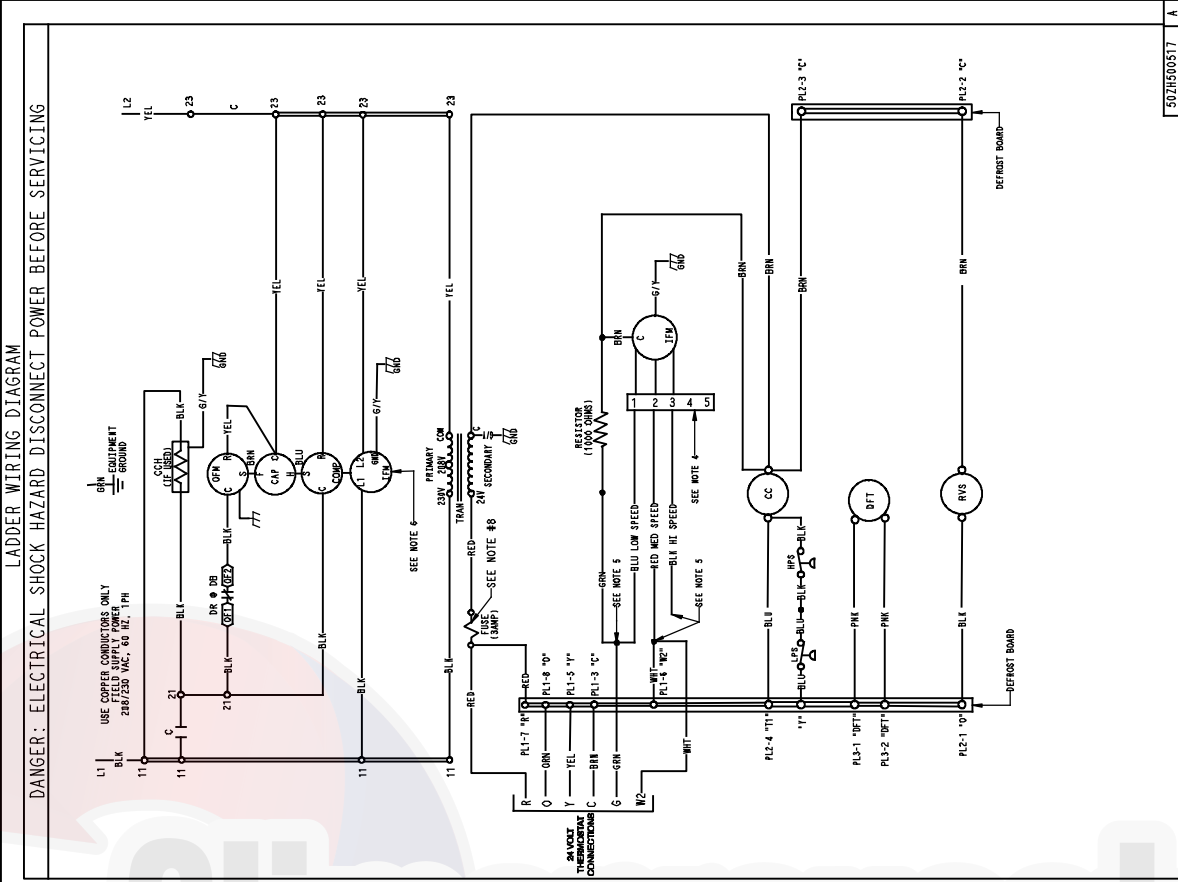
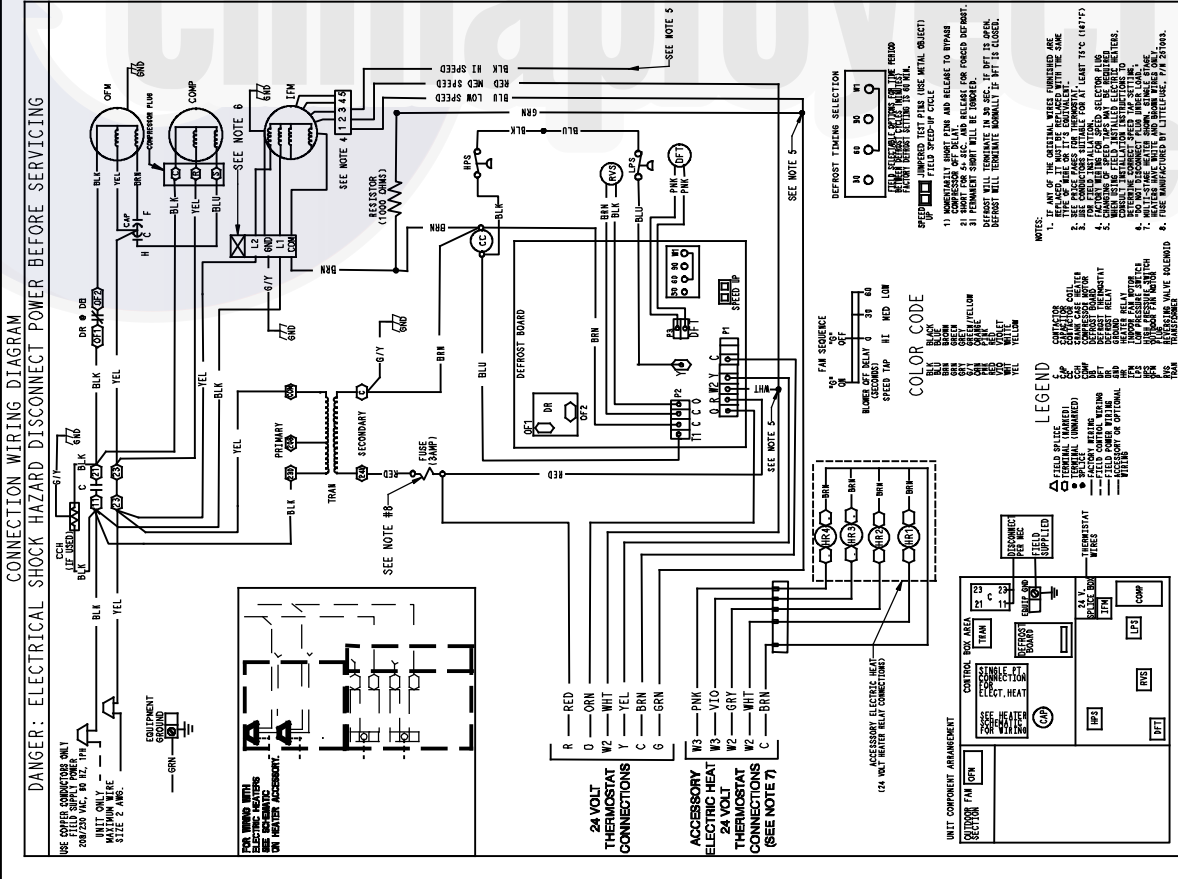

TYPICAL WIRING SCHEMATIC (CONT)

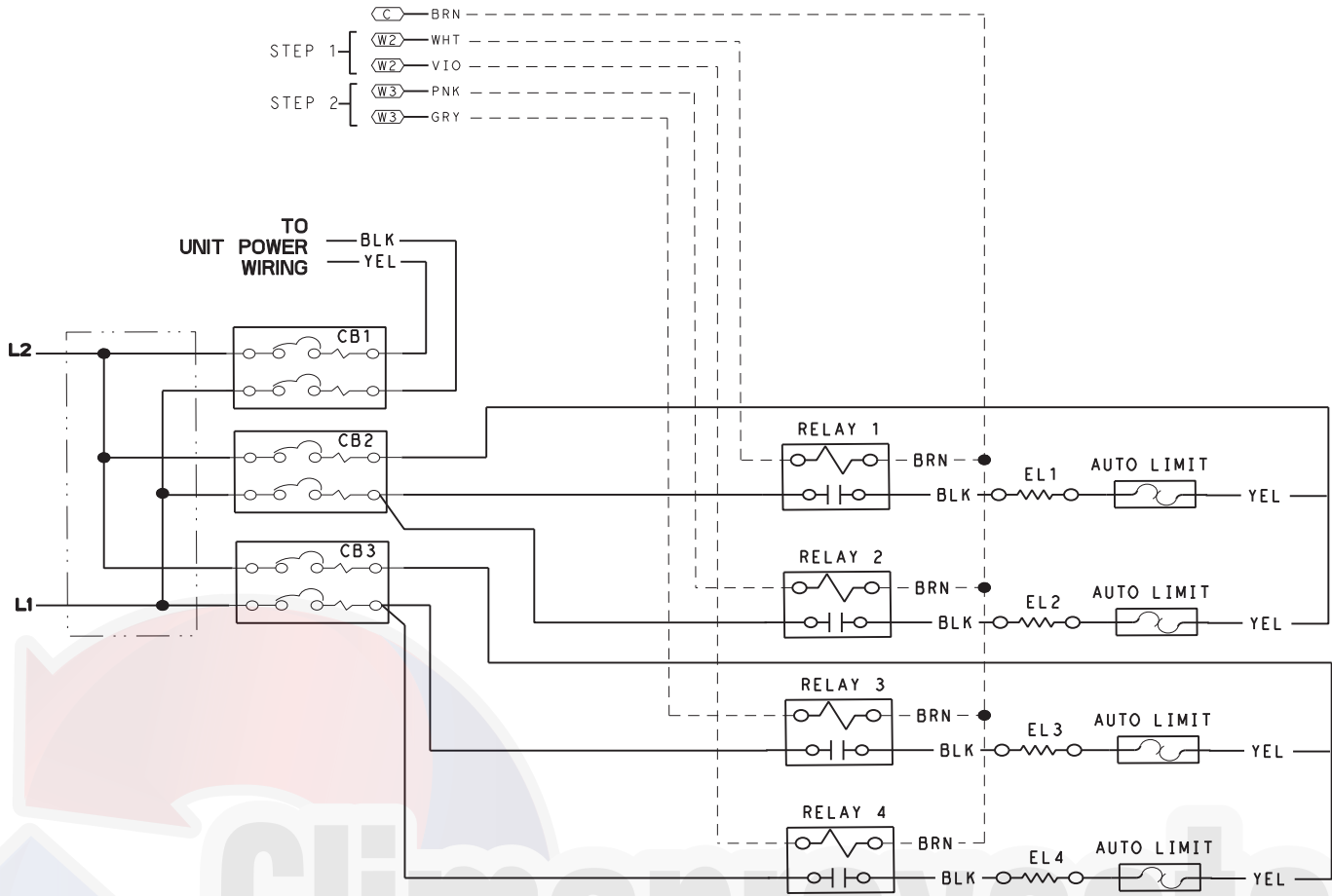

NOTE: 20 kW wiring shown. Smaller heaters have fewer elements and controls.

Single-Phase Accessory Electric Heater Wiring

A10025

CONTROLS

Sequence of operation

When power is supplied to unit, the transformer (TRAN) is energized.

Cooling Operation — With a call for cooling (O,Y,G), the reversing valve, contactor, and indoor fan are energized. When the cooling demand is met, Y and G are de-energized, shutting off the contactor (compressor, outdoor fan). The indoor fan stops after a 60 second delay.

Heating Operation — With a call for heating (Y,G), the contactor and indoor fan are energized. When the heating demand is met, Y and G are de-energized, shutting off the contactor (compressor, outdoor fan). The indoor fan stops after a 60 second delay.

Continuous Fan — With the continuous indoor fan option selected on the thermostat, G is continuously energized keeping the indoor fan running at all times.

Defrost — The defrost control is a time/temperature control which includes a field-selectable time period between defrost cycles of 30, 60, and 90 minutes. Electronic timer and defrost cycle start only when contactor is energized and defrost thermostat (DFT) is closed.

Defrost mode is identical to cooling mode, except outdoor fan motor stops and a bank of optional electric heat turns on to warm air supplying the conditioned space.

APPLICATION DATA

Condensate trap — A 2-in. (51 mm) condensate trap must be field supplied.

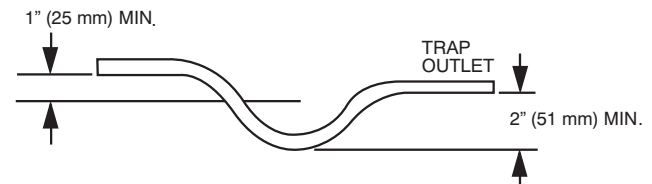

Maximum cooling airflow — To minimize the possibility of condensate blow-off from the evaporator, airflow through the units should not exceed 450 CFM/ton.

Minimum cooling airflow — The minimum cooling airflow is 350 cfm/ton.

Minimum cooling operating outdoor air temperature — All standard units have a minimum ambient operating temperature of 40°F (4.4°C). With accessory low ambient temperature kit, units can operate at temperatures down to 0°F (-17.8°C).

Maximum operating outdoor air temperature — Maximum outdoor operating air temperature for cooling is 125°F (51.7°C).

GUIDE SPECIFICATIONS

SMALL PACKAGED PRODUCT AIR-TO-AIR HEAT PUMP CONSTANT VOLUME APPLICATION

HVAC GUIDE SPECIFICATIONS

SIZE RANGE: 2 TO 5 TONS, NOMINAL (COOLING)

MODEL NUMBER: 50ZHB

PART I - GENERAL

SYSTEM DESCRIPTION

Outdoor packaged, electrically controlled, air-to-air heat pump utilizing a scroll compressor for heating and cooling duty. Unit shall discharge supply air horizontally as shown on contract drawings.

QUALITY ASSURANCE

- A. Unit shall be rated in accordance with AHRI Standards 210/240, and 270. Designed in accordance with UL Standard 1995.**
- B. Unit shall be designed to conform to ASHRAE 15.**
- C. Unit shall be UL listed as a total package for safety requirements.**
- D. Insulation and adhesive shall meet NFPA 90A requirements for flame spread and smoke generation.**

DELIVERY, STORAGE, AND HANDLING

Unit shall be stored and handled per manufacturer's recommendations.

PART 2- PRODUCTS

EQUIPMENT

A. General:

Factory-assembled, single piece, air-to-air heat pump. Contained within the unit enclosure shall be all factory wiring, piping, controls, and refrigerant charge (R-410A).

B. Unit Cabinet:

- 1. Unit cabinet shall be constructed of phosphated, bonderized, zinc-coated, prepainted steel.
- 2. Basepan shall be made of a single-piece non-corrosive, composite material.
- 3. Indoor fan compartment cabinet surfaces shall be insulated with a minimum 1/2 in. (12.7 mm) thick, flexible insulation, coated on the air side, with aluminum foil-faced insulation.
- 4. Cabinet panels shall be easily removable for servicing.
- 5. Unit shall have a factory-installed, sloped, noncorrosive, condensate drain.
- 6. Unit insulation conforms to ASHRAE 62P.

C. Fans:

- 1. Indoor Blower (Indoor Fan):
 - a. Fan shall be multispeed, direct drive as shown on the equipment drawings.
 - b. Fan wheel shall be made from steel, be double-inlet type. It shall have forward-curved blades with a corrosion-resistant finish and shall be dynamically balanced.
- 2. Outdoor fan shall be of the direct-driven propeller type with aluminum blades, riveted to corrosion-resistant steel spiders. It shall be dynamically balanced, and shall discharge air upwards.

D. Compressor:

Fully-hermetic scroll type with external vibration isolation.

E. Coils:

- 1. Indoor and outdoor coils shall have aluminum-plate fins mechanically bonded to seamless copper tubes with all joints brazed.
- 2. Tube sheet openings shall be bellied to prevent tube wear.
- 3. Outdoor coil shall be protected by metal louvered panels.

F. Refrigerant Components:

- 1. TXV and AccuRater feed system.
- 2. Service gauge connections on suction and discharge lines.
- 3. Equipped with liquid line filter drier.
- 4. Equipped with accumulators on all sizes.

G. Controls and Safeties:

- 1. Unit Controls:
 - a. Unit shall be complete with self-contained low voltage control circuit.
 - b. Unit shall incorporate an outdoor coil defrost system to prevent excessive frost accumulation during heating cycle and shall be controlled as follows:
 - (1) Defrost shall be initiated on the basis of time and coil temperature.
 - (2) A 30/60/90-minute timer shall activate defrost cycle only if coil temperature is low enough to indicate a heavy frost condition.
 - (3) Defrost cycle shall terminate when defrost thermostat is satisfied or shall have a positive termination time of 10 minutes.

2. Safeties:

- a. High Pressure Switch
- b. Loss of Charge Switch

H. Operating Characteristics:

- 1. Unit shall be capable of starting and running at 125°F (51.7°C) ambient outdoor temperature.
- 2. Compressor with standard controls shall be capable of operation down to 40°F (4.4°C) ambient outdoor temperature in cooling duty.
- 3. Compressor shall be capable of operation in heating cycle down to -20°F (-28.9°C) ambient outdoor-air temperature.
- 4. Unit shall be capable of simultaneous heating duty and defrost cycle operation when using electric heaters indicated in Section L, Special Features.

I. Electrical Requirements:

All unit power wiring shall enter unit cabinet at a single location.

J. Motors:

- 1. Compressor motors shall be of the refrigerant-cooled type with line break thermal and current overload protection.
- 2. All fan motors shall have permanently lubricated bearings and inherent automatic-reset thermal overload protection.
- 3. Outdoor-fan motor shall be totally enclosed.

GUIDE SPECIFICATIONS (CONT)

K. Grille

1. Louvered Grille:

Louvered grille shall be standard on all units.

L. Special Features Available

1. Coil Options:

Shall include factory-installed optional tin-plated indoor coil.

2. Thermostat:

To provide for two-stage heating and one-stage cooling in addition to manual or automatic changeover and indoor fan control.

3. Low-Ambient Package:

Shall consist of a solid-state control and outdoor coil temperature sensor for controlling outdoor fan motor operation, which shall allow unit to operate down to 0°F (-17.8°C) outdoor ambient temperature in cooling.

4. Crankcase Heater:

Shall provide anti-floodback protection for low-load cooling applications.

5. Electric heaters:

a. Electric heater shall be available as a field-installed option.

b. Heater elements shall be open wire type, adequately supported and insulated with ceramic bushings.

c. Electric heater packages must provide single point power connection capability.

6. Compressor Start Kit:

Shall be available to give a boost to the compressor motor at each start-up.

7. Outdoor Thermostat Kit:

Thermostat allows for staging of electric heaters based on outdoor air temperature.

50ZHB



50ZHB

