

**Hisense**





UEFA  
EURO2020

OFFICIAL PARTNER OF UEFA EURO 2020™

# Light Commercial A/C for Mexico

Hisense International Co., Ltd.  
AC Product Planning Department

# Product line

Type	Capacity	24K	36K	48K	60K
	SEER	17	16	16	15
Duct (AUD)		AUD-24UX5SL	AUD-36UX5SH	AUD-48UX5SH	AUD-60UX5SH
Cassette (AUC)		AUC-24UR5S	AUC-36UR5S	AUC-48UR5S	AUC-60UR5S
Floor ceiling (AUV)		AUV-24UR5S	AUV-36UR5S	AUV-48UR5S	AUV-60UR5S

# Indoor unit

24K/36K



24K/36K



24K



36K



48K/60K



48K/60K



48K/60K



# Outdoor unit

24K



36K



48K/60K





## Universal Features for Duct & Cassette & Floor ceiling

# Universal Main Features

## 1. High efficiency twin rotary DC inverter compressor

Inverter On/off

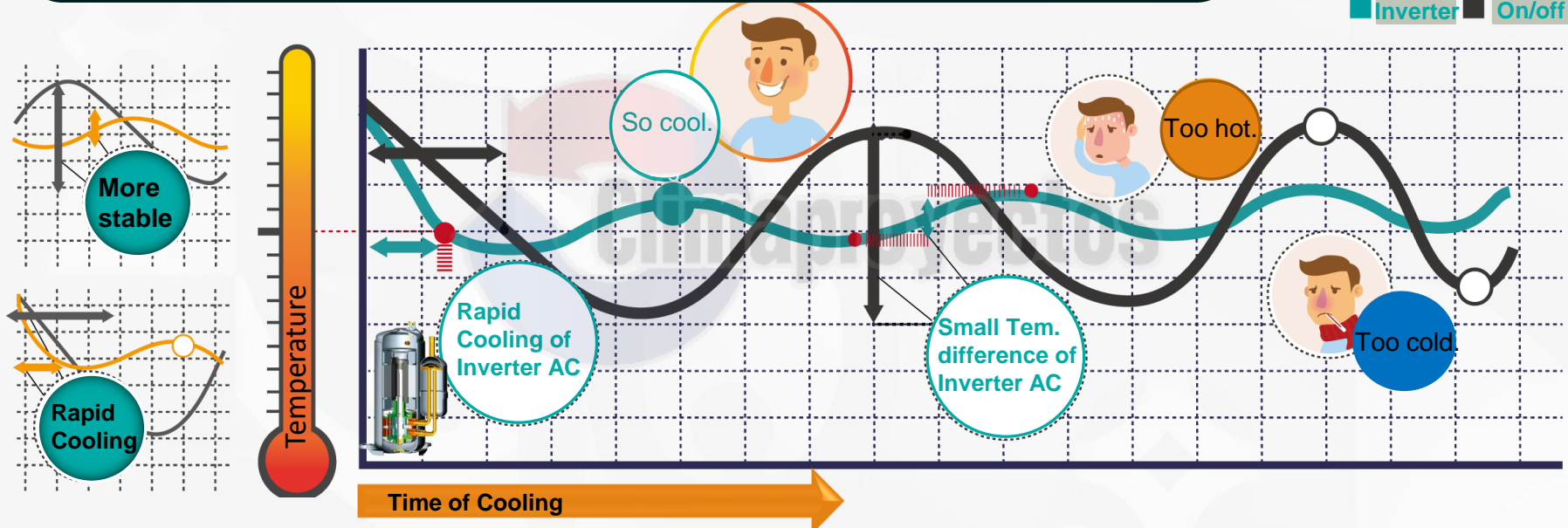

1. Room temperature is much more stable, the indoor temp. is controlled at  $\pm 0.5^{\circ}\text{C}$ ;
2. Reach the setting temperature much more rapidly;
3. Inverter offers the highest part load efficiencies, saving power use by 30%;
4. High system efficiency is obtained by matching capacity with cooling/heating demand;
5. With special design of air tunnel and advanced control technology, the noise of HS new inverter aircon reaches ultra low level under the super quiet mode.

## 2. Both IDU & ODU BLDC motor

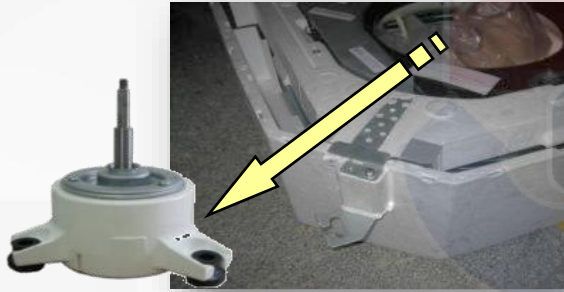

IDU



ODU

- The brushless DC fan motor gives you high efficiency and energy savings.
- Compare to AC motor ,BLDC motor runs more stable and low noise.

## 5. -7°C Heating and 43°C Cooling

Outdoor Unit: Heating:-7-24°C, Cooling:15-43 °C



compressor heat belt



Twin-Rotary compressor



Stronger heating and cooling capability at low ambient temperature. The special compressor crankcase heating belt keeps the reasonable temperature at the bottom of the compressor, which can effectively improve the service life of the compressor and ensure the start of the press at low temperature.



# Universal Main Features

## 6. Refrigerant Leakage Detect

### LEAKAGE ALARM

How?

- 1、 Indoor unit will show error code and stop automatically when the refrigerant charging amount is lower than 30%.
- 2、 When the refrigerant charging amount is between 30% and 50%, the unit will automatically judge if error code is necessary.

### Advantages

- 1、 This function can better ensure the heat transfer efficiency and improve comfort.
- 2、 This function can better protect compressor being damaged by high temperature due to refrigerant leakage.



## 8. Other Protection System

### 1. Fan motor overheating protection:

Built-in thermal protector disconnects when the fan overheats.

### 2. Compressor overheating protection:

Double protection with exhaust temperature sensor and compressor overheat protection switch keeps the compressor working within the allowable range to ensure the reliability of the compressor.

### 3. Indoor unit visual pressure:

The evaporator is visually pressurized to ensure that there are no leaks in the internal machine. If the red needle is visible, it indicates that the pressure is in good condition and the system has no leakage.

### 4. Low/High pressure switch protection:

HP and LP switch keep the system and compressor reliable. 36K with HP switch, 48K/60K with HP and LP switch.

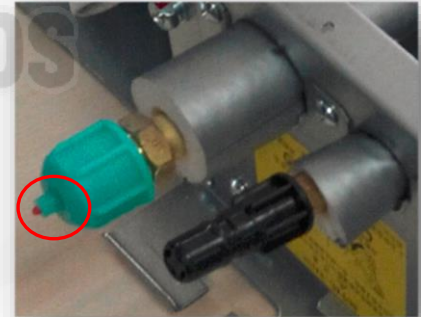

## 9. Universal outdoor unit for F&C , duct , cassette

The outdoor unit can be used to match with same capacity of floor ceiling , duct or cassette , great helpful for the supplier to improving inventory management.

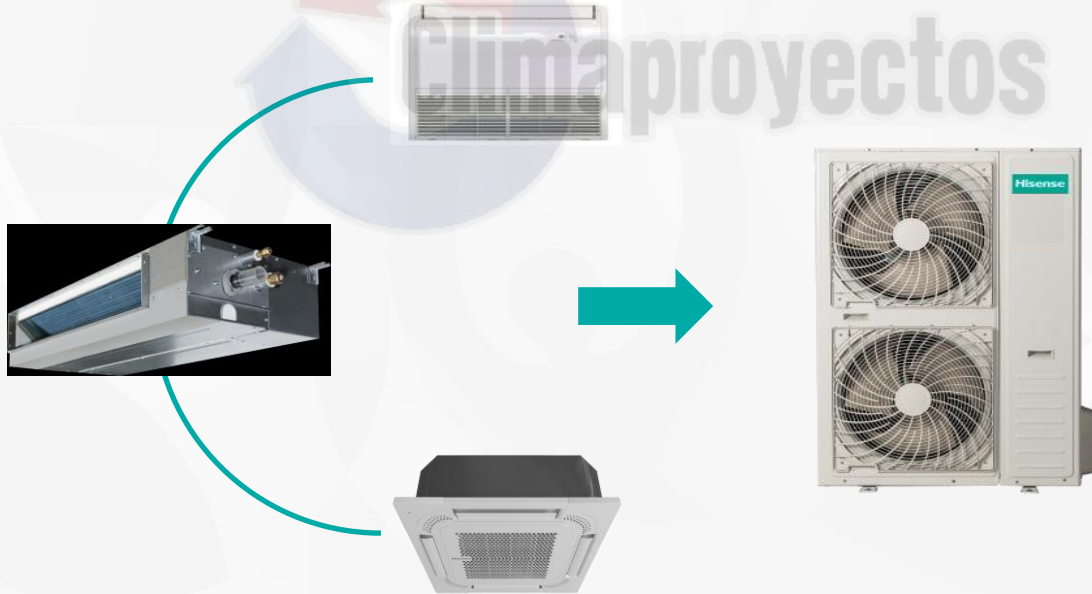

## 10. Fan speed of ODU



By changing the fan speed of ODU, to adjust indoor cooling and heating capacity output.

- There are more choices of fan speed based on actual heating and cooling output, more efficient and energy saving.
- In transition season, air conditioner is easily damaged by high operating pressure or refrigerant return. Hisense adopts multi-speed fan motor which will automatically reduce the fan speed in transition season, more reliable.
- The ODU has mute mode, at this mode, the ODU will reduce the the fan speed and operation frequency to get low noise. Mute mode will give a low noise to the neighborhood environment.

## 11. Height difference & long piping design

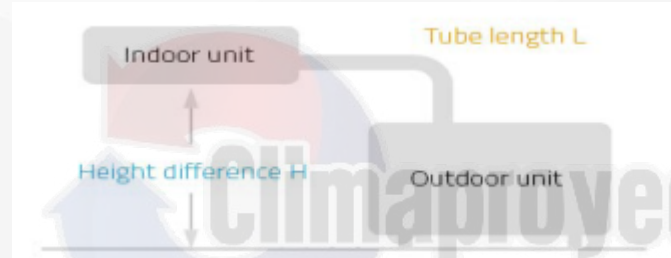

Capacity		24k	36k	48k	60k
Max. pipe length	m	50	50	50	50
Max. difference in height	m	30	30	30	30
additional refrigerant gas volume	g	35	35	35	35

It is easier to install according to the customer's house structure

## 12. Double Control Borads



Indoor control board



outdoor control board

Control boards in both indoor and outdoor and added coil sensors in outdoor unit, for accurate control(esp. defrosting and discharge protection). Some other brands only use one control board, which can not control so accurately. e.g. they set up the timing defrost and can not real-time monitor the defrosting effect.



## 13. Remote controller-L1-12

LCD screen display .

Set temperature : 16-30°C.

Super mode: quickly cooling or heating.

I Feel: Closer to the temperature of human body induction.

Smart : automatically run according the room temperature.

This remote controller is standard for the Floor-ceiling and Cassette,  
and optional for duct.



# Universal Main Features

## 14. Wire controller-YXE-C01U1(E)

Dimensions: 120\*120;

The fashion Acrylic panel;

LCD display screen;

Wireless remote receiver;

Weekly timer setting;

The longest 40 meters of communication distance;

Fault code display;

This wire controller is standard for the duct and optional for Floor-ceiling and Cassette.

**Note: Hisense provide the communication cable is 10 meters;**





## 15. Kit for fresh air intake(Optional)

Cassette

The fresh air function can make air outside lead into the room, which keeps the room air fresh and healthy.

Duct

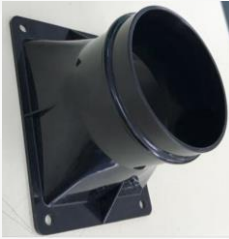

Fresh air intake

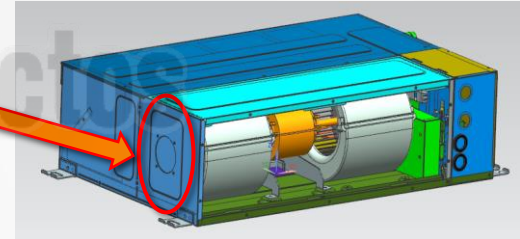

Floor Ceiling

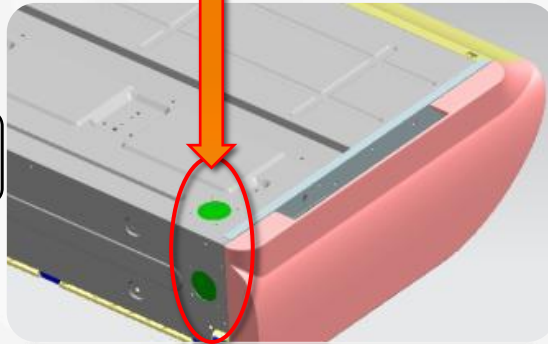



**Features for Floor Ceiling Indoor Unit**

# Floor ceiling Main Features

## 1. Two types installation

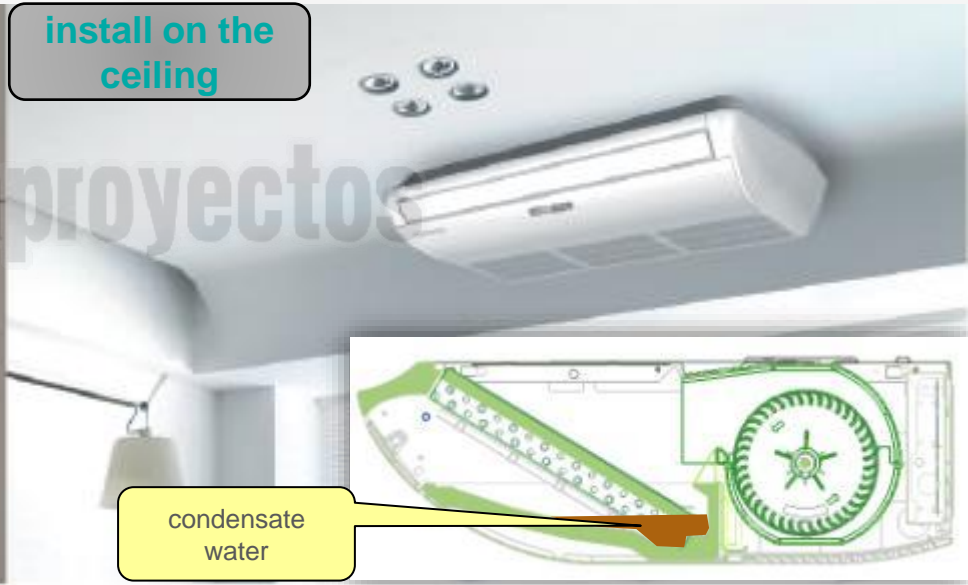

Fashionable design and streamlined appearance. Huge air outlet with an integrative large louver. High air volume and low noise.

## 2. Convenient Pipe Design

3 directions for pipeline , 2 directions for drainage

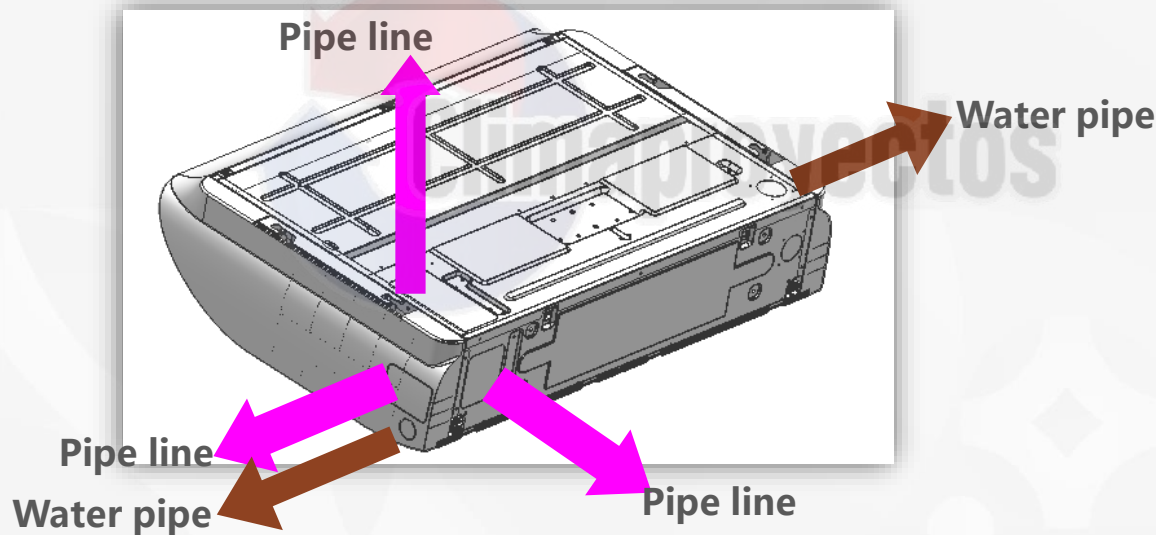

Both right and left sides are possible for drainage hose connection, easy for installation.  
There are 3 choices for refrigerant piping direction, to avoid the inconvenience caused by space limit.

## 3. 3D Air Flow Provides You More Comfort



Horizontal and longitudinal air deflector design let you free to adjust the wind angle, it is easier to blow directly or avoid the wind.

## 4. Anti-condensation



The double layer hollow design of air guide board effectively prevent condensation and reduce the weight.



## Features for Duct Indoor Unit

## 1. Two ways of Air Intake

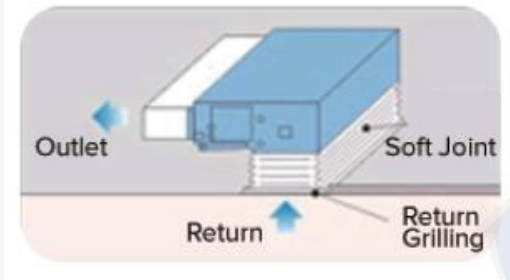

Bottom air intake



Depending on different installation circumstances, the installation will be highly flexible.

**Note:** The noise of bottom air intake is 5dB higher than back air intake, so we recommend that try to do back air intake.

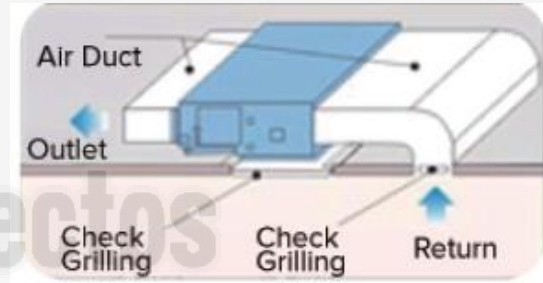

Back air intake





## 2. Built-in Drain Pan & Water Level Switch



Built-in Drain Pan



Outside Drain Pan

Compared with outside drain pan design, the new built-in design can reduce the dust, bacterium adhesion, and avoid water leakage.

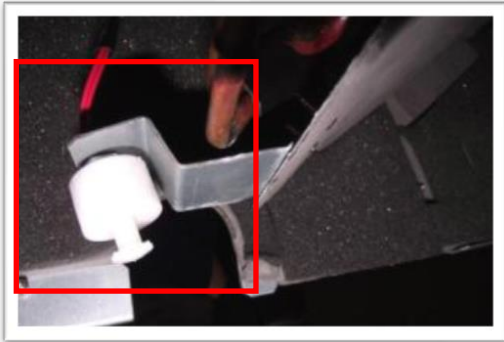

In the case water pump has problem and the water level rises to a certain level, the water level switch will trigger the turn-off of the unit.



## Features for Cassette Indoor Unit

# Cassette Main Features

## 1. Temperature compensation

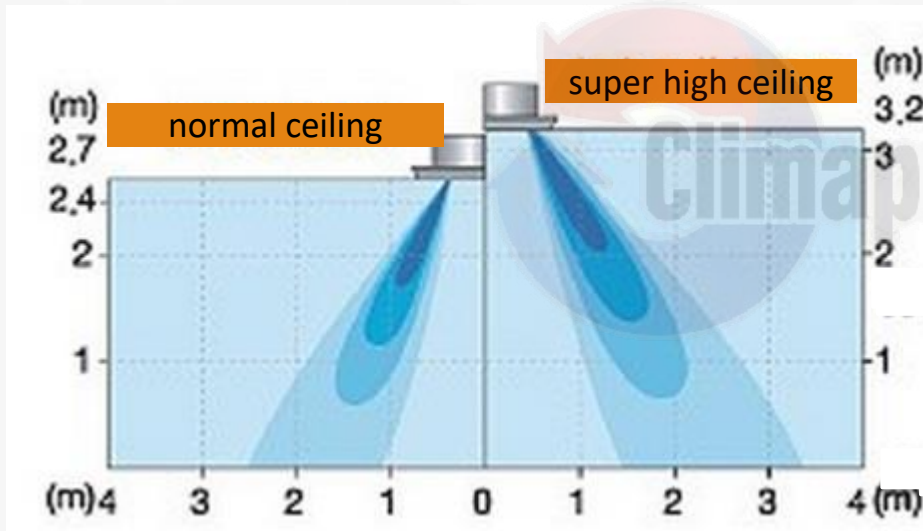

For Cassette type heating mode, people always are not warm enough because the hot air stay at the top level. Hisense Cassette bring temperature compensation setting by wired controller, which will increase the airflow speed and correct the airinlet temperature sensor automatically . This function can revise this temperature difference to make a more accurate temperature control.

Climaproyectos

# THANKS

