



Air Conditioning

Two-pipe S Panel Wall Mounted Fan Coil Unit

Users Manual



Climaproyectos
.com

Two-pipe S Panel Wall Mounted Fan Coil Unit

1.	Introduction.....	2
2.	Nomenclature.....	2
3.	Product Schedule	2
4.	External Appearance	3
5.	Features.....	3
6.	Specifications	4
7.	Dimension	6
8.	Wiring Diagrams	7
9.	Capacity Tables.....	8
10.	Sound Levels	14
11.	Exploded View	15
12.	Installation.....	16
13.	Controller.....	28

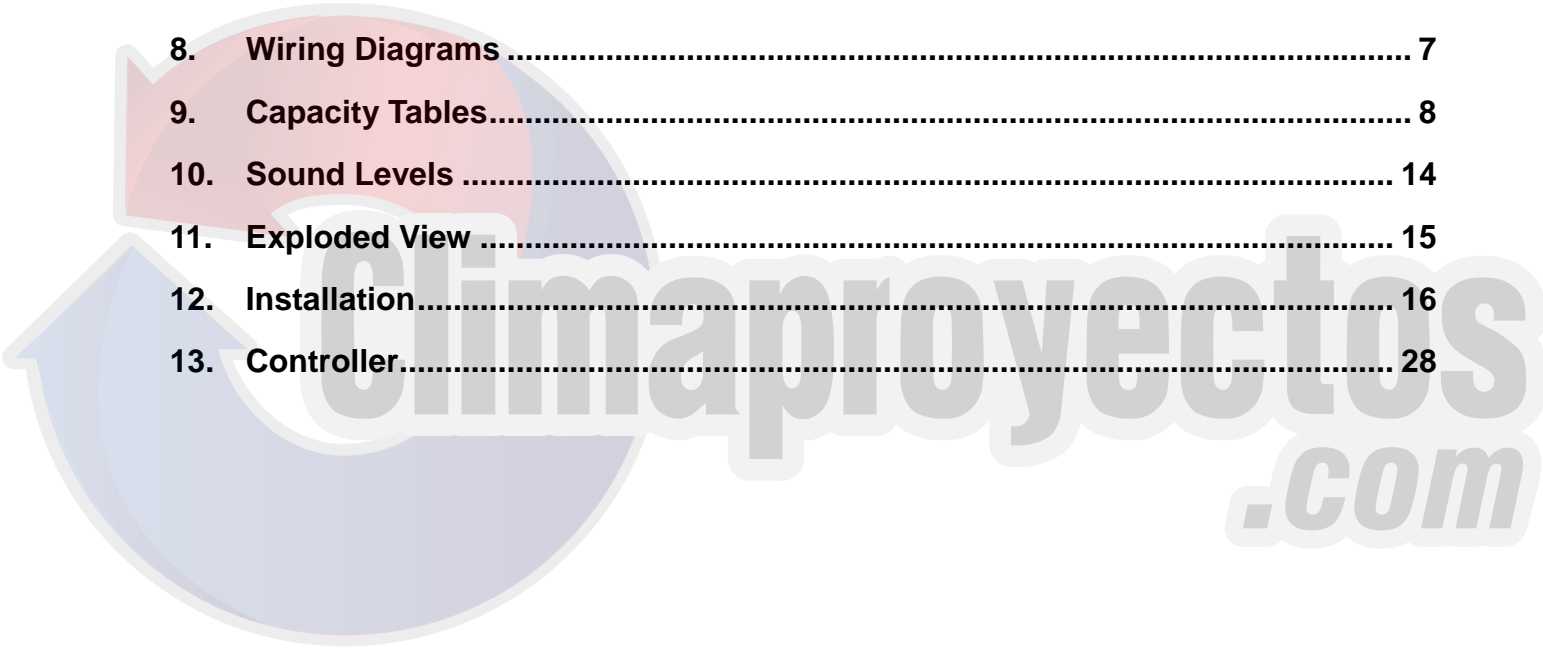

1. Introduction

Fan coil unit is a kind of compound device which assemble fan and heat-exchang coil together. Fan coil with fresh air supply system is a main type of center air-conditioner system, so it is an important component of AC devices. Fan coil unit has concealed type and exposed type. A cooling (heating) supply system usually consists of fan coil terminals and chilled water system (heated water system).

Clima Flex® commercial AC fan coil is designed and manufactured on the base of advanced technology, and utilize qualified galvanized iron as material. Due to its supper-thin design, it has such advantages: beautiful outlook, space saving, easy installation, etc. And the most obvious advantage is that it can decrease the outlet air Temp-difference as low as possible to make room more comfortable, as well as don't decrease cooling capacity output. For the large air flow volume design, it can increase room ventilation frequency, supply more flesh air, and balance room temperature distribution. Benefiting from adoption of advanced material and technology, it can effectively decrease the running noise and keep running smoothly. With the advantages above, it can be widely applied in market, hospital, office building, hotel, airport, etc.

2. Nomenclature

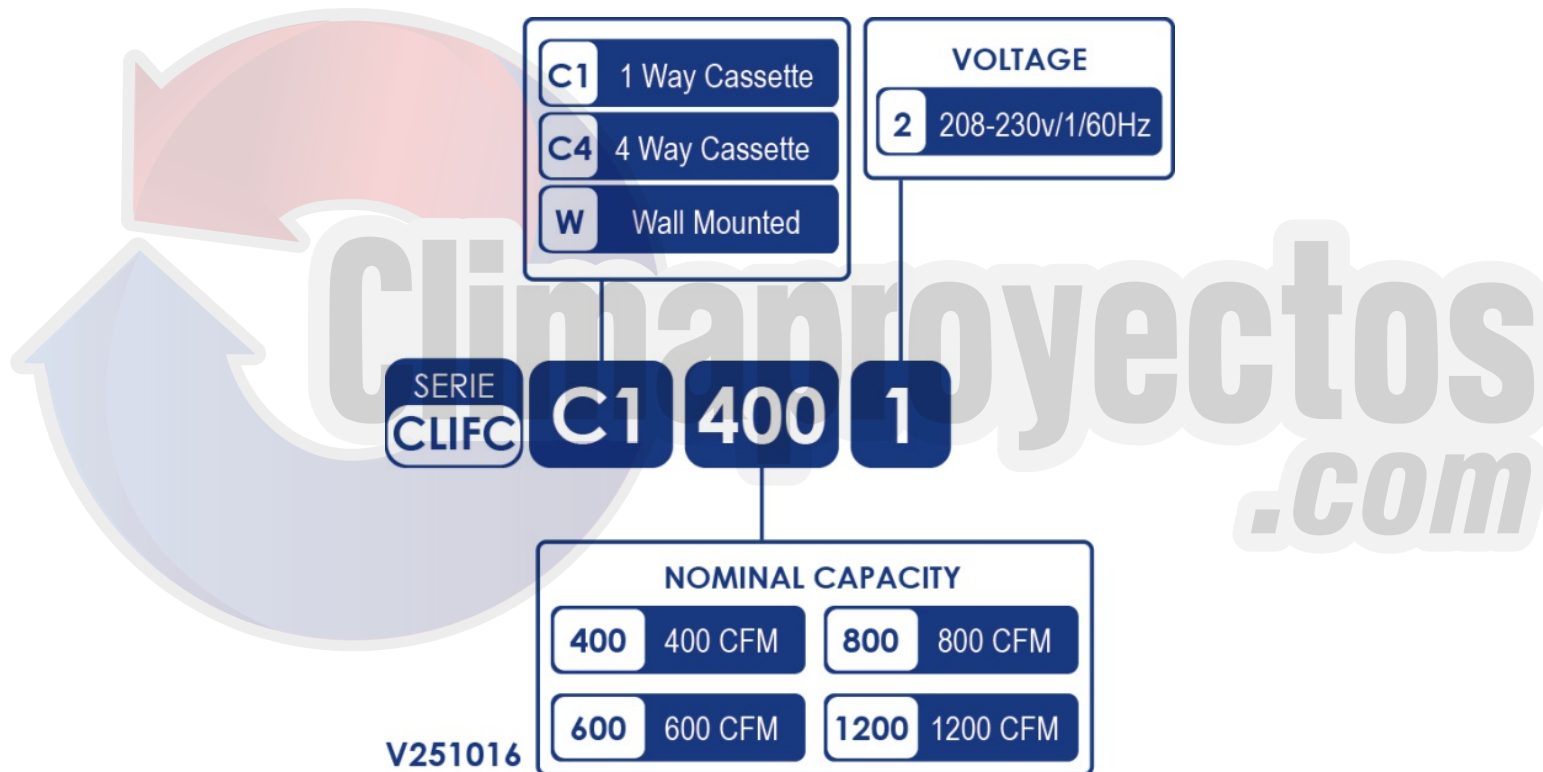

3. Product Schedule

Model	Type	Air volume (CFM)	Power supply
CLIFC-W-250	Wall mounted	250	208~230V-1Ph-60Hz
CLIFC-W-300		300	
CLIFC-W-400		400	
CLIFC-W-500		500	
CLIFC-W-600		600	

4. External Appearance



5. Features

- New panel supplies more choice for customs.
- Multi-connection outlet pipe method: left/right/rear, more flexible for installation.

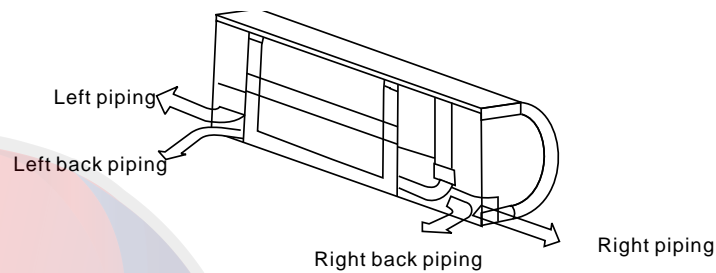

- Wind direction adjustment can be in horizontal and vertical way for auto swing louver

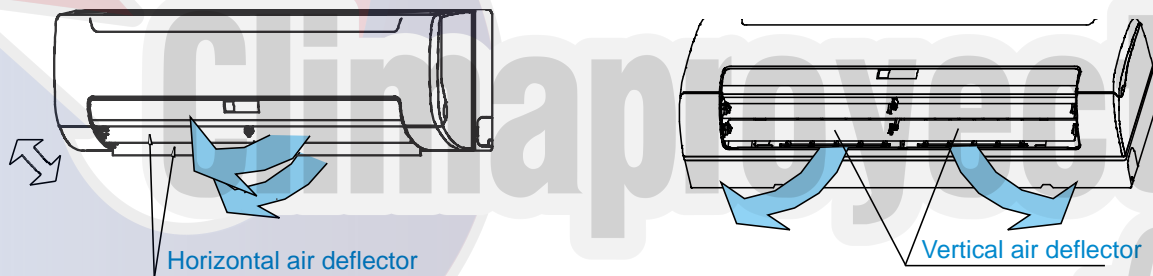

- Built-in 3-way electromagnetic valve.
- Easy maintenance has been realized as the front panel can be removed for easy access.

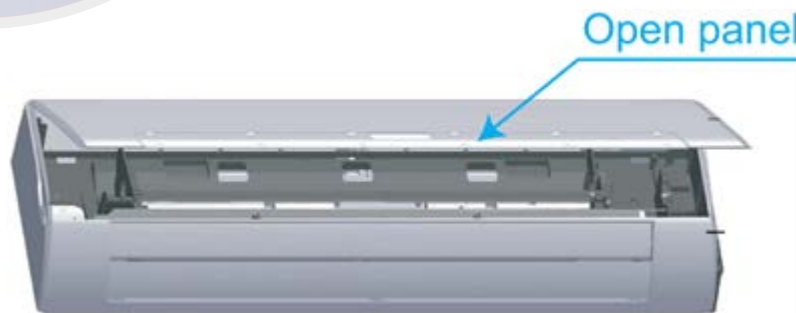

- Remote controller with LCD display is standard, wired controller and central controller is optional.
- Four-speed motor with super high speed reserved for more choice.
- Eurovent certified performance.

6. Specifications

Model			CLIFC-W-250	CLIFC-W-300	CLIFC-W-400
Power supply		V/Ph/Hz	208-230/1/60		
Air flow (H/M/L)		m ³ /h	425/390/350	510/470/390	680/550/460
		CFM	250/230/205	300/275/230	400/325/270
Cooling	Capacity (H/M/L)	kW	2.63/2.41/2.16	2.97/2.47/2.12	3.28/2.83/2.41
	Water flow rate	L/h	452	511	564
	Water pressure drop	kPa	29.4	35.6	43.5
Heating	Capacity (H/M/L)	kW	3.36/3.1/2.79	3.91/3.26/2.77	4.37/3.73/3.17
	Water pressure drop	kPa	27.3	32.9	40.8
Power input		W	24	37	40
Sound pressure level		dB(A)	30/24/20	35/29/24	37/31/26
Fan motor	Type	Low noise 4-speed fan motor			
	Quantity	1			
Fan	Type	Tangential fan			
	Quantity	1			
Coil	Row	2			
	Diameter	mm	Φ7		
	Tube pitch(a)xrow pitch(b)	mm	21×13.37		
	Dimension (W×H×D)	mm	635×315×26.74		
	Fin spacing	mm	1.5		
	Fin type	Hydrophilic aluminium			
	Circuit	5			
	Max. working pressure	MPa	1.6		
Body	Net dimensions (W×H×D)	mm	915×290×230		
	Packing size (W×H×D)	mm	1020×390×315		
	Net weight	kg	13	13	13.3
	Gross weight	kg	16.3	16.3	16.7
Pipe connections	Water inlet/outlet pipe	inch	G3/4		
	Drain pipe	mm	ODΦ20		

Note:

- H: high speed; M: medium speed; L: low speed
- Cooling Conditions: entering water 7°C, temperature rise 5°C, entering air temperature 27°C DB, 19°C WB.
Heating Conditions: entering water 50°C, Entering air temperature 20°C, the same water flow as the cooling conditions.
- Noise is tested in semi-anechoic test room.

Model			CLIFC-W-500	CLIFC-W-600
Power supply		V/Ph/Hz	220-240/1/60	
Air flow (H/M/L)		m ³ /h	850/745/620	1020/915/780
		CFM	500/440/365	600/540/460
Cooling	Capacity (H/M/L)	kW	4.25/3.85/3.32	5/4.47/3.97
	Water flow rate	L/h	731	860
	Water pressure drop	kPa	31.8	42.5
Heating	Capacity (H/M/L)	kW	5.81/5.17/4.43	6.7/6/5.28
	Water pressure drop	kPa	30.2	39.7
Power input		W	50	66
Sound pressure level		dB(A)	39/33/28	40/34/29
Fan motor	Type		Low noise 4-speed fan motor	
	Quantity		1	
Fan	Type		Tangential fan	
	Quantity		1	
Coil	Row		2	
	Diameter	mm	Φ7	
	Tube pitch(a) x row pitch(b)		mm	
	Dimension (W×H×D)		mm	
	Fin spacing	mm	1.5	
	Fin type		Hydrophilic aluminium	
	Circuit		5	
Max. working pressure		MPa	1.6	
Body	Net dimensions (W×H×D)		mm	
	Packing size (W×H×D)		mm	
	Net weight	kg	15.8	15.8
	Gross weight	kg	19.4	19.4
Pipe connections	Water inlet/outlet pipe	inch	G3/4	
	Drain pipe	mm	ODΦ20	

Note:

- H: high speed; M: medium speed; L: low speed
- Cooling Conditions: entering water 7°C, temperature rise 5°C, entering air temperature 27°C DB, 19°C WB.
Heating Conditions: entering water 50°C, Entering air temperature 20°C, the same water flow as the cooling conditions.
- Noise is tested in semi-anechoic test room.

7. Dimension

CLIFC-W-250, CLIFC-W-300, CLIFC-W-400

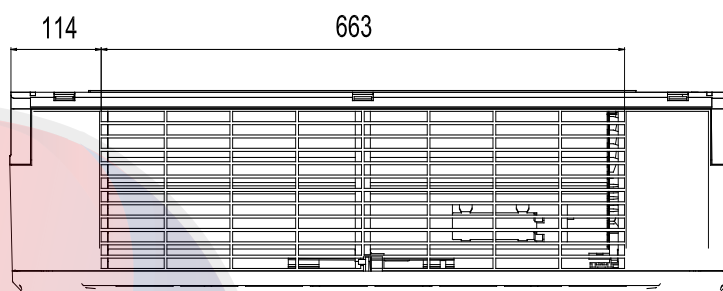
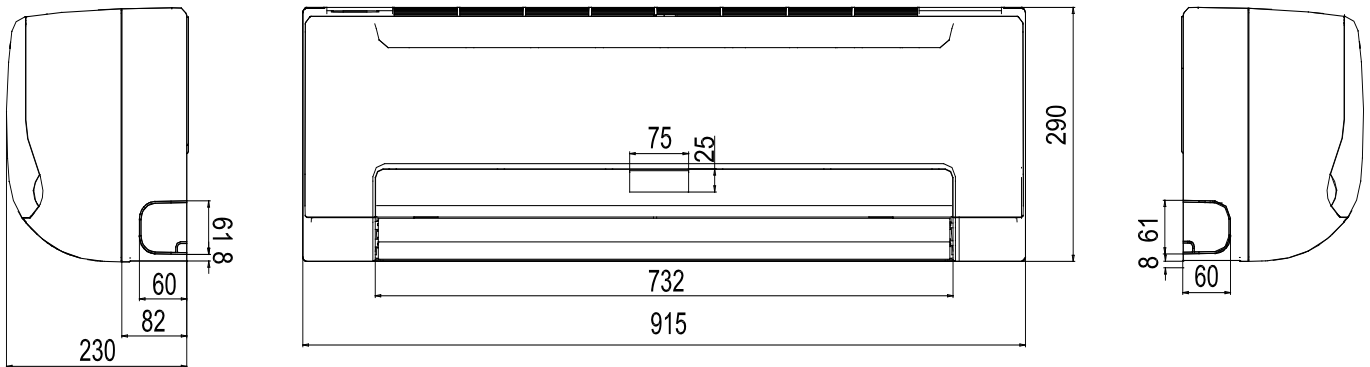

CLIFC-W-500, CLIFC-W-600

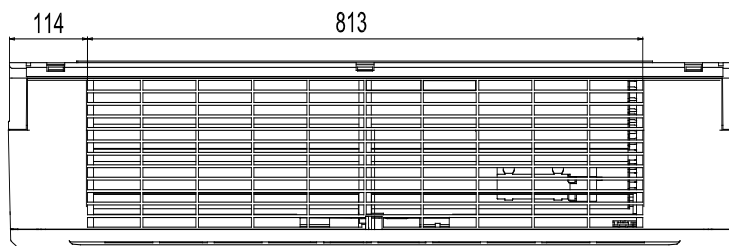
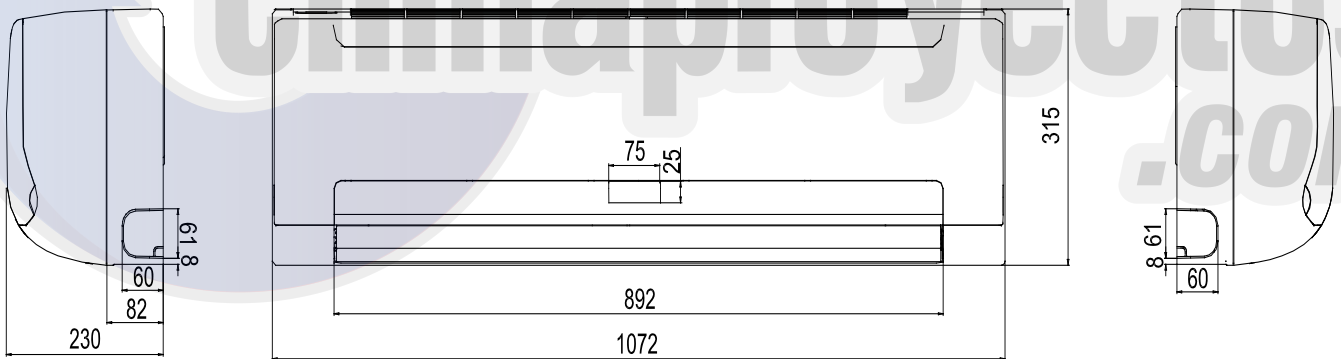

8. Wiring Diagrams

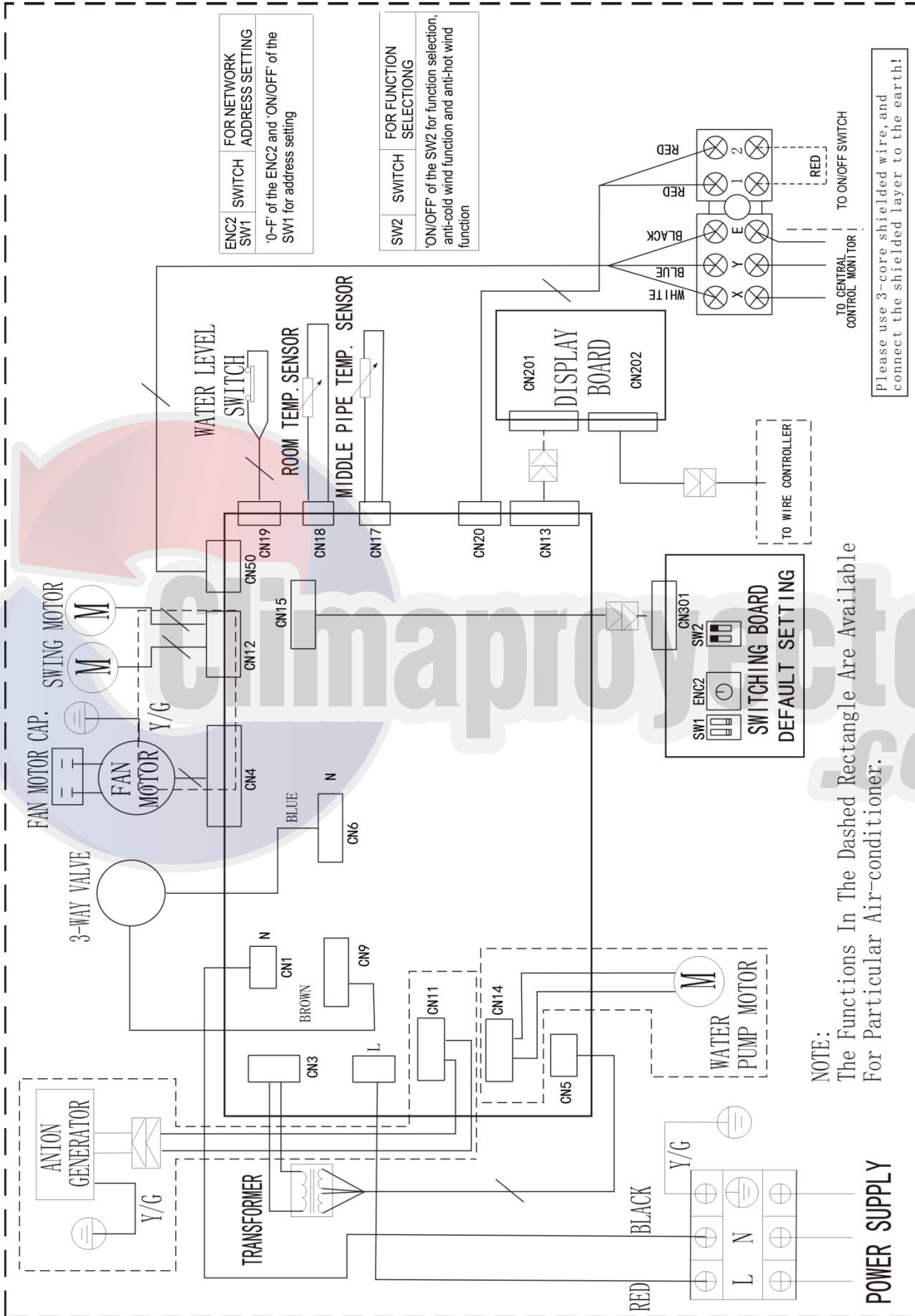

9. Capacity Tables

Cooling Capacity:

Remark: EWT: Enter Water Temp. (°C)

Δt: Temperature Difference (°C)

DB: Dry Bulb Temp. (°C)

WB: Wet Bulb Temp. (°C)

TC: Total Cooling Capacity (kW)

SC: Sensible Cooling Capacity (kW)

WF: Water Flow (m³/h)

WPD: Water Pressure Drop (kPa)

CLIFC-W-250																						
EWT	Δt	Air inlet condition																				
		DB:21 WB:15				DB:26.7 WB:19.4				DB:27 WB:19				DB:29 WB:21				DB:33 WB:25				
		TC	SC	WF	WPD	TC	SC	WF	WPD	TC	SC	WF	WPD	TC	SC	WF	WPD	TC	SC	WF	WPD	
5	3	2.17	1.58	0.62	55.8	3.35	2.02	0.96	132.6	3.28	2.11	0.94	127.2	3.67	1.92	1.05	158.7	4.93	2.39	1.41	287.4	
	4	2.05	1.49	0.44	27.8	3.22	1.96	0.69	68.9	3.17	2.05	0.68	66.7	3.52	1.86	0.76	82.4	4.78	2.32	1.03	151.9	
	5	1.89	1.43	0.33	15.2	3.08	1.89	0.53	40.4	3.02	1.98	0.52	38.8	3.39	2.93	0.58	48.7	4.63	2.28	0.80	91.1	
	6	1.73	1.37	0.25	8.8	2.94	1.84	0.42	25.6	2.89	1.91	0.41	24.6	3.24	1.72	0.46	30.9	4.52	2.20	0.65	60.2	
	7	1.55	1.28	0.19	5.2	2.80	1.75	0.34	17.0	2.74	1.85	0.34	16.2	3.10	1.65	0.38	20.8	4.36	2.13	0.54	41.3	
6	3	1.97	1.49	0.56	45.6	3.16	1.94	0.91	118.0	3.09	2.02	0.89	112.7	3.48	1.84	1.00	143.0	4.74	2.32	1.36	265.7	
	4	1.83	1.42	0.39	22.1	3.04	1.87	0.65	61.2	2.96	1.95	0.64	58.3	3.34	1.78	0.72	74.1	4.59	2.24	0.99	140.0	
	5	1.69	1.35	0.29	12.1	2.89	1.80	0.50	35.5	2.83	1.90	0.49	34.1	3.21	1.71	0.55	43.7	4.44	2.16	0.76	83.8	
	6	1.51	1.29	0.22	6.8	2.75	1.75	0.39	22.3	2.69	1.83	0.39	21.3	3.05	1.63	0.44	27.4	4.33	2.09	0.62	55.2	
	7	1.33	1.20	0.16	3.8	2.61	1.67	0.32	14.7	2.54	1.78	0.31	14.0	2.91	1.56	0.36	18.4	4.17	2.05	0.51	37.8	
7	3	1.76	1.40	0.50	36.5	2.95	1.84	0.85	102.9	2.89	1.94	0.83	98.5	3.28	1.75	0.94	126.6	4.52	2.20	1.29	240.8	
	4	1.61	1.34	0.35	17.3	2.83	1.78	0.61	53.2	2.76	1.87	0.59	50.4	3.15	1.69	0.68	65.7	4.40	2.16	0.95	128.7	
	5	1.46	1.28	0.25	9.0	2.69	1.72	0.46	30.7	2.63	1.81	0.45	29.4	2.99	1.62	0.52	38.1	4.25	2.09	0.73	76.8	
	6	1.28	1.21	0.18	4.9	2.55	1.67	0.36	19.1	2.50	1.75	0.36	18.5	2.86	1.55	0.41	24.1	4.14	2.01	0.59	50.5	
	7	1.11	1.11	0.14	2.7	2.41	1.59	0.30	12.6	2.33	1.69	0.29	11.8	2.71	1.48	0.33	15.9	3.98	1.94	0.49	34.4	
8	3	1.54	1.32	0.44	28.0	2.75	1.76	0.79	89.4	2.69	1.85	0.77	85.2	3.08	1.65	0.88	111.8	4.33	2.13	1.24	221.0	
	4	1.39	1.28	0.30	12.8	2.63	1.70	0.57	45.9	2.55	1.81	0.55	43.2	2.93	1.60	0.63	57.0	4.17	2.05	0.90	115.7	
	5	1.23	1.20	0.21	6.4	2.50	1.63	0.43	26.5	2.42	1.73	0.42	24.9	2.80	1.54	0.48	33.4	4.06	1.97	0.70	70.1	
	6	1.10	1.10	0.16	3.6	2.33	1.58	0.33	16.1	2.29	1.67	0.33	15.5	2.66	1.46	0.38	21.0	3.91	1.94	0.56	45.1	
	7	0.96	0.96	0.12	2.0	2.20	1.51	0.27	10.5	2.13	1.61	0.26	9.8	2.49	1.40	0.31	13.5	3.77	1.86	0.46	30.9	
9	3	1.32	1.25	0.38	20.5	2.56	1.69	0.73	77.2	2.49	1.77	0.71	73.0	2.87	1.57	0.82	97.4	4.14	2.05	1.19	202.0	
	4	1.20	1.20	0.26	9.5	2.41	1.62	0.52	38.7	2.34	1.72	0.50	36.4	2.72	1.51	0.59	49.3	3.98	1.97	0.86	105.5	
	5	1.10	1.07	0.19	5.2	2.28	1.56	0.39	22.2	2.21	1.66	0.38	20.8	2.59	1.45	0.45	28.6	3.87	1.90	0.67	63.7	
	6	0.97	0.97	0.14	2.8	2.13	1.50	0.31	13.4	2.06	1.61	0.29	12.5	2.46	1.38	0.35	17.8	3.71	1.86	0.53	40.6	
	7	0.79	0.79	0.10	1.4	1.97	1.43	0.24	8.4	1.91	1.53	0.23	7.9	2.28	1.32	0.28	11.3	3.58	1.79	0.44	27.8	
10	3	1.16	1.16	0.33	15.9	2.35	1.60	0.67	64.9	2.25	1.70	0.65	59.8	2.67	1.49	0.77	84.3	3.95	1.94	1.13	183.9	
	4	1.07	1.07	0.23	7.6	2.20	1.54	0.47	32.2	2.13	1.65	0.46	30.0	2.52	1.43	0.54	42.0	3.78	1.90	0.81	95.1	
	5	0.95	0.95	0.16	3.9	2.06	1.49	0.35	18.0	1.97	1.59	0.34	16.5	2.38	1.37	0.41	24.1	3.67	1.83	0.63	57.1	
	6	0.82	0.82	0.12	2.0	1.92	1.42	0.27	10.8	1.83	1.53	0.26	9.9	2.23	1.30	0.32	14.6	3.51	1.78	0.50	36.3	
	7	0.52	0.52	0.06	0.6	1.75	1.36	0.21	6.6	1.67	1.48	0.20	6.0	2.08	1.23	0.26	9.4	3.35	1.71	0.41	24.4	
11	3	1.02	1.02	0.29	12.4	2.12	1.53	0.61	52.9	2.04	1.62	0.59	49.2	2.46	1.41	0.70	71.2	3.72	1.86	1.07	163.7	
	4	0.94	0.94	0.20	5.8	1.98	1.47	0.43	26.2	1.91	1.56	0.41	24.1	2.32	1.35	0.50	35.7	3.57	1.81	0.77	84.7	
	5	0.81	0.81	0.14	2.8	1.83	1.42	0.32	14.3	1.75	1.53	0.30	13.0	2.17	1.29	0.37	20.0	3.46	1.75	0.59	50.8	
	6	0.65	0.65	0.09	1.2	1.67	1.36	0.24	8.2	1.61	1.46	0.23	7.6	2.01	1.22	0.29	11.9	3.30	1.70	0.47	32.1	
	7	0.44	0.44	0.05	0.4	1.49	1.31	0.18	4.8	1.43	1.43	0.18	4.5	1.85	1.15	0.23	7.4	3.15	1.63	0.39	21.5	
12	3	0.90	0.90	0.26	9.6	1.89	1.45	0.54	42.3	1.80	1.57	0.52	38.4	2.23	1.33	0.64	58.8	3.51	1.79	1.01	145.8	
	4	0.80	0.80	0.17	4.2	1.75	1.40	0.38	20.4	1.67	1.51	0.36	18.4	2.10	1.27	0.45	29.3	3.37	1.73	0.72	75.3	
	5	0.69	0.69	0.12	2.0	1.60	1.35	0.28	10.9	1.52	1.46	0.26	9.8	1.95	1.21	0.33	16.1	3.24	1.67	0.56	44.5	
	6	0.41	0.41	0.06	0.5	1.42	1.31	0.20	6.0	1.41	1.38	0.20	5.9	1.78	1.15	0.26	9.4	3.08	1.62	0.44	28.0	
	7	0.34	0.34	0.04	0.3	1.26	1.26	0.15	3.4	1.30	1.30	0.16	3.7	1.62	1.08	0.20	5.7	2.93	1.56	0.36	18.6	
13	3	0.78	0.78	0.22	7.1	1.65	1.39	0.47	32.3	1.56	1.51	0.45	28.7	2.01	1.26	0.58	47.8	3.29	1.72	0.94	127.8	
	4	0.66	0.66	0.14	2.9	1.51	1.34	0.33	15.2	1.46	1.43	0.31	14.2	1.87	1.20	0.40	23.2	3.15	1.65	0.68	65.9	
	5	0.48	0.48	0.08	1.0	1.35	1.32	0.23	7.8	1.37	1.37	0.23	7.9	1.72	1.14	0.30	12.6	3.01	1.59	0.52	38.5	
	6	0.32	0.32	0.05	0.3	1.23	1.23	0.18	4.5	1.27	1.27	0.18	4.8	1.55	1.08	0.22	7.1	2.85	1.55	0.41	24.0	
	7	0.24	0.24	0.03	0.1	1.12	1.12	0.14	2.7	1.17	1.17	0.14	3.0	1.36	1.02	0.17	4.0	2.71	1.48	0.33	15.9	

Cooling capacity table

CLIFC-W-300																						
EWT	Δt	Air inlet condition																				
		DB:21 WB:15				DB:26.7 WB:19.4				DB:27 WB:19				DB:29 WB:21				DB:33 WB:25				
		TC	SC	WF	WPD	TC	SC	WF	WPD	TC	SC	WF	WPD	TC	SC	WF	WPD	TC	SC	WF	WPD	
5	3	2.46	1.78	0.70	67.6	3.78	2.28	1.08	160.5	3.71	2.38	1.06	154.1	4.14	2.17	1.19	192.1	5.57	2.70	1.60	348.0	
	4	2.31	1.68	0.50	33.6	3.64	2.21	0.78	83.5	3.58	2.31	0.77	80.8	3.98	2.10	0.86	99.7	5.40	2.61	1.16	183.9	
	5	2.13	1.61	0.37	18.4	3.48	2.13	0.60	48.9	3.41	2.24	0.59	47.0	3.82	3.30	0.66	59.0	5.23	2.57	0.90	110.3	
	6	1.95	1.54	0.28	10.7	3.33	2.07	0.48	31.0	3.26	2.16	0.47	29.8	3.66	1.95	0.52	37.5	5.10	2.49	0.73	72.9	
	7	1.75	1.44	0.21	6.3	3.16	1.98	0.39	20.6	3.09	2.09	0.38	19.7	3.50	1.87	0.43	25.2	4.93	2.40	0.61	50.0	
6	3	2.22	1.68	0.64	55.3	3.57	2.19	1.02	142.9	3.49	2.28	1.00	136.4	3.93	2.07	1.13	173.1	5.36	2.61	1.54	321.7	
	4	2.06	1.60	0.44	26.8	3.43	2.11	0.74	74.1	3.35	2.21	0.72	70.6	3.77	2.01	0.81	89.7	5.19	2.53	1.11	169.6	
	5	1.90	1.53	0.33	14.6	3.26	2.04	0.56	42.9	3.20	2.14	0.55	41.3	3.62	1.93	0.62	52.9	5.01	2.44	0.86	101.5	
	6	1.71	1.46	0.25	8.2	3.11	1.98	0.45	27.1	3.03	2.06	0.43	25.8	3.44	1.84	0.49	33.2	4.89	2.36	0.70	66.9	
	7	1.50	1.35	0.18	4.7	2.94	1.89	0.36	17.9	2.87	2.01	0.35	17.0	3.29	1.77	0.40	22.2	4.71	2.31	0.58	45.8	
7	3	1.98	1.58	0.57	44.1	3.33	2.08	0.96	124.6	3.26	2.19	0.93	119.2	3.70	1.97	1.06	153.4	5.10	2.49	1.46	291.6	
	4	1.82	1.52	0.39	20.9	3.20	2.01	0.69	64.5	3.11	2.12	0.67	61.0	3.55	1.91	0.76	79.6	4.97	2.44	1.07	155.9	
	5	1.65	1.44	0.28	10.9	3.03	1.94	0.52	37.2	2.97	2.04	0.51	35.6	3.38	1.83	0.58	46.1	4.80	2.36	0.83	93.0	
	6	1.45	1.37	0.21	5.9	2.88	1.88	0.41	23.2	2.82	1.97	0.40	22.4	3.23	1.75	0.46	29.2	4.67	2.27	0.67	61.2	
	7	1.26	1.26	0.15	3.2	2.72	1.80	0.33	15.3	2.63	1.91	0.32	14.3	3.06	1.68	0.38	19.2	4.50	2.19	0.55	41.7	
8	3	1.74	1.50	0.50	33.9	3.11	1.99	0.89	108.2	3.03	2.09	0.87	103.2	3.48	1.86	1.00	135.4	4.89	2.40	1.40	267.6	
	4	1.57	1.45	0.34	15.5	2.97	1.92	0.64	55.6	2.88	2.04	0.62	52.3	3.31	1.81	0.71	69.0	4.71	2.31	1.01	140.1	
	5	1.39	1.36	0.24	7.8	2.82	1.84	0.49	32.1	2.73	1.95	0.47	30.2	3.17	1.74	0.54	40.5	4.59	2.23	0.79	84.9	
	6	1.25	1.25	0.18	4.4	2.64	1.79	0.38	19.5	2.58	1.89	0.37	18.7	3.01	1.65	0.43	25.4	4.41	2.19	0.63	54.6	
	7	1.09	1.09	0.13	2.4	2.48	1.71	0.30	12.7	2.40	1.82	0.30	11.9	2.82	1.59	0.35	16.3	4.26	2.10	0.52	37.4	
9	3	1.49	1.41	0.43	24.8	2.89	1.90	0.83	93.5	2.81	2.00	0.80	88.3	3.24	1.77	0.93	118.0	4.67	2.31	1.34	244.6	
	4	1.35	1.35	0.29	11.5	2.73	1.83	0.59	46.9	2.64	1.94	0.57	44.1	3.08	1.71	0.66	59.7	4.50	2.23	0.97	127.7	
	5	1.25	1.21	0.21	6.3	2.58	1.76	0.44	26.9	2.50	1.87	0.43	25.2	2.93	1.63	0.50	34.6	4.37	2.14	0.75	77.1	
	6	1.09	1.09	0.16	3.3	2.41	1.69	0.35	16.3	2.32	1.81	0.33	15.1	2.77	1.56	0.40	21.5	4.19	2.10	0.60	49.1	
	7	0.89	0.89	0.11	1.6	2.23	1.61	0.27	10.2	2.15	1.73	0.26	9.5	2.58	1.49	0.32	13.7	4.05	2.02	0.50	33.7	
10	3	1.31	1.31	0.38	19.3	2.65	1.80	0.76	78.6	2.54	1.92	0.73	72.4	3.02	1.68	0.86	102.1	4.46	2.19	1.28	222.7	
	4	1.20	1.20	0.26	9.1	2.49	1.74	0.53	39.0	2.40	1.86	0.52	36.3	2.84	1.62	0.61	50.9	4.27	2.14	0.92	115.1	
	5	1.08	1.08	0.19	4.7	2.32	1.68	0.40	21.8	2.22	1.80	0.38	20.0	2.69	1.54	0.46	29.2	4.14	2.07	0.71	69.2	
	6	0.92	0.92	0.13	2.4	2.16	1.61	0.31	13.1	2.07	1.73	0.30	12.0	2.52	1.47	0.36	17.7	3.96	2.01	0.57	44.0	
	7	0.59	0.59	0.07	0.7	1.98	1.54	0.24	8.0	1.88	1.67	0.23	7.3	2.35	1.39	0.29	11.4	3.78	1.93	0.46	29.5	
11	3	1.16	1.16	0.33	15.0	2.39	1.72	0.69	64.1	2.31	1.83	0.66	59.6	2.77	1.59	0.79	86.2	4.20	2.10	1.21	198.2	
	4	1.06	1.06	0.23	7.1	2.24	1.66	0.48	31.7	2.15	1.77	0.46	29.2	2.62	1.53	0.56	43.2	4.03	2.05	0.87	102.6	
	5	0.92	0.92	0.16	3.4	2.07	1.60	0.36	17.3	1.98	1.72	0.34	15.8	2.45	1.45	0.42	24.2	3.90	1.98	0.67	61.5	
	6	0.73	0.73	0.10	1.5	1.89	1.53	0.27	10.0	1.81	1.65	0.26	9.2	2.27	1.38	0.33	14.5	3.72	1.92	0.53	38.9	
	7	0.49	0.49	0.06	0.5	1.68	1.48	0.21	5.8	1.62	1.62	0.20	5.4	2.09	1.30	0.26	9.0	3.55	1.84	0.44	26.0	
12	3	1.02	1.02	0.29	11.7	2.14	1.64	0.61	51.3	2.04	1.77	0.58	46.5	2.52	1.50	0.72	71.2	3.97	2.02	1.14	176.6	
	4	0.90	0.90	0.19	5.1	1.98	1.59	0.43	24.7	1.88	1.71	0.40	22.3	2.37	1.44	0.51	35.4	3.80	1.96	0.82	91.1	
	5	0.78	0.78	0.13	2.4	1.81	1.53	0.31	13.2	1.71	1.65	0.29	11.9	2.20	1.37	0.38	19.5	3.66	1.89	0.63	53.9	
	6	0.47	0.47	0.07	0.6	1.61	1.48	0.23	7.2	1.59	1.56	0.23	7.1	2.01	1.29	0.29	11.4	3.48	1.83	0.50	33.9	
	7	0.39	0.39	0.05	0.3	1.42	1.42	0.17	4.2	1.47	1.47	0.18	4.4	1.83	1.22	0.22	6.9	3.31	1.76	0.41	22.5	
13	3	0.88	0.88	0.25	8.7	1.87	1.57	0.54	39.1	1.76	1.70	0.50	34.8	2.27	1.42	0.65	57.8	3.72	1.94	1.07	154.8	
	4	0.75	0.75	0.16	3.5	1.71	1.51	0.37	18.4	1.65	1.62	0.35	17.2	2.11	1.35	0.45	28.0	3.56	1.87	0.76	79.8	
	5	0.54	0.54	0.09	1.2	1.53	1.49	0.26	9.4	1.54	1.54	0.27	9.6	1.94	1.29	0.33	15.2	3.40	1.80	0.58	46.6	
	6	0.36	0.36	0.05	0.4	1.39	1.39	0.20	5.4	1.44	1.44	0.21	5.8	1.75	1.22	0.25	8.6	3.22	1.75	0.46	29.1	
	7	0.27	0.27	0.03	0.1	1.27	1.27	0.16	3.3	1.32	1.32	0.16	3.6	1.53	1.15	0.19	4.8	3.06	1.68	0.38	19.2	

Cooling capacity table

CLIFC-W-400																						
EWT	Δt	Air inlet condition																				
		DB:21		WB:15		DB:26.7		WB:19.4		DB:27		WB:19		DB:29		WB:21		DB:33		WB:25		
		TC	SC	WF	WPD	TC	SC	WF	WPD	TC	SC	WF	WPD	TC	SC	WF	WPD	TC	SC	WF	WPD	
5	3	2.71	1.97	0.78	82.6	4.18	2.52	1.20	196.2	4.09	2.63	1.17	188.3	4.57	2.40	1.31	234.8	6.15	2.98	1.76	425.2	
	4	2.55	1.86	0.55	41.1	4.02	2.44	0.86	102.0	3.95	2.55	0.85	98.7	4.39	2.32	0.94	121.9	5.96	2.89	1.28	224.7	
	5	2.36	1.78	0.41	22.5	3.84	2.36	0.66	59.7	3.77	2.47	0.65	57.4	4.22	3.65	0.73	72.1	5.77	2.84	0.99	134.8	
	6	2.15	1.70	0.31	13.0	3.67	2.29	0.53	37.9	3.60	2.39	0.52	36.4	4.04	2.15	0.58	45.8	5.63	2.75	0.81	89.1	
	7	1.93	1.60	0.24	7.7	3.49	2.18	0.43	25.2	3.41	2.30	0.42	24.0	3.87	2.06	0.48	30.8	5.44	2.65	0.67	61.1	
6	3	2.45	1.86	0.70	67.5	3.94	2.42	1.13	174.6	3.85	2.52	1.10	166.7	4.34	2.29	1.24	211.6	5.92	2.89	1.70	393.1	
	4	2.28	1.77	0.49	32.7	3.79	2.33	0.81	90.6	3.70	2.44	0.79	86.3	4.17	2.22	0.90	109.6	5.73	2.79	1.23	207.2	
	5	2.10	1.68	0.36	17.9	3.60	2.25	0.62	52.5	3.53	2.37	0.61	50.4	4.00	2.13	0.69	64.7	5.54	2.70	0.95	124.0	
	6	1.89	1.61	0.27	10.0	3.43	2.18	0.49	33.1	3.35	2.28	0.48	31.5	3.80	2.04	0.54	40.6	5.40	2.60	0.77	81.7	
	7	1.66	1.50	0.20	5.7	3.25	2.08	0.40	21.8	3.17	2.22	0.39	20.7	3.63	1.95	0.45	27.2	5.21	2.56	0.64	55.9	
7	3	2.19	1.74	0.63	53.9	3.68	2.30	1.06	152.3	3.60	2.42	1.03	145.7	4.08	2.18	1.17	187.4	5.63	2.75	1.61	356.3	
	4	2.01	1.68	0.43	25.6	3.53	2.22	0.76	78.8	3.44	2.34	0.74	74.6	3.92	2.11	0.84	97.3	5.49	2.70	1.18	190.4	
	5	1.82	1.60	0.31	13.4	3.35	2.14	0.58	45.4	3.28	2.26	0.56	43.5	3.73	2.02	0.64	56.4	5.30	2.60	0.91	113.6	
	6	1.60	1.51	0.23	7.2	3.18	2.08	0.46	28.3	3.12	2.18	0.45	27.3	3.56	1.93	0.51	35.7	5.16	2.51	0.74	74.7	
	7	1.39	1.39	0.17	4.0	3.01	1.98	0.37	18.6	2.91	2.11	0.36	17.4	3.37	1.85	0.41	23.5	4.97	2.41	0.61	51.0	
8	3	1.92	1.65	0.55	41.5	3.43	2.20	0.98	132.3	3.35	2.30	0.96	126.1	3.84	2.06	1.10	165.5	5.40	2.65	1.55	327.0	
	4	1.73	1.60	0.37	19.0	3.28	2.13	0.71	68.0	3.18	2.25	0.68	63.9	3.65	2.00	0.79	84.3	5.21	2.56	1.12	171.2	
	5	1.53	1.50	0.26	9.5	3.11	2.04	0.54	39.2	3.02	2.16	0.52	36.9	3.50	1.92	0.60	49.5	5.06	2.46	0.87	103.7	
	6	1.38	1.38	0.20	5.3	2.91	1.97	0.42	23.8	2.85	2.08	0.41	22.9	3.32	1.83	0.48	31.0	4.88	2.41	0.70	66.7	
	7	1.20	1.20	0.15	3.0	2.74	1.88	0.34	15.5	2.66	2.01	0.33	14.5	3.11	1.75	0.38	19.9	4.70	2.32	0.58	45.7	
9	3	1.64	1.56	0.47	30.3	3.19	2.10	0.91	114.3	3.10	2.21	0.89	107.9	3.58	1.96	1.03	144.2	5.16	2.56	1.48	298.9	
	4	1.49	1.49	0.32	14.0	3.01	2.03	0.65	57.2	2.92	2.14	0.63	53.9	3.40	1.89	0.73	73.0	4.97	2.46	1.07	156.0	
	5	1.38	1.33	0.24	7.7	2.85	1.94	0.49	32.8	2.76	2.07	0.47	30.8	3.23	1.80	0.56	42.3	4.83	2.37	0.83	94.2	
	6	1.21	1.21	0.17	4.1	2.66	1.87	0.38	19.9	2.57	2.00	0.37	18.5	3.06	1.72	0.44	26.3	4.62	2.31	0.66	60.0	
	7	0.98	0.98	0.12	2.0	2.46	1.78	0.30	12.5	2.38	1.91	0.29	11.6	2.85	1.64	0.35	16.7	4.47	2.23	0.55	41.2	
10	3	1.45	1.45	0.42	23.6	2.93	1.99	0.84	96.1	2.81	2.13	0.80	88.5	3.33	1.86	0.96	124.7	4.92	2.41	1.41	272.1	
	4	1.33	1.33	0.29	11.2	2.75	1.92	0.59	47.6	2.65	2.05	0.57	44.4	3.14	1.78	0.67	62.2	4.72	2.37	1.01	140.7	
	5	1.19	1.19	0.20	5.7	2.57	1.86	0.44	26.6	2.46	1.99	0.42	24.4	2.97	1.70	0.51	35.7	4.57	2.28	0.79	84.5	
	6	1.02	1.02	0.15	2.9	2.39	1.77	0.34	16.0	2.28	1.91	0.33	14.6	2.78	1.62	0.40	21.7	4.37	2.22	0.63	53.7	
	7	0.65	0.65	0.08	0.9	2.18	1.70	0.27	9.8	2.08	1.84	0.26	8.9	2.60	1.54	0.32	13.9	4.18	2.13	0.51	36.0	
11	3	1.28	1.28	0.37	18.3	2.64	1.90	0.76	78.3	2.55	2.03	0.73	72.8	3.06	1.76	0.88	105.3	4.64	2.32	1.33	242.1	
	4	1.17	1.17	0.25	8.6	2.48	1.84	0.53	38.7	2.38	1.95	0.51	35.7	2.89	1.68	0.62	52.8	4.45	2.26	0.96	125.3	
	5	1.01	1.01	0.17	4.1	2.29	1.77	0.39	21.1	2.18	1.90	0.38	19.2	2.70	1.60	0.46	29.5	4.31	2.18	0.74	75.2	
	6	0.80	0.80	0.12	1.8	2.08	1.69	0.30	12.2	2.00	1.82	0.29	11.3	2.51	1.52	0.36	17.7	4.11	2.13	0.59	47.5	
	7	0.54	0.54	0.07	0.6	1.86	1.63	0.23	7.1	1.79	1.79	0.22	6.6	2.31	1.43	0.28	11.0	3.92	2.04	0.48	31.8	
12	3	1.13	1.13	0.32	14.3	2.36	1.81	0.68	62.7	2.25	1.95	0.64	56.8	2.78	1.66	0.80	87.0	4.38	2.23	1.26	215.7	
	4	0.99	0.99	0.21	6.2	2.19	1.75	0.47	30.2	2.08	1.89	0.45	27.3	2.62	1.59	0.56	43.3	4.20	2.16	0.90	111.3	
	5	0.86	0.86	0.15	3.0	2.00	1.69	0.34	16.1	1.89	1.83	0.33	14.5	2.43	1.51	0.42	23.8	4.04	2.08	0.69	65.9	
	6	0.52	0.52	0.07	0.7	1.77	1.63	0.25	8.8	1.76	1.72	0.25	8.7	2.22	1.43	0.32	13.9	3.84	2.03	0.55	41.5	
	7	0.43	0.43	0.05	0.4	1.57	1.57	0.19	5.1	1.62	1.62	0.20	5.4	2.02	1.34	0.25	8.4	3.65	1.95	0.45	27.5	
13	3	0.97	0.97	0.28	10.6	2.06	1.73	0.59	47.8	1.95	1.88	0.56	42.5	2.51	1.57	0.72	70.7	4.10	2.14	1.18	189.1	
	4	0.83	0.83	0.18	4.3	1.89	1.67	0.41	22.5	1.82	1.79	0.39	21.0	2.33	1.49	0.50	34.3	3.93	2.06	0.84	97.5	
	5	0.60	0.60	0.10	1.4	1.68	1.65	0.29	11.5	1.70	1.70	0.29	11.7	2.14	1.42	0.37	18.6	3.75	1.98	0.65	57.0	
	6	0.40	0.40	0.06	0.4	1.53	1.53	0.22	6.6	1.59	1.59	0.23	7.1	1.94	1.34	0.28	10.5	3.56	1.93	0.51	35.6	
	7	0.29	0.29	0.04	0.2	1.40	1.40	0.17	4.0	1.46	1.46	0.18	4.4	1.69	1.27	0.21	5.9	3.37	1.85	0.41	23.5	

Cooling capacity table

CLIFC-W-500																						
EWT	Δt	Air inlet condition																				
		DB:21 WB:15				DB:26.7 WB:19.4				DB:27 WB:19				DB:29 WB:21				DB:33 WB:25				
		TC	SC	WF	WPD	TC	SC	WF	WPD	TC	SC	WF	WPD	TC	SC	WF	WPD	TC	SC	WF	WPD	
5	3	3.51	2.55	1.01	60.4	5.42	3.26	1.55	143.4	5.30	3.40	1.52	137.6	5.92	3.11	1.70	171.6	7.97	3.86	2.29	310.8	
	4	3.31	2.41	0.71	30.1	5.21	3.16	1.12	74.6	5.12	3.31	1.10	72.1	5.69	3.01	1.22	89.1	7.73	3.74	1.66	164.3	
	5	3.05	2.31	0.53	16.4	4.98	3.05	0.86	43.7	4.88	3.20	0.84	42.0	5.47	4.73	0.94	52.7	7.48	3.68	1.29	98.6	
	6	2.79	2.21	0.40	9.5	4.76	2.97	0.68	27.7	4.67	3.09	0.67	26.6	5.23	2.78	0.75	33.5	7.30	3.56	1.05	65.1	
	7	2.50	2.07	0.31	5.6	4.53	2.83	0.56	18.4	4.42	2.99	0.54	17.6	5.01	2.67	0.62	22.6	7.05	3.43	0.87	44.7	
6	3	3.18	2.40	0.91	49.4	5.11	3.13	1.46	127.6	4.99	3.27	1.43	121.9	5.62	2.97	1.61	154.7	7.67	3.74	2.20	287.4	
	4	2.95	2.29	0.63	23.9	4.91	3.02	1.05	66.2	4.79	3.16	1.03	63.1	5.40	2.87	1.16	80.1	7.42	3.62	1.60	151.5	
	5	2.72	2.18	0.47	13.1	4.67	2.91	0.80	38.3	4.58	3.07	0.79	36.9	5.18	2.76	0.89	47.3	7.18	3.50	1.23	90.6	
	6	2.45	2.09	0.35	7.3	4.45	2.83	0.64	24.2	4.34	2.95	0.62	23.0	4.92	2.64	0.71	29.7	6.99	3.37	1.00	59.8	
	7	2.15	1.94	0.26	4.2	4.21	2.70	0.52	15.9	4.11	2.87	0.50	15.2	4.70	2.53	0.58	19.9	6.75	3.31	0.83	40.9	
7	3	2.84	2.26	0.81	39.4	4.77	2.98	1.37	111.3	4.67	3.13	1.34	106.5	5.29	2.82	1.52	137.0	7.30	3.56	2.09	260.5	
	4	2.61	2.17	0.56	18.7	4.58	2.88	0.98	57.6	4.45	3.03	0.96	54.5	5.08	2.73	1.09	71.1	7.11	3.50	1.53	139.2	
	5	2.35	2.07	0.41	9.8	4.34	2.77	0.75	33.2	4.25	2.93	0.73	31.8	4.84	2.62	0.83	41.2	6.87	3.37	1.18	83.1	
	6	2.07	1.96	0.30	5.3	4.12	2.69	0.59	20.7	4.04	2.82	0.58	20.0	4.62	2.50	0.66	26.1	6.68	3.25	0.96	54.6	
	7	1.80	1.80	0.22	2.9	3.89	2.57	0.48	13.6	3.77	2.74	0.46	12.7	4.37	2.40	0.54	17.2	6.44	3.13	0.79	37.2	
8	3	2.49	2.14	0.71	30.3	4.45	2.85	1.27	96.7	4.34	2.99	1.24	92.2	4.97	2.67	1.43	121.0	6.99	3.43	2.00	239.0	
	4	2.24	2.07	0.48	13.9	4.25	2.75	0.91	49.7	4.12	2.92	0.89	46.7	4.73	2.59	1.02	61.7	6.75	3.31	1.45	125.2	
	5	1.99	1.94	0.34	7.0	4.04	2.64	0.69	28.7	3.91	2.80	0.67	27.0	4.53	2.48	0.78	36.2	6.56	3.19	1.13	75.8	
	6	1.78	1.78	0.26	3.9	3.77	2.56	0.54	17.4	3.70	2.70	0.53	16.7	4.31	2.37	0.62	22.7	6.32	3.13	0.91	48.8	
	7	1.56	1.56	0.19	2.2	3.55	2.44	0.44	11.3	3.44	2.61	0.42	10.6	4.03	2.27	0.50	14.6	6.10	3.01	0.75	33.4	
9	3	2.13	2.02	0.61	22.1	4.13	2.72	1.18	83.6	4.02	2.86	1.15	78.9	4.64	2.54	1.33	105.4	6.68	3.31	1.92	218.5	
	4	1.93	1.93	0.42	10.3	3.90	2.62	0.84	41.8	3.78	2.77	0.81	39.4	4.40	2.45	0.95	53.3	6.44	3.19	1.38	114.1	
	5	1.78	1.73	0.31	5.6	3.69	2.51	0.64	24.0	3.58	2.68	0.61	22.5	4.19	2.34	0.72	30.9	6.26	3.07	1.08	68.9	
	6	1.56	1.56	0.22	3.0	3.45	2.42	0.49	14.5	3.32	2.59	0.48	13.5	3.97	2.23	0.57	19.2	5.99	3.00	0.86	43.9	
	7	1.28	1.28	0.16	1.5	3.19	2.31	0.39	9.1	3.08	2.48	0.38	8.5	3.69	2.13	0.45	12.2	5.79	2.89	0.71	30.1	
10	3	1.88	1.88	0.54	17.2	3.79	2.58	1.09	70.2	3.64	2.75	1.04	64.7	4.32	2.40	1.24	91.2	6.38	3.13	1.83	198.9	
	4	1.72	1.72	0.37	8.2	3.56	2.48	0.76	34.8	3.43	2.66	0.74	32.4	4.07	2.31	0.87	45.5	6.11	3.07	1.31	102.8	
	5	1.54	1.54	0.26	4.2	3.32	2.40	0.57	19.5	3.18	2.58	0.55	17.8	3.85	2.21	0.66	26.1	5.92	2.96	1.02	61.8	
	6	1.32	1.32	0.19	2.1	3.10	2.30	0.44	11.7	2.96	2.48	0.42	10.7	3.60	2.10	0.52	15.8	5.67	2.88	0.81	39.3	
	7	0.84	0.84	0.10	0.6	2.83	2.20	0.35	7.2	2.69	2.39	0.33	6.5	3.37	1.99	0.41	10.2	5.42	2.76	0.67	26.3	
11	3	1.66	1.66	0.47	13.4	3.42	2.47	0.98	57.3	3.30	2.62	0.95	53.2	3.97	2.28	1.14	77.0	6.02	3.01	1.72	177.0	
	4	1.51	1.51	0.33	6.3	3.21	2.38	0.69	28.3	3.08	2.53	0.66	26.1	3.75	2.18	0.81	38.6	5.77	2.93	1.24	91.6	
	5	1.31	1.31	0.23	3.0	2.96	2.29	0.51	15.4	2.83	2.47	0.49	14.1	3.50	2.08	0.60	21.6	5.59	2.83	0.96	55.0	
	6	1.04	1.04	0.15	1.3	2.70	2.20	0.39	8.9	2.59	2.35	0.37	8.2	3.25	1.97	0.47	12.9	5.33	2.75	0.76	34.7	
	7	0.71	0.71	0.09	0.4	2.40	2.12	0.30	5.2	2.32	2.32	0.28	4.8	2.99	1.86	0.37	8.0	5.08	2.64	0.62	23.2	
12	3	1.46	1.46	0.42	10.4	3.06	2.35	0.88	45.8	2.91	2.53	0.84	41.5	3.61	2.15	1.03	63.6	5.68	2.89	1.63	157.7	
	4	1.29	1.29	0.28	4.6	2.83	2.27	0.61	22.1	2.69	2.45	0.58	19.9	3.39	2.05	0.73	31.6	5.44	2.80	1.17	81.4	
	5	1.11	1.11	0.19	2.2	2.59	2.19	0.45	11.8	2.45	2.37	0.42	10.6	3.15	1.96	0.54	17.4	5.23	2.70	0.90	48.2	
	6	0.67	0.67	0.10	0.5	2.30	2.12	0.33	6.5	2.28	2.23	0.33	6.3	2.88	1.85	0.41	10.2	4.98	2.62	0.71	30.3	
	7	0.55	0.55	0.07	0.3	2.04	2.04	0.25	3.7	2.10	2.10	0.26	4.0	2.62	1.74	0.32	6.2	4.73	2.52	0.58	20.1	
13	3	1.26	1.26	0.36	7.7	2.67	2.24	0.77	35.0	2.52	2.43	0.72	31.1	3.25	2.03	0.93	51.7	5.32	2.78	1.52	138.3	
	4	1.07	1.07	0.23	3.2	2.45	2.16	0.53	16.5	2.36	2.32	0.51	15.3	3.02	1.93	0.65	25.0	5.09	2.67	1.09	71.3	
	5	0.77	0.77	0.13	1.1	2.18	2.13	0.38	8.4	2.21	2.21	0.38	8.6	2.78	1.84	0.48	13.6	4.86	2.57	0.84	41.6	
	6	0.52	0.52	0.07	0.3	1.99	1.99	0.28	4.8	2.05	2.05	0.29	5.2	2.51	1.74	0.36	7.7	4.61	2.50	0.66	26.0	
	7	0.38	0.38	0.05	0.1	1.82	1.82	0.22	3.0	1.89	1.89	0.23	3.2	2.20	1.64	0.27	4.3	4.37	2.40	0.54	17.2	

Cooling capacity table

CLIFC-W-600																							
EWT	Δt	Air inlet condition																					
		DB:26.7 WB:19.4				DB:27 WB:18				DB:27 WB:19				DB:27 WB:20				DB:29 WB:21					
		TC	SC	WF	WPD	TC	SC	WF	WPD	TC	SC	WF	WPD	TC	SC	WF	WPD	TC	SC	WF	WPD		
5	3	4.13	3.00	1.19	80.7	6.37	3.84	1.83	191.7	6.24	4.00	1.79	183.9	6.97	3.66	2.00	229.4	9.38	4.55	2.69	415.4		
	4	3.89	2.84	0.84	40.2	6.13	3.72	1.32	99.7	6.02	3.89	1.30	96.4	6.70	3.54	1.44	119.1	9.09	4.40	1.95	219.5		
	5	3.59	2.71	0.62	21.9	5.86	3.59	1.01	58.3	5.74	3.77	0.99	56.1	6.44	3.56	1.11	70.4	8.80	4.33	1.51	131.7		
	6	3.28	2.60	0.47	12.7	5.60	3.49	0.80	37.0	5.49	3.64	0.79	35.6	6.15	3.28	0.88	44.7	8.59	4.18	1.23	87.0		
	7	2.94	2.43	0.36	7.5	5.32	3.33	0.65	24.6	5.20	3.51	0.64	23.5	5.89	3.15	0.72	30.1	8.30	4.04	1.02	59.7		
6	3	3.74	2.83	1.07	66.0	6.01	3.69	1.72	170.6	5.87	3.85	1.68	162.9	6.62	3.49	1.90	206.7	9.02	4.40	2.59	384.1		
	4	3.47	2.69	0.75	32.0	5.77	3.56	1.24	88.5	5.63	3.72	1.21	84.3	6.35	3.38	1.37	107.1	8.73	4.26	1.88	202.4		
	5	3.20	2.57	0.55	17.4	5.49	3.43	0.94	51.2	5.38	3.61	0.93	49.2	6.10	3.25	1.05	63.2	8.44	4.11	1.45	121.1		
	6	2.88	2.45	0.41	9.8	5.23	3.33	0.75	32.3	5.11	3.47	0.73	30.8	5.79	3.10	0.83	39.6	8.23	3.97	1.18	79.9		
	7	2.53	2.28	0.31	5.6	4.96	3.17	0.61	21.3	4.83	3.38	0.59	20.3	5.53	2.97	0.68	26.6	7.94	3.90	0.98	54.6		
7	3	3.34	2.66	0.96	52.7	5.61	3.51	1.61	148.8	5.49	3.69	1.57	142.4	6.23	3.32	1.78	183.1	8.59	4.18	2.46	348.1		
	4	3.07	2.55	0.66	25.0	5.38	3.38	1.16	77.0	5.24	3.56	1.13	72.9	5.98	3.21	1.29	95.0	8.37	4.11	1.80	186.1		
	5	2.77	2.43	0.48	13.0	5.11	3.26	0.88	44.4	5.0	3.44	0.86	42.5	5.69	3.08	0.98	55.1	8.08	3.97	1.39	111.0		
	6	2.44	2.31	0.35	7.0	4.84	3.17	0.69	27.7	4.75	3.32	0.68	26.7	5.43	2.94	0.78	34.8	7.86	3.82	1.13	73.0		
	7	2.11	2.11	0.26	3.9	4.58	3.02	0.56	18.2	4.43	3.22	0.54	17.0	5.14	2.82	0.63	23.0	7.58	3.68	0.93	49.8		
8	3	2.93	2.52	0.84	40.5	5.23	3.35	1.50	129.2	5.11	3.51	1.46	123.2	5.85	3.14	1.68	161.7	8.23	4.04	2.36	319.5		
	4	2.64	2.44	0.57	18.5	5.00	3.24	1.08	66.4	4.85	3.43	1.04	62.4	5.57	3.04	1.20	82.4	7.94	3.90	1.71	167.3		
	5	2.34	2.29	0.40	9.3	4.75	3.10	0.82	38.3	4.60	3.29	0.79	36.0	5.33	2.92	0.92	48.3	7.72	3.75	1.33	101.3		
	6	2.10	2.10	0.30	5.2	4.44	3.01	0.64	23.2	4.35	3.17	0.62	22.3	5.06	2.78	0.73	30.3	7.43	3.68	1.07	65.2		
	7	1.83	1.83	0.23	2.9	4.18	2.87	0.51	15.1	4.05	3.07	0.50	14.2	4.74	2.67	0.58	19.5	7.17	3.54	0.88	44.6		
9	3	2.50	2.37	0.72	29.6	4.86	3.20	1.39	111.7	4.73	3.36	1.35	105.5	5.46	2.99	1.57	140.9	7.86	3.90	2.25	292.1		
	4	2.27	2.27	0.49	13.7	4.59	3.09	0.99	55.9	4.45	3.26	0.96	52.6	5.18	2.88	1.11	71.3	7.58	3.75	1.63	152.4		
	5	2.10	2.03	0.36	7.5	4.34	2.96	0.75	32.1	4.21	3.15	0.72	30.1	4.93	2.75	0.85	41.3	7.36	3.61	1.27	92.1		
	6	1.84	1.84	0.26	4.0	4.05	2.85	0.58	19.4	3.91	3.05	0.56	18.1	4.67	2.62	0.67	25.7	7.05	3.53	1.01	58.7		
	7	1.50	1.50	0.18	2.0	3.75	2.71	0.46	12.2	3.62	2.91	0.44	11.4	4.34	2.50	0.53	16.4	6.81	3.40	0.84	40.2		
10	3	2.21	2.21	0.63	23.0	4.46	3.04	1.28	93.9	4.28	3.24	1.23	86.4	5.08	2.83	1.46	121.8	7.50	3.68	2.15	265.9		
	4	2.03	2.03	0.44	10.9	4.18	2.92	0.90	46.5	4.04	3.13	0.87	43.4	4.78	2.72	1.03	60.8	7.19	3.61	1.55	137.4		
	5	1.81	1.81	0.31	5.6	3.91	2.83	0.67	26.0	3.74	3.03	0.64	23.8	4.53	2.60	0.78	34.9	6.97	3.48	1.20	82.6		
	6	1.55	1.55	0.22	2.8	3.64	2.71	0.52	15.7	3.48	2.91	0.50	14.3	4.24	2.47	0.61	21.2	6.67	3.38	0.96	52.5		
	7	0.99	0.99	0.12	0.8	3.33	2.59	0.41	9.6	3.17	2.81	0.39	8.7	3.96	2.34	0.49	13.6	6.37	3.25	0.78	35.2		
11	3	1.95	1.95	0.56	17.9	4.03	2.90	1.15	76.5	3.88	3.09	1.11	71.2	4.67	2.68	1.34	102.9	7.08	3.54	2.03	236.6		
	4	1.78	1.78	0.38	8.4	3.77	2.80	0.81	37.8	3.62	2.97	0.78	34.8	4.41	2.57	0.95	51.6	6.79	3.45	1.46	122.4		
	5	1.54	1.54	0.27	4.1	3.48	2.69	0.60	20.6	3.33	2.90	0.57	18.8	4.12	2.45	0.71	28.9	6.57	3.33	1.13	73.4		
	6	1.23	1.23	0.18	1.8	3.17	2.58	0.46	11.9	3.05	2.77	0.44	11.0	3.82	2.32	0.55	17.3	6.27	3.24	0.90	46.4		
	7	0.83	0.83	0.10	0.6	2.83	2.49	0.35	6.9	2.73	2.73	0.34	6.5	3.52	2.19	0.43	10.8	5.98	3.10	0.73	31.0		
12	3	1.72	1.72	0.49	13.9	3.60	2.76	1.03	61.2	3.43	2.98	0.98	55.5	4.24	2.53	1.22	85.0	6.68	3.41	1.92	210.8		
	4	1.52	1.52	0.33	6.1	3.33	2.67	0.72	29.5	3.17	2.88	0.68	26.6	3.99	2.42	0.86	42.3	6.40	3.30	1.38	108.8		
	5	1.31	1.31	0.22	2.9	3.04	2.58	0.52	15.8	2.89	2.78	0.50	14.2	3.70	2.31	0.64	23.3	6.15	3.17	1.06	64.4		
	6	0.79	0.79	0.11	0.7	2.71	2.49	0.39	8.6	2.68	2.63	0.38	8.5	3.39	2.18	0.49	13.6	5.86	3.09	0.84	40.5		
	7	0.65	0.65	0.08	0.4	2.40	2.40	0.29	5.0	2.47	2.47	0.30	5.3	3.08	2.05	0.38	8.2	5.57	2.97	0.68	26.9		
13	3	1.48	1.48	0.42	10.3	3.15	2.64	0.90	46.7	2.97	2.86	0.85	41.5	3.82	2.39	1.10	69.1	6.26	3.27	1.79	184.8		
	4	1.26	1.26	0.27	4.2	2.88	2.54	0.62	22.0	2.78	2.73	0.60	20.5	3.55	2.27	0.76	33.5	5.99	3.15	1.29	95.3		
	5	0.91	0.91	0.16	1.4	2.57	2.51	0.44	11.2	2.60	2.60	0.45	11.5	3.27	2.16	0.56	18.2	5.72	3.02	0.98	55.7		
	6	0.61	0.61	0.09	0.4	2.34	2.34	0.34	6.5	2.42	2.42	0.35	6.9	2.95	2.05	0.42	10.3	5.43	2.94	0.78	34.8		
	7	0.45	0.45	0.05	0.2	2.14	2.14	0.26	4.0	2.22	2.22	0.27	4.3	2.58	1.93	0.32	5.8	5.14	2.82	0.63	23.0		

Cooling capacity modification coefficient table:

Speed	250		300		400		500		600	
	TC	SC	TC	SC	TC	SC	TC	SC	TC	SC
High	1	1	1	1	1	1	1	1	1	1
Mid	0.92	0.9	0.83	0.8	0.86	0.83	0.91	0.86	0.89	0.85
Low	0.82	0.8	0.71	0.7	0.73	0.7	0.78	0.75	0.79	0.75

Heating Capacity:

Remark:

Δt: Temperature Difference (°C) **TH:** Total Heating Capacity (kW)

WF: Water Flow (m³/h) **WPD:** Water Pressure Drop (kPa)

CLIFC-W-250																										
Air inlet temp. (20°C DB)																										
Water inlet temp. (°C)																										
Δt	35			40			45			50			55			60			65			70				
	TH	WF	WPD	TH	WF	WPD	TH	WF	WPD	TH	WF	WPD	TH	WF	WPD	TH	WF	WPD	TH	WF	WPD	TH	WF	WPD		
10	1.15	0.10	1.2	1.80	0.15	2.8	2.49	0.21	5.4	3.14	0.27	8.7	3.80	0.33	12.6	4.46	0.38	17.5	5.11	0.44	22.9	5.75	0.49	29.0		
8	1.27	0.14	2.2	1.98	0.21	5.4	2.65	0.28	9.6	3.31	0.36	15.0	3.94	0.42	21.3	4.58	0.49	28.8	5.23	0.56	37.4	5.87	0.63	47.2		
6	1.47	0.21	5.3	2.14	0.31	11.2	2.78	0.40	18.8	3.45	0.49	29.0	4.10	0.59	41.0	4.74	0.68	54.9	5.35	0.77	69.7	6.03	0.86	88.6		
CLIFC-W-300																										
Air inlet temp. (20°C DB)																										
Water inlet temp. (°C)																										
Δt	35			40			45			50			55			60			65			70				
	TH	WF	WPD	TH	WF	WPD	TH	WF	WPD	TH	WF	WPD	TH	WF	WPD	TH	WF	WPD	TH	WF	WPD	TH	WF	WPD	TH	WF
10	1.33	0.11	1.5	2.08	0.18	3.7	2.89	0.25	7.1	3.64	0.31	11.3	4.40	0.38	16.6	5.17	0.45	22.9	5.92	0.51	30.0	6.67	0.57	38.0		
8	1.47	0.16	2.9	2.29	0.25	7.0	3.07	0.33	12.6	3.83	0.41	19.6	4.57	0.49	27.9	5.31	0.57	37.7	6.06	0.65	49.1	6.81	0.73	61.9		
6	1.71	0.24	6.9	2.48	0.36	14.7	3.22	0.46	24.6	4.00	0.57	38.0	4.76	0.68	53.7	5.50	0.79	71.9	6.20	0.89	91.3	6.99	1.00	116.1		
CLIFC-W-400																										
Air inlet temp. (20°C DB)																										
Water inlet temp. (°C)																										
Δt	35			40			45			50			55			60			65			70				
	TH	WF	WPD	TH	WF	WPD	TH	WF	WPD	TH	WF	WPD	TH	WF	WPD	TH	WF	WPD	TH	WF	WPD	TH	WF	WPD	TH	WF
10	1.49	0.13	2.1	2.34	0.20	5.1	3.25	0.28	9.7	4.10	0.35	15.5	4.95	0.43	22.7	5.82	0.50	31.3	6.66	0.57	41.0	7.50	0.65	52.0		
8	1.66	0.18	4.0	2.58	0.28	9.6	3.46	0.37	17.3	4.31	0.46	26.8	5.14	0.55	38.2	5.98	0.64	51.6	6.82	0.73	67.1	7.66	0.82	84.7		
6	1.92	0.28	9.5	2.80	0.40	20.1	3.62	0.52	33.7	4.50	0.65	52.0	5.35	0.77	73.5	6.19	0.89	98.4	6.98	1.00	124.9	7.87	1.13	158.9		
CLIFC-W-500																										
Air inlet temp. (20°C DB)																										
Water inlet temp. (°C)																										
Δt	35			40			45			50			55			60			65			70				
	TH	WF	WPD	TH	WF	WPD	TH	WF	WPD	TH	WF	WPD	TH	WF	WPD	TH	WF	WPD	TH	WF	WPD	TH	WF	WPD	TH	WF
10	1.99	0.17	1.6	3.13	0.27	3.9	4.33	0.37	7.5	5.46	0.47	11.9	6.60	0.57	17.4	7.76	0.67	24.1	8.88	0.76	31.5	10.00	0.86	40.0		
8	2.21	0.24	3.1	3.44	0.37	7.4	4.61	0.50	13.3	5.75	0.62	20.7	6.85	0.74	29.4	7.97	0.86	39.7	9.09	0.98	51.7	10.21	1.10	65.1		
6	2.56	0.37	7.3	3.73	0.53	15.4	4.83	0.69	25.9	6.00	0.86	40.0	7.13	1.02	56.5	8.25	1.18	75.7	9.30	1.33	96.1	10.49	1.50	122.3		
CLIFC-W-600																										
Air inlet temp. (20°C DB)																										
Water inlet temp. (°C)																										
Δt	35			40			45			50			55			60			65			70				
	TH	WF	WPD	TH	WF	WPD	TH	WF	WPD	TH	WF	WPD	TH	WF	WPD	TH	WF	WPD	TH	WF	WPD	TH	WF	WPD	TH	WF
10	2.29	0.20	2.0	3.59	0.31	4.9	4.98	0.43	9.4	6.28	0.54	14.9	7.59	0.65	21.8	8.93	0.77	30.1	10.21	0.88	39.4	11.50	0.99	50.0		
8	2.54	0.27	3.8	3.96	0.43	9.2	5.30	0.57	16.6	6.61	0.71	25.8	7.88	0.85	36.7	9.17	0.99	49.7	10.45	1.12	64.6	11.74	1.26	81.4		
6	2.94	0.42	9.1	4.29	0.61	19.3	5.56	0.80	32.4	6.90	0.99	50.0	8.20	1.18	70.7	9.49	1.36	94.6	10.70	1.53	120.1	12.06	1.73	152.8		

Heating capacity modification coefficient table:

Speed	250	300	400	500	600
	TH	TH	TH	TH	TH
High	1	1	1	1	1
Mid	0.92	0.83	0.85	0.89	0.90
Low	0.83	0.71	0.73	0.76	0.79

Altitude modification coefficient table:

Altitude (m)	TC	SC	TH
500	0.98	0.95	0.95
1000	0.97	0.91	0.91
1500	0.95	0.86	0.86
2000	0.94	0.82	0.82
2500	0.93	0.78	0.78
3000	0.91	0.74	0.7

10. Sound Levels

Test condition

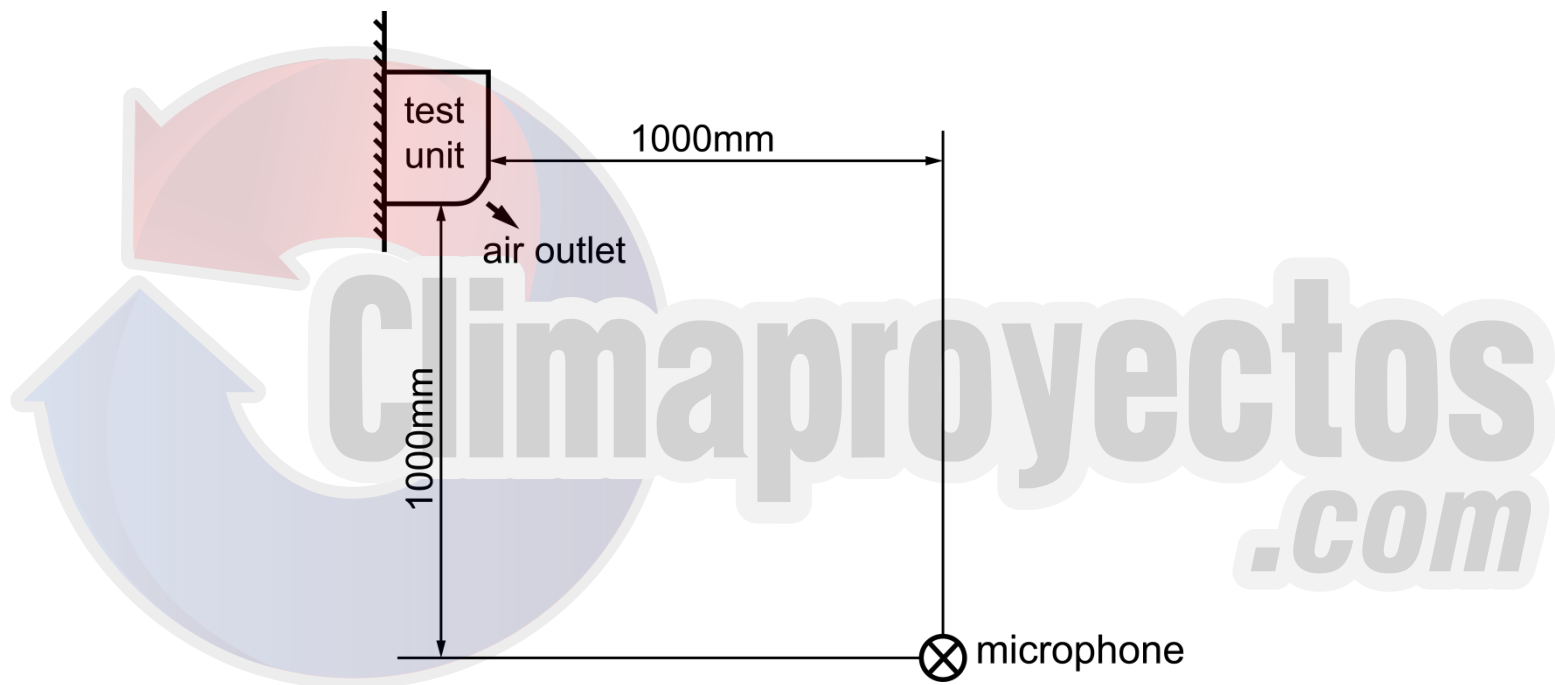

Unit Number	Model	Sound pressure level under three speeds of fan (dB(A))		
		H	M	L
1	CLIFC-W-250	30	24	20
2	CLIFC-W-300	35	29	24
3	CLIFC-W-400	37	31	26
4	CLIFC-W-500	39	33	28
5	CLIFC-W-600	40	34	29

11. Exploded View

CLIFC-W-250, CLIFC-W-300, CLIFC-W-400, CLIFC-W-500, CLIFC-W-600

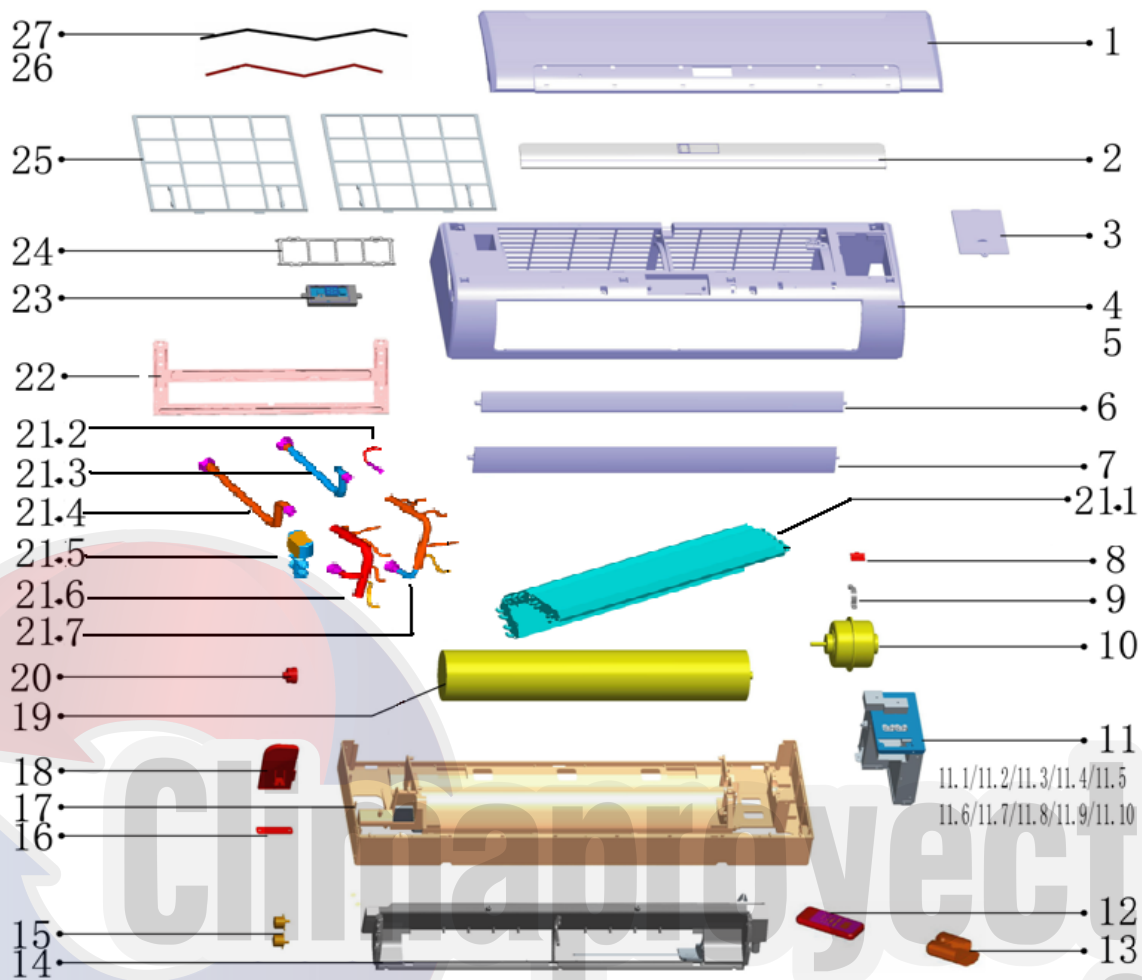

No.	Part Name	Quantity	No.	Part Name	Quantity
1	Panel ass'y	1	16	Pipe clamp	1
2	Panel decorative plates	1	17	Chassis ass'y	1
3	Electrical cover	1	18	Drainage pan ass'y	1
4	Panel frame ass'y	1	19	Cross fan	1
5	Screw cover	3	20	Bearing block	1
8	Sealing plug	2	21	Evaporator ass'y	1
9	Motor spud	2	21.1	Evaporator	1
10	Motor	1	21.2	Evaporator	1
11	E-part box ass'y	1	21.3	Evaporator	1
11.1	Electric control box base	1	21.4	Evaporate connecting board	1
11.2	Electric control box side panel	1	21.5	Evaporate connecting board	1
11.3	electric control box cover	1	21.8	Water-outlet pipe ass'y	1
11.4	Dial switch cover label	1	21.9	Water-inlet pipe ass'y	1
11.5	Dial code switch board ass'y	1	21.10	3-Way valve	1
11.7	Terminal block, 5p	1	21.11	Discharge valve	1
11.8	Main control board ass'y	1	22	Installation board ass'y	1
11.9	Terminal block, 3p	1	23	Display board ass'y	1
11.10	Capacitor	1	24	Air purify net	1
12	Remote controller	1	25	Filter network	2
13	Remote controller bracket	1	26	Pipe temp. sensor ass'y	1
14	Air outlet frame	1	27	Room temp sensor ass'y	1
15	Stepper motor	1			

12. Installation

12.1 Precautions

- Be sure to be in conformity with the local, national and international laws and regulations.
- Read "PRECAUTIONS" carefully before installation.
- The following precautions include important safety items. Observe them and never forget.
- Keep the installation manual in a handy place for future reference.
- Before out from factory, FAN COIL UNIT (AIR UNITS) has passed Fan Coil Overpressure Resistant Test, Statically and Dynamically Balanced Adjustment, Noise Test, Air (cool) Volume Test, Electric Property Test, Outline Quality Detection.

The safety precautions listed here are divided into two categories. In either case, important safety information is listed that must be read carefully.

Warning: Failure to observe a warning may result in death.

Caution: Failure to observe a caution may result in injury or damage to the equipment.









After completing the installation, make sure that the unit operates properly during the start-up operation. Please instruct the customer on how to operate the unit and keep it maintained.

◇ **Warning:**

- **Be sure only trained and qualified service personnel to install, repair or service the equipment.**
Improper installation, repair, and maintenance may result in electric shocks, short-circuit, leaks, fire or other damage to the equipment.
- **Install according to the installation instructions strictly.**
If installation is defective, it will cause water leakage, electrical shock and fire.
- **When installing the unit in a small room, take measures against to keep refrigerant concentration from exceeding allowable safety limits in the event of refrigerant leakage.**
Contact the place of purchase for more information. Excessive refrigerant in a closed ambient can lead to oxygen deficiency.
- **Use the attached accessories parts and specified parts for installation.**
Otherwise, it will cause the set to fall, water leakage, electrical shock and fire.
- **The appliance must be installed 2.3m above floor.**
- **The appliance shall not be installed in the laundry.**
- **Before obtaining access to terminals, all supply circuits must be disconnected.**
- **The appliance must be positioned so that the plug is accessible.**
- **The enclosure of the appliance shall be marked by word, or by symbols, with the direction of the fluid flow.**
- **For electrical work, follow the local national wiring standard, regulation the installation instructions. An independent circuit and single outlet must be used.**
If electrical circuit capacity is not enough or defect in electrical work, it will cause electrical shock fire.
- **Use the specified cable and connect tightly and clamp the cable so that no external force will be acted on the terminal.**
If connection or fixing is not perfect, it will cause heat-up or fire at the connection.
- **Wiring routing must be properly arranged so that control board cover is fixed properly.**
If control board cover is not fixed perfectly, it will cause heat-up at connection point of terminal, fire or electrical shock.
- **If the supply cord is damaged, it must be replaced by the manufacture or its service agent or a similarly qualified person in order to avoid a hazard.**
- **An all-pole disconnection switch having a contact separation of at least 3mm in all poles should be connected in fixed wiring.**

- **When carrying out piping connection, take care not to let air substances go into refrigeration cycle.**
Otherwise, it will cause lower capacity, abnormal high pressure in the refrigeration cycle.
 - **Do not modify the length of the power supply cord or use of extension cord, and do not share the single outlet with other electrical appliances.**
Otherwise, it will cause fire or electrical shock.
 - **If the water leaks during installation, ventilate the area immediately.**
 - **After completing the installation work, check that the water does not leak.**
The cool water in the unit is not lower than 3°C, hot water is not higher than 70°C. Water in the unit must be clean, air quality must meet to the standard of PH=6.5~7.5.
- ✧ **Caution:**
- **Ground the air conditioner.**
Do not connect the ground wire to gas or water pipes, lightning rod or telephone ground wire. Incomplete grounding may result in electric shocks.
 - **Be sure to install an earth leakage breaker.**
Failure to install an earth leakage breaker may result in electric shocks.
 - **Connect the outdoor unit wires, and then connect the indoor unit wires.**
You are not allowed to connect the air conditioner with the power source until wiring and piping the air conditioner is done.
 - **While following the installation instructions, install drain piping in order to ensure proper drainage and insulate piping in order to prevent condensation.**
Improper drain piping may result in water leakage and property damage.
 - **Install the indoor and outdoor units, power supply wiring and connecting wires at least 1 meter away from televisions or radios in order to prevent image interference or noise.**
Depending on the radio waves, a distance of 1 meter may not be sufficient enough to eliminate the noise.
 - **This appliance is not intended for use by persons (including children) with reduced physical, sensory or mental capabilities, or lack of experience and knowledge, unless they have been given supervision or instruction concerning use of the appliance by a person responsible for their safety.**
- ✧ **Don't install the air conditioner in the following locations:**
- There is petrolatum existing.
 - There is salty air surrounding (near the coast).
 - There is caustic gas (the sulfide, for example) existing in the air (near a hot spring).
 - The Volt vibrates violently (in the factories).
 - In buses or cabinets.
 - In kitchen where it is full of oil gas.
 - There is strong electromagnetic wave existing.
 - There are inflammable materials or gas.
 - There is acid or alkaline liquid evaporating.
 - Other special conditions.

12.2 Accessory

Name	Shape	Quantity	Function
1. Screw ST3.9x25 for installation board		3	Secure the installation board
2. Plastic expanded tube		3	_____
3. Wrapping tape		1	_____
4. Drain pipe		1	_____
5. Wall conduit cover		1	_____
6. Remote controller (including operation manual)		1	_____
7. Frame		1	Hold the remote controller
8. Mounting screw (ST2.9 x 10-C-H)		2	Insulation the holder of remote controller
9. Alkaline dry batteries (AM4)		2	_____
10. Owner's manual	_____	1	_____
11. Installation manual	_____	1	_____
12. seel gasket	_____	4	For connecting water pipe

12.3 Remote controller installation

- Never throw or beat the controller.
- Before installation, operate the remote controller to determine its location in a reception range.
- Keep the remote controller at least 1m apart from the nearest TV set or stereoequipment. (it is necessary to prevent image disturbances or noise interferences.)
- Do not install the remote controller in a place exposed to direct sunlight or close to a heating source, such as a stove.
- Note that the positive and negative poles are right positions when loading batteries.
- This information is subject to changes due to technological improvement without further notices.

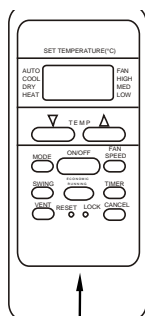

Remote controller

Mounting screw B
ST2.9x10-C-H

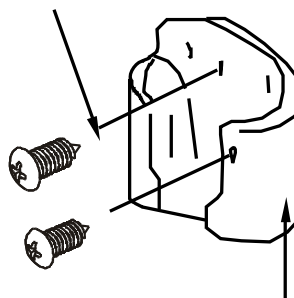

Remote controller holder

12.4 Indoor unit installation

12.4.1 Installation place

Installation in the following places may cause trouble. If it is unavoidable, please consult with the local dealer.

- A place full of machine oil.
- A saline place such as coast.
- A place full of sulfide gas such as hot-spring resort.
- Places where there are high frequency machines such as wireless equipment, welding machine, and medical facility.
- A place there is no combustive gases and volatile matter.
- A place of special environmental conditions.

Indoor unit installation place

- A place where is no obstacle near the inlet and outlet area.
- A place which can bear the indoor unit.
- A place which is convenient to maintenance.
- A place which provides the space around the indoor unit as required right in the diagram.
- There is strong electromagnetic wave existing.
- A place which is far from heat, steam and inflammable gas.

12.4.2 Drilling a hole and mounting installation board

Installation Board and Its Direction (unit: mm)

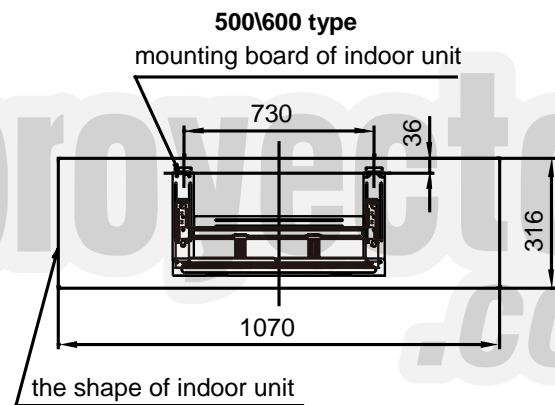
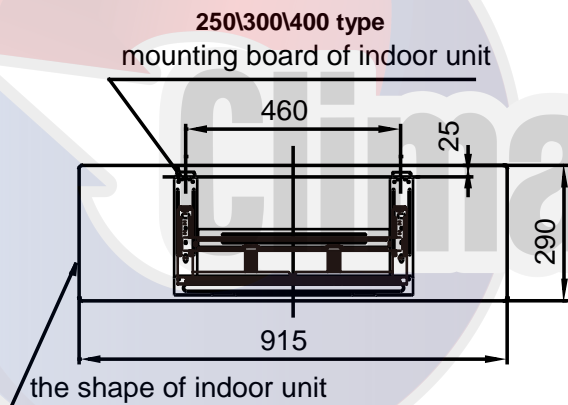

Fix the installation board.

- Install the installation board horizontally on structural parts on the wall with the spaces provided around the plate.
- In case of brick, concrete or similar type walls, make 5mm dia. holes on the wall. Insert clip anchors for appropriate mounting screws.
- Fix the installation board on the wall.

Right installation

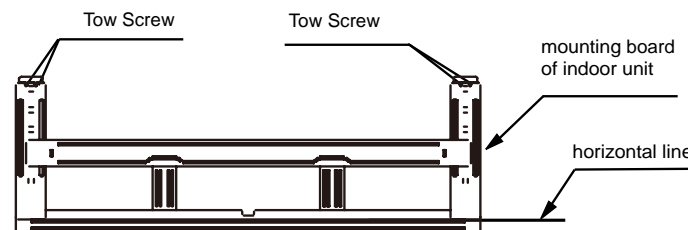

False installation

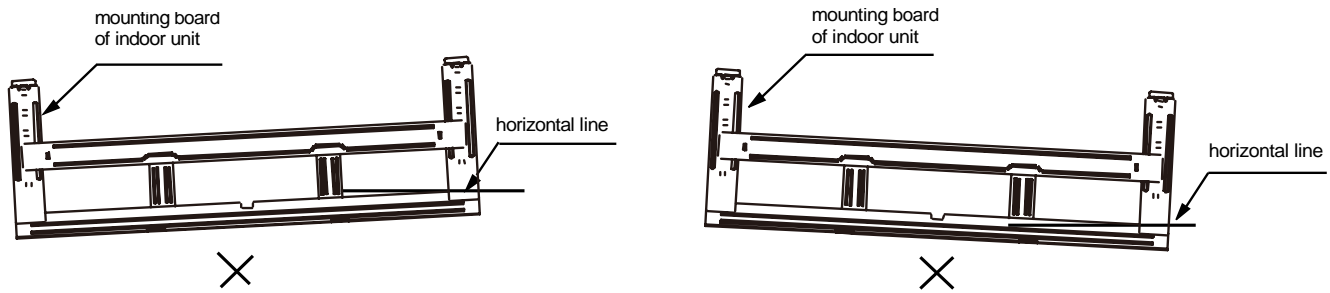

Drilling a hole

- Determine the pipe hole position using the installation board, and drill the pipe hole (N95mm) so it slants slightly downward.
- Always use a wall hole conduit when piercing metal lath, ply wood or metal plate.

12.4.3 Connective and drain pipe installation

Drain pipe installation

- Run the drain hose sloping downward. Do not install the drain hose as illustrated below.

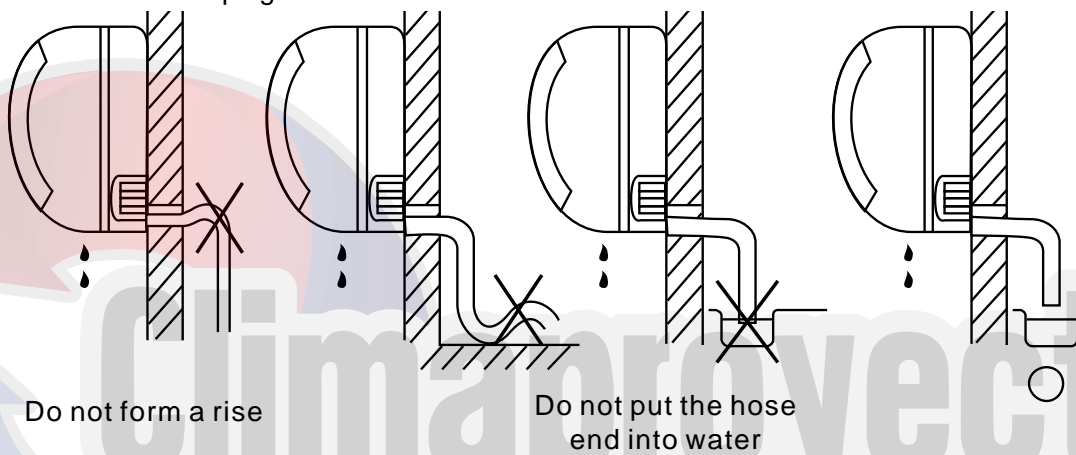

- When connection extended drain hose, insulate the connecting part of extended drain hose with a shield pipe.

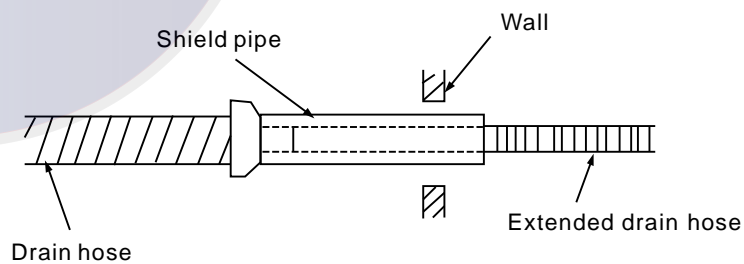

Connection pipe installation

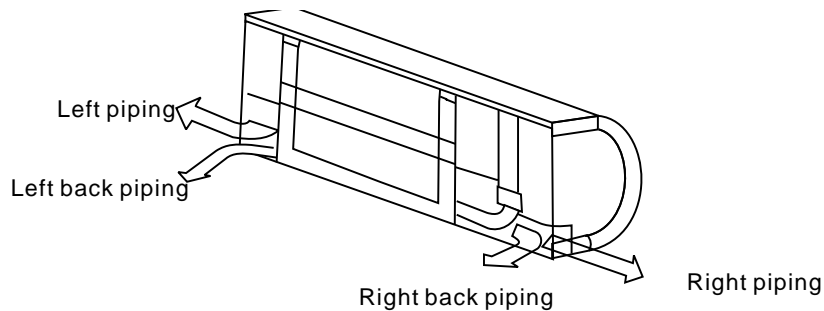

- For the left-hand and rear-left-hand piping, install the piping as shown. Bend the connective pipe to be laid at 43mm height or less from the wall.

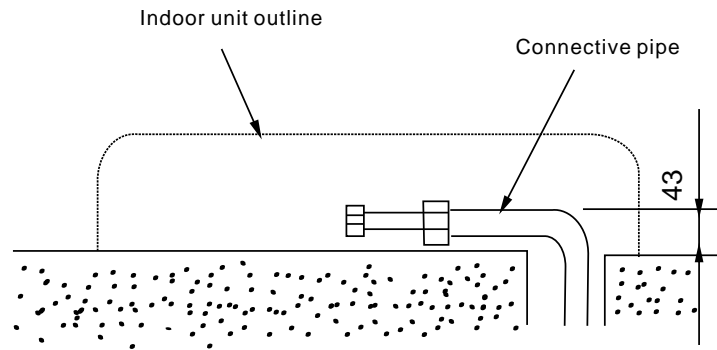

- Fix the end of the connective pipe. (Refer to Tightening Connection in WATER PIPING INSTALLATION)

Cautions:

- Connect the indoor unit first, then the outdoor unit. Bend and arrange the pipe carefully.
- Do not allow the piping to let out from the back of the indoor unit.
- Be careful not to let the drain hose slack.
- Insulate both of the auxiliary piping.
- Banding the drain hose under the auxiliary pipe.

Piping and bandaging

Wind the connective cable, drain hose and wiring with tape securely, evenly as shown below.

- Because the condensed water from rear of the indoor unit is gathered in Pond Box and is piped out of room. Do not put anything else in the box.

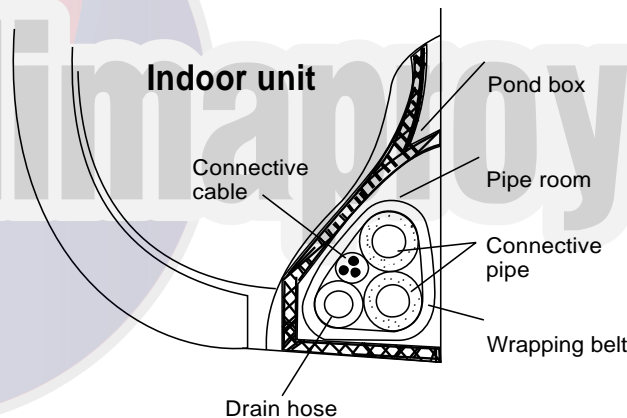

12.4.4 Indoor unit installation

- Pass the piping through the hole in the wall.
- Put the claw at the back of the indoor unit on the hook of the installation board, move the Indoor Unit from side to side to see that it is securely hooked.
- Piping can easily lift the indoor unit by the cushioning material between the indoor unit and the wall. Get it out after finish piping.
- Push the lower part of the Indoor Unit up to the wall, and then move the Indoor Unit from side to side, up and down to check if it is hooked securely.

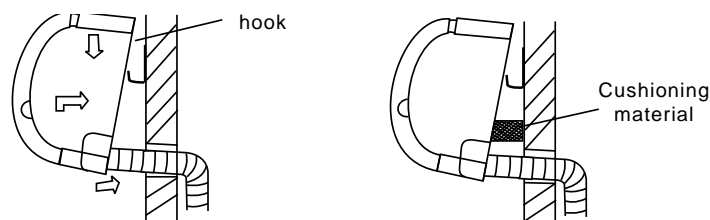

12.5 Water pipe installation

Connection of the water pipe should be done by professionals. Double-span should be used when connecting pipes of Indoor Unit.

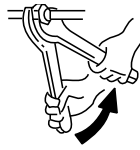

- At the first debugging, completely expel air from coils via expelling valve.

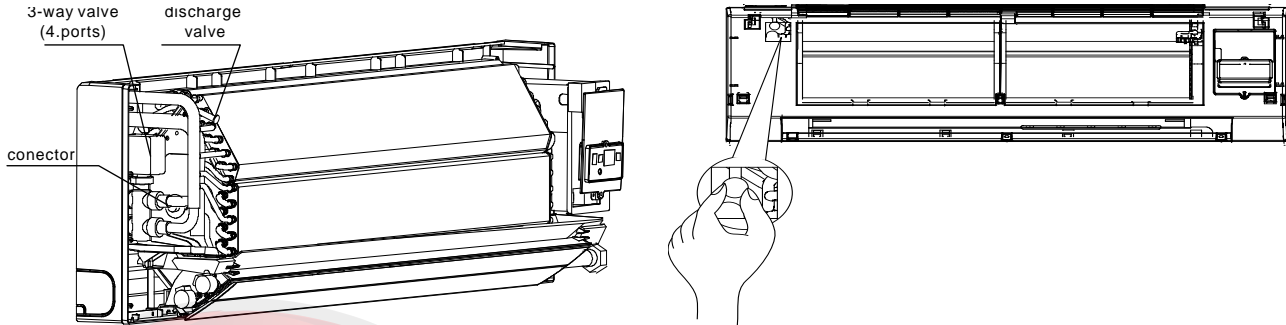

12.6 Wiring chart

The wiring diagram please refers to chapter 8.

Cautions:

- The reserved function is indicated in broken line table, users can select it when necessary.
- An all-pole disconnection device which has at least 3mm separation distance in all pole and a residual current device (RCD) with the rating of above 10mA shall be incorporated in the fixed wiring according to the national rule.
- The appliance shall be installed in accordance with national wiring regulations.

Take out the faceplate, and then dismantle the display cover

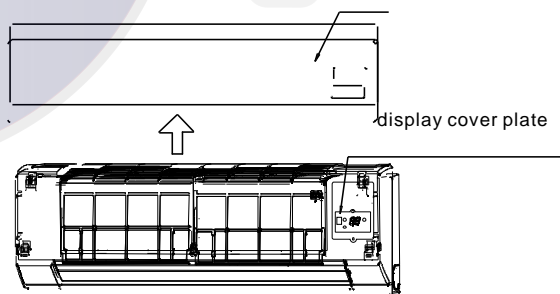

Individual connect the power cord and signal line, adjust the dial switch.

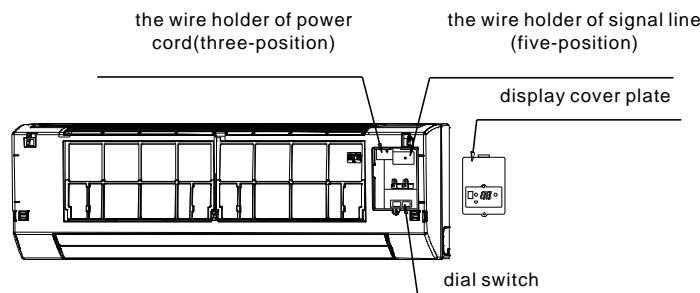

12.6.1 Terminal Board Diagram

Note: The air-conditioners can connect with Central Control Monitor (CCM). Before operation, please wiring

correctly and set system address and network address of indoor units.

- Single phase indoor unit

Power supply	220-240V/1 ph/60Hz	
Circuit breaker/fuse (A)	15/15	
Indoor unit power wiring	Below 20m	Twisted pairwire 2.5 mm ²
	Below 50m	Twisted pairwire 6 mm ²
Ground wiring (mm ²)	2.5	

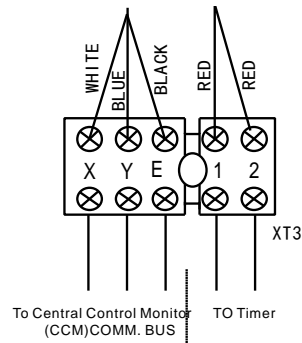
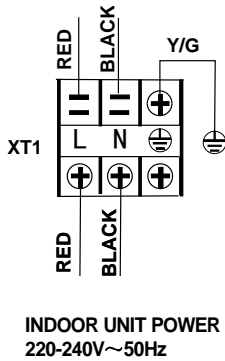

- Please adopt the shielded twisted-pair wire, and connect the shielded layer to E

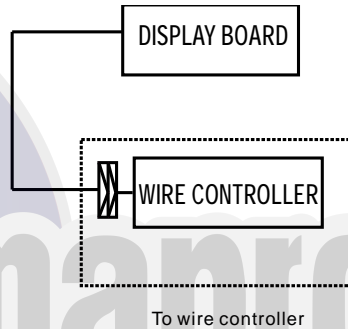





The reserved wire control function is indicated in broken line table, users can purchase the wire controller when necessary.

12.6.2 Network address setting

Every air-conditioner in network has only one network address to distinguish each other. Address code of air-conditioner in LAN is set by code switch on Network Interface Module (NIM), and the set range is 0-63.

Toggle switch set			Network address code
SW1	ENC2		
		~	00~15
		~	16~31
		~	32~47
		~	48-63

Functions of anti-cold wind and anti-hot wind

Toggle switch set	Function selection
SW2	
	Anti-cold wind OFF, Anti-hot wind OFF
	Anti-cold wind OFF, Anti-hot wind ON
	Anti-cold wind ON, Anti-hot wind OFF
	Anti-cold wind ON, Anti-hot wind ON

12.7 Troubleshooting

Malfunction code	Malfunction
EE	DC motor malfunction
E3	T2 evaporator sensor malfunction
E2	T1 evaporator sensor malfunction
E8	Water-level alarm malfunction
E7	EEPROM communication error

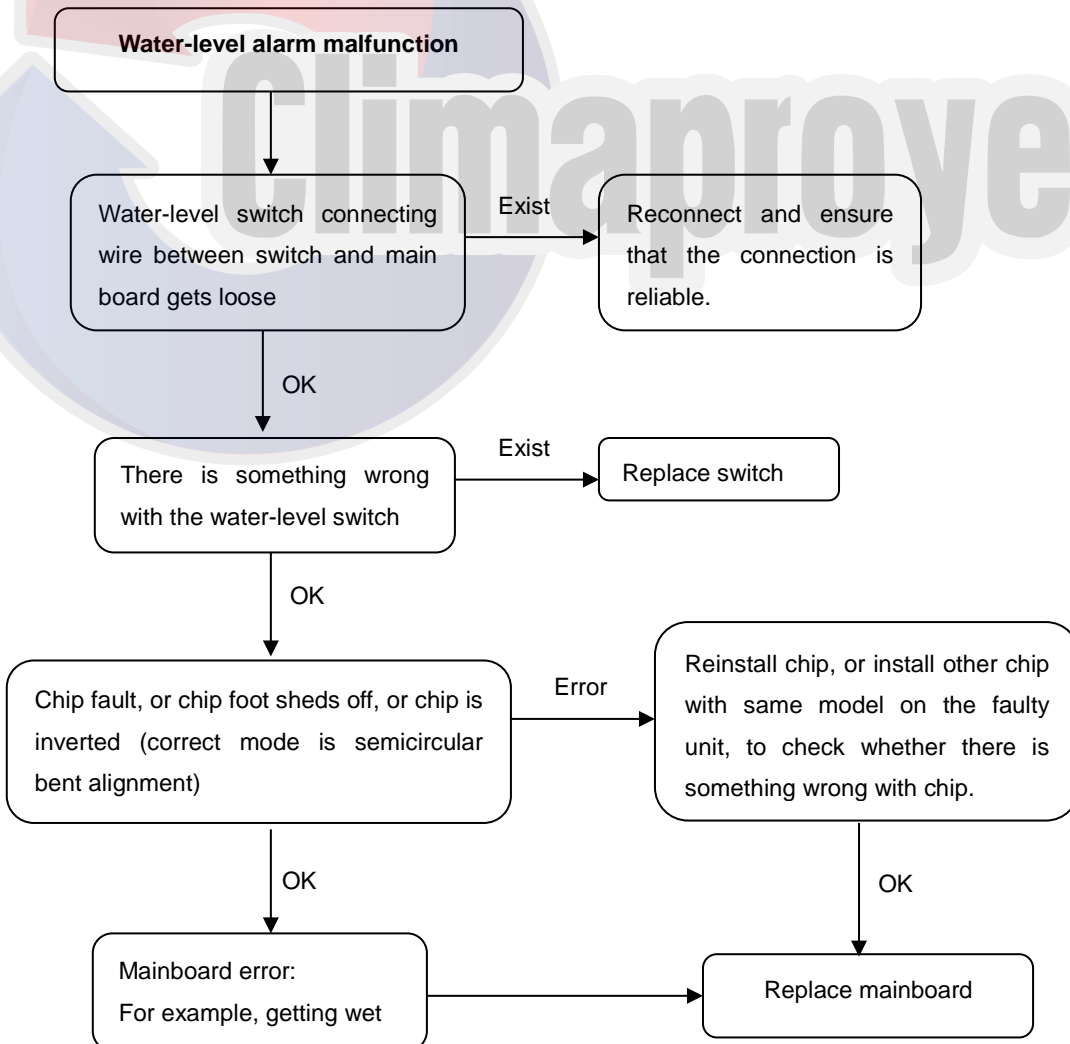

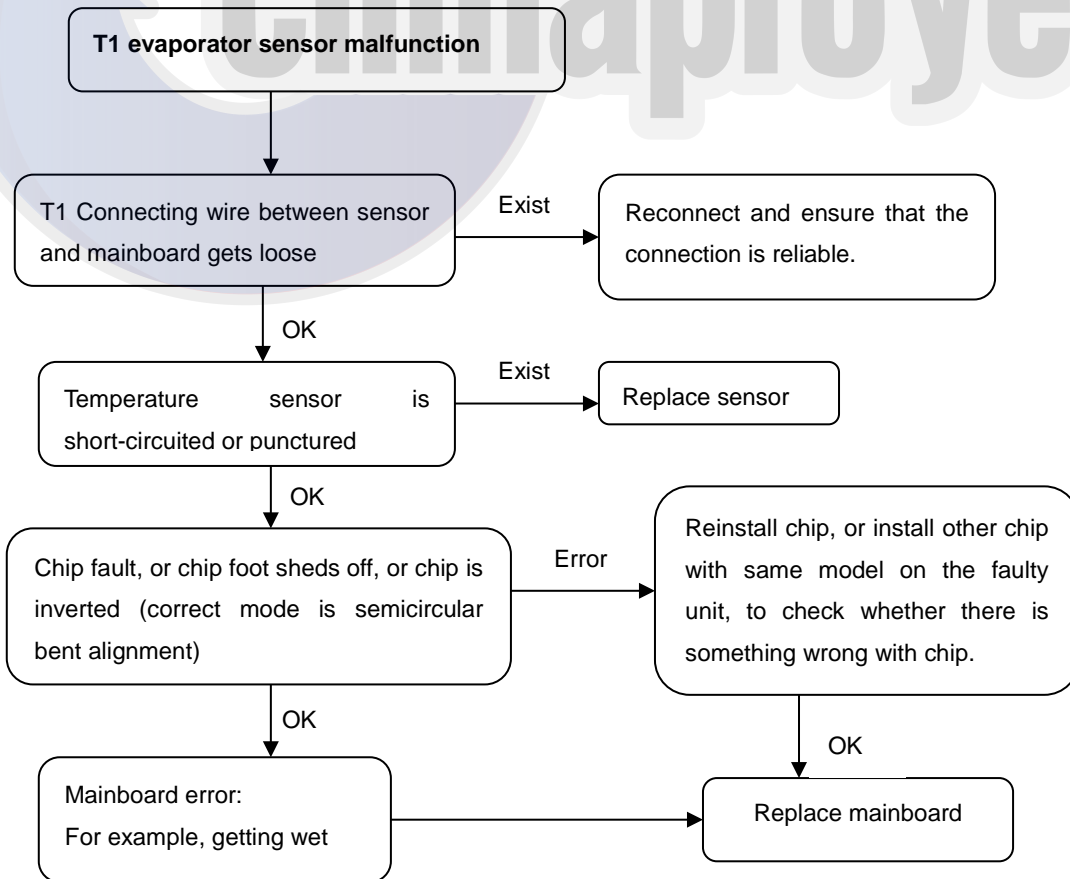
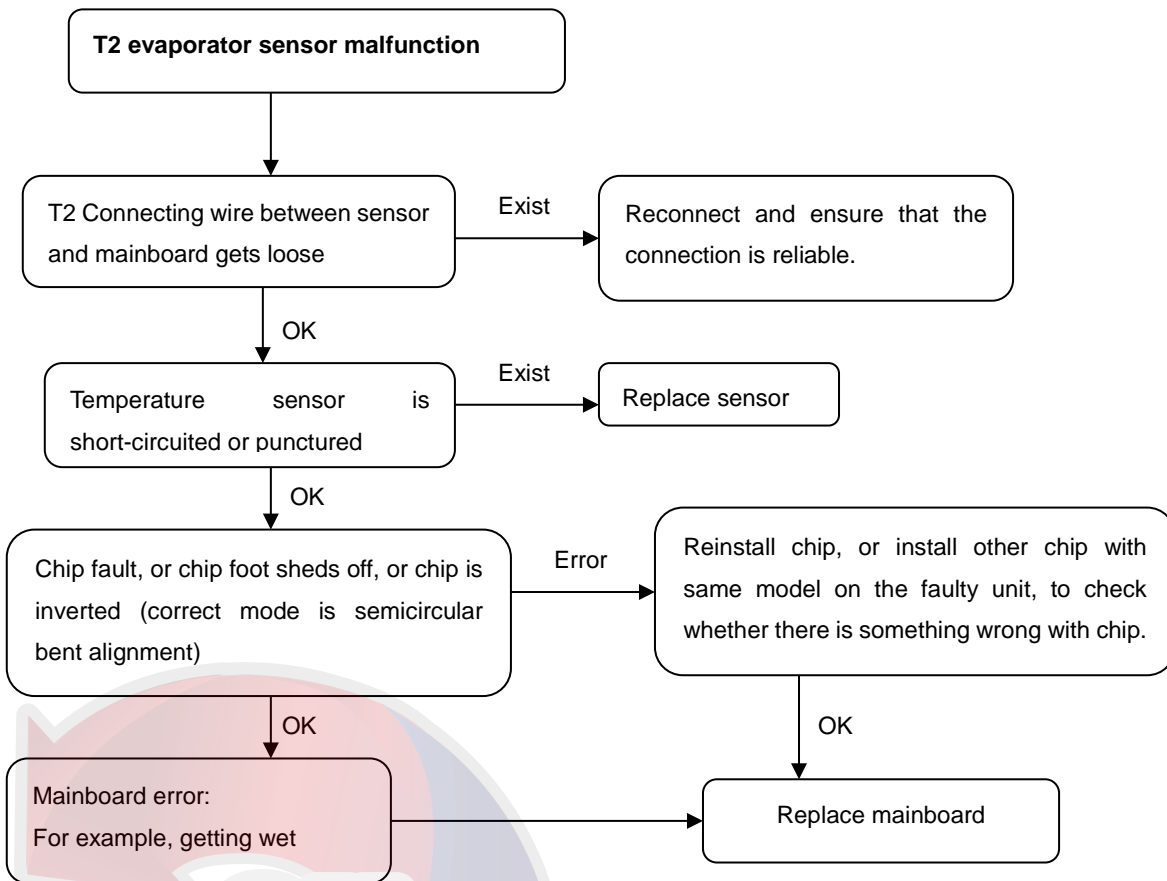

12.7.1 Troubles and causes of air conditioner

If one of the following malfunctions occur, stop operation, shut off the power, and contact with your dealer.

- The operation lamp is flashing rapidly (twice every second)
- This lamp is still flashing rapidly after turn off the power and turn on again.
- Remote controller receives malfunction or the button does not work well.
- A safety device such as a fuse, a breaker frequently actuates.
- Water leaks from indoor unit.
- Other malfunctions.

Symptoms	Causes	Solution
Unit does not start	<ul style="list-style-type: none"> • Power failure. • Power switch is off. • Fuse of power switch may have burned. • Batteries of remote controller exhausted or other problem of controller. 	<ul style="list-style-type: none"> • Wait for the comeback of power. • Switch on the power. • Replace the fuse. • Replace the batteries or check the controller.
Air flowing normally but completely can't cooling	<ul style="list-style-type: none"> • Temperature is not set correctly. 	<ul style="list-style-type: none"> • Set the temperature properly.
Low cooling effect	<ul style="list-style-type: none"> • Indoor unit heat exchanger is dirty. • The air filter is dirty. • Inlet of indoor units is blocked. • Doors and windows are open • Sunlight directly shine. • Too much heat resource. • Outdoor temp. is too high. 	<ul style="list-style-type: none"> • Clean the heat exchanger. • Clean the air filter. • Eliminate all dirties and make air smooth. • Close doors and windows. • Make curtains in order to shelter from sunshine. • Reduce heat source. • AC cooling capacity reduces (normal).
Low heating effect	<ul style="list-style-type: none"> • Outdoor temperature is lower than 7°C . • Doors and windows not completely closed. 	<ul style="list-style-type: none"> • Use heating device. • Close doors and windows.

12.7.2 Troubles and causes of remote controller

Before asking for serving or repairing, check the following points.

Symptoms	Causes	Solution
The fan speed can not be changed.	<ul style="list-style-type: none"> ● Check whether the MODE indicated on the display is "AUTO" 	When the automatic mode is selected, the air conditioner will automatically change the fan speed.
	<ul style="list-style-type: none"> ● Protection against hot wind in cooling mode. ● Protection against cold wind in heating mode. 	Reduce the temperature of inlet in cooling mode rise the temperature of inlet in heating mode.
The remote controller signal is not transmitted even when the ON/OFF button is pushed.	<ul style="list-style-type: none"> ● Check whether the batteries in the remote controller are exhausted. 	The power supply is off.
The TEMP. indicator does not come on.	<ul style="list-style-type: none"> ● Check whether the MODE indicated on the display is FAN ONLY 	The temperature cannot be set during FAN mode.
The indication on the display disappears after a lapse of time.	<ul style="list-style-type: none"> ● Check whether the timer operation has come to an end when the TIMER OFF is indicated on the display. 	The air conditioner operation will stop up to the set time
The TIMER ON indicator goes off after a lapse of certain time.	<ul style="list-style-type: none"> ● Check whether the timer operation is started when the TIMER ON is indicated on the display. 	Up to the set time, the air conditioner will automatically start and the appropriate indicator will go off.
No receiving tone sounds from the indoor unit even when the ON/OFF button is pressed.	<ul style="list-style-type: none"> ● Check whether the signal transmitter of the remote controller is properly directed to the infrared signal receiver of the indoor unit when the ON/OFF button is pressed. 	Directly transmit the signal transmitter of the remote controller to the infrared signal receiver of the indoor unit, and then repeatedly push the ON/OFF button twice.

13. Controller

13.1 Standard Controller : Remote Controller R51/E

13.1.1 Specifications

Model	R51/E
Rated Voltage	3.0V
Lowest Voltage of CPU Emitting Signal	2.0V
Reaching Distance	8m (when using 3.0 voltage, it can get 11m)
Environment Temperature Range	-5 °C~60 °C

13.1.2 Performance Features

1. Operating Mode: COOL、HEAT、 DRY、 FAN and AUTO.
2. Timer Setting Function in 24 hours.
3. Indoor Temperature Setting Range : 17°C~30°C.
4. LCD display for all functions.
5. Compatible with the former R11.

13.1.3 Function Buttons Introduction

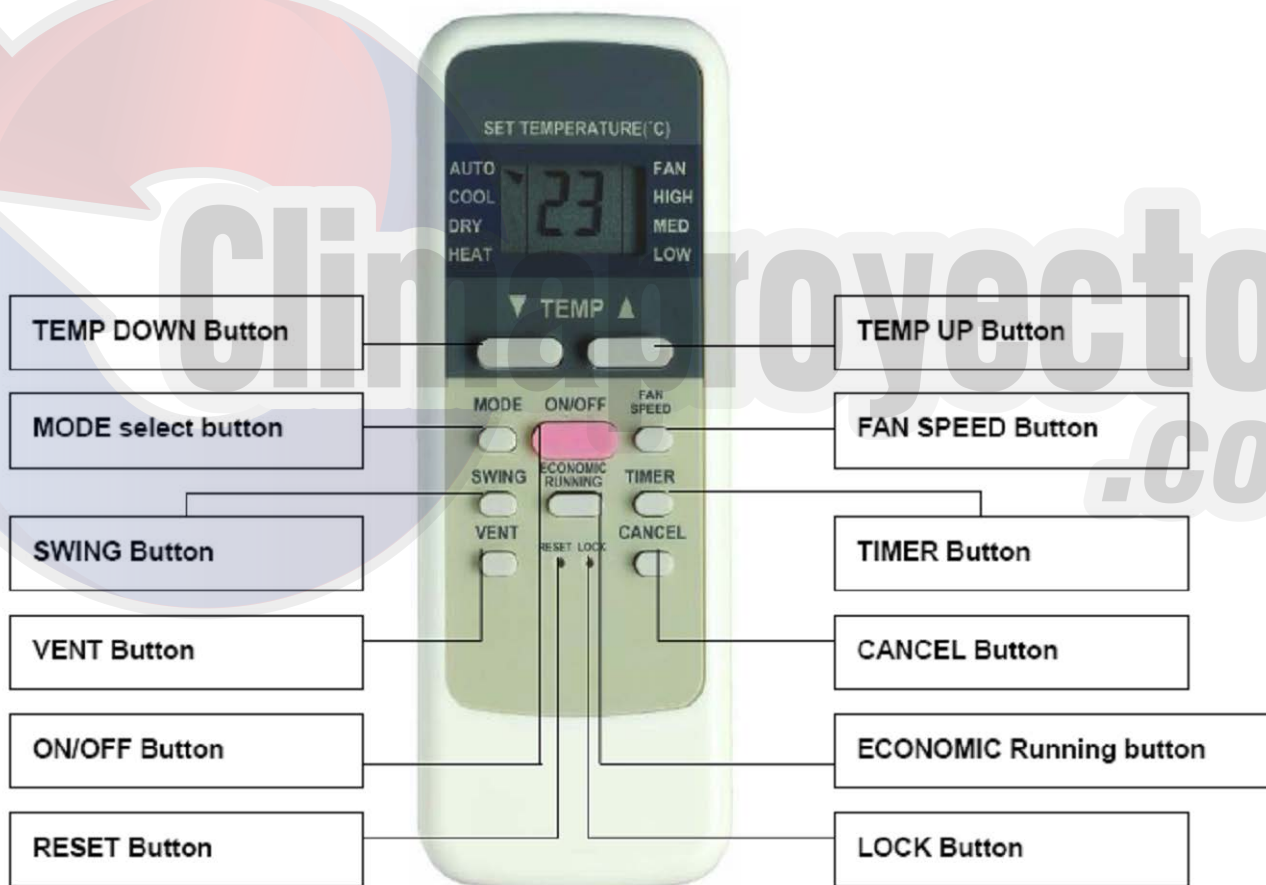

1. **TEMP DOWN Button:** Push the TEMP DOWN button to decrease the indoor temperature setting or to adjust the timer in a counter-clockwise direction.
2. **MODLE SELECT Button:** Each time you push the button, a mode is selected in a sequence that goes from AUTO, COOL, DRY, HEAT and FAN as the following figure indicates:



▲ NOTE: HEAT only for Heat Pump

3. **SWING Button:** Push this switch button to change the louver angle.

4. **RESET Button:** When the RESET button is pushed, all of the current settings are cancelled and the control will return to the initial settings.
5. **ECONOMIC RUNNING Button:** Push this button to go into the Energy-Saving operation mode.
6. **LOCK Button:** Push this button to lock in all the current settings. To release settings, push again.
7. **CANCEL Button:** Push this button to cancel the TIMER settings.
8. **TIMER Button:** This button is used to preset the time ON (start to operate) and the time OFF (turn off the operation)
9. **ON/OFF Button:** Push this button to start the unit operation. Push the button again to stop the unit operation.
10. **FAN SPEED Button:** This button is used for setting fan speed in the sequence that goes from AUTO, LOW, MED to HIGH, and then back to Auto.
11. **TEMP UP Button:** Push this button to increase the indoor temperature setting or to adjust the timer in a counter-clockwise direction.
12. **VENT Button:** Push this button to set the ventilating mode. The ventilating mode will operate in the following sequence:

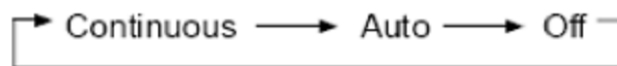

Ventilation Function is available for the Fresh Star Series.

13.1.4 Indicators Introduction

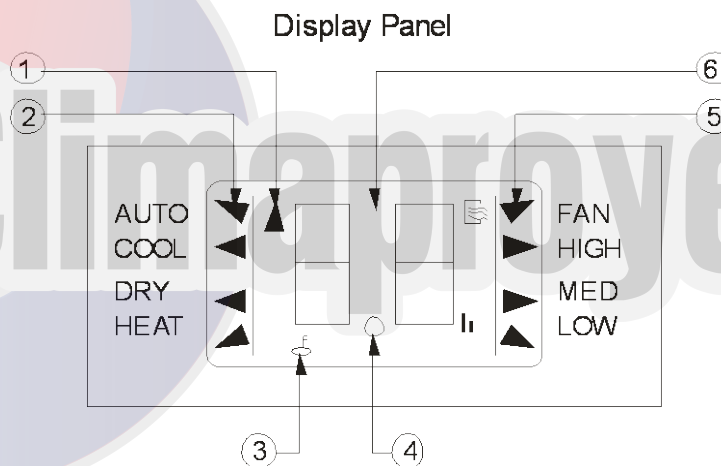

1. **TRANSMISSION Indicator:** This indicator lights when remote controller transmits signals to indoor unit.
2. **MODE Display:** Shows the current operation mode - AUTO, COOL, DRY or HEAT. HEAT only available for heat pump model.
3. **HEAT PUMP ONLY- LOCK display** is displayed by pushing the LOCK button. Push the LOCK button again to clear display.
4. **TIMER Display:** This display area shows the settings of TIMER. That is, if only the starting time of operation is set, it will display the TIMER ON. If only the turning off time of operation is set, it will display the TIMER OFF. If both operations are set, it will show TIMER ON OFF which indicates you have chosen to set both the starting time and off time.
5. **FAN Display:** When the FAN button is pushed, this signal indicator lights.
6. **Digital Display Area:** This area will show the temperature, and if in the TIMER mode, it will show the ON and OFF settings of the TIMER.

NOTE: All items are shown in the Fig for the purpose of clear presentation, But during the actual operation only the relative functional items are shown on the display panel.

13.1.5 Operational Guidelines

13.1.5.1 Operating the Remote Controller

Install / Replace Batteries: The Remote Controller uses two alkaline dry batteries(R03/Ir03X2).

1. To install batteries, slide back the cover of the battery compartment and install the batteries according to the directions (+and -) shown on the Remote Controller.
2. To replace the old batteries , use the same method as mentioned above.

Note :

1. When replacing batteries, do not use old batteries or a different type battery. This may cause the remote controller to malfunction.
2. If you do not use the remote controller for several weeks remove the batteries. Otherwise battery leakage may damage the remote controller.
3. The average battery life under normal use is about 6 months.
4. Replace the batteries when there is no answering beep from the indoor unit or if the Transmission Indicator light fails to appear.

13.1.5.2 Automatic Operation

When the Air Conditioner is ready for use, switch on the power and the OPERATION indicator lamp on the display panel of the indoor unit starts flashing.

1. Use the MODE select button to select AUTO.
2. Push the TEMP button to set the desired room temperature. The most comfortable temperature settings are between 21°C to 28°C.
3. Push the ON/OFF button to start the air conditioner. The OPERATION lamp on the display panel of the indoor unit lights. The operating mode of AUTO FAN SPEED is automatically set and there are no indicators shown on the display panel of the remote controller.
4. Push the ON/OFF button again to stop the unit.

Note :

1. In the AUTO mode, the air conditioner can logically choose the mode of COOL, FAN, HEAT and DRY by sensing the difference between the actual ambient room temperature and the set temperature on the remote controller..
2. If the AUTO mode is not comfortable for you , the desired mode can be selected manually.

13.1.5.3 COOL, HEAT, and FAN ONLY Operation

1. If the AUTO mode is not comfortable, you may manually override the settings by using COOL, DRY, HEAT(HEAT PUMP units only), or FAN ONLY modes.
2. Push the TEMP button to set the desired room temperature. When in COOLING mode, the most comfortable settings are 21°C or above. When in HEATING mode, the most comfortable settings are 28°C or below.
3. Push the FAN SPEED to select the FAN mode of AUTO, HIGH, MED or LOW.
4. Push the ON/OFF button. The operation lamp lights and the air conditioner starts to run according to your settings.
5. Push the ON/OFF button again to stop.

Note :

The FAN ONLY mode cannot be used to control the temperature. While in this mode, only steps 1、 3 and 4 may be performed.

13.1.5.4 Dry Operation

1. Push the MODE button to select DRY.
2. Push the TEMP button to set the desired temperature from 21°C to 28°C.
3. Push the ON/OFF button. The operation lamp lights and the air conditioner starts to run in the DRY mode.
4. Push the ON/OFF button again to stop the unit.

Note :

Due to the difference of the set temperature of the unit and the actual indoor temperature, the Air

Conditioner when in DRY mode will automatically operate many times without running the COOL and FAN mode.

13.1.5.5 Time Operation

PUSH TIMER button to set the on and off times of the unit.

1. To set the STARTING time.

- 1.1 Please push the CANCEL button to cancel any former settings.
- 1.2 Push the TIMER button. The remote controller will show the TIMER and the signal "h" is shown on the display panel. The control is now ready to reset the TIMER ON to start the operation.
- 1.3 Push the TEMP button (▼ or ▲) to set desired unit START time .
- 1.4 After setting the TIMER there will be a one-half second delay before the remote controller transmits the signal to the Air Conditioner. Then, after approximately another 2 seconds, the set temperature will re-appear on the digital display.

2. To set the STOPPING time.

- 2.1 Please press the CANCEL button to cancel any former settings.
- 2.2 Push the TIMER button and the remote controller will show the last set time for the START operation and the signal "h" will be shown on the display panel. You are now ready to re-adjust the TIMER OFF to stop the operation.
- 2.3 Push the TEMP button to cancel the TIMER ON setting. The digital area will show "00".
- 2.4 Push the TIMER button and the remote controller will show the last set time for the STOP operation and the signal "h" will be shown on the display panel. You are now ready to reset the time of the STOP operation.
- 2.5 Push the TEMP button (▼ or ▲) to set the time you want to stop the operation.
- 2.6 After setting the TIMER there will be a one-half second delay before the remote controller transmits the signals to the Air Conditioner. Then after approximately another 2 seconds, the set temperature will re-appear on the digital display.

3. Set the STARTING & STOPPING time

- 3.1 Please press the CANCEL button to cancel any former settings.
- 3.2 Push the TIMER button and the remote controller will show the last setting time for START operation and the signal "h" will be shown on the display panel. You are now ready to readjust the TIMER ON to start the operation.
- 3.3 Push the TEMP button (▼ or ▲) to set the time you want to start the operation.
- 3.4 Push the TIMER button and the remote controller will show the last set time for STOP operation and the signal "h" will be shown on the display panel. You are now ready to reset the time of the STOP operation.
- 3.5 Push the TEMP button (▼ or ▲) to set the time you want to stop the operation.
- 3.6 After setting the TIMER there will be a one-half second delay before the remote controller transmits the signal to the Air Conditioner. Then, after approximately another 2 seconds ,the set temperature will re-appear on the digital display.

Note :

1. Please reset the TIMER after cancelling the former time settings.
2. The setting time is relative time. That is the time set is based on the delay of the current time.

13.2 Optional Controller

13.2.1 Wired Controller KJR-10B



Name and function of LCD display on the wired controller

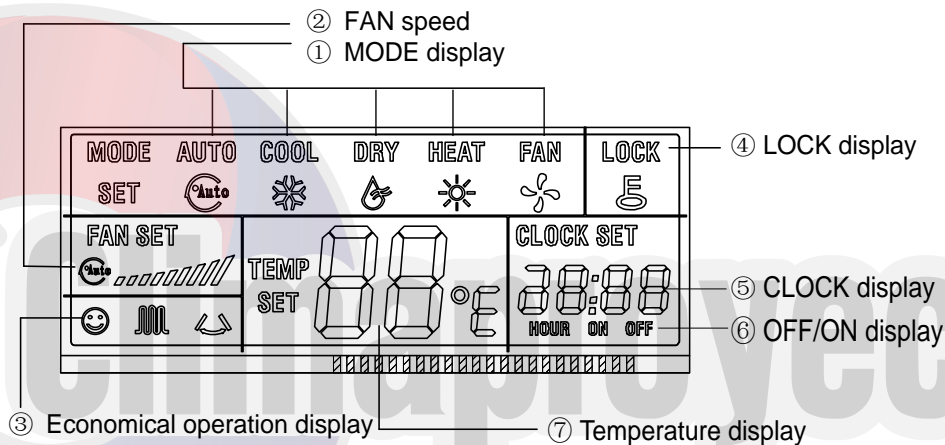

1. Mode select button (MODE):
Press MODE button to select "COOL", "DRY", "HEAT", or "FAN ONLY" mode. (HEAT is invalid for COOL ONLY wire controller.)
2. Fan speed button (FAN SPEED)
Press FAN SPEED to select fan speed from "AUTO", "LOW", "MED", and "HIGH". NOTE: some air conditioners have no MED fan speed, and then the MED is regarded as HIGH.
3. Economical operation displays:
Press ECONOMICAL to display economical operation, if press ECONOMICAL again then the display disappears
4. Lock display
Press LOCK to display the icon of LOCK. Press the button again then the icon of LOCK disappears. In the mode of LOCK, all the buttons are invalid except for LOCK button.
5. CLOCK display
Usually display the clock set currently. Press the button CLOCK for 4 seconds, the HOUR part will flash, press button ▲ and ▼ to adjust HOUR. Press the button CLOCK again, the minute part flash, press button ▲ or ▼ to adjust MINUTE. After clock set or clock operation, it must press CONFIRM to complete the set.
6. TIMER ON/OFF display:
Display ON at the state of TIMER ON adjustment or after only set the TIMER ON; Display OFF at the

state of TIMER OFF adjustment or after only set the TIMER OFF; Display ON/OFF if simultaneously set the mode of TIMER ON and TIMER OFF.

7. Temperature display area:

Usually display the set temperature. Press the buttons of and to set temperature, at the mode of FAN, there is no figure display in the area.

Name and functions of buttons on the wired controller

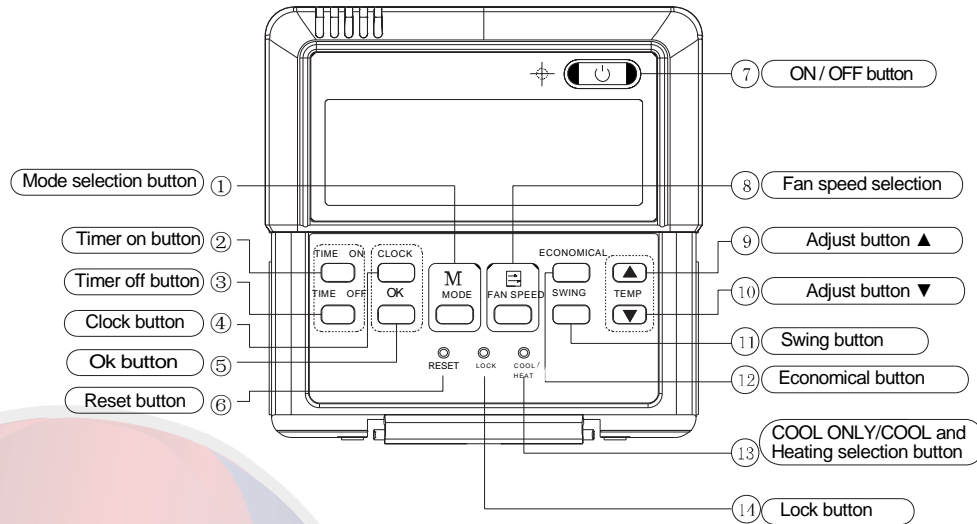

1. Mode selection button:

It is used to select mode, push the button one time, then the operation modes will change in turn as follows:

AUTO → COOLING → DEHUMIDIFY → HEATING → FAN

Remark: no heating mode if wire controller is set as the cool only.

2. Timer on button:

Push the button to set TIMER ON, each time you push the button the time moves forward by 0.5 hours. When the set time is over 10 hours, each time you push the button the time moves forward by 1 hour. If want to cancel the TIMER ON, then adjust the time of TIMER ON as 0.0

3. Timer off button:

Push the button to set TIMER OFF, each time you push the button the time moves forward by 0.5 hours. When the set time is over 10 hours, each time you push the button the time moves forward by 1 hour. If want to cancel the TIMER OFF, then adjust the time of TIMER OFF as 0.0

4. CLOCK button:

Normally display the clock set currently (display 12:00 for the first electrifying or resetting). When push the button for 4 seconds, the hour part on the clock display flashes every 0.5 seconds, then push button and to adjust hour; push the button CLOCK again, the minute part flashes every 0.5 seconds, then push and button to adjust minute. When set clock or alter clock setting, must push the confirm button to complete the setting.

5. Ok button:

The button is used at the state of CLOCK adjustment. After select the time, push the button to confirm then exit, the current clock will display

6. Reset button (hidden):

Use a small stick with a diameter of 1mm to push the RESET button to cancel the current settings and get into the condition of resetting.

7. ON/OFF button:

Push the button at the condition of OFF, the OPERATION lamp lights, and the wire controller enters into ON operation, simultaneously sends the information of operation mode set currently, temperature, fan speed, timer etc. Push the button at the condition of ON, the OPERATION lamp extinguishes, simu-

Itaneously sends the OFF. If having set TIMER ON or TIMER OFF, the wire controller will cancel these settings before entering into OFF, close the concern indicator, and then send the OFF information.

8. Fan speed selection button (FAN SPEED)

Select any one fan speed from "AUTO", "LOW", "MED", and "HIGH". Each time push the button, the fan speed will change in turn as follow.

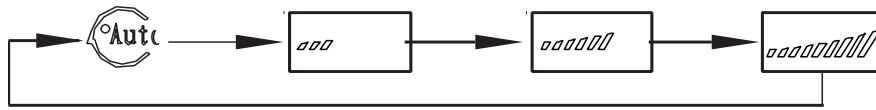

9. Adjust button ▲:

Set indoor temperature up. If press and hold on, it will increase at 1 degree per 0.5 second.

10. Adjust button ▼ :

Set indoor temperature down. If press and hold on, it will decrease at 1degree per 0.5 second.

11. Swing button:

Push this button for the first time when operation,it will start the swing function. Push the button for the second time, cancel the swing function. (The function is available matched with the concerned unit)

12. Economical button:

Push the button to set the economical operation mode for air conditioner, push again then cancel the mode. The operation mode is suitable for sleeping time.

13. Cool only/cooling and heating selection button (hidden):

Use a small stick with a diameter of 1mm to push the button to switch modes.For COOLING ONLY type, it will be no heating mode when pressing MODE. The uniform mode is COOLING and HEATING at the factory.

14. Lock button (hidden):

Use a small stick with the diameter of 1mm to push the LOCK button to lock the current setting, push the button again then cancel the setting.

Installation

Wiring Principle Sketch:

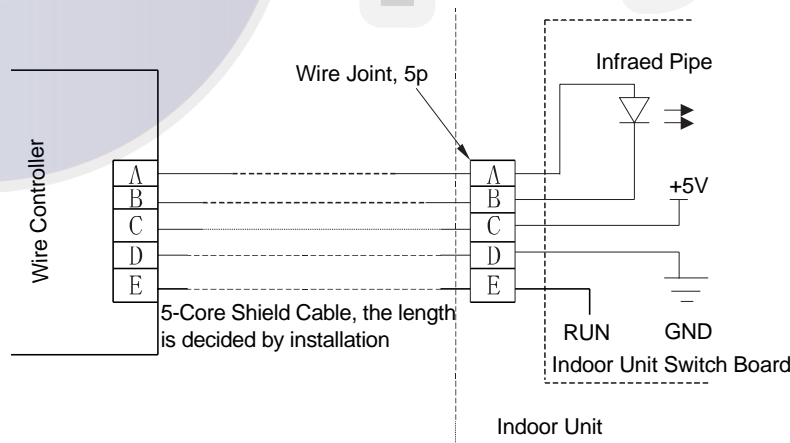

Installation description:

When the air conditioner needs the constant frequency wire Controller, be sure adding a Wire Joint with 5 terminal named A, B, C, D, E in indoor unit, and fixing a infraed emitter whose anode and cathode connecting with A and B near the receiver in the Indoor Unit Switch Board, then connecting the terminal +5V, GND, Run in the Switch Board to C, D, E respectively.

NOTE

Never turn screws too tightly, or else the cover would be dented or the Liquid Crystal breaks. Please leave enough long cable for maintenance of the Wire Controller Board.

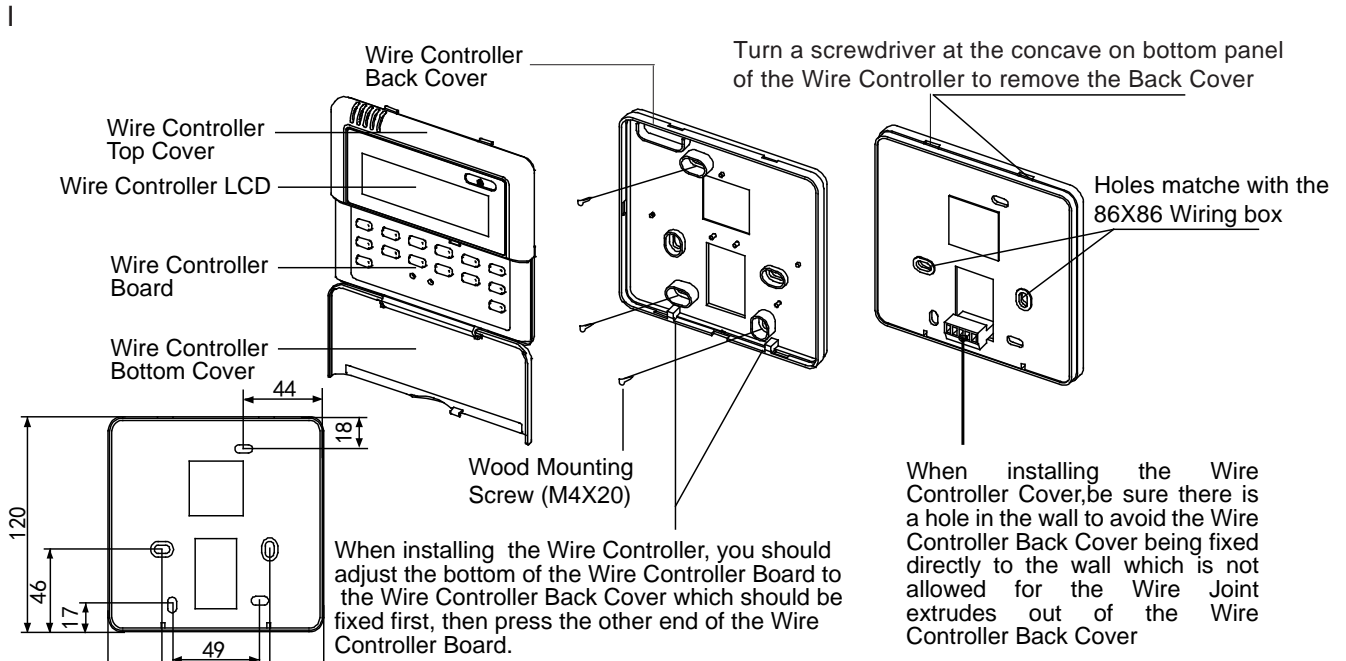

13.2.2 Wired Controller: KJR-12B



Name and function of LCD display on the wired controller

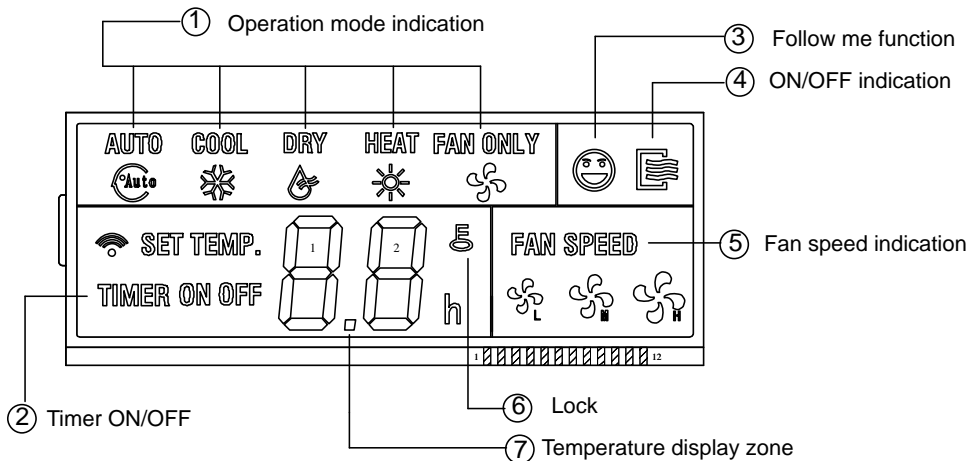

1、 Operation mode indication:

When press "MODE" button, the following mode can be selected in circle. Auto→Cool →Dry→Heat→ Fan only→Auto. For cooling only model, heat mode is skipped.

2、 Timer :

When adjust setting on time or only on time is set, the "ON" is lighted.

When adjust setting off time or only off time is set, the "OFF" is lighted. If on and off timer are both set, the"ON" and "OFF"are both lighted.

3、 Follow me function:

There is a temperature sensor inside the wire controller, after setting temperature, it will compare the two temperatures, and the space of wire controller will be the same as setting temperature. It is available under cooling, heating, auto mode.

4、 ON/OFF indication :

When it is on, the icon display, otherwise it is extinguished.

5、 Fan speed indication :

There are four fan modes: low, middle, high, and auto. For some models, no middle fan then the middle fan is seen as high speed.

6、 Lock:

When the "LOCK "button is pressed, the icon appear and other buttons is unable, press again, the icon disappear.

7、 Temperature display zone:

Generally it displays setting temperature, it can be adjusted by press temperature button ▲ and ▼. But no display in fan mode.

Name and functions of buttons on the wired controller

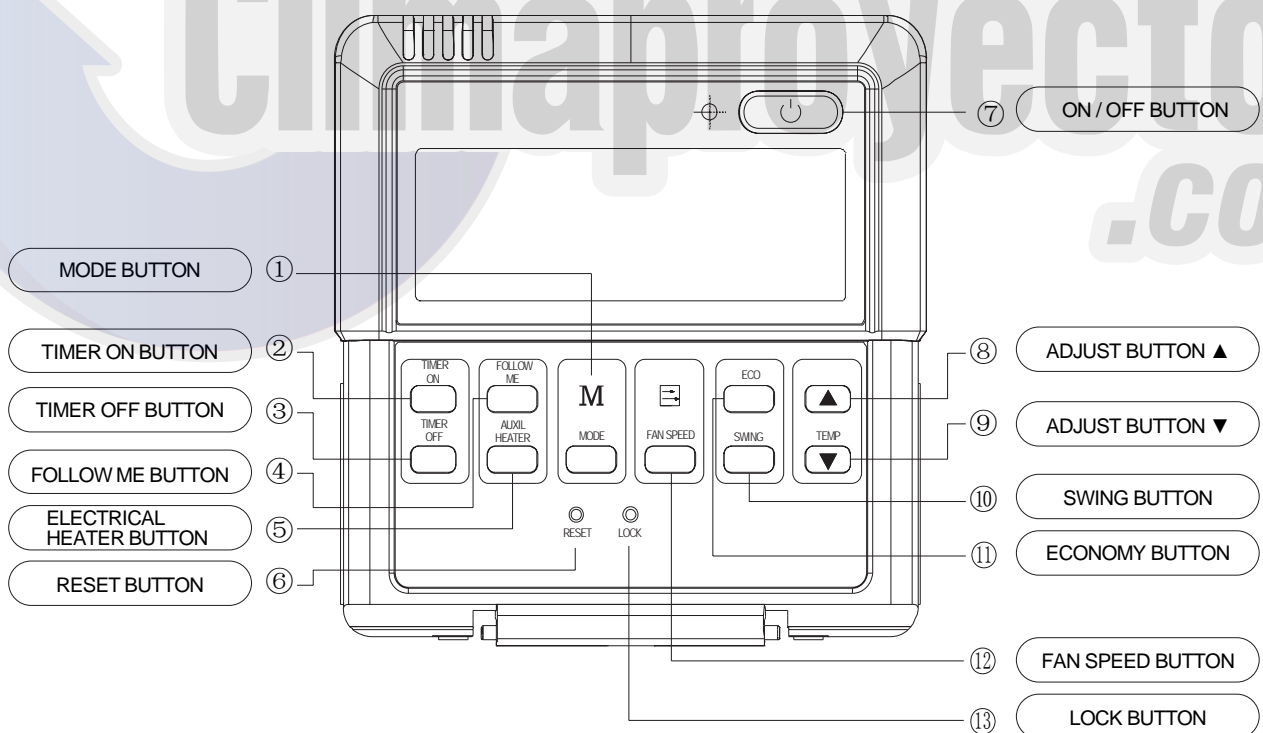

1、 Mode botton:

When press this botton, the operation mode change as the following sequence:

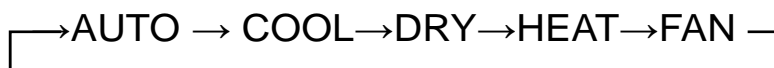

Remark: For the cooling only model, the heating mode is skipped.

2、 Timer on button :

Press this button, timer on function is active. Then every press, the time increase 0.5h, after 10h, 1h increasement after each press. If cancel this Function, just set it to "0.0".

3、 Timer off button:

Press this button, timer off function is active. Then every press, the time increase 0.5h, after 10h, 1h increasement after each press. If cancel this function, just set it to "0.0".

4、 Follow me button:

When under cool, heat and auto mode, and press this button, follow me function is active. Press again, this function is ineffective.

5、 Electrical heater button :

If press this button in heat mode, electrical heater function become ineffective.

6、 Reset button(hidden):

Use a 1mm stick to press in the little hole, then the current setting is canceled. The wire controller enters into original state.

7、 ON/OFF button:

When in off state, press this button, the indicator is on, the wire controller enter into on state, and send setting information to in door Pcb. When in on state, press this button, the indicator is off, and send instruction. If timer on or timer off has been set, it cancel this setting then send instruction to stop the machine.

8、 Adjust button ▲:

Set indoor temperature up. If press and hold on, it will increase at 1°C (2°F) per 0.5 second.

9、 Adjust button ▼ :

Set indoor temperature down. If press and hold on, it will decrease at 1°C (2°F) per 0.5 second.

10、 Swing button:

First press "start swing function"; second press "stop swing". (Match to some model with swing function).

11、 Economy operation button:

Press this button, the indoor unit operates in economy mode, press again, exit this mode (it may be ineffective for some models)

12、 Fan speed button:

Press this button consecutively; the fan speed will circle as follow:

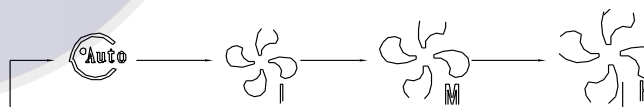

13、 Lock button(hidden):

When you push the LOCK button, all current settings are locked in and the wire controller does not accept any operation except that of the LOCK button. Use the lock mode when you want to prevent setting from being changed accidentally or play fully. Push the LOCK button again when you want to cancel the LOCK mode.

Installation

Wiring Principle Sketch:

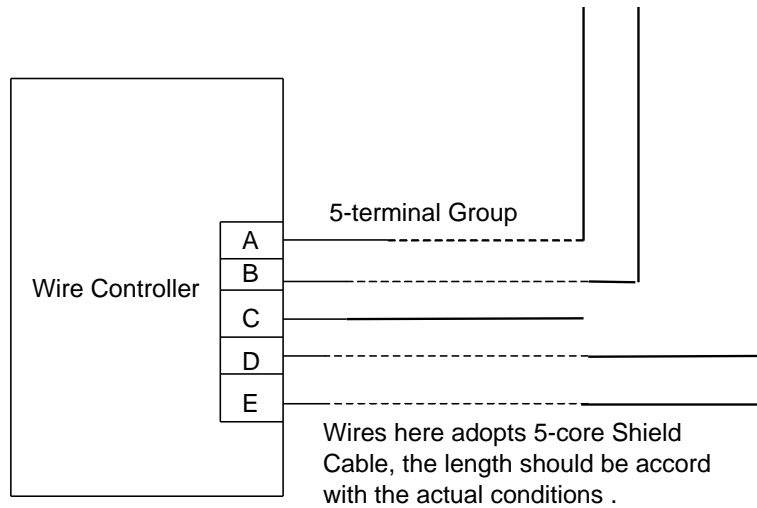

Installation description:

When it is necessary to use this controller, it needs to add a small 5-terminal group and fasten a infrared emmitter near to the receiver in the switch board. Connecting the anode and cathode to A、 B of the Terminal Group, also connect +5V、 GND、 RUN of the switch board separately to the C、 D、 E of the 5-terminal Group.

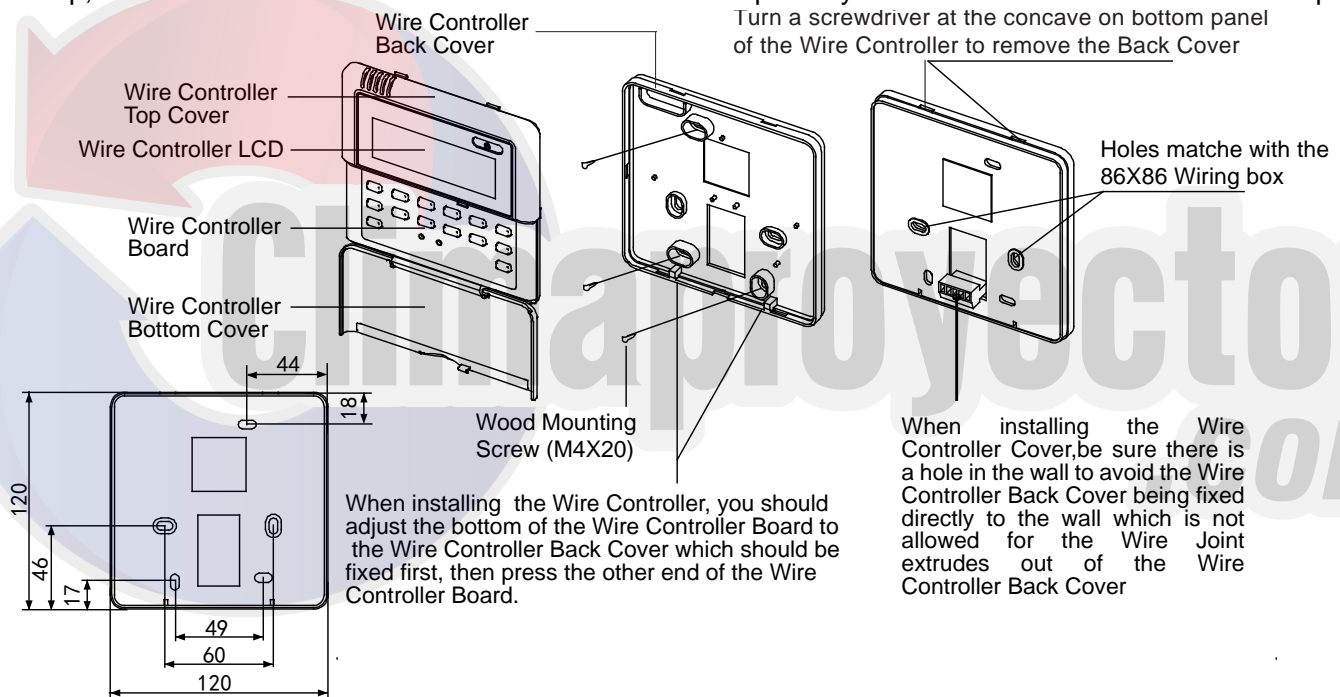

Caution:

The connecting wire should be a little longer as to take away the switch board easily for maintenance
 The connecting wire should be a little longer as to take away the controller easily for maintenance..

13.2.3 Central Controller: MD-CCM03

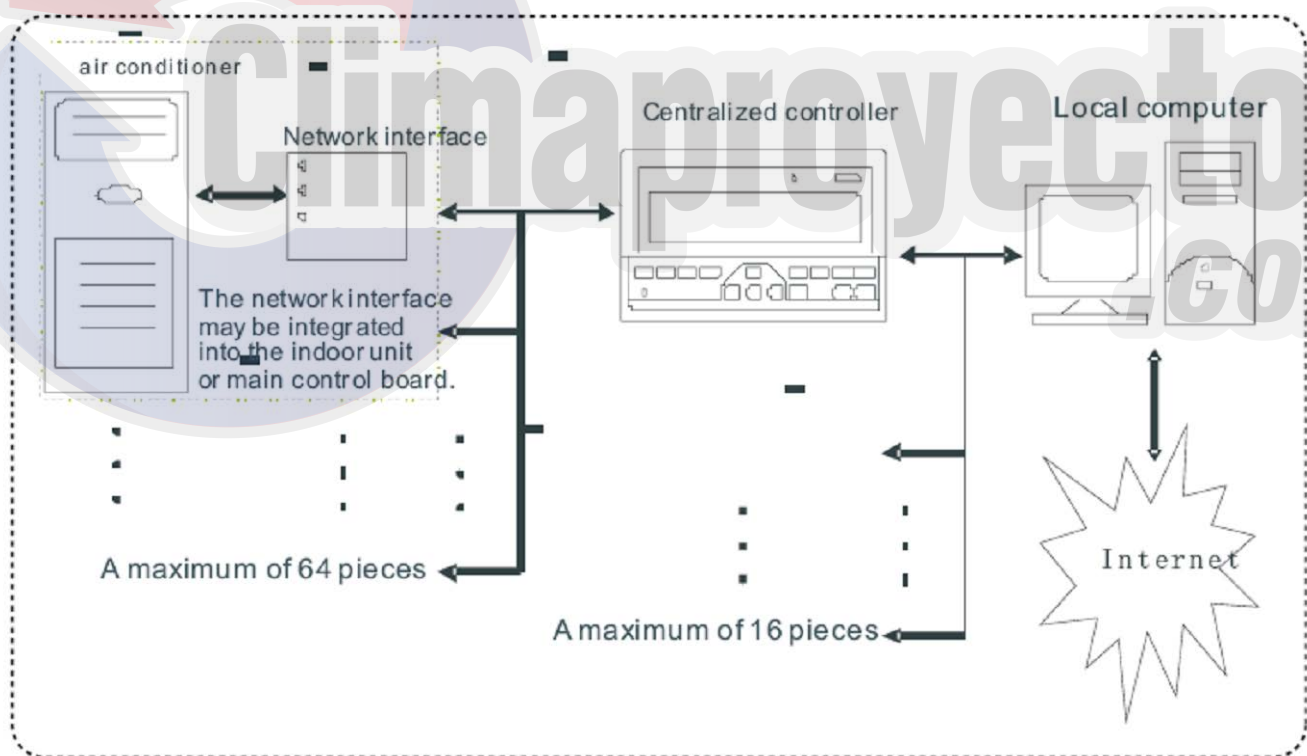

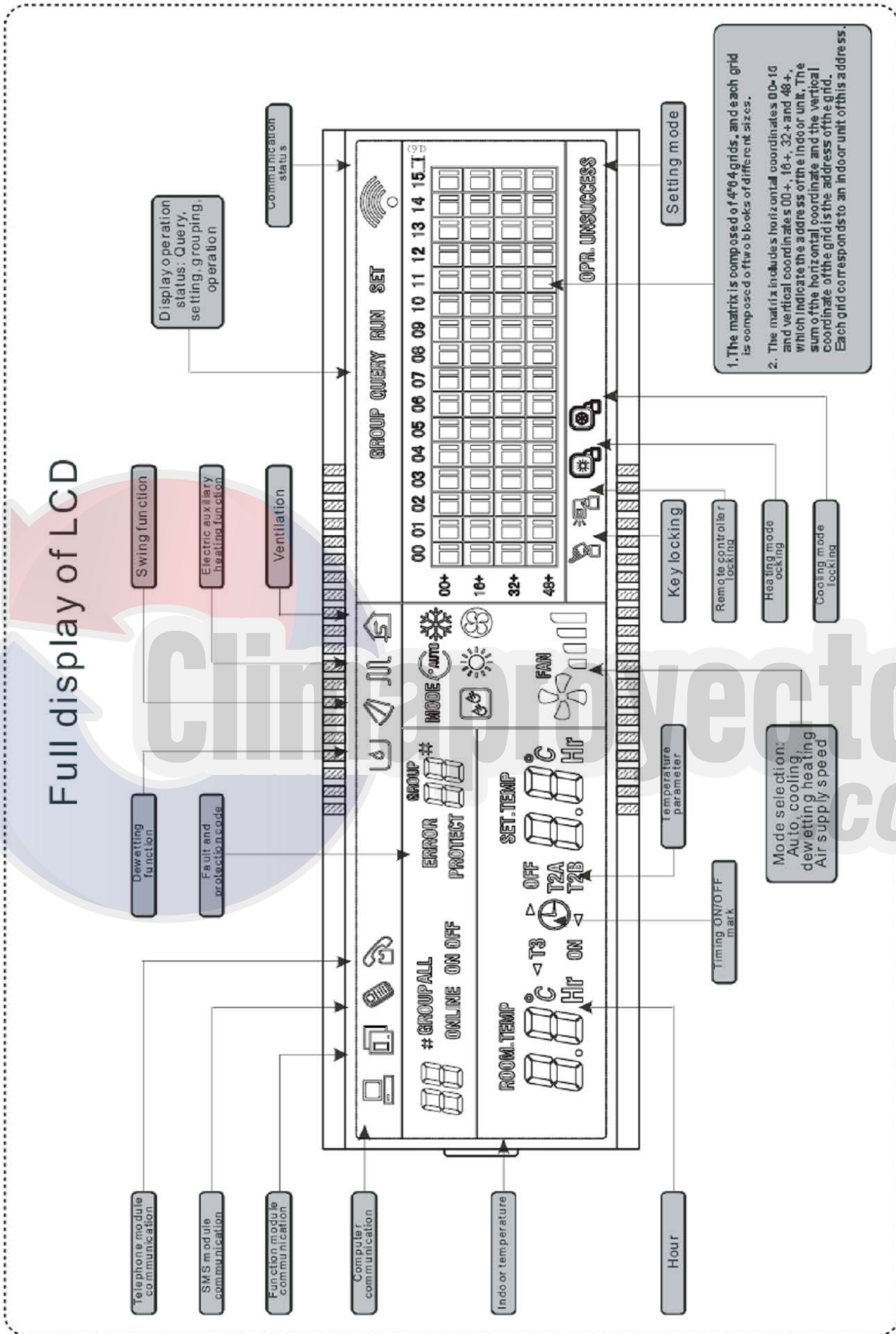

Liquid crystal matrix display description:

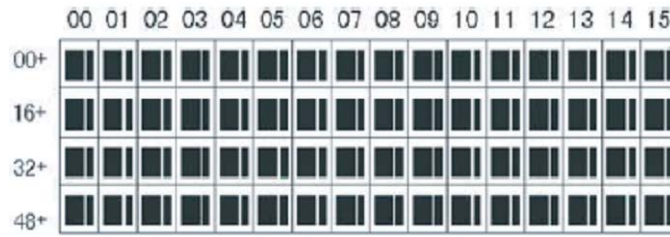

1. The liquid crystal matrix is composed of 4*64 grids, and each grid is composed of two blocks of different sizes (as shown in the above figure).
2. The matrix includes horizontal coordinates 00-15 on the upper side and vertical coordinates 00+, 16+, 32+ and 48+ on the left

Side, which indicate the address of the indoor unit. The sum of the horizontal coordinate and the vertical coordinate of the grid is the address of the grid. Each grid corresponds to an indoor unit of this address.

3. One grid is composed of two blocks of different sizes. The status

Indication table is as follows:

Status \ Object	Constantly on	Slow blink		Fast blink
Big black block	In-service	Selected		Out of service
Small black block	Power on		Fault of indoor unit	Power off

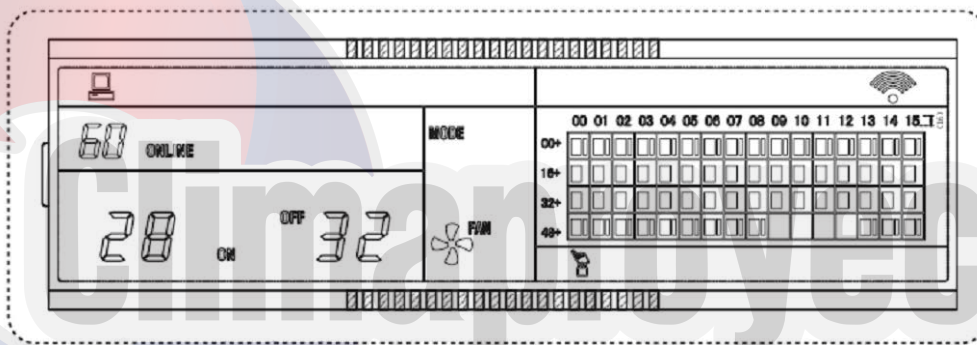

LCD display description

1. Description of the standby page
 - 1) The LCD displays the standby page, 60 air conditioners are in service, of which 28 are powered on and 32 off.
 - 2) In the matrix, the big dots of (00, 16+) and (15,32+) are luminous, and the small dots are not luminous. It indicates the 32 air conditioners with the addresses from 16 to 47 are powered off.
 - 3) In the matrix, the big and small dots of (09, 48+) and (12, 48+) are not luminous. It indicates the four air conditioners with the addresses from 57 to 60 are outside the network.
 - 4) All other big and small dots in the matrix are luminous. It indicates all other air conditioners are in the network and powered on.
 - 5) The address of the air conditioner is sum of the coordinates. For example, the address of (09, 48+) is 09+48=57.
 - 6) The centralized controller keypad is locked, and the centralized controller communicates with the computer normally.

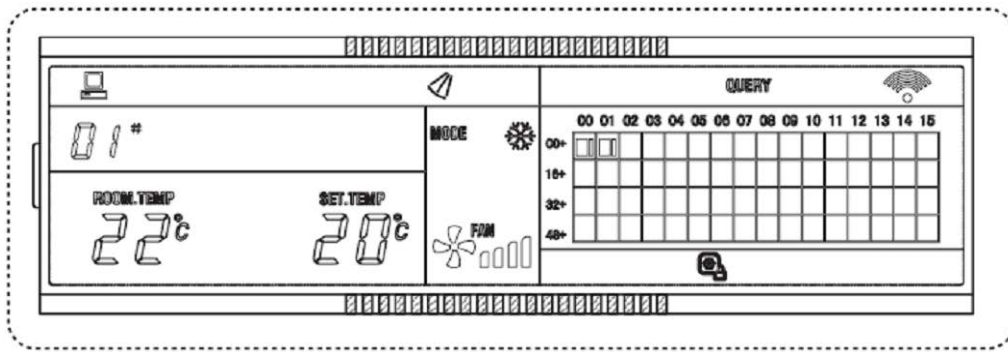

Query page description

- 1) The LCD displays the query page, and the air conditioner with the address of 08 is being queried. Mode of the air conditioner with the address 01 is: Cooling, strong air, swing on, indoor temperature 22°C, set temperature 20°C, cooling mode “lock”.
- 2) In the matrix, only the big and small black dots at (00, 00+) and (01, 00+) are luminous. It indicates the in-service and power-on status of the air conditioners with the addresses of 00 and 01.
- 3) The centralized controller communicates with the computer normally.

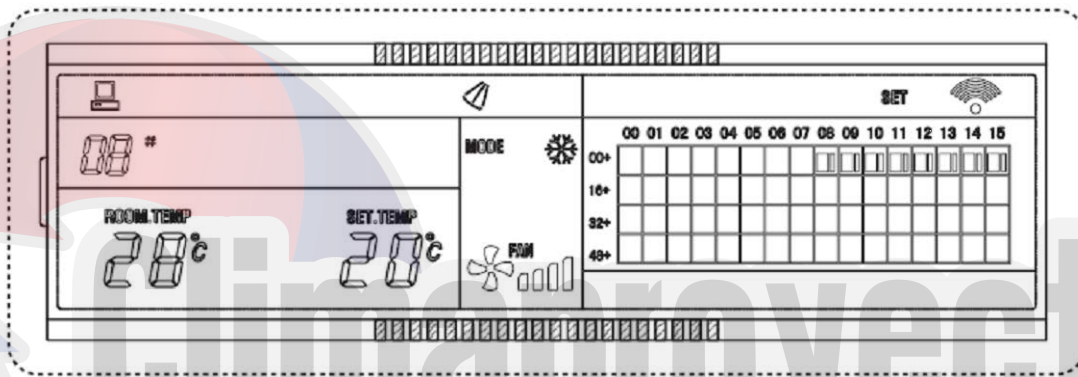

Setting page description

- 1) The LCD displays the setting page, and queries the air conditioner with the address of 08. The mode of the air conditioner with the address 08 is: Cooling, strong air, swing on, indoor temperature 28°C, set temperature 22°C, cooling.
- 2) In the matrix, only the big black dots from (08, 00+) to (16, 00+) are luminous. It indicates the air conditioners with the addresses from 08 to 16 are in service.
- 3) The centralized controller communicates with the computer normally.

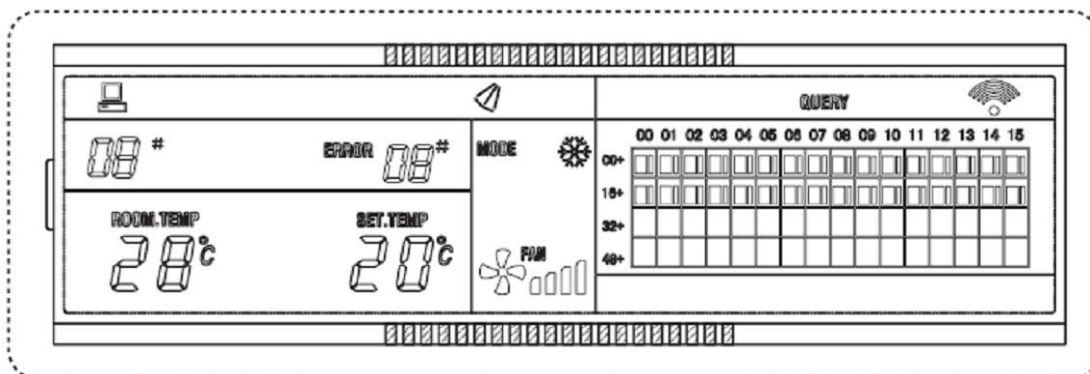

Fault page display description

- 1) Query the air conditioner with the address of 08 in the query page. The air conditioner with the address of 08 is faulty, and the fault code is 08. The big black dot below (08, 0+) blinks.
- 2) In the matrix, only the big and small black dots from (00, 00+) to (16, 15+) illuminate. It indicates the in-service status of the air conditioners with the addresses of 00 and 01.
- 3) The centralized controller communicates with the computer normally.



Climaproyectos .com

Av. Central No. 285, Parque Logístico,
Deleg. La Pila, San Luis Potosí, C.P. 78422
More Info (444) 161.50.43
info@clima-flex.com
service@clima-flex.com
ventas@clima-flex.com
US Toll Free **01 800 201 48 16**
Lada sin costo **01 800 890 59 17**

 /ComfortFlexMexico

 /ComfortFlexMx

 /Comfort-Flex

 /ClimaFlex