



DDW Compact Air Handling Unit

Horizontal unit

Model: DDW020C ~ DDW450C

Airflow rate: 2000m³/h ~ 45000m³/h

Vertical unit

Model: DDW040C ~ DDW450C

Airflow rate: 4000m³/h ~ 45000m³/h



Overview

New DDW Series of Compact Air Handling Unit of Daikin are developed with more advanced technology and production technique on the basis of advantages of previous generation of air handling units. Featuring compact in structure and flexible for assembly, the units can be widely used in commercial and industrial central air conditioning system. Through such processing as air cooling, dewetting and drying, heating and humidifying, and double filtration, the series of units can provide comfortable and clean air-conditioning environment for shopping malls, office buildings, stations, hospitals, and electronics factories. The executive standard for the product is GB/T14294-2008 "Combined air conditioning unit".



Commercial office building

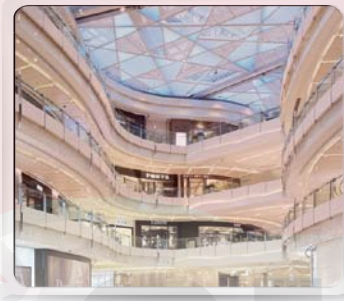

Shopping mall



Hospital

Contents

- Overview.....2
- Unit features4
- Control of unit7
- Parameters of unit8
- Figure of outline dimension 10
- Lookup table for motor power - maximum external total pressure 18
- Notes 19

DDW Compact Air Handling Unit

DDW compact air handling units are available for customers with various combinations of horizontal or vertical units. The airflow rate for horizontal and vertical units are in the range of 2,000 ~ 45,000m³/h which can meet the requirements of a variety of residual pressure. The air discharge modes include top air discharge and horizontal air discharge which can make full use of the room space.



Product nomenclature

Name Code	D	D	W	4	5	0	C	E	A	E	L	A	A	□	0	A	F	E
	1	2	3	4	5	6	7	8	9	10	11	12	13	14	15	16	17	18
Code	● Meaning of																	

Digits 1,2,3	● Model code: DDW Compact Air Handling Unit	film humidifier H - Galvanized steel plate + hydrophilic aluminum + 50 mm wet film humidifier J - Galvanized steel plate + normal aluminum + 100 mm wet film humidifier K - Galvanized steel plate + hydrophilic aluminum + 100 mm wet film humidifier L - Stainless steel plate + normal aluminum + 100 mm wet film humidifier M - Stainless steel plate + hydrophilic aluminum + 100 mm wet film humidifier																																				
Digits 4,5,6	● Airflow rate code: The airflow rate code 450 refers to 45,000m ³ /h (airflow rate = airflow rate code *100m ³ /h)																																					
Digit 7	● Design serial No.: C series																																					
Digit 8	● Structure style + usage feature: A: 25mm panel horizontal fresh air; B: 25mm panel horizontal return air; C: 25mm panel vertical fresh air; D: 25mm panel vertical return air; E: 50mm panel horizontal fresh air; F: 50mm panel horizontal return air;																																					
Digit 9	● Cooling coil: A—2C C—4C E—6C B—3C D—5C ● Cooling coil with heating coil: F—2C1H H—4C1H K—6C1H M—3C2H P—5C2H G—3C1H J—5C1H L—2C2H N—4C2H Q—6C2H Notes: Number -- coil rows, C -- cooling coil, H -- heating coil; e.g. 4C1H -- 4 rows of cooling coil + 1 row of heating coil																																					
Digit 10	● ETP code: Unit: Pa <table border="1"> <tr> <td>B</td><td>C</td><td>D</td><td>E</td><td>F</td><td>G</td><td>H</td><td>J</td><td>K</td> </tr> <tr> <td>100</td><td>125</td><td>150</td><td>175</td><td>200</td><td>225</td><td>250</td><td>275</td><td>300</td> </tr> <tr> <td>L</td><td>M</td><td>N</td><td>P</td><td>Q</td><td>R</td><td>S</td><td>T</td><td></td> </tr> <tr> <td>350</td><td>400</td><td>450</td><td>500</td><td>550</td><td>600</td><td>650</td><td>700</td><td></td> </tr> </table> Where: Standard ETP for unit model DDW020~070 are 150, 225, 300 Pa Standard ETP for unit model DDW080~150 are 225, 300, 400 Pa Standard ETP for unit model DDW180~250 are 300, 400, 500 Pa Standard ETP for unit model DDW270~450 are 400, 500 Pa	B	C	D	E	F	G	H	J	K	100	125	150	175	200	225	250	275	300	L	M	N	P	Q	R	S	T		350	400	450	500	550	600	650	700		
B	C	D	E	F	G	H	J	K																														
100	125	150	175	200	225	250	275	300																														
L	M	N	P	Q	R	S	T																															
350	400	450	500	550	600	650	700																															
Digit 11	● Pipe connection: L---Connected from left; R---Connected from right																																					
Digit 12	● Material of drain pan + Material of aluminum foil + Wet film options: A - Galvanized steel plate + normal aluminum B - Galvanized steel plate + hydrophilic aluminum C - Stainless steel plate + normal aluminum D - Stainless steel plate + hydrophilic aluminum E - Galvanized steel plate + normal aluminum + 50mm wet film humidifier F - Galvanized steel plate + hydrophilic aluminum + 50mm wet film humidifier G - Stainless steel plate + normal aluminum + 50 mm wet																																					
Digit 13	● Filter type (nylon mesh, G3/G4 plate filter, F5/F6/F7 bag filter): A—nylon mesh C—G4 E—G3+F6 G—G4+F5 J—G4+F7 K—G4+electronic purifying filter L—none B—G3 D—G3+F5 F—G3+F7 H—G4+F6																																					
Digit 14	● Fan motor options: - Constant frequency motor V— Inverter motor																																					
Digit 15	0- No control 1. Local starting cabinet 2. Remote starting cabinet 3. Local control cabinet 4. Remote starting cabinet 5. Inverter starting cabinet 6. Inverter control cabinet																																					
Digit 16	● Type of mixing section + supply fan section: A- No mixing section + flange horizontal air discharge B- No mixing section + flange top air discharge C- Mixing section (top + front flange) + flange horizontal air discharge D- Mixing section (top + front flange) + flange top air discharge E- Mixing section (top + front damper) + flange horizontal air discharge F- Mixing section (top + front damper) + flange top air discharge																																					
Digit 17	● Power options: F—380V/3N~/50Hz																																					
Digit 18	● Export sales code: E— Export sale, Default— Domestic																																					

▶ Judging for left/ right hand orientation: Facing to the airflow direction, if the pipe is connected from the left, the unit is the left hand orientation; otherwise, the unit is right orientation.

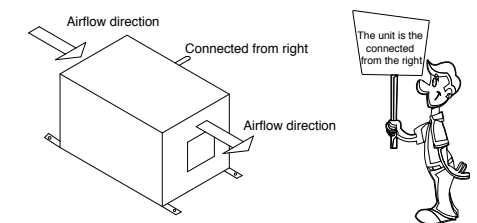

Diagram for left/ right hand orientation judging

Unit features

Superior performance of cabinet

► The latest patent structural design (patent No.: 201320410231)

- The cabinet is made of panels through aluminum alloy profile embedded mortise and tenon joint, fixed with high strength bolts from outside for the convenience of assembly and disassembly. The unit features stable performance in all kinds of extreme environment.

► Excellent thermal insulation

- The panel adopts double-layer metal wall structure; the outer layer adopts attractive and durable anti-rust, anti-corrosion color coated sheet; the inner layer adopts aluminum-coated zinc plate; the middle layer is filled in high density environment-friendly polyurethane foaming material which is with good insulation properties, sound absorption and noise reduction functions.

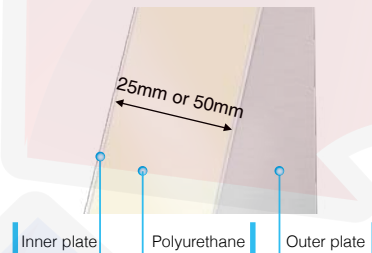

► Superior performance of anti-cold bridge

- Special panel structure design of no metal pieces connecting directly inside or outside of unit ensures absolutely no cold bridge.
- Insulation material is pasted between panel and external components such as damper and flange, the unit won't dew in high humidity environment.

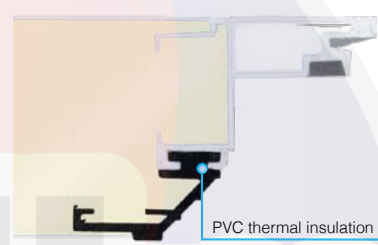

► Good leakproofness

- The design of double-line convex angle anti-leakage is adopted between panels for solid and permanent airtightness;
- The crush- and wear-resistant sealing rings are filled for the joints between cabinet and exposed parts for stable mechanical fixation to reduce the unit leakage effectively;
- Some access doors are equipped with locks and adopted special sealing design of integral anti-aging sealing ring.

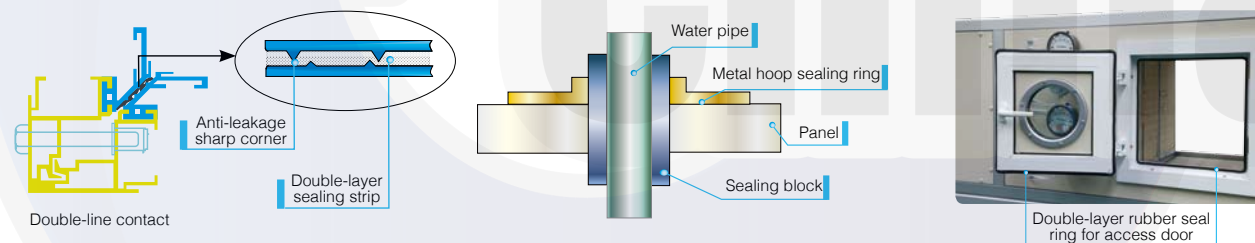

Variety combination type available for various air handling requirements

► General comfortable places

- The air handling unit with prefilter section, cooling coil section and supply fan section can meet general comfortable places such as the office buildings and shopping malls. For places with higher temperature and humidity requirements of indoor environment, the heating coil or wet film humidifier can be equipped additionally. In order to better meet the requirements of installation space for the indoor unit, the units are available in vertical and horizontal options.

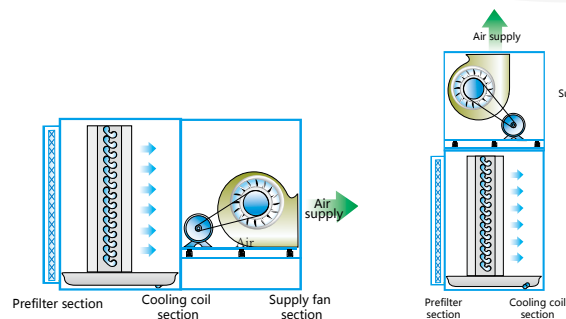

► Purified comfortable places

- The air handling unit with prefilter, mid-filter, cooling coil, heating coil, wet film and supply fan section can implement double air purifying treatment for higher cleanliness, to meet higher requirement of air cleanliness for the places such as high-end commercial office building, hospital, and scientific research institutions.

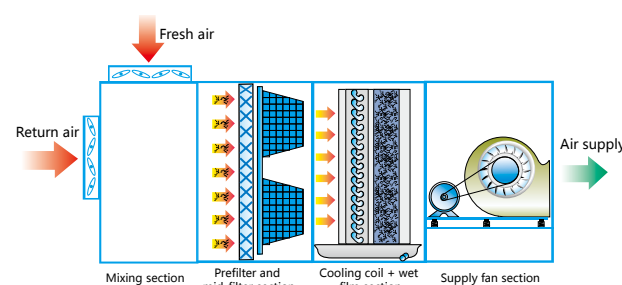

A variety of ETP and optional components

- A variety of standard ETP options and a variety of optional components are available, for example, prefilter and mid-filter, the cooling and heating coil, the wet film humidifier, the pointer differential pressure gauge, damper, the inspection light, etc. All are for your convenient, fast, and flexible selection.

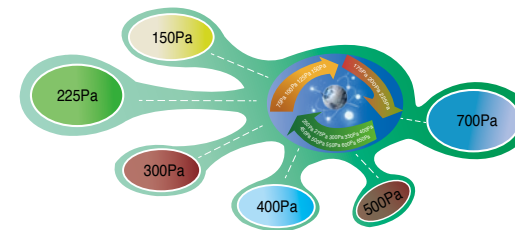

Professional software for DDW unit selection

- The professional software for air handling unit selection
- Various available configurations for unit selection according to customer requirements
- Automatic output of unit performance parameters, CAD outline drawings and quotations



Function sections combination of different AHU

Function section	Configuration of general standard unit			Configuration of multifunctional unit						
	Prefilter section	Cooling coil section	Supply fan section	Mixing section	Prefilter	Mid-filter section	Cooling coil section	Heating coil section	Wetfilm humidifying section (direct drainage)	Supply fan section
Parts	Nylon filter	4 or 6 rows	Supply fan	Flange, damper	G3-G4	F5,F6,F7	2, 3, 4, 5, 6 rows	1 or 2 rows	50,100mm	Supply fan

Notes: The heating coil section and wet film humidifying section are alternative; The ETP, overall dimensions, and weight of unit are variable according to selection of different function sections. For details, please refer to the selection software.

Introduction to function section

► Mixing section

- The regulated return air is fully mixed with fresh air in a certain percentage to avoid airflow stratification and ensure heat exchange and anti-condensation performance for the whole unit.
- The direction and size of air outlet can be designed according to customer requirements. Its standard configuration is flange, and its options includes the manual/electric damper and the damper actuator.
- The access door is provided for the mixing section.



Damper

► Filtering section

- This section aims to air purification, and the gaps between filters are filled with special sealing material to reduce air leakage rate effectively.
- The filter features standard configuration of nylon mesh, prefilter, mid-filter and electronic purifying filter are available for selection
- The electronic purifying filter features two-stage filtration. Its first stage is a pre-filter, and the second stage is a two-section high pressure electronic dust chamber which makes the air dust and pollutants positively charged and adsorbed onto the integrated cathode plate for dust removing and sterilizing effect.

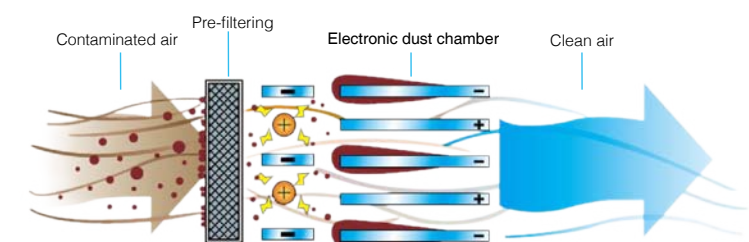

Working principle of electronic purifying filter

► Cooling coil section

- This section aims to the air cooling and dehumidifying. The cooling coil is made up of high quality red copper tubes and efficient aluminum fin through mechanical expansion, and finished with pressure test upon requirements of national standard before Ex-factory to ensure no leakage.
- A water baffle can be used for the cooling coil to further prevent "spray water" phenomenon from the cooling coil.

Cooling coil

- High quality red copper tube cross is in cross reverse-flow layout to enhance the air turbulence and improve heat exchange effect.

Aluminum foil

- The corrugated aluminum fin increases the area of heat exchange, optimizes the effect of heat exchange, and is helpful to the flowing of condensed water flow, preventing the formation of water droplets on the fin surface.
- 9~14 fins per inch are optional.

Header of cooling coil

- Seamless steel pipe is used as Header of cooling coil.
- The header is configured with drainage valve and aire vent, and sealing ring is equiped for thermal insulation to eliminate cold bridge and reduce air leakage. Maintenance is convenient.

Drain pan

- High quality coated, galvanized steel plate
- Thermal insulation cotton pasted on the outside of drain pan to prevent the second condensation
- V double-tilt design to ensure smooth drainage
- Drainage pipe diameter is designed precisely by condensate water volume
- Option: Stainless steel drain pan

► Supply fan section

- The supply fan section aims to provide power for the airflow circulation of entire system. It comprises the fan, motor, belt transmission mechanism, base, and shock absorber.
- The fan is certified by the Air Movement and Control Association (AMCA), and selected by professional software to ensure each unit operating in safe and efficient condition.
- The totally enclosed squirrel cage 3-phase asynchronous motor with protection level IP55 and insulation level F is adopted for the section, which can be used in harsh application environment.
- Optional components: inspection light, transformer, start-up cabinet.

Fan motor assembly

- The fan motor is installed on the common base, and the vibration absorber is installed between the base and the unit to isolate vibration effectively.

Impeller

- The impeller is with high stability and low noise through strictly dynamic and static balance correction.

Motor

- Single speed or variable frequency motors are available.

Bearing detail

- The world renowned brand of bearings are adopted in high assembly accuracy to ensure the unit in long period of continuous operation.

Belt pulley detail

- World famous brand of narrow V-belt is used.
- The belt pulley is in conical sleeve structure for the convenience of rapid assembly and maintenance.

Motor connection detail

- Flexible connection is used for the outlet of supply fan for effective isolation of vibration.
- Motor maintenance is convenient, and slider is adopted for adjusting motor to the optimal location.

► Humidifying section

- This section aims to humidifying process to ensure relative humidity for the air.
- The wet film humidifier is available with 50mm or 100mm thickness. Humidifying distance is only the thickness of wet film which makes the good humidifying effect. The wet film humidifier is suitable for civil building dimidification, industrial cooling and other places which have common requirement of humidity.

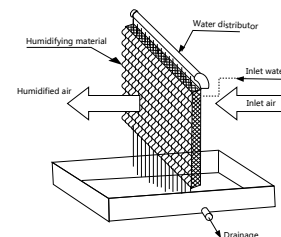

► Control of unit

DDW series of units are provided with a variety of control programs for the users who can choose the appropriate program according to their own needs. Not only the common direct-starting cabinet or the star delta starting cabinet, the inverter starting cabinet can be selected as well to reduce the impact to the grid during the start. In addition, we also provide multiple control functions such as local control, remote control, temperature/humidity control, and mixing air control on the basis of general starting cabinet.

► Four-pipe proportional-integral control of unit

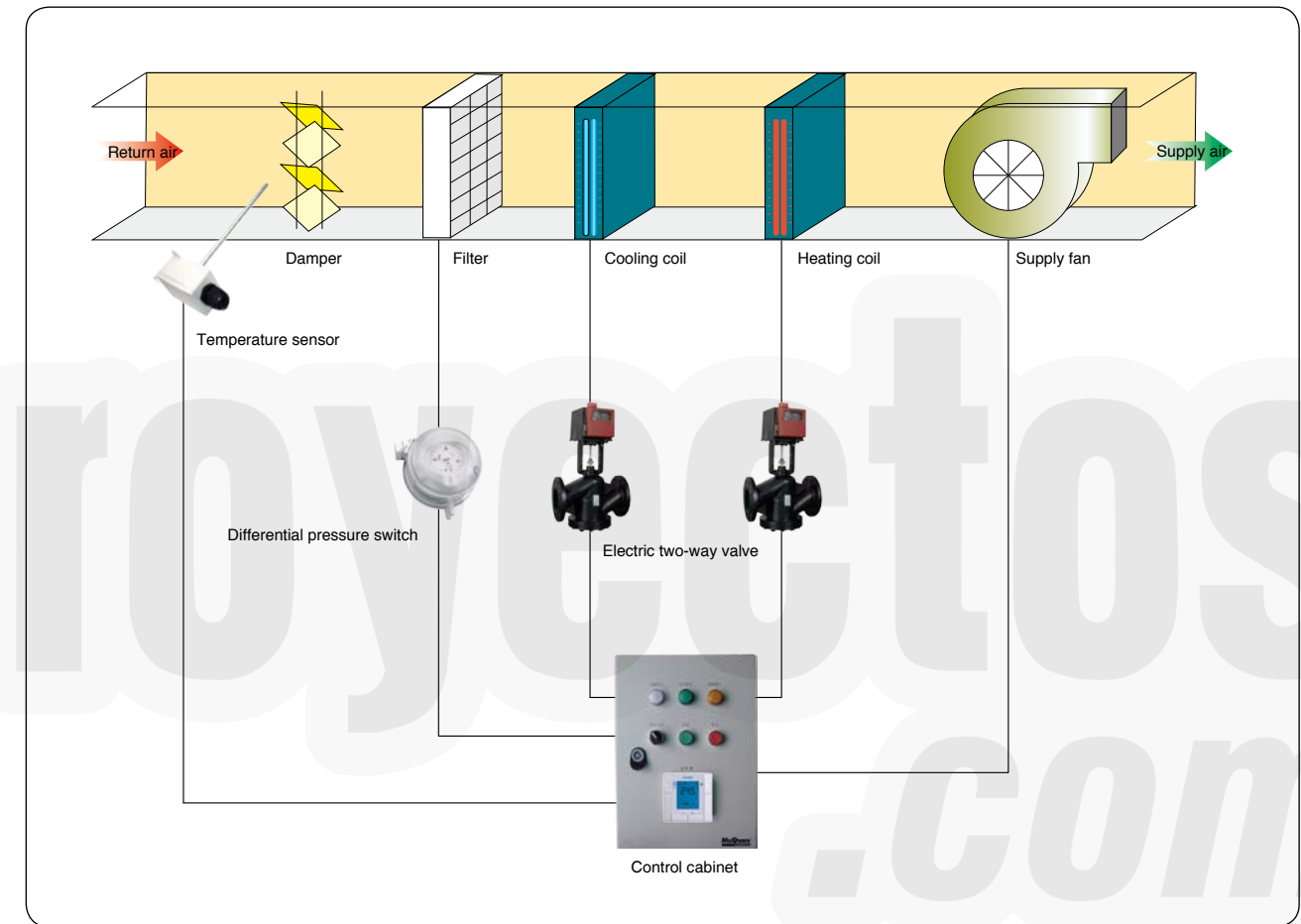

► Working principle

- The temperature control system for air supply comprises the temperature sensor, proportional-integral temperature controller, and electric two-way valve. The temperature sensor installed in the duct of return air sends the detected temperature signals to the proportional-integral temperature controller which compares the detected temperature values against the setting values continuously, meanwhile outputs signals to control the opening of electric two-way valve for continuous adjustment, and finally make ambient temperature values detected by temperature sensor maintained within the range of temperature setting.
- The differential pressure switch detects the difference of pressures at both ends of filter, and then compares it against the setting value. If it exceeds this value, the alarm will occur.

► Function

- Controllable starting and stopping of motor
- Controllable opening of electric two-way valve to make the detecting temperature maintained within the temperature setting range



Parameter table of DDW horizontal AHU

Unit model		DDW 020C	DDW 030C	DDW 040C	DDW 050C	DDW 060C	DDW 070C	DDW 080C	DDW 100C	DDW 120C	DDW 150C	DDW 180C	DDW 200C	DDW 220C	DDW 250C	DDW 270C	DDW 300C	DDW 330C	DDW 360C	DDW 400C	DDW 450C	
Nominal airflow rate (m³/h)		2000	3000	4000	5000	6000	7000	8000	10000	12000	15000	18000	20000	22000	25000	27000	30000	33000	36000	40000	45000	
ETP(Pa)	I	150	150	150	150	150	150	225	225	225	225	300	300	300	300	400	400	400	400	400	400	
	II	225	225	225	225	225	225	300	300	300	300	400	400	400	400	500	500	500	500	500	500	
	III	300	300	300	300	300	300	400	400	400	400	500	500	500	500	-	-	-	-	-	-	
Cooling coil	Nominal cooling capacity (kW)	4-row (return air condition)	11.6	18.1	23.4	29.2	34.8	44.0	49.0	60.7	71.8	92.9	106.6	121.5	137.1	155.2	165.1	189.7	207.8	226.8	237.7	265.5
		4-row (fresh air condition)	28.0	40.4	52.3	70.8	85.4	90.0	106.0	136.6	164.0	208.3	245.0	269.6	299.7	341.8	361.5	419.8	460.5	488.8	519.2	576.2
		6-row (return air condition)	15.6	21.7	30.0	39.8	45.1	53.4	60.6	78.0	93.6	115.7	140.5	159.6	177.4	203.8	207.5	236.4	259.8	280.1	296.3	329.5
		6-row (fresh air condition)	34.5	53.6	65.6	87.8	104.6	120.9	136.5	169.9	201.6	257.6	309.2	345.3	383.8	438.5	463.3	520.6	566.3	607.6	631.4	702.5
	Nominal heating capacity (kW)	4-row (return air condition)	21.7	33.9	42.6	56.6	66.0	80.2	94.2	123.3	147.9	188.8	221.9	246.6	274.1	308.1	332.8	377.9	411.2	443.8	498.4	554.7
		4-row (fresh air condition)	26.1	39.2	50.1	68.8	80.6	91.8	106.1	145.2	174.2	222.6	267.0	296.6	329.7	368.8	383.6	435.5	473.9	517.1	580.7	646.4
		6-row (return air condition)	25.0	38.5	48.9	66.5	76.4	90.4	106.2	145.2	173.4	218.7	262.4	291.6	322.1	362.8	386.5	437.4	476.8	517.9	580.5	650.2
		6-row (fresh air condition)	29.8	46.3	56.7	77.8	92.2	113.7	131.1	168.7	202.4	257.5	309.1	343.4	379.6	429.3	463.7	522.2	569.3	618.2	693.2	772.8
	Nominal cooling water flow (l/s)	4-row (return air condition)	0.55	0.86	1.11	1.39	1.66	2.09	2.33	2.89	3.42	4.42	5.07	5.78	6.53	7.39	7.86	9.03	9.90	10.80	11.32	12.64
		4-row (fresh air condition)	1.33	1.92	2.49	3.37	4.06	4.29	5.05	6.51	7.81	9.92	11.67	12.84	14.27	16.28	17.21	19.99	21.93	23.28	24.72	27.44
		6-row (return air condition)	0.74	1.03	1.43	1.89	2.15	2.54	2.89	3.71	4.46	5.51	6.69	7.60	8.45	9.70	9.88	11.26	12.37	13.34	14.11	15.89
		6-row (fresh air condition)	1.64	2.55	3.12	4.18	4.98	5.76	6.50	8.09	9.60	12.27	14.72	16.44	18.28	20.88	22.06	24.79	26.97	28.93	30.07	33.45
Nominal heating water flow (l/s)	4-row (return air condition)	0.52	0.81	1.01	1.35	1.57	1.91	2.24	2.94	3.52	4.50	5.28	5.87	6.53	7.34	7.92	9.00	9.79	10.57	11.87	13.21	
	4-row (fresh air condition)	0.62	0.93	1.19	1.64	1.92	2.19	2.53	3.46	4.15	5.30	6.36	7.06	7.85	8.78	9.13	10.37	11.28	12.31	13.83	15.39	
	6-row (return air condition)	0.60	0.92	1.16	1.58	1.82	2.15	2.53	3.46	4.13	5.21	6.25	6.94	7.67	8.64	9.20	10.41	11.35	12.33	13.82	15.48	
	6-row (fresh air condition)	0.71	1.10	1.35	1.85	2.20	2.71	3.12	4.02	4.82	6.13	7.36	8.18	9.04	10.22	11.04	12.43	13.55	14.72	16.50	18.40	
Nominal cooling water WPD (kPa)	4-row (return air condition)	18.9	42.5	39.7	13.4	12.7	19.3	29.0	42.7	36.3	50.2	21.7	28.6	32.7	30.9	35.6	46.9	50.1	54.3	61.5	66.3	
	4-row (fresh air condition)	44.4	35.4	29.9	58.1	63.4	15.6	22.8	57.9	52.4	61.8	67.4	71.7	75.3	70.2	37.7	48.9	55.6	60.9	75.6	87.7	
	6-row (return air condition)	49.9	14.0	30.8	52.6	27.8	39.7	54.8	59.2	62.0	35.9	49.1	64.6	71.8	70.6	29.0	37.6	40.8	43.8	51.6	56.9	
	6-row (fresh air condition)	30.2	67.0	24.6	34.3	50.2	61.4	82.8	39.0	37.1	52.1	68.2	72.5	76.2	79.4	81.7	90.5	92.3	94.3	103.5	109.3	
Type		Copper pipe embedded with new corrugated aluminum fin																				
FPI		12																				
Working pressure (MPa)		1.6																				
Water pipe diameter		R1-1/2	R1-1/2	R2	R2	R2	R2 (R2-1/2)	R2 (R2-1/2)	R2-1/2	R2-1/2	R2-1/2 (R3)	R3	R3	R3	R3	R3	R3	R3	R3	R3	R3	
Drainage pipe diameter		R1-1/4																				
Fan	Model/ Material	Efficient centrifugal fore rake multi-blade fan/galvanized steel plate																				
	Drive mode	V-belt drive																				
	Air discharge direction	Horizontal air discharge or Top air discharge																				
Motor	Power supply	380V/3N-50Hz																				
	Type	3-phase asynchronous motor with insulation level F and protection level IP55																				
	Power (kW)	0.55	0.55 (0.75)	0.75	1.1	1.1 (1.5)	1.5	2.2	2.2	3	4	5.5	5.5	5.5	7.5	7.5	11	11	15	15	15	15 (18.5)
		0.55	0.75	0.75 (1.1)	1.1 (1.5)	1.5	1.5	2.2	3	3	4	5.5	7.5	7.5	7.5 (11)	11	15	15	15	15	15	18.5
0.55		0.75	1.1	1.5	1.5	1.5 (2.2)	3	3	4	5.5	7.5	7.5 (11)	11	-	-	-	-	-	-	-	-	
Filter	Type	Nylon filter																				
	Thickness (mm)	8										21										
Cabinet	Type	Double layer panel with thickness of 25mm/50mm, outer plate as color plate and inner plate as aluminum zinc plate, filled with thermal insulation polyurethane high-pressure foaming material.																				
	Length (mm)	955	955	955	1075	1075	1125	1125	1255	1275	1145	1275	1275	1275	1275	1315	1555	1555	1625	1625	1625	
Dimension of 25mm panel cabinet(mm)*	Width (mm)	900	1050	1080	1250	1320	1500	1680	1690	1920	2100	2280	2400	2400	2470	2760	2760	2760	2920	2920	2920	
	Height (mm)	520	520	680	680	730	750	750	880	990	1120	1180	1180	1250	1370	1370	1440	1500	1560	1690	1820	
	Length (mm)	1005	1005	1025	1125	1125	1185	1185	1315	1315	1195	1315	1315	1315	1315	1365	1605	1605	1675	1675	1675	
Dimension of 50mm panel cabinet(mm)*	Width (mm)	950	1100	1130	1300	1370	1550	1730	1740	1970	2150	2330	2450	2450	2520	2810	2810	2810	2970	2970	2970	
	Height (mm)	570	570	730	730	780	800	800	930	1040	1170	1230	1230	1300	1420	1420	1490	1550	1610	1740	1870	
	Unit weight of 25mm panel(kg)	4-row	126	137	156	181	194	232	251	304	339	414	497	515	560	626	628	707	789	804	897	959
Unit weight of 50mm panel(kg)	6-row	130	142	163	189	203	244	266	320	358	443	529	550	645	666	670	757	841	859	959	1026	
	4-row	146	158	179	206	220	261	282	343	379	450	544	565	618	686	688	773	860	876	974	1039	
Unit weight of 50mm panel(kg)	6-row	150	163	186	214	229	273	297	359	398	479	576	600	703	726	730	823	912	931	1036	1106	

Notes: ■ The parameters for standard units are listed above. For special requirements, we will provide special design.
 ■ Nominal return air cooling condition: 27°C (dry bulb)/19.5°C (wet bulb); Nominal fresh air cooling condition: 35°C (dry bulb)/28°C (wet bulb); Nominal cooling entering and leaving water temperature: EWT 7°C, LWT 12°C;
 ■ Nominal return air heating condition: 15°C (dry bulb); Nominal fresh air heating condition: 7°C (dry bulb); Nominal heating entering and leaving water temperature: EWT 60°C, LWT 50°C;
 ■ The unit weight in the table is the net weight of unit, while the weight in operation will increase by about 20%.
 ■ The values in the brackets () in the table are the water pipe diameters and motor powers of unit with 6-row cooling coil.
 ■ The unit coil loops for full fresh air and full return air may be different. Note to specify the code of air inlet condition when placing an order. The code for unit with full return air is "B, F", and the code for unit with full fresh air is "A, E". For special requirements, customer can select the unit through selection software.
 ■ The cabinet size does not include the protruding parts (collecting pipe, air outlet, and suspender).

General nomenclature for standard units

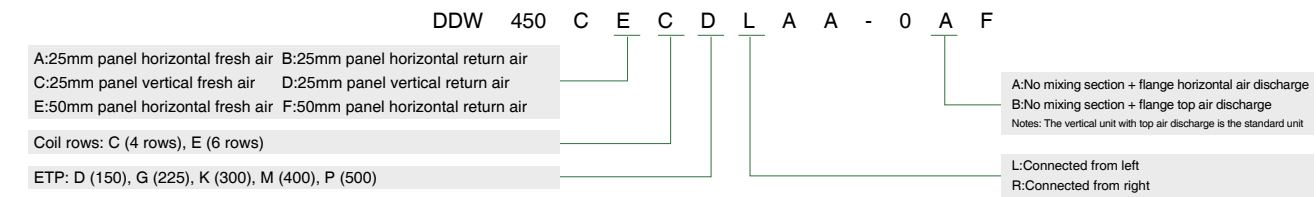

Parameter table of DDW vertical AHU

Unit model		DDW 040C	DDW 050C	DDW 060C	DDW 070C	DDW 080C	DDW 100C	DDW 120C	DDW 150C	DDW 180C	DDW 200C	DDW 220C	DDW 250C	DDW 270C	DDW 300C	DDW 330C	DDW 360C	DDW 400C	DDW 450C	
Nominal airflow rate (m³/h)		4000	5000	6000	7000	8000	10000	12000	15000	18000	20000	22000	25000	27000	30000	33000	36000	40000	45000	
ETP(Pa)	I	150	150	150	150	225	225	225	225	300	300	300	300	400	400	400	400	400	400	400
	II	225	225	225	225	300	300	300	300	400	400	400	400	500	500	500	500	500	500	500
	III	300	300	300	300	400	400	400	400	500	500	500	500	-	-	-	-	-	-	-
Cooling coil	Nominal cooling capacity (kW)	4-row (return air condition)	23.4	29.2	34.8	44.0	49.0	60.7	71.8	92.9	106.6	121.5	137.1	155.2	165.1	189.7	207.8	226.8	237.7	265.5
		4-row (fresh air condition)	52.3	70.8	85.4	90.0	106.0	136.6	164.0	208.3	245.0	269.6	299.7	341.8	361.5	419.8	460.5	488.8	519.2	576.2
		6-row (return air condition)	30.0	39.8	45.1	53.4	60.6	78.0	93.6	115.7	140.5	159.6	177.4	203.8	207.5	236.4	259.8	280.1	296.3	329.5
		6-row (fresh air condition)	65.6	87.8	104.6	120.9	136.5	169.9	201.6	257.6	309.2	345.3	383.8	438.5	463.3	520.6	566.3	607.6	631.4	702.5
	Nominal heating capacity (kW)	4-row (return air condition)	42.6	56.6	66.0	80.2	94.2	123.3	147.9	188.8	221.9	246.6	274.1	308.1	332.8	377.9	411.2	443.8	498.4	554.7
		4-row (fresh air condition)	50.1	68.8	80.6	91.8	106.1	145.2	174.2	222.6	267.0	296.6	329.7	368.8	383.6	435.5	473.9	517.1	580.7	646.4
		6-row (return air condition)	48.9	66.5	76.4	90.4	106.2	145.2	173.4	218.7	262.4	291.6	322.1	362.8	386.5	437.4	476.8	517.9	580.5	650.2
		6-row (fresh air condition)	56.7	77.8	92.2	113.7	131.1	168.7	202.4	257.5	309.1	343.4	379.6	429.3	463.7	522.2	569.3	618.2	693.2	772.8
	Nominal cooling water flow (l/s)	4-row (return air condition)	1.11	1.39	1.66	2.09	2.33	2.89	3.42	4.42	5.07	5.78	6.53	7.39	7.86	9.03	9.90	10.80	11.32	12.64
		4-row (fresh air condition)	2.49	3.37	4.06	4.29	5.05	6.51	7.81	9.92	11.67	12.84	14.27	16.28	17.21	19.99	21.93	23.28	24.72	27.44
		6-row (return air condition)	1.43	1.89	2.15	2.54	2.89	3.71	4.46	5.51										

Dimension of DDW horizontal unit (25mm panel)

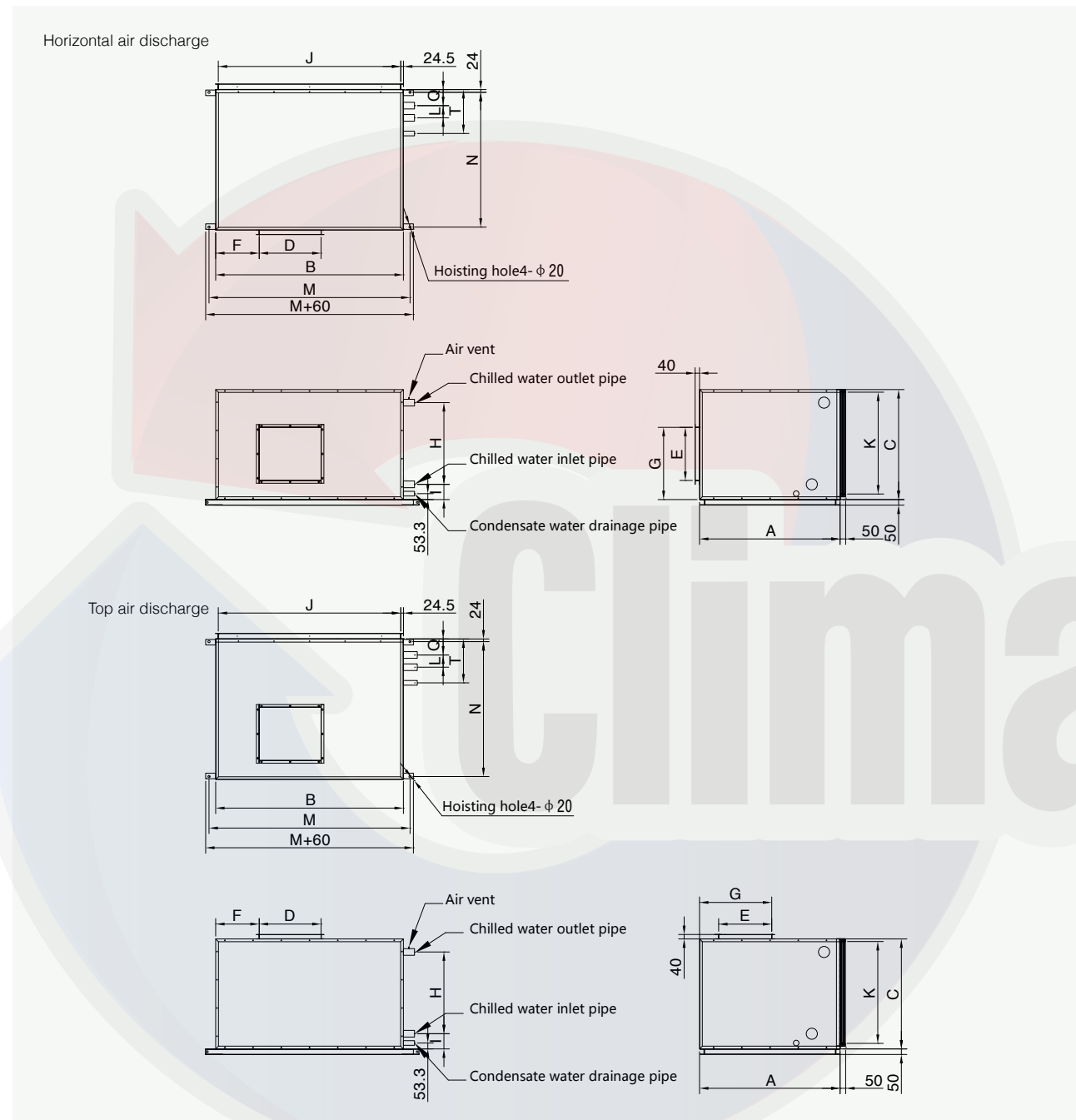

Unit: mm

Unit size	Cabinet size			Supply air outlet size				Pipe size								Return air inlet size			Hoisting hole size		
	A	B	C	D	E	F	G (Horizontal air-out)	G (Top air-out)	H (4R)	H (6R)	I (4R)	I (6R)	Q (4R)	Q (6R)	L (4R)	L (6R)	T	J	K	M	N
DDW020C	955	900	520	232	262	178	362	430	294	294	123	123	135	141	66	110	355	853	445	1020	904
DDW030C	955	1050	520	298	262	218	362	430	294	294	123	123	135	141	66	110	355	1003	445	1170	904
DDW040C	955	1080	680	331	289	209	423	507	434	434	129	129	135	141	66	110	355	1033	605	1200	904
DDW050C	1075	1250	680	309	341	289	441	582	434	434	129	129	135	141	66	110	405	1203	605	1370	1024
DDW060C	1075	1320	730	395	341	288	474	568	485	485	129	129	135	141	66	110	405	1273	655	1440	1024
DDW070C	1125	1500	750	373	404	363	504	678	485	469	129	137	135	141	66	110	405	1453	675	1620	1074
DDW080C	1125	1680	750	373	404	543	504	678	485	469	129	137	135	141	66	110	405	1633	675	1800	1074
DDW100C	1255	1690	880	430	478	442	577	810	609	609	137	137	154	141	110	138	405	1643	805	1810	1204
DDW120C	1275	1690	990	557	478	392	650	803	736	736	137	137	154	141	110	138	405	1643	915	1810	1224

Notes: The cabinet size does not include the protruding parts (header, air outlet, filter, and suspender) as shown in the figure above.

Dimension of DDW horizontal unit (25mm panel)

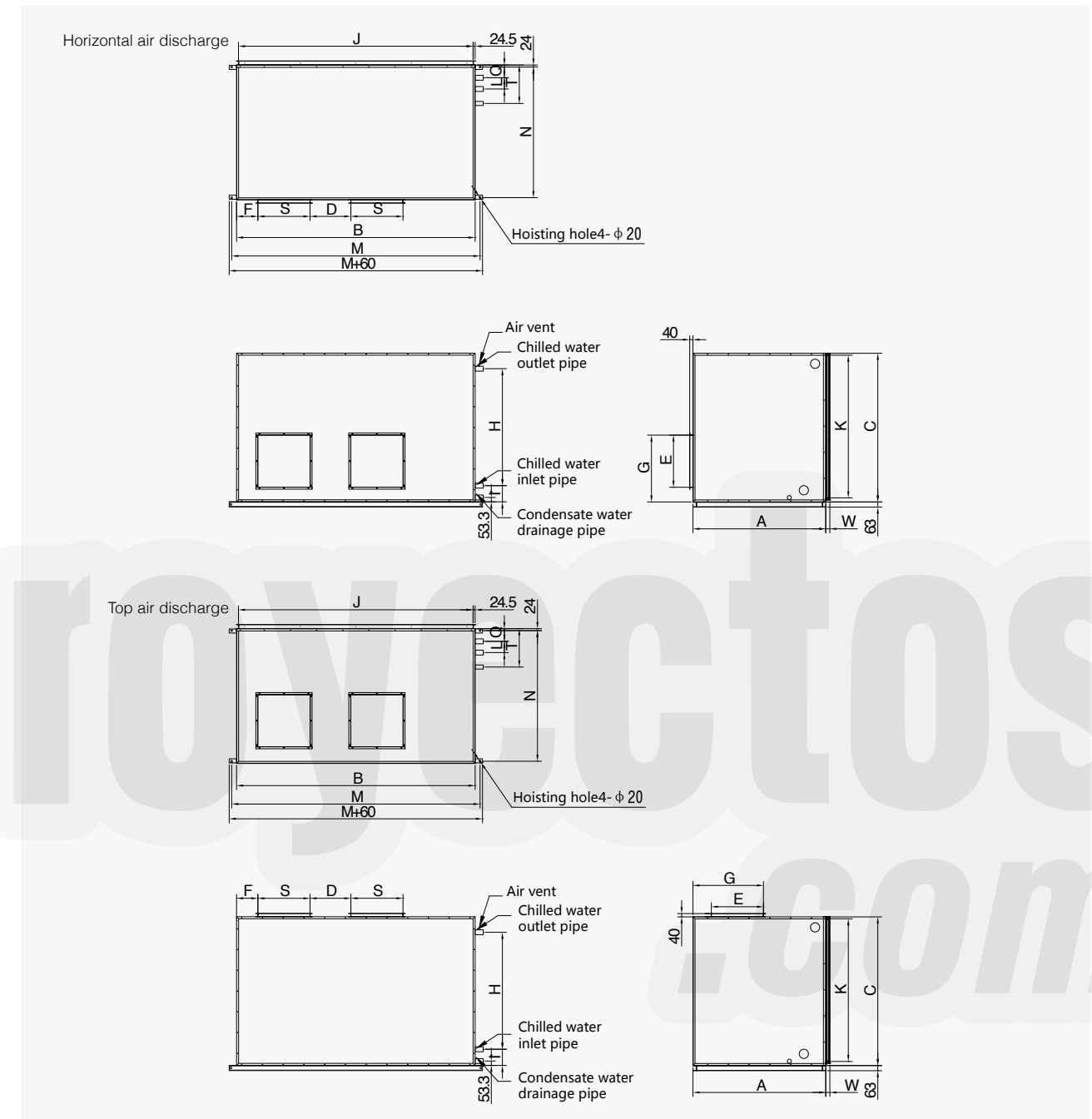

Unit: mm

Unit size	Cabinet size			Supply air outlet size				Pipe size								Return air inlet size			Hoisting hole size				
	A	B	C	D	S	E	F	G (Horizontal air-out)	G (Top air-out)	H (4R)	H (6R)	I (4R)	I (6R)	Q (4R)	Q (6R)	L (4R)	L (6R)	T	J	K	W	M	N
DDW150C	1145	1920	1120	294	373	404	204	572	675	863	850	137	143	154	141	110	138	405	1873	1045	50	2040	1094
DDW180C	1275	2100	1180	343	430	478	172	650	796	913	913	143	143	154	141	110	138	405	2053	1105	50	2220	1224
DDW200C	1275	2280	1180	343	430	478	252	650	806	913	913	143	143	154	141	110	138	405	2233	1105	50	2400	1224
DDW220C	1275	2400	1250	458	557	478	114	650	806	977	977	143	143	154	141	110	138	405	2353	1175	50	2520	1224
DDW250C	1275	2400	1370	458	557	478	114	650	806	1104	1104	143	143	154	141	110	138	405	2353	1295	50	2520	1224

Notes: The cabinet size does not include the protruding parts (header, air outlet, filter, and suspender) as shown in the figure above.

Dimension of DDW horizontal unit (25mm panel)

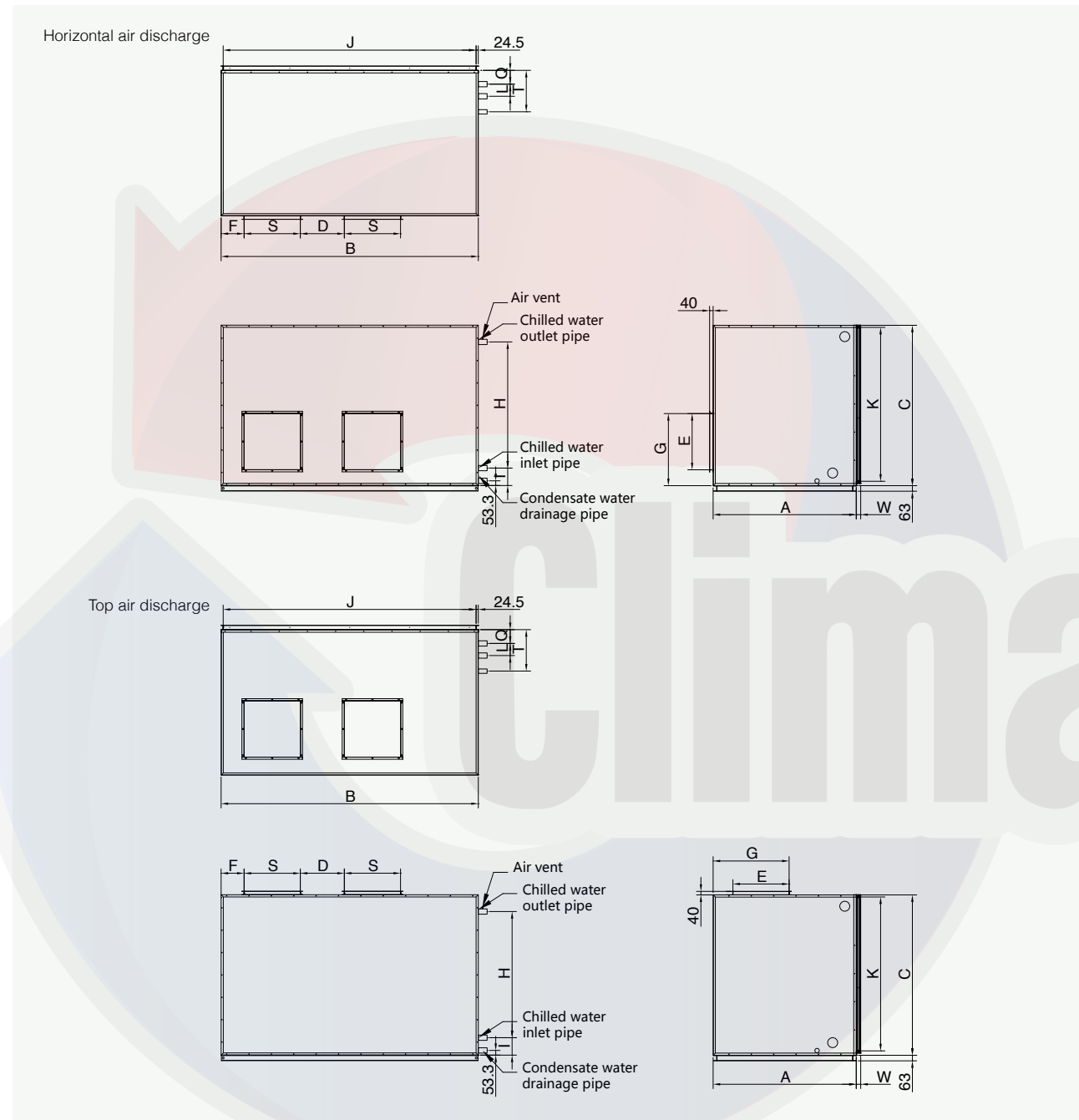

Unit size	Cabinet size			Supply air outlet size				Pipe size								Return air inlet size					
	A	B	C	D	S	E	F	G (Horizontal air-out)	G (Top air-out)	H (4R)	H (6R)	I (4R)	I (6R)	Q (4R)	Q (6R)	L (4R)	L (6R)	T	J	K	W
DDW270C	1275	2470	1370	458	557	478	122	650	806	1104	1104	143	143	154	141	110	138	405	2423	1295	50
DDW300C	1315	2760	1440	458	557	478	267	650	794	1167	1167	143	143	154	141	110	138	455	2713	1365	90
DDW330C	1555	2760	1500	450	569	569	290	749	887	1231	1231	143	143	154	141	110	138	455	2713	1425	90
DDW360C	1555	2760	1560	450	569	569	290	749	887	1294	1294	143	143	154	141	110	138	455	2713	1485	90
DDW400C	1625	2920	1690	500	638	638	261	818	981	1421	1421	143	143	154	141	110	138	455	2873	1615	90
DDW450C	1625	2920	1820	500	638	638	261	818	981	1548	1548	143	143	154	141	110	138	455	2873	1745	90

Notes: The cabinet size does not include the protruding parts (header, air outlet, filter, and suspender) as shown in the figure above.

Dimension of DDW horizontal unit (50mm panel)

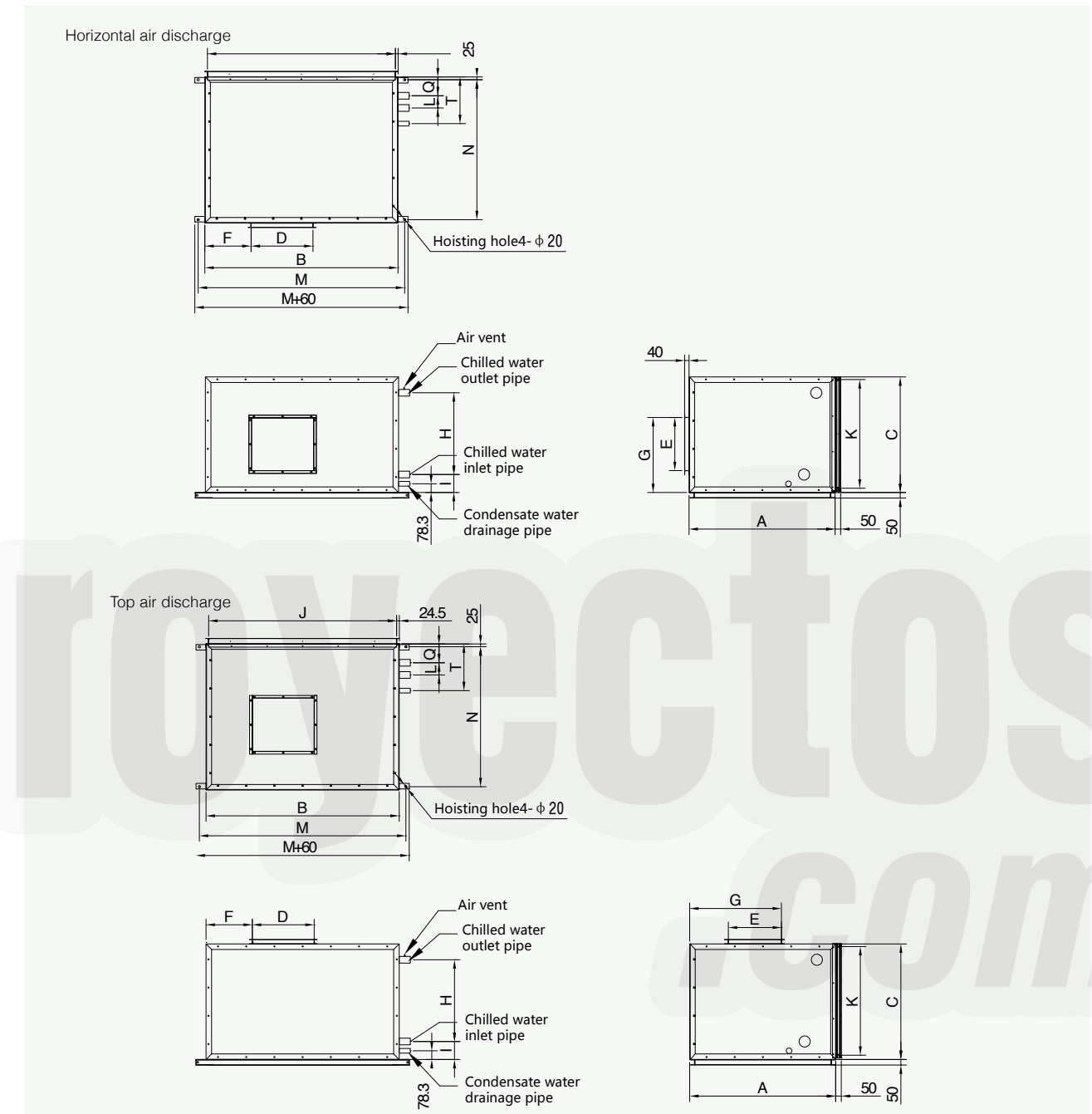

Unit size	Cabinet size			Supply air outlet size				Pipe size								Return air inlet size		Hoisting hole size			
	A	B	C	D	E	F	G (Horizontal air-out)	G (Top air-out)	H (4R)	H (6R)	I (4R)	I (6R)	Q (4R)	Q (6R)	L (4R)	L (6R)	T	J	K	M	N
DDW020C	1005	950	570	232	262	203	387	466	294	294	148	148	155	161	66	110	370	903	508	1070	950
DDW030C	1005	1100	570	298	262	243	388	467	294	294	148	148	155	161	66	110	370	1053	508	1220	950
DDW040C	1025	1130	730	331	289	234	448	538	434	434	154	154	155	161	66	110	370	1083	668	1250	970
DDW050C	1125	1300	730	309	341	314	466	617	434	434	154	154	155	161	66	110	420	1253	668	1420	1070
DDW060C	1125	1370	780	395	341	313	499	611	485	485	154	154	155	161	66	110	420	1323	718	1490	1070
DDW070C	1185	1550	800	373	404	388	529	723	485	469	154	162	155	161	66	110	420	1503	738	1670	1130
DDW080C	1185	1730	800	373	404	568	529	723	485	469	154	162	155	161	66	110	420	1683	738	1850	1130
DDW100C	1315	1740	930	430	478	467	602	855	609	609	162	174	161	110	138	420	1693	868	1860	1260	
DDW120C	1315	1740	1040	557	478	417	675	828	736	736	162	162	174	161	110	138	420	1693	978	1860	1260

Notes: The cabinet size does not include the protruding parts (header, air outlet, filter, and suspender) as shown in the figure above.

Dimension of DDW horizontal unit (50mm panel)

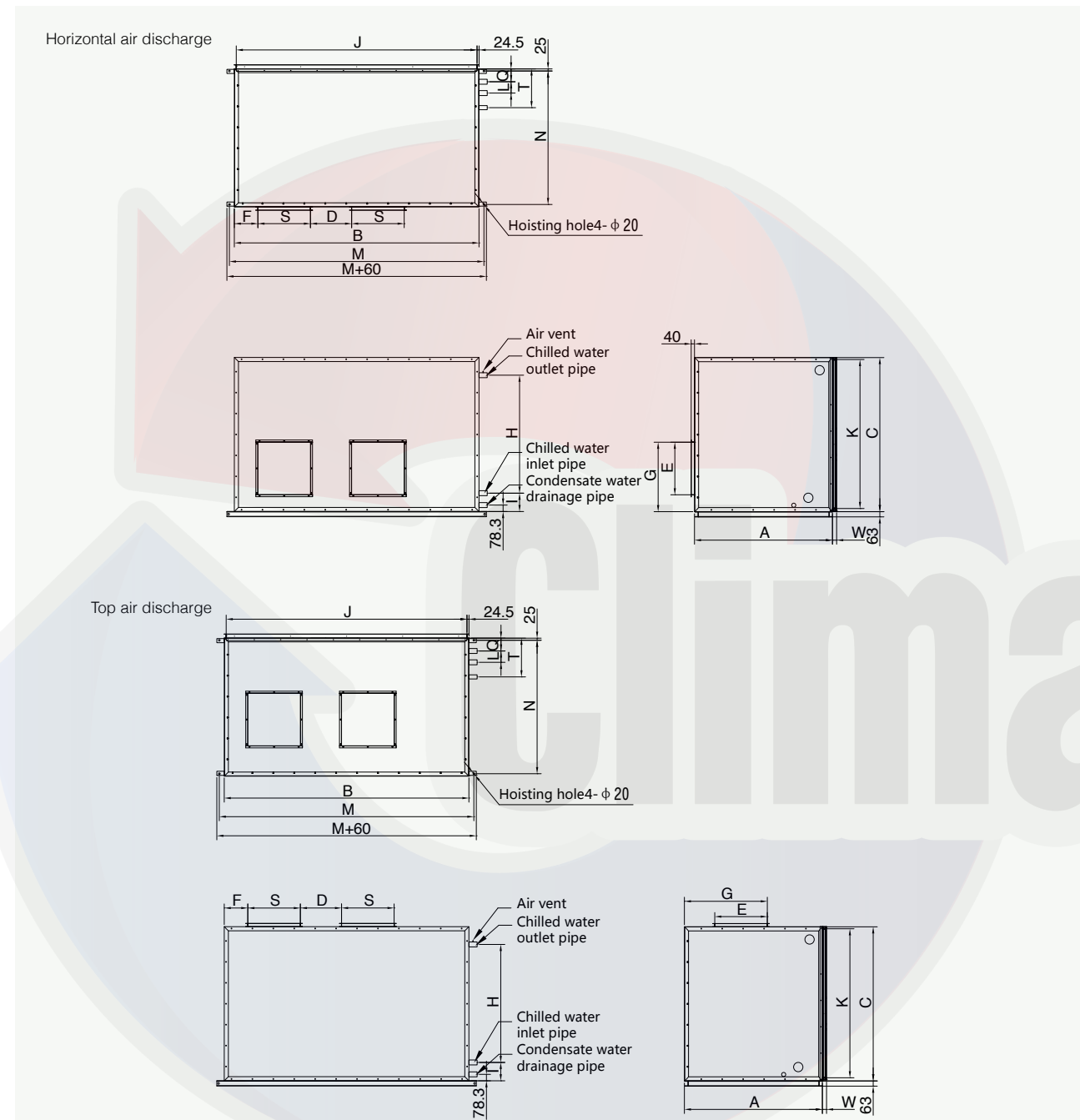

Unit: mm

Unit size	Cabinet size			Supply air discharge size						Pipe size								Return air inlet size			
	A	B	C	D	S	E	F	G (Horizontal air-out)	G (Top air-out)	H (4R)	H (6R)	I (4R)	I (6R)	Q (4R)	Q (6R)	L (4R)	L (6R)	T	J	K	W
DDW150C	1195	1970	1170	294	373	404	229	597	701	863	850	162	168	174	161	110	138	420	1923	1108	50
DDW180C	1315	2150	1230	343	430	478	197	675	826	913	913	168	168	174	161	110	138	420	2103	1168	50
DDW200C	1315	2330	1230	343	430	478	277	675	832	913	913	168	168	174	161	110	138	420	2283	1168	50
DDW220C	1315	2450	1300	458	557	478	139	675	828	977	977	168	168	174	161	110	138	420	2403	1238	50
DDW250C	1315	2450	1420	458	557	478	139	675	830	1104	1104	168	168	174	161	110	138	420	2403	1358	50

Notes: The cabinet size does not include the protruding parts (header, air outlet, filter, and suspender) as shown in the figure above.

Dimension of DDW vertical unit (25mm panel)

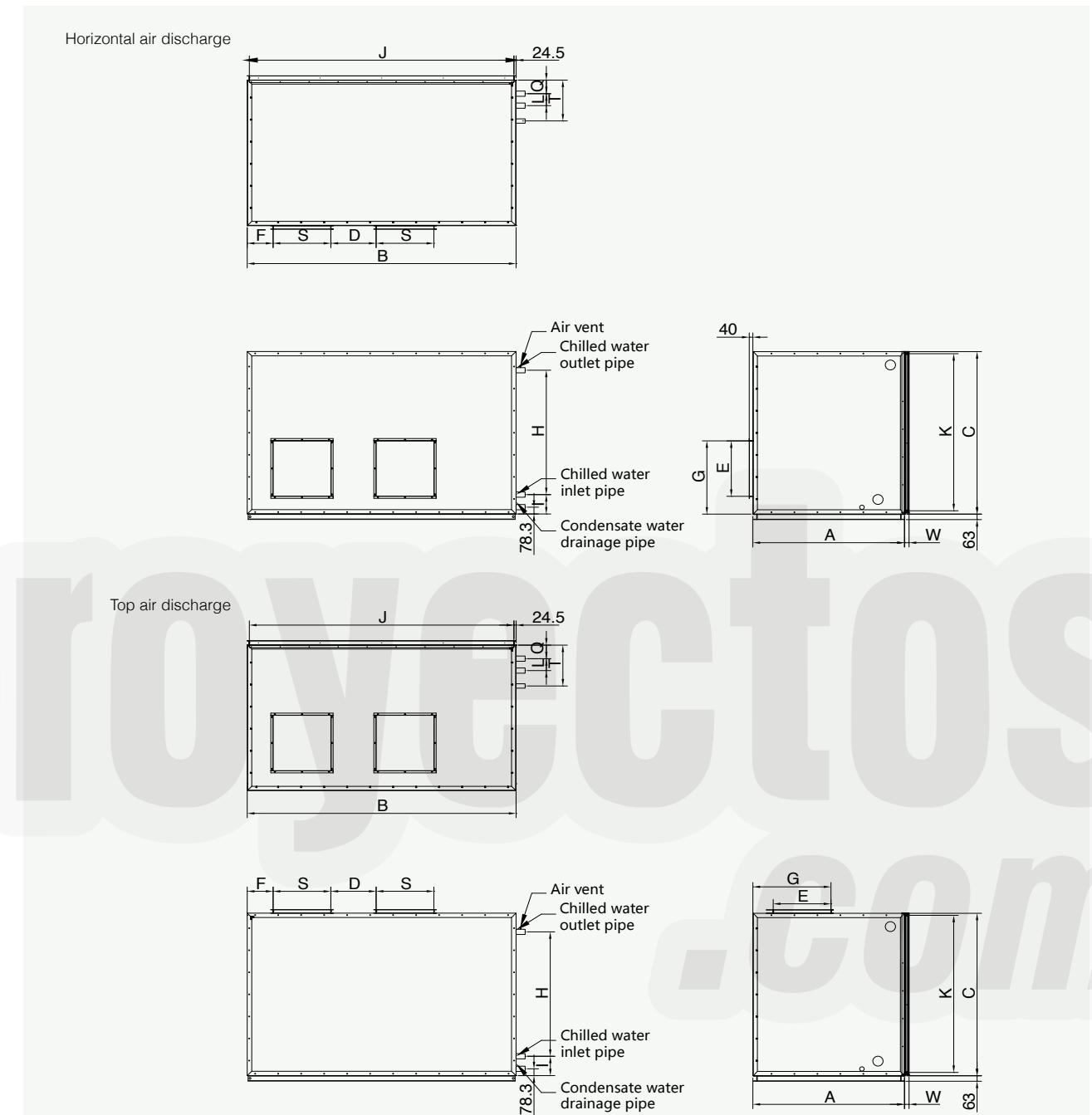

Unit: mm

Unit size	Cabinet size			Supply air discharge size						Pipe size								Return air inlet size			
	A	B	C	D	S	E	F	G (Horizontal air-out)	G (Top air-out)	H (4R)	H (6R)	I (4R)	I (6R)	Q (4R)	Q (6R)	L (4R)	L (6R)	T	J	K	W
DDW270C	1315	2520	1420	458	557	478	147	675	830	1104	1104	168	168	174	161	110	138	420	2473	1358	50
DDW300C	1365	2810	1490	458	557	478	292	675	819	1167	1167	168	168	174	161	110	138	470	2763	1428	90
DDW330C	1605	2810	1550	450	569	569	315	774	916	1231	1231	168	168	174	161	110	138	470	2763	1488	90
DDW360C	1605	2810	1610	450	569	569	315	774	916	1294	1294	168	168	174	161	110	138	470	2763	1548	90
DDW400C	1675	2970	1740	500	638	638	286	843	1007	1421	1421	168	168	174	161	110	138	470	2923	1678	90
DDW450C	1675	2970	1870	500	638	638	286	843	1007	1548	1548	168	168	174	161	110	138	470	2923	1808	90

Notes: The cabinet size does not include the protruding parts (header, air outlet, filter, and suspender) as shown in the figure above.

➤ Dimension of DDW vertical unit (25mm panel)

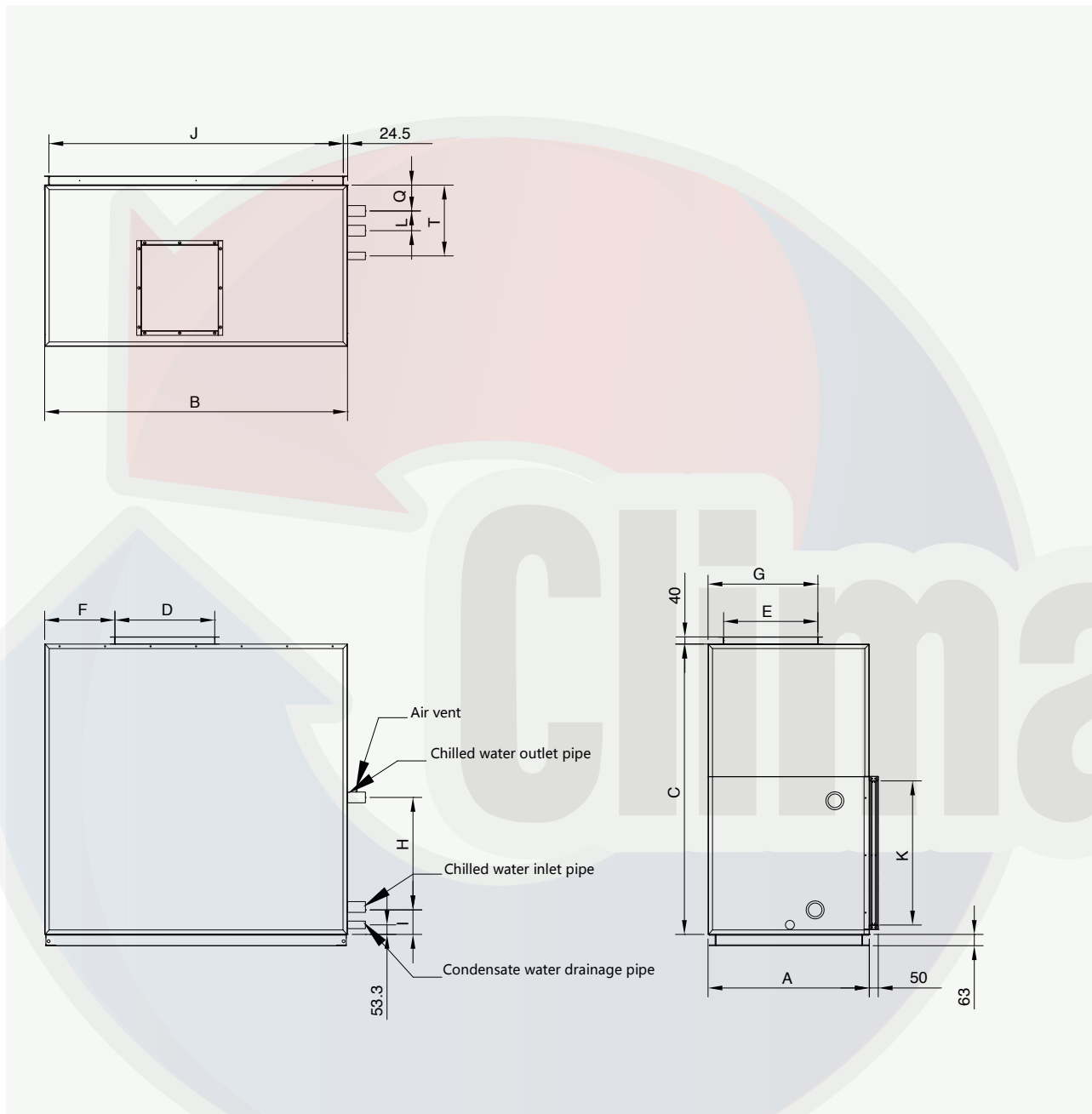

Unit: mm

Unit size	Cabinet size			Supply air discharge size				Pipe size								Return air inlet size		
	A	B	C	D	E	F	G	H (4R)	H (6R)	I (4R)	I (6R)	Q (4R)	Q (6R)	L (4R)	L (6R)	T	J	K
DDW040C	650	1080	1170	331	289	208	403	434	434	129	129	173	179	66	110	393	1033	605
DDW050C	650	1250	1240	309	341	293	423	434	434	129	129	173	179	66	110	443	1203	605
DDW060C	650	1320	1290	395	341	288	422	485	485	129	129	173	179	66	110	443	1273	655
DDW070C	750	1500	1370	373	404	364	484	485	469	129	137	173	179	66	110	443	1453	675
DDW080C	750	1680	1370	373	404	543	484	485	469	129	137	173	179	66	110	443	1633	675
DDW100C	900	1690	1620	430	478	442	565	609	609	137	137	192	179	110	138	443	1643	805
DDW120C	900	1690	1750	557	478	392	550	736	736	137	137	192	179	110	138	443	1643	915

Notes: The cabinet size does not include the protruding parts (header, air outlet, filter, and suspender) as shown in the figure above.

➤ Dimension of DDW vertical unit (25mm panel)

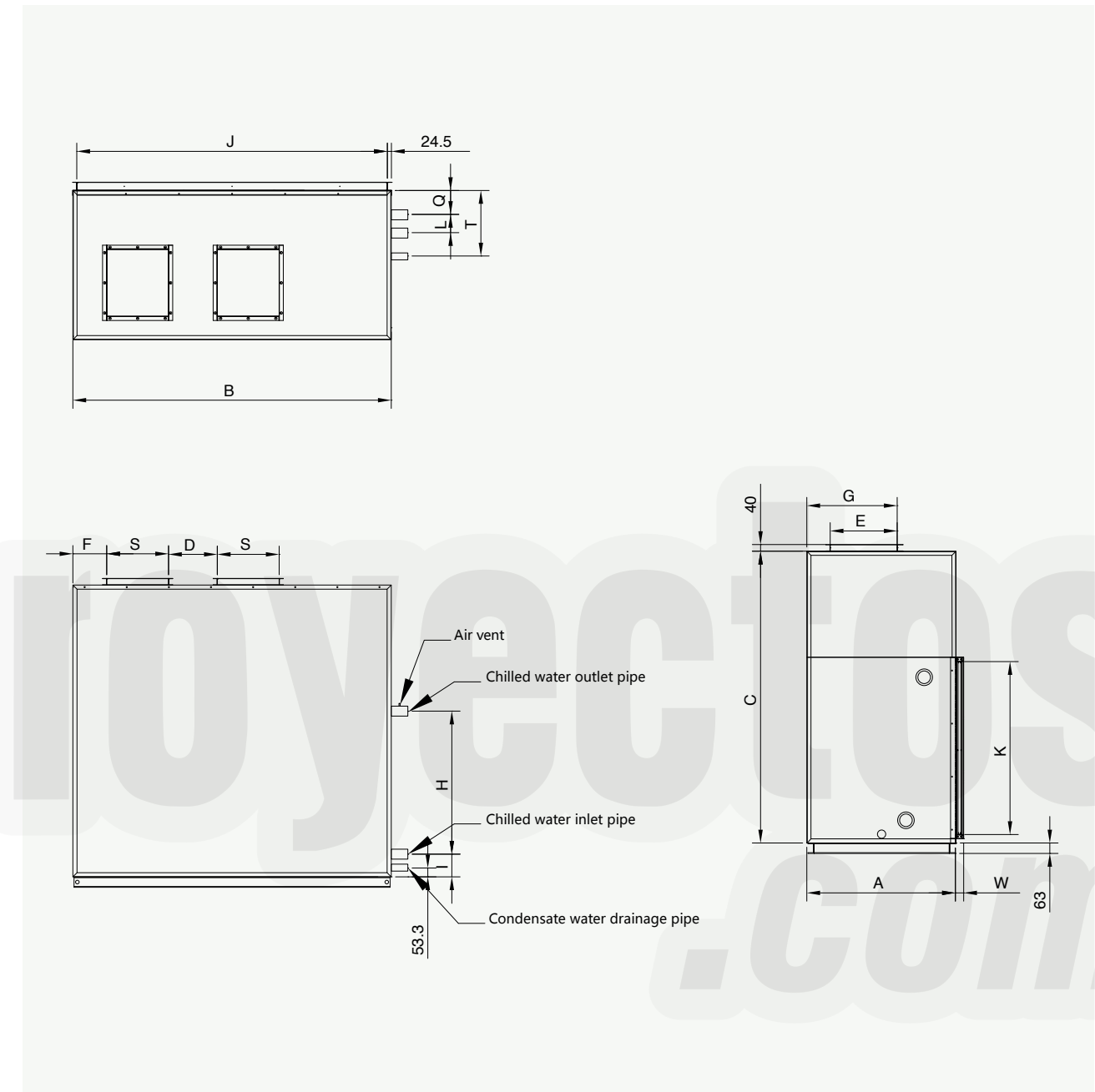

Unit: mm

Unit size	Cabinet size			Supply air discharge size					Pipe size								Return air inlet size			
	A	B	C	D	S	E	F	G	H (4R)	H (6R)	I (4R)	I (6R)	Q (4R)	Q (6R)	L (4R)	L (6R)	T	J	K	W
DDW150C	900	1920	1760	294	373	404	204	545	863	850	137	143	192	179	110	138	443	1873	1045	50
DDW180C	900	2100	1940	343	430	478	172	572	913	913	143	143	192	179	110	138	443	2053	1105	50
DDW200C	900	2280	1940	343	430	478	252	571	913	913	143	143	192	179	110	138	443	2233	1105	50
DDW220C	900	2400	2010	458	557	478	114	571	977	977	143	143	192	179	110	138	443	2353	1175	50
DDW250C	900	2400	2130	458	557	478	114	571	1104	1104	143	143	192	179	110	138	443	2353	1295	50
DDW270C	900	2470	2130	458	557	478	122	571	1104	1104	143	143	192	179	110	138	443	2423	1295	50
DDW300C	900	2760	2200	458	557	478	267	571	1167	1167	143	143	192	179	110	138	493	2713	1365	90
DDW330C	1100	2760	2340	450	569	569	290	711	1231	1231	143	143	192	179	110	138	493	2713	1425	90
DDW360C	1100	2760	2400	450	569	569	290	711	1294	1294	143	143	192	179	110	138	493	2713	1485	90
DDW400C	1170	2920	2610	500	638	638	261	769	1421	1421	143	143	192	179	110	138	493	2873	1615	90
DDW450C	1170	2920	2685	500	638	638	261	769	1548	1548	143	143	192	179	110	138	493	2873	1745	90

Notes: The cabinet size does not include the protruding parts (header, air outlet, filter, and suspender) as shown in the figure above.

➤ Lookup table for motor power - maximum external total pressure

Unit model		DDW020C	DDW030C	DDW040C	DDW050C	DDW060C
Nominal airflow rate (m³/h)		2000	3000	4000	5000	6000
Row of coil	Motor power (kW)	ETP (Pa)				
4-row	0.55	430	200	130		
	0.75	590	360	250		
	1.1	820	550	450	260	200
	1.5		740	650	460	350
	2.2			790	750	620
	3				870	820
6-row	0.55	390	140			
	0.75	550	310	200		
	1.1	780	490	400	210	140
	1.5		690	600	410	300
	2.2			750	700	570
				820	760	

Unit model		DDW070C	DDW080C	DDW100C	DDW120C	DDW150C
Nominal airflow rate (m³/h)		7000	8000	10000	12000	15000
Row of coil	Motor power (kW)	ETP (Pa)				
4-row cooling coil	0.75					
	1.1	130				
	1.5	300				
	2.2	560	350	270	190	
	3	830	610	460	350	180
	4	870	890	690	520	350
	5.5			850	750	600
	7.5				830	850
6-row cooling coil	0.75					
	1.1					
	1.5	240				
	2.2	510	300	220	140	
	3	780	560	420	300	130
	4	820	840	640	470	310
	5.5			800	700	550
			780	800		

Unit model		DDW180C	DDW200C	DDW220C	DDW250C	DDW270C
Nominal airflow rate (m³/h)		18000	20000	22000	25000	27000
Row of coil	Motor power (kW)	ETP (Pa)				
4-row cooling coil	3	160				
	4	290	210	180		
	5.5	490	380	340	220	170
	7.5	720	590	530	410	320
	11		780	790	700	580
	15					740
6-row cooling coil	3	110				
	4	250	160	140		
	5.5	440	340	300	170	
	7.5	670	550	480	360	270
			730	650	530	690

Unit model		DDW300C	DDW330C	DDW360C	DDW400C	DDW450C
Nominal airflow rate (m³/h)		30000	33000	36000	40000	45000
Row of coil	Motor power (kW)	ETP (Pa)				
4-row cooling coil	5.5					
	7.5	190	210			
	11	440	450	290	320	
	15	720	730	690	600	400
	18.5			850	790	590
	22					780
6-row cooling coil	5.5		160			
	7.5					
	11	400	400	240	270	
	15	680	680	640	550	350
				800	750	540
						730

Notes:
 ■ The table lists the maximum ETP for the motor power corresponding to the unit (including standard configured filter + cooling coil). If some function sections are added, maximum ETP should minus the resistance of corresponding component. For example, the DDW300C unit can be selected with motor power of 11kW, 4-row cooling coil, maximum ETP of 440Pa. If the unit is added with wet film, for the resistance of 55Pa, the maximum ETP should be 440-55=385Pa.

➤ Notes

- Note to specify the thickness and model of unit panel, the orientation of water inlet/outlet pipe, the quantity, the unit working condition, and the structure type when placing an order.
- This unit is available for standard model, and also multi-function designed according to customer requirements. Note to specify it clear when placing an order.
- Appropriate water seal should be fitted to ensure the smooth drainage of condensate water during the installation. The installation diagram for water seal is shown in Fig 1.
- The electrical wiring diagram for the unit is shown in Fig 2.

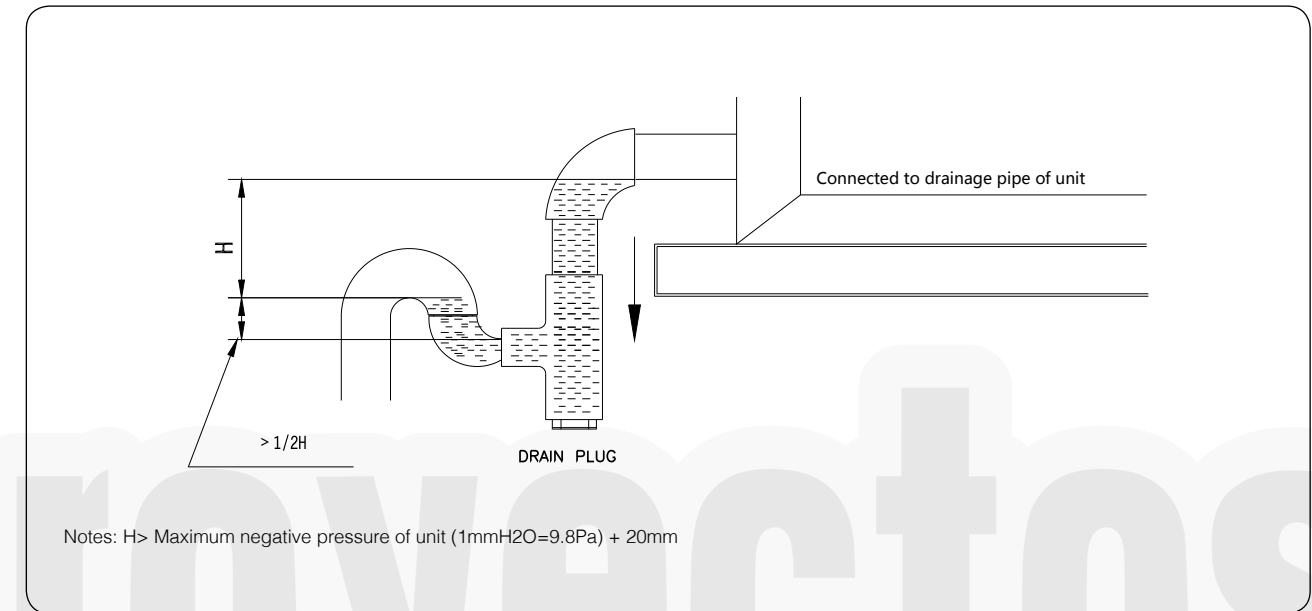

Fig 1 Installation diagram for water seal

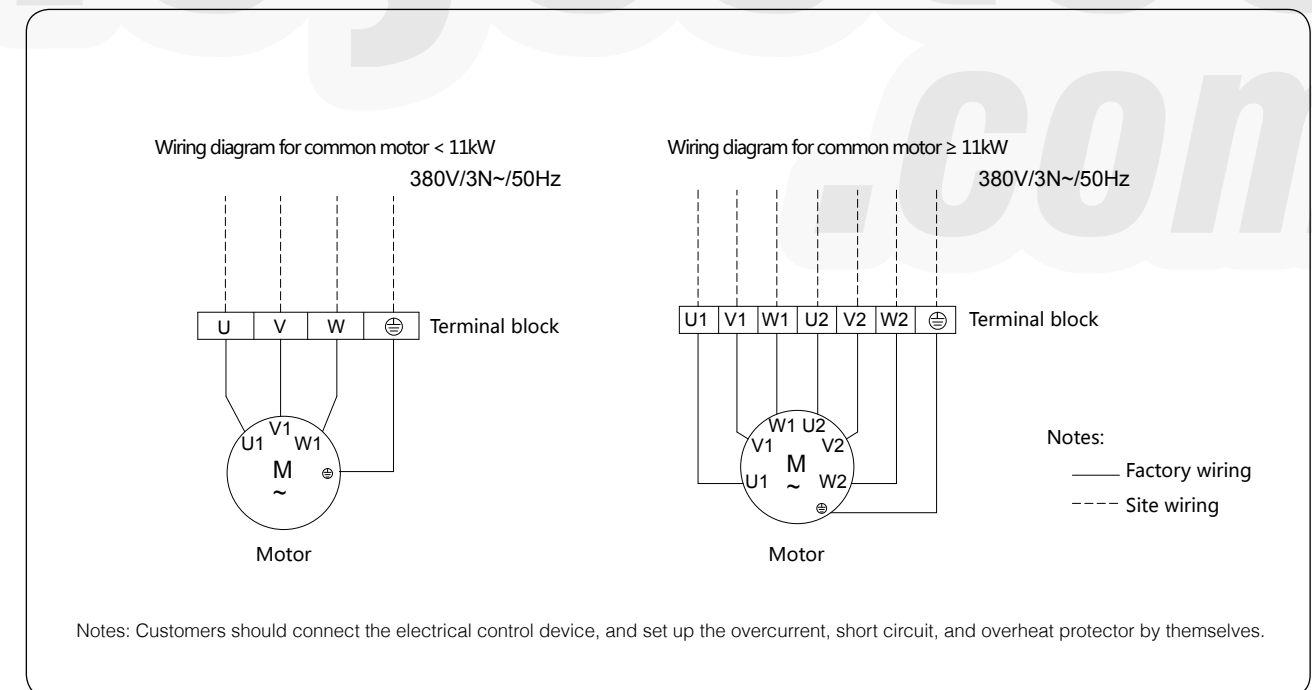

Fig 2 Electrical wiring diagram

Warning



- Daikin Industries, Ltd.'s products are manufactured for export to numerous countries throughout the world. Daikin Industries, Ltd. does not have control over which products are exported to and used in a particular country. Prior to purchase, please therefore confirm with your local authorized importer, distributor and/or retailer whether this product conforms to the applicable standards, and is suitable or use, in the region where the product will be used. This statement does not purport to exclude, restrict or modify the application of any local legislation.
- Ask a qualified installer or contractor to install this product. Do not try to install the product yourself. Improper installation can result in water or refrigerant leakage, electrical shock, fire or explosion.
- Use only those parts and accessories supplied or specified by Daikin. Ask a qualified installer or contractor to install those parts and accessories. Use of unauthorized parts and accessories or improper installation of parts and accessories can result in water or refrigerant leakage, electrical shock, fire or explosion.
- Read the User's Manual carefully before using this product. The User's Manual provides important safety instructions and warnings. Be sure to follow these instructions and warnings.

If you have any enquiries, please contact your local importer, distributor and/or retailer.



ISO9001: 2008
Quality Management
System Certification

Certificate No.: 9601019



ISO14001: 2004 Environmental Management System Certification

Certificate No.: EMS 80362

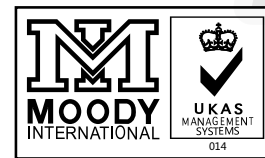

BS-OHSAS18001: 2007 Occupational Health and Safety Management System Certification

Certificate No.: 7644

Cautions on product corrosion

1. The units should not be installed in areas where corrosive gases, such as acid gas or alkaline gas, are produced.
2. If the unit is to be installed close to the sea shore, direct exposure to the sea breeze should be avoided. If you need to install the unit close to the sea shore, contact your local distributor.

Dealer

DAIKIN INDUSTRIES, LTD.

Head Office:
Umeda Center Bldg., 2-4-12, Nakazaki-Nishi,
Kita-ku, Osaka, 530-8323 Japan
http://www.daikin.com/global_ac/

© All rights reserved

Literature No.: CA-DDW-C-201607

Supersedes: N/A