

DVM S

AM***FXVAF* Series

AM***FXVAJ* Series

AM***HXVAF* Series

AM***HXVAJ* Series

AM***KXVTF* Series

AM***KXVTJ* Series

Air Conditioner installation manual

Climaproyectos
.com

imagine the possibilities

Thank you for purchasing this Samsung product.

Contents

Safety precautions	3
Preparing for installation	6
Selecting installation location	11
Space requirement for installation	13
Accessories	15
Base construction and installation of the outdoor unit	17
Installing the wind/snow prevention duct	22
Refrigerant pipe installation	24
Electrical wiring work	56
Air tightness test and vacuum drying	71
Pipe insulation	73
Charging additional refrigerant	77
Basic segment display	79
Setting outdoor unit option switch and key function	79
Things to check after completing the installation	88
Inspection and test operation	90
Inspection and trial operation	92
Automatic refrigerant amount detection function	94



Climaproyectos
.com

Safety precautions

WARNING

State of California Proposition 65 Warning (US only)

This product contains chemicals known to the State of California to cause cancer and birth defects or other reproductive harm.

Please follow the following safety information for safety of the installer and the user.

- * DVM S air conditioner uses R-410A refrigerant.
 - When using R-410A, moisture or foreign substances may affect the performance and reliability of the product. Safety precautions must be obeyed when installing the refrigerant pipe.
 - The designed maximum pressure of the system is 4.1MPa(594.6 psi) and therefore select appropriate material and thickness according to the regulations.
 - R-410A is a quasi-azeotrope of two refrigerants and it has to be charged in liquid phase when filling the refrigerant. (If you charge vapor refrigerant, it may change the blend of the refrigerant and cause product malfunction.)
- * You must connect the indoor units for R-410A refrigerant. Refer to product catalog to find out the models names for connectable indoor units. (If you connect the indoor units that are not designed for R-410A, it cannot operated normally.)
- * After completing the installation and trial operation, explain to the user how to use and maintain the product. Also, hand over this installation manual so that it can be stored by the user.
- * Manufacturer is not responsible for the incidents occurred by improper installation. Installer is responsible for any installation related claims from the user occurred by neglecting warnings and cautions stated in this manual. (Installer will be responsible for any service charges that may occur)
- * Generally, system air conditioners should not be relocated after installation. But when it has to be relocated for inevitable reasons, please contact Samsung's qualified dealers for system air conditioners.

WARNING

- Hazards or unsafe practices that may **result in severe personal injury or death.**

CAUTION

- Hazards or unsafe practices that may **result in minor personal injury (to installer/user) or property damage.**

SEVERE WARNING SIGNS

Consult qualified installer or dealer for installation.

- ▶ When installation is done by unqualified person, problems such as water leakage, electric shock or fire may occur.

Installation work must be done properly according to this installation manual.

- ▶ When installation is not done properly, it may cause water leakage, electric shock or fire.

When installing the unit in a small room, take measure to keep the refrigerant concentration from exceeding allowable safety limits in case of refrigerant leakage. Consult the dealer for precautionary measure before the installation.

- ▶ When refrigerant leaks and exceed dangerous concentration level, it may cause suffocation accidents.

If any gas or impurities, except R-410A refrigerant, come into the refrigerant pipe, serious problem may occur and it may cause injury.

Use the supplied accessories, specified components and tools for the installation.

- ▶ Do not use the pipe and the installation product used for the R-22 refrigerant.
- ▶ Failure to use the specified components can cause product fall down, water leakage, electrical shock, and fire. (The pipe and flare components used for R-22 refrigerant must not be used)

Install the outdoor unit on a hard and even place that can support its weight.

- ▶ If the place cannot support its weight, the outdoor unit may fall down and it may cause injury.

Safety precautions

Check the following before installation and service work.

- ▶ Before welding, remove dangerous and inflammable things that may cause an explosion and fire around the work.
- ▶ Before welding, remove the refrigerant from inside the pipe or the product.
 - If you perform welding while refrigerant is in the pipe, it may increase the pressure of the refrigerant and cause the pipe to burst. If the pipe bursts or explodes, it may cause severe injury to the installer.
- ▶ When welding, use the nitrogen gas to eliminate oxidation inside the pipe.

Do not modify the product on your own.

- ▶ Potential risk of electric shock, fire, product failure or injury.

Fix the outdoor unit securely on foundation to resist strong wind or earthquake.

- ▶ If the outdoor unit is not properly fixed, it turns over and accidents may occur.

Electric work must be done by qualified persons, complying the national wiring regulations and installed according to the instruction stated in the installation manual with leased circuit.

- ▶ Capacity shortage on the leased circuit and improper installation may cause electric shock or fire.

Make sure to perform grounding work.

- ▶ Do not connect the ground wire to a gas pipe, water pipe, lightning rod or telephone grounding. Improper grounding could cause electric shock.

Wiring must be connected with the designated wires and it must be fixed securely so that it does not apply any external force to the connection part of the terminals.

- ▶ If connection for fixation is not properly done, it may cause heat generation or fire.

Neatly arrange the wires in the electrical parts to make sure that electrical cover is closed securely without any gaps.

- ▶ If the cover is not properly closed, heat may generate on the electrical terminal and cause electric shock or fire.

Exclusive circuit breaker (MCCB, ELB) must be installed to the power supply.

- ▶ When overcurrent or current leakage occurs with no circuit breaker installed, power will not be cut-off and it may cause electric shock or fire.
- ▶ Do not use damaged parts. It may cause fire or electric shock.

You must cut-off the power before you work on, or adjust any power supply part for product installation, maintenance, repair or any other services.

- ▶ There is risk of electric shock.
- ▶ Even when the power is off, it is dangerous when you come in contact with inverter PCB, fan PCB since high pressure DC voltage is charged to those parts.
- ▶ When replacing/repairing the PCB, cut-off the power and wait until the DC voltage is discharged before replacing/repairing them. (Wait for more than 15 minutes to allow it to discharge naturally.)

If the refrigerant gas leaks during the installation, you should ventilate the room.

- ▶ When the refrigerant gas gets in contact with flammable substance, it may generate toxic gas.

Gas leakage must be checked after installation is completed.

- ▶ When the refrigerant gas gets in contact with flammable substance, it may generate toxic gas.

You can get a frostbite if you get in contact with the leaked refrigerant gas.

Supply power to the product during winter time since the product will operate in protection mode itself when the temperature decrease below 0°C(32°F).

- ▶ If you cut-off the power, compressor protection mode cannot be operated and may cause damage to the product.

CAUTION SIGNS

Do not install the drain pipe directly to the bottom part of the outdoor unit and built a proper drainage so that water drains out smoothly. If not, pipe may freeze or bursts during winter time and cause damage to the product or water leakage.

- ▶ When the draining work is not done properly, water leak may occur and cause property damage.

Install the power cable and communication cable of the indoor and outdoor unit at least 1.5m(4.92ft) away from the electric appliances and install it at least 2m(6.56ft) away from the lightning conductor.

- ▶ Noise may be generated from the electronic devices, depending on the status of the electric wave.

Install the outdoor unit within the angle stated in the table, according to the height of the building.

- ▶ Do not leave the refrigerant container under the hot sunlight. (There is risk of explosion.)
- ▶ You must use the appropriate pipes according to the standard since the pressure of the refrigerant is very high.
- ▶ Make sure that the pipes does not get any weaker by welding it too much.
- ▶ Make sure to install the product away from children's' reach. (Sharp parts of the heat exchanger is may cause personal injury and when parts of the product gets damage, it may decrease product's performance.)

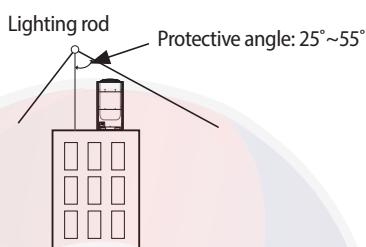

Height of the building	Protection control
20m(65.6 ft) or less	55°
40m(131.2 ft) or less	35°
60m(196.9 ft) or less	25°

Install the indoor unit away from lighting apparatus that uses ballast stabilizer.

- ▶ If you use the wireless remote control, it may not operate normally due to ballast stabilizer.

Do not install the product in following places.

- ▶ Place where outdoor unit's noise and warm air may disturb neighbors. (It may cause property loss.)
- ▶ Do not leave any obstacles around the inlet and outlet of the product. (It may cause damage or accidents.)
- ▶ The place where there is mineral oil or arsenic acid.
 - Those parts may get damaged due to burned resin and cause water leakage or product may fall.
 - The efficiency of the heat exchanger may reduce or product may break.
- ▶ The place where corrosive gas such as sulfurous acid gas generates from the vent pipe or air outlet.
 - The copper pipe or connection pipe may corrode and refrigerant may leak.
- ▶ The place where there is a machine that generates electromagnetic waves.
 - The air conditioner may not operate normally due to problems in control system.
- ▶ The place where there is a danger of combustible gas leakage or place where thinner or gasoline is handled.
 - (There is risk of fire or explosion.)
- ▶ The place with carbon fiber or flammable dust.
- ▶ The place near seashore or hot spring where there is risk of outdoor unit corrosion.

Safety precautions

Changes in DVM S (inverter) compare to conventional models that has to noted when installing

- ▶ For optimal distribution of the refrigerant, you must use Y-joint as branch joint for connecting outdoor units. (To not use T-joint)
- ▶ You cannot operate normally if you do not complete the trial operation through outdoor unit key mode. You must use KEY MODE to run trial operation.
- ▶ DVM S air conditioner uses R-410A refrigerant.
- ▶ Check the compatibility of other products such as indoor unit, EEV kits etc. which will be connected to DVM S.
- ▶ Make sure to note that outdoor unit combination is different from DVM PLUS III and IV.
- ▶ The length of maximum piping, level difference, the quantity of connectable indoor units, the installation at the outdoor joints and the outdoor unit combinations are different from the conventional models.
- ▶ If the pipe length is over 2m(6.56ft) between outdoor units, make traps to prevent oil stagnation. Oil stagnation may occur when outdoor unit at the end of module stops while other outdoor units are still in operation.

Preparing for installation

Outdoor unit classification

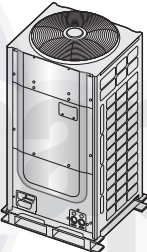
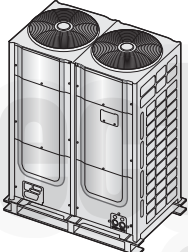
Classification		Small type	Large type
Appearance			
Models	AM***F* Series	AM072***	AM096/120/144***
	AM***H* Series		AM168/192***
	AM***K* Series		AM072/096***



CAUTION

Packaging material disposition

- Safely store or dispose the packaging materials.
 - Sharp metals such as nails or wooden material packaging that may break into pieces become a cause for personal injury.
 - Make sure to store or dispose the vinyl type packaging material to keep it out of reach of children. Children may put them over their face, which is very dangerous since it may lead them to suffocation.

Preparing for installation

Outdoor unit combination

- ▶ Make sure to use an indoor unit that is compatible with DVM S.
- ▶ Indoor units can be connected within the range indicated in following table.
- ▶ If the total capacity of the connected indoor units exceeds the indicated maximum capacity, cooling and heating capacity of the indoor unit may decrease.
- ▶ Total capacity of the connected indoor units can be allowed from 50% to 130% of the total outdoor unit capacity.
 $0.5 \times \Sigma (\text{Outdoor unit capacity}) \leq \text{Total capacity of the connected indoor units} \leq 1.3 \times \Sigma (\text{Outdoor unit capacity})$

Module combination for AM***F* Series, AM***H* Series

Model name for Combination		6TON	8TON	10TON	12TON
		AM072FXVA**	AM096FXVA**	AM120FXVA**	AM144FXVA**
Number of individual outdoor units		1	1	1	1
Combined outdoor unit	AM072***	1			
	AM096***		1		
	AM120***			1	
	AM144***				1
	AM168***				
Nominal Capacity	Cooling(btu/h)	72000	96000	120000	144000
	Heating(btu/h)	81000	108000	135000	162000
Rated Capacity	Cooling(btu/h)	69000	92000	114000	138000
	Heating(btu/h)	77000	103000	129000	154000
Total capacity of the connected indoor units(cooling)	Minimum(btu/h)	36000	48000	60000	72000
	Maximum(btu/h)	93600	124800	156000	187200
Maximum number of connectable indoor units		12	16	20	25

Model name for Combination		14TON	16TON	18TON	20TON
		AM168HXVA**	AM192HXVA**	AM216FXVA**	AM240HXVA**
Number of individual outdoor units		1	1	2	2
Combined outdoor unit	AM072***			1	1
	AM096***				
	AM120***				
	AM144***			1	
	AM168***	1			1
Nominal Capacity	Cooling(btu/h)	168000	192000	216000	240000
	Heating(btu/h)	189000	216000	243000	270000
Rated Capacity	Cooling(btu/h)	160000	184000	206000	228000
	Heating(btu/h)	180000	206000	230000	258000
Total capacity of the connected indoor units(cooling)	Minimum(btu/h)	84000	96000	108000	120000
	Maximum(btu/h)	218400	249600	280800	312000
Maximum number of connectable indoor units		29	33	37	41

Preparing for installation

Model name for Combination		22TON	24TON	26TON	28TON
		AM264HXVA**	AM288FXVA**	AM312HXVA**	AM336HXVA**
Number of individual outdoor units		2	2	2	2
Combined outdoor unit	AM072***	1			
	AM096***				
	AM120***				
	AM144***		2	1	
	AM168***			1	2
Nominal Capacity	AM192***	1			
	Cooling(btu/h)	264000	288000	312000	336000
Rated Capacity	Heating(btu/h)	297000	324000	351000	378000
	Cooling(btu/h)	252000	276000	298000	320000
Total capacity of the connected indoor units(cooling)	Heating(btu/h)	282000	308000	334000	360000
	Minimum(btu/h)	132000	144000	156000	168000
Maximum number of connectable indoor units		45	49	54	58

Model name for Combination		30TON	32TON	34TON	36TON
		AM360HXVA**	AM384HXVA**	AM408HXVA**	AM432FXVA**
Number of individual outdoor units		2	2	3	3
Combined outdoor unit	AM072***			1	
	AM096***				
	AM120***				
	AM144***			1	3
	AM168***	1			
Nominal Capacity	AM192***	1	2	1	
	Cooling(btu/h)	360000	384000	408000	432000
Rated Capacity	Heating(btu/h)	405000	432000	459000	486000
	Cooling(btu/h)	344000	366000	390000	415000
Total capacity of the connected indoor units(cooling)	Heating(btu/h)	386000	410000	435000	460000
	Minimum(btu/h)	180000	192000	204000	216000
Maximum number of connectable indoor units		62	64	64	64

Model name for Combination		38 TON	40 TON	42 TON	44 TON
		AM456HXVA**	AM480HXVA**	AM504HXVA**	AM528HXVA**
Number of individual outdoor units		3	3	3	3
Combined outdoor unit	AM072***				
	AM096***				
	AM120***	1			
	AM144***		1		
	AM168***	2	2	3	2
Nominal Capacity	AM192***				1
	Cooling(btu/h)	456000	480000	504000	528000
Rated Capacity	Heating(btu/h)	513000	540000	567000	594000
	Cooling(btu/h)	435000	455000	480000	500000
Total capacity of the connected indoor units(cooling)	Heating(btu/h)	490000	510000	535000	560000
	Minimum(btu/h)	228000	240000	252000	264000
Maximum number of connectable indoor units		64	64	64	64

► Module combination for AM***K* Series

Model name for Combination		6 TON	8 TON	12 TON	14 TON
Number of individual outdoor units		1	1	2	2
Combined outdoor unit	AM072***	1		2	1
	AM096***		1		1
Nominal Capacity	Cooling(btu/h)	72000	96000	144000	168000
	Heating(btu/h)	81000	108000	162000	189000
Rated Capacity	Cooling(btu/h)	69000	92000	138000	160000
	Heating(btu/h)	77000	103000	154000	180000
Total capacity of the connected indoor units(cooling)	Minimum(btu/h)	36000	48000	72000	84000
	Maximum(btu/h)	93600	124800	187200	218400
Maximum number of connectable indoor units		12	16	25	29

Model name for Combination		16 TON	18 TON	20 TON	22 TON	24 TON
Number of individual outdoor units		2	3	3	3	3
Combined outdoor unit	AM072***		3	2	1	
	AM096***	2		1	2	3
Nominal Capacity	Cooling(btu/h)	192000	216000	240000	264000	288000
	Heating(btu/h)	216000	243000	270000	297000	324000
Rated Capacity	Cooling(btu/h)	184000	206000	228000	252000	276000
	Heating(btu/h)	206000	230000	258000	282000	308000
Total capacity of the connected indoor units(cooling)	Minimum(btu/h)	96000	108000	120000	132000	144000
	Maximum(btu/h)	249600	280800	312000	343200	374400
Maximum number of connectable indoor units		33	37	41	45	49

* You can connect maximum 64 indoor units to the outdoor unit. Maximum quantity of connectable indoor unit is set to 64 since outdoor unit only support up to 64 communication address. Indoor unit address can be assigned from 0~63. If the indoor unit address was assigned from 64~79, E201 error will occur.

* Minimum capacity of the indoor unit is 7.5MBH.



CAUTION

• Installation combination must be complied when composing outdoor unit combination.

Preparing for installation

Moving the outdoor unit

- ▶ Select the moving path in advance.
- ▶ Be sure that moving path can support weight of the outdoor unit.
- ▶ Do not slant the product more than 30° when carrying it. (Do not lay the product down in sideways.)
- ▶ Surface of the heat exchanger is sharp. Be careful not to get injured while moving the product.



• You must use certain part of the product when moving the product.

When moving with a crane

- ▶ Fasten the wire rope as shown in the figure.
- ▶ To protect damage or scratches, insert a piece of cloth between the outdoor unit and the wire rope.

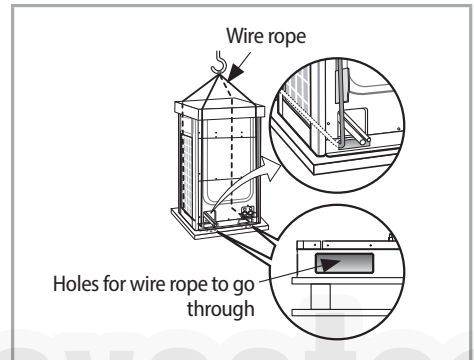

When moving with a forklift

- ▶ Carefully insert the forklift forks into the forklift holes at the bottom of the outdoor unit.
- ▶ Be careful with the forklift from damaging the product.

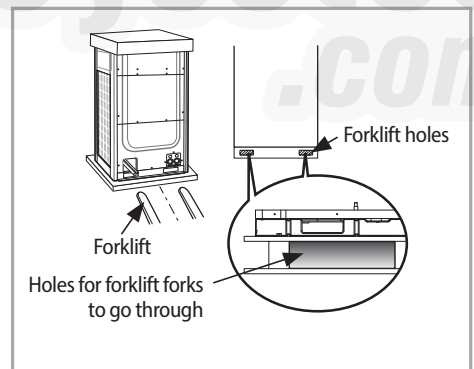

When moving the product without wooden pallet and the crane is not available for use

- ▶ Connect a wire rope to the outdoor unit as you would move it with a crane.
- ▶ Hang the wire rope to the forklift fork to move the outdoor unit.

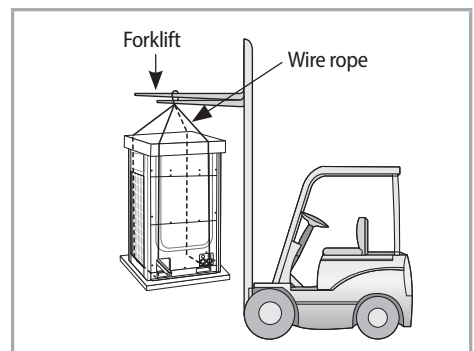

Selecting installation location

Decide the installation location, with the consideration of the following conditions, under user's approval.

- ▶ Place where hot discharge air or noise from the outdoor unit may not disturb the neighbor (Especially in residential areas, keep the operation hours in mind.)
- ▶ Place where structure can bear the weight and vibration of the outdoor unit.
- ▶ Place with flat surface where rainwater does not settle or leak.
- ▶ Place where it is not exposed to strong wind.
- ▶ Well ventilated place with sufficient service place for repairs and maintenance. (Discharge duct can be purchased separately)
- ▶ Place where you can connect the refrigerant pipes between indoor and outdoor units within allowable distance.
- ▶ Place where it allows easy waterproofing and draining work for the condensation water generated from the outdoor unit during heating operation.
- ▶ Place where there is no risk of inflammable gas leakage.
- ▶ Place where there is no direct influence of snow or rain.
- ▶ Do not install the product in a place where it will be directly exposed to sea breeze.
 - Consult an installation expert (or company) since you will need to take extra anti-corrosion measures if you need to install the product in a place where it can be exposed to direct sea breeze. (You have to remove dusts and salinity on the heat exchanger and apply designated rust inhibitor more than once a year.)

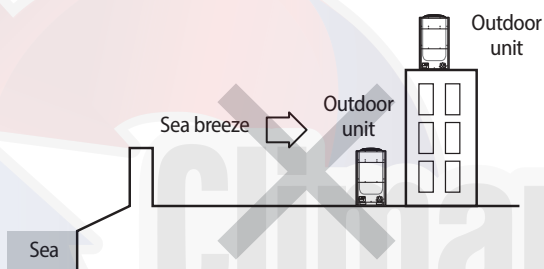

* Caution when installing the product in seashore

- When installing the product in seashore, make sure to install it behind a structure (such as building) that can block the sea breeze or install protection wall around the outdoor unit.
- Make sure to install the product in a place where it allows smooth drainage.

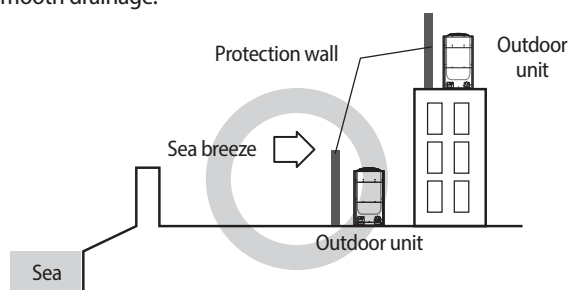
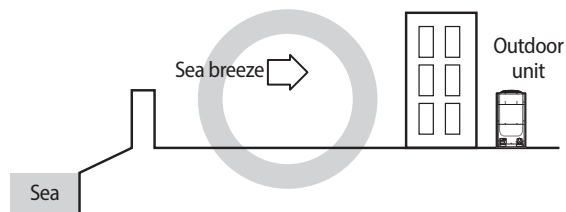

Protection wall should be constructed with a solid material that can block the sea breeze and the height and width of the wall should be 1.5 times larger than the size of the outdoor unit. (You must secure more than 700mm(28inch) of space between the protection wall and the outdoor unit for air circulation.)

Selecting installation location



- System air conditioner may cause static noise when listening to AM stations. Therefore, select an installation location for indoor unit where electrical wiring can be done while keeping certain distance from a radio, computer and stereo equipment.
 - Especially, keep the unit at least 3m(9.84inch) away from the electrical equipment in an area with weak electromagnetic waves and put the main power cable and communication cables in a separately installed protection tube.
 - Make sure that there is no equipment that generates electromagnetic waves. If not electromagnetic waves may cause problem to the control systems which may lead to air conditioner malfunction. (Example: Remote control sensor of the indoor unit may not receive the signal very well, due to ballast stabilizer of the lighting equipment.)
- In regions with heavy snowfall, make sure to install the outdoor unit where there is no concerns of direct snowfall on the outdoor unit. Also, build higher base support so that accumulated snow does not block the air inlet or the heat exchanger.
- R-410A refrigerant is a safe, nontoxic and nonflammable refrigerant. However, if the place holds any concerns for exceeding dangerous level of refrigerant concentration in case of refrigerant leakage, extra ventilation system is required.
- When you install the outdoor unit in a high places such as roof, install fence or guardrail around it. When there is no fence or guardrail, service person could fall.
- Do not install the product in places where corrosive gases such as sulfur oxides, ammonia, and sulfurous gas are produced. (e.g. Toilet outlet, ventilation opening, sewage works, dyeing complex, cattle shed, sulfuric hot spring, nuclear power plant, ship etc.) When installing the product in those places, contact an installation specialty store as the copper pipe and brazing part will need additional corrosion proof or anti-rust additive to prevent corrosion.
- Make sure to keep any inflammable materials (such as wooden materials, oil etc.) around the outdoor unit. When there's fire, those inflammable material will easily catch the fire and may pass it on to the product.
- Depending on the condition of power supply, unstable power or voltage any cause malfunction of the parts or control system. (At the ship or places using power supply from electric generator...etc)
- Make sure to install MCU when using HR products.
- When you select the location to install MCU, the location is far away from indoor rooms because the refrigerant running of MCU may create noise.

Space requirement for installation

- ▶ Space requirement was decided based on following conditions; Cooling mode, outdoor temperature of 35°C (95°F). Larger space is required if the outdoor temperature is higher than 35°C (95°F) or if the place is heated easily by quantity of solar radiation.
- ▶ When you secure installation space, consider path for people and the direction of the wind.
- ▶ Secure installation space as shown in the below illustration, considering ventilation and the service space.
- ▶ If the installation space is narrow, installer or other worker may get injured during work and may also cause problem to the product.
- ▶ If you install multiple number of outdoor units in one space, make sure to secure enough ventilation space if there's any walls around the product that may disturb the air flow. If enough ventilation space is not secured, product may malfunction.
- ▶ You may install the outdoor units with 20mm (0.78 inch) of space between the product, but product's performance may decrease depending on the installation environment.

Single installation

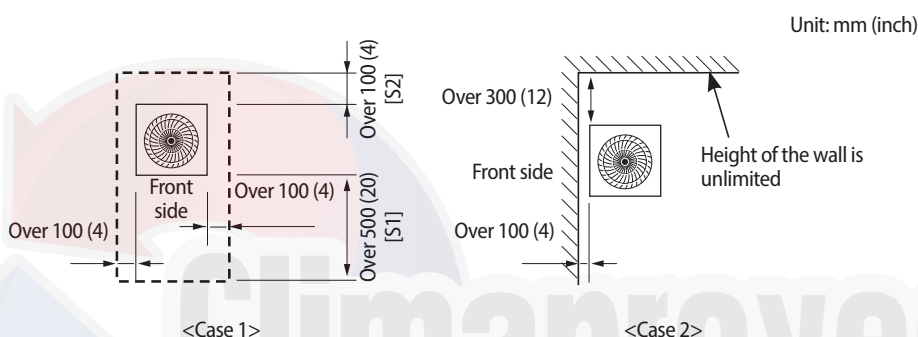

Space requirement for installation

Module installation

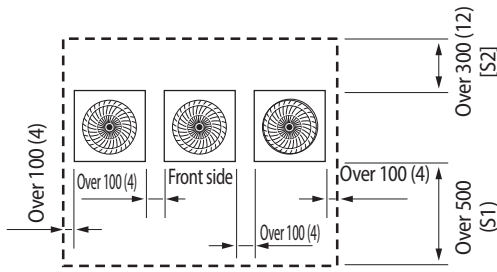

<Case 1>

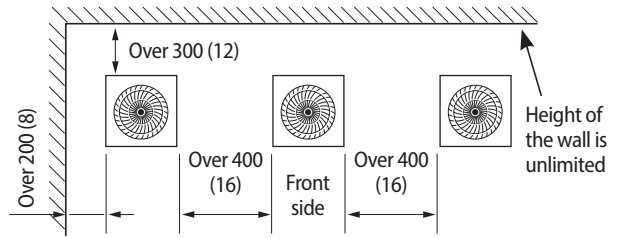

<Case 2>

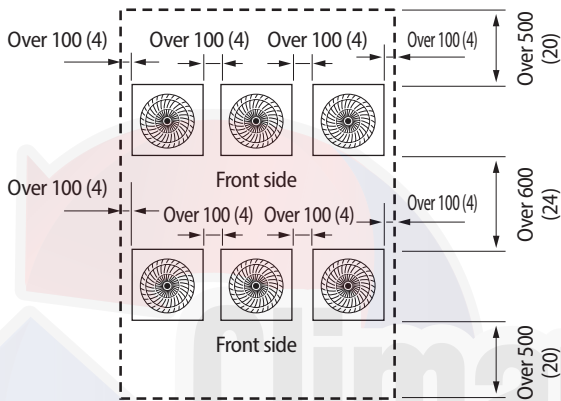

<Case 3>

* For <Case 1> or <Case 3>

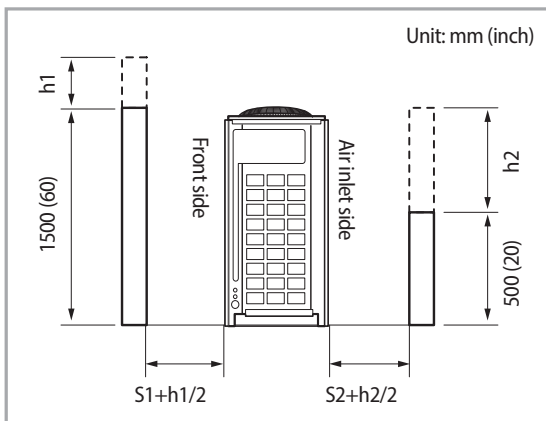

- Height of the wall on the front side should not be higher than 1500mm (60 inch).
- Height of the wall on the air inlet side should not be higher than 500mm (20 inch).
- Height of the wall on the side is not limited.
- If the height of the wall exceeds by certain value (h_1 , h_2), additional clearance $[(h_1)/2, (h_2)/2$: Half of the exceeded distance] should be added to the service space (S_1 , S_2).



Accessories

Accessories

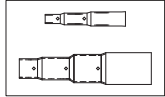
- ▶ You must keep following accessories until the installation is finished.
- ▶ Hand over the installation manual to the customer after finishing the installation.

Installation manual (1) 	*Installation socket (1) 	Brand Label (1) 	Instruction sheet (1) 
--	---	--	--

* Models with installaton socket

MODEL (AM***F*, AM***H* Series)		HR				HP		
		GAS	LIQUID	HIGH GAS	SOCKET	GAS	LIQUID	SOCKET
6TON	Pipe in Production	3/4"	3/8"	5/8"	X	3/4"	3/8"	X
	Installaton Pipe							
8TON*	Pipe in Production	1-1/8"	1/2"	7/8"	O	1"	1/2"	O
	Installaton Pipe	7/8"	3/8"	3/4"		7/8"	3/8"	
10TON	Pipe in Production	1-1/8"	1/2"	7/8"	O	1"	1/2"	O
	Installaton Pipe			3/4"		1-1/8"		
12TON	Pipe in Production	1-1/8"	5/8"	1-1/8"	O	1-1/8"	1/2"	X
	Installaton Pipe		1/2"	7/8"				
14TON	Pipe in Production	1-1/8"	5/8"	1-1/8"	O	1-1/8"	5/8"	X
	Installation Pipe			7/8"				
16TON	Pipe in Production	1-1/8"	5/8"	1-1/8"	X	1-1/8"	5/8"	X
	Installation Pipe							

MODEL (AM***K* Series)		HR				HP		
		GAS	LIQUID	HIGH GAS	SOCKET	GAS	LIQUID	SOCKET
6TON*	Pipe in Production	-	-	-	-	1-1/8"	1/2"	O
	Installaton Pipe					3/4"	3/8"	
8TON*	Pipe in Production	-	-	-	-	1-1/8"	5/8"	O
	Installaton Pipe					7/8"	3/8"	

* In case of 8TON HR, cut the socket for gas pipe and use the other part at high gas pipe.

Socket for Gas and High gas pipe
cutting line

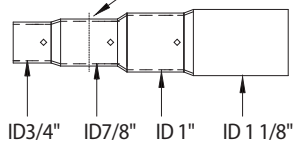

Socket for Liquid pipe

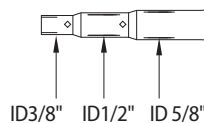

Accessories

Optional accessories

► Following optional accessories are needed for connecting pipes between the indoor and outdoor units.

Classification	Model Name	Specification	
		MBH	KW
Y-Joint	MXJ-YA1509M	51 below	15.0 and below
	MXJ-YA2512M	Over 51~136 and below	Over 15.0 ~40.0 and below
	MXJ-YA2812M	Over 136~154 and below	Over 40.0 ~45.0 and below
	MXJ-YA2815M	Over 154~240 and below	Over 45.0 ~70.3 and below
	MXJ-YA3419M	Over 240~336 and below	Over 70.3 ~98.4 and below
	MXJ-YA4119M	Over 336~461 and below	Over 98.4 ~135.2 and below
	MXJ-YA4422M	Over 461	Over 135.2
Y-Joint (Only H/R)	MXJ-YA1500M	76 and below	22.4 and below
	MXJ-YA2500M	Over 76~240 and below	Over 22.4 ~70.3 and below
	MXJ-YA3100M	Over 240~461 and below	Over 70.3 ~135.2 and below
	MXJ-YA3800M	Over 461	Over 135.2
Distribution header	MXJ-HA2512M	154 and below (for 4 rooms)	45.0 and below (for 4 rooms)
	MXJ-HA3115M	Over 240 ~ 461 and below (for 8 rooms)	Over 70.3 ~ 135.2 and below (for 8 rooms)
	MXJ-HA3819M	Over 240 (for 8 rooms)	Over 70.3 (for 8 rooms)
Y-Joint - Outdoor unit	MXJ-TA3819M	461 and below	135.2 and below
	MXJ-TA4422M	478.4 and over	140.2 and over
Y-Joint (Only H/R) - Outdoor unit	MXJ-TA3100M	461.3 and below	135.2 and below
	MXJ-TA3800M	478.4 and over	140.2 and over

* If you use an indoor unit with no internal EEV(Electric Expansion Valve), you will need an EEV kit.

* Only use the genuine accessories listed in above table and do not use imitated accessories.

Base construction and installation of the outdoor unit



- Make sure to remove the wooden pallet before installing the outdoor unit. If you do not remove the wooden pallet, there is risk of fire during welding the pipes. If the outdoor unit is installed with wooden pallet on, and it was used for long period time, wooden palette may break and cause electrical hazard or high pressure may damage the pipes.

- * Fix an outdoor unit firmly on the base ground with anchor bolts.
 - * Manufacturer is not responsible for the damage occurred by not following the installation standards.
1. Make sure that the height of the base ground is 200mm or higher to protect the outdoor unit from rain water or other external conditions. Also, install a draining pit around the base ground and connect the drain pipe to the drainage.
 2. Considering the vibration and weight of the outdoor unit, strength of the base ground must be strong to prevent noise and the top surface of it should be flat.
 3. Base ground should be 1.5 times larger than the bottom of the outdoor unit.
 4. Outdoor unit must be fixed firmly so that it can withstand the wind speed of 30m/s. If you cannot fix the outdoor unit on the base ground, fix it by side or use extra structure.
 5. In heating operation, defrost water may form so you must really care about the drainage and waterproofing the floor. To prevent defrost water from stagnating or freezing, construct a drainage with over 1/50 slope. (Ice may form on the floor in winter time.)
 6. It is necessary to add wire mesh or steel bar during concrete construction for the base ground to prevent damages or cracks.
 7. When installing multiple outdoor units at the same place, construct a H beam or an anti-vibration frame on the base ground to install the outdoor unit.
 8. After installing a H beam or an anti-vibration frame, apply corrosion protection and other necessary coating.
 9. When concrete construction for outdoor unit installation is completed, install an anti-vibration pad (t=20mm/0.78 inch or more) or an anti-vibration frame to prevent vibration of the outdoor unit from transferring to the base ground.
 10. Place the outdoor unit on a H beam or an anti-vibration frame and fix it with the bolt, nut and washer. (The bearing force has to be over 3.5kN)

Base ground construction

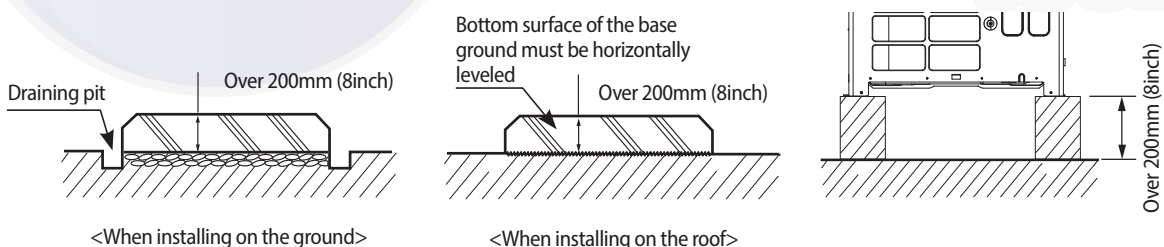

Base construction and installation of the outdoor unit

Outdoor unit installation

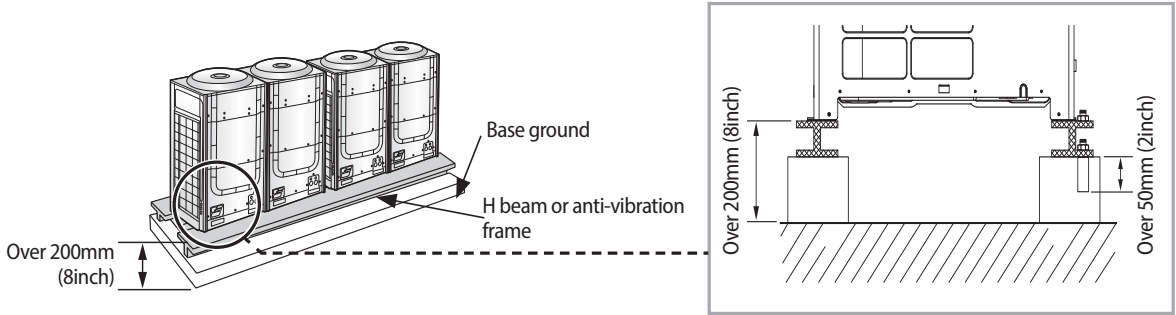

Outdoor unit base mount and anchor bolt position

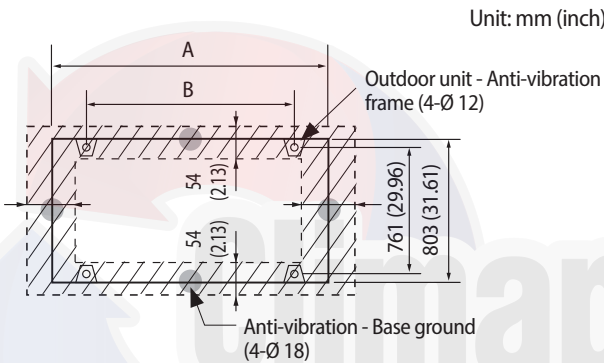

Unit: mm (inch)

Classification	Small type	Large type
Models	AM072F*	AM096/120/144F*, AM168/192H*, AM072/096K*
A	880 (34.65)	1,295 (50.98)
B	740 (29.13)	1,150 (45.28)

* Refer to the blueprints in technical data book to make a holes for connecting the anti-vibration pad.

Examples of draining work

- ▶ Construct the drainage ditch with reinforced concretes and make sure that water-proofing work is done.
- ▶ For smooth draining of defrost water, make sure to apply 1/50 slope.
- ▶ Construct a drainage around the outdoor unit to prevent the defrost water (from the outdoor unit) from stagnating, overflowing or freezing near the installation space.
- ▶ When the outdoor unit is installed on the roof, check the strength and waterproof status of the roof.

Unit: mm (inch)

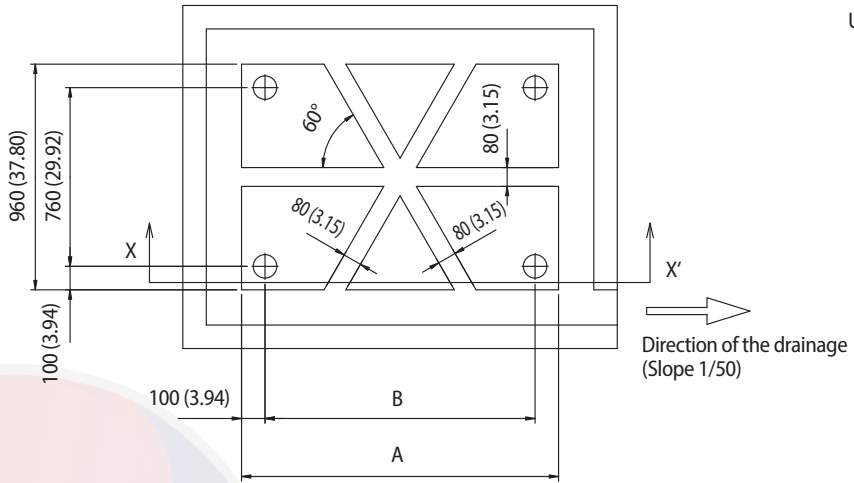

<Drainage work for single installation>

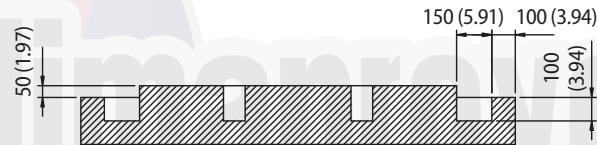

<X-X' SECTION>

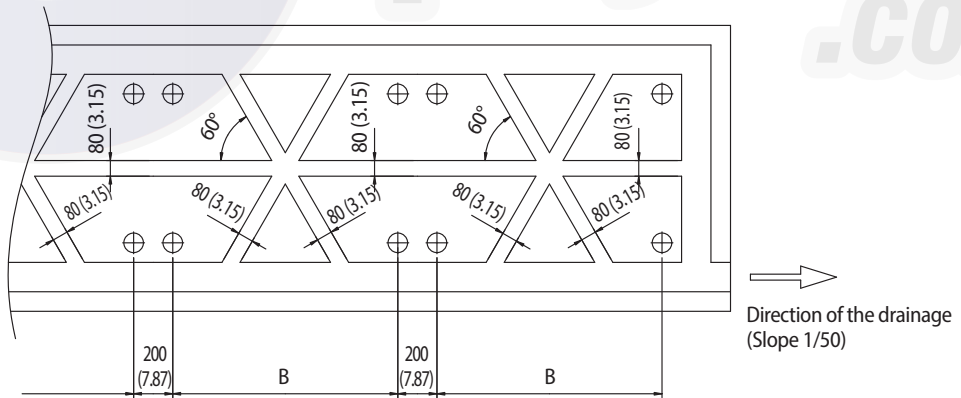

<Drainage work for module installation>

Unit: mm (inch)

Classification	Small type	Large type
Models	AM072F*	AM096/120/144F*, AM168/192H*, AM072/096K*
A	940 (37.01)	1,350 (53.15)
B	740 (29.13)	1,150 (45.28)

Base construction and installation of the outdoor unit



Cautions regarding on connecting the anchor bolt

CAUTION

- ▶ Tighten the rubber washer to prevent the bolt connection part of the outdoor unit from corroding.

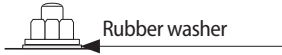

Rubber washer

- ▶ Anchor specification

Size	Diameter of drill bit (a)	Anchor length (b)	Sleeve length (b)	Insert depth	Fastening torque
Ø 10	14mm (1/2")	75mm (3")	40mm (1-1/2")	50mm (2")	30 N·m

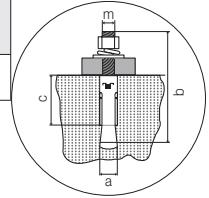

- * Use the anchor bolts and nuts that is zinc plated or made of STS material. Regular anchor bolts or nuts may get damaged by corrosion.

Cautions regarding on connecting the pipe

- ▶ If you install the outdoor unit on the rooftop, check the strength and make sure to waterproof the rooftop.
- ▶ Construct draining pit around the base construction and pay attention to the drainage around the outdoor unit. (Condensation or defrost water may form during outdoor unit operation.)
- ▶ If there's any possibility of small animals from entering the pipe outlet, block the outlet as shown in the illustration.

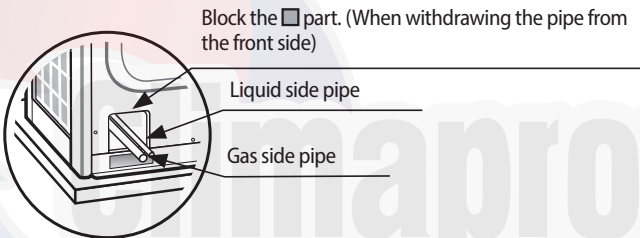

Cautions regarding on anti-vibration frame installation

- ▶ During installation, make sure there is no gap between the base ground and the supporting structures such as anti-vibration frame or H beam.
- ▶ Base ground must be constructed strongly to support the bottom part of the anti-vibration mount.

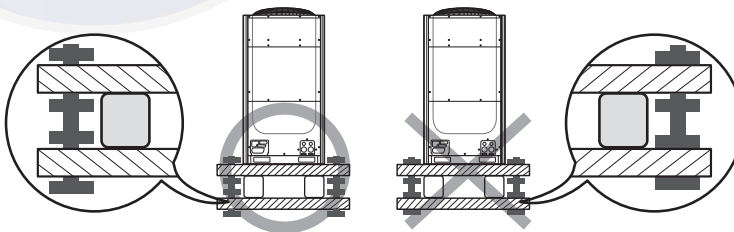

- ▶ After installing the anti-vibration frame, untighten the fixing part on the top and bottom part of the frame.

**Caution for installing discharge duct**

- ▶ Static pressure of the discharge duct should be within the standard specification 78.45 Pa (0.315 W.G) when installing the duct.
- ▶ If you remove the fan guard to install the discharge duct, make sure to install a safety net on the duct outlet. Foreign substance may enter into the product and there could be a risk of personal injury.
- ▶ Wear protection equipment at all times when making galvanized sheet metal duct, since the worker may get injured by the sharp parts.
- ▶ When installing the outdoor unit under the tree or near forest, leafs may get into the product and cause problems on the product. Therefore, install a discharge duct to prevent foreign substance infiltration.

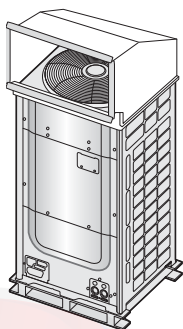

<Protecting discharge duct>

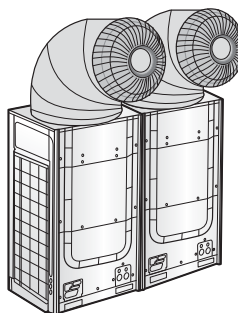

<Preventing foreign substance infiltration>

Climaproyectos
.com

Installing the wind/snow prevention duct

Installing the outdoor unit around the obstacles

- ▶ It is necessary to install a wind/snow prevention duct (field supply) to direct exhaust from the fan horizontally, when it is difficult to provide a minimum space of 2m (6.56ft) between the air outlet and a nearby obstacle.

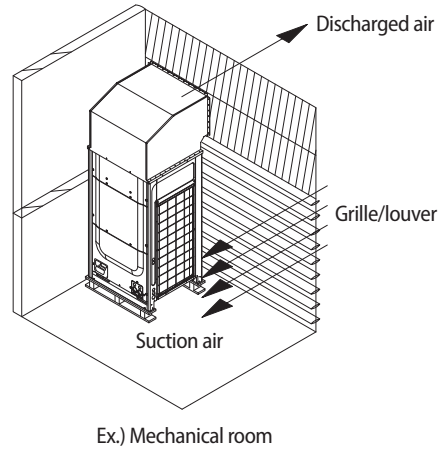
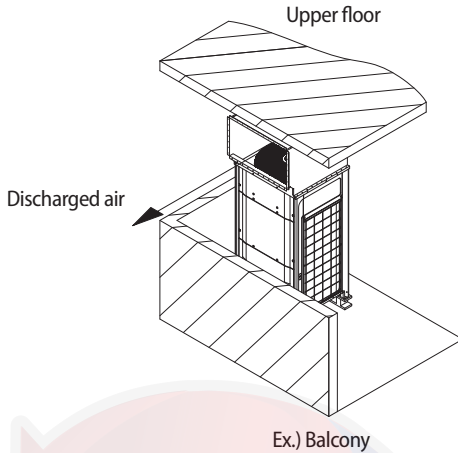

Installing the outdoor unit in cold region

- ▶ In cold regions with lots of snowfall, install a snow prevention duct, as a sufficient countermeasure, to prevent snow from accumulating on the outdoor unit. When the snow prevention duct is not installed, frost may accumulate on the heat exchanger and heating operation may not work normally.
- ▶ Air outlet of the duct should not be directed to the enclosed space.



CAUTION

Caution regarding on installing the frame and selecting the base ground

- Height (h) of the frame and the base ground should be higher than the "heaviest expected snowfall".
- Area of the frame and the base ground should not be larger than the area of the outdoor unit. Snow may accumulate if the area of the frame or the base ground is larger.

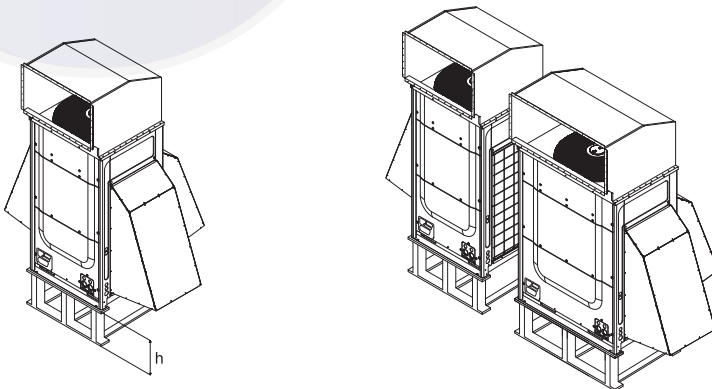

Installing the outdoor unit in windy region

- ▶ In windy regions such as near sea shores, protection wall or wind protection duct must be installed for normal operation of the outdoor unit. (Refer to the illustration of the snow prevention duct, for installing the wind protection duct.)
- ▶ Install the wind prevention duct with the consideration of major wind direction. If the direction of the discharge part is same as major direction of the wind, it could cause product's performance decrease.



Cautions regarding on installing the frame and selecting the base ground

- The base ground must be solid and the outdoor unit must be fixed with anchor bolts.
- Make sure to install outdoor unit in a place strong enough to withstand its weight. If the place cannot withstand the weight of the outdoor unit, outdoor unit may fall and cause personal injury.
- When installing on a rooftop subject to strong wind, countermeasures must be taken to prevent the unit from falling down.
- Use a frame that is resistant to corrosion.

Unit: mm (inch)

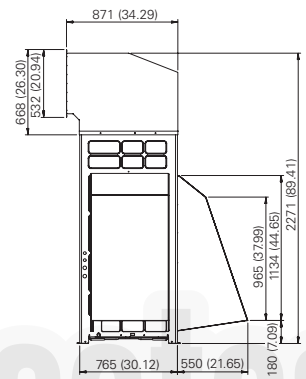
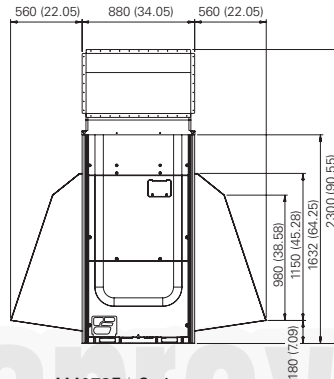
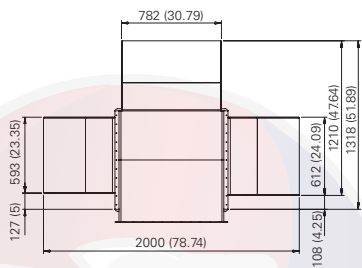

<AM072F*Series>

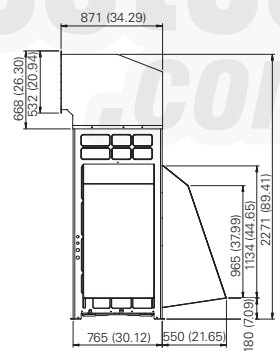
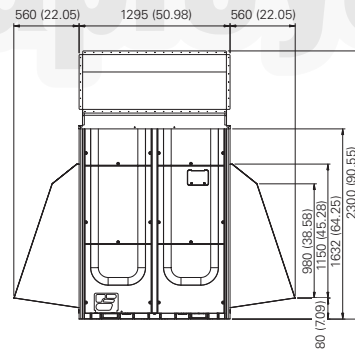
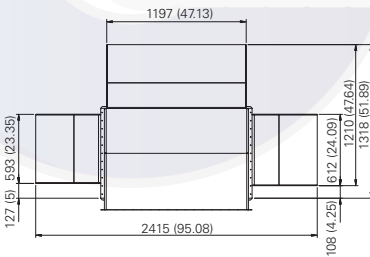

<AM096/120/144F*, AM168/192H*, AM072/096K* Series>

Refrigerant pipe installation



- When installing, make sure there is no leakage. When collecting the refrigerant, stop the compressor first before removing the connection pipe. If the refrigerant pipe is not properly connected and the compressor works with the service valve open, the pipe inhales the air and it makes the pressure inside of the refrigerant cycle abnormally high which may lead to explosion and injury.

Refrigerant pipe work

- ▶ The length of refrigerant pipe should be as short as possible and the height difference between an indoor and outdoor unit should be minimized.
- ▶ Piping work must be done within allowable piping length, height difference, and the allowable length after branching.
- ▶ The pressure of the R-410A is high. Use only certified refrigerant pipe and follow the installation method.
- ▶ After installing the pipes, calculate the total length of the pipe to check if additional refrigerant is needed. When you need to charge the additional refrigerant, make sure to use R-410A refrigerant.
- ▶ Use clean refrigerant pipe and there shouldn't be any harmful ion, oxide, dust, iron content or moisture inside pipe.
- ▶ Use tools and accessories that fit on R-410A only.

Tool	Installation process/purpose	Compatibility with conventional tool
Pipe cutter	Refrigerant pipe installation	Compatible
Flaring tool		
Refrigerant machine oil		Apply refrigerant oil on flared part
Torque wrench	Air tightness test	Compatible
Pipe bender		
Nitrogen gas		
Welder		
Manifold gage	Air tightness test ~ additional refrigerant charging	Need exclusive one to prevent mixture of R-22 refrigerant oil use and also the measurement is not available due to high pressure
Refrigerant charging hose		
Vacuum pump	Pipe drying	Compatible (Use products which contain the check valve to prevent the oil from flowing backward into the outdoor unit.) Use the one that can be vacuumed up to -100.7kpa(5Torr).
Scale for refrigerant charging	Charging refrigerant	Compatible
Gas leak detector	Gas leak test	Need exclusive one (Ones used for R-134a is compatible)
Flare nut	Must use the flare nut equipped with the product. Refrigerant leakage may occur when the conventional flare nut for R-22 is used.	

Selecting refrigerant pipe

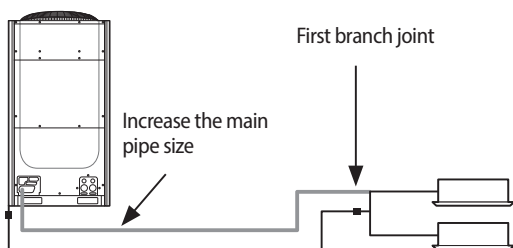

- ▶ Install the refrigerant pipe according to main pipe size of each outdoor unit capacity.
- ▶ When the pipe length (including elbow) between an outdoor unit and the farthest indoor unit exceeds 90m (295.28ft), you must increase the size of the pipe (main pipe) by one grade which connects between the outdoor unit to the first branch joint.
- ▶ For H/R model, When the pipe length (including elbow) between an outdoor unit and the farthest indoor unit exceeds 90m, you must increase the size of the liquid pipe by one grade among the pipes(main pipe) which connects between the outdoor unit to the first branch joint.

Climaproyectos
.com

Refrigerant pipe installation

H/P

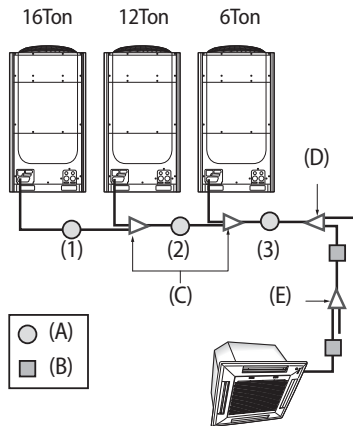

Ex.) 34 Ton

Ton	No.	Pipe size (O.D)			
		Liquid pipe		Gas pipe	
		mm	inch	mm	inch
16	(1)	15.88	5/8	28.58	1 1/8
28	(2)	19.05	3/4	34.92	1 3/8
34	(3)	19.05	3/4	41.28	1 5/8

Size of the pipe connected to the outdoor unit (A)

Select the size of the pipe according to the below table.

Outdoor unit capacity			Main pipe length within 90m (295.3ft)				Size up(Main pipe length over 90m (295.3ft))			
Ton	MBH	KW	Liquid		Gas		Liquid		Gas	
			mm	inch	mm	inch	mm	inch	mm	inch
6	72	21.1	9.52	3/8	19.05	3/4	12.7	1/2	22.22	7/8
8	96	28.1	9.52	3/8	22.22	7/8	12.7	1/2	25.4	1 note1)
10	120	35.2	12.7	1/2	28.58	1 1/8	15.88	5/8	28.58	1 1/8
12	144	42.2	12.7	1/2	28.58	1 1/8	15.88	5/8	31.75	1 1/4 note2)
14	168	49.2	15.88	5/8	28.58	1 1/8	19.05	3/4	31.75	1 1/4 note2)
16	192	56.3	15.88	5/8	28.58	1 1/8	19.05	3/4	31.75	1 1/4 note2)
18	216	63.3	15.88	5/8	28.58	1 1/8	19.05	3/4	31.75	1 1/4 note2)
20	240	70.3	15.88	5/8	28.58	1 1/8	19.05	3/4	31.75	1 1/4 note2)
22	264	77.4	19.05	3/4	34.92	1 3/8	22.22	7/8	38.1	1 1/2 note3)
24	288	84.4	19.05	3/4	34.92	1 3/8	22.22	7/8	38.1	1 1/2 note3)
26	312	91.4	19.05	3/4	34.92	1 3/8	22.22	7/8	38.1	1 1/2 note3)
28	336	98.4	19.05	3/4	34.92	1 3/8	22.22	7/8	38.1	1 1/2 note3)
30	360	105.5	19.05	3/4	41.28	1 5/8	22.22	7/8	41.28	1 5/8
32	384	112.5	19.05	3/4	41.28	1 5/8	22.22	7/8	41.28	1 5/8
34	408	119.5	19.05	3/4	41.28	1 5/8	22.22	7/8	41.28	1 5/8
36	432	126.6	19.05	3/4	41.28	1 5/8	22.22	7/8	41.28	1 5/8
38	456	133.6	19.05	3/4	41.28	1 5/8	22.22	7/8	41.28	1 5/8
40	480	140.7	19.05	3/4	41.28	1 5/8	22.22	7/8	41.28	1 5/8
42	504	147.7	19.05	3/4	41.28	1 5/8	22.22	7/8	41.28	1 5/8
44	528	154.7	19.05	3/4	41.28	1 5/8	22.22	7/8	41.28	1 5/8

Note1) If 1" (25.4mm) pipe is not available on site, use 1 1/8" (28.58mm) pipe.

Note2) If 1 1/4" (31.75mm) pipe is not available on site, use 1 3/8" (34.92mm) pipe.

Note3) If 1 1/2" (38.1mm) pipe is not available on site, use 1 5/8" (41.28mm) pipe.

Size of the pipe between branch joints (B)

Select the pipe size according to the sum of indoor unit capacity which will be connected after the branch.

Indoor unit capacity		Branch pipe length within 45m(147.6ft) ^{note1)}				Branch pipe length between 45~90m(147.6~295.3ft) ^{note1)}			
		Liquid		Gas		Liquid		Gas	
MBH	KW	mm	inch	mm	inch	mm	inch	mm	inch
~51	~15.0	9.52	3/8	15.88	5/8	12.7	1/2	19.05	3/4
51~76	15.0~22.4	9.52	3/8	19.05	3/4	12.7	1/2	22.22	7/8
76~96	22.4~28.1	9.52	3/8	22.22	7/8	12.7	1/2	25.4	1 ^{note2)}
96~136	28.1~40.0	12.7	1/2	28.58	1 1/8	15.88	5/8	28.58	1 1/8
136~154	40.0~45.0	12.7	1/2	28.58	1 1/8	15.88	5/8	31.75	1 1/4 ^{note3)}
154~240	45.0~70.3	15.88	5/8	28.58	1 1/8	19.05	3/4	31.75	1 1/4 ^{note3)}
240~336	70.3~98.4	19.05	3/4	34.92	1 3/8	22.22	7/8	38.1	1 1/2 ^{note4)}
336~461	98.4~135.2	19.05	3/4	41.28	1 5/8	22.22	7/8	41.28	1 5/8
461~577	135.2~169	19.05	3/4	41.28	1 5/8	22.22	7/8	53.98	2 1/8
577~	169.0~	22.22	7/8	53.98	2 1/8	25.40	1	53.98	2 1/8

Note1) **Note on measuring distance between branch joints (B)** : You must measure the distance between first branch joint to the last indoor unit. (NOT from first joint to the last branch joint)

Note2) If 1" (25.4mm) pipe is not available on site, use 1 1/8" (28.58mm) pipe.

Note3) If 1 1/4" (31.75mm) pipe is not available on site, use 1 3/8" (34.92mm) pipe.

Note4) If 1 1/2" (38.1mm) pipe is not available on site, use 1 5/8" (41.28mm) pipe.

Size of the pipe between the branch joint and the indoor unit

Make a selection according to outdoor unit capacity.

Indoor unit capacity		Pipe Size(O.D)			
		Liquid		Gas	
MBH	KW	mm	inch	mm	inch
~20	~6.0	6.35	1/4	12.7	1/2
24~52	7.1~16.0	9.52	3/8	15.88	5/8
68~78	20.0~23.0	9.52	3/8	19.05	3/4
78~96	23.0~29.0	9.52	3/8	22.22	7/8

Refrigerant pipe installation

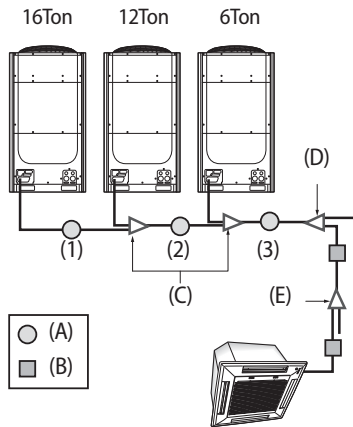

Branch joint

- ▶ Branch joint between outdoor units (C)

Classification	Model name	Specification	
		MBH	kW
Y-joint for outdoor unit (C)	MXJ-TA3819M	461 and below	135.2 and below
	MXJ-TA4422M	478 and over	140.2 and over

- ▶ First branch joint (D)
Make a selection according to outdoor unit capacity.

Classification	Model name	Outdoor unit capacity	
		MBH	kW
Y-joint (D)	MXJ-YA2512M	Over 51 ~ 136 and below	Over 15.0 ~ 40.0 and below
	MXJ-YA2812M	Over 136 ~ 154 and below	Over 40.0 ~ 45.0 and below
	MXJ-YA2815M	Over 154 ~ 240 and below	Over 45.0 ~ 70.3 and below
	MXJ-YA3419M	Over 240 ~ 336 and below	Over 70.3 ~ 98.4 and below
	MXJ-YA4119M	Over 336 ~ 461 and below	Over 98.4 ~ 135.2 and below
	MXJ-YA4422M	Over 461	Over 135.2

► Branch joint (E)

Select a branch joint according to the sum of indoor unit capacity which will be connected after the branch.

1) Y-joint

Classification	Model name	Specification	
		MBH	kW
Y-joint (E)	MXJ-YA1509M	51 and below	15.0 and below
	MXJ-YA2512M	Over 51 ~ 136 and below	Over 15.0 ~ 40.0 and below
	MXJ-YA2812M	Over 136 ~ 154 and below	Over 40.0 ~ 45.0 and below
	MXJ-YA2815M	Over 154 ~ 240 and below	Over 45.0 ~ 70.3 and below
	MXJ-YA3419M	Over 240 ~ 336 and below	Over 70.3 ~ 98.4 and below
	MXJ-YA4119M	Over 336 ~ 461 and below	Over 98.4 ~ 135.2 and below
	MXJ-YA4422M	Over 461	Over 135.2

2) Distribution header

Classification	Model name	Specification	
		MBH	kW
Distribution header (E)	MXJ-HA2512M	154 and below (for 4 rooms)	45.0 and below (for 4 rooms)
	MXJ-HA3115M	240 and below (for 8 rooms)	70.3 and below (for 8 rooms)
	MXJ-HA3819M	Over 240 (for 8 rooms)	Over 70.3 (for 8 rooms)

Refrigerant pipe installation

H/R

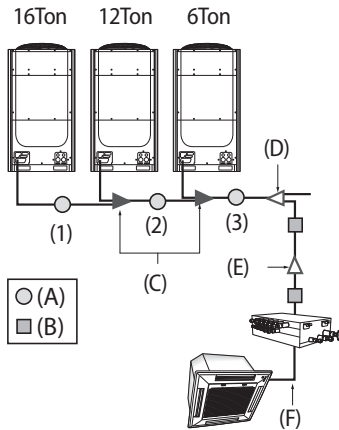

Ex.) 34 Ton

Ton	No.	Pipe size (O.D)					
		Liquid		Gas		High pressure Gas	
		mm	inch	mm	inch	mm	inch
10	(1)	15.88	5/8	28.58	1 1/8	28.58	1 1/8
28	(2)	19.05	3/4	34.92	1 3/8	28.58	1 1/8
34	(3)	19.05	3/4	41.28	1 5/8	34.92	1 3/8

Size of the pipe connected to the outdoor unit (A)

Select the size of the pipe according to the below table.

Outdoor unit capacity			Main pipe length within 90m (295.3ft)						Size up(Main pipe length over 90m (295.3ft))					
Ton	MBH	KW	Liquid		Gas		High pressure Gas		Liquid		Gas		High pressure Gas	
			mm	inch	mm	inch	mm	inch	mm	inch	mm	inch	mm	inch
6	72	21.1	9.52	3/8	19.05	3/4	15.88	5/8	12.7	1/2	19.05	3/4	15.88	5/8
8	96	28.1	9.52	3/8	22.22	7/8	19.05	3/4	12.7	1/2	22.22	7/8	19.05	3/4
10	120	35.2	12.7	1/2	28.58	1 1/8	22.22	7/8	15.88	5/8	28.58	1 1/8	22.22	7/8
12	144	42.2	12.7	1/2	28.58	1 1/8	22.22	7/8	15.88	5/8	28.58	1 1/8	22.22	7/8
14	168	49.2	15.88	5/8	28.58	1 1/8	22.22	7/8	19.05	3/4	28.58	1 1/8	22.22	7/8
16	192	56.3	15.88	5/8	28.58	1 1/8	28.58	1 1/8	19.05	3/4	28.58	1 1/8	28.58	1 1/8
18	216	63.3	15.88	5/8	28.58	1 1/8	28.58	1 1/8	19.05	3/4	28.58	1 1/8	28.58	1 1/8
20	240	70.3	15.88	5/8	28.58	1 1/8	28.58	1 1/8	19.05	3/4	28.58	1 1/8	28.58	1 1/8
22	264	77.4	19.05	3/4	34.92	1 3/8	28.58	1 1/8	22.22	7/8	34.92	1 3/8	28.58	1 1/8
24	288	84.4	19.05	3/4	34.92	1 3/8	28.58	1 1/8	22.22	7/8	34.92	1 3/8	28.58	1 1/8
26	312	91.4	19.05	3/4	34.92	1 3/8	28.58	1 1/8	22.22	7/8	34.92	1 3/8	28.58	1 1/8
28	336	98.4	19.05	3/4	34.92	1 3/8	28.58	1 1/8	22.22	7/8	34.92	1 3/8	28.58	1 1/8
30	360	105.5	19.05	3/4	41.28	1 5/8	34.92	1 3/8	22.22	7/8	41.28	1 5/8	34.92	1 3/8
32	384	112.5	19.05	3/4	41.28	1 5/8	34.92	1 3/8	22.22	7/8	41.28	1 5/8	34.92	1 3/8
34	408	119.5	19.05	3/4	41.28	1 5/8	34.92	1 3/8	22.22	7/8	41.28	1 5/8	34.92	1 3/8
36	432	126.6	19.05	3/4	41.28	1 5/8	34.92	1 3/8	22.22	7/8	41.28	1 5/8	34.92	1 3/8
38	456	133.6	19.05	3/4	41.28	1 5/8	34.92	1 3/8	22.22	7/8	41.28	1 5/8	34.92	1 3/8
40	480	140.7	19.05	3/4	41.28	1 5/8	34.92	1 3/8	22.22	7/8	41.28	1 5/8	34.92	1 3/8
42	504	147.7	19.05	3/4	41.28	1 5/8	34.92	1 3/8	22.22	7/8	41.28	1 5/8	34.92	1 3/8
44	528	154.7	19.05	3/4	41.28	1 5/8	34.92	1 3/8	22.22	7/8	41.28	1 5/8	34.92	1 3/8

* For HR model, only increase the size of the liquid pipe if pipe length exceeds 90m

Size of the pipe between branch joints (B)

Select the pipe size according to the sum of indoor unit capacity which will be connected after the branch.

Indoor unit capacity		Pipe size (O.D)					
		Liquid		Gas		High pressure Gas	
MBH	KW	mm	inch	mm	inch	mm	inch
~51	~15.0	9.52	3/8	15.88	5/8	15.88	5/8
51~76	15.0~22.4	9.52	3/8	19.05	3/4	15.88	5/8
76~96	22.4~28.1	9.52	3/8	22.22	7/8	19.05	3/4
96~115	28.1~33.6	12.7	1/2	28.58	1 1/8	19.05	3/4
115~154	33.6~45.0	12.7	1/2	28.58	1 1/8	22.22	7/8
154~172	45.0~50.4	15.88	5/8	28.58	1 1/8	22.22	7/8
172~240	50.4~70.3	15.88	5/8	28.58	1 1/8	28.58	1 1/8
240~336	70.3~98.4	19.05	3/4	34.92	1 3/8	28.58	1 1/8
336~360	98.4~105.5	19.05	3/4	41.28	1 5/8	28.58	1 1/8
360~461	105.5~135.2	19.05	3/4	41.28	1 5/8	34.92	1 3/8
461~577	135.2~169	19.05	3/4	41.28	1 5/8	34.92	1 3/8
577 ~	169.0 ~	22.22	7/8	53.98	2 1/8	41.28	1 5/8

Size of the pipe between the branch joint and the indoor unit

Make a selection according to outdoor unit capacity.

Indoor unit capacity		Pipe Size(O.D)			
		Liquid		Gas	
MBH	KW	mm	inch	mm	inch
~20	~6.0	6.35	1/4	12.7	1/2
24~52	7.1~16.0	9.52	3/8	15.88	5/8
68~78	20.0~23.0	9.52	3/8	19.05	3/4
78~96	23.0~29.0	9.52	3/8	22.22	7/8

Refrigerant pipe installation

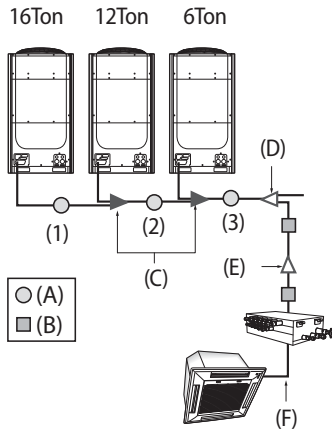

Branch joint

- ▶ Branch joint between outdoor units (C)

Classification	Model name	Specification	
		MBH	kW
Liquid/Low pressure Y-joint (C)	MXJ-TA3819M	461 and below	135.2 and below
	MXJ-TA4422M	478 and over	140.2 and over
High pressure Y-joint (C)	MXJ-TA3100M	461 and below	135.2 and below
	MXJ-TA3800M	478 and over	140.2 and over

- ▶ First branch joint (D)
Make a selection according to outdoor unit capacity.

Classification	Model name	Outdoor unit capacity	
		MBH	kW
Liquid/Low pressure Y-joint (D)	MXJ-YA2512M	Over 51 ~ 136 and below	Over 15.0 ~ 40.0 and below
	MXJ-YA2812M	Over 136 ~ 154 and below	Over 40.0 ~ 45.0 and below
	MXJ-YA2815M	Over 154 ~ 240 and below	Over 45.0 ~ 70.3 and below
	MXJ-YA3419M	Over 240 ~ 336 and below	Over 70.3 ~ 98.4 and below
	MXJ-YA4119M	Over 336 ~ 461 and below	Over 98.4 ~ 135.2 and below
	MXJ-YA4422M	Over 461	Over 135.2
High pressure Y-joint (D)	MXJ-YA1500M	76 and below	22.4 and below
	MXJ-YA2500M	Over 76 ~ 240 and below	Over 22.4 ~ 70.3 and below
	MXJ-YA3100M	Over 240 ~ 461 and below	Over 70.3 ~ 135.2 and below
	MXJ-YA3800M	Over 461	Over 135.2

► Branch joint (E)

Select a branch joint according to the sum of indoor unit capacity which will be connected after the branch.

- Y-joint

Classification	Model name	Specification	
		MBH	kW
Y-joint (E)	MXJ-YA1509M	51 and below	15.0 and below
	MXJ-YA2512M	Over 51 ~ 136 and below	Over 15.0 ~ 40.0 and below
	MXJ-YA2812M	Over 136 ~ 154 and below	Over 40.0 ~ 45.0 and below
	MXJ-YA2815M	Over 154 ~ 240 and below	Over 45.0 ~ 70.3 and below
	MXJ-YA3419M	Over 240 ~ 336 and below	Over 70.3 ~ 98.4 and below
	MXJ-YA4119M	Over 336 ~ 461 and below	Over 98.4 ~ 135.2 and below
	MXJ-YA4422M	Over 461	Over 135.2
Y-joint (E) (Only H/R)	MXJ-YA1500M	76 and below	22.4 and below
	MXJ-YA2500M	Over 76 ~ 240 and below	Over 22.4 ~ 70.3 and below
	MXJ-YA3100M	Over 240 ~ 461 and below	Over 70.3 ~ 135.2 and below
	MXJ-YA3800M	Over 461	Over 135.2

Climaproyectos.com

- ▶ Amount of additional refrigerant depending on the pipe size (a)
 - Amount of additional refrigerant has to be calculated based on the sum of all liquid pipe length.

Size of liquid pipe [mm (inch)]	Ø6.35 (Ø1/4)	Ø9.52 (Ø3/8)	Ø12.70 (Ø1/2)	Ø15.88 (Ø5/8)	Ø19.05 (Ø3/4)	Ø22.23 (Ø7/8)	Ø25.40 (Ø1)
Additional amount [kg/m (lb/ft)]	0.02 (0.013)	0.06 (0.040)	0.125 (0.084)	0.18 (0.121)	0.27 (0.181)	0.35 (0.235)	0.53 (0.356)

- For the indoor unit already connected to EEV kit, the additional refrigerant charging is 0.0067lb per feet regardless of the pipe size.

- ▶ Amount of additional refrigerant for each indoor unit (b)

(Unit : kg(lb))

Model	Capacity (kBtu)																			
	6	7.5	9	9.5	12	15	18	20	24	27	30	36	48	54	60	72	76.8	96		
1way cassette (AM***FN1DC*)		0.25 (0.55)		0.25 (0.55)	0.25 (0.55)															
4way cassette S(600x600) (AM***FNNDC*)			0.37 (0.82)		0.37 (0.82)		0.37 (0.82)	0.37 (0.82)												
4way cassette S(AM***FN4DC*)			0.45 (0.99)		0.45 (0.99)		0.45 (0.99)		0.45 (0.99)		0.69 (1.52)	0.69 (1.52)	0.69 (1.52)							
Floor Standing Unit (AM***JNFDC*), (AM***JNGDC*)	0.12 (0.26)		0.22 (0.49)		0.22 (0.49)		0.32 (0.72)		0.32 (0.72)											
Slim duct (AM***FNLDC*)		0.24 (0.53)		0.24 (0.53)	0.24 (0.53)		0.45 (0.99)		0.45 (0.99)		0.45 (0.99)	0.45 (0.99)	0.62 (1.37)							
MA duct (AM***JNMDC*)		0.37 (0.81)	0.37 (0.81)		0.37 (0.81)	0.54 (1.19)	0.54 (1.19)		0.47 (1.04)	0.47 (1.04)	0.47 (1.04)	0.68 (1.50)	0.68 (1.50)							
MSP duct (AM***FNMDC*)							0.28 (0.62)		0.28 (0.62)		0.54 (1.19)	0.54 (1.19)	0.68 (1.50)							
HSP duct (AM***FNHDC*)												0.68 (1.50)	0.68 (1.50)					1.18 (2.60)	1.18 (2.60)	
Wall mounted (AM***FNTDC*)		0.24 (0.53)		0.24 (0.53)	0.24 (0.53)		0.36 (0.79)	0.36 (0.79)	0.36 (0.79)											
Ceiling (AM***FNCDC*), (AM***JNCDC*)							0.39 (0.86)		0.39 (0.86)			0.56 (1.23)	0.95 (2.09)							
V-AHU (AM***JNZDC*)					0.33 (0.73)		0.5 (1.10)		0.5 (1.10)		0.83 (1.83)	0.88 (1.94)	1.18 (2.60)	1.27 (2.80)	1.69 (3.73)	1.69 (3.73)			1.18 (2.60)	
OAP Duct (AM***JNESC*)																			1.18 (2.60)	1.18 (2.60)

- ▶ Additional refrigerant charging of MCU is 0.5kg (1.1lb) for every MCU kit
- ▶ If AHU Kit is included among the indoor units, add 0.018kg(0.04lb) of refrigerant for every 1MBH of AHU capacity increase.

Refrigerant pipe installation

- ▶ Method to calculate total amount of additional refrigerant
 - Amount of additional refrigerant depending on the pipe length (a)
 - Amount of additional refrigerant for each indoor unit (b) = Σ (Amount of additional refrigerant for each connected indoor unit) * Refer to the table
 - Total amount of additional refrigerant = a+b
- * Sum of total amount of additional refrigerant and the basic amount of refrigerant should not exceed 100kg (220lb). If the refrigerant exceeds 100kg (220lb), separate the module so that weight of the refrigerant doesn't exceed 100kg (220lb).
Ex.) For AM144***, basic amount of refrigerant is 8.7kg (19.1lb), therefore total amount of additional refrigerant (a+b) should not exceed 91.3kg (200.9lb).
- ▶ Example of refrigerant calculation for HP models

Classification	Size of liquid pipe [mm (inch)]	Length [m (ft)]	Unit amount of refrigerant [kg/m (lb/ft)]	Amount of additional refrigerant [kg (lb)]	Total amount of additional refrigerant [kg (lb)]
		①	②	①×②	Σ (①×②)
Liquid pipe (a)	Ø6.35 (Ø1/4)	35 (114.8)	0.02 (0.013)	0.7 (1.49)	5.575 (12.19)
	Ø9.52 (Ø3/8)	50 (164.0)	0.06 (0.040)	3.0 (6.56)	
	Ø12.70 (Ø1/2)	15 (49.2)	0.125 (0.084)	1.875 (4.13)	

Classification	Model name of indoor unit	Number of units	Unit amount of refrigerant [kg/EA (lb/EA)]	Amount of additional refrigerant [kg (lb)]	Total amount of additional refrigerant [kg (lb)]
		①	②	①×②	Σ (①×②)
Indoor unit (b)	4way cassette (AM018FN4DCH)	4	0.45 (0.99)	1.8 (3.96)	b) 3.30 (7.26)
	Slim duct (AM024FNLDCH)	2	0.45 (0.99)	0.90 (1.98)	
	Slim duct (AM012FNLDCH)	1	0.35 (0.77)	0.35 (0.77)	
	1way cassette (AM012FN1DCH)	1	0.25 (0.55)	0.25 (0.55)	

- Total amount of refrigerant (a+b) = 5.575 + 3.30 = 8.875 (kg)
= 12.19 + 7.26 = 19.45 (lb)

- ▶ Example of refrigerant calculation for HR models

Classification	Size of liquid pipe [mm (inch)]	Length [m (ft)]	Unit amount of refrigerant [kg/m (lb/ft)]	Amount of additional refrigerant [kg (lb)]	Total amount of additional refrigerant [kg (lb)]
		①	②	①×②	Σ (①×②)
Liquid pipe (a)	Ø 6.35 (Ø 1/4)	15 (49.2)	0.02 (0.013)	0.3 (0.64)	a) 11.965 (26.24)
	Ø 9.52 (Ø 3/8)	112 (367.5)	0.06 (0.040)	6.72 (14.70)	
	Ø 12.70 (Ø 1/2)	25 (82.0)	0.125 (0.084)	3.125 (6.89)	
	Ø 15.88 (Ø 5/8)	10 (32.8)	0.18 (0.121)	1.8 (3.97)	
	Ø 6.35 (Ø 1/4) (EEV Kit ~ indoor unit)	2 (6.6)	0.01 (0.0067)	0.02 (0.04)	

Classification	Model name of indoor unit	Number of units	Unit amount of refrigerant (kg/EA)	Amount of additional refrigerant (kg)	Total amount of additional refrigerant (kg)
		①	②	①×②	Σ(①×②)
Indoor unit (b)	4way cassette (AM024FN4DC*)	4	0.45 (0.99)	1.8 (3.96)	b) 5.11 (11.25)
	4way cassette (AM036FN4DC*)	3	0.69 (1.52)	2.07 (4.56)	
	Wall mounted (AM012FNTDC*)	1	0.24 (0.53)	0.24 (0.53)	
	MCU	2	0.50 (1.10)	1 (2.20)	

- Total amount of refrigerant (a)+b) = 11.965+5.11=17.075 (kg)
= 26.24+11.25=37.49 (lb)

Temper grade and minimum thickness of the refrigerant pipe

Outer diameter		Minimum thickness		Temper grade
mm	inch	mm	inch	
6.35	1/4	0.70	0.028	Annealed
9.52	3/8	0.70	0.028	
12.70	1/2	0.80	0.031	
15.88	5/8	1.00	0.039	
19.05	3/4	0.90	0.035	
22.22	7/8	0.90	0.035	
25.40	1	1.00	0.039	
28.58	1 1/8	1.10	0.043	Drawn
31.75	1 1/4	1.10	0.043	
34.92	1 3/8	1.21	0.048	
38.10	1 1/2	1.35	0.053	
41.28	1 5/8	1.43	0.056	
44.45	1 3/4	1.60	0.063	
50.80	2	2.00	0.079	
53.98	2 1/8	2.10	0.083	



- For pipes larger than Ø 3/4" (Ø 19.05mm), drawn type (C1220T-1/2H or C1220T-H) type copper pipe must be used. If an annealed type (C1220T-O) copper pipe is used, pipe may break due to its low pressure resistance and cause personal injury.

Refrigerant pipe installation

Keeping refrigerant pipe

To prevent foreign materials or water from entering the pipe, storing method and sealing method (especially during installation) is very important. Apply correct sealing method depending on the environment.

Exposure place	Exposure time	Sealing type
Outdoor	Longer than one month	Pipe pinch
	Shorter than one month	Taping
Indoor	-	Taping

Refrigerant pipe welding and safety information



CAUTION

Important information for refrigerant pipe work

- Make sure there is no moisture inside the pipe.
- Make sure there are no foreign substances and impurities in the pipe.
- Make sure there is no leakage.
- Make sure to follow the instruction when welding or storing the pipe.

Nitrogen flushing welding

- ▶ When welding the refrigerant pipes, flush them with nitrogen gas as shown in the picture.
- ▶ If you do not perform nitrogen flushing when welding the pipes, oxide may form inside the pipe. It can cause the damage of the important parts such as compressor and valves etc.
- ▶ Adjust the flow rate of the nitrogen flushing with a pressure regulator to maintain $0.05\text{m}^3/\text{h}$ ($0.54\text{ft}^3/\text{h}$) or less.

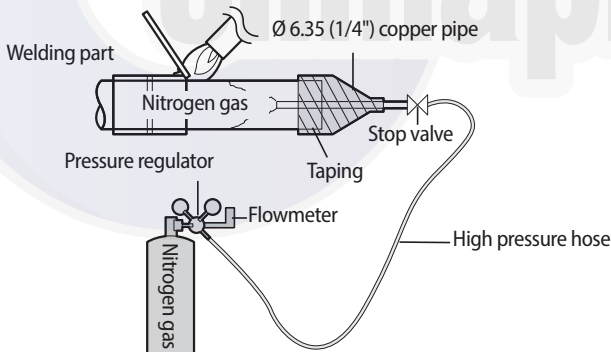

Direction of the pipe when welding

- ▶ Direction of the pipe should be headed downward or in a sideways when welding.
- ▶ Avoid welding the pipe with pipe direction heading upward.



CAUTION

- When you test gas leakage after welding the pipes, use a designated solution for gas leakage detection. If you use the detection solution that includes sulfuric ingredient, it may cause corrosion to the pipes.

Cutting or flaring the pipes

1. Make sure that you prepared the required tools.
 - ▶ Pipe cutter, Deburring tool, flaring tool and pipe holder, etc.
2. If you want to shorten the pipe, cut it with a pipe cutter ensuring that the cut edge remains at 90° with the side of the pipe.
 - ▶ Refer to below illustrations for correct and incorrect examples of cut edges.

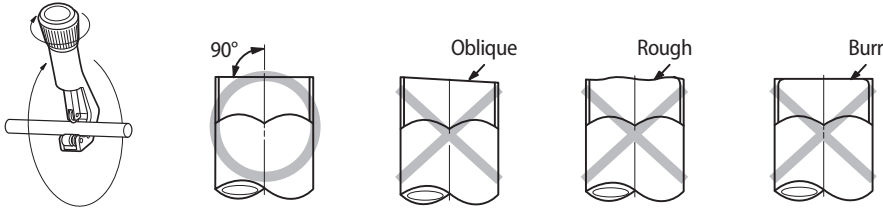

3. To prevent a gas leak, remove all burrs at the cut edge of the pipe using a Deburring tool.
4. Carry out flaring work using flaring tool as shown below.

[Flaring tools]



	Pipe diameter [D, mm (inch)]	Depth of flaring part [A, mm (inch)]		
		Using flaring tool for R-410A	Using conventional flaring tool	
			Clutch type	Wing nut type
	ø6.35(ø1/4)	0~0.5(0~0.02)	1.0~1.5(0.04~0.06)	1.5~2.0(0.06~0.08)
	ø9.52(ø3/8)	0~0.5(0~0.02)	1.0~1.5(0.04~0.06)	1.5~2.0(0.06~0.08)
	ø12.70(ø1/2)	0~0.5(0~0.02)	1.0~1.5(0.04~0.06)	1.5~2.0(0.06~0.08)
	ø15.88(ø5/8)	0~0.5(0~0.02)	1.0~1.5(0.04~0.06)	1.5~2.0(0.06~0.08)

5. Check that you flared the pipe correctly.
 - ▶ Refer to below illustrations for correct and incorrect examples of flared pipe.



- If foreign matters or burrs are not removed after cutting pipe, refrigerant gas may leak.
- If foreign matters enter inside the pipe, important interior parts of the unit may get damaged or product efficiency will be reduced. So, the direction of pipe should be downward during pipe cutting or flaring.

Refrigerant pipe installation

Connecting the flared pipes

- ▶ Check if the flaring is properly done according to the standard size.
- ▶ Align the center of the piping and tighten the flare nut with your hands. Then, tighten the flare nut with torque wrench in a direction of the arrow indicated in below illustration.
- ▶ Make sure to use ester oil to coat the flare connection section.

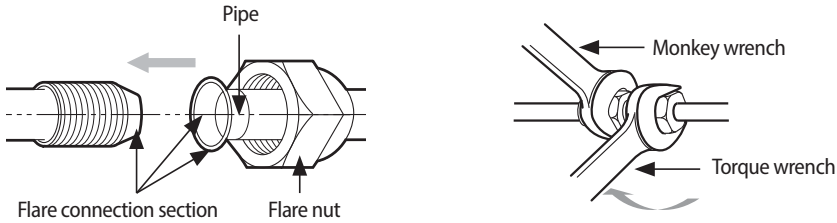

Outer diameter (D)		Torque		Flare dimension (L)		Flare shape [mm(inch)]
mm	inch	N·m	lbf·ft	mm	inch	
6.35	1/4	14 ~ 18	10.3 ~ 13.3	8.7 ~ 9.1	0.34 ~ 0.36	
9.52	3/8	34 ~ 42	25.1 ~ 31.0	12.8 ~ 13.2	0.50 ~ 0.52	
12.7	1/2	49 ~ 61	36.1 ~ 45.0	16.2 ~ 16.6	0.64 ~ 0.65	
15.88	5/8	68 ~ 82	50.2 ~ 60.5	19.3 ~ 19.7	0.76 ~ 0.78	



- Blowing Nitrogen gas should be done when welding the pipe.
- Make sure to use the provided flare nut.
- Make sure that there are no cracks or twisted part when you need to bend the pipe.
- Do not fasten the flare nut with excessive strength.
- R-410A is a high pressure refrigerant and there is a risk of refrigerant leakage if the flare connection is not coated with ester oil. Therefore, apply ester oil to coat the flare connection area.

Pipe installation for an outdoor unit

1. Direction of the pipe

Refrigerant pipe can be withdrawn from the front, left and right side. Take necessary method to install the pipes according to the condition of the installation site.

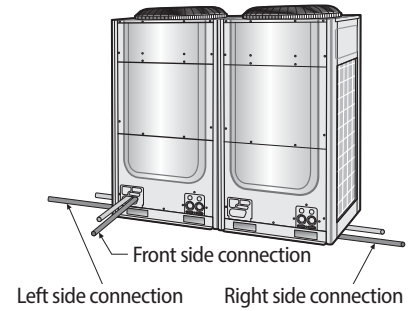

Caution for using knock-out hole

CAUTION

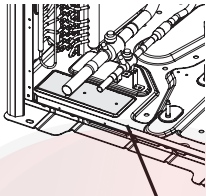

Knock-out hole

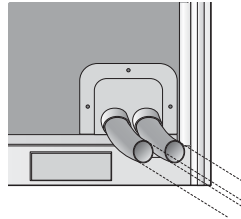

- Make sure to prevent any damages on the exterior of the outdoor unit.
- Remove all burrs around the knock-out hole and apply varnish on the cross section and edges of the knock-out hole to prevent rust.
- Use a cable protection tube and bushing to prevent a cable from being damaged when passing through a knock-out hole.

Refrigerant pipe installation

2. Connecting refrigerant pipe for outdoor unit

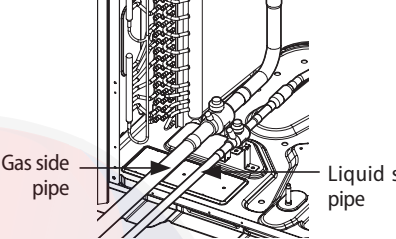
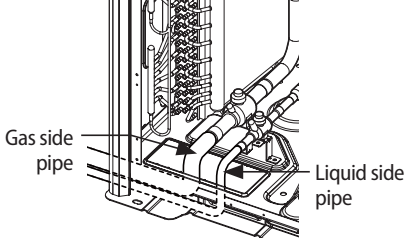
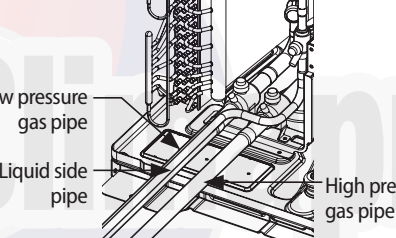
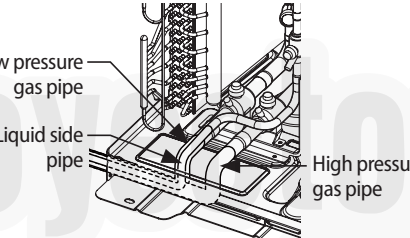
Classification	Front side connection	Right/left (and bottom) side connection
Working process	<ul style="list-style-type: none"> • First, remove the piping cover from the outdoor unit. • Separate the knock-out hole that you are going to use. If you separate the knock-out hole that is going to be unused, small animals such as squirrels and rats may get into the unit through the hole. • Fix the bottom side of the piping cover first and then fix the top part of it. 	<ul style="list-style-type: none"> • Separate the knock-out hole at the bottom side of the unit and install the pipe. • After installing and insulating the pipe, close up the remaining holes. If not, small animals such as rats and squirrels may get inside the unit.
H/P		
H/R		



CAUTION

Caution for welding the pipe to an outdoor unit

- When welding the pipe, the unit may get damaged by the heat and flame from welding. Use a flame proofing cloth to protect the unit from a welding fire or flame. Sensor for detecting outside temperature is located on the left side of the welding part so be extra careful not to damage the sensor when welding.
- The O-ring and Teflon packing inside service valve may get damaged by the heat from welding. Wrap the bottom side of the service valve with a wet cloth and weld it as shown in the illustration. Also, water dripping from the wet cloth may interrupt the welding. Make sure the water does not drip from the wet cloth.
- Make sure that connected pipes does not interrupt each other or make contact with the product. (Vibration may cause damage to the pipes.)
- When removing the sealed pipe on the bottom side of the service valve, cut it with a pipe cutter first and then start the welding. When the sealed pipe is welded without cutting, you may get injured by the refrigerant within the pipe.

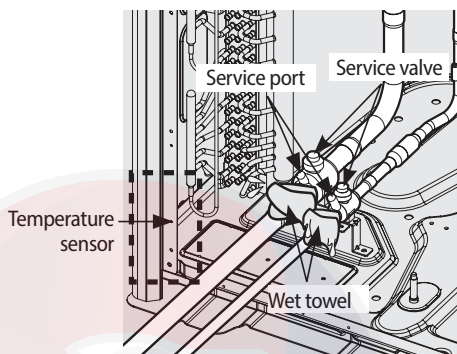

< H/P >

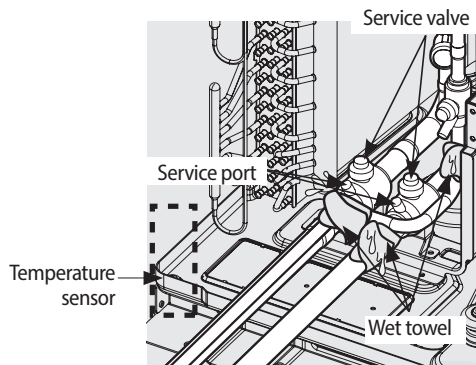

< H/R >

Climaproyectos
.com

Refrigerant pipe installation

3. Pipe installation between the outdoor units

- ▶ You will need branch joints, which is an optional accessory, for connecting in between outdoor units in order to combine outdoor units in module.
- * For optimal distribution of the refrigerant, you must use Y-joint as branch joint for connecting outdoor units. (Do not use T-joint)
- ▶ When you install the outdoor units in module, there is no restriction of installation order among outdoor units.
- ▶ Height of the connection pipe should be same or lower than the ones connected to the outdoor units.
- ▶ Check the changes in comparison with the DVM II and III.

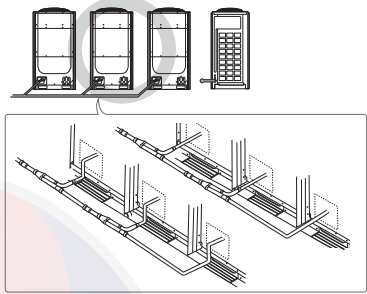
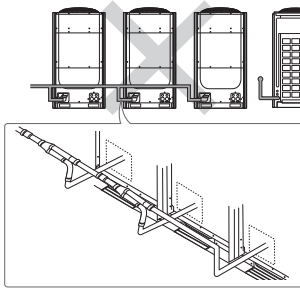
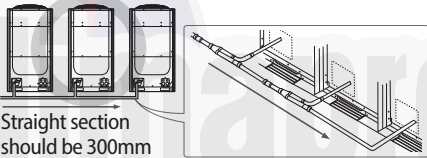
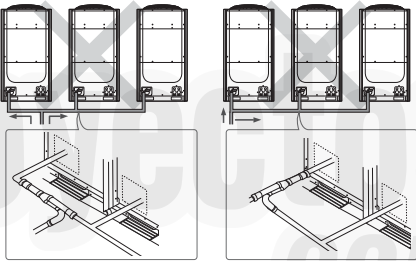
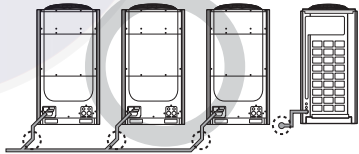
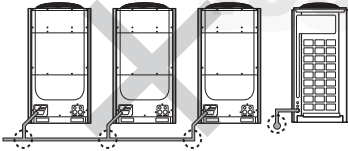
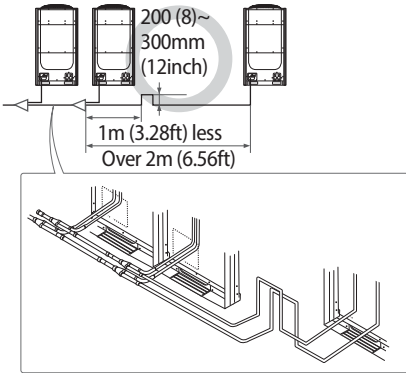
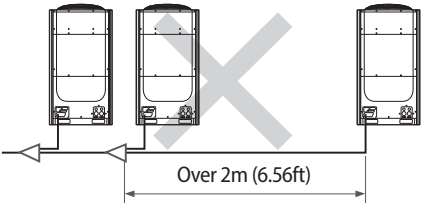
Caution	Correct installation	Incorrect installation
<p>Refrigerant pipes should be connected at the same or lower level than the ones connected to the outdoor unit.</p>		
<p>Refrigerant pipes must be connected by the side of the product.</p>	 <p>Straight section should be 300mm (12inch) or more</p>	
<p>Branch joint between outdoor units must be installed horizontally.</p>		
<p>When the piping length between outdoor unit and the branch joint exceeds 2m (6.56ft), install a vertical trap as show in the figure.</p>		

Examples of refrigerant pipe installation

H/P

1. Using Y-joint

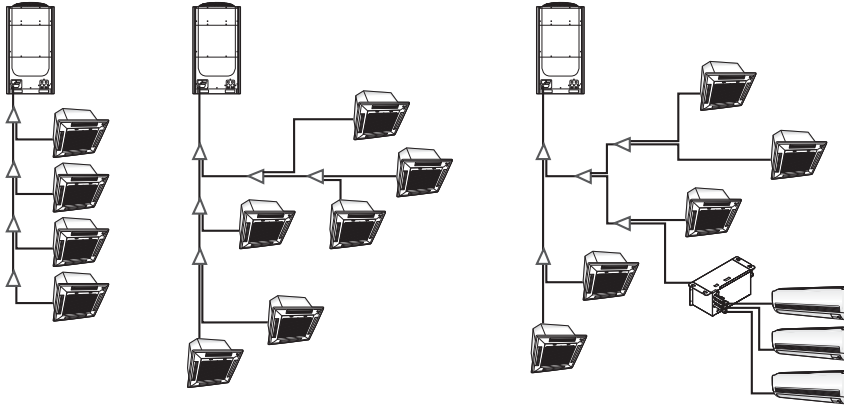

2. Using distribution header

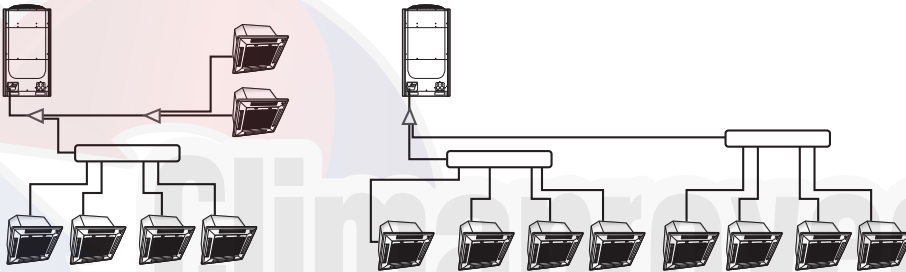

H/R

1. Using Y-joint

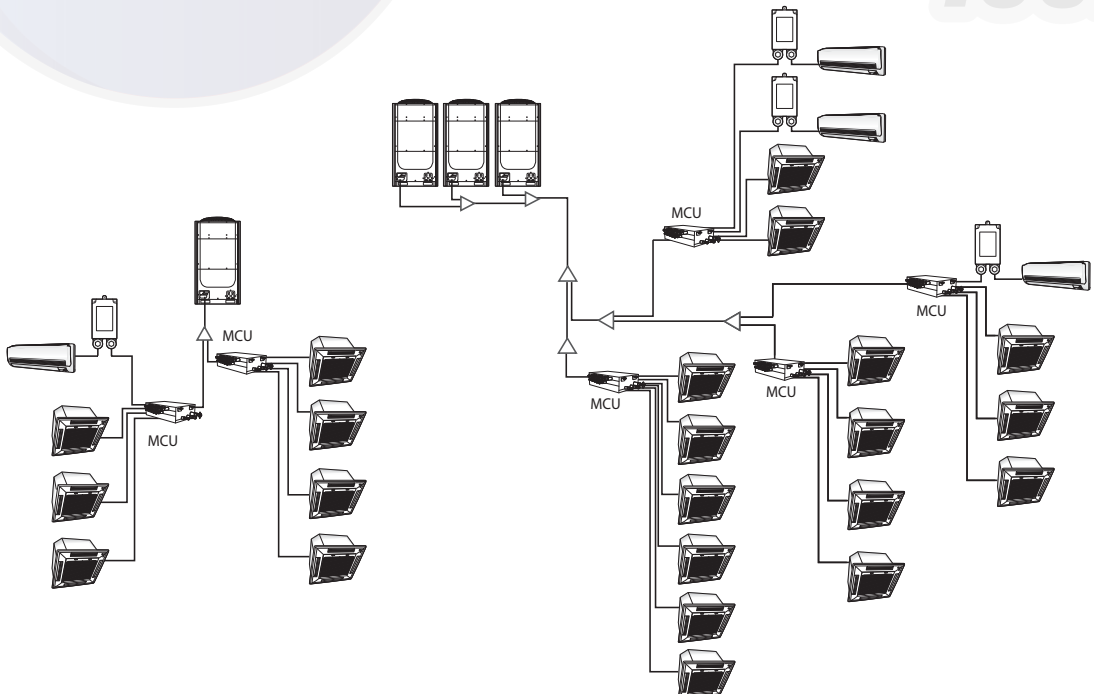

Refrigerant pipe installation

Allowable length of the refrigerant pipe and the installation examples

H/P

Classification	Single Installation	Module installation
Installing only with Y-joint		
Installing with Y-joint and distribution header		
Installing only with distribution header		

Classification		Example		Remarks		
Maximum allowable length of pipe	Outdoor unit ~ Indoor unit	Actual length (Equivalent length)	200m (656') and below [220m (722') and below]	Installing only with Y-joint $a+b+c+d+e+f+g+p \leq 200\text{m}(220\text{m})/656'(722')$	Equivalent length Y-joint: 0.5m (1.64'), Distribution header: 1m (3.28')	
				Installing with Y-joint and distribution header $a+b+h \leq 200\text{m}(220\text{m})/656'(722')$, $a+i+k \leq 200\text{m}(220\text{m})/656'(722')$		
				Installing only with distribution header $a+i \leq 200\text{m}(220\text{m})/656'(722')$		
	Outdoor unit ~ Outdoor unit (Module installation)	Pipe length	10m (33') or less	$r \leq 10\text{m} (33'), s \leq 10\text{m} (33'), t \leq 10\text{m} (33')$		
			Equivalent length	13m (43') or less	$r \leq 13\text{m} (43'), s \leq 13\text{m} (43'), t \leq 13\text{m} (43')$	
			Total length of pipe (m)	1000m (3281') or less	Installing only with Y-joint	
Maximum allowable height difference of pipe	Outdoor unit ~ Indoor unit	110/40m (361'/131') ^{Note 2)}		110/40m (361'/131')		
	Indoor unit ~ Indoor unit	50m (164')		50m (164')		

Classification			Example	Remarks
Maximum allowable length after branch joint	First branch joint ~ Farthest Indoor unit	Pipe length	45m (148') or less	$b+c+d+e+f+g+p \leq 45m (148')$, $i \leq 45m (148')$
			45m~90m (148'~295') <small>Note 1)</small>	Required conditions must be satisfied Exclude H/R

EEV kit		Model name		Remarks	
EEV Kit ~ Indoor unit	Actual pipe length	2m(6.6') or less	MEV-E24SA	1 indoor	Apply to products without EEV(Wall mounted & ceiling)
			MEV-E32SA		
		20m(66') or less	MXD-E24K132A	2 indoor	
			MXD-E24K200A		
			MXD-E32K200A		
			MXD-E24K232A	3 indoor	
			MXD-E24K300A		
			MXD-E32K224A		
MXD-E32K300A					

* Please refer to the EEV Kit manual.

Note 1) Required condition

Classification	Condition	Example
First branch joint ~ Farthest Indoor unit	$45m (148') \leq b+c+d+e+f+g+p \leq 90m (295')$: branch pipes (b, c, d, e, f, g) size must be increased by 1 grade	
Total length of extended pipe	If the size of pipe (main pipe), between the first branch joint and the outdoor unit, is not increased by 1 grade, $a+(b+c+d+e+f+g) \times 2+h+i+j+k+l+m+n+p \leq 1000m (3281')$ If the size of pipe (main pipe), between the first branch joint and the outdoor unit, is increased by 1 grade, $a+(b+c+d+e+f+g) \times 2+h+i+j+k+l+m+n+p \leq 1000m (3281')$	
Each Y-joint ~ Each indoor unit	$h, i, j, \dots p \leq 45m (148')$	
Difference between the distance of the outdoor unit to the farthest indoor unit and nearest indoor unit $\leq 45m (148')$, $(a+b+c+d+e+g+p)-(a+h) \leq 45m (148')$		

Note 2) When indoor unit is located at higher level than outdoor unit, allowable height difference is 40 m (131'), but when the indoor unit is located at lower level than outdoor unit, allowable height difference is 100 m (361'). [If the height difference is over 50 m (164') decide if you need to install PDM kit]

Model name of the PDM kit: MXD-A38K2A, MXD-A12K2A, MXD-A58K2A

Refrigerant pipe installation

H/R

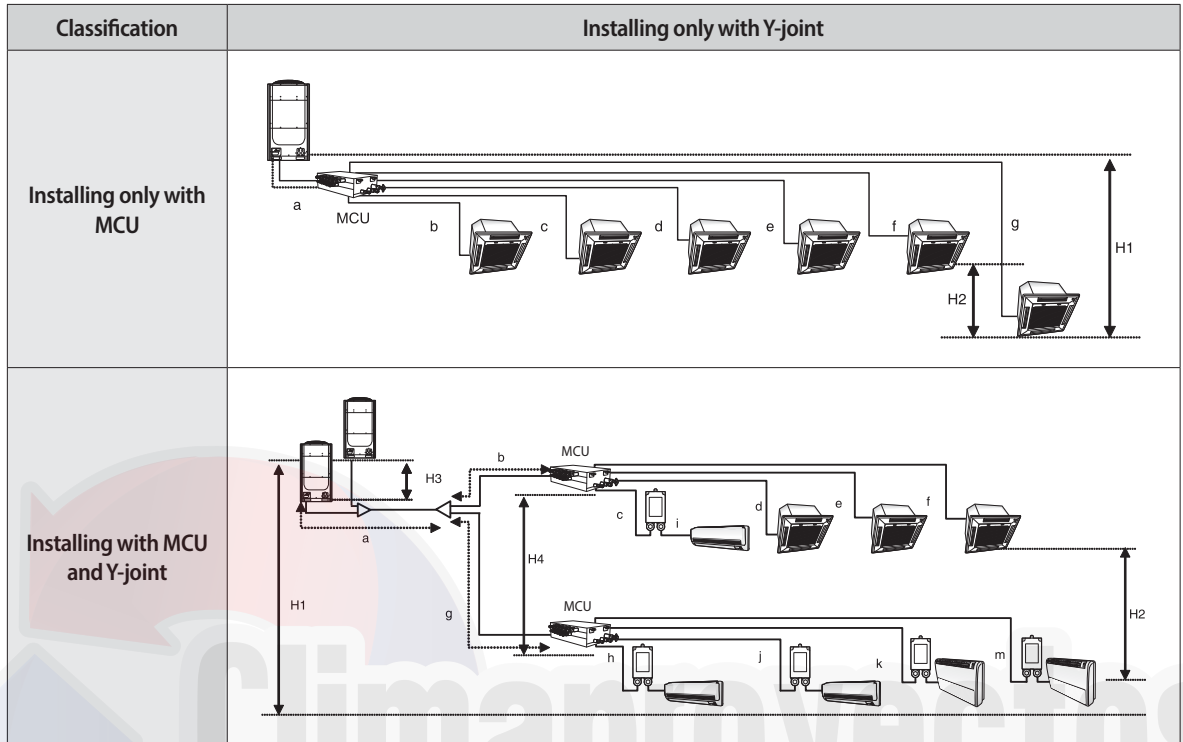

Items				Examples		Remarks
Max. piping length	Indoor ~ Outdoor unit	Piping (Equivalent piping)	200m(656') 220m(722')	Using MCU only	$a+g \leq 200m(220m)/656'(722')$	Equivalent pipe length. Y joint : 0.5m (1.64'), Header : 1m (3.28'), MCU : 1m (3.28')
				Using Y-joint and MCU	$a+g+m \leq 200m(220m)/656'(722')$	
	Total piping	1000m(3281')	Using MCU only	$a+b+c+d+e+f+g \leq 1000m/3281'$		
			Using Y-joint and MCU	$a+b+c+d+e+f+g+p+h+i+j+k+m \leq 1000m/3281'$		
	Outdoor ~ Outdoor unit	Piping	10m(33')	$r \leq 10(33'), s \leq 10(33'), t \leq 10m(33')$		
Equivalent piping		13m(43')	$r \leq 13(43'), s \leq 13(43'), t \leq 13m(43')$			
Level difference	Outdoor ~ Indoor unit	Piping	110m/40m ^{Note 1)} (361'/131')	$H1 \leq 110m/40m(361'/131')$		
	Indoor ~ Indoor unit	Piping	15m(49')	$H2 \leq 15m(49')$		
	MCU~MCU	Piping	15m(49')	$H4 \leq 15m(49')$		
Allowable length after branch	The first branch ~ the farthest Indoor unit	Piping	45m(148')	Using MCU only	45m(148')	
				Using Y-joint and MCU	$g+m \leq 45m(148')$	

Distribution kit			Model	Remarks
Allowable	From distribution kit to indoor unit	2 m	MEV-E245A, MEV-E325A (For 1 indoor unit)	Apply to products without EEV (Wall mount & ceiling)

Note 1) When indoor unit is located at higher level than outdoor unit, allowable height difference is 40 m, but when the indoor unit is located at lower level than outdoor unit, allowable height difference is 110 m (If the height difference is over 50 m, decide if you need to install PDM kit).

Model name of the PDM kit: MXD-A38K2A, MXD-A12K2A, MXD-A58K2A

*PDM kit: Pressure Drop Modulation kit

* Total refrigerant amount of the system must be less than 100 kg(220 lb). If total refrigerant amount of system is over than 100 kg(220 lb), the system has to be divided into smaller system, each less than 100 kg(220 lb).

Refrigerant pipe installation

Installing the branch joints

Branch joints must be installed 'horizontally' or 'vertically'.

Horizontal installation

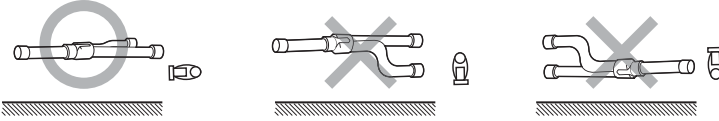

Vertical installation

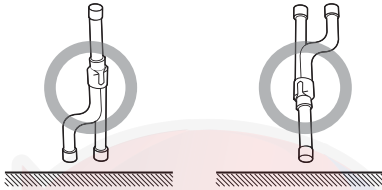

NOTE

- For A~J type branch joints : Connect the branch joint to the connection pipe with the provided reducer.
- For K~Z type branch joints : Cut the connection part of the branch joint or the provided socket, according to the diameter of the connection pipe, before connecting them.

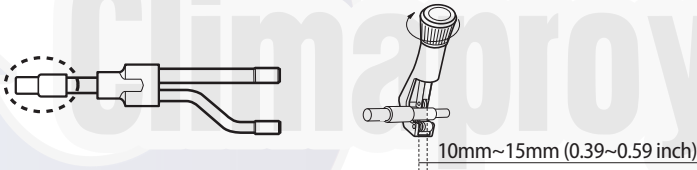

CAUTION

- Install the branch joint within $\pm 15^\circ$ of the horizon or vertical line.
- Make sure that the pipe is not bent at where it is connected to the branch joint.
- Keep a minimum straight line distance of 500mm (20 inch) or more before connecting branch joint.

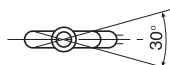
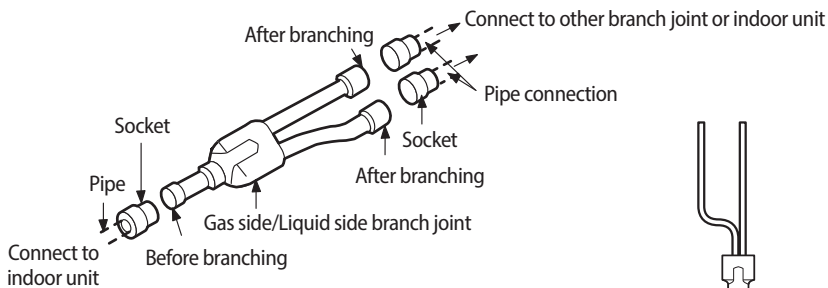

* Install within $\pm 15^\circ$ of the horizon or vertical line.

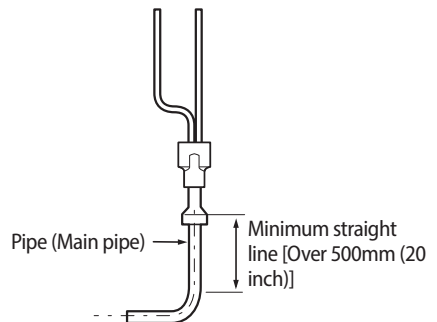

Installing the distribution header

1. Select the reducer that fits the diameter of the pipe.

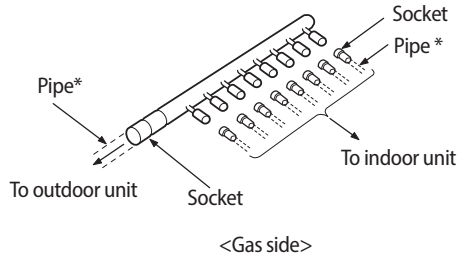
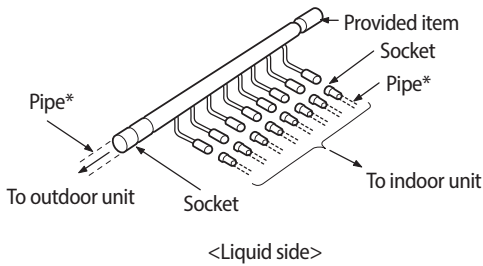

* Pipe : Separately purchased item

2. If the number of connected indoor unit is fewer than ports on the distribution header, block the unused ports with caps.

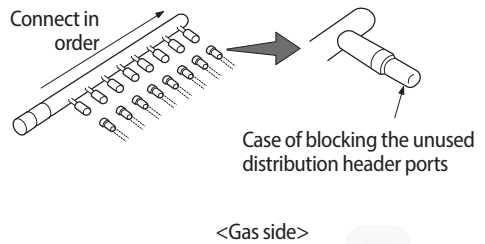
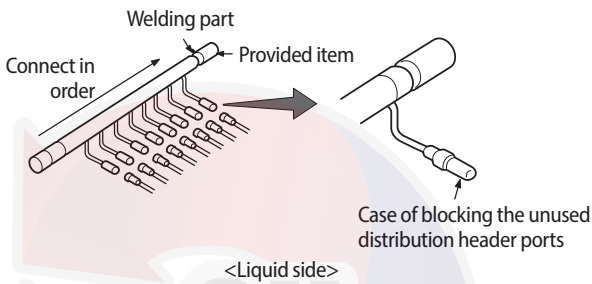

- For A~J type distribution header :
Connect the distribution header to the connection pipe with the provided reducer.
- For K~Z type distribution headers :
Cut the provided socket, according to the diameter of the connection pipe, before connecting it.

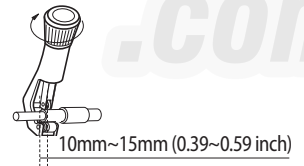
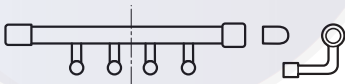

- Connect the indoor units in order, while respecting the direction of the arrow shown in the illustration.
- When indoor units are connected to same distribution head, indoor unit must be connected in order of their capacity, from largest to smallest.

Refrigerant pipe installation

3. Install the distribution header horizontally.
 - ▶ Install the distribution header horizontally so that its ports does not face down.

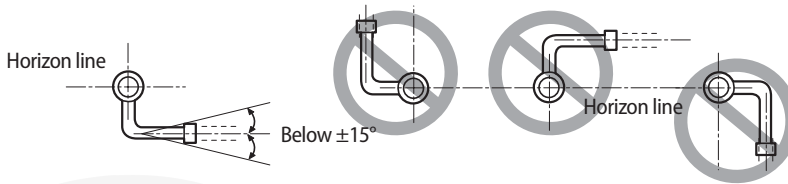
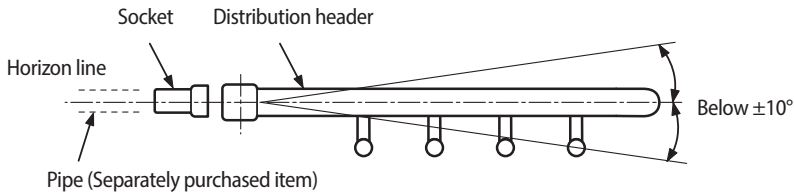

< Liquid side >

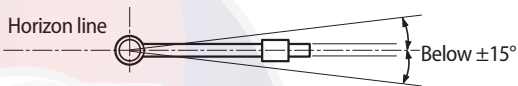

< Gas side >

Installing the branch joint between outdoor units

Installation of outdoor joints

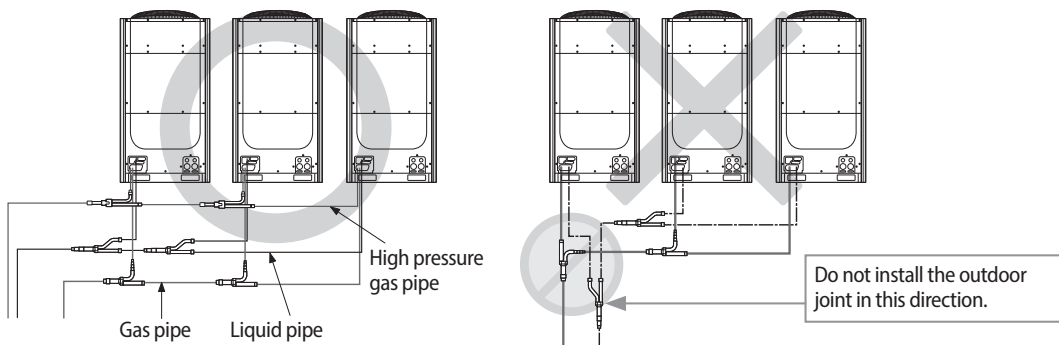

* High pressure gas pipe only applies to the H/R product.

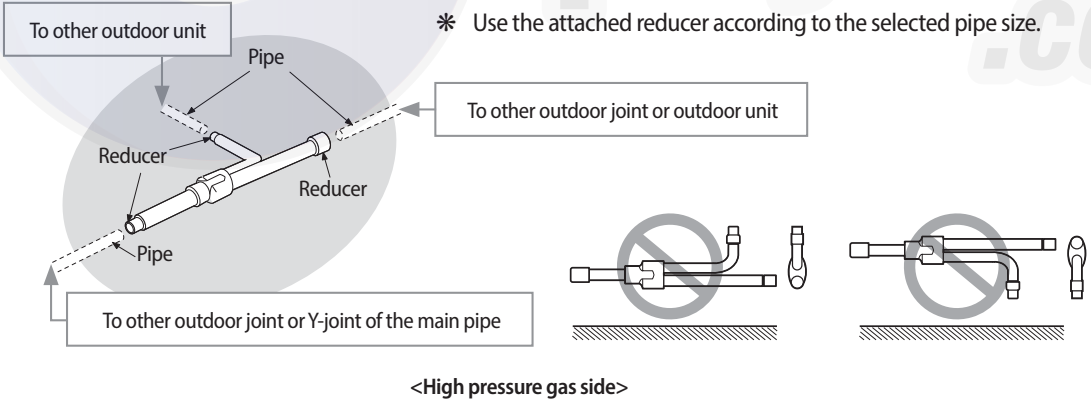
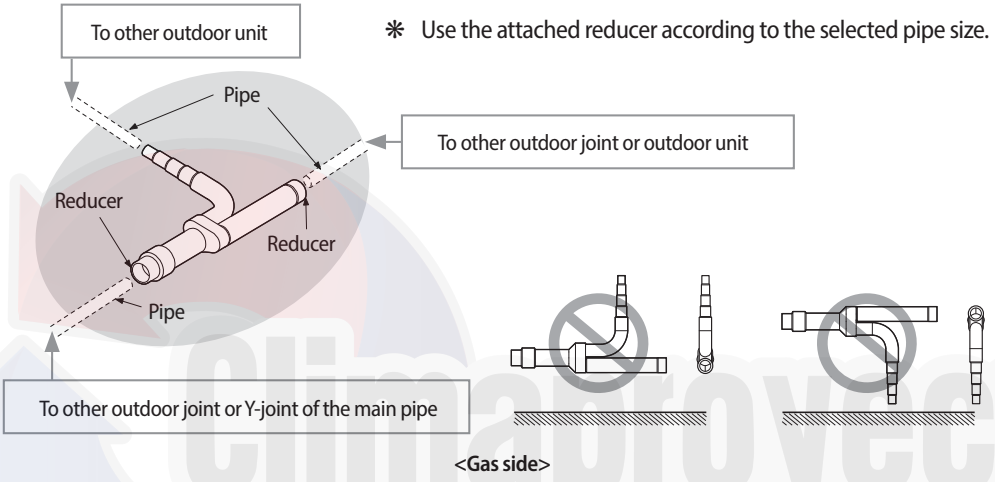
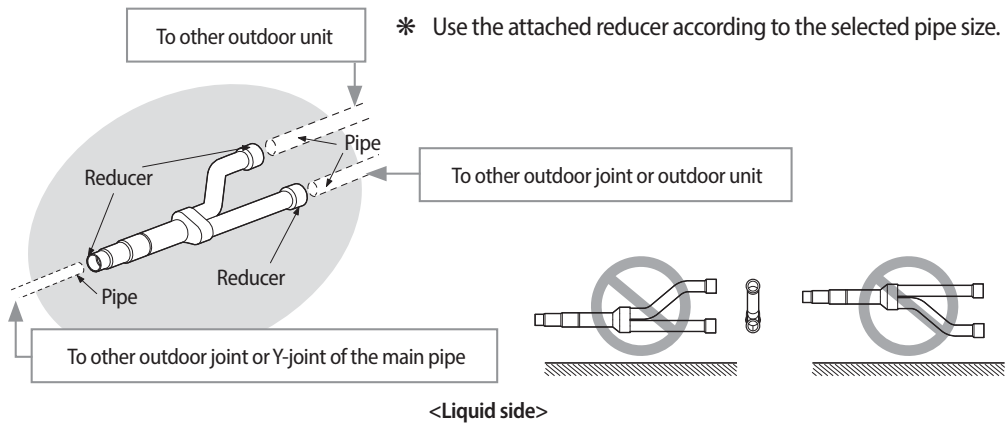

NOTE

• Connect the Outdoor joint to the pipe by cutting the outlet of the Outdoor joint or provided reducer properly.

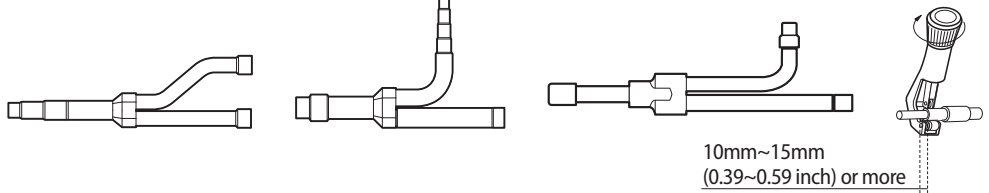

Refrigerant pipe installation

Installing the MCU

MCU specification

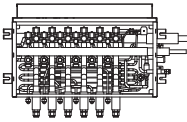
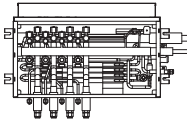
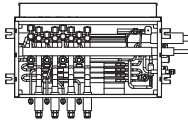
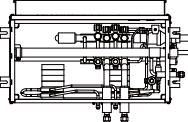
Model	MCU-S6NEE1N	MCU-S4NEE1N	MCU-S4NEE2N	MCU-S2NEK1N
Exterior of MCU				
Number of connectable indoor units	Up to 6 units	Up to 4 units	Up to 2 units * Refer the detail information of installation	Up to 2 units
Maximum capacity of connectable indoor units	56 kW (192MBH)	56 kW (192MBH)	56 kW (192MBH)	28 kW (96MBH)

Installing the indoor units

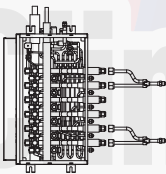
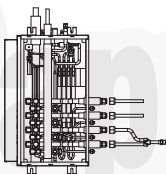
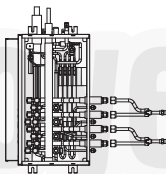
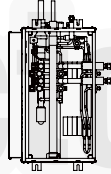
Model	MCU-S6NEE1N	MCU-S4NEE1N	MCU-S4NEE2N	MCU-S2NEK1N
Example installing				
Installation Condition	Single capacity range 10 kW(30 MBH) or under: Connect the liquid, gas pipe of indoor unit to a single port in MCU 11.2~14 kW(36~48 MBH): Use Y-Joint		The indoor unit's capacity of 20 kW(60 MBH) or over, must use the appropriate MCU Apply when connecting the indoor unit's capacity of over 11.2 kW (36 MBH): Use Y-Joint	14 kW(48 MHB) or under: Connect the liquid, gas pipe of indoor unit to a single port in MCU 14~28 kW(48~96 MBH): Use Y-Joint(DB97-19694A)
Maximum IDU Capacity	14 kW(48 MBH)		28 kW(96 MBH)	28 kW(96 MBH)
Minimum IDU Capacity	-		11.2 kW(36 MBH)	-
Maximum Single Port Capacity	10 kW(30 MBH)		-	14 kW(48 MBH)
Installation condition in case of continuous cooling	5~14 kW(18~48 MBH): Use Y-joint Under 5 kW(18 MBH): Connect the liquid, gas pipe of indoor unit to a single port in MCU		Use Y-Joint	5 kW(18 MHB) or over: Use Y-Joint(DB97-19693A) Under 5 kW(18 MBH): Connect the liquid, gas pipe of indoor unit to a single port in MCU
	Option switch and key function needs to set. For detail information, refer to the outdoor unit's manual			
Remarks	Y-Joint consists of accessories			Y-Joint is supplied with service materials (DB97-19693A, DB97-19694A)

How to connect the pipes

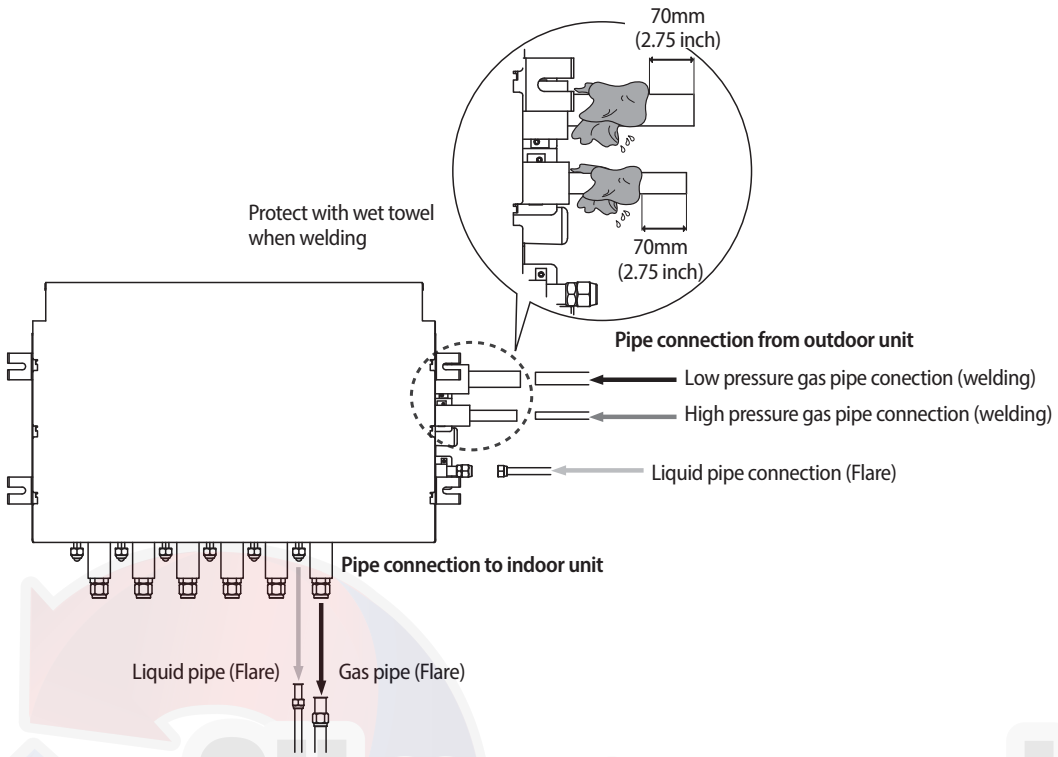

- * When installing MCU, use the pattern sheet for installation that is provided with the product.
- * When welding the high/low pressure gas pipe, protect the product with the flame-proof sheet.

Electrical wiring work

Specification of the circuit breaker and power cable

Electric Characteristics

1. Heat Pump/Heat Recovery (208~230V) (AM***F*, AM***H* Series)

		Units		Module1						Module2					
Nom.Ton	Model			Hz	Volts	RLA		FLA		Power Supply		RLA		FLA	
				Comp1	Comp2	FAN1	FAN2	MCA	MOP	Comp1	Comp2	FAN1	FAN2	MCA	MOP
6TON	AM072*XVAF*	60	208/230	14.3		4.0		28.0	35.0						
8TON	AM096*XVAF*	60	208/230	13.9	13.9	3.0	3.0	37.8	50.0						
10TON	AM120*XVAF*	60	208/230	14.8	14.8	3.0	3.0	43.0	50.0						
12TON	AM144*XVAF*	60	208/230	20.7	20.7	3.0	3.0	52.6	70.0						
14TON	AM168*XVAF*	60	208/230	24.0	24.0	3.0	3.0	66.0	80.0						
16TON	AM192*XVAF*	60	208/230	28.0	28.0	3.0	3.0	73.0	90.0						
18TON	AM216*XVAF*	60	208/230	14.3		4.0		28.0	35.0	20.7	20.7	3.0	3.0	52.6	70.0
20TON	AM240*XVAF*	60	208/230	14.3		4.0		28.0	35.0	24.0	24.0	3.0	3.0	66.0	80.0
22TON	AM264*XVAF*	60	208/230	14.3		4.0		28.0	35.0	28.0	28.0	3.0	3.0	73.0	90.0
24TON	AM288*XVAF*	60	208/230	20.7	20.7	3.0	3.0	52.6	70.0	20.7	20.7	3.0	3.0	52.6	70.0
26TON	AM312*XVAF*	60	208/230	20.7	20.7	3.0	3.0	52.6	70.0	24.0	24.0	3.0	3.0	66.0	80.0
28TON	AM336*XVAF*	60	208/230	24.0	24.0	3.0	3.0	66.0	80.0	24.0	24.0	3.0	3.0	66.0	80.0
30TON	AM360*XVAF*	60	208/230	24.0	24.0	3.0	3.0	66.0	80.0	28.0	28.0	3.0	3.0	73.0	90.0
32TON	AM384*XVAF*	60	208/230	28.0	28.0	3.0	3.0	73.0	90.0	28.0	28.0	3.0	3.0	73.0	90.0
34TON	AM408*XVAF*	60	208/230	14.3		4.0		28.0	35.0	20.7	20.7	3.0	3.0	52.6	70.0
36TON	AM432*XVAF*	60	208/230	20.7	20.7	3.0	3.0	52.6	70.0	20.7	20.7	3.0	3.0	52.6	70.0
38TON	AM456*XVAF*	60	208/230	14.8	14.8	3.0	3.0	43.0	50.0	24.0	24.0	3.0	3.0	66.0	80.0
40TON	AM480*XVAF*	60	208/230	20.7	20.7	3.0	3.0	52.6	70.0	24.0	24.0	3.0	3.0	66.0	80.0
42TON	AM504*XVAF*	60	208/230	24.0	24.0	3.0	3.0	66.0	80.0	24.0	24.0	3.0	3.0	66.0	80.0
44TON	AM528*XVAF*	60	208/230	24.0	24.0	3.0	3.0	66.0	80.0	24.0	24.0	3.0	3.0	66.0	80.0

		Units		Module3					
Nom.Ton	Model			Hz	Volts	RLA		FLA	
				Comp1	Comp2	FAN1	FAN2	MCA	MOP
6TON	AM072*XVAF*	60	208/230						
8TON	AM096*XVAF*	60	208/230						
10TON	AM120*XVAF*	60	208/230						
12TON	AM144*XVAF*	60	208/230						
14TON	AM168*XVAF*	60	208/230						
16TON	AM192*XVAF*	60	208/230						
18TON	AM216*XVAF*	60	208/230						
20TON	AM240*XVAF*	60	208/230						
22TON	AM264*XVAF*	60	208/230						
24TON	AM288*XVAF*	60	208/230						
26TON	AM312*XVAF*	60	208/230						
28TON	AM336*XVAF*	60	208/230						
30TON	AM360*XVAF*	60	208/230						
32TON	AM384*XVAF*	60	208/230						
34TON	AM408*XVAF*	60	208/230	28.0	28.0	3.0	3.0	73.0	90.0
36TON	AM432*XVAF*	60	208/230	20.7	20.7	3.0	3.0	52.6	70.0
38TON	AM456*XVAF*	60	208/230	24.0	24.0	3.0	3.0	66.0	80.0
40TON	AM480*XVAF*	60	208/230	24.0	24.0	3.0	3.0	66.0	80.0
42TON	AM504*XVAF*	60	208/230	24.0	24.0	3.0	3.0	66.0	80.0
44TON	AM528*XVAF*	60	208/230	28.0	28.0	3.0	3.0	73.0	90.0

Note: 1. RLA is based on AHRI 1230 Cooling Standard Condition (Indoor Temp : 26.7°C/80°F(DB) / 19.46°C/67°F(WB), Outdoor Temp : 35°C/95°F(DB))

2. Voltage Tolerance is ± 10%

3. Maximum allowable voltage between phases is 2%

4. Refer to module combination table for independent units information

Symbols: 1. RLA : Rated Load Ampere

2. FLA : Full Load Ampere

3. MCA : Minimum Circuit Ampere (A)

4. MOP : Maximum Overcurrent Protective Device(A)

2. Heat Pump/Heat Recovery (460V) (AM***F*, AM***H* Series)

		Units		Module1						Module2					
Nom.Ton	Model			RLA		FLA		Power Supply		RLA		FLA		Power Supply	
		Hz	Volts	Comp1	Comp2	FAN1	FAN2	MCA	MOP	Comp1	Comp2	FAN1	FAN2	MCA	MOP
6TON	AM072*XVAJ*	60	460	9.5		2.0		16.4	20.0						
8TON	AM096*XVAJ*	60	460	11.5		1.5	1.5	19.0	25.0						
10TON	AM120*XVAJ*	60	460	14.0		1.5	1.5	21.7	30.0						
12TON	AM144*XVAJ*	60	460	11.4	11.4	1.5	1.5	28.7	40.0						
14TON	AM168*XVAJ*	60	460	12.0	12.0	1.5	1.5	33.0	40.0						
16TON	AM192*XVAJ*	60	460	14.5	14.5	1.5	1.5	37.0	50.0						
18TON	AM216*XVAJ*	60	460	9.5		2.0		16.4	20.0	11.4	11.4	1.5	1.5	28.7	40.0
20TON	AM240*XVAJ*	60	460	9.5		2.0		16.4	20.0	12.0	12.0	1.5	1.5	33.0	40.0
22TON	AM264*XVAJ*	60	460	9.5		2.0		16.4	20.0	14.5	14.5	1.5	1.5	37.0	50.0
24TON	AM288*XVAJ*	60	460	11.4	11.4	1.5	1.5	28.7	40.0	11.4	11.4	1.5	1.5	28.7	40.0
26TON	AM312*XVAJ*	60	460	11.4	11.4	1.5	1.5	28.7	40.0	12.0	12.0	1.5	1.5	33.0	40.0
28TON	AM336*XVAJ*	60	460	12.0	12.0	1.5	1.5	33.0	40.0	12.0	12.0	1.5	1.5	33.0	40.0
30TON	AM360*XVAJ*	60	460	12.0	12.0	1.5	1.5	33.0	40.0	14.5	14.5	1.5	1.5	37.0	50.0
32TON	AM384*XVAJ*	60	460	14.5	14.5	1.5	1.5	37.0	50.0	14.5	14.5	1.5	1.5	37.0	50.0
34TON	AM408*XVAJ*	60	460	9.5		2.0		16.4	20.0	11.4	11.4	1.5	1.5	28.7	40.0
36TON	AM432*XVAJ*	60	460	11.4	11.4	1.5	1.5	28.7	40.0	11.4	11.4	1.5	1.5	28.7	40.0
38TON	AM456*XVAJ*	60	460	14.0		1.5	1.5	21.7	30.0	12.0	12.0	1.5	1.5	33.0	40.0
40TON	AM480*XVAJ*	60	460	11.4	11.4	1.5	1.5	28.7	40.0	12.0	12.0	1.5	1.5	33.0	40.0
42TON	AM504*XVAJ*	60	460	12.0	12.0	1.5	1.5	33.0	40.0	12.0	12.0	1.5	1.5	33.0	40.0
44TON	AM528*XVAJ*	60	460	12.0	12.0	1.5	1.5	33.0	40.0	12.0	12.0	1.5	1.5	33.0	40.0

		Units		Module3					
Nom.Ton	Model			RLA		FLA		Power Supply	
		Hz	Volts	Comp1	Comp2	FAN1	FAN2	MCA	MOP
6TON	AM072*XVAJ*	60	460						
8TON	AM096*XVAJ*	60	460						
10TON	AM120*XVAJ*	60	460						
12TON	AM144*XVAJ*	60	460						
14TON	AM168*XVAJ*	60	460						
16TON	AM192*XVAJ*	60	460						
18TON	AM216*XVAJ*	60	460						
20TON	AM240*XVAJ*	60	460						
22TON	AM264*XVAJ*	60	460						
24TON	AM288*XVAJ*	60	460						
26TON	AM312*XVAJ*	60	460						
28TON	AM336*XVAJ*	60	460						
30TON	AM360*XVAJ*	60	460						
32TON	AM384*XVAJ*	60	460						
34TON	AM408*XVAJ*	60	460	14.5	14.5	1.5	1.5	37.0	50.0
36TON	AM432*XVAJ*	60	460	11.4	11.4	1.5	1.5	28.7	40.0
38TON	AM456*XVAJ*	60	460	12.0	12.0	1.5	1.5	33.0	40.0
40TON	AM480*XVAJ*	60	460	12.0	12.0	1.5	1.5	33.0	40.0
42TON	AM504*XVAJ*	60	460	12.0	12.0	1.5	1.5	33.0	40.0
44TON	AM528*XVAJ*	60	460	14.5	14.5	1.5	1.5	37.0	50.0

Note: 1. RLA is based on AHRI 1230 Cooling Standard Condition (Indoor Temp : 26.7°C/80°F(DB) / 19.46°C/67°F(WB), Outdoor Temp : 35°C/95°F(DB))

2. Voltage Tolerance is ± 10%
3. Maxium allowable voltage between phases is 2%
4. Refer to module combination table for independent units information

- Symbols: 1. RLA : Rated Load Ampere
2. FLA : Full Load Ampere
 3. MCA : Minimum Circuit Ampere (A)
 4. MOP : Maxium Overcurrent Protective Device(A)

Electrical wiring work

3. Heat Pump/Heat Recovery (220V) (AM***K* Series)

		Units		Module1						Module2					
				RLA		FLA		Power Supply		RLA		FLA		Power Supply	
Nom.Ton	Model	Hz	Volts	Comp1	Comp2	FAN1	FAN2	MCA	MOP	Comp1	Comp2	FAN1	FAN2	MCA	MOP
6TON	AM072*XVTF*	60	208/230	19.5	19.5	3.0	3.0	50.0	60.0						
8TON	AM096*XVTF*	60	208/230	28.4	28.4	3.0	3.0	70.0	80.0						
12TON	AM144*XVTF*	60	208/230	19.5	19.5	3.0	3.0	50.0	60.0	19.5	19.5	3.0	3.0	50.0	60.0
14TON	AM168*XVTF*	60	208/230	19.5	19.5	3.0	3.0	50.0	60.0	28.4	28.4	3.0	3.0	70.0	80.0
16TON	AM192*XVTF*	60	208/230	28.4	28.4	3.0	3.0	70.0	80.0	28.4	28.4	3.0	3.0	70.0	80.0
18TON	AM216*XVTF*	60	208/230	19.5	19.5	3.0	3.0	50.0	60.0	19.5	19.5	3.0	3.0	50.0	60.0
20TON	AM240*XVTF*	60	208/230	19.5	19.5	3.0	3.0	50.0	60.0	19.5	19.5	3.0	3.0	50.0	60.0
22TON	AM264*XVTF*	60	208/230	19.5	19.5	3.0	3.0	50.0	60.0	28.4	28.4	3.0	3.0	70.0	80.0
24TON	AM288*XVTF*	60	208/230	28.4	28.4	3.0	3.0	70.0	80.0	28.4	28.4	3.0	3.0	70.0	80.0

		Units		Module3					
				RLA		FLA		Power Supply	
Nom.Ton	Model	Hz	Volts	Comp1	Comp2	FAN1	FAN2	MCA	MOP
6TON	AM072*XVTF*	60	208/230						
8TON	AM096*XVTF*	60	208/230						
12TON	AM144*XVTF*	60	208/230						
14TON	AM168*XVTF*	60	208/230						
16TON	AM192*XVTF*	60	208/230						
18TON	AM216*XVTF*	60	208/230	19.5	19.5	3.0	3.0	50.0	60.0
20TON	AM240*XVTF*	60	208/230	28.4	28.4	3.0	3.0	70.0	80.0
22TON	AM264*XVTF*	60	208/230	28.4	28.4	3.0	3.0	70.0	80.0
24TON	AM288*XVTF*	60	208/230	28.4	28.4	3.0	3.0	70.0	80.0

Note: 1. RLA is based on AHRI 1230 Cooling Standard Condition (Indoor Temp : 26.7°C/80°F(DB) / 19.46°C/67°F(WB), Outdoor Temp : 35°C/95°F(DB))

2. Voltage Tolerance is $\pm 10\%$

3. Maximum allowable voltage between phases is 2%

4. Refer to module combination table for independent units information

Symbols: 1. RLA : Rated Load Ampere

2. FLA : Full Load Ampere

3. MCA : Minimum Circuit Ampere (A)

4. MOP : Maximum Overcurrent Protective Device(A)

4. Heat Pump/Heat Recovery (460V) (AM***K* Series)

		Units		Module1						Module2					
				RLA		FLA		Power Supply		RLA		FLA		Power Supply	
Nom.Ton	Model	Hz	Volts	Comp1	Comp2	FAN1	FAN2	MCA	MOP	Comp1	Comp2	FAN1	FAN2	MCA	MOP
6TON	AM072*XVTJ*	60	460	11.1	11.1	1.5	1.5	28.0	35.0						
8TON	AM096*XVTJ*	60	460	15.5	15.5	1.5	1.5	38.0	45.0						
12TON	AM144*XVTJ*	60	460	11.1	11.1	1.5	1.5	28.0	35.0	11.1	11.1	1.5	1.5	28.0	35.0
14TON	AM168*XVTJ*	60	460	11.1	11.1	1.5	1.5	28.0	35.0	15.5	15.5	1.5	1.5	38.0	45.0
16TON	AM192*XVTJ*	60	460	15.5	15.5	1.5	1.5	38.0	45.0	15.5	15.5	1.5	1.5	38.0	45.0
18TON	AM216*XVTJ*	60	460	11.1	11.1	1.5	1.5	28.0	35.0	11.1	11.1	1.5	1.5	28.0	35.0
20TON	AM240*XVTJ*	60	460	11.1	11.1	1.5	1.5	28.0	35.0	11.1	11.1	1.5	1.5	28.0	35.0
22TON	AM264*XVTJ*	60	460	11.1	11.1	1.5	1.5	28.0	35.0	15.5	15.5	1.5	1.5	38.0	45.0
24TON	AM288*XVTJ*	60	460	15.5	15.5	1.5	1.5	38.0	45.0	15.5	15.5	1.5	1.5	38.0	45.0

		Units		Module3					
				RLA		FLA		Power Supply	
Nom.Ton	Model	Hz	Volts	Comp1	Comp2	FAN1	FAN2	MCA	MOP
6TON	AM072*XVTJ*	60	460						
8TON	AM096*XVTJ*	60	460						
12TON	AM144*XVTJ*	60	460						
14TON	AM168*XVTJ*	60	460						
16TON	AM192*XVTJ*	60	460						
18TON	AM216*XVTJ*	60	460	11.1	11.1	1.5	1.5	28.0	35.0
20TON	AM240*XVTJ*	60	460	15.5	15.5	1.5	1.5	38.0	45.0
22TON	AM264*XVTJ*	60	460	15.5	15.5	1.5	1.5	38.0	45.0
24TON	AM288*XVTJ*	60	460	15.5	15.5	1.5	1.5	38.0	45.0

Note: 1. RLA is based on AHRI 1230 Cooling Standard Condition (Indoor Temp : 26.7°C/80°F(DB) / 19.46°C/67°F(WB), Outdoor Temp : 35°C/95°F(DB))

2. Voltage Tolerance is ± 10%

3. Maxium allowable voltage between phases is 2%

4. Refer to module combination table for independent units information

Symbols: 1. RLA : Rated Load Ampere

2. FLA : Full Load Ampere

3. MCA : Minimum Circuit Ampere (A)

4. MOP : Maxium Overcurrent Protective Device(A)

Electrical wiring work



Caution for electrical work

- You must install ELCB or MCCB + ELB
 - ELCB: Earth leakage breaker
 - MCCB: Molded case circuit breaker
 - ELB: Earth leakage breaker
- Do not operate the outdoor unit before completing the refrigerant pipe work.
- Do not disconnect or change the cable inside the product. It may cause damage to the product.
- Specification of the power cable is selected based on following installation condition; culvert installation/ ambient temperature 30°C(86°F) / single multi conductor cables. If the condition is different from the ones stated, please consult an electrical installation expert and re-select the power cable.
 - If the length of power cable exceed 50m (164.04ft), re-select the power cable considering the voltage drop.
- Use a power cable made out of incombustible material for the insulator (inner cover) and the sheath (outer cover).
- Do not use the power cable with the core wire exposed due to insulator damage occurred during removal of the sheath. When the core wire is exposed, it may cause fire.

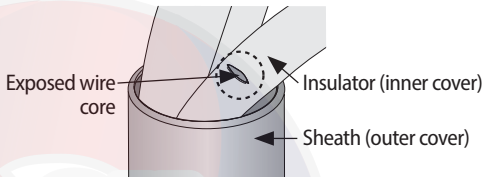

<The example of exposed core wire>

Power and communication cable configuration

- ▶ Main power and the ground cable must be withdrawn through the knock-out hole on the bottom-right or right side of the cabinet.
- ▶ Withdraw the communication cable from the designated knock-out hole on the bottom-right side of the front part.
- ▶ Install the power and communication cable using separate cable protection tube.
- ▶ Fix a protection tube to the knock-out hole on the outdoor unit by using a CD connector or bushing. Make sure to use insulating bushing.

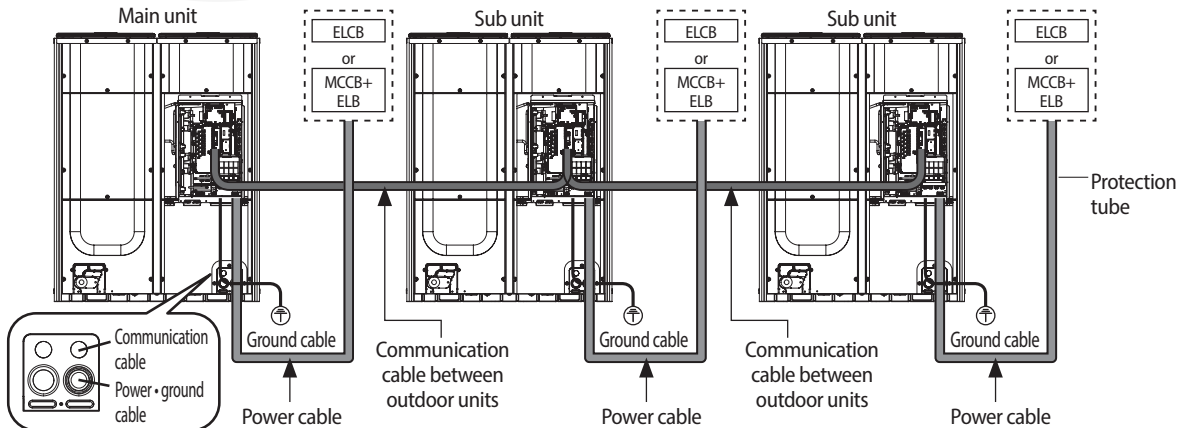

Specification of the protection tube

Name	Temper grade	Applicable conditions
Flexible PVC conduit	PVC	When the protection tube is installed indoor and not exposed to outside, because it is embedded in concrete structure
Class 1 flexible conduit	Galvanized steel sheet	When the protection tube is installed indoor but exposed to outside so there are risk of damage to the protection tube
Class 1 PVC coated flexible conduit	Galvanized steel sheet and Soft PVC compound	When the protection tube is installed outdoor and exposed to outside so there are risk of damage to the protection tube and extra waterproof is needed



CAUTION

Caution for perforating the knock-out hole

- Perforate a knock-out hole by punching it with a hammer.
- After perforating the knock-out hole, apply rust resisting paint around the hole.
- When you need to pass the cables through the knock-out hole, remove burrs on the hole and protection the cable with a protection tape or bushing etc.

Caution for installing communication cable

- When you connect the cable, it may sag and pressed by other parts. Therefore cables should be fixed to a clamp highlighted with a box on the illustration.

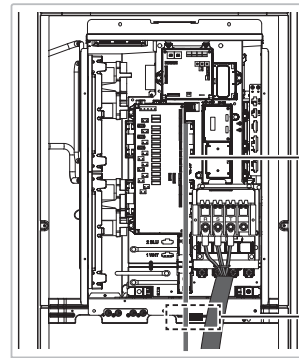

Path for arranging external communication cable

Fixing location of the external communication cable

Electrical wiring work

Power wiring diagram

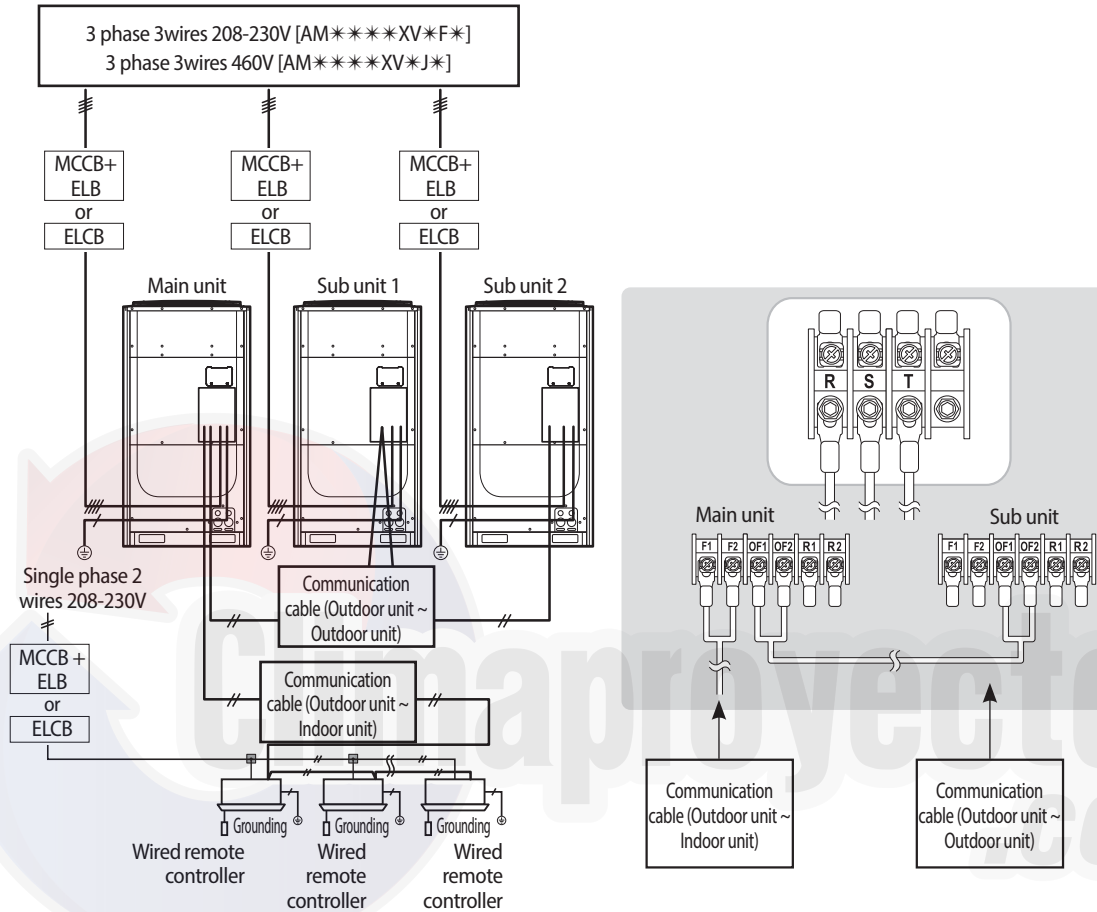

- ▶ Connect a power cable of the outdoor unit after checking that R-S-T (3 phase 3 wire) is properly connected.
- ▶ Malfunction may occur if one or more of the wires among R-S-T phases (3 Phases-3 Wires) are not connected properly. (*Malfunction: Turning on/off, occurrence of error, consecutive reset)
- ▶ Communication cable between indoor and outdoor units and communication cable between outdoor units has no polarity.
- ▶ Arrange the cables with a cable tie.
- * ELCB and ELB must be installed since there is risk of electric shock or fire when they are not installed.

Selecting solderless ring terminal

- ▶ Select a solderless ring terminal for a power cable according to the nominal dimensions for cable.
- ▶ Apply insulation coating to the connection part of the solderless ring terminal and the power cable.

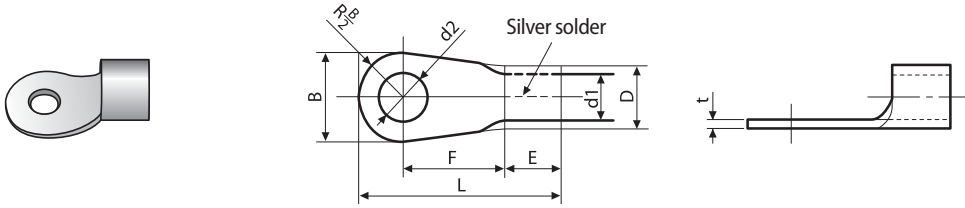

Nominal dimensions for cable [mm ² (inch ²)]		4/6 (0.006/0.009)		10 (0.01)	16 (0.02)	25 (0.03)		35 (0.05)		50 (0.07)	70 (0.10)
Nominal dimensions for screw [mm (inch)]		4 (3/8)	8 (3/16)	8 (3/16)	8 (3/16)	8 (3/16)	8 (3/16)	8 (3/16)	8 (3/16)	8 (3/16)	8 (3/16)
B	Standard dimension [mm (inch)]	9.5 (3/8)	15 (9/16)	15 (9/16)	16 (10/16)	12 (1/2)	16.5 (10/16)	16 (10/16)	22 (7/8)	22 (7/8)	24 (1)
	Allowance [mm (inch)]	±0.2 (±0.007)		±0.2 (±0.007)	±0.2 (±0.007)	±0.3 (±0.011)		±0.3 (±0.011)		±0.3 (±0.011)	±0.4 (±0.015)
D	Standard dimension [mm (inch)]	5.6 (1/4)		7.1 (1/4)	9 (3/8)	11.5 (7/16)		13.3 (1/2)		13.5 (1/2)	17.5 (1/2)
	Allowance [mm (inch)]	+0.3 (+0.011) -0.2 (-0.007)		+0.3 (+0.011) -0.2 (-0.007)	+0.3 (+0.011) -0.2 (-0.007)	+0.5 (+0.019) -0.2 (-0.007)		+0.5 (+0.019) -0.2 (-0.007)		+0.5 (+0.019) -0.2 (-0.007)	+0.5 (+0.019) -0.4 (-0.015)
d1	Standard dimension [mm (inch)]	3.4 (1/8)		4.5 (3/16)	5.8 (1/4)	7.7 (5/16)		9.4 (3/8)		11.4 (7/16)	13.3 (1/2)
	Allowance [mm (inch)]	±0.2 (±0.007)		±0.2 (±0.007)	±0.2 (±0.007)	±0.2 (±0.007)		±0.2 (±0.007)		±0.3 (±0.011)	±0.4 (±0.015)
E	Min. [mm (inch)]	6 (1/4)		7.9 (5/16)	9.5 (5/16)	11 (3/8)		12.5 (1/2)		17.5 (11/16)	18.5 (3/4)
F	Min. [mm (inch)]	5 (3/16)	9 (3/8)	9 (3/8)	13 (1/2)	15 (5/8)	13 (1/2)	13 (1/2)	13 (1/2)	14 (9/16)	20 (3/4)
L	Max. [mm (inch)]	20 (3/4)	28.5 (1-1/8)	30 (1-3/16)	33 (1-5/16)	34 (1-3/8)		38 (1-1/2)	43 (1-11/16)	50 (2)	51 (2)
d2	Standard dimension [mm (inch)]	4.3 (3/16)	8.4 (1-3/16)	8.4 (1-3/16)	8.4 (1-3/16)	8.4 (1-3/16)	8.4 (1-3/16)	8.4 (1-3/16)	8.4 (1-3/16)	8.4 (1-3/16)	8.4 (1-3/16)
	Allowance [mm (inch)]	+0.2 (+0.007) 0 (0)	+0.4 (+0.015) 0 (0)	+0.4 (+0.015) 0 (0)	+0.4 (+0.015) 0 (0)	+0.4 (+0.015) 0 (0)		+0.4 (+0.015) 0 (0)		+0.4 (+0.015) 0 (0)	+0.4 (+0.015) 0 (0)
t	Min. [mm (inch)]	0.9 (0.03)		1.15 (0.04)	1.45 (0.05)	1.7 (0.06)		1.8 (0.07)		1.8 (0.07)	2.0 (0.078)

Electrical wiring work

Connecting the power terminal

- ▶ Connect the cables to the terminal board with solderless ring terminals.
- ▶ Properly connect the cables by using certified and rated cables and make sure to fix them properly so that external force is not applied to the terminal.
- ▶ Use a driver and wrench that can apply the rated torque when tightening the screws on the terminal board.
- ▶ Tighten the terminal screws by complying rated torque value. If the terminal is loose, fire can occur due to arc heat generation and if the terminal is too tight, terminal board could get damaged.

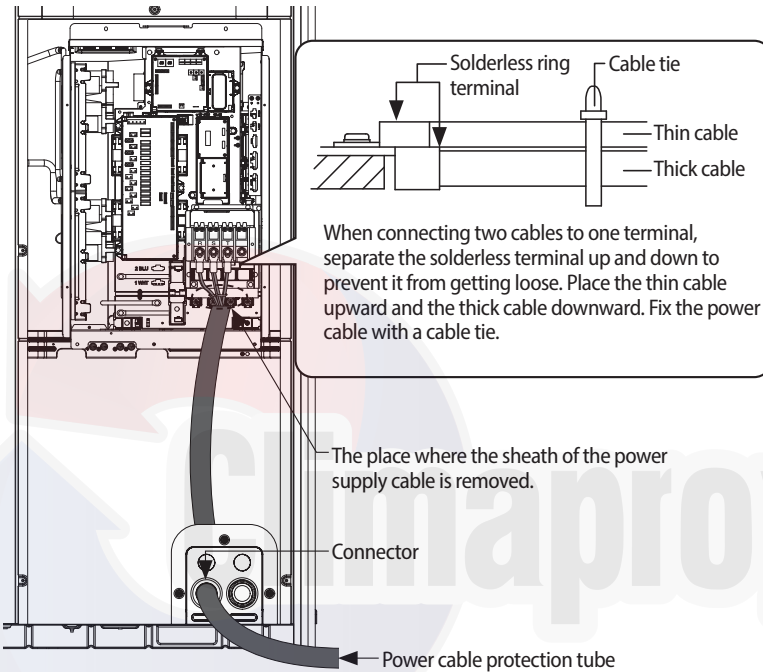

- When removing the outer sheath of the power supply cable, be careful not to scratch the inner sheath of the cable.
- Make sure that more than 20 mm (0.79 inch) of the outer sheath of the indoor unit power and communication cable are inside the electrical component box.
- Install the communication cable separately from power cable and other communication cables.

Screw	Tightening torque for terminal		Remarks
	N·m	lbf·ft	
M4	1.2~1.8	0.9~1.3	Single phase 208~230V power cable
M8	5.5~7.3	4.1~5.4	3 phase 208~230V / 460V power cable

Examples of how to use the cable stripper

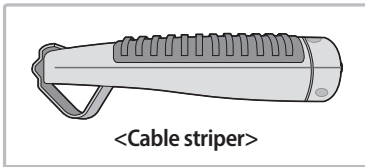

1. Adjust the blade position by coin. (Controller is at the bottom side of the tool.) Fix the blade position according to the outer sheath thickness of the power cable.
2. Fix the power cable and tool by using the hook at the top side of the tool.
3. Cut out the outer sheath of the power cable by revolving the tool in the direction of the arrow, two or three times.
4. At this situation, cut out the outer sheath of the power cable by moving the tool toward the direction of the arrow.
5. Slightly bend the wire and pull out the cut part of the outer sheath.

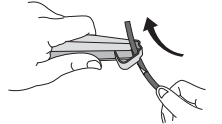
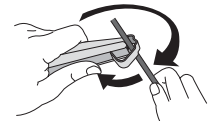
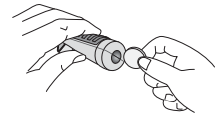

Electrical wiring work

Fixing the power cable

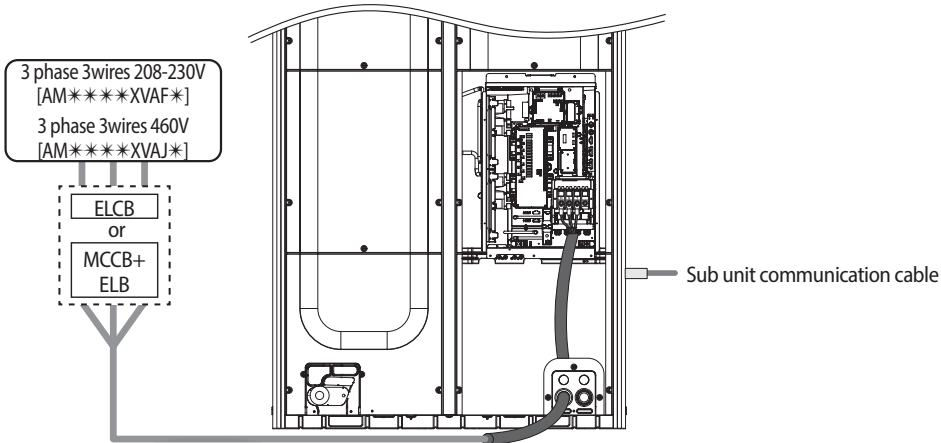

CAUTION

- Do not let the power cable come into contact with the pipes inside the outdoor unit. If the power supply cable touches the pipes, the vibration of the compressor is transferred to the pipes and can damage the power supply cables or pipes, creating the danger of fire or explosion.
- Make sure that the place where the sheath of power supply cable is removed is inside the power supply box. If it is impossible, you should connect the protection tube for power cable to the power supply box.
- After arranging the power cable into the power supply box, tighten the cover.

Connect the ring terminal of 3 phase cable

1. Cut the power cable to an appropriate length and connect it with the solderless terminal.
2. After connecting the power cable to the terminal as seen in the illustration, fix it with cable tie.
3. Fix the housing, which has an insulator, to the terminal board.

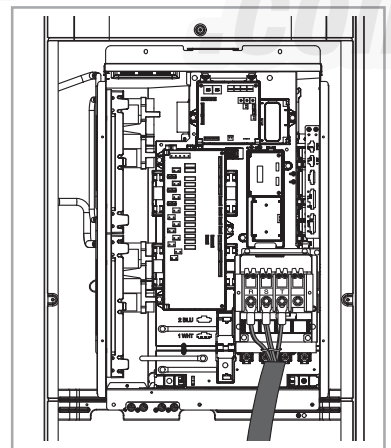

Fixing the ground cable

- ▶ Connect the ground cable to the grounding hole inside the power supply box.

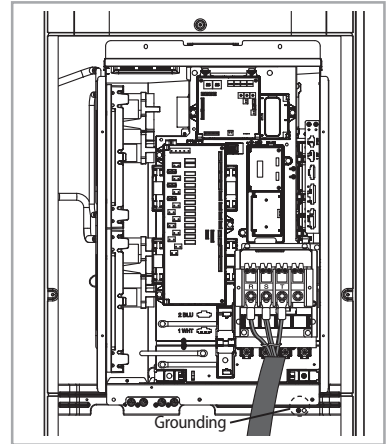

Withdrawing the power cable

- ▶ Withdrawing from the front side
 - Connect the power cable protection tube into the power supply box as shown picture.
 - Be sure that the power supply cable is not damaged by burr on the knock-out hole.

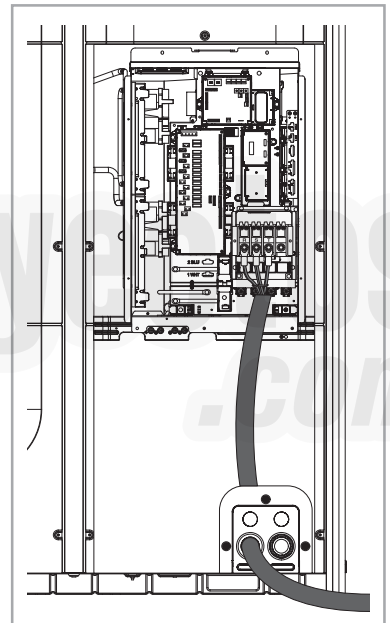

Electrical wiring work

Installing the Solution device

- ▶ When the number of indoor units installed with the outdoor unit is 16 or less

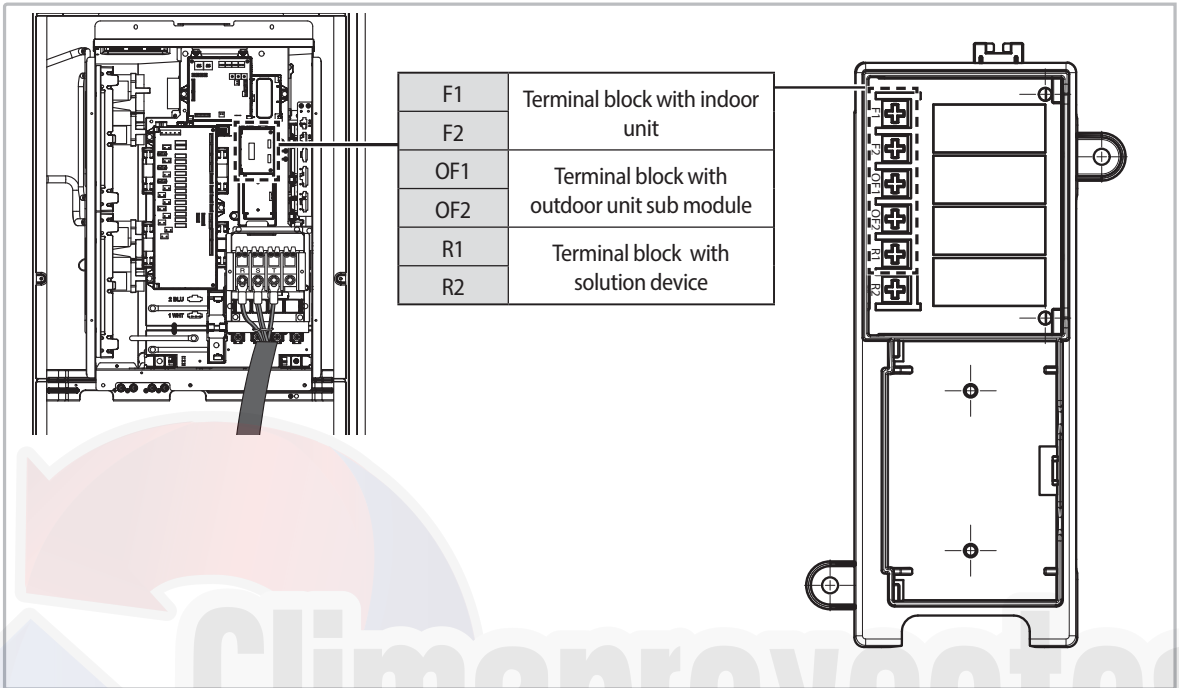

Climaproyectos
.com

Connecting the MCU

Example 1

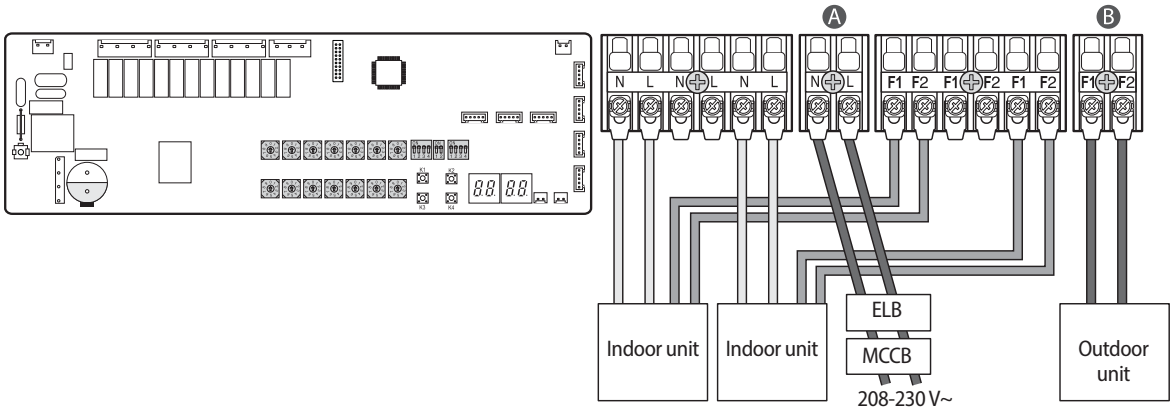

Example 2

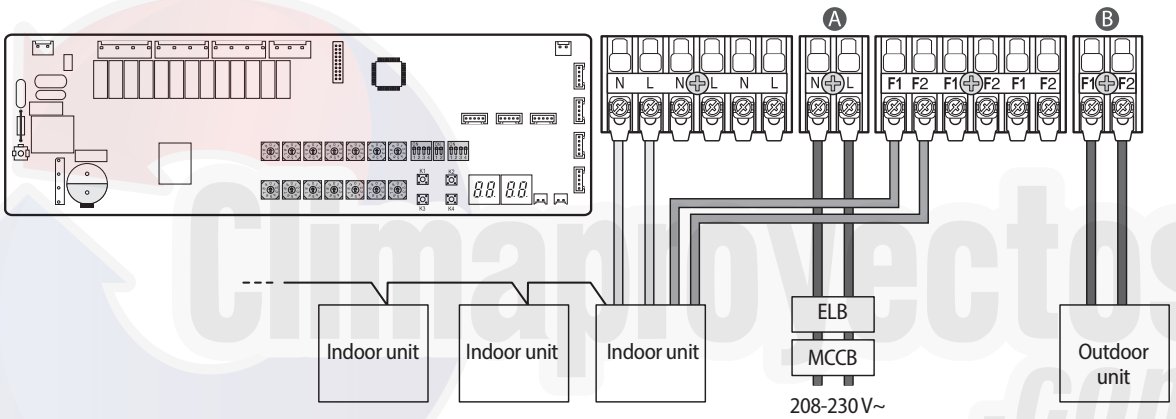

- ▶ **A** Power must be supplied to the MCU separately from the outdoor unit.
- ▶ **B** Connect the communication cable of the outdoor unit (F1, F2) to the communication cable of the MCU (F1, F2)



- Power cable connection should be done with the solderless ring terminal.

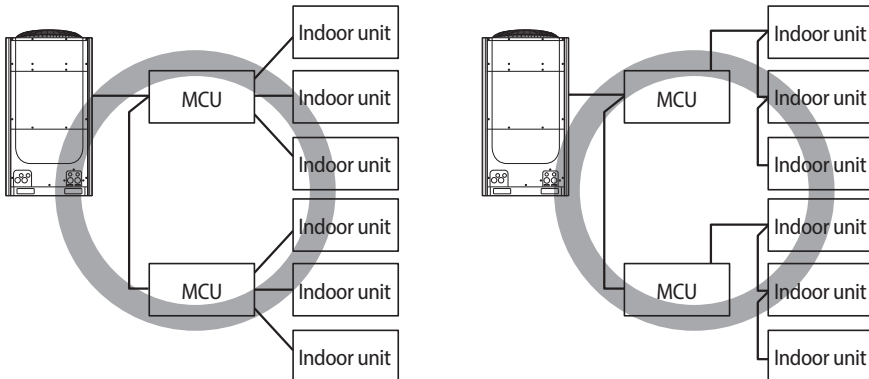

- When installing the MCU, communication cable can be connected as shown above.

Electrical wiring work

Grounding work

Grounding must be done by a qualified installer for your safety.

Grounding the power cable

- ▶ The standard of grounding may vary according to the rated voltage and installation place of the air conditioner.
- ▶ Ground the power cable according to the following table.

Installation place	Power condition	
	Voltage to ground is lower than 150V	Voltage to ground is over 150V
High humidity	Must perform the grounding work 3. ^{Note 1)} (Including the case where earth leakage breaker is installed)	
Average humidity	Perform grounding work 3. ^{Note 1)}	Must perform the grounding work 3. ^{Note 1)} (Including the case where earth leakage breaker is installed)
Low humidity	Perform grounding work 3, if possible, for your safety. ^{Note 2)}	

Note 1) About grounding work 3.

- Grounding work must be done by an expert (with qualification).
- Check if the grounding resistance is lower than 100Ω. When installing a earth leakage breaker (that can cut the electric circuit within 0.5 second in case of a short circuit), allowable grounding resistance should be 30~500Ω.

Note 2) Grounding at dry place

- The grounding resistance should be lower than 100Ω. Even in worst case, grounding resistance should be lower than 250Ω.

Performing the grounding work

- ▶ Use a rated grounding cable by referring to the specification of the electric cable for the outdoor unit.

* When using the exclusive grounding terminal (When the grounding terminal is already built on the house)

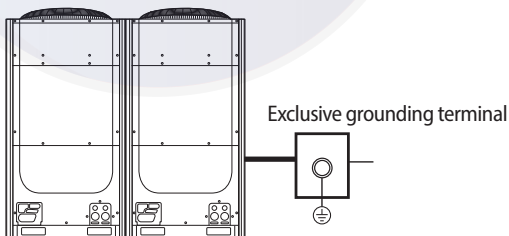

* When using grounding of the switch board

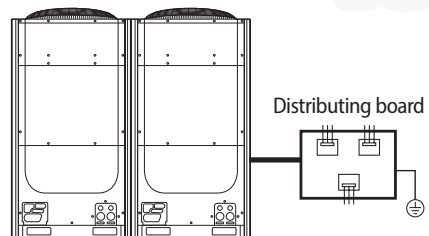

Air tightness test and vacuum drying

Air tightness test

- ▶ Use tools for R-410A to prevent the inflow of foreign substances and resist against the internal pressure.
- ▶ Do not remove the core of filling port.
- ▶ Use Nitrogen gas for air tightness test as shown in the illustration.

H/P

H/R

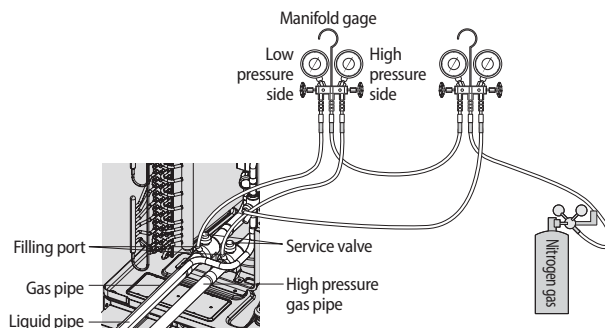
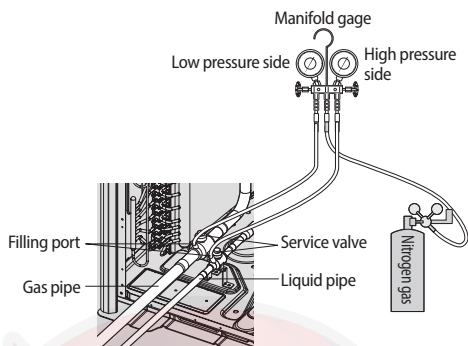

Apply pressure to the liquid side pipe and gas side pipe (when installing outdoor units in module) with Nitrogen gas at 4.1MPa(594.6psi).

If you apply pressure at more than 4.1MPa(594.6psi), pipes may get damaged. Apply pressure with pressure regulator and pay attention to the pressure of the nitrogen.

Keep it for minimum 24 hours to check if pressure drops.

After applying Nitrogen gas, check there's any change of pressure, using a pressure regulator.

If the pressure drops, check for gas leakage.

If the pressure is changed, apply soap water to check for leakage and check the pressure of the nitrogen gas again.

Maintain 1.0MPa(145psi) of the pressure before performing vacuum drying and check for further gas leakage.

After checking the first gas leakage, maintain 1.0MPa(145psi) to check for further gas leakage.



- Perform a Nitrogen gas leak test with the service valve of the outdoor unit closed.
- When charging the nitrogen gas, charge it from the both (high-low pressure) sides.
- If the pipe is filled in a short time with a highly excessive pressure of Nitrogen gas, the pipes may get damaged. Make sure to use a regulator to prevent the high pressure Nitrogen gas, over 4.1MPa(594.6psi), from entering into the pipe.

Air tightness test and vacuum drying

Vacuum drying pipes and indoor units

- ▶ Use tools for R-410A to prevent the inflow of foreign substances and resist against the internal pressure.
- ▶ Use vacuum pump that allows vacuuming under -100.7kPa (5 Torr).
- ▶ Use the vacuum pump with the check valve to prevent pump oil from flowing backward while the vacuum pump is stopped.
- ▶ Completely close the liquid-gas side service valve of the outdoor unit.

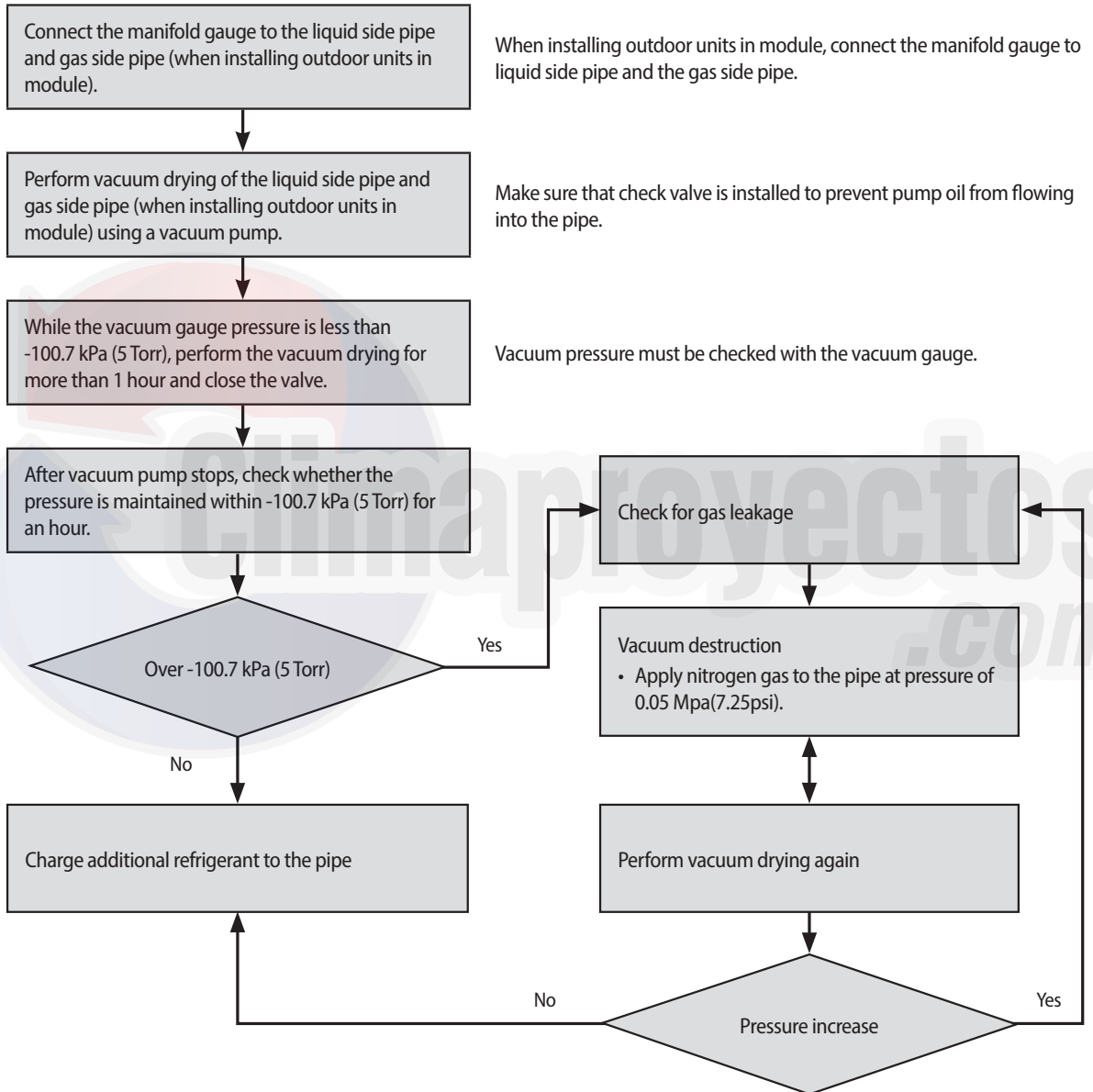

- * If the pressure rises in an hour, either water is remaining inside the pipe or there is a leakage.
- * When the ambient temperature of vacuuming pipe is low (less than 0°C (32°F)), moisture might remain within the pipe. Therefore, pay special attention to the pipe sealing in the winter.

Pipe insulation

Insulating the refrigerant pipes and branch joints

- ▶ Check for gas leakage before completing (the hose and pipe insulation) and if there is no sign of leakage, make sure to insulate the pipes and hoses.
- ▶ Use EPDM material insulator that meets the following conditions.

Test item	Unit	Standard
Density	g/cm ³	0.048~0.096
Dimensional change rate by heat	%	Below -5
Absorption rate	g/cm ³	Below 0.005
Thermal conduction rate	W/m·K	Below 0.037
Moisture transpiration factor	ng/(m ² ·s·Pa)	Below 15
Moisture transpiration grade	g/(m ² ·24h)	Below 15
Formaldehyde dispersion	mg/L	There should be none
Oxygen rate	%	Over 25

Selecting the refrigerant pipe insulator

- ▶ Insulate the gas pipe and liquid pipe by referring to the thickness of insulator for each pipe size.
- ▶ The standard condition is; temperature at 30°C, humidity less than 85%. If case if the humidity is higher, you must increase the size by one grade as stated in below table.

Pipe	Outer diameter		Insulator (Cooling, Heating)				Remarks
			General [30°C (86°F), 85%]		High humidity [30°C (86°F), over 85%]		
			EPDM, NBR				
mm	inch	mm	inch	mm	inch		
Liquid pipe	6.35~9.52	1/4~3/8	9	3/8	9	3/8	Heating resisting temperature over 120°C(248°F)
	12.7~50.8	1/2~2	13	1/2	13	1/2	
Gas pipe	6.35	1/4	13	1/2	19	3/4	
	9.52~25.4	3/8~1	19	3/4	25	1	
	28.58~44.45	1 1/8~1 3/4	19	3/4	32	1 1/4	
	50.8	2	25	1	38	1 1/2	

- * When installing insulation in places and conditions below, use the same insulation that is used for high humidity conditions.
- <Geological condition>
- High humidity places such as shoreline, hot spring, near lake or river, and ridge (when the part of the building is covered by earth and sand.)
- <Operation purpose condition>
- Restaurant ceiling, sauna, swimming pool etc.
- <Building construction condition>
- The ceiling frequently exposed to moisture and cooling is not covered. (e.g. The pipe installed at a corridor of a dormitory and studio or near an exit that opens and closes frequently.)
 - The place where the pipe is installed is highly humid due to the lack of ventilation system.

Pipe insulation

Insulate the refrigerant pipe

- ▶ Make sure to insulate the refrigerant pipe, branch joint, distribution header, and the connection part of the pipes.
- ▶ If you insulate the pipes, condensed water will not fall from the pipes.
- ▶ Check if there are any cracks on the insulation at the bent part of the pipe.

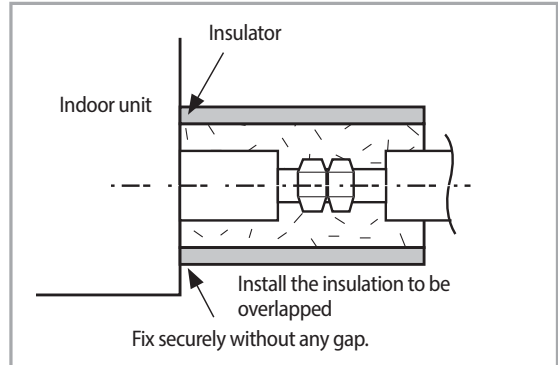
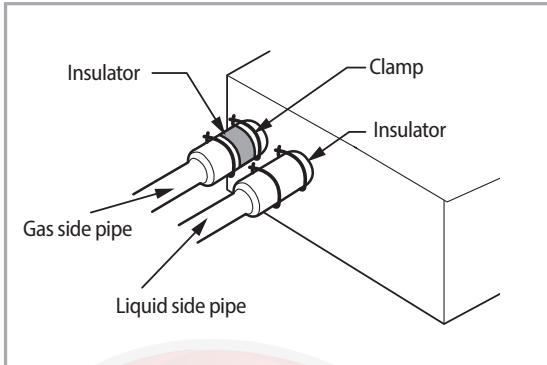

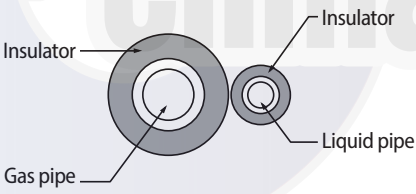
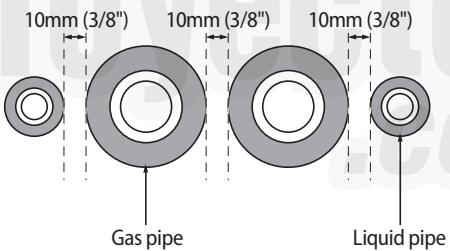
Insulating pipes	Insulating pipes connected behind the EEV kit
<ul style="list-style-type: none"> • The insulation of the gas and liquid pipes can be in contact with each other but they should not press excessively against each other. • When the gas side and liquid side pipes are contacting each other, increase the thickness of the insulation by one grade.  <p>The diagram shows a cross-section of a 'Gas pipe' and a 'Liquid pipe'. Each pipe is surrounded by its own 'Insulator'. The insulation on the gas pipe is thicker than the insulation on the liquid pipe.</p>	<ul style="list-style-type: none"> • When installing the gas side and liquid side pipes, leave at least 10mm (3/8") of space. • When the gas side and liquid side pipes are contacting each other, increase the thickness of the insulation by one grade.  <p>The diagram shows a cross-section of a 'Gas pipe' and a 'Liquid pipe' with '10mm (3/8")' gaps between them. The insulation on the gas pipe is thicker than the insulation on the liquid pipe. The diagram illustrates the required spacing and insulation thickness.</p>



- Install the insulation without any gaps or cracks and use adhesive on the connection part of it to prevent moisture from entering.
- Bind the refrigerant pipe with insulation tape if it is exposed to outside sunlight. (When binding the pipe with finishing tape, be careful not to reduce the thickness of the insulation.)
- Install the refrigerant pipe respecting that the insulation does not get thinner on the bent part or hanger of pipe.
- When the thickness of insulation is reduced, reinforce the reduced thickness with additional insulation.

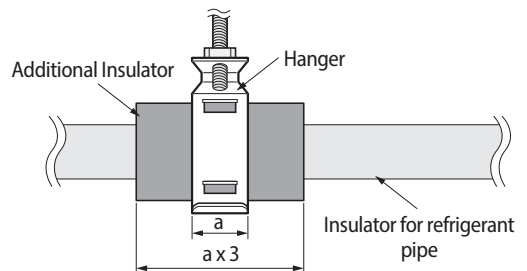

Insulate the distribution header

- ▶ Fix the distribution header with a cable tie and cover the connected part.
- ▶ Insulate the distribution header and the welded part and wrap the connected part with an adhesive insulation tape to prevent dew formation.

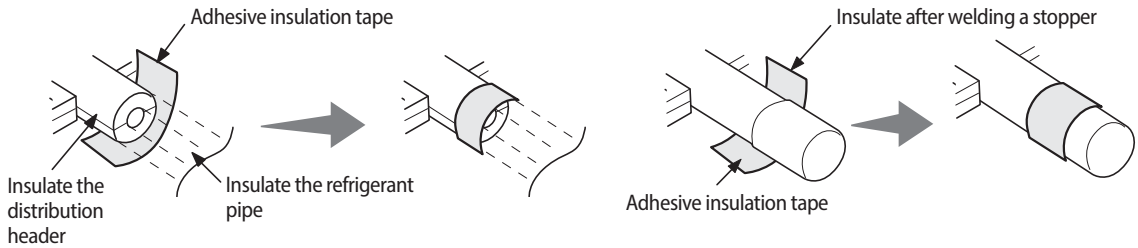
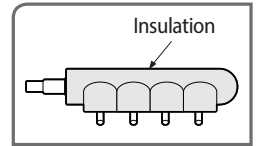

- ▶ Fix the distribution header with a hanger after insulating it.

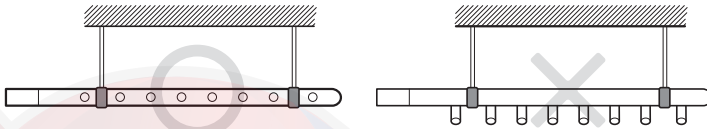

Insulating the branch joint

- ▶ Tightly attach the insulator, provided with the branch joint, to the separately purchased insulator. Wrap the connected part with an insulator (separately purchased item) that has thickness of at least 10mm (0.39 inch).
- ▶ Use an insulator that resist heat up to 120°C. Wrap the branch joint with an insulation that has thickness of at least 10mm (0.39 inch).

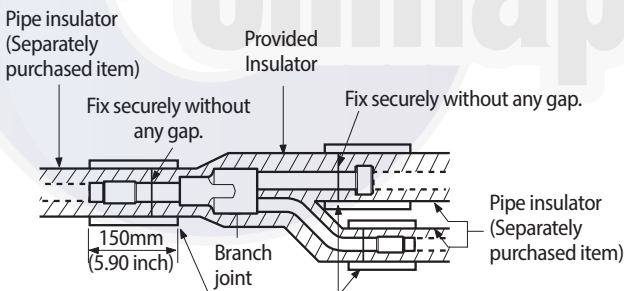

Thickness of the insulator (Separately purchased item) should be thicker than 10mm (0.39 inch).

Insulation tape (Separately purchased item)

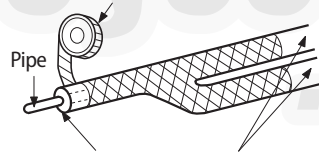

Pipe insulator (Separately purchased item)

- * Attach the adhesive insulation tape to the pipe, as shown in the picture, after insulating the pipe.

Pipe insulation

Insulating the pipe located inside of the outdoor unit

- ▶ With a pipe insulator, insulate the pipe up to whole service valve located inside of the outdoor unit.
- ▶ Seal the gap between the outdoor unit pipe and the insulator. Rainwater and dewdrops may soak through the gap between the pipe and the insulation of the outdoor unit installed on the outside.
- ▶ Separate the cover of the pipe and close it after insulation work. Only remove a knock-out hole cover where the pipe will be installed. If the knock-out hole is open unnecessarily, it must be closed. If not, small animals such as squirrels and rats may get into the unit through the hole and the unit may be damaged.

H/P

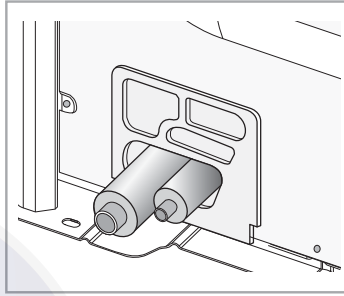
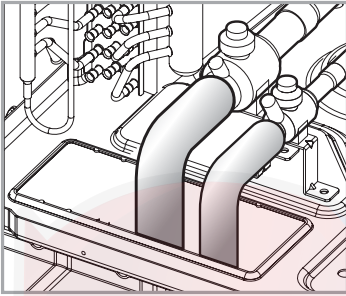

H/R

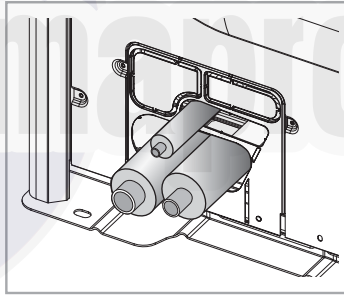
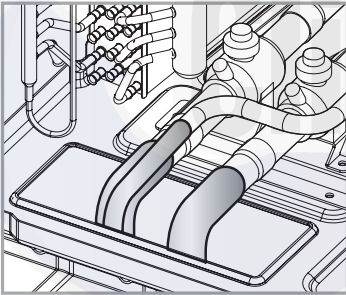

Charging additional refrigerant

- ▶ R-410A refrigerant is blended refrigerant. Add refrigerant in liquid form only. (Make sure to use the refrigerant bomb in upright position)
- ▶ Measure the quantity of the refrigerant according to the length of the liquid side pipe. Add fixed quantity of the refrigerant using a scale.

Single installation

- ▶ Open the manifold gauge valve connected to the liquid side service valve and add the liquid refrigerant.
- ▶ If you cannot add the whole quantity of the refrigerant while the outdoor unit is stopped, open the gas side and liquid side service valve. Then, add remaining refrigerant by pressing the refrigerant adding button of the outdoor PCB.

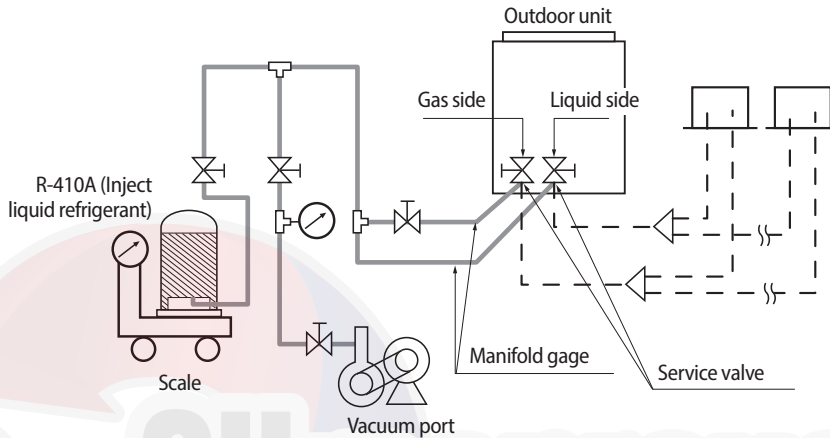

Charging additional refrigerant

Module installation

- ▶ Open the manifold gauge valve connected to the liquid side service valve and add the liquid refrigerant.
- ▶ If you cannot add the whole quantity of the refrigerant while the outdoor unit is stopped, open the gas side and liquid side service valve. Then, add remaining refrigerant by pressing the refrigerant adding button of the outdoor PCB.
- ▶ If you use the refrigerant charging function from the PCB, outdoor unit will operate and charge the refrigerant. At this time, you must use gas side manifold gauge for cooling operation and use charging port for heating at the manifold gauge for heating operation.

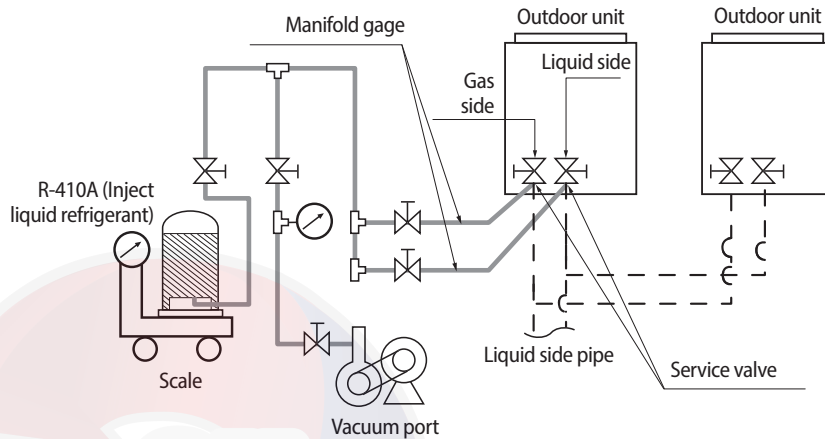

- Open the gas side and liquid side service valve completely after charging the refrigerant. (If you operate the air conditioner with the service valve closed, the important parts may be damaged.)
- Put on safety equipment when charging refrigerant.
- Do not charge the refrigerant when you adjust or control other product such as indoor units or EEV kits.
- If you charge the refrigerant with the front cabinet open, be very careful with the fan on the top of the product to prevent personal injury.
- When the ambient temperature is low in winter time, do not heat the refrigerant container to speed up the charging process. There is risk of explosion.
- Beware for possibility of refrigerant leakage when you connect the manifold gauge to the charging port for heating.
- Close the valve of the refrigerant container immediately after charging the refrigerant. If not, there might be a change in entire amount of refrigerant.

Using service valve for gas

- ▶ After charging the refrigerant, close all caps as shown in the illustration.
- ▶ Tightening torque for the cap of refrigerant charging port 10~12N·m (7.4 ~ 8.9 lbf·ft)
- ▶ Tightening torque for the cap of control part 20~25N·m (14.8 ~ 18.4 lbf·ft)
- ▶ Opening/closing torque for the valve
 - Over Ø19.05mm (Ø3/4inch) : 10 N·m (7.4 lbf·ft)

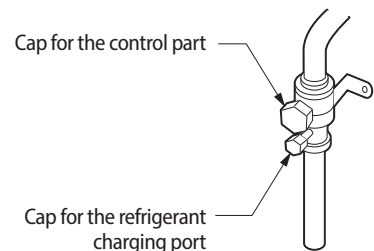

Basic segment display

Step	Display content	Display			
At initial power input	Checking segment display	SEG 1	SEG 2	SEG 3	SEG 4
		"8"	"8"	"8"	"8"
While setting communication between indoor and outdoor unit (Addressing)	Number of connected indoor units	SEG 1	SEG 2	SEG 3	SEG 4
		"A"	"d"	Number of communicated units * Refer to "View Mode" for communication address	
After communication setting (usual occasion)	Transmit/Reception address	SEG 1	SEG 2	SEG 3	SEG 4
		I/U: "A" MCU: "C"	I/U: "0" MCU: "1"	Reception address (in decimal number)	

* I/U : Indoor unit

Setting outdoor unit option switch and key function

Setting outdoor unit option switches

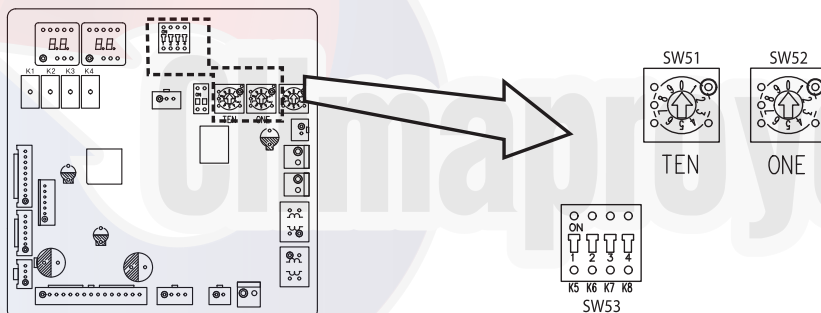

* If you install HR products, you must match the address between the MCU and the indoor unit.

Switch	Setting	Function	Remarks	
SW51 / SW52		Setting total number of installed indoor unit SW51: Tens digit, SW52: Units digit	Setting can be done from the main outdoor unit only (sub unit: setting is unnecessary) Ex) When 12 indoor units are installed → SW51: 1, SW52: 2	
SW53	K6	On	Enable maximum capacity restriction for cooling operation	Restrict excessive capacity increase when operating indoor units with small capacity
		Off	Disable maximum capacity restriction for cooling operation	-
	K7	K8	Selecting outdoor unit address	
	On	On	Outdoor unit address: No. 1	Main unit
	On	Off	Outdoor unit address: No. 2	Sub unit 1
	Off	On	Outdoor unit address: No. 3	Sub unit 2
Off	Off	Outdoor unit address: No. 4	Sub unit 3	
SW57		Setting total number of connected MCU	Setting can be done from Main unit only. Ex) When 3 MCUs are installed → SW57:3, When 10 MCUs are installed → SW57:A	

Setting outdoor unit option switch and key function

Setting outdoor unit key function

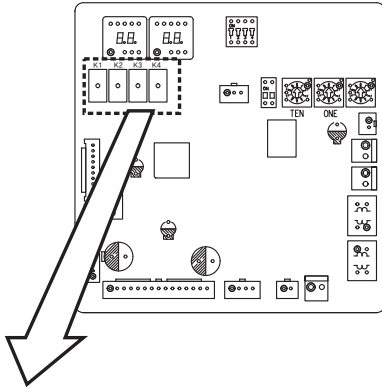

Installing and setting the option with tact switch and explanation of the functions

Setting the option

1. Press and hold K2 to enter the option setting. (Only available when the operation is stopped)
 - If you enter the option setting, display will show the following. (If you have set the 'Emergency operation for compressor malfunction', 1 or 2 will be displayed on Seg 4.)



- Seg 1 and Seg 2 will display the number for selected option.
 - Seg 3 and Seg 4 will display the number for set value of the selected option.
2. If you have entered option setting, you can shortly press the K1 switch to adjust the value of the Seg 1, Seg 2 and select the desired option. (Refer to pages 79~81 for the Seg number of the function for each option)

Example)

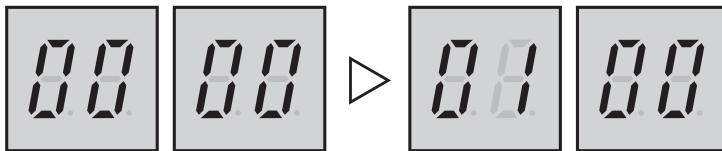

3. If you have selected desired option, you can shortly press the K2 switch to adjust the value of the Seg 3, Seg 4 and change the function for the selected option. (Refer to pages 79~81 for the Seg number of the function for each option)

Example)

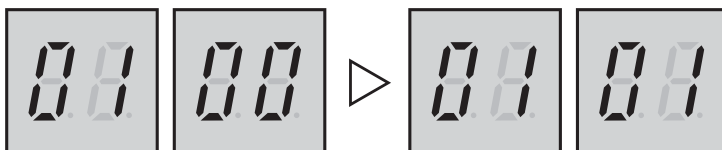

4. After selecting the function for options, press and hold the K2 switch for 2 seconds. Edited value of the option will be saved when entire segments blinks and tracking mode begins.

 • Edited option will not be saved if you do not end the option setting as explained in above instruction.

- * While you are setting the option, you may press and hold the K1 button to reset the value to previous setting.
- * If you want to restore the setting to factory default, press and hold the K4 button while you are in the option setting mode.
 - If you press and hold the K4 button, setting will be restored to factory default but it doesn't mean that restored setting is saved. Press and hold the K2 button. When the segments shows that tracking mode is in progress, setting will be saved.

Optional item	Input unit	SEG1	SEG2	SEG3	SEG4	Function of the option	Remarks
Emergency operation for compressor malfunction	Individual	0	0	0	0	Disabled (Factory default)	E560 will occur when all the compressors are set as malfunction state.
				0	1	Set compressor 1 as malfunction state	
				0	2	Set compressor 2 as malfunction state	
Cooling capacity correction	Main	0	1	0	0	7-9 (Factory default)	Targeted evaporation temperature [°C]. (When low temperature value is set, discharged air temperature of the indoor unit will decrease)
				0	1	5-7	
				0	2	9-11	
				0	3	10-12	
				0	4	11-13	
				0	5	12-14	
Capacity correction for heating	Main	0	2	0	0	3.0 (Factory default)	Targeted high pressure [MPa]. (When low pressure value is set, discharged air temperature of the indoor unit will decrease)
				0	1	2.5	
				0	2	2.6	
				0	3	2.7	
				0	4	2.8	
				0	5	2.9	
				0	6	3.1	
				0	7	3.2	
Current restriction rate	Individual	0	3	0	0	100% (Factory default)	When restriction option is set, cooling and heating performance may decrease.
				0	1	95 %	
				0	2	90 %	
				0	3	85 %	
				0	4	80 %	
				0	5	75 %	
				0	6	70 %	
				0	7	65 %	
				0	8	60 %	
				0	9	55 %	
				1	0	50 %	
Oil collection interval	Main	0	4	0	0	Factory default	
				0	1	Shorten the interval by 1/2	

Setting outdoor unit option switch and key function

Optional item	Input unit	SEG1	SEG2	SEG3	SEG4	Function of the option	Remarks
Temperature to trigger defrost operation	Main	0	5	0	0	Factory default	
				0	1	Apply setting when the product is being installed in humid area such as near river or lake	
Fan speed correction for outdoor unit	Individual	0	6	0	0	Factory default	
				0	1	Increase fan speed	Increase the outdoor unit's fan speed to maximum value
Silent mode for night-time	Main	0	7	0	0	Disabled (Factory default)	Enables the silent mode for night-time (It operates automatically depending on the temperature.) However, if the external contact interface module (MIM-B14) is used, entering the silent mode is available with contact signal.
				0	1	LEVEL 1 / Auto	
				0	2	LEVEL 2 / Auto	
				0	3	LEVEL 3 / Auto	
				0	4	LEVEL 1 / External contact	
				0	5	LEVEL 2 / External contact	
High-head condition setting	Main	0	8	0	0	Disabled (Factory default)	
				0	1	Level 1 of height difference type 1 (Indoor unit is lower than outdoor unit)	When outdoor unit is located 40~80m above the indoor unit
				0	2	Level 2 of height difference type 1 (Indoor unit is lower than outdoor unit)	When outdoor unit is located over 80m above the indoor unit
				0	3	Height difference type 2 (Outdoor unit is lower than indoor unit)	When indoor unit is over 30 m above the outdoor unit
Long-pipng condition setting (Setting is unnecessary if high-head condition is set)	Main	0	9	0	0	Disabled (Factory default)	
				0	1	LEVEL 1	When equivalent length of farthest indoor unit from the outdoor unit is between 100~170m
				0	2	LEVEL 2	When equivalent length of farthest indoor unit from the outdoor unit is over 170m
Energy saving setting	Main	1	0	0	0	Disabled (Factory default)	
				0	1	Enabled	Energy saving mode triggers when the room temperature reaches desired temperature while operating in heating mode.
Rotation defrost (HR only)	Main	1	1	0	0	Disabled (Factory default)	
				0	1	Enabled	When enabled, continuous heating operation is possible but heating performance will decrease during rotation defrost operation

Optional item	Input unit	SEG1	SEG2	SEG3	SEG4	Function of the option	Remarks
Expand operational temperature range for cooling operation (HR only)	Main	1	2	0	0	Disabled (Factory default)	When enabled, continuous cooling operation is possible even in low temperature condition up to -15°C, but noise of the MCU will increase
				0	1	Enabled	
Channel address	Main	1	3	A	U	Automatic setting (Factory default)	Address for classifying the product from upper level controller (DMS, S-NET 3, etc.)
				0 ~ 15		Manual setting for channel 0~15	
Snow accumulation prevention control	Main	1	4	0	0	Enabled (Factory default)	During snow accumulation, the fan may spin even when the unit is not in operation
				0	1	Disabled	



Setting outdoor unit option switch and key function

Setting key operation and checking the view mode with tact switch

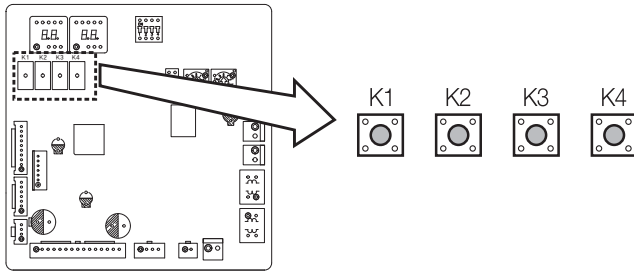

K1 control	KEY operation	Display on segment
Press and hold 1 time	Auto trial operation	"K""K""BLANK""BLANK"

K1 (Number of press)	KEY operation	Display on segment
1 time	Refrigerant charging in Heating mode	"K""1""BLANK""BLANK"
2 times	Trial operation in Heating mode	"K""2""BLANK""BLANK"
3 times	Pump out in Heating mode (Outdoor unit address 1)	"K""3""BLANK""1"
4 times	Pump out in Heating mode (Outdoor unit address 2)	"K""3""BLANK""2"
5 times	Pump out in Heating mode (Outdoor unit address 3)	"K""3""BLANK""3"
6 times	Pump out in Heating mode (Outdoor unit address 4)	"K""3""BLANK""4"
7 times	Vacuumig (Outdoor unit address 1)	"K""4""BLANK""1"
8 times	Vacuumig (Outdoor unit address 2)	"K""4""BLANK""2"
9 times	Vacuumig (Outdoor unit address 3)	"K""4""BLANK""3"
10 times	Vacuumig (Outdoor unit address 4)	"K""4""BLANK""4"
11 times	Vacuuming (All outdoor units)	"K""4""BLANK""A"
12 times	End Key operation	-

K2 (Number of press)	KEY operation	Display on segment
1 time	Refrigerant charging in Cooling mode	"K"5"BLANK"BLANK"
2 times	Trial operation in Cooling mode	"K"6"BLANK"BLANK"
3 times	Pump down all units in Cooling mode	"K"7"BLANK"BLANK"
4 times	H/R: Checking the pipe connection H/P: Automatic setting of operation mode (Cooling/ Heating) for trail operation	"K"8"BLANK"BLANK"
5 times	Checking the amount of refrigerant	"K"9" X X (Display of last two digits may differ depending on the progress)
6 times	Discharge mode of DC link voltage	"K"A"BLANK"BLANK"
7 times	Forced defrost operation	"K"B"BLANK"BLANK"
8 times	Forced oil collection	"K"C"BLANK"BLANK"
9 times	Inverter compressor 1 check	"K"D"BLANK"BLANK"
10 times	Inverter compressor 2 check	"K"E"BLANK"BLANK"
11 times	Fan 1 check	"K"F"BLANK"BLANK"
12 times	Fan 2 check	"K"G"BLANK"BLANK"
13 times	End Key operation	-

- * During "Discharge mode of DC link voltage", voltage of INV1 and INV2 will be displayed alternately.
- * Even when the outdoor unit power is off, it is dangerous when you come in contact with inverter PCB and fan PCB since they are charged with high DC voltage.
- * When pressing K2 key 9 to 12 times without inverter checker, error code can be displayed on segment even though the outdoor unit is normal.
- * When replacing/repairing the PCB, cut-off the power and wait until the DC voltage is discharged before replacing/repairing them. (Wait for more than 15 minutes to allow it to discharge naturally.)
- * When there were error, 'Discharge mode of DC link voltage' may not have been effective. Especially if error E464 and E364 have been occurred, power element might be damaged by fire and therefore, do not use the 'Discharge mode of DC link voltage'.

K3 (Number of press)	KEY operation	Display on segment
1 time	Intialize (Reset) setting	Same as initial state

Setting outdoor unit option switch and key function

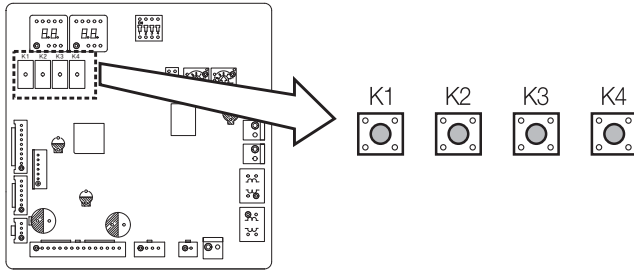

K4 (Number of press)	KEY operation	Display on segment	
		SEG 1	SEG2, 3, 4
1 time	Outdoor unit model	1	(a) Capacity → Off, 1, 4
2 times	Order frequency of the compressor 1	2	120 Hz → 1, 2, 0
3 times	Order frequency of the compressor 2	3	120 Hz → 1, 2, 0
4 times	High pressure (MPa)	4	1.52 MPa → 1, 5, 2
5 times	Low pressure (MPa)	5	0.43 MPa → 0, 4, 3
6 times	Discharge temperature (Compressor 1)	6	87 °C → 0, 8, 7
7 times	Discharge temperature (Compressor 2)	7	87 °C → 0, 8, 7
8 times	IPM temperature (Compressor 1)	8	87 °C → 0, 8, 7
9 times	IPM temperature (Compressor 2)	9	87 °C → 0, 8, 7
10 times	CT sensor value (Compressor 1)	A	2 A → 0, 2, 0
11 times	CT sensor value (Compressor 2)	B	2 A → 0, 2, 0
12 times	Suction temperature	C	-42 °C → -, 4, 2
13 times	COND OUT temperautre	D	-42 °C → -, 4, 2
14 times	Temperature of liquid pipe	E	-42 °C → -, 4, 2
15 times	TOP temperature (Compressor 1)	F	-42 °C → -, 4, 2
16 times	TOP temperature (Compressor 2)	G	-42 °C → -, 4, 2
17 times	Outdoor temperature	H	-42 °C → -, 4, 2
18 times	ESC inlet temperature	I	-42 °C → -, 4, 2
19 times	ESC outlet temperature	J	-42 °C → -, 4, 2
20 times	Main EEV1 step	K	2000 steps → 2, 0, 0
21 times	Main EEV2 step	L	2000 steps → 2, 0, 0
22 times	ESC EEV step	M	300 steps → 3, 0, 0
23 times	HR EEV step	N	300 steps → 3, 0, 0
24 times	Fan step (SSR or BLDC)	O	13 steps → 0, 1, 3
25 times	Current frequency (Compressor 1)	P	120 Hz → 1, 2, 0
26 times	Current frequency (Compressor 2)	Q	120 Hz → 1, 2, 0

K4 (Number of press)	KEY operation	Display on segment	
		SEG 1	SEG2, 3, 4
27 times	Suction 2 temperature	R	-42 °C → -, 4, 2
28 times	Master indoor unit address	S	Master indoor unit not selected → BLANK, N, D If indoor unit No.1 is selected as the master unit → 0, 0, 1

(a) When pressing K4 key 1 time, below number is displayed on segment depending on model.

Model	Display on segment
AM072***	Off, 0, 8
AM096***	Off, 1, 0
AM120***	Off, 1, 2
AM144***	Off, 1, 4
AM168***	Off, 1, 8
AM192***	Off, 2, 0

K4 (Number of press) Press and hold the K4 to enter the setting	Displayed content	Display on segment			
		page1	page2		
1 time	Main version	MAIN	Version (ex. 1412)		
2 times	Hub version	HUB	Version (ex. 1412)		
3 times	Inverter 1 version	INV1	Version (ex. 1412)		
4 times	Inverter 2 version	INV2	Version (ex. 1412)		
5 times	Fan 1 version	FAN1	Version (ex. 1412)		
6 times	Fan 2 version	FAN2	Version (ex. 1412)		
7 times	EEP version	EEP	Version (ex. 1412)		
8 times	Automatically assigned address of the units	AUTO	SEG1	SEG2	SEG3, 4
			Indoor unit: "A" MCU: "C"	Indoor unit: "0" MCU: "1"	Address (ex: 07)
9 times	Manually assigned address of the units	MANU	SEG1	SEG2	SEG3, 4
			Indoor unit: "A" MCU: "C"	Indoor unit: "0" MCU: "1"	Address (ex: 15)

Things to check after completing the installation

- Before supplying the power, use DC 500V (AM****XV*J*) or DC 600 V (AM****XV*F*) insulation resistance tester to measure the power (3 phase: R, S, T) terminal and the outdoor unit grounding.
 - Measurement should be over 30MΩ.
- Before supplying the power, use a voltmeter and phase tester to check the voltage and the phase.
 - R, S, T terminal: Check the 460V (AM****XV*J*) or 230V (AM****XV*F*) between wires (R-S, S-T, T-R)

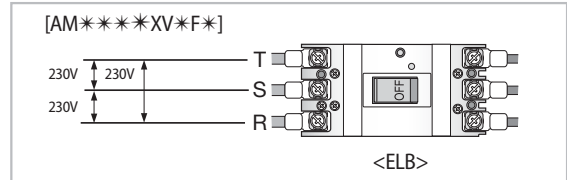
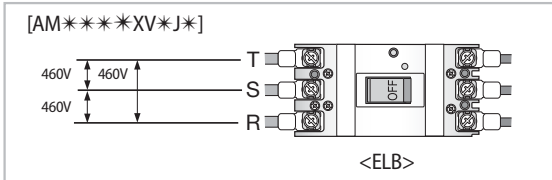

- Never measure the communication terminal since communication circuit may get damaged.
- Check for short-circuit of the communication terminal with a general circuit tester.

- Check if the R-410A indoor units are connected.
- Check the following after the installation is completed.

Installation work	Outdoor unit	<ul style="list-style-type: none"> • Have you checked the external surface and the inside of the outdoor unit? • Is there any possibility of short-circuit caused by the heat of an outdoor unit? • Is the place well-ventilated and ensures space for service? • Is the outdoor unit fixed securely to withstand any external force?
	Indoor unit	<ul style="list-style-type: none"> • Have you checked the external surface and the inside of the indoor unit? • Is there enough space for service? • Have you checked if the center of the indoor unit is ensured and it is installed horizontally?
Refrigerant pipe work		<ul style="list-style-type: none"> • Have you selected correct pipes? • Are the liquid and gas valve open? • Is the total number of connected indoor units within the allowable range? • Are the length and the height difference between the refrigerant pipes within the allowable range? • Are the branch joints properly installed? • Did you check the connection of liquid and gas pipes? • Have you selected correct insulator for pipes and insulated them correctly? • Did you insulate the pipes and connection part correctly? • Is the quantity of the additional refrigerant correctly weighed in? (You must record the amount of additional refrigerant on the service record paper placed inside of the outdoor unit.)
Drain pipe work		<ul style="list-style-type: none"> • Have you checked if the drain pipes of the indoor and outdoor unit are connected together? • Have you completed the drain test? • Is the drain pipe properly insulated?

Electrical wiring work	<ul style="list-style-type: none"> • Are the power cable and communication cable tightened firmly on the terminal board within the range of rated tightening torque? • Have you checked for cross-connection of the power and communication cables? • Have you performed the earthing work 3 to the outdoor unit? • Did you make sure to use 2-core cable (not multi-core cable) for the communication cable? • Is the length of the wire within allowed range? • Is the wiring route correct?
Setting address	<ul style="list-style-type: none"> • Did you set the address of the indoor and outdoor units properly? • Did you set the address of the indoor and outdoor units properly? (When using multiple remote controllers)
Option	<ul style="list-style-type: none"> • If there is a possibility of the outdoor unit from vibrating, check whether the anti-vibration frame is correctly installed.



Inspection and test operation



Precautions before test operation

- When the outdoor temperature is low, turn on the main power 6 hours before beginning the operation.
 - If you start the operation immediately after turning on the main power, it may cause serious damage to the part within the product.
- Do not touch the refrigerant pipe during or right after the operation.
 - Refrigerant pipe may be hot or cold during or right after the operation depending on the status of the refrigerant which flows through the refrigerant pipe, compressor and other parts of the refrigerant cycle.
- Do not operate the product with its panel or protection nets off.
 - There is risk of personal injury from the parts that rotates, heated or with the high voltage.
- Do not turn off the main power immediately after stopping the operation.
 - Wait for at least 5 minutes before turning off the main power. If not, water leakage or other problems may occur.
- Connect all the indoor units and the power supply for the outdoor unit and run auto address setting. Run auto address setting even after changing the indoor unit PCB.

Checklist before auto trial operation

1. Check the power cable and communication cable of the indoor and outdoor unit.
2. Supply power to the outdoor unit 6 hours before trial operation to pre-heat the crank case heater.
3. Before supplying the power, use a voltmeter and phase tester to check the voltage and the phase.
 - R,S,T terminal: check the 460V between wires (R-S, S-T, T-R) (AM****XV*J* Model only) / 230V between wires (R-S, S-T, T-R) (AM****XV*F* Model only).
4. When the power is supplied, outdoor unit will execute tracking to check the indoor unit connection and other optional functions.
5. Write down the installation report on the service history report paper attached on the front part of the control box.



- Supply power to the outdoor unit 6 hours before auto trial operation to pre-heat the crank case heater.

6. Guaranteed range of auto trial operation

For precise judgment, you must perform auto trial operation in below indoor/outdoor temperature condition.

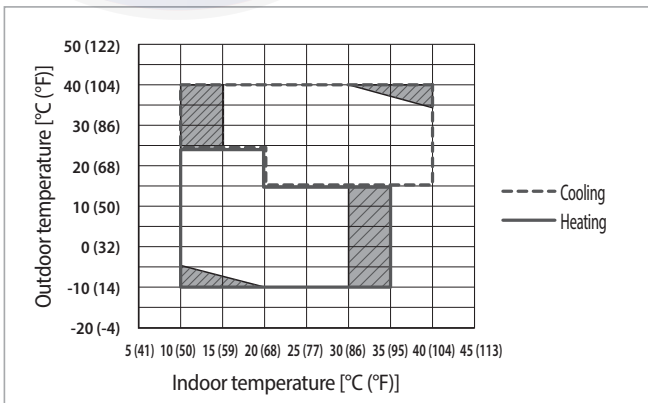

- In Auto trial operation, product will automatically select either cooling or heating mode and operate in selected mode.
- In the temperature range marked with slashed pattern, system protection control may trigger during operation. (If the system protection control is enabled, it can be hard to get the precise judgment after the auto trial operation.)
- When the temperature is outside of guaranteed range, accuracy of judgment on auto trial operation may decrease near border line area.

Auto trial operation

1. If the Auto Trial Operation is not completed, normal operation will be prohibited.
 - When the auto trial operation is not completed, UP (UnPrepared) will appear on the segment after the communication check and restrict compressor from operating. (UP Mode will be cleared automatically when auto trial mode is completed.)
 - Auto trial operation may take 20 minutes to maximum 2 hours depending on the operation status.
 - During auto trial operation, noise can be generated due to vavle inspection. (Check the product if abnormal noise occurs continously)
2. When error occurs during auto trial operation, check the error code and take appropriate measures.
 - Refer to next couple of pages when E503, E505 or E506 error occurs.
 - Refer to service manual if you need inspection or when other errors occur.
3. When auto trial operation ends, use S-NET pro or S-CHECKER to issue a result report.
 - Refer to service manual for further actions if you have any items with "inspection required" sign on the result report.
 - After taking appropriate measure for the items with "inspection required" sign, run the auto trial operation again.
4. Check the following items by running trial operation (cooling/heating).
 - Check if cooling/heating operation performs normally.
 - Individual indoor unit control: Check for air flow direction and fan speed.
 - Check for abnormal operation noise from the indoor and outdoor unit.
 - Check for proper draining from the indoor unit during cooling operation.
 - Use S-NET pro to check the detail operation status.
5. Explain to the user how to use the air conditioner according to the user's manual.
6. Hand over the installation manual to the customer so they can keep it with them.



CAUTION

- Make sure to close the top and bottom part of the outdoor unit cabinet during operation. If you operate the unit with the front cabinet open, it may cause damage to the product and you may not get the precise data from S-NET pro.

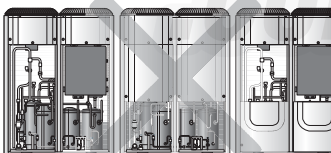
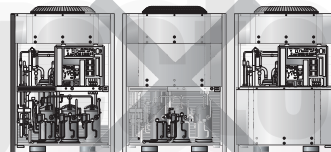
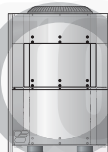

Inspection and trial operation

Measure to take when E503 error occurs (When "inspection required" sign is appeared on result report of S-NET pro)

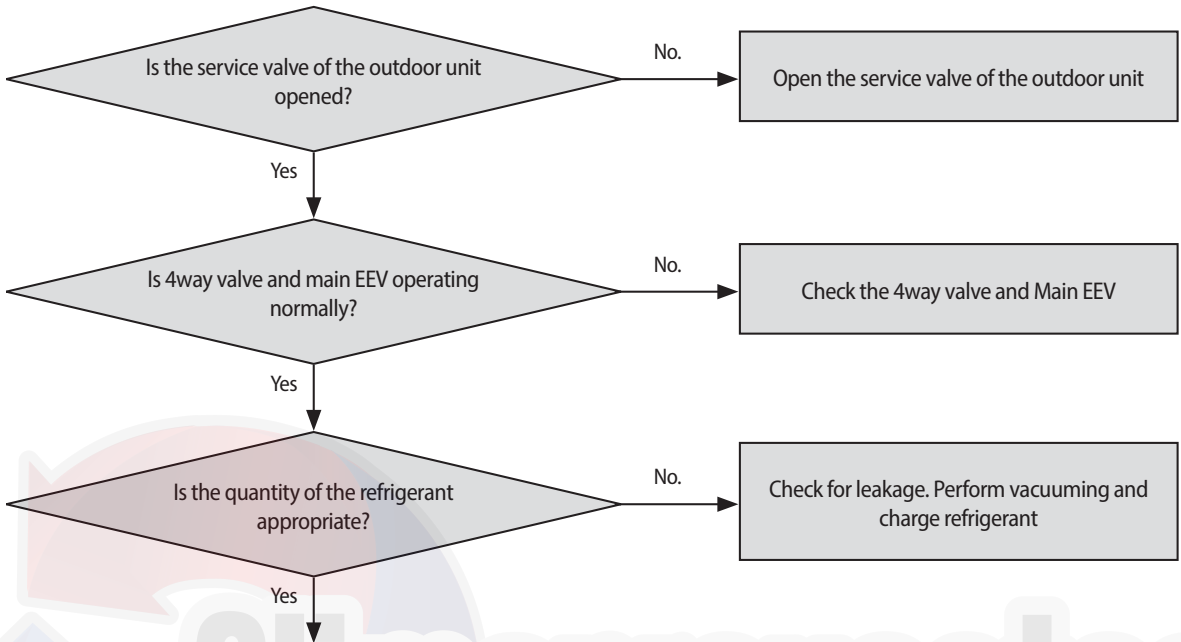

1. Run trial operation mode for more than 30 minutes
2. Run Fan mode for more than 10 minutes
3. Restart the auto trial operation

* Symptoms for abnormal operation of the 4way valve

- Refrigerant noise is increased while compressor operates and temperature of the pipe inlet (H/P: Suction, H/R: Suction 2) remains over 10 °C (50 °F) compared to low pressure's saturation temperature.
- Temperature of Eva. in/out remains below 0 °C (32 °F) during heating operation.

* Symptoms for abnormal operation of the Main EEV

- Error on controlling degree of superheat of compressor inlet during heating operation.
 - : If there's operation error while the EEV is fully opened, targeted degree of superheat [1 °C (33.8 °F)] cannot be secured [below 0 °C (32 °F)] and discharge temperature of the compressor will be low.
 - : If there's operation error while the EEV is fully closed, low pressure will decrease and the degree of superheat on the compressor inlet will increase excessively.



- If the service valve need to be detected, corresponding outdoor unit will display the error.
- If the service valve need to be detected, auto detection mode will end. Check both gas pipe and liquid pipe service valves when detecting service valve.
- When 4way valve, Main EEV detection is needed, run heating trial operation for more than 1 hour and analyze the data to check for a problem.
- If there's frost formed in outdoor unit or the outdoor unit is operating in defrost operation, it may be hard to detect problem normally. In this case, run heating trial operation for more than 1 hour.
- If the operation range is not within guaranteed range, error may occur even though the product is normal.

Measure to take when E505, E506 error occurs

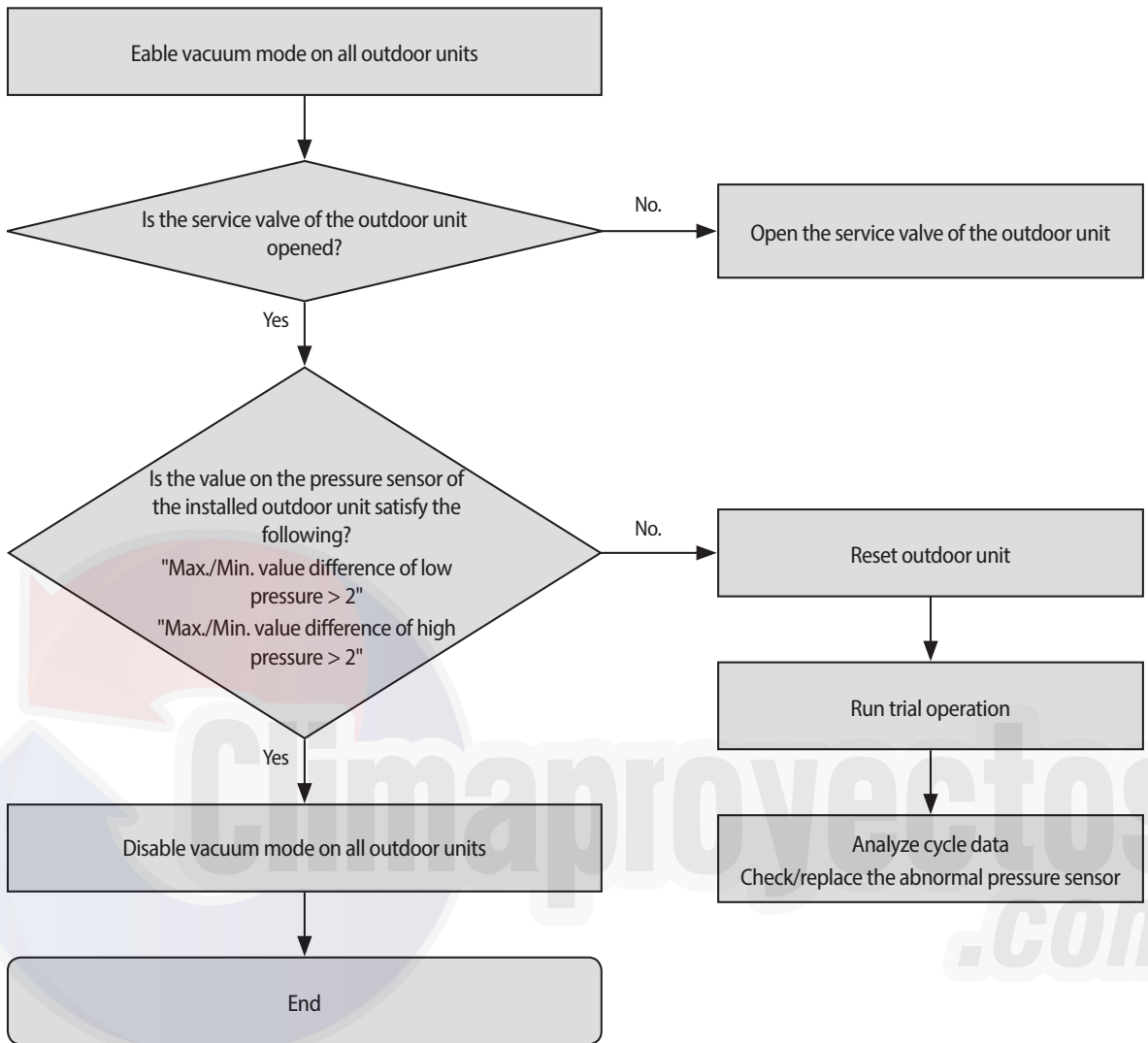

CAUTION

- When the auto trial operation for pressure sensor was executed before the pressure of the outdoor unit is equalized (when there's close to no difference between high and low pressure), error may occur even though the product is normal.
- If the pressure sensor need to be detected, all outdoor units will display the error.
- If the pressure sensor need to be detected, auto trial operation mode will end.
- To check for the pressure sensor with the problem, run trial operation for more than 1 hour and analyze the data to check for a problem.

Automatic refrigerant amount detection function

This function detects amount of refrigerant in the system through refrigerant amount detection operation

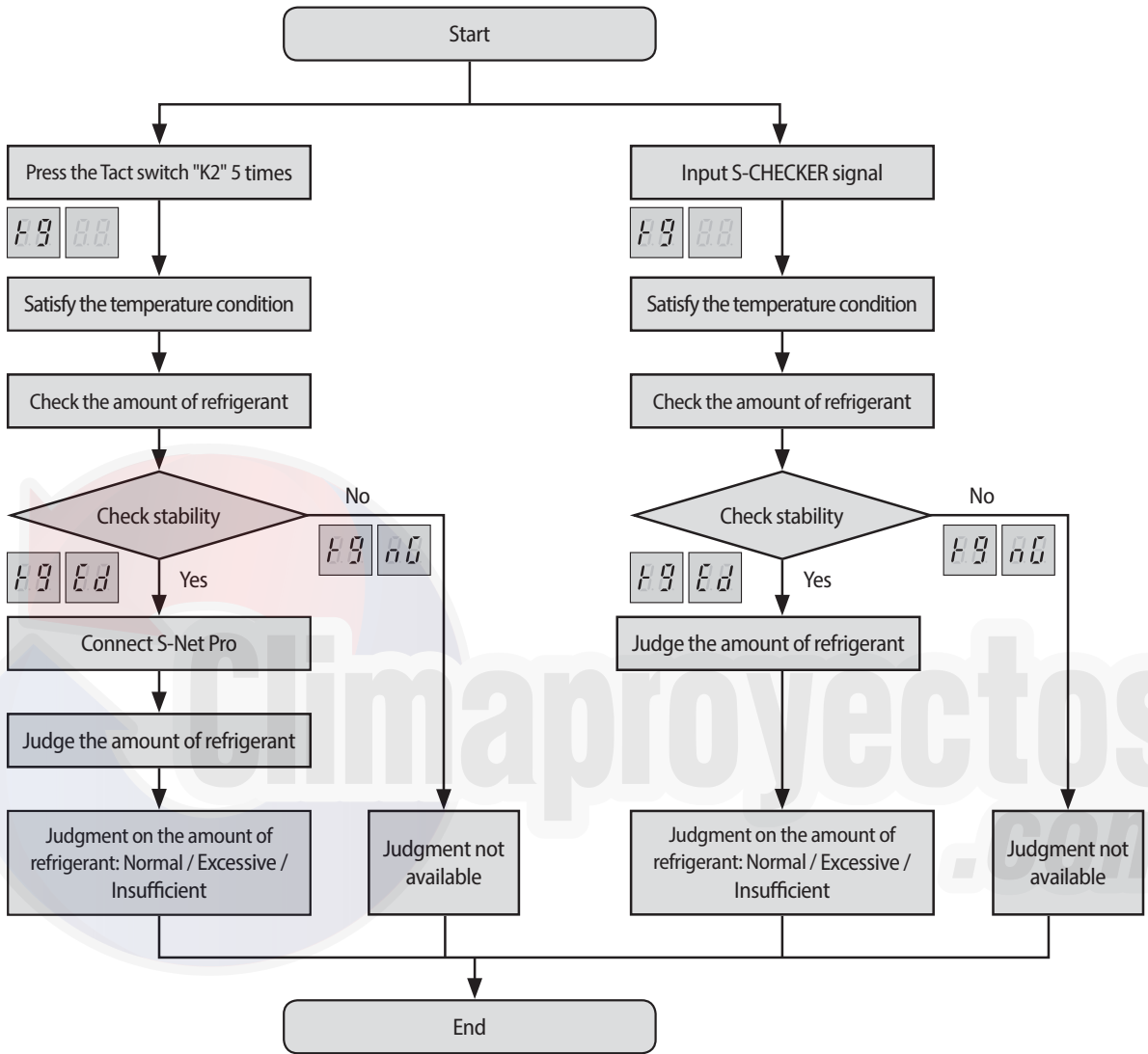

* After refrigerant amount detection is finished, if you see "K9 Ed" on the display and cannot check the refrigerant amount from the S-net pro and S-checker, it means insufficient degree of supercooling.



- If the temperature is out of the guaranteed range below, exact result will not be obtained.
 - Indoor: 20~32 °C
 - Outdoor: 5~43 °C
- If the operation cycle is not stable, the operation of refrigerant amount check may be forcibly finished.
- Accuracy of the result may decrease if the product has not been operated for a long period of time or heat mode has been operated before running the function of refrigerant amount check. Therefore, use the function of refrigerant amount check after operating the product in cool mode for at least 30 minutes.
- Product may trigger system protection operation depending on the installation environment. In this case, the result of refrigerant amount check may not be accurate.

Actions to take for the check result

- Excessive amount of refrigerant
 - Discharge 5% of total amount of refrigerant and restart the refrigerant amount check.
- Insufficient amount of refrigerant
 - Add 5% of the total amount of refrigerant and restart the refrigerant amount check.
- Insufficient degree of supercooling
 - Add 10 % of the total amount of refrigerant and restart the refrigerant amount check.
- Judgment not available
 - Check if the function of refrigerant amount check is executed within the guaranteed temperature range. Run trial operation to check if there are other problems on the system.

 Climaproyectos
.com



SAMSUNG

Climaproyectos
.com