

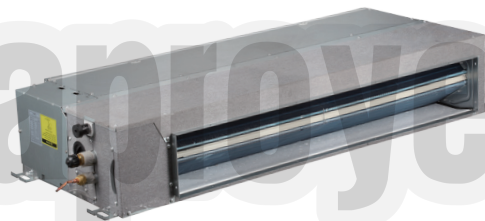

Technical Service Manual

VRF Indoor Unit

60Hz

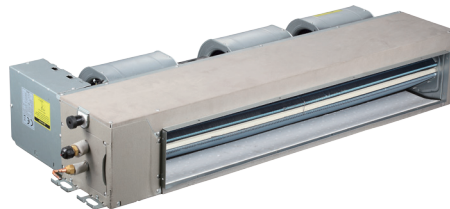

Series:

Low Static Pressure Duct

Concealed Duct Unit (Slim A5 Type)

Concealed Duct Unit (A5 Type)

High Static Pressure Duct

Fresh Air Processing Unit

Contents

001 Low Static Pressure Duct

025 Concealed Duct Unit (Slim A5 Type)

047 Concealed Duct Unit (A5 Type)

073 High Static Pressure Duct

104 Fresh Air Processing Unit

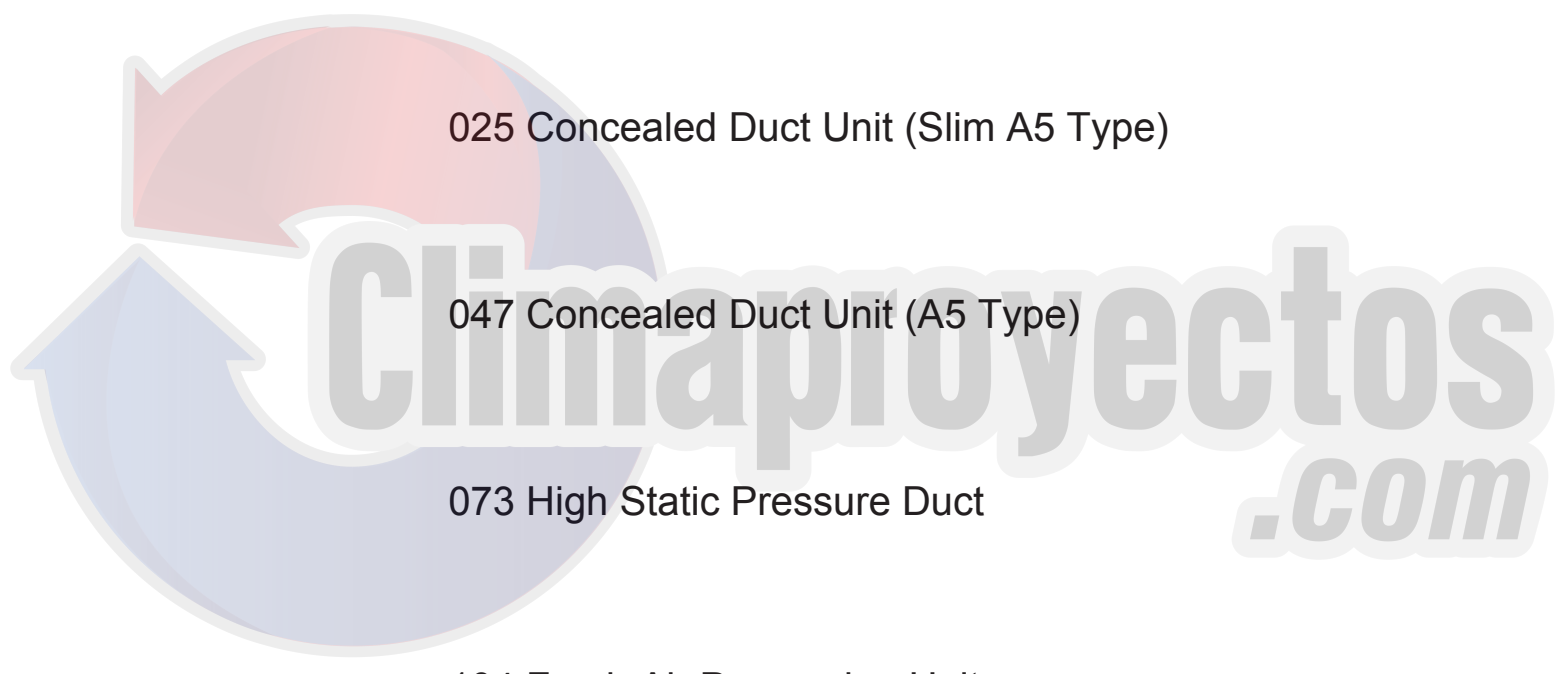

Low Static Pressure Duct (V shape evaporator)

1. Features	2
2. Specifications	4
3. Dimensions	7
4. Service Spaces	9
5. Piping Diagrams	10
6. Wiring Diagrams	11
7. Fan Performance	12
8. Capacity Tables	14
9. Electrical Characteristics	20
10. Sound Levels	21
11. Accessories	24



1. Features

1.1 Lower noise level

—Utilize the centrifugal type blower, the lowest noise is 24dB(A).



1.2 V shape evaporator

—V shape evaporator design enhances heat exchanging efficiency about 22%.

1.3 Less weight and super thin

—Flat design for easy fit when ceiling over head space is minimal. Only 7-15/32in.(190 mm) in height, this model can be installed in rooms with as little as 7-7/8in (200 mm) depth between the drop-ceiling and ceiling slab.

1.4 The length of air duct can be 6m.

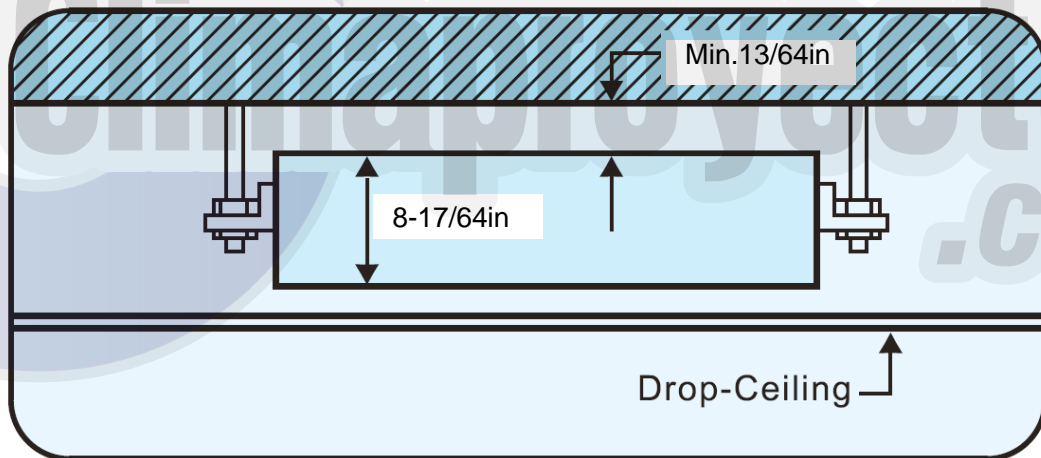

1.5 wide capacity range

—The capacity range is from 6100Btu/h to 24200Btu/h (1.8KW to 7.1KW) ,totally 7 models available.

1.6 Convenient installation and maintenance

1.6.1 The EXV is fixed inside the indoor unit

1.6.2 The connection pipe is flexible pipe, so it can change the connection direction conveniently.

1.6.3 Optional drain pump

With a drain-up pump 29-17/32in (750 mm lift) as an optional accessory.

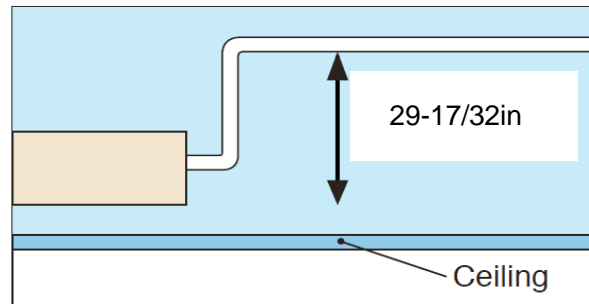

1.7 Auto restart

—When there is a power failure, the indoor unit will restart automatically after power restores, and the operation state will be the same as its original state.



2. Specifications

Model			MDV-D18T3/VN1-C	MDV-D22T3/VN1-C	MDV-D28T3/VN1-C
Power supply		V- Ph-Hz	208-230V~, 1Ph, 60Hz		
Cooling	Capacity	kW	1.8	2.2	2.8
		Btu/h	6100	7500	9600
	Input	W	62	62	62
	Rated current	A	0.28	0.28	0.28
Heating	Capacity	kW	2.2	2.6	3.2
		Btu/h	7500	8900	10900
	Input	W	62	62	62
	Rated current	A	0.28	0.28	0.28
Indoor fan motor	Model		YSK27-4G	YSK27-4G	YSK27-4G
	Type		AC MOTOR		
	Brand		Yongan/Welling		
	Input	W	60	60	60
	Capacitor	μF	1.5μF/450V	1.5μF/450V	1.5μF/450V
	Speed (sh/h/m/l)	r/min	1000/890/750/675	1000/890/750/675	1000/890/750/675
Indoor coil	Number of rows		2	2	2
	Tube pitch(a)x row pitch(b)	in.(mm)	13/16x17/32(21x13.37)		
	Fin spacing	in.(mm)	1/16(1.5)	1/16(1.5)	1/16(1.5)
	Fin type		Hydrophilic aluminum		
	Tube outside diameter and type	in.(mm)	9/32(Φ7), Inner groove tube		
	Coil length x height x width	in.(mm)	20-9/32x5-25/32x1-3/64(515x147x26.74)		
	Number of circuits		3	3	3
Indoor air flow (SH/H/ML)		m ³ /h	606(30pa)/578/512/409		
		CFM	357/340/301/241		
Indoor external static pressure (H)		Pa	10(10-30)	10(10-30)	10(10-30)
Indoor noise level (H/ML)		dB(A)	35/27/24	35/27/24	35/27/24
Indoor unit	Dimension (WxHxD)	in.(mm)	29-9/64x8-17/64x18-1/2(740x210x470)		
	Packing (WxHxD)	in.(mm)	35-53/64x9-1/16x20-5/64(910x230x510)		
	Net/Gross weight	lbs.(kg)	32.0/39.7(14.5/18)		
Refrigerant type		R410A			
Throttle		Type	Electronic expansion valve		
		Model	D20MISZ-1R(L)		
Design pressure(H/L)		MPa	4.4/2.6		
Refrigerant piping	Liquid side/ Gas side	in.(mm)	Φ1/4,Φ1/2 (Φ6.35,Φ12.7)		
Connecting wiring	Power wiring	mm ²	3x2.5		
	Signal wiring	mm ²	3x0.75		
Drainage water pipe diameter		in.(mm)	OD 63/64(Φ25)		
Controller		Wireless remote controller			

Notes: 1. Nominal cooling capacities are based on the following conditions: return air temperature : 80.6°F(27°C)DB, 66.2°F(19°C)WB, outdoor temperature:95°F(35°C)DB, equivalent ref. Piping: 26.25ft(8m)(horizontal)

2. Nominal heating capacities are based on the following conditions: return air temperature: 68°F(20°C)DB, outdoor temperature: 44.6°F(7°C)DB,42.8°F(6°C)WB, equivalent ref. Piping: 26.25ft(8m)(horizontal)

Model			MDV-D36T3/VN1-C	MDV-D45T3/VN1-C	MDV-D56T3/VN1-C
Power supply		V- Ph-Hz	208-230V~, 1Ph, 60Hz		
Cooling	Capacity	kW	3.6	4.5	5.6
		Btu/h	12300	15400	19100
	Input	W	65	105	105
	Rated current	A	0.3	0.5	0.5
Heating	Capacity	kW	4	5	6.3
		Btu/h	13600	17100	21500
	Input	W	65	105	105
	Rated current	A	0.3	0.5	0.5
Indoor fan motor	Model		YSK27-4G	YSK47-4G	YSK47-4G
	Type		AC MOTOR		
	Brand		Yongan/Welling	Yongan	
	Input	W	63	100	100
	Capacitor	μF	2μF/450V	3.5μF/450V	3.5μF/450V
	Speed (sh/h/m/l)	r/min	1100/990/860/750	1075/950/780/670	1075/950/780/670
Indoor coil	Number of rows		2	2	2
	Tube pitch(a)x row pitch(b)	in.(mm)	13/16x17/32(21x13.37)		
	Fin spacing	in.(mm)	1/16(1.5)	3/64(1.3)	3/64(1.3)
	Fin type		Hydrophilic aluminum		
	Tube outside diameter and type	in.(mm)	9/32(Φ7), inner groove tube		
	Coil length x height x width	in.(mm)	20-9/32x5-25/32x1-3/64(515x147x26.74)	28-57/64x5-25/32x1-3/64(734x147x26.74)	
	Number of circuits		3	6	6
Indoor air flow (SH/H/M/L)		m ³ /h	646(30pa)/617/551/441		803(30pa)/824/690/609
		CFM	380/363/324/260		473/485/406/358
Indoor external static pressure		Pa	10(10~30)	10(10~30)	10(10~30)
Indoor noise level (H/M/L)		dB(A)	38/32/28	39/32/29	39/32/29
Indoor unit	Dimension (WxHxD)	in.(mm)	29-9/64x8-17/64x18-1/2(740x210x470)	37-51/64x8-17/64x18-1/2(960x210x470)	
	Packing (WxHxD)	in.(mm)	35-53/64x9-1/16x20-5/64(910x230x510)	44-31/64x9-1/16x20-5/64(1130x230x510)	
	Net/Gross weight		lbs.(kg)	32.0/39.7(14.5/18)	39.7/49.6(18/22.5)
Refrigerant type			R410A		
Throttle		Type	Electronic expansion valve		
		Model	D20MISZ-1R(L)		
Design pressure(H/L)		MPa	4.4/2.6		
Refrigerant piping	Liquid side/ Gas side	in.(mm)	Φ1/4,Φ1/2(Φ6.35/ Φ12.7)	Φ1/4,Φ1/2(Φ6.35/ Φ12.7)	Φ3/8,Φ5/8(Φ9.53/ Φ15.9)
Connecting wiring	Power wiring	mm ²	3x2.5		
	Signal wiring	mm ²	3x0.75		
Drainage water pipe diameter		in.(mm)	OD 63/64(Φ25)		
Controller			Wireless remote controller		

Notes: 1. Nominal cooling capacities are based on the following conditions: return air temperature : 80.6°F(27°C)DB, 66.2°F(19°C)WB, outdoor temperature:95°F(35°C)DB, equivalent ref. Piping: 26.25ft(8m)(horizontal)

2. Nominal heating capacities are based on the following conditions: return air temperature: 68°F(20°C)DB, outdoor temperature: 44.6°F(7°C)DB,42.8°F(6°C)WB, equivalent ref. Piping: 26.25ft(8m)(horizontal)

Model		MDV-D71T3/VN1-C	
Power supply		V- Ph-Hz	208-230V~, 1Ph, 60Hz
Cooling	Capacity	kW	7.1
		Btu/h	24200
	Input	W	130
	Rated current	A	0.6
Heating	Capacity	kW	8
		Btu/h	27300
	Input	W	130
Indoor fan motor	Model		YSK65-4G
	Type		AC MOTOR
	Brand		Welling
	Input	W	125
	Capacitor	μF	3.5μF/450V
	Speed (sh/h/m/l)	r/min	1100/950/800/670
Indoor coil	Number of rows		2
	Tube pitch(a)x row pitch(b)	in.(mm)	13/16×17/32(21×13.37)
	Fin spacing	in.(mm)	1/16(1.5)
	Fin type		Hydrophilic aluminum
	Tube outside diameter and type	in.(mm)	9/32(Φ7), inner groove tube
	Coil length x height x width	in.(mm)	37-31/64x5-25/32x1-3/64 (952x147x26.74)
	Number of circuits		6
Indoor air flow (SH/H/M/L)		m ³ /h	1207(30pa)/1060/970/811
		CFM	710/624/571/477
Indoor external static pressure		Pa	10(10~30)
Indoor noise level (H/M/L)		dB(A)	41/33/30
Indoor unit	Dimension (W×H×D)	in.(mm)	46-29/64×8-17/64×18-1/2(1180×210×470)
	Packing (W×H×D)	in.(mm)	53-5/32×9-1/16×20-5/64(1350×230×510)
	Net/Gross weight	lbs.(kg)	49.6/58.5(22.5/26.5)
Refrigerant type		R410A	
Throttle		Type	Electronic expansion valve
		Model	D20MISZ-1R(L)
Design pressure(H/L)		MPa	4.4/2.6
Refrigerant piping	Liquid side/ Gas side	in.(mm)	Φ3/8,Φ5/8
			(Φ 9.53/Φ 15.9)
Connecting wiring	Power wiring	mm ²	3x2.5
	Signal wiring	mm ²	3x0.75
Drainage water pipe diameter		in.(mm)	OD 63/64(Φ25)
Controller		Wireless remote controller	

Notes: 1. Nominal cooling capacities are based on the following conditions: return air temperature : 80.6°F(27°C)DB, 66.2°F(19°C)WB, outdoor temperature:95°F(35°C)DB, equivalent ref. Piping: 26.25ft(8m)(horizontal)
 2. Nominal heating capacities are based on the following conditions: return air temperature: 68°F(20°C)DB, outdoor temperature: 44.6°F(7°C)DB,42.8°F(6°C)WB, equivalent ref. Piping: 26.25ft(8m)(horizontal)

3. Dimensions

MDV-D18T3/VN1-C MDV-D22T3/VN1-C MDV-D28T3/VN1-C MDV-D36T3/VN1-C MDV-D45T3/VN1-C
MDV-D56T3/VN1-C MDV-D71T3/VN1-C

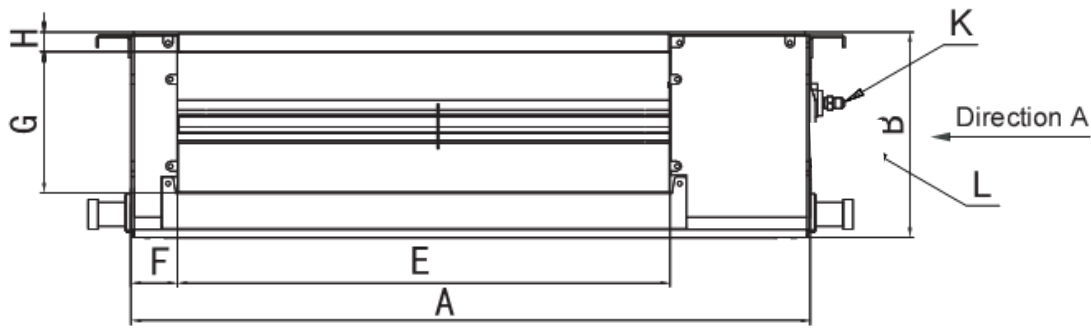

Unit in(mm)

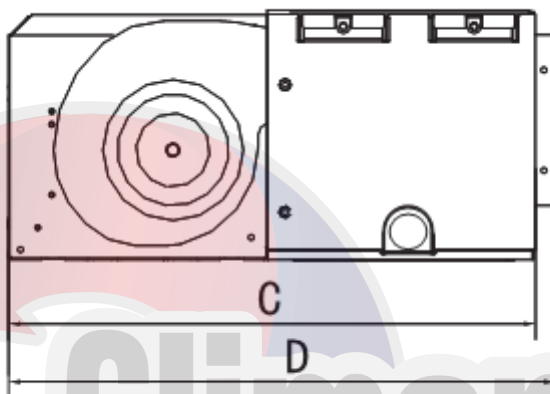

Mounted lug size

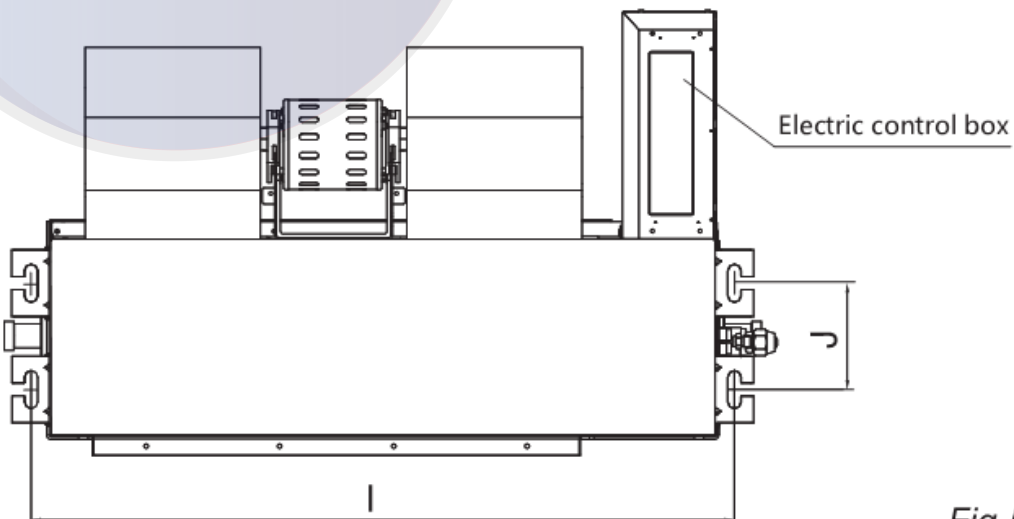

Fig.5-9

MODEL(kW)	A	B	C	D	E
1.8~3.6	700	210	450	470	512
4.5~5.6	920	210	450	470	732
7.1	1140	210	450	470	952

MODEL(kW)	F	G	H	I	J
1.8~3.6	45	145	17	740	112
4.5~5.6	45	145	17	960	112
7.1	45	145	17	1180	112



4. Service Spaces

- Ensure the needed spaces for installation and maintenance.
- The ceiling is horizontal, and its structure can endure the weight of the indoor unit.
- The outlet and the inlet are not impeded, and the influence of external air is the least.
- The air flow can reach throughout the room.
- The connecting pipe and drainpipe could be extracted out easily.
- There is no direct radiation from heaters.

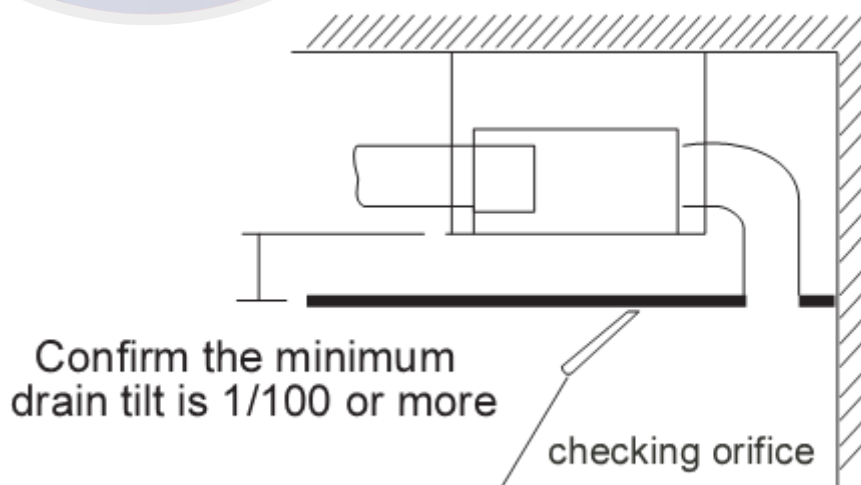
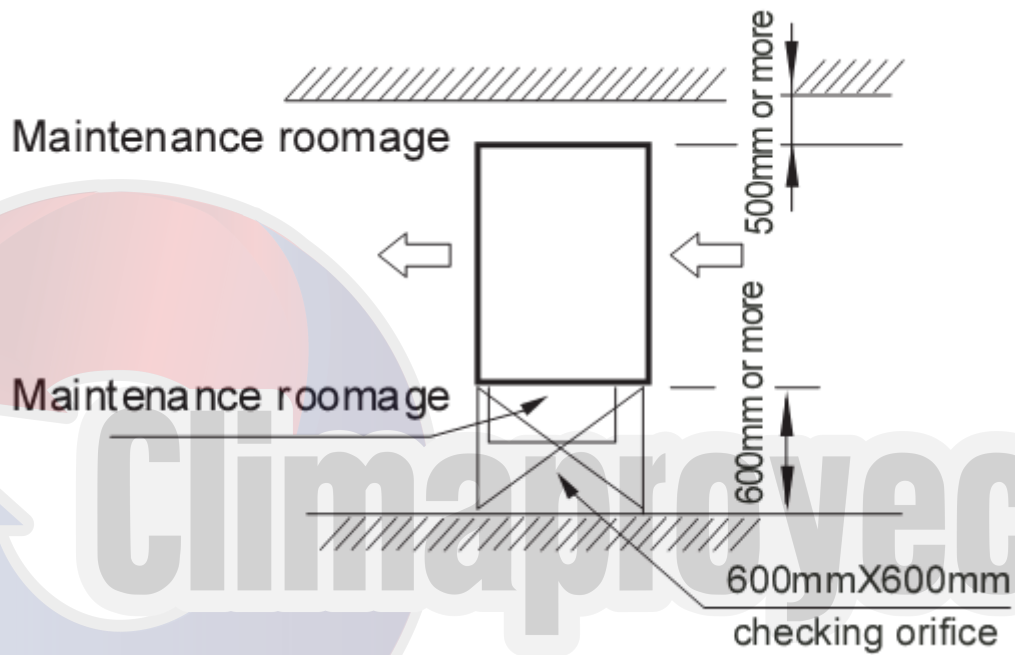

5. Piping Diagrams

MDV-D18T3/VN1-C MDV-D22T3/VN1-C MDV-D28T3/VN1-C MDV-D36T3/VN1-C MDV-D45T3/VN1-C
MDV-D56T3/VN1-C MDV-D71T3/VN1-C

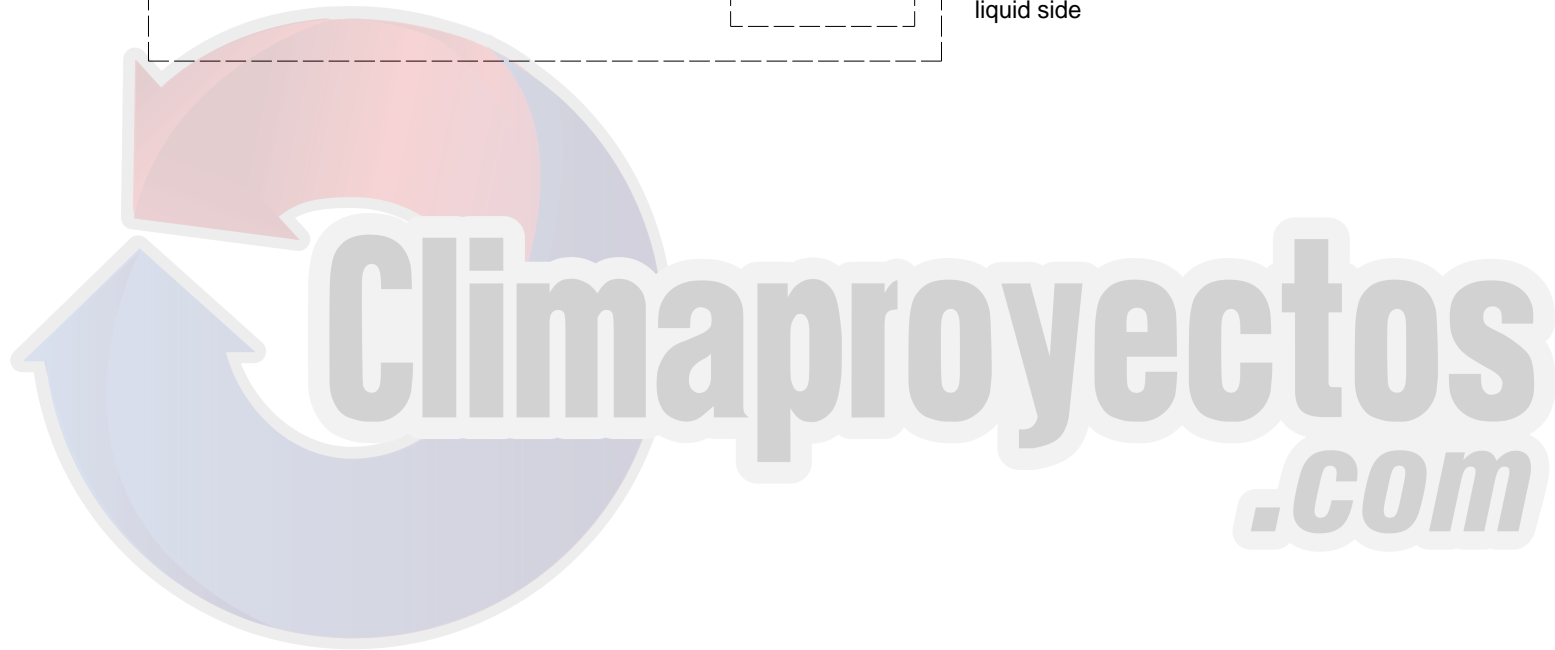
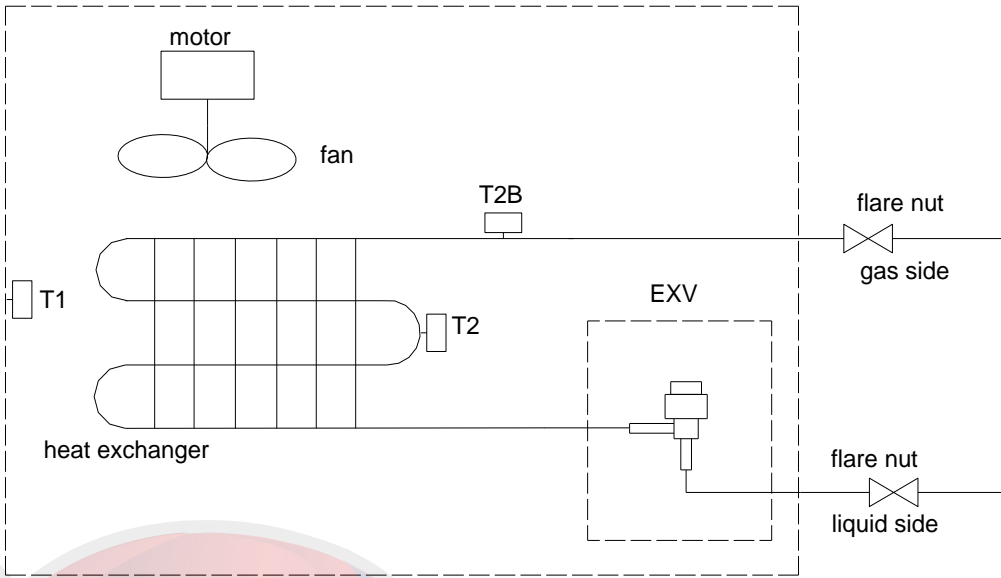

6. Wiring Diagrams

MDV-D18T3/VN1-C MDV-D22T3/VN1-C MDV-D28T3/VN1-C MDV-D36T3/VN1-C MDV-D45T3/VN1-C
 MDV-D56T3/VN1-C MDV-D71T3/VN1-C

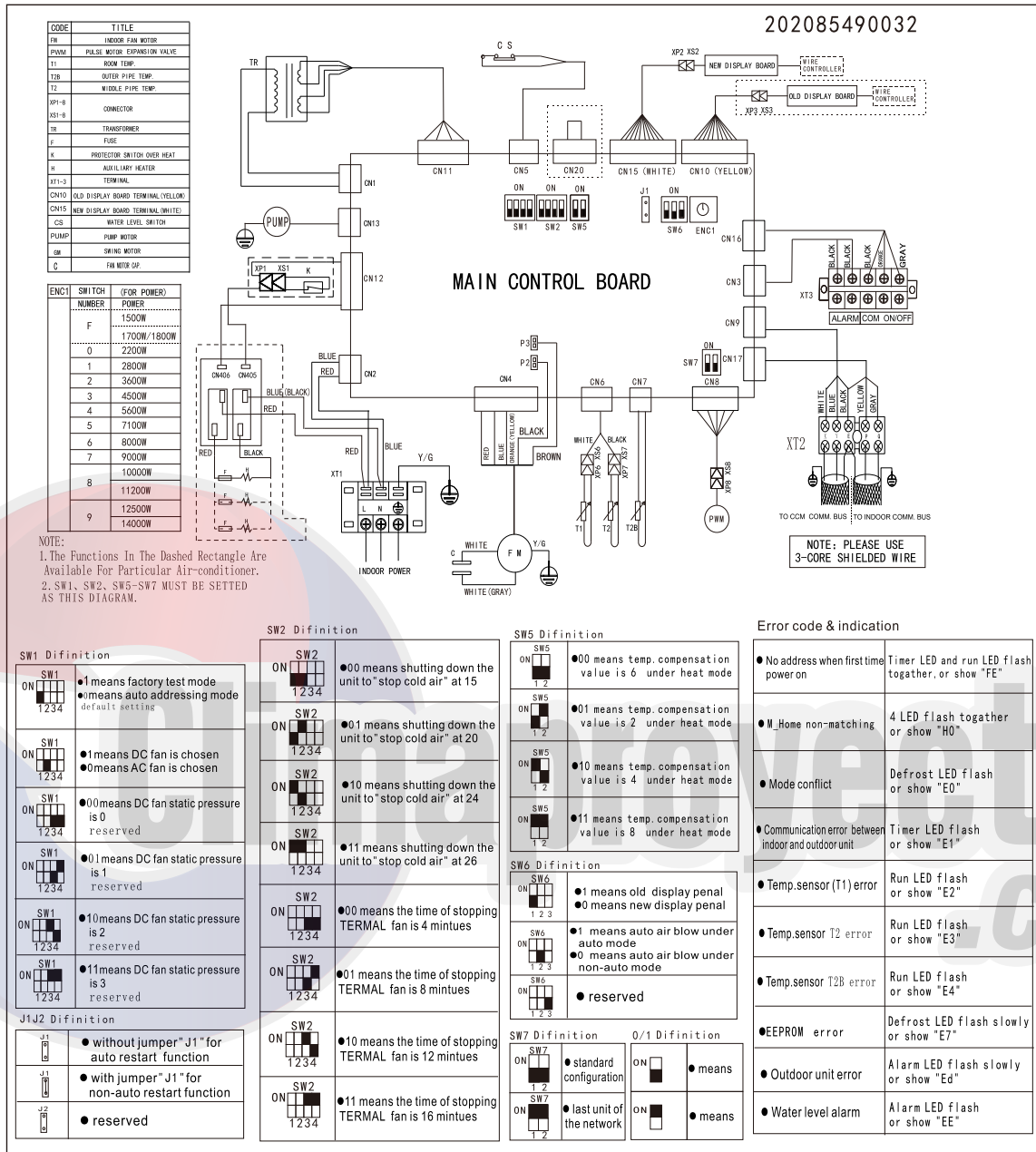

SW1 Difinition

ON SW1 1234	●1 means factory test mode ●0 means auto addressing mode default setting
ON SW1 1234	●1 means DC fan is chosen ●0 means AC fan is chosen
ON SW1 1234	●00 means DC fan static pressure is 0 reserved
ON SW1 1234	●01 means DC fan static pressure is 1 reserved
ON SW1 1234	●10 means DC fan static pressure is 2 reserved
ON SW1 1234	●11 means DC fan static pressure is 3 reserved

J1J2 Difinition

J1	● without jumper "J1" for auto restart function
J1	● with jumper "J1" for non-auto restart function
J2	● reserved

SW2 Difinition

ON SW2 1234	●00 means shutting down the unit to "stop cold air" at 15
ON SW2 1234	●01 means shutting down the unit to "stop cold air" at 20
ON SW2 1234	●10 means shutting down the unit to "stop cold air" at 24
ON SW2 1234	●11 means shutting down the unit to "stop cold air" at 26
ON SW2 1234	●00 means the time of stopping TERMAL fan is 4 mintues
ON SW2 1234	●01 means the time of stopping TERMAL fan is 8 mintues
ON SW2 1234	●10 means the time of stopping TERMAL fan is 12 mintues
ON SW2 1234	●11 means the time of stopping TERMAL fan is 16 mintues

SW5 Difinition

ON SW5 123	●00 means temp. compensation value is 6 under heat mode
ON SW5 123	●01 means temp. compensation value is 2 under heat mode
ON SW5 123	●10 means temp. compensation value is 4 under heat mode
ON SW5 123	●11 means temp. compensation value is 8 under heat mode

SW6 Difinition

ON SW6 123	●1 means old display penal ●0 means new display penal
ON SW6 123	●1 means auto air blow under auto mode ●0 means auto air blow under non-auto mode
ON SW6 123	● reserved

SW7 Difinition

ON SW7 123	● standard configuration
ON SW7 123	● last unit of the network

O/1 Difinition

ON	● means
ON	● means

Error code & indication

● No address when first time power on	Timer LED and run LED flash together, or show "FE"
● M Home non-matching	4 LED flash together or show "H0"
● Mode conflict	Defrost LED flash or show "E0"
● Communication error between indoor and outdoor unit	Timer LED flash or show "E1"
● Temp. sensor T1 error	Run LED flash or show "E2"
● Temp. sensor T2 error	Run LED flash or show "E3"
● Temp. sensor T2B error	Run LED flash or show "E4"
● EEPROM error	Defrost LED flash slowly or show "E7"
● Outdoor unit error	Alarm LED flash slowly or show "Ed"
● Water level alarm	Alarm LED flash or show "EE"

7.Fan Performance

How to Read the Diagram

The vertical axis is the External Static Pressure (Pa) while the horizontal axis represents the Air Flow (m³/h).

The characteristic curve for the “SH,” “H,” “M,” and “L” fan speed control

The nameplate values are shown based on the “H” air flow.

Therefore in the case of 22T3Type, the air flow is 512 m³/h , while the External Static Pressure is 10Pa at “H ” position. If 30Pa needed, the airflow is at 'SH'

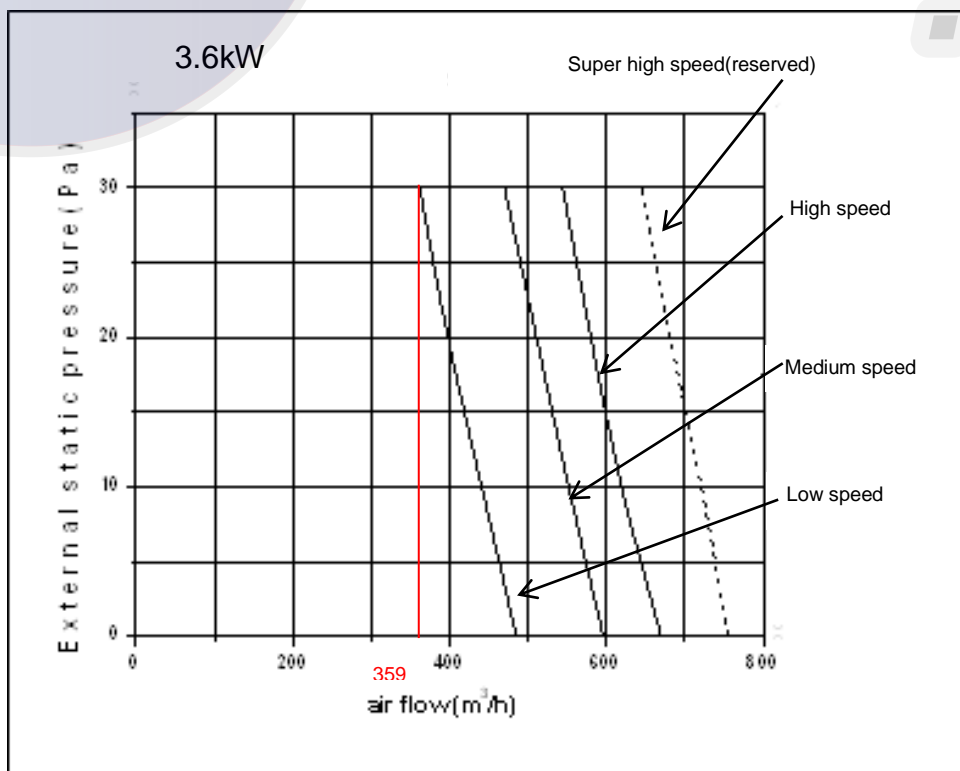
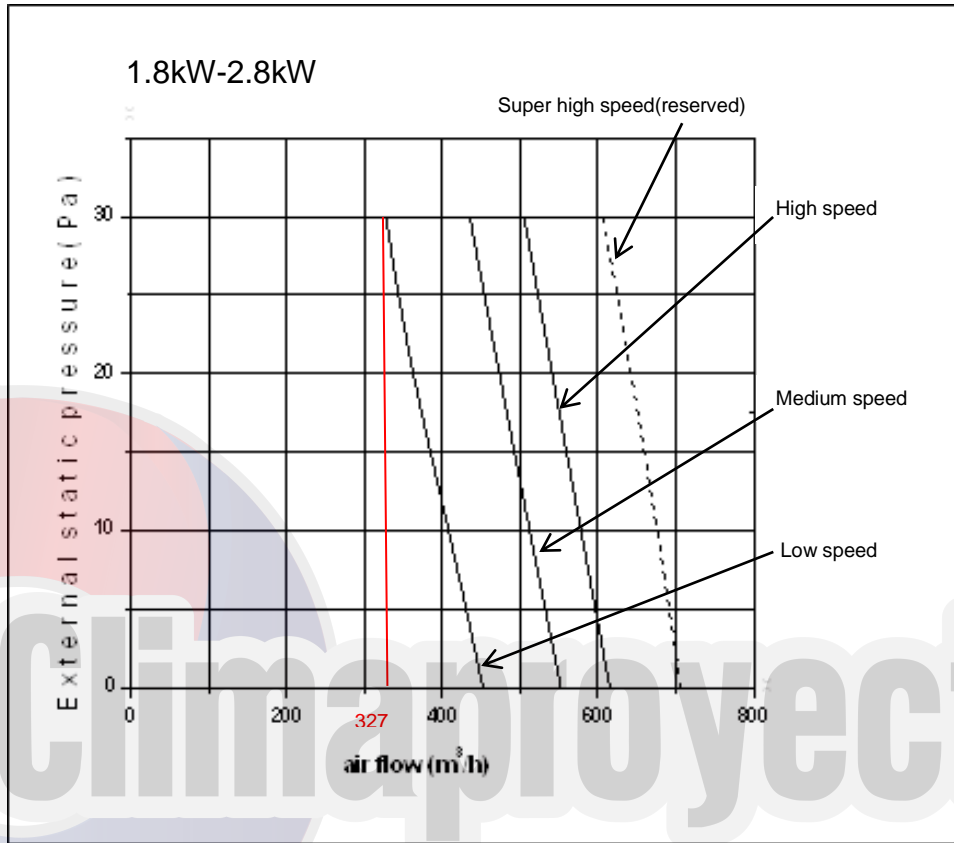

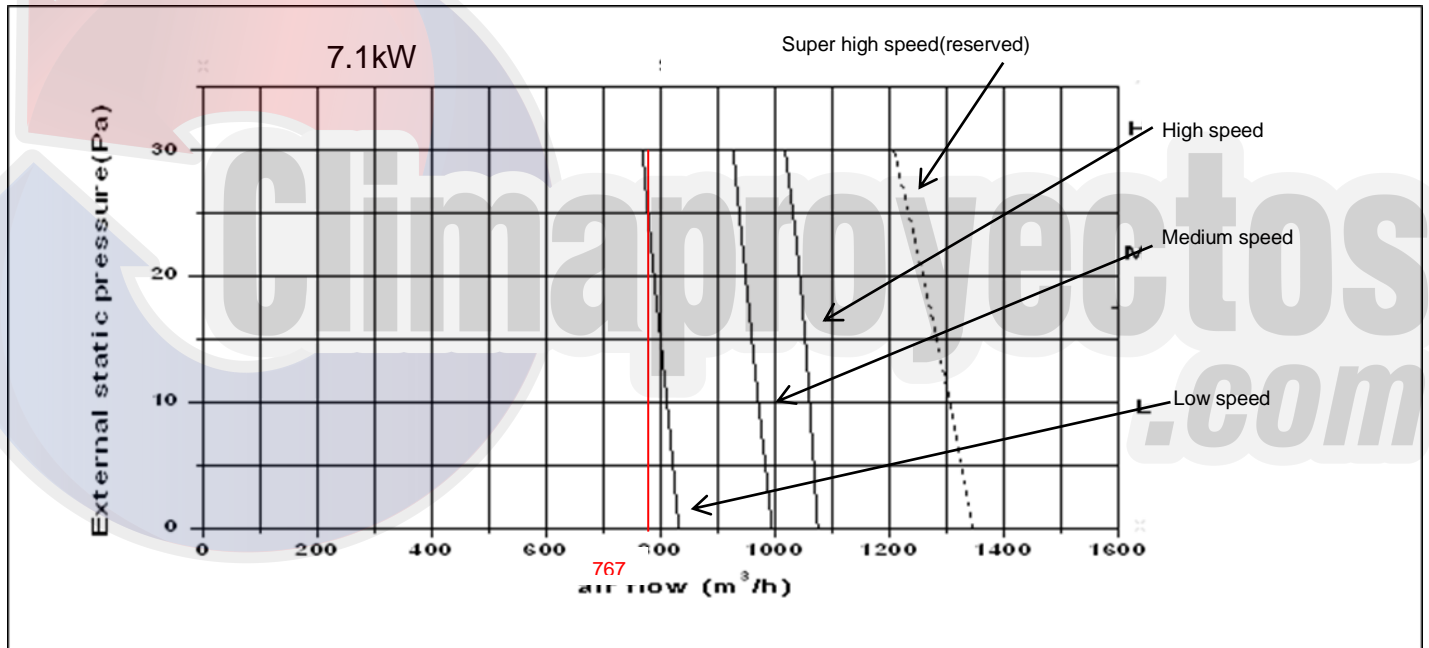
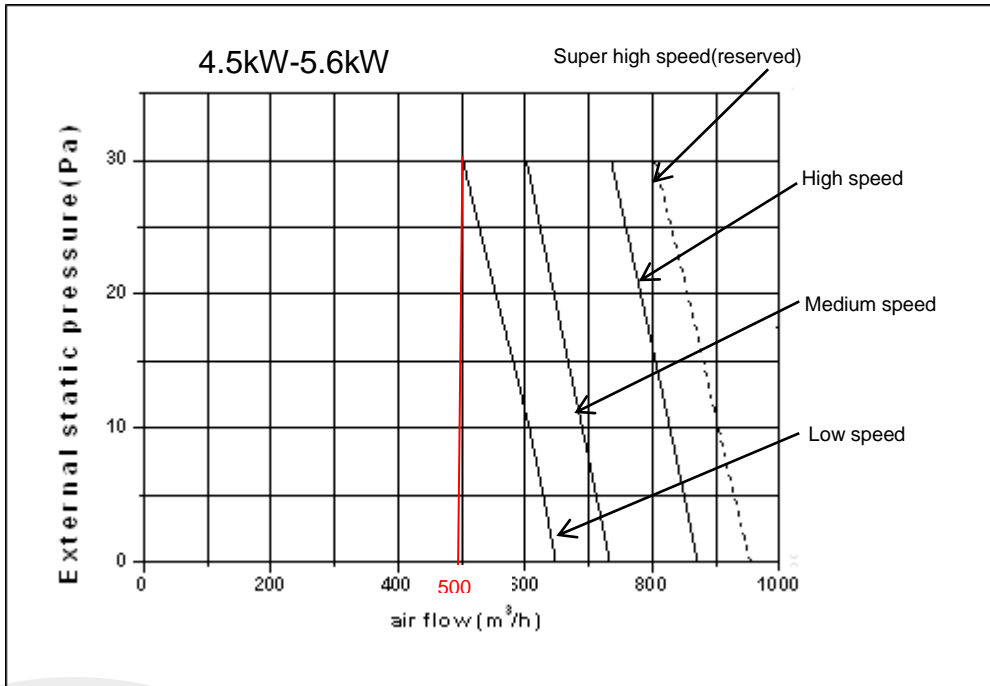

- If the external static pressure is too great (due to long extension of duct, for example), the air flow volume may drop too low at each air outlet.
- So there's a limit air flow volume line for each speed and it is the min. airflow of this duct unit. At this flow volume, the fan achieves the max. ESP and indoor evaporator may be protected by low temperature.
- As well, there's a limit airflow volume, which is the max. value at each speed. It requests the unit to connect ducts for air inlet and outlet to prevent damage from the high temperature of motor/evaporator.

8.Capacity Tables

8.1 Cooling TC: total capacity SC: sensible capacity

WB: wet-bulb temperature DB: dry-bulb temperature

Indoor Unit size (kW)	Outdoor temperature (°F DB)	Indoor temperature (°F WB/DB)													
		57.2/68		60.8/73.4		64.4/78.8		66.2/80.6		68/82.4		71.6/86		75.2/89.6	
		TC	SC	TC	SC	TC	SC	TC	SC	TC	SC	TC	SC	TC	SC
		kW	kW	kW	kW	kW	kW	kW	kW	kW	kW	kW	kW	kW	kW
1.8	50	1.2	1.1	1.5	1.1	1.7	1.2	1.8	1.2	1.9	1.3	2.1	1.3	2.4	1.3
	53.6	1.2	1.1	1.5	1.1	1.7	1.2	1.8	1.2	1.9	1.3	2.1	1.3	2.3	1.2
	57.2	1.2	1.1	1.5	1.1	1.7	1.2	1.8	1.2	1.9	1.3	2.1	1.3	2.3	1.2
	60.8	1.2	1.1	1.5	1.1	1.7	1.2	1.8	1.2	1.9	1.3	2.1	1.3	2.3	1.2
	64.4	1.2	1.1	1.5	1.1	1.7	1.2	1.8	1.2	1.9	1.3	2.1	1.3	2.3	1.2
	68	1.2	1.1	1.5	1.1	1.7	1.2	1.8	1.2	1.9	1.3	2.1	1.3	2.2	1.1
	69.8	1.2	1.1	1.5	1.1	1.7	1.2	1.8	1.2	1.9	1.3	2.1	1.3	2.2	1.1
	73.4	1.2	1.1	1.5	1.1	1.7	1.2	1.8	1.2	1.9	1.3	2.1	1.2	2.2	1.1
	77	1.2	1.1	1.5	1.1	1.7	1.2	1.8	1.2	1.9	1.3	2.1	1.2	2.1	1.1
	80.6	1.2	1.1	1.5	1.1	1.7	1.2	1.8	1.2	1.9	1.3	2.1	1.2	2.1	1.1
	84.2	1.2	1.1	1.5	1.1	1.7	1.2	1.8	1.2	1.9	1.3	2.0	1.2	2.1	1.1
	87.8	1.2	1.1	1.5	1.1	1.7	1.2	1.8	1.2	1.9	1.3	2.0	1.2	2.1	1.1
	91.4	1.2	1.1	1.5	1.1	1.7	1.2	1.8	1.2	1.9	1.3	2.0	1.2	2.0	1.2
	95	1.2	1.1	1.5	1.1	1.7	1.2	1.8	1.2	1.9	1.3	1.9	1.1	2.0	1.2
	98.6	1.2	1.1	1.5	1.1	1.7	1.2	1.8	1.2	1.9	1.3	1.9	1.1	1.9	1.1
	102.2	1.2	1.1	1.5	1.1	1.7	1.2	1.8	1.2	1.8	1.2	1.9	1.1	1.9	1.1
107.6	1.2	1.1	1.5	1.1	1.7	1.2	1.8	1.2	1.8	1.2	1.9	1.1	1.9	1.1	
111.2	1.2	1.1	1.5	1.1	1.7	1.2	1.8	1.2	1.8	1.2	1.9	1.1	1.9	1.1	
114.8	1.2	1.1	1.5	1.2	1.7	1.2	1.8	1.2	1.8	1.2	1.9	1.1	1.9	1.1	
2.2	50	1.5	1.3	1.8	1.4	2.1	1.5	2.2	1.5	2.3	1.6	2.6	1.6	2.9	1.5
	53.6	1.5	1.3	1.8	1.4	2.1	1.5	2.2	1.5	2.3	1.6	2.6	1.6	2.8	1.5
	57.2	1.5	1.3	1.8	1.4	2.1	1.5	2.2	1.5	2.3	1.6	2.6	1.6	2.8	1.5
	60.8	1.5	1.3	1.8	1.4	2.1	1.5	2.2	1.5	2.3	1.6	2.6	1.6	2.8	1.5
	64.4	1.5	1.3	1.8	1.4	2.1	1.5	2.2	1.5	2.3	1.6	2.6	1.6	2.8	1.4
	68	1.5	1.3	1.8	1.4	2.1	1.5	2.2	1.5	2.3	1.6	2.6	1.6	2.7	1.4
	69.8	1.5	1.3	1.8	1.4	2.1	1.5	2.2	1.5	2.3	1.6	2.6	1.6	2.7	1.4
	73.4	1.5	1.3	1.8	1.4	2.1	1.5	2.2	1.5	2.3	1.6	2.5	1.5	2.7	1.4
	77	1.5	1.3	1.8	1.4	2.1	1.5	2.2	1.5	2.3	1.6	2.5	1.5	2.6	1.4
	80.6	1.5	1.3	1.8	1.4	2.1	1.5	2.2	1.5	2.3	1.6	2.5	1.5	2.6	1.4
	84.2	1.5	1.3	1.8	1.4	2.1	1.5	2.2	1.5	2.3	1.6	2.4	1.4	2.5	1.4
	87.8	1.5	1.3	1.8	1.4	2.1	1.5	2.2	1.5	2.3	1.6	2.4	1.4	2.5	1.4
	91.4	1.5	1.3	1.8	1.4	2.1	1.5	2.2	1.5	2.3	1.6	2.4	1.4	2.4	1.4
	95	1.5	1.3	1.8	1.4	2.1	1.5	2.2	1.5	2.3	1.6	2.3	1.3	2.4	1.4
	98.6	1.5	1.3	1.8	1.4	2.1	1.5	2.2	1.5	2.3	1.6	2.3	1.3	2.3	1.4
	102.2	1.5	1.3	1.8	1.4	2.1	1.5	2.2	1.5	2.2	1.5	2.3	1.3	2.3	1.4
107.6	1.5	1.3	1.8	1.4	2.1	1.5	2.2	1.5	2.2	1.5	2.3	1.3	2.3	1.4	
111.2	1.5	1.3	1.8	1.4	2.1	1.5	2.2	1.5	2.2	1.5	2.3	1.3	2.3	1.4	
114.8	1.5	1.3	1.8	1.4	2.1	1.5	2.2	1.5	2.2	1.5	2.3	1.3	2.3	1.4	
2.8	50	1.9	1.6	2.3	1.8	2.6	1.9	2.8	1.9	3.0	1.9	3.3	2.0	3.7	2.0
	53.6	1.9	1.6	2.3	1.8	2.6	1.9	2.8	1.9	3.0	1.9	3.3	2.0	3.6	2.0
	57.2	1.9	1.6	2.3	1.8	2.6	1.9	2.8	1.9	3.0	1.9	3.3	2.0	3.6	2.0
	60.8	1.9	1.6	2.3	1.8	2.6	1.9	2.8	1.9	3.0	1.9	3.3	2.0	3.5	1.9
	64.4	1.9	1.6	2.3	1.8	2.6	1.9	2.8	1.9	3.0	1.9	3.3	2.0	3.5	1.9
	68	1.9	1.6	2.3	1.8	2.6	1.9	2.8	1.9	3.0	1.9	3.3	2.0	3.4	1.9
	69.8	1.9	1.6	2.3	1.8	2.6	1.9	2.8	1.9	3.0	1.9	3.3	2.0	3.4	1.9
	73.4	1.9	1.6	2.3	1.8	2.6	1.9	2.8	1.9	3.0	1.9	3.3	2.0	3.4	1.9
	77	1.9	1.6	2.3	1.8	2.6	1.9	2.8	1.9	3.0	1.9	3.2	1.9	3.3	1.9
	80.6	1.9	1.6	2.3	1.8	2.6	1.9	2.8	1.9	3.0	1.9	3.2	1.9	3.3	1.9
	84.2	1.9	1.6	2.3	1.8	2.6	1.9	2.8	1.9	3.0	1.9	3.1	1.8	3.2	1.8
	87.8	1.9	1.6	2.3	1.8	2.6	1.9	2.8	1.9	3.0	1.9	3.1	1.8	3.2	1.7
	91.4	1.9	1.6	2.3	1.8	2.6	1.9	2.8	1.9	3.0	1.9	3.1	1.8	3.1	1.7
	95	1.9	1.6	2.3	1.8	2.6	1.9	2.8	1.9	2.9	1.9	3.0	1.8	3.1	1.7
	98.6	1.9	1.6	2.3	1.8	2.6	1.9	2.8	1.9	2.9	1.9	3.0	1.8	3.0	1.7
	102.2	1.9	1.6	2.3	1.8	2.6	1.9	2.8	1.9	2.9	1.9	3.0	1.9	3.0	1.7
107.6	1.9	1.6	2.3	1.8	2.6	1.9	2.8	1.9	2.9	1.9	3.0	1.9	3.0	1.7	
111.2	1.9	1.6	2.3	1.8	2.6	1.9	2.8	1.9	2.9	1.9	3.0	1.9	3.0	1.7	
114.8	1.9	1.6	2.3	1.8	2.6	1.9	2.8	1.9	2.9	1.9	3.0	1.9	3.0	1.7	

Indoor Unit size (kW)	Outdoor temperature (°F DB)	Indoor temperature (°F WB/DB)													
		57.2/68		60.8/73.4		64.4/78.8		66.2/80.6		68/82.4		71.6/86		75.2/89.6	
		TC	SC	TC	SC	TC	SC	TC	SC	TC	SC	TC	SC	TC	SC
		kW	kW	kW	kW	kW	kW	kW	kW	kW	kW	kW	kW	kW	kW
3.6	50	2.5	1.9	2.9	2.1	3.4	2.3	3.6	2.4	3.8	2.5	4.3	2.4	4.7	2.5
	53.6	2.5	1.9	2.9	2.1	3.4	2.3	3.6	2.4	3.8	2.5	4.3	2.4	4.7	2.5
	57.2	2.5	1.9	2.9	2.1	3.4	2.3	3.6	2.4	3.8	2.5	4.3	2.4	4.6	2.4
	60.8	2.5	1.9	2.9	2.1	3.4	2.3	3.6	2.4	3.8	2.5	4.3	2.4	4.5	2.4
	64.4	2.5	1.9	2.9	2.1	3.4	2.3	3.6	2.4	3.8	2.5	4.3	2.4	4.5	2.4
	68	2.5	1.9	2.9	2.1	3.4	2.3	3.6	2.4	3.8	2.5	4.3	2.4	4.4	2.3
	69.8	2.5	1.9	2.9	2.1	3.4	2.3	3.6	2.4	3.8	2.5	4.3	2.4	4.4	2.3
	73.4	2.5	1.9	2.9	2.1	3.4	2.3	3.6	2.4	3.8	2.5	4.1	2.3	4.3	2.2
	77	2.5	1.9	2.9	2.1	3.4	2.3	3.6	2.4	3.8	2.5	4.1	2.3	4.2	2.2
	80.6	2.5	1.9	2.9	2.1	3.4	2.3	3.6	2.4	3.8	2.5	4.0	2.2	4.2	2.2
	84.2	2.5	1.9	2.9	2.1	3.4	2.3	3.6	2.4	3.8	2.5	4.0	2.2	4.1	2.2
	87.8	2.5	1.9	2.9	2.1	3.4	2.3	3.6	2.4	3.8	2.5	4.2	2.6	4.1	2.2
	91.4	2.5	1.9	2.9	2.1	3.4	2.3	3.6	2.4	3.8	2.5	4.2	2.6	3.9	2.1
	95	2.5	1.9	2.9	2.1	3.4	2.3	3.6	2.4	3.8	2.5	4.2	2.6	3.9	2.1
	98.6	2.5	1.9	2.9	2.1	3.4	2.3	3.6	2.4	3.7	2.4	3.8	2.3	3.9	2.1
	102.2	2.5	1.9	2.9	2.1	3.4	2.3	3.6	2.4	3.7	2.4	3.8	2.3	3.8	2.1
107.6	2.5	1.9	2.9	2.1	3.4	2.3	3.6	2.4	3.7	2.4	3.8	2.3	3.8	2.1	
111.2	2.5	1.9	2.9	2.1	3.4	2.3	3.6	2.4	3.7	2.4	3.8	2.3	3.8	2.1	
114.8	2.5	1.9	2.9	2.1	3.4	2.3	3.6	2.4	3.7	2.4	3.8	2.3	3.8	2.1	
4.5	50	3.1	2.4	3.7	2.6	4.2	2.8	4.5	2.9	4.8	3.0	5.3	3.4	5.9	3.0
	53.6	3.1	2.4	3.7	2.6	4.2	2.8	4.5	2.9	4.8	3.0	5.3	3.4	5.9	3.0
	57.2	3.1	2.4	3.7	2.6	4.2	2.8	4.5	2.9	4.8	3.0	5.3	3.4	5.8	3.0
	60.8	3.1	2.4	3.7	2.6	4.2	2.8	4.5	2.9	4.8	3.0	5.3	3.4	5.6	2.9
	64.4	3.1	2.4	3.7	2.6	4.2	2.8	4.5	2.9	4.8	3.0	5.3	3.4	5.7	3.0
	68	3.1	2.4	3.7	2.6	4.2	2.8	4.5	2.9	4.8	3.0	5.3	3.4	5.7	3.0
	69.8	3.1	2.4	3.7	2.6	4.2	2.8	4.5	2.9	4.8	3.0	5.3	3.4	5.6	3.0
	73.4	3.1	2.4	3.7	2.6	4.2	2.8	4.5	2.9	4.8	3.0	5.3	3.4	5.5	3.0
	77	3.1	2.4	3.7	2.6	4.2	2.8	4.5	2.9	4.8	3.0	5.2	3.0	5.4	2.9
	80.6	3.1	2.4	3.7	2.6	4.2	2.8	4.5	2.9	4.8	3.0	5.1	3.0	5.2	2.8
	84.2	3.1	2.4	3.7	2.6	4.2	2.8	4.5	2.9	4.8	3.0	5.1	2.9	5.2	2.8
	87.8	3.1	2.4	3.7	2.6	4.2	2.8	4.5	2.9	4.8	3.0	5.0	2.9	5.1	2.7
	91.4	3.1	2.4	3.7	2.6	4.2	2.8	4.5	2.9	4.8	3.0	4.9	2.8	5.1	2.7
	95	3.1	2.4	3.7	2.6	4.2	2.8	4.5	2.9	4.8	3.0	4.8	2.8	5.0	2.7
	98.6	3.1	2.4	3.7	2.6	4.2	2.8	4.5	2.9	4.8	3.0	4.8	2.9	4.9	2.6
	102.2	3.1	2.4	3.7	2.6	4.2	2.8	4.5	2.9	4.6	2.8	4.7	2.8	4.8	2.6
107.6	3.1	2.4	3.7	2.6	4.2	2.8	4.5	2.9	4.6	2.8	4.7	2.8	4.8	2.6	
111.2	3.1	2.4	3.7	2.6	4.2	2.8	4.5	2.9	4.6	2.8	4.7	2.8	4.8	2.6	
114.8	3.1	2.4	3.7	2.6	4.2	2.8	4.5	2.9	4.6	2.8	4.7	3.1	4.8	2.6	
5.6	50	3.9	2.7	4.6	3.0	5.3	3.3	5.6	3.4	5.9	3.5	6.6	3.6	7.3	3.5
	53.6	3.9	2.7	4.6	3.0	5.3	3.3	5.6	3.4	5.9	3.5	6.6	3.6	7.2	3.5
	57.2	3.9	2.7	4.6	3.0	5.3	3.3	5.6	3.4	5.9	3.5	6.6	3.6	7.1	3.5
	60.8	3.9	2.7	4.6	3.0	5.3	3.3	5.6	3.4	5.9	3.5	6.6	3.6	7.0	3.4
	64.4	3.9	2.7	4.6	3.0	5.3	3.3	5.6	3.4	5.9	3.5	6.6	3.6	6.8	3.4
	68	3.9	2.7	4.6	3.0	5.3	3.3	5.6	3.4	5.9	3.5	6.6	3.6	6.7	3.3
	69.8	3.9	2.7	4.6	3.0	5.3	3.3	5.6	3.4	5.9	3.5	6.6	3.6	6.6	3.3
	73.4	3.9	2.7	4.6	3.0	5.3	3.3	5.6	3.4	5.9	3.5	6.6	3.6	6.6	3.3
	77	3.9	2.7	4.6	3.0	5.3	3.3	5.6	3.4	5.9	3.5	6.6	3.6	6.5	3.2
	80.6	3.9	2.7	4.6	3.0	5.3	3.3	5.6	3.4	5.9	3.5	6.4	3.5	6.4	3.2
	84.2	3.9	2.7	4.6	3.0	5.3	3.3	5.6	3.4	5.9	3.5	6.3	3.5	6.4	3.3
	87.8	3.9	2.7	4.6	3.0	5.3	3.3	5.6	3.4	5.9	3.5	6.2	3.4	6.2	3.2
	91.4	3.9	2.7	4.6	3.0	5.3	3.3	5.6	3.4	5.9	3.5	6.2	3.4	6.2	3.2
	95	3.9	2.7	4.6	3.0	5.3	3.3	5.6	3.4	5.9	3.5	6.0	3.3	6.0	3.1
	98.6	3.9	2.7	4.6	3.0	5.3	3.3	5.6	3.4	5.9	3.5	5.9	3.2	6.0	3.1
	102.2	3.9	2.7	4.6	3.0	5.3	3.3	5.6	3.4	5.7	3.4	5.8	3.2	6.0	3.1
107.6	3.9	2.7	4.6	3.0	5.3	3.3	5.6	3.4	5.7	3.4	5.8	3.2	6.0	3.1	
111.2	3.9	2.7	4.6	3.0	5.3	3.3	5.6	3.4	5.7	3.4	5.8	3.2	6.0	3.1	
114.8	3.9	2.7	4.6	3.0	5.3	3.3	5.6	3.4	5.7	3.7	5.8	3.2	6.0	3.1	
7.1	50	4.9	3.6	5.8	4.0	6.7	4.3	7.1	4.5	7.5	4.4	8.4	4.5	9.2	4.6
	53.6	4.9	3.6	5.8	4.0	6.7	4.3	7.1	4.5	7.5	4.4	8.4	4.5	9.1	4.5
	57.2	4.9	3.6	5.8	4.0	6.7	4.3	7.1	4.5	7.5	4.4	8.4	4.5	9.0	4.5
	60.8	4.9	3.6	5.8	4.0	6.7	4.3	7.1	4.5	7.5	4.4	8.4	4.5	8.9	4.4

Indoor Unit size (kW)	Outdoor temperature (°F DB)	Indoor temperature (°F WB/DB)													
		57.2/68		60.8/73.4		64.4/78.8		66.2/80.6		68/82.4		71.6/86		75.2/89.6	
		TC	SC	TC	SC	TC	SC	TC	SC	TC	SC	TC	SC	TC	SC
		kW	kW	kW	kW	kW	kW	kW	kW	kW	kW	kW	kW	kW	kW
7.1	64.4	4.9	3.6	5.8	4.0	6.7	4.3	7.1	4.5	7.5	4.4	8.4	4.5	8.7	4.3
	68	4.9	3.6	5.8	4.0	6.7	4.3	7.1	4.5	7.5	4.4	8.4	4.5	8.5	4.2
	69.8	3.6	5.8	4.0	6.7	4.3	7.1	4.5	7.5	4.4	8.4	4.5	8.4	4.2	3.6
	73.4	3.6	5.8	4.0	6.7	4.3	7.1	4.5	7.5	4.4	8.4	4.5	8.3	4.1	3.6
	77	3.6	5.8	4.0	6.7	4.3	7.1	4.5	7.5	4.4	8.4	4.5	8.2	4.1	3.6
	80.6	3.6	5.8	4.0	6.7	4.3	7.1	4.5	7.5	4.4	8.1	4.3	8.2	4.1	3.6
	84.2	3.6	5.8	4.0	6.7	4.3	7.1	4.5	7.5	4.5	8.0	4.3	8.1	4.1	3.6
	87.8	3.6	5.8	4.0	6.7	4.3	7.1	4.5	7.5	4.5	7.9	4.3	7.8	4.0	3.6
	91.4	3.6	5.8	4.0	6.7	4.3	7.1	4.5	7.5	4.5	7.8	4.2	7.8	4.0	3.6
	95	3.6	5.8	4.0	6.7	4.3	7.1	4.5	7.5	4.5	7.6	4.1	7.7	3.9	3.6
	98.6	3.6	5.8	4.0	6.7	4.3	7.1	4.5	7.4	4.4	7.5	4.1	7.6	4.0	3.6
	102.2	3.6	5.8	4.0	6.7	4.3	7.1	4.5	7.2	4.3	7.4	4.1	7.6	4.0	3.6
	107.6	3.6	5.8	4.0	6.7	4.3	7.1	4.5	7.2	4.3	7.4	4.1	7.6	4.0	3.6
	111.2	3.6	5.8	4.0	6.7	4.3	7.1	4.5	7.2	4.3	7.4	4.1	7.6	4.0	3.6
114.8	3.6	5.8	4.0	6.7	4.3	7.1	4.5	7.2	4.3	7.4	4.1	7.6	4.0	3.6	



8.2 Heating

TC: total capacity **WB:** wet-bulb temperature **DB:** dry-bulb temperature

Indoor Unit size (kW)	Outdoor temperature (°F)		Indoor temperature (°F DB)					
			60.8	64.4	68	69.8	71.6	75.2
	WB	DB	TC kW	TC kW	TC kW	TC kW	TC kW	TC kW
1.8	-3.64	-4	1.23	1.23	1.23	1.23	1.23	1.23
	-1.84	-2.2	1.32	1.32	1.32	1.32	1.32	1.32
	1.94	1.4	1.39	1.39	1.39	1.39	1.39	1.39
	7.34	5	1.43	1.43	1.43	1.43	1.43	1.43
	10.76	8.6	1.52	1.52	1.52	1.52	1.52	1.52
	14.36	12.2	1.54	1.56	1.56	1.56	1.56	1.56
	14.9	14	1.61	1.61	1.61	1.61	1.61	1.61
	16.7	15.62	1.65	1.65	1.65	1.65	1.65	1.65
	19.4	18.32	1.67	1.67	1.67	1.67	1.67	1.67
	23	21.92	1.74	1.74	1.74	1.74	1.74	1.74
	26.6	25.34	1.83	1.83	1.83	1.83	1.83	1.83
	32	30.74	1.96	1.96	1.96	1.96	1.96	1.85
	37.4	35.96	2.07	2.07	2.07	2.07	2.02	1.85
	41	39.38	2.13	2.13	2.13	2.13	2.02	1.85
	44.6	42.8	2.20	2.20	2.20	2.13	2.02	1.85
	48.2	46.22	2.27	2.27	2.20	2.13	2.02	1.85
	51.8	49.64	2.33	2.33	2.20	2.13	2.02	1.85
	55.4	53.24	2.42	2.38	2.20	2.13	2.02	1.85
59	56.66	2.49	2.38	2.20	2.13	2.02	1.85	
2.2	-3.64	-4	1.46	1.46	1.46	1.46	1.46	1.46
	-1.84	-2.2	1.56	1.56	1.56	1.56	1.56	1.56
	1.94	1.4	1.64	1.64	1.64	1.64	1.64	1.64
	7.34	5	1.69	1.69	1.69	1.69	1.69	1.69
	10.76	8.6	1.79	1.79	1.79	1.79	1.79	1.79
	14.36	12.2	1.82	1.85	1.85	1.85	1.85	1.85
	14.9	14	1.90	1.90	1.90	1.90	1.90	1.90
	16.7	15.62	1.95	1.95	1.95	1.95	1.95	1.95
	19.4	18.32	1.98	1.98	1.98	1.98	1.98	1.98
	23	21.92	2.05	2.05	2.05	2.05	2.05	2.05
	26.6	25.34	2.16	2.16	2.16	2.16	2.16	2.16
	32	30.74	2.31	2.31	2.31	2.31	2.31	2.18
	37.4	35.96	2.44	2.44	2.44	2.44	2.39	2.18
	41	39.38	2.52	2.52	2.52	2.52	2.39	2.18
	44.6	42.8	2.60	2.60	2.60	2.52	2.39	2.18
	48.2	46.22	2.68	2.68	2.60	2.52	2.39	2.18
	51.8	49.64	2.76	2.76	2.60	2.52	2.39	2.18
	55.4	53.24	2.86	2.81	2.60	2.52	2.39	2.18
59	56.66	2.94	2.81	2.60	2.52	2.39	2.18	
2.8	-3.64	-4	1.79	1.79	1.79	1.79	1.79	1.79
	-1.84	-2.2	1.92	1.92	1.92	1.92	1.92	1.92
	1.94	1.4	2.02	2.02	2.02	2.02	2.02	2.02
	7.34	5	2.02	2.02	2.02	2.02	2.02	2.02
	10.76	8.6	2.14	2.14	2.14	2.14	2.14	2.14
	14.36	12.2	2.24	2.24	2.24	2.24	2.24	2.24
	14.9	14	2.34	2.34	2.34	2.34	2.34	2.34
	16.7	15.62	2.40	2.40	2.40	2.40	2.40	2.40
	19.4	18.32	2.43	2.43	2.43	2.43	2.43	2.43
	23	21.92	2.53	2.53	2.53	2.53	2.53	2.53
	26.6	25.34	2.66	2.66	2.66	2.66	2.66	2.66
	32	30.74	2.85	2.85	2.85	2.85	2.85	2.69
	37.4	35.96	3.01	3.01	3.01	3.01	2.94	2.69
	41	39.38	3.10	3.10	3.10	3.10	2.94	2.69
	44.6	42.8	3.20	3.20	3.20	3.10	2.94	2.69
	48.2	46.22	3.30	3.30	3.20	3.10	2.94	2.69
	51.8	49.64	3.39	3.39	3.20	3.10	2.94	2.69
	55.4	53.24	3.52	3.46	3.20	3.10	2.94	2.69
59	56.66	3.62	3.46	3.20	3.10	2.94	2.69	
3.6	-3.64	-4	2.24	2.24	2.24	2.24	2.24	2.24
	-1.84	-2.2	2.40	2.40	2.40	2.40	2.40	2.40

Indoor Unit size (kW)	Outdoor temperature (°F)		Indoor temperature (°F DB)					
			60.8	64.4	68	69.8	71.6	75.2
	WB	DB	TC	TC	TC	TC	TC	TC
3.6	1.94	1.4	2.52	2.52	2.52	2.52	2.52	2.52
	7.34	5	2.60	2.60	2.60	2.60	2.60	2.60
	10.76	8.6	2.68	2.68	2.68	2.68	2.68	2.68
	14.36	12.2	2.80	2.80	2.80	2.80	2.80	2.80
	14.9	14	2.92	2.92	2.92	2.92	2.92	2.92
	16.7	15.62	3.00	3.00	3.00	3.00	3.00	3.00
	19.4	18.32	3.04	3.04	3.04	3.04	3.04	3.04
	23	21.92	3.16	3.16	3.16	3.16	3.16	3.16
	26.6	25.34	3.32	3.32	3.32	3.32	3.32	3.32
	32	30.74	3.56	3.56	3.56	3.56	3.56	3.36
	37.4	35.96	3.76	3.76	3.76	3.76	3.68	3.36
	41	39.38	3.88	3.88	3.88	3.88	3.68	3.36
	44.6	42.8	4.00	4.00	4.00	3.88	3.68	3.36
	48.2	46.22	4.12	4.12	4.00	3.88	3.68	3.36
	51.8	49.64	4.24	4.24	4.00	3.88	3.68	3.36
	55.4	53.24	4.40	4.32	4.00	3.88	3.68	3.36
59	56.66	4.52	4.32	4.00	3.88	3.68	3.36	
4.5	-3.64	-4	2.80	2.80	2.80	2.80	2.80	2.80
	-1.84	-2.2	3.00	3.00	3.00	3.00	3.00	3.00
	1.94	1.4	3.15	3.15	3.15	3.15	3.15	3.15
	7.34	5	3.25	3.25	3.25	3.25	3.25	3.25
	10.76	8.6	3.35	3.35	3.35	3.35	3.35	3.35
	14.36	12.2	3.50	3.50	3.50	3.50	3.50	3.50
	14.9	14	3.65	3.65	3.65	3.65	3.65	3.65
	16.7	15.62	3.75	3.75	3.75	3.75	3.75	3.75
	19.4	18.32	3.80	3.80	3.80	3.80	3.80	3.80
	23	21.92	3.95	3.95	3.95	3.95	3.95	3.95
	26.6	25.34	4.15	4.15	4.15	4.15	4.15	4.15
	32	30.74	4.45	4.45	4.45	4.45	4.45	4.20
	37.4	35.96	4.70	4.70	4.70	4.70	4.60	4.20
	41	39.38	4.85	4.85	4.85	4.85	4.60	4.20
	44.6	42.8	5.00	5.00	5.00	4.85	4.60	4.20
	48.2	46.22	5.15	5.15	5.00	4.85	4.60	4.20
51.8	49.64	5.30	5.30	5.00	4.85	4.60	4.20	
55.4	53.24	5.50	5.40	5.00	4.85	4.60	4.20	
59	56.66	5.65	5.40	5.00	4.85	4.60	4.20	
5.6	-3.64	-4	3.53	3.53	3.53	3.53	3.53	3.53
	-1.84	-2.2	3.78	3.78	3.78	3.78	3.78	3.78
	1.94	1.4	3.97	3.97	3.97	3.97	3.97	3.97
	7.34	5	4.10	4.10	4.10	4.10	4.10	4.10
	10.76	8.6	4.22	4.22	4.22	4.22	4.22	4.22
	14.36	12.2	4.41	4.41	4.41	4.41	4.41	4.41
	14.9	14	4.60	4.60	4.60	4.60	4.60	4.60
	16.7	15.62	4.73	4.73	4.73	4.73	4.73	4.73
	19.4	18.32	4.79	4.79	4.79	4.79	4.79	4.79
	23	21.92	4.98	4.98	4.98	4.98	4.98	4.98
	26.6	25.34	5.23	5.23	5.23	5.23	5.23	5.23
	32	30.74	5.61	5.61	5.61	5.61	5.61	5.29
	37.4	35.96	5.92	5.92	5.92	5.92	5.80	5.29
	41	39.38	6.11	6.11	6.11	6.11	5.80	5.29
	44.6	42.8	6.30	6.30	6.30	6.11	5.80	5.29
	48.2	46.22	6.49	6.49	6.30	6.11	5.80	5.29
51.8	49.64	6.68	6.68	6.30	6.11	5.80	5.29	
55.4	53.24	6.93	6.80	6.30	6.11	5.80	5.29	
59	56.66	7.12	6.80	6.30	6.11	5.80	5.29	
7.1	-3.64	-4	4.48	4.48	4.48	4.48	4.48	4.48
	-1.84	-2.2	4.80	4.80	4.80	4.80	4.80	4.80
	1.94	1.4	5.04	5.04	5.04	5.04	5.04	5.04
	7.34	5	5.20	5.20	5.20	5.20	5.20	5.20
	10.76	8.6	5.52	5.52	5.52	5.52	5.52	5.52
	14.36	12.2	5.60	5.68	5.68	5.68	5.68	5.68

Indoor Unit size (kW)	Outdoor temperature (°F)		Indoor temperature (°F DB)					
			60.8	64.4	68	69.8	71.6	75.2
	WB	DB	TC	TC	TC	TC	TC	TC
7.1	14.9	14	5.84	5.84	5.84	5.84	5.84	5.84
	16.7	15.62	6.00	6.00	6.00	6.00	6.00	6.00
	19.4	18.32	6.08	6.08	6.08	6.08	6.08	6.08
	23	21.92	6.32	6.32	6.32	6.32	6.32	6.32
	26.6	25.34	6.64	6.64	6.64	6.64	6.64	6.64
	32	30.74	7.12	7.12	7.12	7.12	7.12	6.72
	37.4	35.96	7.52	7.52	7.52	7.52	7.36	6.72
	41	39.38	7.76	7.76	7.76	7.76	7.36	6.72
	44.6	42.8	8.00	8.00	8.00	7.76	7.36	6.72
	48.2	46.22	8.24	8.24	8.00	7.76	7.36	6.72
	51.8	49.64	8.48	8.48	8.00	7.76	7.36	6.72
	55.4	53.24	8.80	8.64	8.00	7.76	7.36	6.72
59	56.66	9.04	8.64	8.00	7.76	7.36	6.72	



9.Electrical Characteristics

Model	Indoor Unit				Power Supply		IFM	
	Hz	Voltage	Min.	Max.	MCA	MFA	KW	FLA
MDV-D18T3/VN1-C	60	208-230	187	253	0.325	5A	0.027	0.26
MDV-D22T3/VN1-C	60	208-230	187	253	0.325	5A	0.027	0.26
MDV-D28T3/VN1-C	60	208-230	187	253	0.325	5A	0.027	0.26
MDV-D36T3/VN1-C	60	208-230	187	253	0.375	5A	0.027	0.3
MDV-D45T3/VN1-C	60	208-230	187	253	0.59	5A	0.047	0.47
MDV-D56T3/VN1-C	60	208-230	187	253	0.59	5A	0.047	0.47
MDV-D71T3/VN1-C	60	208-230	187	253	0.72	5A	0.065	0.58

Remark:

MCA: Min. Current Amps. (A)

MFA: Max. Fuse Amps. (A)

KW: Fan Motor Rated Output (kW)

FLA: Full Load Amps. (A)

IFM:Indoor Fan Motor



10.Sound Levels

10.1 Test condition

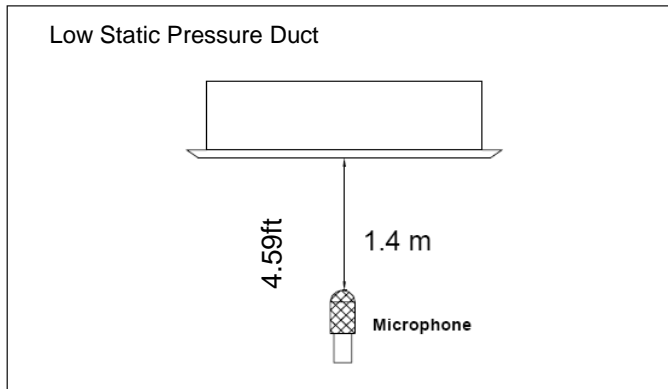

Note:

- 1, during actual operation, these values are normally somewhat higher as a result of ambient conditions.
- 2, Semi-anechoic chamber conversion value, measured at a point which is 4.59ft(1.4m) under the unit.

10.2 Test value

Model	Sound Levels value dB(A)		
	H	M	L
MDV-D18T3/VN1-C	35	27	24
MDV-D22T3/VN1-C	35	27	24
MDV-D28T3/VN1-C	35	27	24
MDV-D36T3/VN1-C	38	32	28
MDV-D45T3/VN1-C	39	32	29
MDV-D56T3/VN1-C	39	32	29
MDV-D71T3/VN1-C	41	33	30

MDV-D18T3/VN1-C, MDV-D22T3/VN1-C, MDV-D28T3/VN1-C

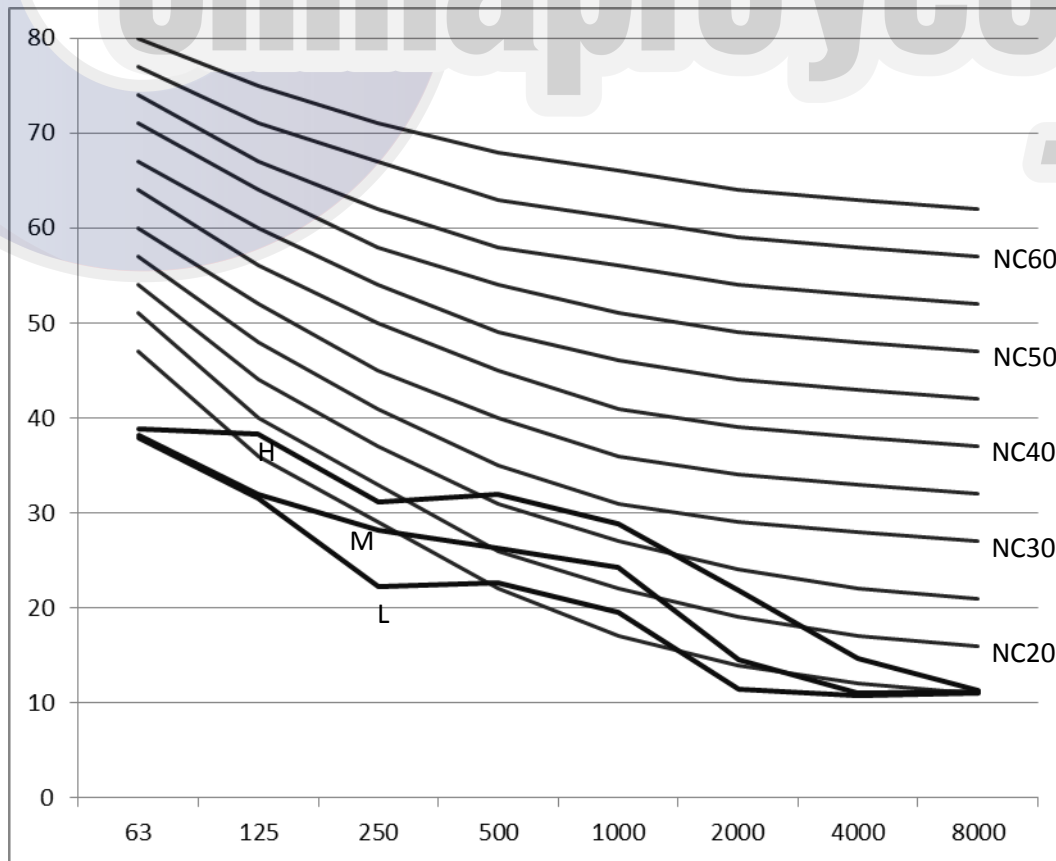

MDV-D36T3/VN1-C

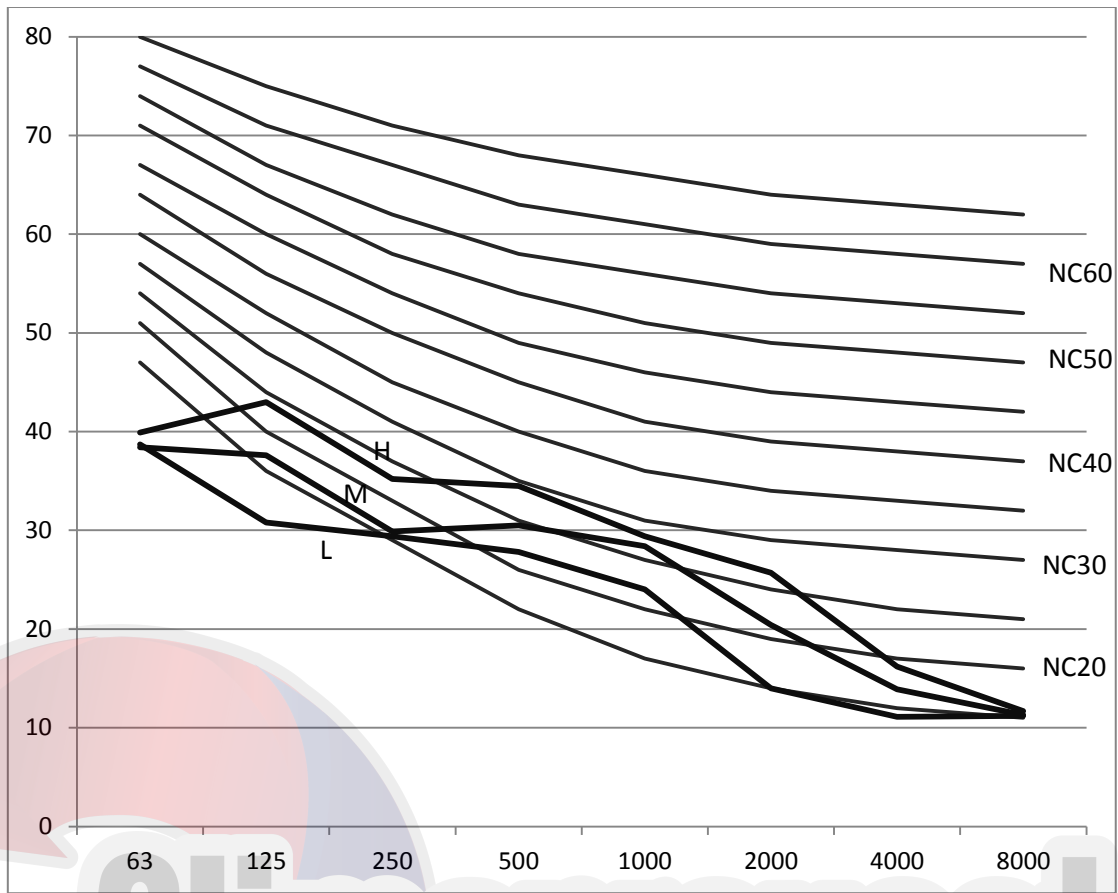

MDV-D45T3/VN1-C, MDV-D56T3/VN1-C

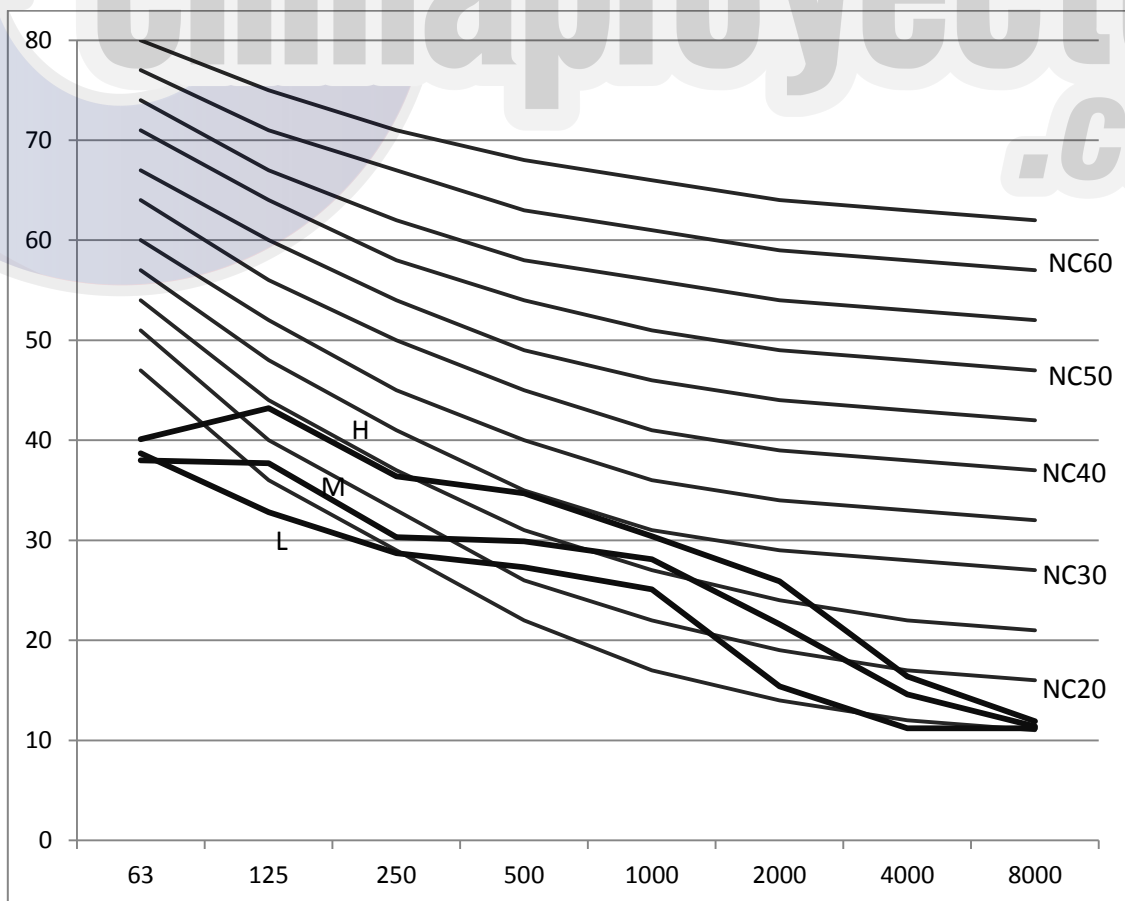



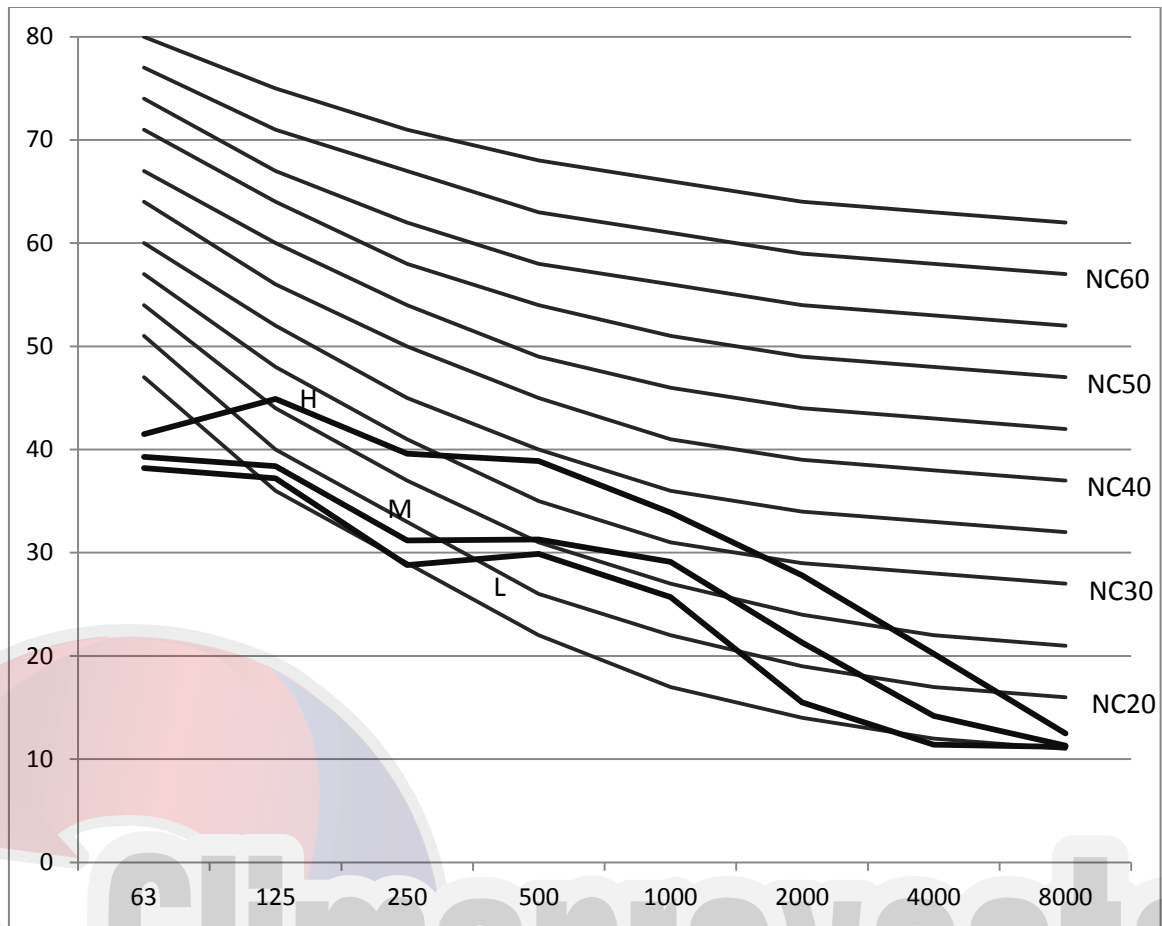









MDV-D71T3/VN1-C



11. Accessories

11.1 Standard accessories

Name of accessories	Quantity	Outline	Usage
Installation manual	1	(This manual)	/
Remote controller	1		Remote control the air-conditioner
Frame	1		/
7# alkaline battery	2		For remote controller
Remote controller manual	1		/
Pipe insulation material	2		Heat insulation
Adhesive tape for sea	1		To connect drain pipe
Water outlet joint	1		For drainage
Clasp	1		Chucking the joint which connect the drain hose and the outlet of indoor unit
Copper nut	1		Use for pipe connection of engineering installation
Signal receive and display box	1		Receive and display signal
Signal receive and display box installation manual	1		Display box installation manual
Gasket	8		Secure the Installation lifting lug
Installation spring	2		Fix water outlet

Concealed Duct Unit (Slim A5 Type)

1. Features	26
2. Specifications	28
3. Dimensions	30
4. Service Spaces	32
5. Piping Diagrams	33
6. Wiring Diagrams	34
7. Fan Performance	35
8. Capacity Tables	37
9. Electrical Characteristics	42
10. Sound Levels	43
11. Accessories	46

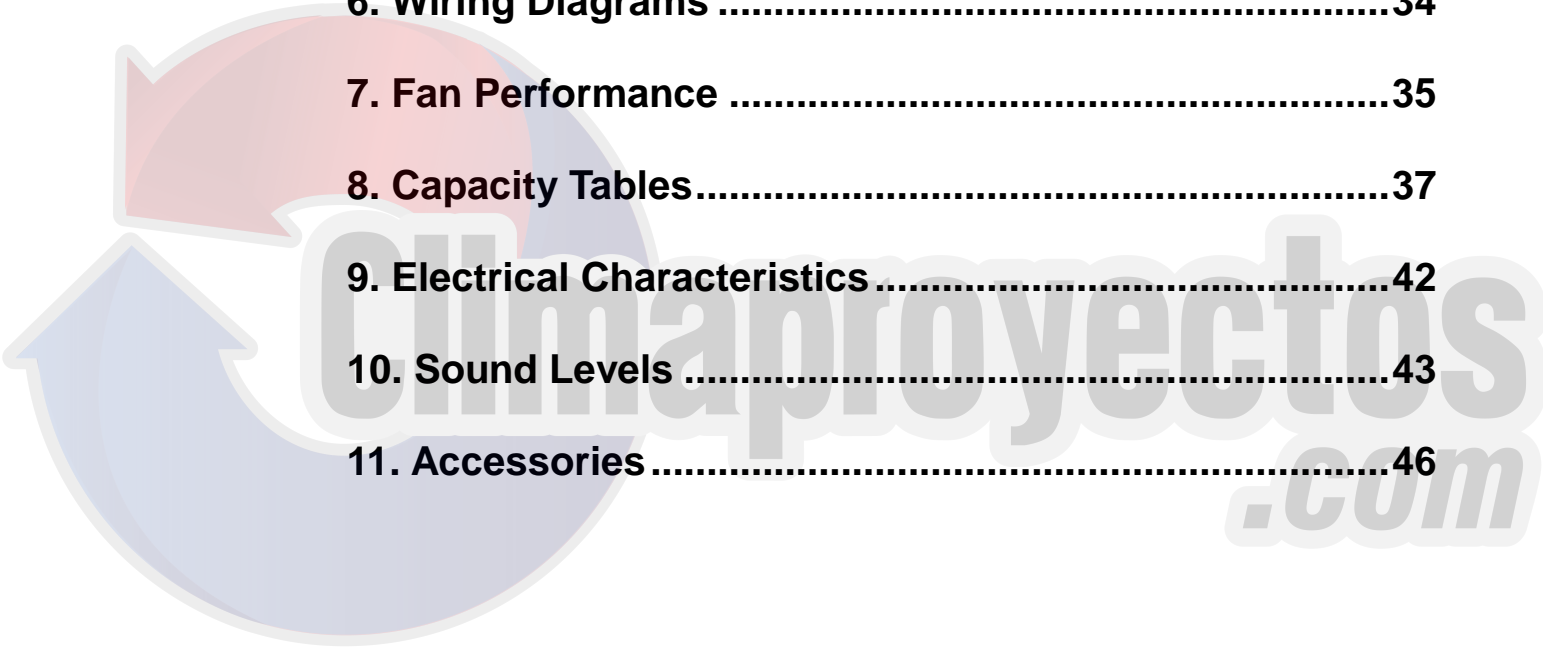

1. Features

1.1 Compact design

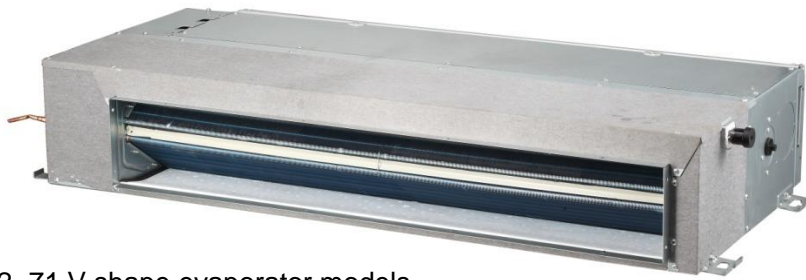

22~71 V shape evaporator models

1.1.1 Only 8-17/64in.(210 mm) in height and 19-11/16in.(500mm) in depth, these models can be installed in rooms with as little as 9-7/16in.~11-13/16in.(240mm~300mm) height between the drop ceiling and ceiling slab, and rooms required less depth.

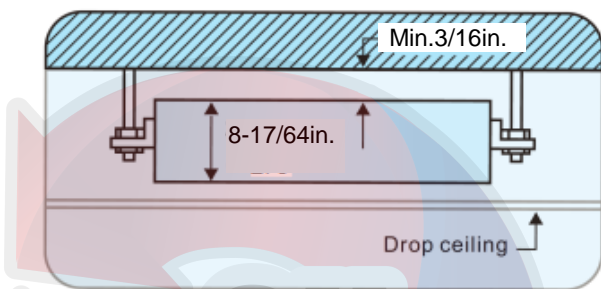

1.2 Wide capacity range

—The capacity ranges from 7500Btu/h~24200Btu/h(2.2kW to 7.1kW), totally seven models available.

1.3 Four speed fan motor(Super High ‘SH’ speed as an option)

1.4 Two external static pressure settings for added flexibility

Just exchange the wiring connection of ‘SH’ and ‘H’. P2 and P3 as the right side diagram.

1.5 Convenient installation

1.5.1 The EXV is fixed inside the indoor unit.

1.5.2 Standard filter with aluminum frame, which is removable downward from the bottom.

1.5.3 Suction chamber is included as standard equipment.

1.5.4 Flange for air in/outlet duct connection is standard.

1.5.5 Air inlet from back standard and from bottom optional

Size of the plate from bottom and flange from back is the same, which makes it possible to convert the air return from back to bottom easily by installer.

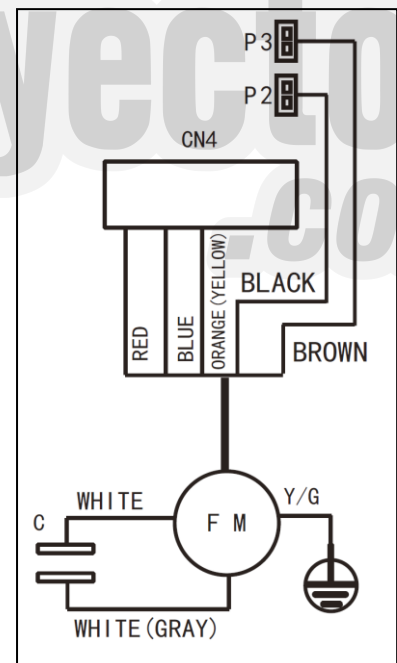

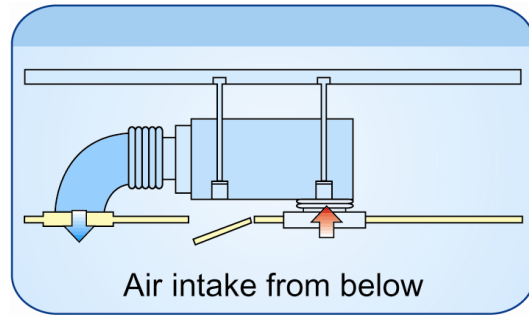
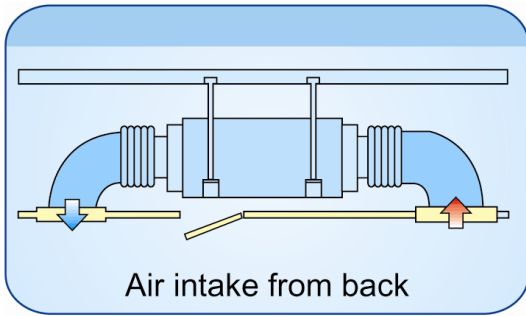

1.5.6 Standard built-in drain pump

Drain pump is equipped as standard accessory with 27-9/16in.(750mm) pump head.

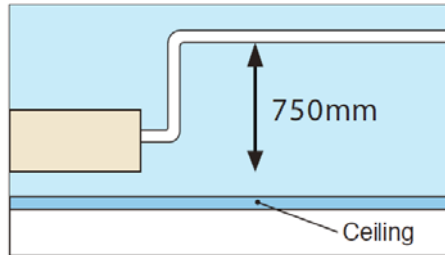

1.6 Flexible control and convenient for maintenance

1.6.1 Standard wired remote controller KJR-29B1/BK-E, and wireless remote controller RM05/BG(T)E-A is optional.

1.6.2 The display board is connected with the E-box in factory, which makes troubleshooting easier by LED display.



22~71 model (V shape evaporator) (Standard)

1.6.3 The electrical control box is possible to remove 1m far away from the main unit, which is suitable for the small space hard to maintain. (It should be required by client in advance and done by Midea CAC in factory)

1.6.4 The EXV is fixed inside the indoor unit, which is weld connection and convenient for installation.

1.6.5 Standard functional port such as Remote On/Off Dry contact switch, and Alarm signal output (220V).

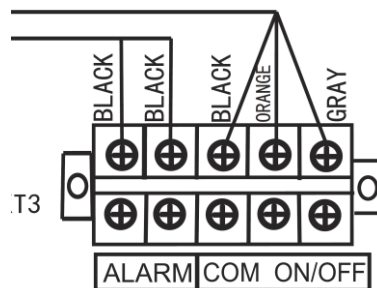

1.7 Auto restart

When there is a power failure, the indoor unit will restart automatically after power restores, and the operation state will be the same as its original state.

2. Specifications

Model			MDV-D22T2/VN1-DA5	MDV-D28T2/VN1-DA5	MDV-D36T2/VN1-DA5
Power supply		V- Ph-Hz	208-230V~, 1Ph, 60Hz		
Cooling	Capacity	kW	2.2	2.8	3.6
		Btu/h	7500	9600	12300
	Input	W	66	72	77
	Rated current	A	0.24	0.24	0.28
Heating	Capacity	kW	2.6	3.2	4.0
		Btu/h	8900	10900	13600
	Input	W	66	72	77
	Rated current	A	0.24	0.24	0.28
Indoor fan motor	Model		YSK27-4G	YSK27-4G	YSK27-4G
	Type		AC Motor		
	Brand		Yongan/Welling		
	Input	W	47.1	47.1	60
	Capacitor	μF	1.5μF/450V	1.5μF/450V	2μF/450V
	Speed (SH/H/M/L)	r/min	1150/1040/960/850	1150/1040/960/850	1235/1100/980/870
Indoor coil	Number of rows		2	2	2
	Tube pitch(a) × row Pitch(b)	in.(mm)	13/16×17/32(21×13.37)		
	Fin spacing	in.(mm)	1/16(1.5)	1/16(1.5)	1/16(1.5)
	Fin type		Hydrophilic aluminum		
	Tube outside diameter and type	in.(mm)	9/32(Φ7) Inner groove tube		
	Length × height xwidth	in.(mm)	20-9/32×5-25/32×1-3/64 (515×147×26.74)	20-9/32×5-25/32×1-37/64 (515×147×40.1)	
	Number of circuits		3	4	4
Indoor air flow (SH/H/M/L)	m ³ /h		588(30pa)/538/456/375	588(30pa)/538/456/375	614(30pa)/597/514/429
	CFM		346/317/268/221	346/317/268/221	361/351/303/253
Indoor external static pressure		Pa	10(10~30)		
Indoor noise level (H/M/L)		dB(A)	36/35/32	37/35/32	38.6/37.5/33.8
Indoor unit	Dimension	in.(mm)	30-45/64×8-17/64×19-11/16(780×210×500)		
	Packing (W×H×D)	in.(mm)	34-1/4×11-7/32×20-43/64(870×285×525)		
	Net/Gross weight	lbs.(kg)	38.6/44.1(17.5/20)		
Fresh Air intake hole diameter		in.(mm)	3-5/8(Φ92)	3-5/8(Φ92)	3-5/8(Φ92)
Refrigerant type		R410A			
Throttle	Type		Electronic expansion valve		
	Model		BD20FKS(L)		
Design pressure(H/L)		MPa	4.4/2.6		
Refrigerant piping	Liquid / Gas	in.(mm)	1/4(Φ6.35)/1/2(Φ12.7)		
Connecting wiring	Power	mm ²	3×2.5(L≤20m); 3×3.5(L≤50m)		
	Signal	mm ²	3×0.75		
Drainage water pipe diameter		in.(m)	OD 63/64(Φ25)		
Controller		Wired controller KJR-29B1/BK-E (6 meters connection wire)			

Notes: 1. Nominal cooling capacities are based on the following conditions: return air temperature : 80.6°F(27°C)DB/66.2°F(19°C)WB, outdoor temperature:95°F(35°C)DB, equivalent piping: 26.25ft(8m)(horizontal).

2. Nominal heating capacities are based on the following conditions: return air temperature: 68°F(20°C)DB, outdoor temperature: 44.6°F(7°C)DB/42.8°F(6°C)WB, equivalent piping: 26.25ft(8m)(horizontal).

Model		MDV-D45T2/VN1-DA5	MDV-D56T2/VN1-DA5	MDV-D71T2/VN1-DA5	
Power supply		V- Ph-Hz	208-230V~, 1Ph, 60Hz		
Cooling	Capacity	kW	4.5	5.6	7.1
		Btu/h	15400	19100	24200
	Input	W	100	100	125
	Rated current	A	0.48	0.48	0.6
Heating	Capacity	kW	5	6.3	8.0
		Btu/h	17100	21500	27300
	Input	W	100	100	125
	Rated current	A	0.48	0.48	0.6
Indoor fan motor	Model		YSK47-4G	YSK47-4G	YSK65-4G
	Type		AC Motor	AC Motor	AC Motor
	Brand		Yongan	Yongan	Yongan
	Input	W	95	95	121
	Capacitor	μF	3.5μF/450V	3.5μF/450V	3.5μF/450V
	Speed	r/min	1235/1130/950/810	1235/1130/950/810	1270/1080/930/780
Indoor coil	Number of rows		2	2	2
	Tube pitch(a) ×	in.(mm)	13/16×17/32(21×13.37)	13/16×17/32(21×13.37)	13/16×17/32(21×13.37)
	Fin spacing	in.(mm)	3/64(1.3)	3/64(1.3)	3/64(1.3)
	Fin type		Hydrophilic aluminum	Hydrophilic aluminum	Hydrophilic aluminum
	Tube outside	in.(mm)	9/32(Φ7)		
	Length × height × width	in.(mm)	28-57/64×5-25/32×1-3/64 (734×147×26.74)	28-57/64×5-25/32×1-3/64 (734×147×26.74)	37-31/64×5-25/32×1-3/64 (952×147×26.74)
	Number of circuits		6	6	6
Indoor air flow (SH/H/M/L)		m ³ /h	763(30pa)/811/684/575	763(30pa)/811/684/575	1127(30pa)/1029/934/781
		CFM	449/477/403/338	449/477/403/338	663/606/550/460
Indoor external static		Pa	10(10~30)	10(10~30)	10(10~30)
Indoor noise level (H/M/L)		dB(A)	39/37.9/34	39/37.9/34	41.4/39/35
Indoor unit	Dimension (W×H×D)	in.(mm)	39-3/8×8-17/64×19-11/16(1000×210×500)		48-1/32×8-17/64×19-11/16 (1220×210×500)
	Packing (W×H×D)	in.(mm)	43-57/64×11-7/32×20-43/64(1115×285×525)		52-9/16×11-7/32×20-43/64 (1335×285×525)
	Net/Gross weight	lbs.(kg)	49.6/57.3(22.5/26)	49.6/57.3(22.5/26)	61.8/69.5(28/31.5)
Fresh Air intake hole diameter		in.(mm)	3-5/8(Φ92)	3-5/8(Φ92)	3-5/8(Φ92)
Refrigerant type			R410A	R410A	R410A
Throttle		Type	Electronic expansion valve		
		Model	BD20FKS(L)	BD20FKS(L)	BD20FKS(L)
Design pressure(H/L)		MPa	4.4/2.6	4.4/2.6	4.4/2.6
Refrigerant	Liquid / Gas	in.(mm)	1/4(Φ6.35)/1/2(Φ12.7)	3/8(Φ9.53)/5/8(Φ15.9)	3/8(Φ9.53)/5/8 (Φ15.9)
Connecting wiring	Power wiring	mm ²	3×2.5(L≤20m); 3×3.5(L≤50m)		
	Signal wiring	mm ²	3×0.75		
Drainage water pipe diameter		in.(mm)	OD 63/64(Φ25)		
Controller			Wired controller KJR-29B1/BK-E (6 meters connection wire)		

Notes: 1. Nominal cooling capacities are based on the following conditions: return air temperature : 80.6°F(27°C)DB/ 66.2°F(19°C)WB, outdoor temperature:95°F(35°C)DB, equivalent piping: 26.25ft(8m)(horizontal).

2. Nominal heating capacities are based on the following conditions: return air temperature: 68°F(20°C)DB, outdoor temperature: 44.6°F(7°C)DB/42.8°F(6°C)WB, equivalent piping: 26.25ft(8m)(horizontal).

3. Dimensions

For models:

MDV-D22T2/VN1-DA5 MDV-D28T2/VN1-DA5 MDV-D36T2/VN1-DA5

MDV-D45T2/VN1-DA5 MDV-D56T2/VN1-DA5 MDV-D71T2/VN1-DA5

Outline dimension and air outlet opening size:

Unit: in.(mm)

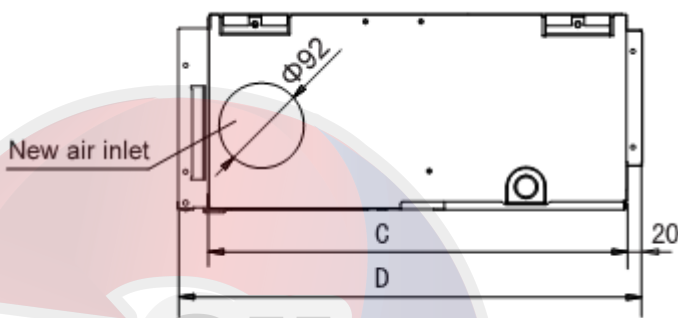
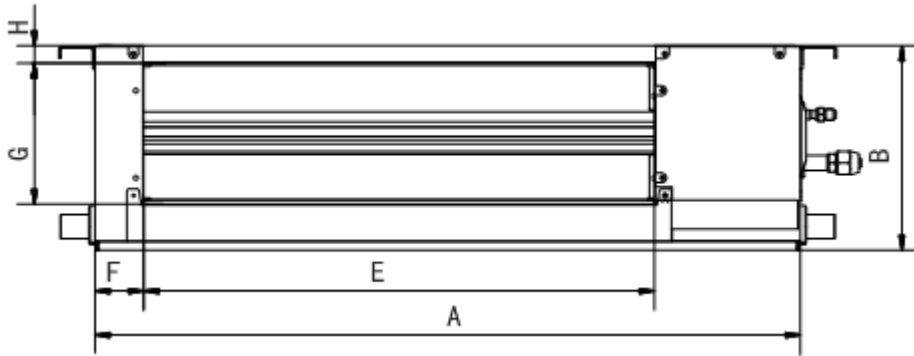

Air return opening size:

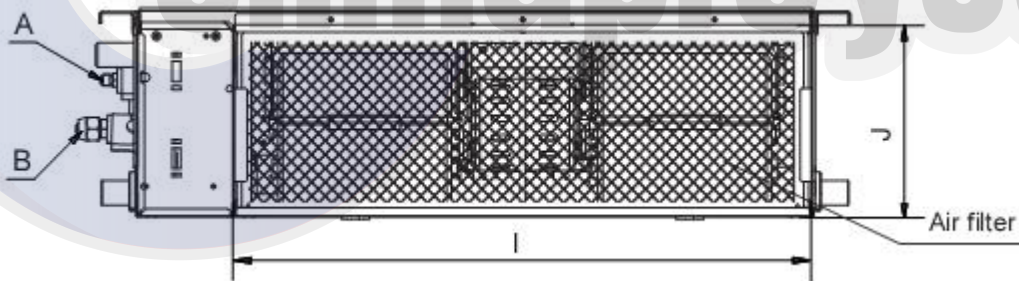

Position size of declensional ventilation opening:

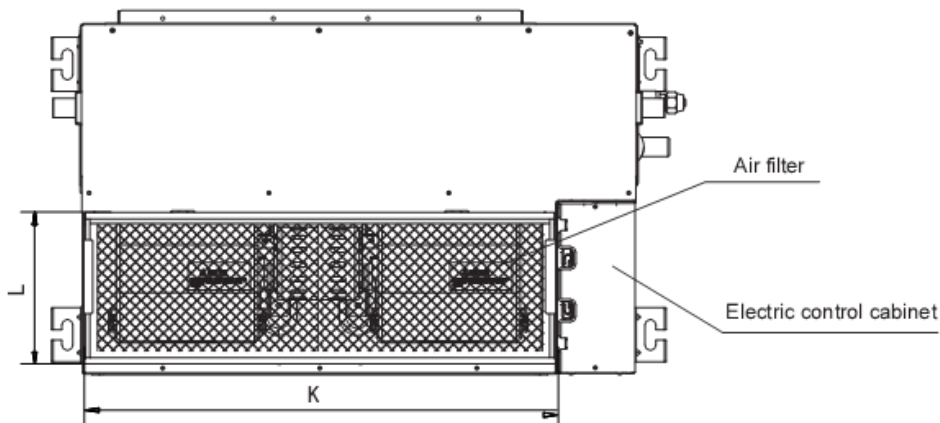

Size of mounted lug:

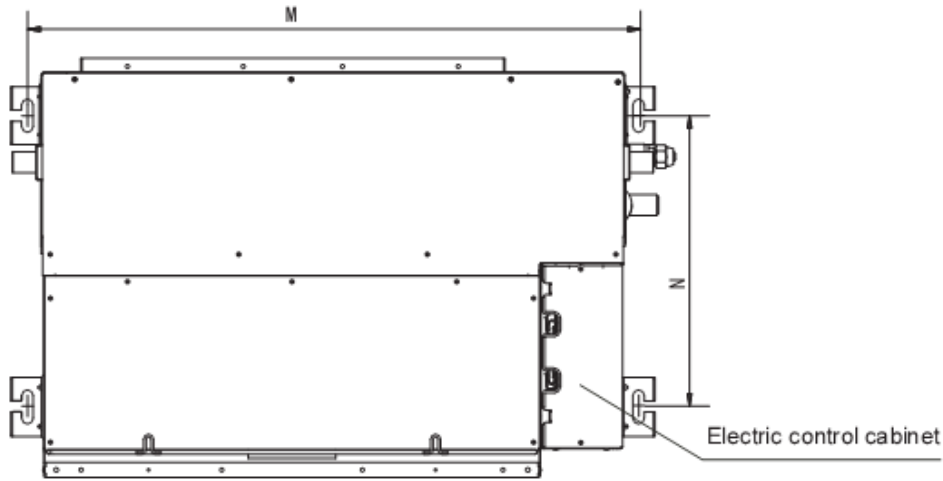

Mode(W)	A	B	C	D	E	F	G	H	I	J	K	L	M	N
1500~3600	700	210	450	500	512	45	145	17	600	196	600	196	740	350
4500~5600	920	210	450	500	732	45	145	17	820	200	820	200	960	350
7100	1140	210	450	500	950	45	145	17	1040	200	1040	200	1180	350



4. Service Spaces

- Ensure the needed spaces for installation and maintenance.
- The ceiling is horizontal and its structure can endure the weight of the indoor unit.
- The outlet and the inlet are not impeded, and the influence of external air is the least.
- The air flow can reach throughout the room.
- The connecting pipe and drainpipe could be extracted out easily.
- There is no direct radiation from heaters.

Confirm that there is enough room for installation and maintenance:

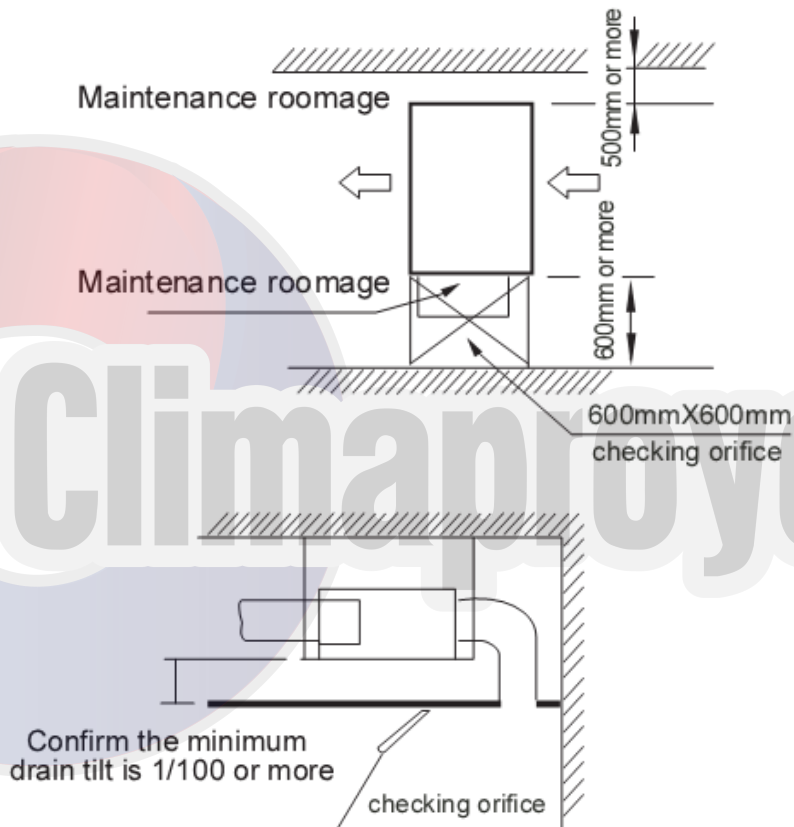

- (1) Air inlet and air outlet duct should be apart far enough to prevent air outlet entering air inlet.
- (2) There is dust filter on the indoor unit.

Recommended duct connection:

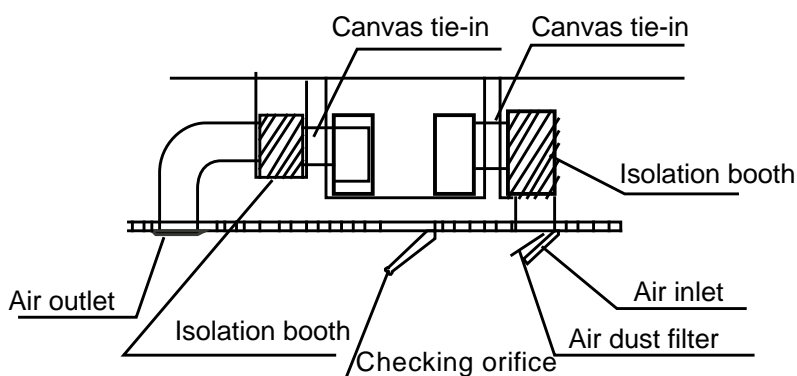

5. Piping Diagrams

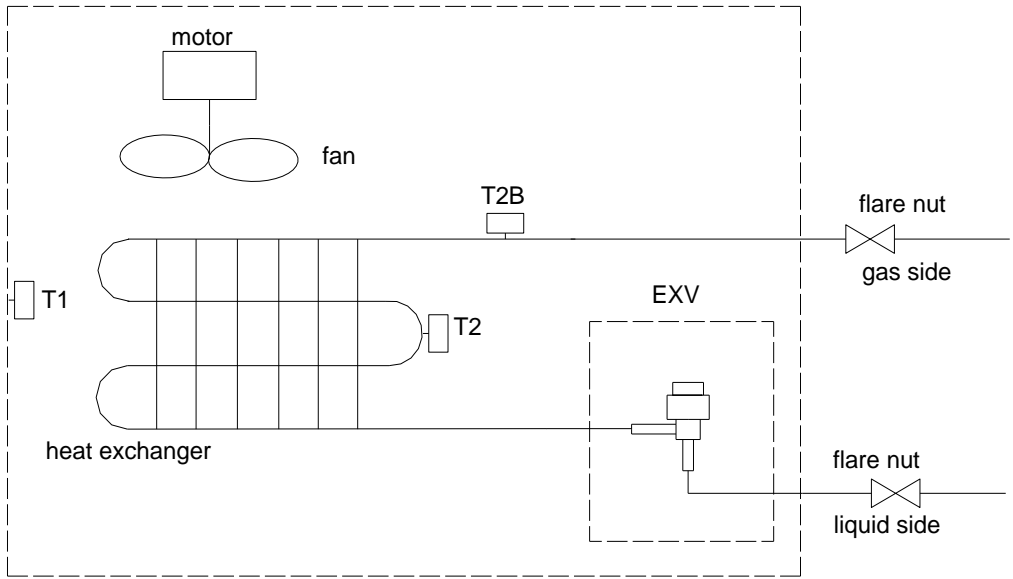

6. Wiring Diagrams

For models: MDV-D22T2/VN1-DA5, MDV-D28T2/VN1-DA5, MDV-D36T2/VN1-DA5, MDV-D45T2/VN1-DA5, MDV-D56T2/VN1-DA5,MDV-D71T2/VN1-DA5

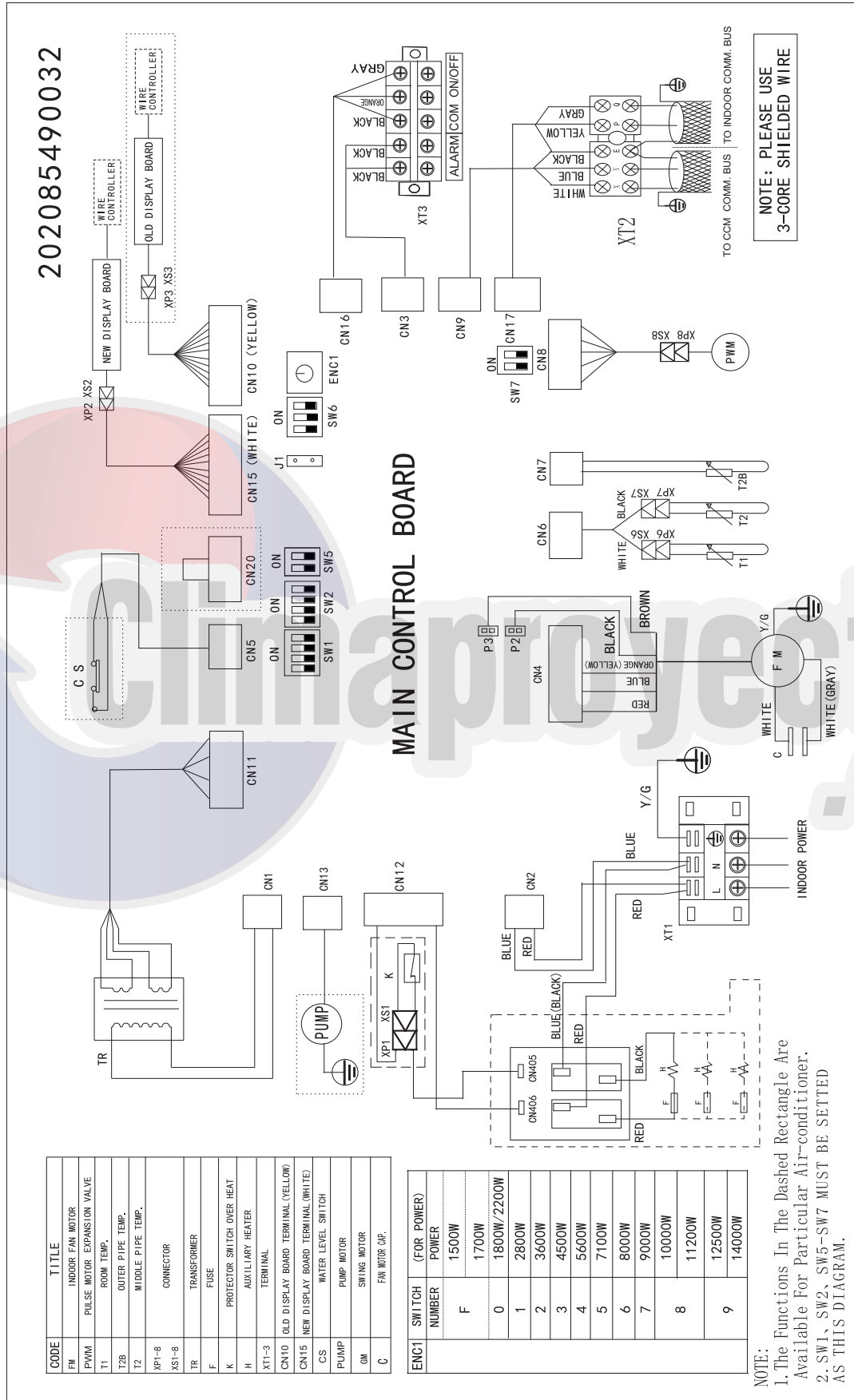

7. Fan Performance

How to Read the Diagram

The vertical axis is the External Static Pressure (**Pa**) while the horizontal axis represents the Air Flow (**CFM**).

The characteristic curve for the “H”, “M” and “L” fan speed control, as well the reserved “SH” speed.

The nameplate values are shown based on the “H” air flow.

Therefore in the case of **22T2** Type, the air flow is 538 (m³/h), while the External Static Pressure is 10Pa at “H” position. If 30Pa needed, the airflow is at “SH”.

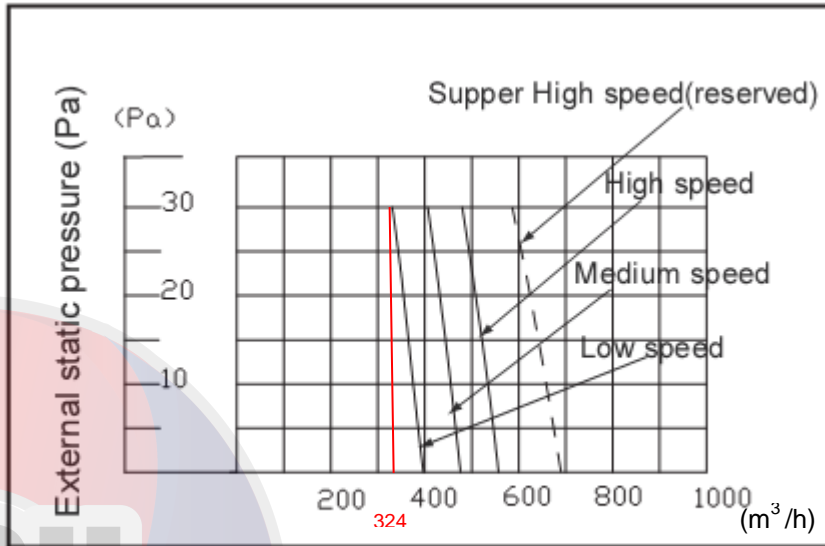

2.2KW~2.8KW

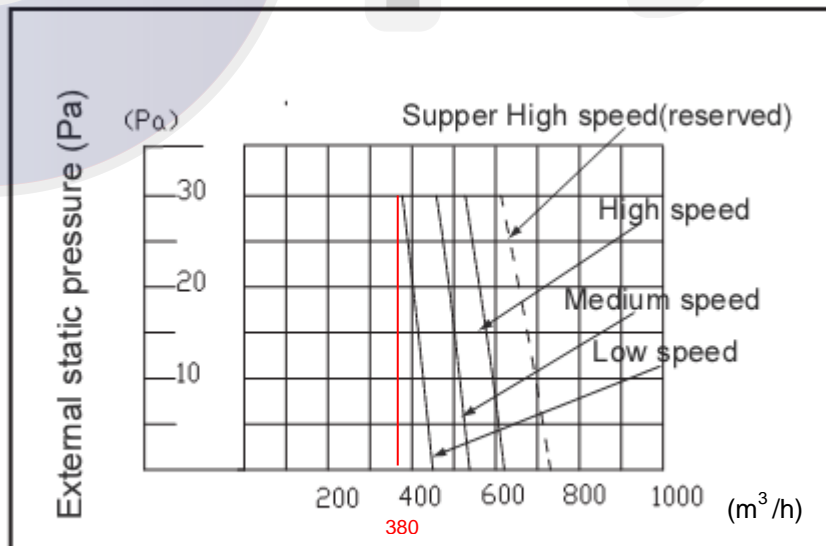

3.6KW

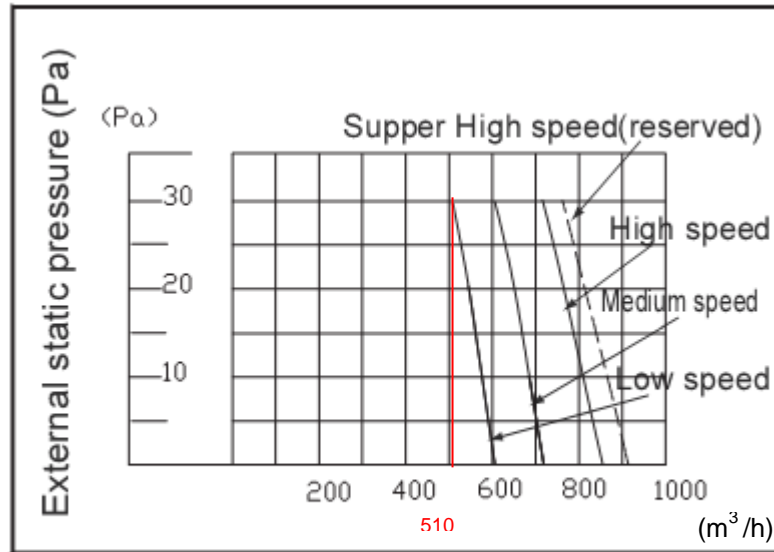

4.5KW~5.6KW

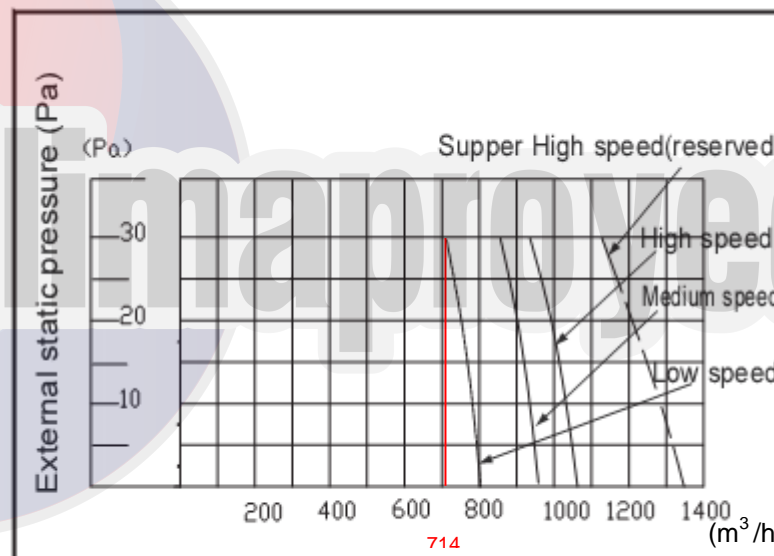

7.1KW

- If the external static pressure is too great (due to long extension of duct, for example), the air flow volume may drop too low at each air outlet.
- So there's a limit air flow volume line for each speed and it is the min. airflow of this duct unit. At this flow volume, the fan achieves the max. ESP and indoor evaporator may be protected by low temperature.
- As well, there's a limit air flow volume, which is the max. value at each speed. It requests the unit to connect ducts for air inlet and outlet to prevent damage from the high temperature of motor/evaporator.

8.Capacity Tables

8.1 Cooling

TC: Total capacity SC: Sensible capacity WB: Wet-bulb temperature DB: Dry-bulb temperature

Indoor Unit size (kW)	Outdoor temperature (°F DB)	Indoor temperature (°F WB/DB)													
		57.2/68		60.8/73.4		64.4/78.8		66.2/80.6		68/82.4		71.6/86		75.2/89.6	
		TC	SC	TC	SC	TC	SC	TC	SC	TC	SC	TC	SC	TC	SC
		kW	kW	kW	kW	kW	kW	kW	kW	kW	kW	kW	kW	kW	kW
2.2	50	1.5	1.4	1.8	1.5	2.1	1.6	2.2	1.6	2.3	1.7	2.6	1.7	2.9	1.7
	53.6	1.5	1.4	1.8	1.5	2.1	1.6	2.2	1.6	2.3	1.7	2.6	1.7	2.8	1.6
	57.2	1.5	1.4	1.8	1.5	2.1	1.6	2.2	1.6	2.3	1.7	2.6	1.7	2.8	1.6
	60.8	1.5	1.4	1.8	1.5	2.1	1.6	2.2	1.6	2.3	1.7	2.6	1.7	2.8	1.6
	64.4	1.5	1.4	1.8	1.5	2.1	1.6	2.2	1.6	2.3	1.7	2.6	1.7	2.8	1.6
	68	1.5	1.4	1.8	1.5	2.1	1.6	2.2	1.6	2.3	1.7	2.6	1.7	2.7	1.5
	69.8	1.5	1.4	1.8	1.5	2.1	1.6	2.2	1.6	2.3	1.7	2.6	1.7	2.7	1.5
	73.4	1.5	1.4	1.8	1.5	2.1	1.6	2.2	1.6	2.3	1.7	2.5	1.6	2.7	1.5
	77	1.5	1.4	1.8	1.5	2.1	1.6	2.2	1.6	2.3	1.7	2.5	1.6	2.6	1.5
	80.6	1.5	1.4	1.8	1.5	2.1	1.6	2.2	1.6	2.3	1.7	2.5	1.6	2.6	1.5
	84.2	1.5	1.4	1.8	1.5	2.1	1.6	2.2	1.6	2.3	1.7	2.4	1.5	2.5	1.5
	87.8	1.5	1.4	1.8	1.5	2.1	1.6	2.2	1.6	2.3	1.7	2.4	1.5	2.5	1.5
	91.4	1.5	1.4	1.8	1.5	2.1	1.6	2.2	1.6	2.3	1.7	2.4	1.5	2.4	1.5
	95	1.5	1.4	1.8	1.5	2.1	1.6	2.2	1.6	2.3	1.7	2.3	1.5	2.4	1.5
	98.6	1.5	1.4	1.8	1.5	2.1	1.6	2.2	1.6	2.3	1.7	2.3	1.5	2.3	1.5
	102.2	1.5	1.4	1.8	1.5	2.1	1.6	2.2	1.6	2.2	1.6	2.3	1.5	2.3	1.5
107.6	1.5	1.4	1.8	1.5	2.1	1.6	2.2	1.6	2.2	1.6	2.3	1.5	2.3	1.5	
111.2	1.5	1.4	1.8	1.5	2.1	1.6	2.2	1.6	2.2	1.6	2.3	1.5	2.3	1.5	
114.8	1.5	1.4	1.8	1.5	2.1	1.6	2.2	1.6	2.2	1.6	2.3	1.5	2.3	1.5	
2.8	50	1.9	1.7	2.3	1.9	2.6	2.1	2.8	2.1	3.0	2.1	3.3	2.2	3.7	2.2
	53.6	1.9	1.7	2.3	1.9	2.6	2.1	2.8	2.1	3.0	2.1	3.3	2.2	3.6	2.1
	57.2	1.9	1.7	2.3	1.9	2.6	2.1	2.8	2.1	3.0	2.1	3.3	2.2	3.6	2.1
	60.8	1.9	1.7	2.3	1.9	2.6	2.1	2.8	2.1	3.0	2.1	3.3	2.2	3.5	2.1
	64.4	1.9	1.7	2.3	1.9	2.6	2.1	2.8	2.1	3.0	2.1	3.3	2.2	3.5	2.1
	68	1.9	1.7	2.3	1.9	2.6	2.1	2.8	2.1	3.0	2.1	3.3	2.2	3.4	2.1
	69.8	1.9	1.7	2.3	1.9	2.6	2.1	2.8	2.1	3.0	2.1	3.3	2.2	3.4	2.1
	73.4	1.9	1.7	2.3	1.9	2.6	2.1	2.8	2.1	3.0	2.1	3.3	2.1	3.4	2.1
	77	1.9	1.7	2.3	1.9	2.6	2.1	2.8	2.1	3.0	2.1	3.2	2.1	3.3	2.0
	80.6	1.9	1.7	2.3	1.9	2.6	2.1	2.8	2.1	3.0	2.1	3.2	2.1	3.3	2.0
	84.2	1.9	1.7	2.3	1.9	2.6	2.1	2.8	2.1	3.0	2.1	3.1	2.0	3.2	1.9
	87.8	1.9	1.7	2.3	1.9	2.6	2.1	2.8	2.1	3.0	2.1	3.1	2.0	3.2	1.9
	91.4	1.9	1.7	2.3	1.9	2.6	2.1	2.8	2.1	3.0	2.1	3.1	2.0	3.1	1.9
	95	1.9	1.7	2.3	1.9	2.6	2.1	2.8	2.1	2.9	2.0	3.0	2.0	3.1	1.9
	98.6	1.9	1.7	2.3	1.9	2.6	2.1	2.8	2.1	2.9	2.0	3.0	2.0	3.0	1.8
	102.2	1.9	1.7	2.3	1.9	2.6	2.1	2.8	2.1	2.9	2.0	3.0	2.1	3.0	1.9
107.6	1.9	1.7	2.3	1.9	2.6	2.1	2.8	2.1	2.9	2.0	3.0	2.1	3.0	1.9	
111.2	1.9	1.7	2.3	1.9	2.6	2.1	2.8	2.1	2.9	2.0	3.0	2.1	3.0	1.9	
114.8	1.9	1.7	2.3	1.9	2.6	2.1	2.8	2.1	2.9	2.0	3.0	2.1	3.0	1.9	
3.6	50	2.5	2.1	2.9	2.3	3.4	2.5	3.6	2.6	3.8	2.7	4.3	2.6	4.7	2.7
	53.6	2.5	2.1	2.9	2.3	3.4	2.5	3.6	2.6	3.8	2.7	4.3	2.6	4.7	2.7
	57.2	2.5	2.1	2.9	2.3	3.4	2.5	3.6	2.6	3.8	2.7	4.3	2.6	4.6	2.6
	60.8	2.5	2.1	2.9	2.3	3.4	2.5	3.6	2.6	3.8	2.7	4.3	2.6	4.5	2.6
	64.4	2.5	2.1	2.9	2.3	3.4	2.5	3.6	2.6	3.8	2.7	4.3	2.6	4.5	2.6
	68	2.5	2.1	2.9	2.3	3.4	2.5	3.6	2.6	3.8	2.7	4.3	2.6	4.4	2.5
	69.8	2.5	2.1	2.9	2.3	3.4	2.5	3.6	2.6	3.8	2.7	4.3	2.6	4.4	2.5

Indoor Unit size (kW)	Outdoor temperature (°F DB)	Indoor temperature (°F WB/DB)													
		57.2/68		60.8/73.4		64.4/78.8		66.2/80.6		68/82.4		71.6/86		75.2/89.6	
		TC	SC	TC	SC	TC	SC	TC	SC	TC	SC	TC	SC	TC	SC
		kW	kW	kW	kW	kW	kW	kW	kW	kW	kW	kW	kW	kW	kW
3.6	73.4	2.5	2.1	2.9	2.3	3.4	2.5	3.6	2.6	3.8	2.7	4.1	2.5	4.3	2.4
	77	2.5	2.1	2.9	2.3	3.4	2.5	3.6	2.6	3.8	2.7	4.1	2.5	4.2	2.4
	80.6	2.5	2.1	2.9	2.3	3.4	2.5	3.6	2.6	3.8	2.7	4.0	2.4	4.2	2.4
	84.2	2.5	2.1	2.9	2.3	3.4	2.5	3.6	2.6	3.8	2.7	4.0	2.4	4.1	2.4
	87.8	2.5	2.1	2.9	2.3	3.4	2.5	3.6	2.6	3.8	2.7	4.2	2.8	4.1	2.4
	91.4	2.5	2.1	2.9	2.3	3.4	2.5	3.6	2.6	3.8	2.7	4.2	2.8	3.9	2.3
	95	2.5	2.1	2.9	2.3	3.4	2.5	3.6	2.6	3.8	2.7	4.2	2.8	3.9	2.3
	98.6	2.5	2.1	2.9	2.3	3.4	2.5	3.6	2.6	3.7	2.6	3.8	2.5	3.9	2.3
	102.2	2.5	2.1	2.9	2.3	3.4	2.5	3.6	2.6	3.7	2.6	3.8	2.5	3.8	2.3
	107.6	2.5	2.1	2.9	2.3	3.4	2.5	3.6	2.6	3.7	2.6	3.8	2.5	3.8	2.3
	111.2	2.5	2.1	2.9	2.3	3.4	2.5	3.6	2.6	3.7	2.6	3.8	2.5	3.8	2.3
114.8	2.5	2.1	2.9	2.3	3.4	2.5	3.6	2.6	3.7	2.6	3.8	2.5	3.8	2.3	
4.5	50	3.1	2.6	3.7	2.8	4.2	3.1	4.5	3.2	4.8	3.2	5.3	3.7	5.9	3.3
	53.6	3.1	2.6	3.7	2.8	4.2	3.1	4.5	3.2	4.8	3.2	5.3	3.7	5.9	3.3
	57.2	3.1	2.6	3.7	2.8	4.2	3.1	4.5	3.2	4.8	3.2	5.3	3.7	5.8	3.3
	60.8	3.1	2.6	3.7	2.8	4.2	3.1	4.5	3.2	4.8	3.2	5.3	3.7	5.6	3.2
	64.4	3.1	2.6	3.7	2.8	4.2	3.1	4.5	3.2	4.8	3.2	5.3	3.7	5.7	3.3
	68	3.1	2.6	3.7	2.8	4.2	3.1	4.5	3.2	4.8	3.2	5.3	3.7	5.7	3.3
	69.8	3.1	2.6	3.7	2.8	4.2	3.1	4.5	3.2	4.8	3.2	5.3	3.7	5.6	3.3
	73.4	3.1	2.6	3.7	2.8	4.2	3.1	4.5	3.2	4.8	3.2	5.3	3.7	5.5	3.2
	77	3.1	2.6	3.7	2.8	4.2	3.1	4.5	3.2	4.8	3.2	5.2	3.3	5.4	3.2
	80.6	3.1	2.6	3.7	2.8	4.2	3.1	4.5	3.2	4.8	3.2	5.1	3.2	5.2	3.0
	84.2	3.1	2.6	3.7	2.8	4.2	3.1	4.5	3.2	4.8	3.2	5.1	3.2	5.2	3.0
	87.8	3.1	2.6	3.7	2.8	4.2	3.1	4.5	3.2	4.8	3.2	5.0	3.1	5.1	2.9
	91.4	3.1	2.6	3.7	2.8	4.2	3.1	4.5	3.2	4.8	3.2	4.9	3.1	5.1	2.9
	95	3.1	2.6	3.7	2.8	4.2	3.1	4.5	3.2	4.8	3.2	4.8	3.0	5.0	2.9
	98.6	3.1	2.6	3.7	2.8	4.2	3.1	4.5	3.2	4.8	3.2	4.8	3.1	4.9	2.8
102.2	3.1	2.6	3.7	2.8	4.2	3.1	4.5	3.2	4.6	3.1	4.7	3.1	4.8	2.8	
107.6	3.1	2.6	3.7	2.8	4.2	3.1	4.5	3.2	4.6	3.1	4.7	3.1	4.8	2.8	
111.2	3.1	2.6	3.7	2.8	4.2	3.1	4.5	3.2	4.6	3.1	4.7	3.1	4.8	2.8	
114.8	3.1	2.6	3.7	2.8	4.2	3.1	4.5	3.2	4.6	3.1	4.7	3.1	4.8	2.8	
5.6	50	3.9	3.0	4.6	3.3	5.3	3.6	5.6	3.7	5.9	3.8	6.6	3.9	7.3	3.9
	53.6	3.9	3.0	4.6	3.3	5.3	3.6	5.6	3.7	5.9	3.8	6.6	3.9	7.2	3.8
	57.2	3.9	3.0	4.6	3.3	5.3	3.6	5.6	3.7	5.9	3.8	6.6	3.9	7.1	3.8
	60.8	3.9	3.0	4.6	3.3	5.3	3.6	5.6	3.7	5.9	3.8	6.6	3.9	7.0	3.7
	64.4	3.9	3.0	4.6	3.3	5.3	3.6	5.6	3.7	5.9	3.8	6.6	3.9	6.8	3.7
	68	3.9	3.0	4.6	3.3	5.3	3.6	5.6	3.7	5.9	3.8	6.6	3.9	6.7	3.6
	69.8	3.9	3.0	4.6	3.3	5.3	3.6	5.6	3.7	5.9	3.8	6.6	3.9	6.6	3.6
	73.4	3.9	3.0	4.6	3.3	5.3	3.6	5.6	3.7	5.9	3.8	6.6	3.9	6.6	3.5
	77	3.9	3.0	4.6	3.3	5.3	3.6	5.6	3.7	5.9	3.8	6.6	3.9	6.5	3.5
	80.6	3.9	3.0	4.6	3.3	5.3	3.6	5.6	3.7	5.9	3.8	6.4	3.8	6.4	3.5
	84.2	3.9	3.0	4.6	3.3	5.3	3.6	5.6	3.7	5.9	3.8	6.3	3.8	6.4	3.6
	87.8	3.9	3.0	4.6	3.3	5.3	3.6	5.6	3.7	5.9	3.8	6.2	3.7	6.2	3.4
	91.4	3.9	3.0	4.6	3.3	5.3	3.6	5.6	3.7	5.9	3.8	6.2	3.7	6.2	3.4
	95	3.9	3.0	4.6	3.3	5.3	3.6	5.6	3.7	5.9	3.8	6.0	3.6	6.0	3.4
	98.6	3.9	3.0	4.6	3.3	5.3	3.6	5.6	3.7	5.9	3.8	5.9	3.5	6.0	3.4
102.2	3.9	3.0	4.6	3.3	5.3	3.6	5.6	3.7	5.7	3.7	5.8	3.5	6.0	3.4	
107.6	3.9	3.0	4.6	3.3	5.3	3.6	5.6	3.7	5.7	3.7	5.8	3.5	6.0	3.4	

Indoor Unit size (kW)	Outdoor temperature (°F DB)	Indoor temperature (°F WB/DB)													
		57.2/68		60.8/73.4		64.4/78.8		66.2/80.6		68/82.4		71.6/86		75.2/89.6	
		TC	SC	TC	SC	TC	SC	TC	SC	TC	SC	TC	SC	TC	SC
		kW	kW	kW	kW	kW	kW	kW	kW	kW	kW	kW	kW	kW	kW
5.6	111.2	3.9	3.0	4.6	3.3	5.3	3.6	5.6	3.7	5.7	3.7	5.8	3.5	6.0	3.4
	114.8	3.9	3.0	4.6	3.3	5.3	3.6	5.6	3.7	5.7	3.7	5.8	3.5	6.0	3.4
7.1	50	4.9	3.9	5.8	4.3	6.7	4.7	7.1	4.9	7.5	4.8	8.4	4.9	9.2	5.0
	53.6	4.9	3.9	5.8	4.3	6.7	4.7	7.1	4.9	7.5	4.8	8.4	4.9	9.1	4.9
	57.2	4.9	3.9	5.8	4.3	6.7	4.7	7.1	4.9	7.5	4.8	8.4	4.9	9.0	4.9
	60.8	4.9	3.9	5.8	4.3	6.7	4.7	7.1	4.9	7.5	4.8	8.4	4.9	8.9	4.8
	64.4	4.9	3.9	5.8	4.3	6.7	4.7	7.1	4.9	7.5	4.8	8.4	4.9	8.7	4.7
	68	4.9	3.9	5.8	4.3	6.7	4.7	7.1	4.9	7.5	4.8	8.4	4.9	8.5	4.6
	69.8	4.9	3.9	5.8	4.3	6.7	4.7	7.1	4.9	7.5	4.8	8.4	4.9	8.4	4.5
	73.4	4.9	3.9	5.8	4.3	6.7	4.7	7.1	4.9	7.5	4.8	8.4	4.9	8.3	4.5
	77	4.9	3.9	5.8	4.3	6.7	4.7	7.1	4.9	7.5	4.8	8.4	4.9	8.2	4.4
	80.6	4.9	3.9	5.8	4.3	6.7	4.7	7.1	4.9	7.5	4.8	8.1	4.7	8.2	4.5
	84.2	4.9	3.9	5.8	4.3	6.7	4.7	7.1	4.9	7.5	4.8	8.0	4.7	8.1	4.5
	87.8	4.9	3.9	5.8	4.3	6.7	4.7	7.1	4.9	7.5	4.8	7.9	4.6	7.8	4.3
	91.4	4.9	3.9	5.8	4.3	6.7	4.7	7.1	4.9	7.5	4.8	7.8	4.6	7.8	4.3
	95	4.9	3.9	5.8	4.3	6.7	4.7	7.1	4.9	7.5	4.8	7.6	4.5	7.7	4.2
	98.6	4.9	3.9	5.8	4.3	6.7	4.7	7.1	4.9	7.4	4.8	7.5	4.5	7.6	4.3
	102.2	4.9	3.9	5.8	4.3	6.7	4.7	7.1	4.9	7.2	4.7	7.4	4.4	7.6	4.3
	107.6	4.9	3.9	5.8	4.3	6.7	4.7	7.1	4.9	7.2	4.7	7.4	4.4	7.6	4.3
111.2	4.9	3.9	5.8	4.3	6.7	4.7	7.1	4.9	7.2	4.7	7.4	4.4	7.6	4.3	
114.8	4.9	3.9	5.8	4.3	6.7	4.7	7.1	4.9	7.2	4.7	7.4	4.4	7.6	4.3	

8.2 Heating

TC: total capacity **WB:** wet-bulb temperature **DB:** dry-bulb temperature

Indoor Unit size (kW)	Outdoor temperature (°F)		Indoor temperature (°F DB)					
			60.8	64.4	68	69.8	71.6	75.2
	WB	DB	TC kW	TC kW	TC kW	TC kW	TC kW	TC kW
2.2	-3.64	-4	1.46	1.46	1.46	1.46	1.46	1.46
	-1.84	-2.2	1.56	1.56	1.56	1.56	1.56	1.56
	1.94	1.4	1.64	1.64	1.64	1.64	1.64	1.64
	7.34	5	1.69	1.69	1.69	1.69	1.69	1.69
	10.76	8.6	1.79	1.79	1.79	1.79	1.79	1.79
	14.36	12.2	1.82	1.85	1.85	1.85	1.85	1.85
	14.9	14	1.90	1.90	1.90	1.90	1.90	1.90
	16.7	15.62	1.95	1.95	1.95	1.95	1.95	1.95
	19.4	18.32	1.98	1.98	1.98	1.98	1.98	1.98
	23	21.92	2.05	2.05	2.05	2.05	2.05	2.05
	26.6	25.34	2.16	2.16	2.16	2.16	2.16	2.16
	32	30.74	2.31	2.31	2.31	2.31	2.31	2.18
	37.4	35.96	2.44	2.44	2.44	2.44	2.39	2.18
	41	39.38	2.52	2.52	2.52	2.52	2.39	2.18
	44.6	42.8	2.60	2.60	2.60	2.52	2.39	2.18
	48.2	46.22	2.68	2.68	2.60	2.52	2.39	2.18
	51.8	49.64	2.76	2.76	2.60	2.52	2.39	2.18
	55.4	53.24	2.86	2.81	2.60	2.52	2.39	2.18
59	56.66	2.94	2.81	2.60	2.52	2.39	2.18	
2.8	-3.64	-4	1.79	1.79	1.79	1.79	1.79	1.79
	-1.84	-2.2	1.92	1.92	1.92	1.92	1.92	1.92
	1.94	1.4	2.02	2.02	2.02	2.02	2.02	2.02
	7.34	5	2.02	2.02	2.02	2.02	2.02	2.02
	10.76	8.6	2.14	2.14	2.14	2.14	2.14	2.14
	14.36	12.2	2.24	2.24	2.24	2.24	2.24	2.24
	14.9	14	2.34	2.34	2.34	2.34	2.34	2.34
	16.7	15.62	2.40	2.40	2.40	2.40	2.40	2.40
	19.4	18.32	2.43	2.43	2.43	2.43	2.43	2.43
	23	21.92	2.53	2.53	2.53	2.53	2.53	2.53
	26.6	25.34	2.66	2.66	2.66	2.66	2.66	2.66
	32	30.74	2.85	2.85	2.85	2.85	2.85	2.69
	37.4	35.96	3.01	3.01	3.01	3.01	2.94	2.69
	41	39.38	3.10	3.10	3.10	3.10	2.94	2.69
	44.6	42.8	3.20	3.20	3.20	3.10	2.94	2.69
	48.2	46.22	3.30	3.30	3.20	3.10	2.94	2.69
	51.8	49.64	3.39	3.39	3.20	3.10	2.94	2.69
	55.4	53.24	3.52	3.46	3.20	3.10	2.94	2.69
59	56.66	3.62	3.46	3.20	3.10	2.94	2.69	
3.6	-3.64	-4	2.24	2.24	2.24	2.24	2.24	2.24
	-1.84	-2.2	2.40	2.40	2.40	2.40	2.40	2.40
	1.94	1.4	2.52	2.52	2.52	2.52	2.52	2.52
	7.34	5	2.60	2.60	2.60	2.60	2.60	2.60
	10.76	8.6	2.68	2.68	2.68	2.68	2.68	2.68
	14.36	12.2	2.80	2.80	2.80	2.80	2.80	2.80
	14.9	14	2.92	2.92	2.92	2.92	2.92	2.92
	16.7	15.62	3.00	3.00	3.00	3.00	3.00	3.00
	19.4	18.32	3.04	3.04	3.04	3.04	3.04	3.04
	23	21.92	3.16	3.16	3.16	3.16	3.16	3.16
	26.6	25.34	3.32	3.32	3.32	3.32	3.32	3.32
	32	30.74	3.56	3.56	3.56	3.56	3.56	3.36
	37.4	35.96	3.76	3.76	3.76	3.76	3.68	3.36
	41	39.38	3.88	3.88	3.88	3.88	3.68	3.36
	44.6	42.8	4.00	4.00	4.00	3.88	3.68	3.36
	48.2	46.22	4.12	4.12	4.00	3.88	3.68	3.36
	51.8	49.64	4.24	4.24	4.00	3.88	3.68	3.36
	55.4	53.24	4.40	4.32	4.00	3.88	3.68	3.36
59	56.66	4.52	4.32	4.00	3.88	3.68	3.36	
4.5	-3.64	-4	2.52	2.52	2.52	2.52	2.52	2.52
	-1.84	-2.2	2.70	2.70	2.70	2.70	2.70	2.70
	1.94	1.4	2.84	2.84	2.84	2.84	2.84	2.84

Indoor Unit size (kW)	Outdoor temperature (°F)		Indoor temperature (°F DB)						
			60.8	64.4	68	69.8	71.6	75.2	
	WB	DB	TC	TC	TC	TC	TC	TC	
4.5	7.34	5	2.93	2.93	2.93	2.93	2.93	2.93	2.93
	10.76	8.6	3.11	3.11	3.11	3.11	3.11	3.11	3.11
	14.36	12.2	3.15	3.20	3.20	3.20	3.20	3.20	3.20
	14.9	14	3.29	3.29	3.29	3.29	3.29	3.29	3.29
	16.7	15.62	3.38	3.38	3.38	3.38	3.38	3.38	3.38
	19.4	18.32	3.42	3.42	3.42	3.42	3.42	3.42	3.42
	23	21.92	3.56	3.56	3.56	3.56	3.56	3.56	3.56
	26.6	25.34	3.74	3.74	3.74	3.74	3.74	3.74	3.74
	32	30.74	4.01	4.01	4.01	4.01	4.01	4.01	3.78
	37.4	35.96	4.23	4.23	4.23	4.23	4.14	3.78	3.78
	41	39.38	4.37	4.37	4.37	4.37	4.14	3.78	3.78
	44.6	42.8	4.50	4.50	4.50	4.37	4.14	3.78	3.78
	48.2	46.22	4.64	4.64	4.50	4.37	4.14	3.78	3.78
	51.8	49.64	4.77	4.77	4.50	4.37	4.14	3.78	3.78
	55.4	53.24	4.95	4.86	4.50	4.37	4.14	3.78	3.78
59	56.66	5.09	4.86	4.50	4.37	4.14	3.78	3.78	
5.6	-3.64	-4	3.14	3.14	3.14	3.14	3.14	3.14	3.14
	-1.84	-2.2	3.36	3.36	3.36	3.36	3.36	3.36	3.36
	1.94	1.4	3.53	3.53	3.53	3.53	3.53	3.53	3.53
	7.34	5	3.64	3.64	3.64	3.64	3.64	3.64	3.64
	10.76	8.6	3.86	3.86	3.86	3.86	3.86	3.86	3.86
	14.36	12.2	3.92	3.98	3.98	3.98	3.98	3.98	3.98
	14.9	14	4.09	4.09	4.09	4.09	4.09	4.09	4.09
	16.7	15.62	4.20	4.20	4.20	4.20	4.20	4.20	4.20
	19.4	18.32	4.26	4.26	4.26	4.26	4.26	4.26	4.26
	23	21.92	4.42	4.42	4.42	4.42	4.42	4.42	4.42
	26.6	25.34	4.65	4.65	4.65	4.65	4.65	4.65	4.65
	32	30.74	4.98	4.98	4.98	4.98	4.98	4.70	4.70
	37.4	35.96	5.26	5.26	5.26	5.26	5.15	4.70	4.70
	41	39.38	5.43	5.43	5.43	5.43	5.15	4.70	4.70
	44.6	42.8	5.60	5.60	5.60	5.43	5.15	4.70	4.70
48.2	46.22	5.77	5.77	5.60	5.43	5.15	4.70	4.70	
51.8	49.64	5.94	5.94	5.60	5.43	5.15	4.70	4.70	
55.4	53.24	6.16	6.05	5.60	5.43	5.15	4.70	4.70	
59	56.66	6.33	6.05	5.60	5.43	5.15	4.70	4.70	
7.1	-3.64	-4	4.48	4.48	4.48	4.48	4.48	4.48	4.48
	-1.84	-2.2	4.80	4.80	4.80	4.80	4.80	4.80	4.80
	1.94	1.4	5.04	5.04	5.04	5.04	5.04	5.04	5.04
	7.34	5	5.20	5.20	5.20	5.2	5.20	5.20	5.20
	10.76	8.6	5.36	5.36	5.36	5.36	5.36	5.36	5.36
	14.36	12.2	5.60	5.60	5.60	5.60	5.60	5.60	5.60
	14.9	14	5.84	5.84	5.84	5.84	5.84	5.84	5.84
	16.7	15.62	6.00	6.00	6.00	6.00	6.00	6.00	6.00
	19.4	18.32	6.08	6.08	6.08	6.08	6.08	6.08	6.08
	23	21.92	6.32	6.32	6.32	6.32	6.32	6.32	6.32
	26.6	25.34	6.64	6.64	6.64	6.64	6.64	6.64	6.64
	32	30.74	7.12	7.12	7.12	7.12	7.12	6.72	6.72
	37.4	35.96	7.52	7.52	7.52	7.52	7.36	6.72	6.72
	41	39.38	7.76	7.76	7.76	7.76	7.36	6.72	6.72
	44.6	42.8	8.00	8.00	8.00	7.76	7.36	6.72	6.72
48.2	46.22	8.24	8.24	8.00	7.76	7.36	6.72	6.72	
51.8	49.64	8.48	8.48	8.00	7.76	7.36	6.72	6.72	
55.4	53.24	8.80	8.64	8.00	7.76	7.36	6.72	6.72	
59	56.66	9.04	8.64	8.00	7.76	7.36	6.72	6.72	

9. Electrical Characteristics

Model	Indoor Unit				Power Supply		IFM	
	Hz	Voltage	Min.	Max.	MCA	MFA	KW	FLA
MDV-D22T2/VN1-DA5	60	208-230	187	253	0.325	15	0.059	0.26
MDV-D28T2/VN1-DA5	60	208-230	187	253	0.325	15	0.059	0.26
MDV-D36T2/VN1-DA5	60	208-230	187	253	0.375	15	0.064	0.3
MDV-D45T2/VN1-DA5	60	208-230	187	253	0.575	15	0.047	0.46
MDV-D56T2/VN1-DA5	60	208-230	187	253	0.575	15	0.047	0.46
MDV-D71T2/VN1-DA5	60	208-230	187	253	0.7	15	0.065	0.56

Remark:

MCA: Min. Current Amps. (A)

MFA: Max. Fuse Amps. (A)

KW: Fan Motor Rated Output (kW)

FLA: Full Load Amps. (A)

IFM: Indoor Fan Motor



10.Sound Levels

10.1 Test condition

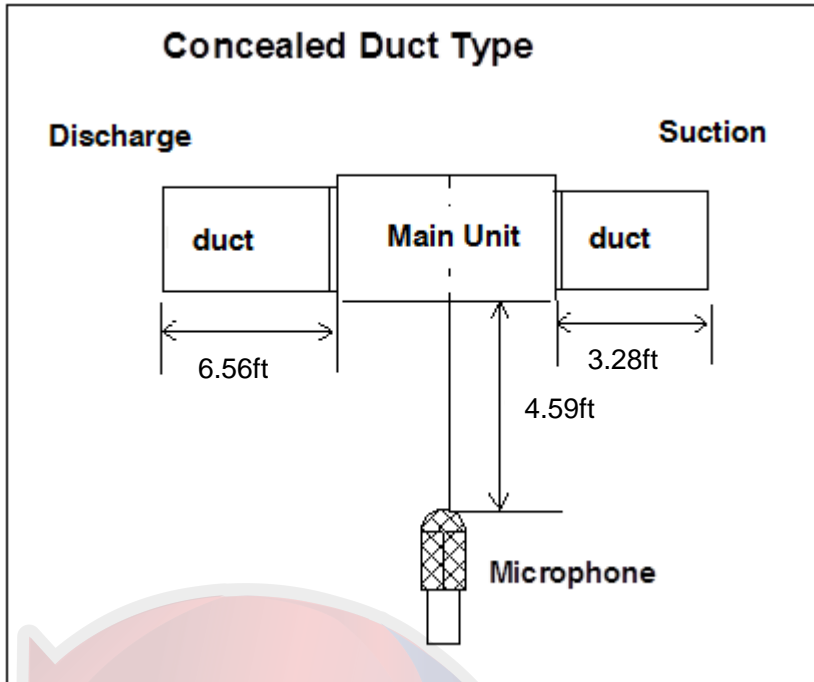

10.2 Test value

Model	Sound value dB(A)		
	H	M	L
MDV-D22T2/VN1-DA5	36	35	32
MDV-D28T2/VN1-DA5	36	35	32
MDV-D36T2/VN1-DA5	38.6	37.5	33.8
MDV-D45T2/VN1-DA5	39	37.9	34
MDV-D56T2/VN1-DA5	39	37.9	34
MDV-D71T2/VN1-DA5	41.4	39	35

MDV-D22T2/VN1-DA5

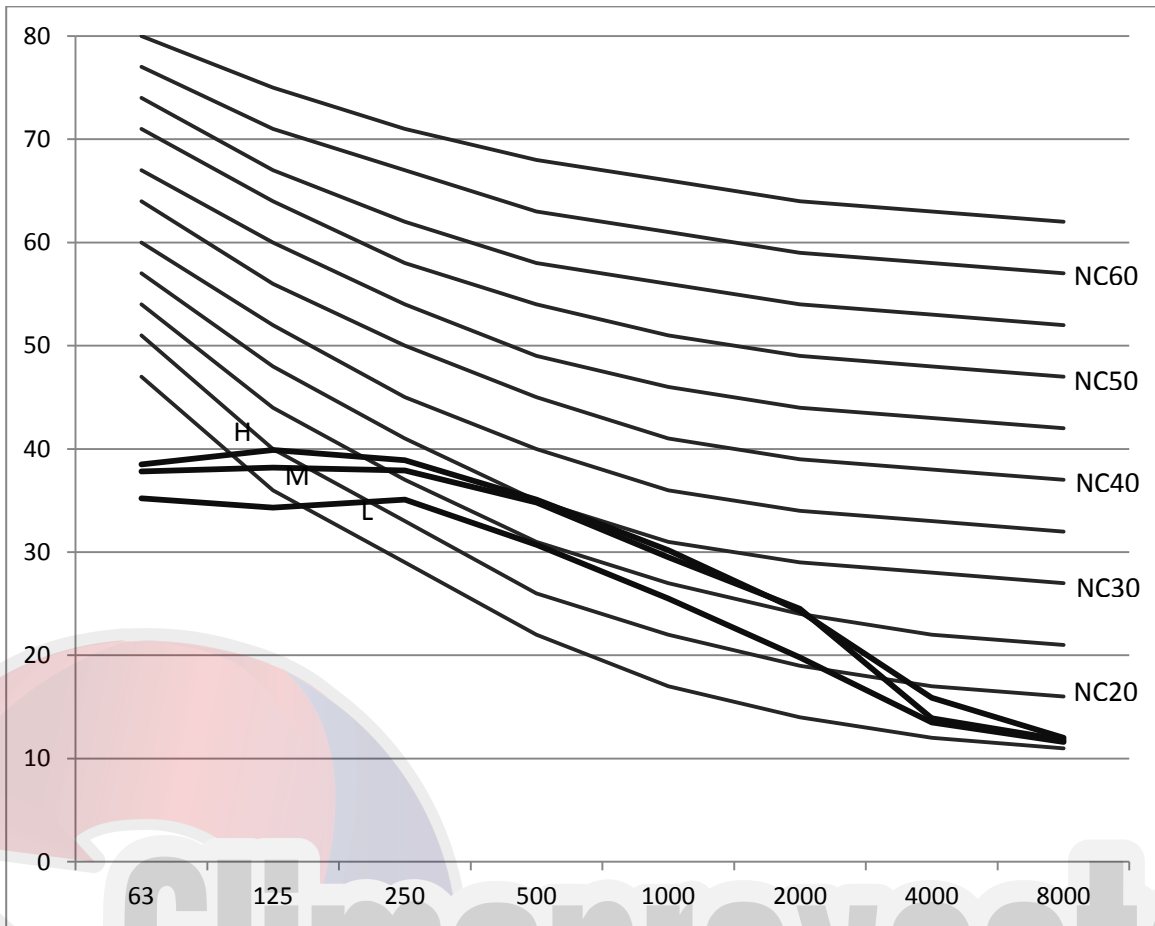

MDV-D28T2/VN1-DA5

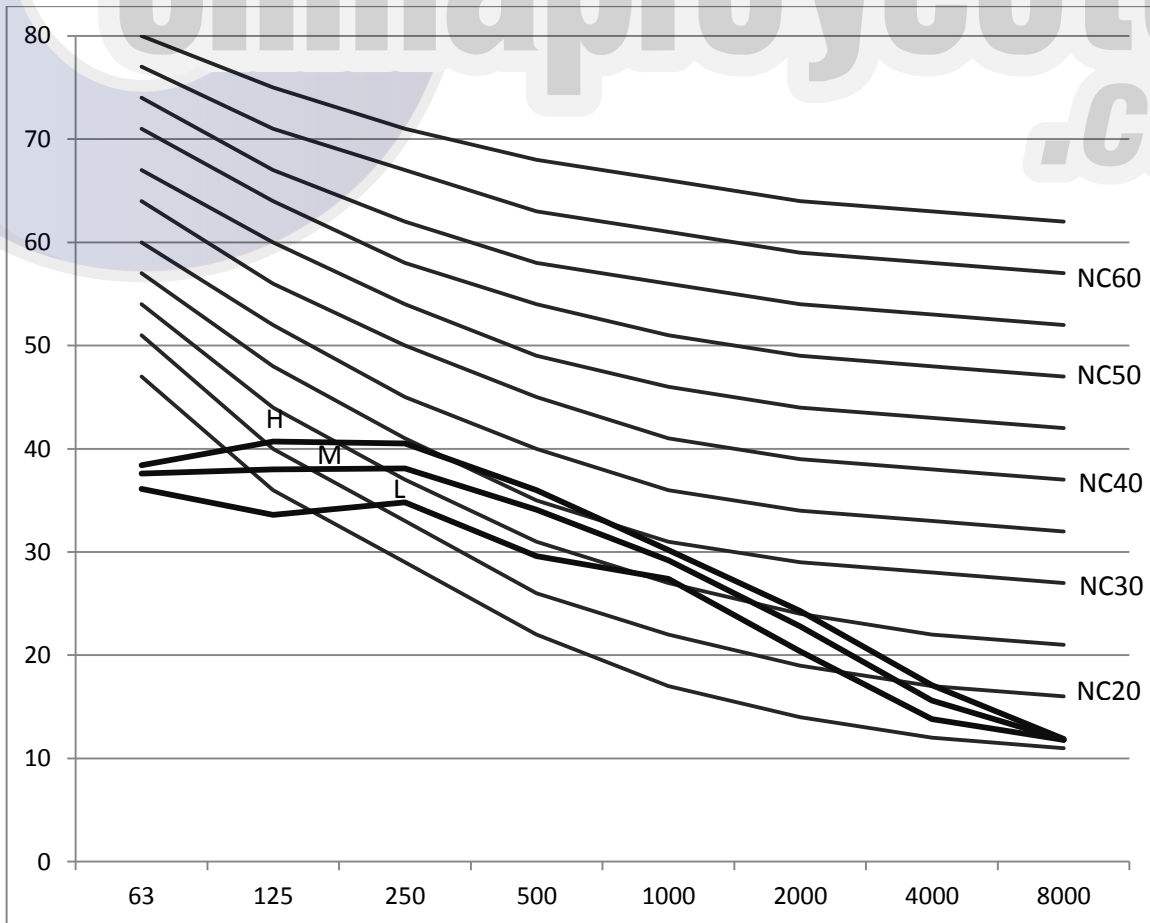

MDV-D36T2/VN1-DA5, MDV-D45T2/VN1-DA5, MDV-D45T2/VN1-DA5

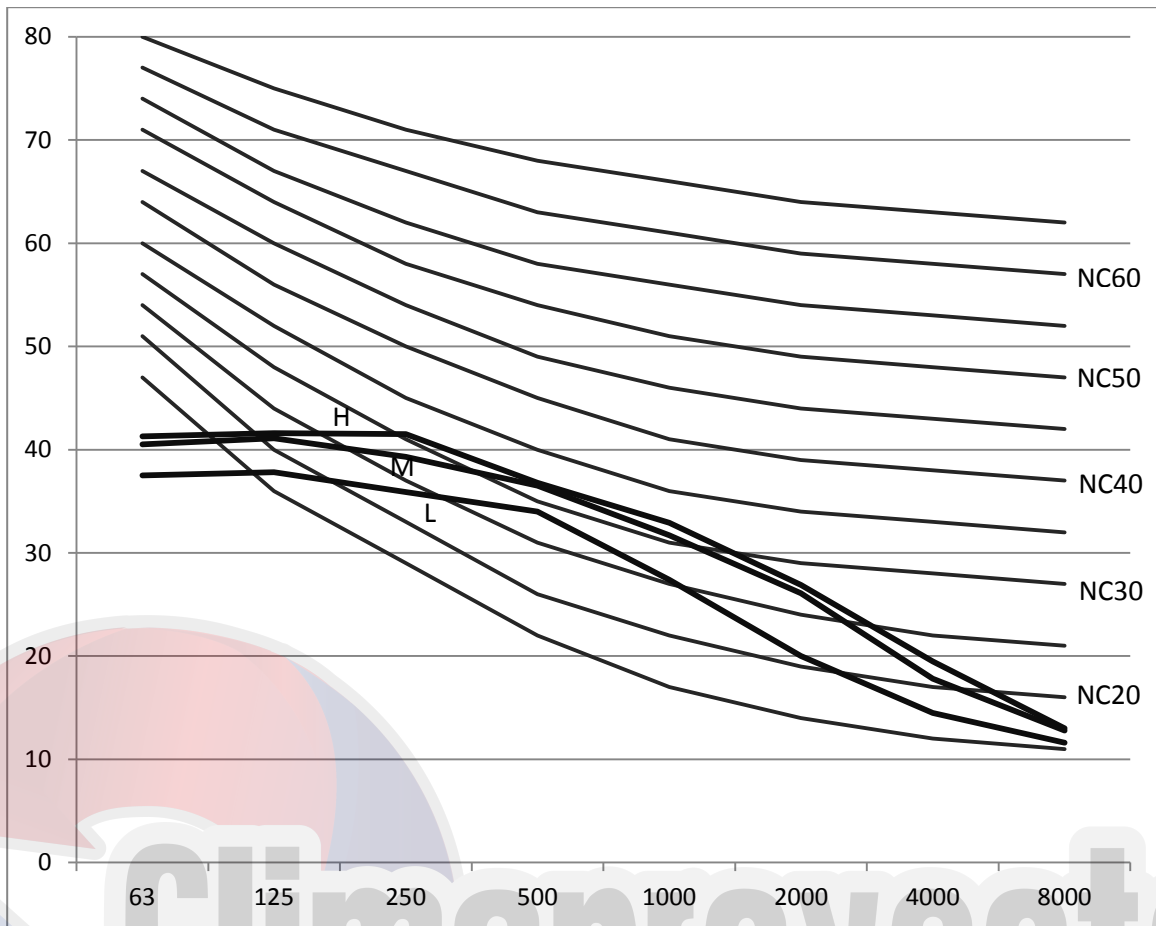



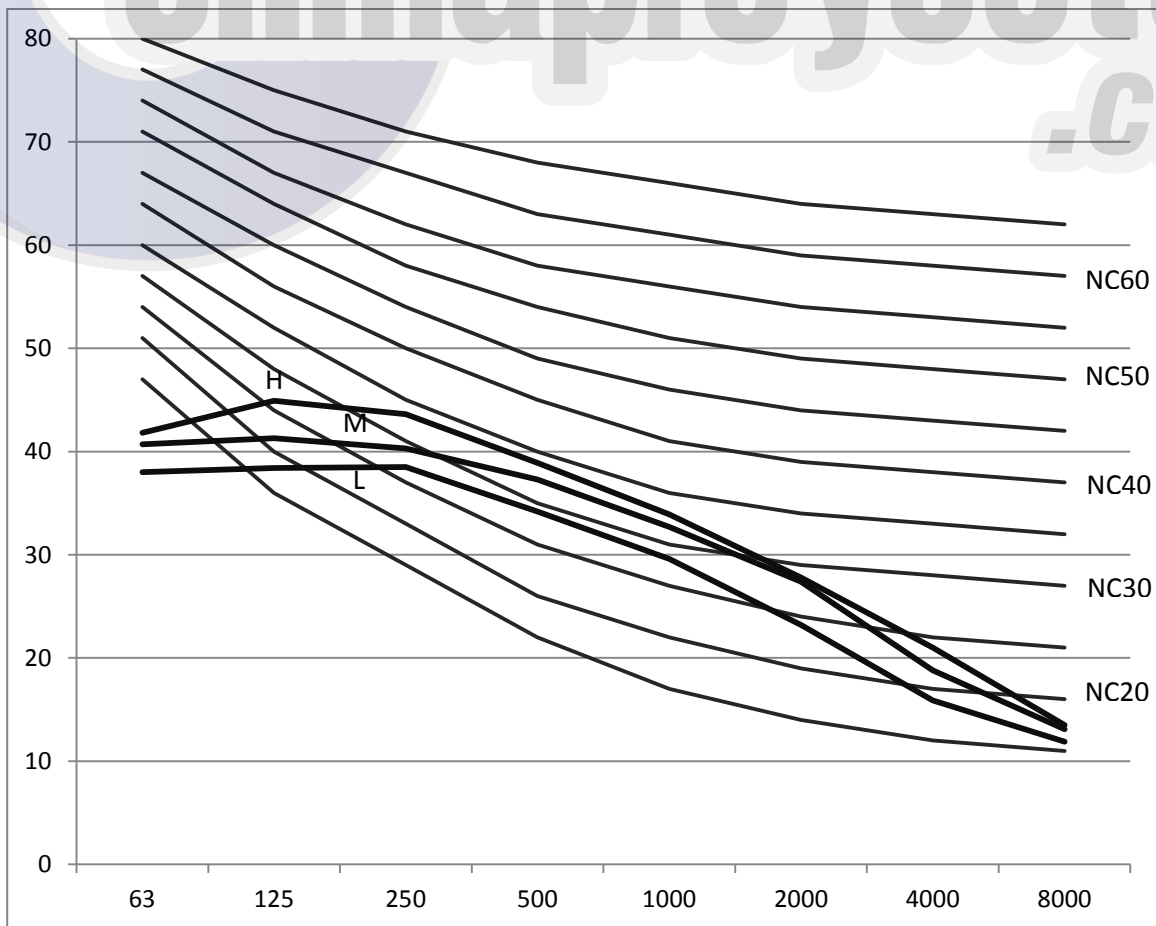



MDV-D71T2/VN1-DA5

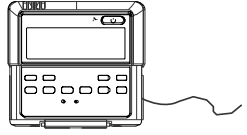

11. Accessories

11.1 Standard accessories

For models: MDV-D22T2/VN1-DA5, MDV-D28T2/VN1-DA5, MDV-D36T2/VN1-DA5, MDV-D45T2/VN1-DA5, MDV-D56T2/VN1-DA5, MDV-D71T2/VN1-DA5

Name	Quantity	Shape	Usage
Installation manual	1	/	/
Pipe insulation material	2		Heat insulation
Adhesive tape for seal	2		To connect drain pipe
Wired controller	1		/
Network matching wire	1		The indoor unit which at the terminal of communication system should connect a impedance between port P and port Q
Water outlet joint	1		For drainage
Clasp	1		Chucking the joint which connect the drain hose and the outlet of indoor unit
Signal receiver display board (already fixed inside control box)	1		Receive signal

Climaproyectos
.com

Concealed Duct Unit (A5 Type)

1. Feature	48
2. Specifications	50
3. Dimensions	53
4. Service Spaces.....	55
5. Piping Diagrams	56
6. Wiring Diagram	57
7. Fan Performance	59
8. Capacity Tables.....	61
9. Electrical Characteristics	69
10. Sound Levels	70
11. Accessories.....	72

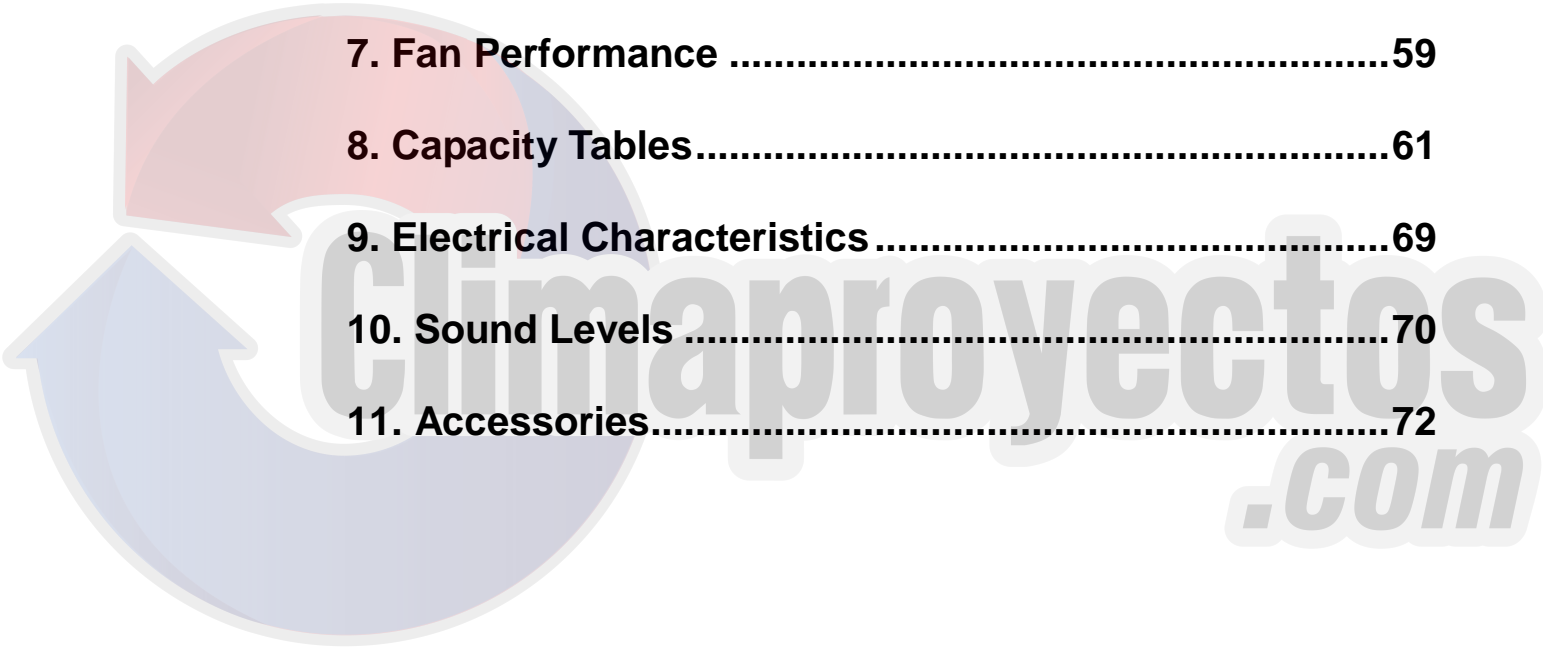

1. Feature

1.1 Compact size



1.1.1 Only 210 mm (22~71 models) or 270mm (80 to 112 model) or 300mm (140 model)in height, this model can be installed in rooms with as little as 9-7/16in.~11-13/16in.(240mm~300mm) depth between the drop-ceiling and ceiling slab.

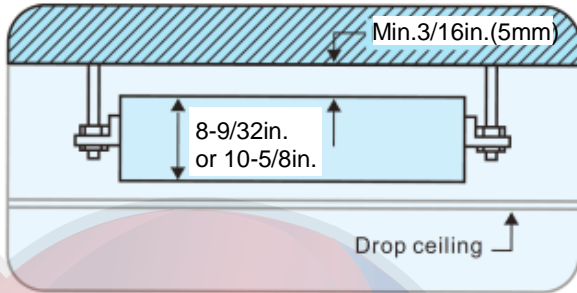

1.1.2 **The EXV is built-in** design of the indoor unit, makes the main body without an extra throttle kit box.

1.2 Wide capacity range

—The capacity ranges from 7500Btu/h~47800Btu/h(2.2kW to 14.0kW), totally ten models.

1.3 Four speed fan motor (Super High ‘SH’ speed as an option)

1.4 Two external static pressure settings for added flexibility

Just exchange the wiring connection of ‘SH’ and ‘H’. P2 and P3 as the right side diagram.

1.5 Convenient installation

1.5.1 The EXV is fixed inside the indoor unit.

1.5.2 Standard filter with aluminum frame, which is removable downward from the bottom.

1.5.3 Suction chamber is included as standard equipment.

1.5.4 Flange for air in/outlet duct connection is standard.

1.5.5 Air inlet from back standard and from bottom optional

Size of the plate from bottom and flange from back is the same, which makes it possible to convert the air return from back to bottom easily by installer.

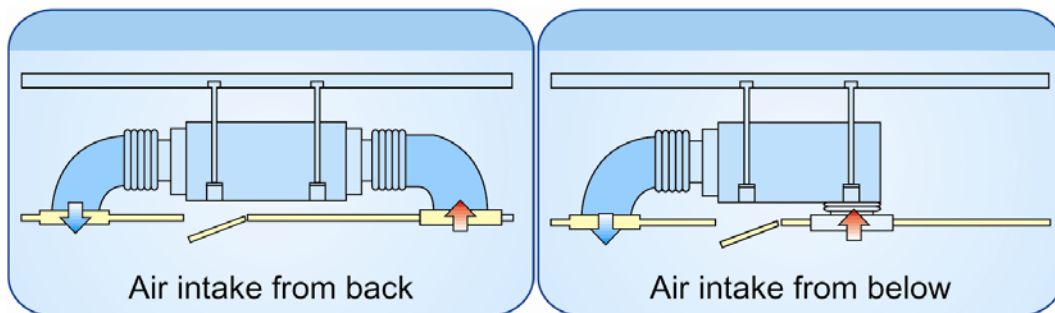
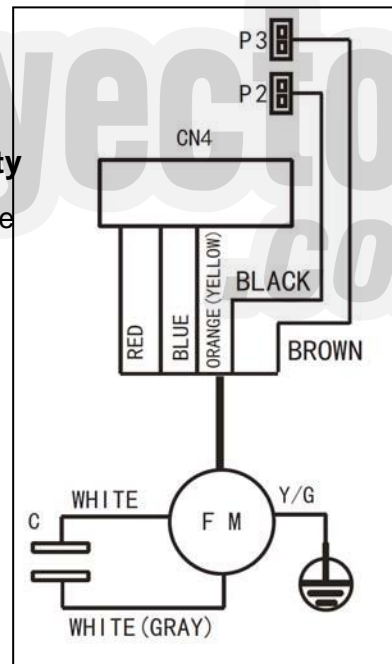

1.5.6 Standard built-in drain pump

Drain pump is equipped as standard accessory with 29-17/32in (750mm) pump head.

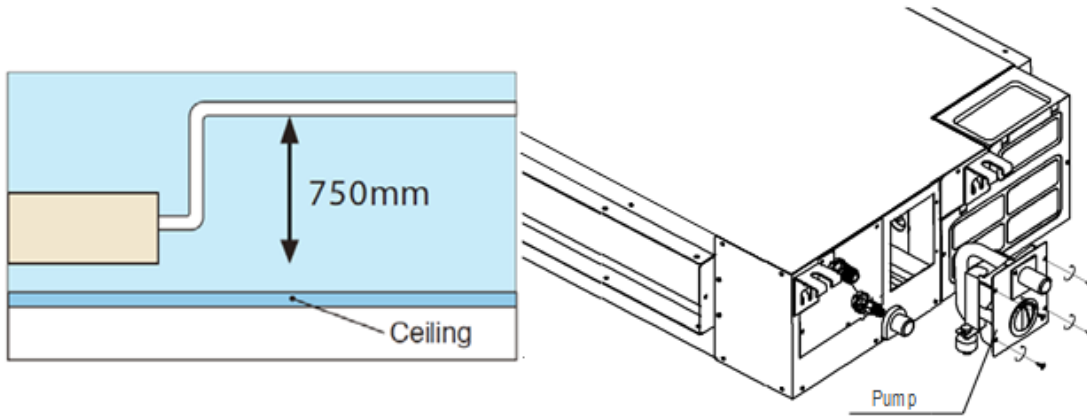

1.6 Flexible control and convenient for maintenance

1.6.1 Standard wired remote controller KJR-29B1/BK-E, and wireless remote controller RM05/BG(T)E-A is optional.

1.6.2 The display board is connected with the E-box in factory, which makes trouble-shooting easier by LED display.

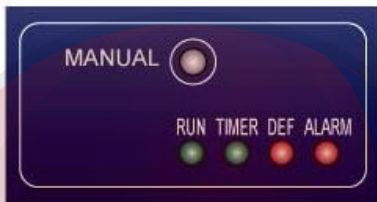

22~56 model (Standard)

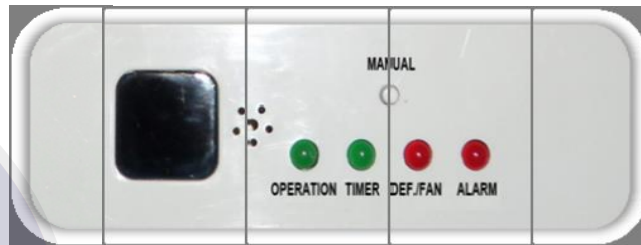

22~56 model (Optional)



71~140 model

1.6.3 The electrical control box is possible to remove 1m far away from the main unit, which is suitable for the small space hard to maintain. (It should be required by client in advance and done by Midea CAC in factory)

1.6.4 The EXV is fixed inside of the indoor unit, which is welded connection.

1.6.5 Standard functional port such as Remote On/Off Dry contact switch, and Alarm signal output (220V).

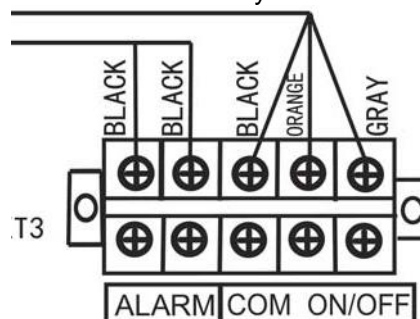

2. Specifications

Model			MDV-D22T2/VN1-BA5	MDV-D28T2/VN1-BA5	MDV-D36T2/VN1-BA5
Power supply		V- Ph-Hz	208-230V~, 1Ph,		
Cooling	Capacity	kW	2.2	2.8	3.6
		Btu/h	7500	9600	12300
	Input	W	66	72	77
	Rated current	A	0.28	0.28	0.28
Heating	Capacity	kW	2.6	3.2	4.0
		Btu/h	8900	10900	13600
	Input	W	66	72	77
	Rated current	A	0.28	0.28	0.28
Indoor fan motor	Model		YSK27-4G	YSK27-4G	YSK27-4G
	Type		AC Motor		
	Brand		Yongan/Welling		
	Input	W	47.1	47.1	60
	Capacitor	μF	1.5μF/450V	1.5μF/450V	2μF/450V
	Speed (SH/H/M/L)	r/min	1150/1040/960/850	1150/1040/960/850	1235/1100/980/870
	Number of rows		2	2	3
Indoor coil	Tube pitch(a) x row	in.(mm)	13/16x17/32(21x13.37)		
	Pitch(b)				
	Fin spacing	in.(mm)	1/16(1.5)	1/16(1.5)	1/16(1.5)
	Fin type		Hydrophilic aluminum		
	Tube outside diameter and type	in.(mm)	9/32(Φ7) Inner groove tube		
	Length x height xwidth	in.(mm)	20-9/32x1-3/64x9-59/64(515x26.74x252)	28-15/16x1-37/64x9-59/64(735x40.1x252)	
	Number of circuits		3	3	3
Indoor air flow (SH/H/M/L)	m3/h	522(30pa)/528/417/322			
	CFM	307/311/245/190			
Indoor external static pressure		Pa	10(10~30)		
Indoor noise level (H/M/L)		dB(A)	38/35/32	38/35/32	40/38/36
Indoor unit	Dimension (WxHxD)	in.(mm)	29-9/64x8-9/32x25(740x210x635)		
	Packing (WxHxD)	in.(mm)	36-1/32x11-13/32x25-25/32(915x290x655)		
	Net/Gross weight	lbs.(kg)	47.4/58.5(21.5/26.5)	47.4/58.5(21.5/26.5)	48.5/59.5(22/27)
Fresh Air intake hole diameter		in.(mm)	3-5/8(Φ92)	3-5/8(Φ92)	3-5/8(Φ92)
Refrigerant type			R410A		
Throttle	Type		Electronic expansion valve		
	Model		BD20FKS(L)		
Design pressure		MPa	4.4/2.6		
Refrigerant	Liquid / Gas	in.(mm)	1/4(Φ6.35)/1/2(Φ12.7)		
Connecting wiring	Power wiring	mm2	3x2.5(L≤20m); 3x3.5(L≤50m)		
	Signal wiring	mm2	3x0.75		
Drainage water pipe diameter		in.(mm)	OD 63/64(Φ25)		
Controller			Wired controller KJR-29B1/BK-E (6 meters connection wire)		

Notes: 1. Nominal cooling capacities are based on the following conditions: return air temperature : 80.6°F (27°C)DB / 66.2°F(19°C)WB, outdoor temperature:95°F (35°C)DB, equivalent piping: 26.25ft(8m)(horizontal).

2. Nominal heating capacities are based on the following conditions: return air temperature: 68°F (20°C) DB, outdoor temperature:44.6°F (7°C) DB/42.8°F (6°C) WB, equivalent piping: 26.25ft (8m) (horizontal)

Specifications

Model			MDV-D45T2/VN1-BA5	MDV-D56T2/VN1-BA5	MDV-D71T2/VN1-BA5
Power supply		V- Ph-Hz	208-230V~, 1Ph, 60Hz		
Cooling	Capacity	kW	4.5	5.6	7.1
		Btu/h	15400	19100	24200
	Input	W	101	100	170
	Rated current	A	0.5	0.5	0.7
Heating	Capacity	kW	5	6.3	8
		Btu/h	17100	21500	27300
	Input	W	101	100	170
	Rated current	A	0.5	0.5	0.7
Indoor fan motor	Model		YSK47-4G	YSK47-4G	YSK56-4G
	Type		AC MOTOR		
	Brand		Yongan/Welling		Yongan/Welling
	Input	W	96	96	165
	Capacitor	μF	3.5μF/450V	3.5μF/450V	3.5μF/450V
	Speed	r/min	1150/1020/800/700	1150/1020/800/700	940/835/705/640
	Indoor coil	Number of rows		3	3
Tube pitch(a) x row		in.(mm)	13/16×17/32(21×13.37)		
Fin spacing		in.(mm)	1/16(1.5)	1/16(1.5)	1/16(1.5)
Fin type		Hydrophilic aluminum			
Tube outside diameter and type		in.(mm)	9/32(Φ7) Inner groove tube		
Length x height x width		in.(mm)	28-15/16×1-37/64×9-59/64(735×40.1×252)		37-19/32×1-37/64×9-59/64(955×40.1×252)
Number of circuits		4	4	5	
Indoor air flow (SH/H/M/L)	m ³ /h	898(30pa)/852/675/567	898(30pa)/852/675/567	1142(30pa)/1047/917/832	
	CFM	529/501/397/334	529/501/397/334	672/616/540/490	
Indoor external static	Pa	10~30(40Pa site setting)			
Indoor noise level (H/M/L)	dB(A)	41/38.9/36	41/38.9/36	42/40/35	
Indoor unit	Dimension (W×H×D)	in.(mm)	39-49/64×8-9/32×25(1010×210×635)		37-51/64×10- 5/8×25(960×270×635)
	Packing (W×H×D)	in.(mm)	44-11/16×11-27/64×25-25/32(1135×290×655)		44-11/16×13-25/32×25- 25/32(1135×350×655)
	Net/Gross	lbs.(kg)	59.6/70.6(27/32)		66.2/75.0(30/34)
Fresh Air intake hole diameter	in.(mm)	3-5/8(Φ92)	3-5/8(Φ92)	3-5/8(Φ92)	
Refrigerant type		R410A			
Throttle	Type	Electronic expansion valve			
	Model	BD20FKS(L)			
Design pressure(H/ L)		MPa	4.4/2.6		
Refrigerant piping	Liquid / Gas	in.(mm)	1/4(Φ6.35)/1/2(Φ12.7)	3/8(Φ9.53)/5/8(Φ15.9)	3/8(Φ9.53)/5/8 (Φ15.9)
Connecting wiring	Power wiring	mm ²	3×2.5(L≤20m); 3×3.5(L≤50m)		
	Signal wiring	mm ²	3×0.75		
Drainage water pipe		in.(mm)	OD 63/64(Φ25)		
Controller		Wired controller KJR-29B1/BK-E (6 meters connection wire)			

Notes: 1. Nominal cooling capacities are based on the following conditions: return air temperature : 80.6°F(27°C)DB/ 66.2°F(19°C)WB, outdoor temperature:95°F(35°C)DB, equivalent piping: 26.25ft(8m)(horizontal).

2. Nominal heating capacities are based on the following conditions: return air temperature: 68°F (20°C) DB, outdoor temperature:44.6°F (7°C) DB/42.8°F (6°C) WB, equivalent piping: 26.25ft (8m) (horizontal).

Specifications

Model		MDV-D80T2/VN1-B A5	MDV-D90T2/VN1- BA5	MDV-D112T2/VN1-B A5	MDV-D140T2/VN1-BA 5	
Power supply		V- Ph-Hz	208-230V~, 1Ph, 60Hz			
Cooling	Capacity	kW	8	9	11.2	14
		Btu/h	27300	30700	38200	47800
	Input	W	133	134	378	352
	Rated current	A	1	1	1.8	1.55
Heating	Capacity	kW	9	10	12.5	15.5
		Btu/h	30700	34100	42650	52900
	Input	W	133	134	378	352
	Rated current	A	1	1	1.8	1.55
Indoor fan motor	Model		YSK75-6G	YSK75-6G	YSK180-4G	YSK145-4G
	Type		AC MOTOR			
	Brand		Yongan			
	Input	W	127.5	127.5	365	330
	Capacitor	μF	10μF/450V	10μF/450V	10μF/450V	10μF/450V
	Speed (H/M/L)	r/min	950/750/655/610	950/750/655/610	1090/1015/910/830	930/900/805/705
	Number of rows		4	4	4	4
Indoor coil	Tube pitch(a) × row pitch(b)	in.(mm)	13/16×17/32(21×13.37)			1×55/64(25.4×22)
	Fin spacing	in.(mm)	1/16(1.5)	1/16(1.5)	1/16(1.5)	1/16(1.5)
	Fin type		Hydrophilic aluminum			
	Tube outside diameter	in.(mm)	9/32(Φ7) Inner groove tube			
	Length × height × width	in.(mm)	37-19/32×2-1/8×13-7/32(955×54×336)			40-9/16×3-15/32×18 (1030×88×457.2)
	Number of circuits		5	8	8	8
	Indoor air flow ((SH/H/M/L)	m ³ /h	1388(50pa)/1345/11 65/1013	1388(50pa)/1345/1 165/1013	1851(80pa)/1800/15 56/1400	1745(100pa)/1905/16 36/1400
CFM		817/792/686/596	817/792/686/596	1089/1059/916/824	1027/1121/963/824	
Indoor external static pressure		Pa	20(10~50)	20(10~50)	40(10~80)	40(10~100)
Indoor noise level (H/M/L)		dB(A)	45.4/39.8/37	45.4/39.8/37	48.0 /41.9/38	47.7/43.2/39.0
Indoor unit	Dimension (W×H×D)	in.(mm)	48-27/64×10-5/8×30-33/64(1230×270×775)			50-25/32×11-13/16×34 - 1/16 (1290×300×865)
	Packing (W×H×D)	in.(mm)	53-11/32×13-25/32×31-5/16(1355×350×795)			55-1/8×14-49/64×36-2 7/64 (1400×375×925)
	Net/Gross weight	lbs.(kg)	84/102.5(38/46.5)	88/106(40/48)	88/106(40/48)	108/128(49/58)
Fresh Air intake hole diameter		in.(mm)	4-29/32(Φ125)	4-29/32(Φ125)	4-29/32(Φ125)	4-29/32(Φ125)
Refrigerant type			R410A			
Throttle	Type		Electronic expansion valve			
	Model		BD24FKS(L)			
Design pressure(H/L)		MPa	4.4/2.6			
Refrigerant piping	Liquid / Gas	in.(mm)	3/8(Φ9.53)/5/8(Φ15.9)		3/8(Φ9.53)/5/8(Φ15.9)	
Connecting wiring	Power	mm ²	3×2.5(L≤20m);			
	Signal	mm ²	3×0.7			
Drainage water pipe diameter		in.(mm)	OD 63/64(Φ25)			
Controller			Wired controller KJR-29B1/BK-E (6 meters connection wire)			

- Notes:** 1. Nominal cooling capacities are based on the following conditions: return air temperature : 80.6°F(27°C)DB/ 66.2°F(19°C)WB, outdoor temperature:95°F (35°C) DB, equivalent piping: 26.25ft (8m) (horizontal)
2. Nominal heating capacities are based on the following conditions: return air temperature: 68° F (20°C) DB, outdoor temperature:44.6°F (7°C) DB /42.8°F (6°C) WB, equivalent piping: 26.2ft (8m)(horizontal)

3. Dimensions

MDV-D22T2/VN1-BA5 MDV-D28T2/VN1-BA5 MDV-D36T2/VN1-BA5 MDV-D45T2/VN1-BA5
 MDV-D56T2/VN1-BA5 MDV-D71T2/VN1-BA5 MDV-D80T2/VN1-BA5 MDV-D90T2/VN1-BA5
 MDV-D112T2/VN1-BA5 MDV-D140T2/VN1-BA5

Outline dimension and air outlet opening size:

(Unit: mm)

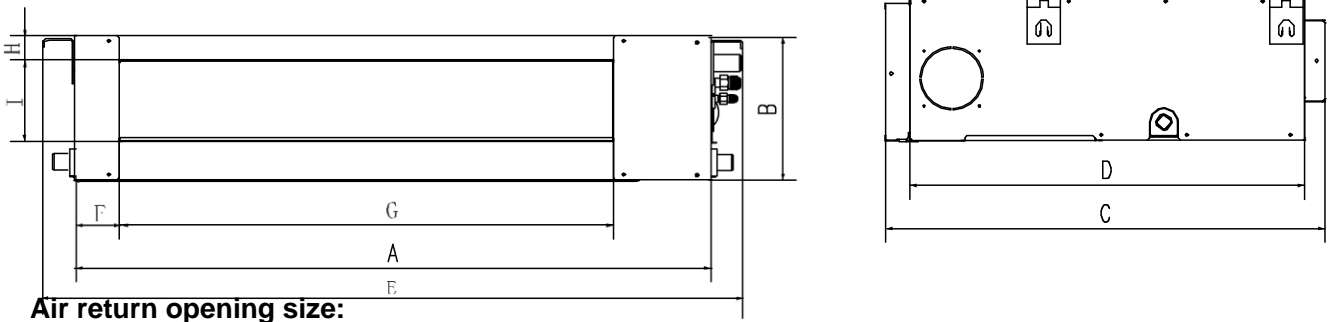

Air return opening size:

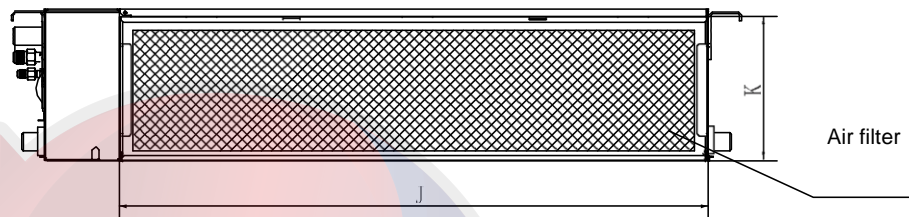

Position size of declensional ventilation opening:

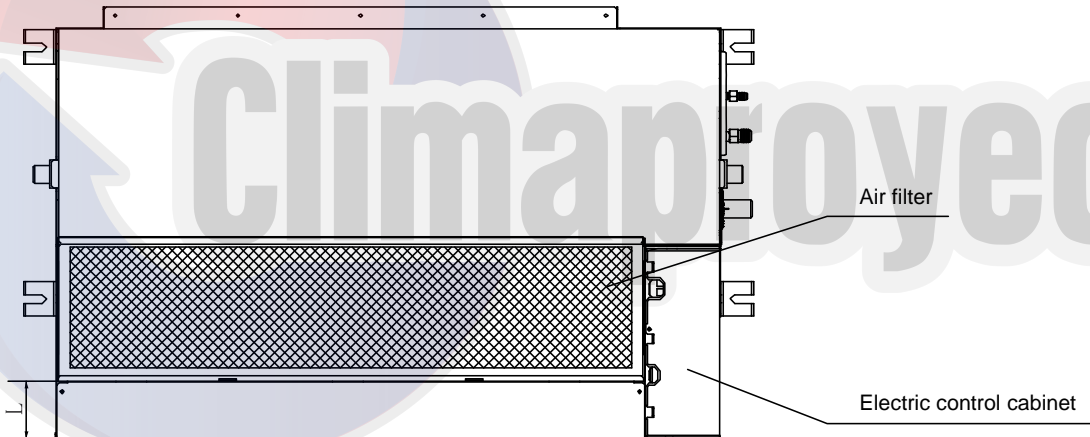

Size of mounted lug:

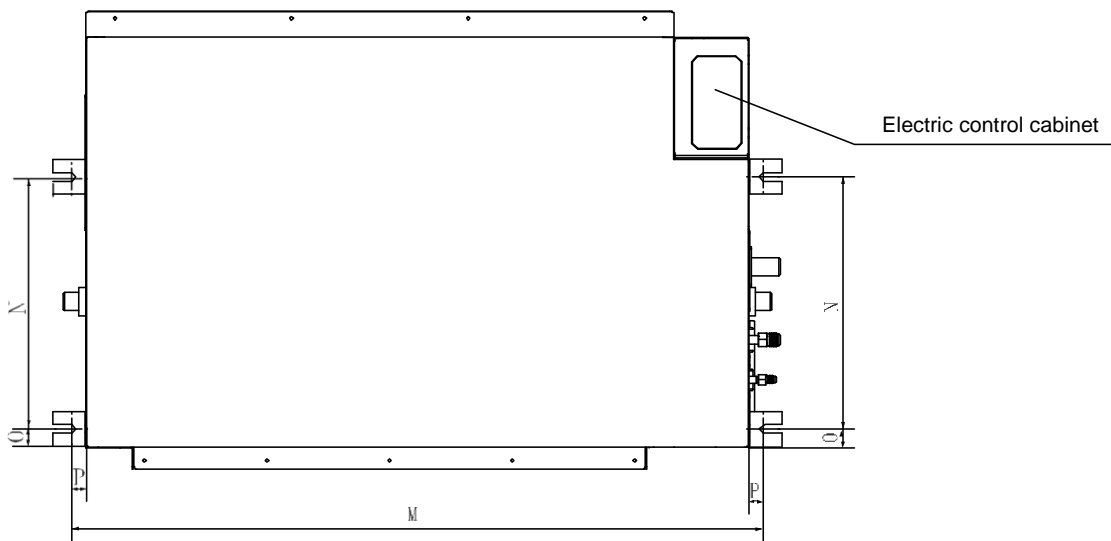

MODEL (MDV-D**T2/N1-*A5)	Outline dimension in.(mm)					Air outlet opening size in.(mm)		
	A	B	C	D	E	F	G	H
22~36	27-9/16(700)	8-9/32(210)	25(635)	22-7/16(570)	31-3/32(790)	2-9/16(65)	19-13/32(493)	1-3/8(35)
45~56	36-7/32(920)	8-9/32(210)	25(635)	22-7/16(570)	39-3/4(1010)	2-9/16(65)	28-1/16(713)	1-3/8(35)
71	44-7/8(1140)	8-9/32(210)	25(635)	22-7/16(570)	48-7/16(1230)	2-9/16(65)	38-23/32(933)	1-3/8(35)
80~112	44-7/8(1140)	10-5/8(270)	30-1/2(775)	27-15/16(710)	48-7/16(1230)	2-9/16(65)	38-23/32(933)	1-3/8(35)
140	47-1/4(1200)	11-13/16(300)	34-1/16(865)	31-1/2(800)	50-25/32(1290)	305/32(80)	38-1/8(968)	1-9/16(40)

MODEL (MDV-D**T2/N1-*A5)	Air return opening size				Size of mounted lug			
	I	J	K	L	M	N	O	P
22~36	4-11/16(119)	23-7/16(595)	7-7/8(200)	3-5/32(80)	29-1/8(740)	13-25/32(350)	1-1/32(26)	25/32(20)
45~56	4-11/16(119)	32-3/32(815)	7-7/8(200)	3-5/32(80)	37-25/32(960)	13-25/32(350)	1-1/32(26)	25/32(20)
71	4-11/16(119)	40-3/4(1035)	7-7/8(200)	2-61/64(75)	46-15/32(1180)	13-25/32(350)	1-1/32(26)	25/32(20)
80~112	7-1/16(179)	40-3/4(1035)	10-1/4(260)	25/32(20)	46-15/32(1180)	19-9/32(490)	1-1/32(26)	25/32(20)
140	8-1/32(204)	43-1/16(1094)	11-11/32(288)	1-25/32(45)	48-13/16(1240)	19-11/16(500)	1-1/32(26)	25/32(20)

4. Service Spaces

- Ensure the needed spaces for installation and maintenance.
- The ceiling is horizontal and its structure can endure the weight of the indoor unit.
- The outlet and the inlet are not impeded, and the influence of external air is the least.
- The air flow can reach throughout the room.
- The connecting pipe and drainpipe could be extracted out easily.
- There is no direct radiation from heaters.
- **Below is the recommended duct installation method:**

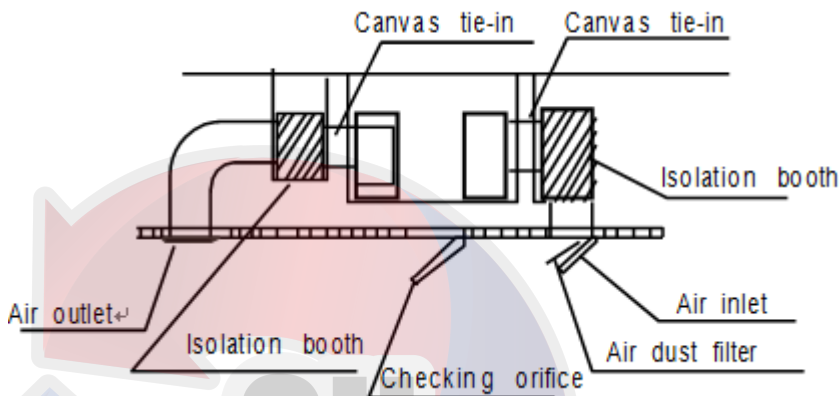

- **Keep 23-5/8in.x23-5/8in. (min. 600x600) space for checking & maintenance:**

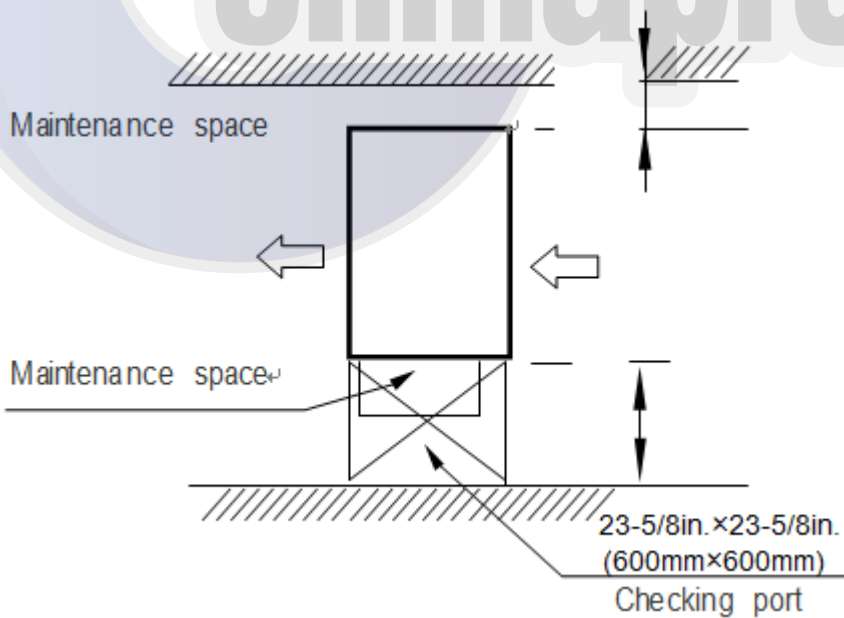

5. Piping Diagrams

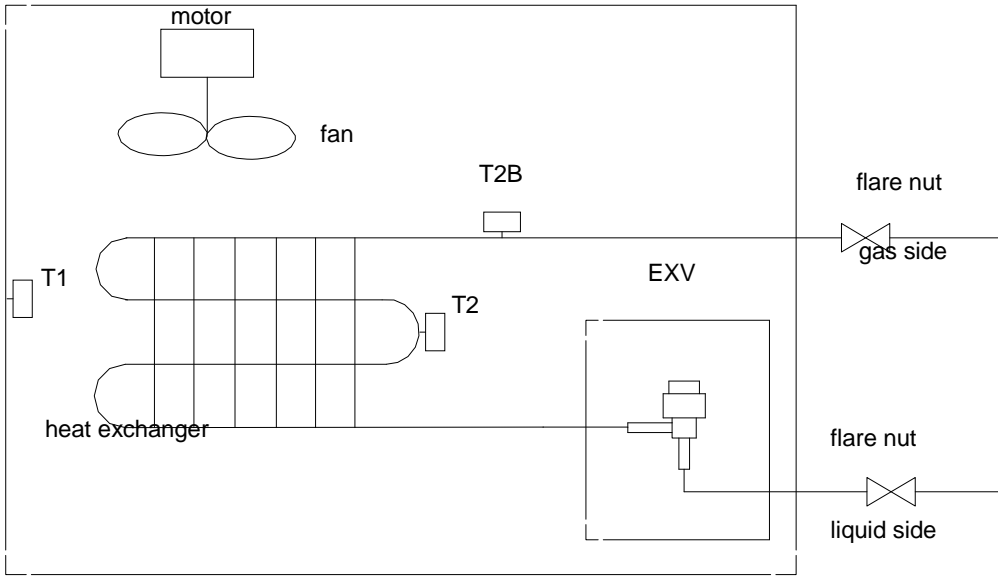

6. Wiring Diagrams

MDV-D22T2/VN1-BA5 MDV-D28T2/VN1-BA5 MDV-D36T2/VN1-BA5 MDV-D45T2/VN1-BA5

MDV-D56T2/VN1-BA5

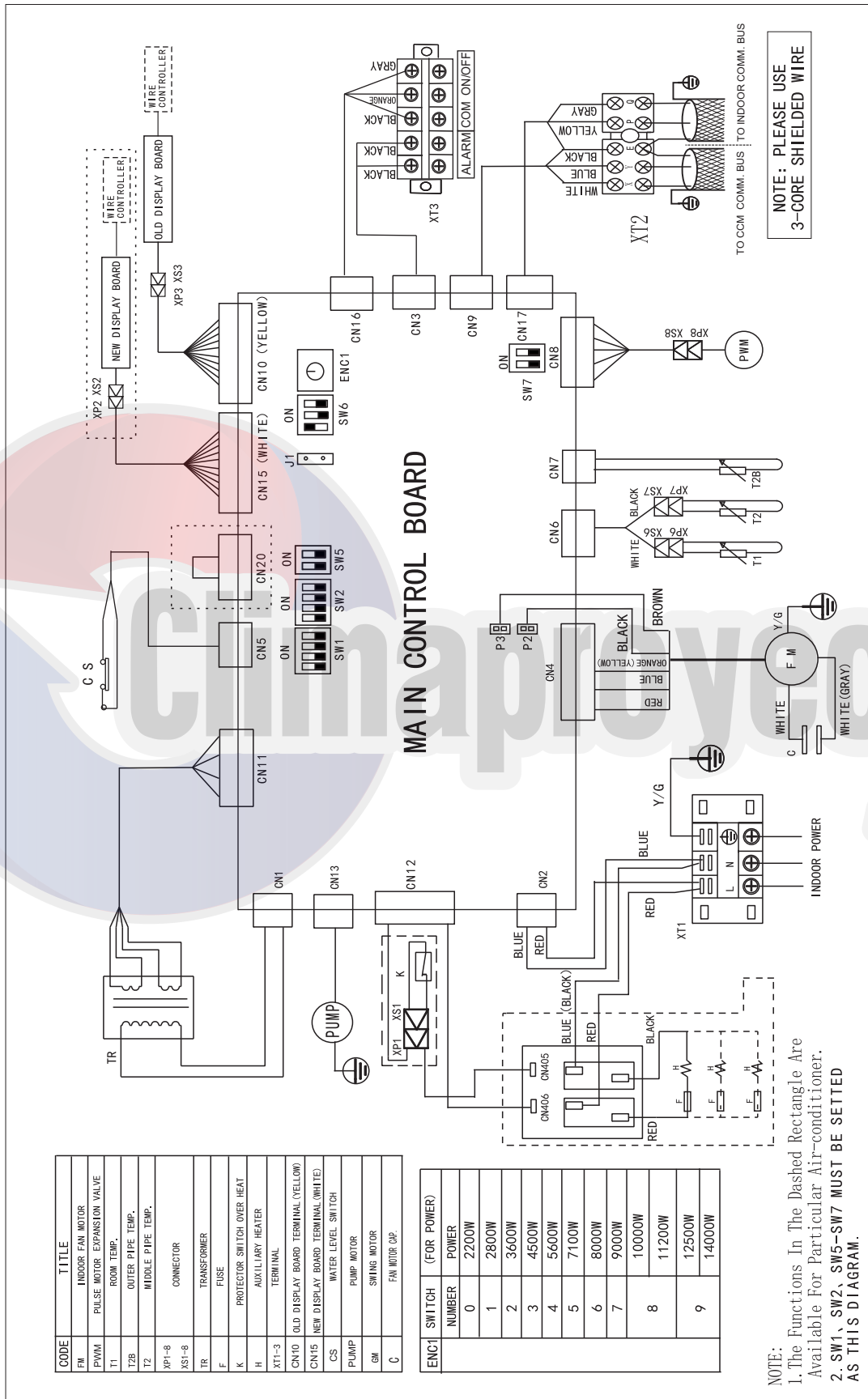

MDV-D71T2/VN1-BA5
MDV-D112T2/VN1-BA5

MDV-D80T2/VN1-BA5
MDV-D140T2/VN1-BA5

MDV-D90T2/VN1-BA5

202085490032

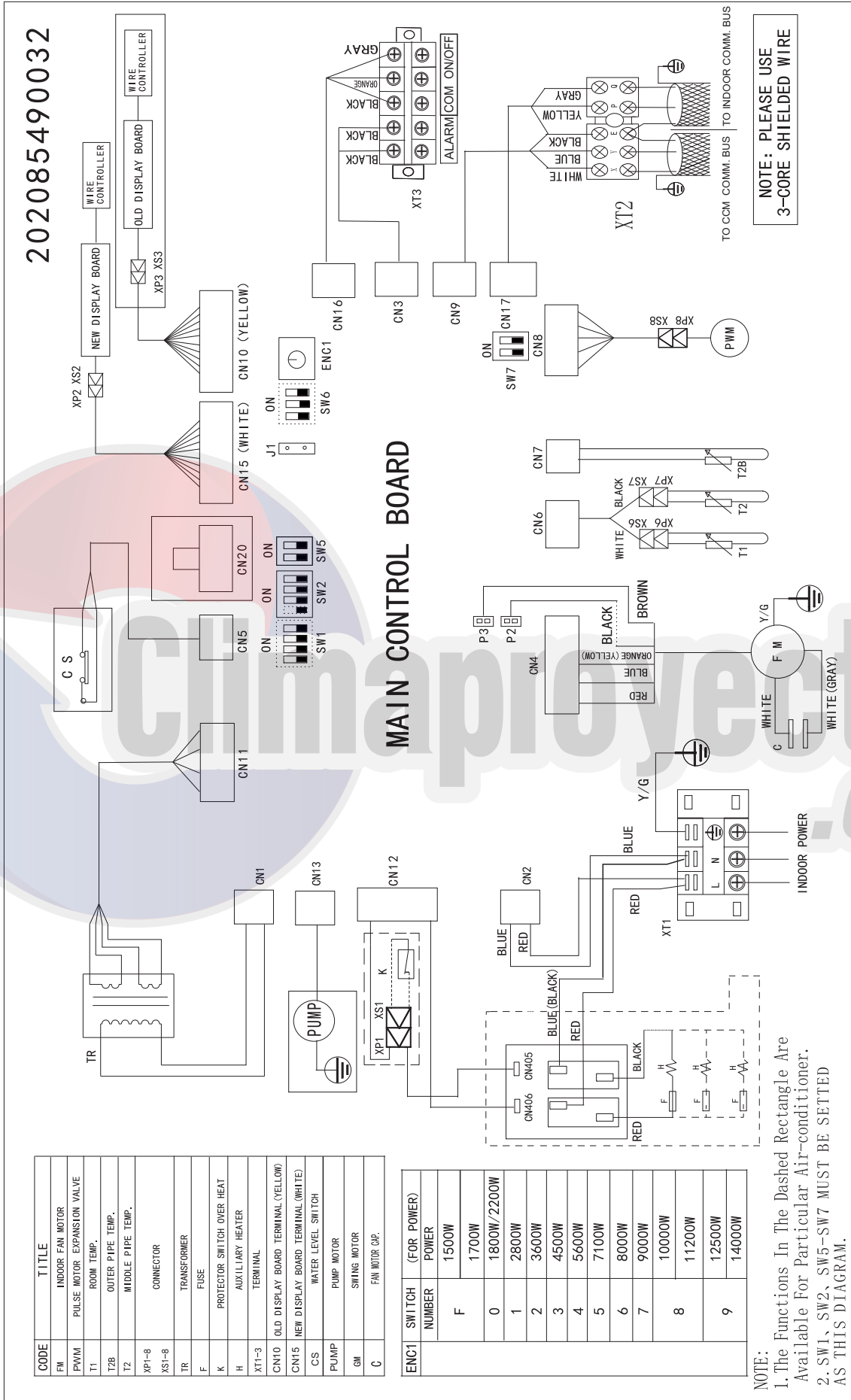

NOTE: PLEASE USE 3-CORE SHIELDED WIRE

7. Fan Performance

How to Read the Diagram

The vertical axis is the External Static Pressure (**Pa**) while the horizontal axis represents the Air Flow (**m³/h**). The characteristic curve for the "SH," "H," "M," and "L" fan speed control

The nameplate values are shown based on the "H" air flow

Therefore in the case of **22T2** Type, the air flow is 528 m³/h , while the External Static Pressure is 10Pa at "H" position. If 30Pa needed, the airflow is at 'SH'

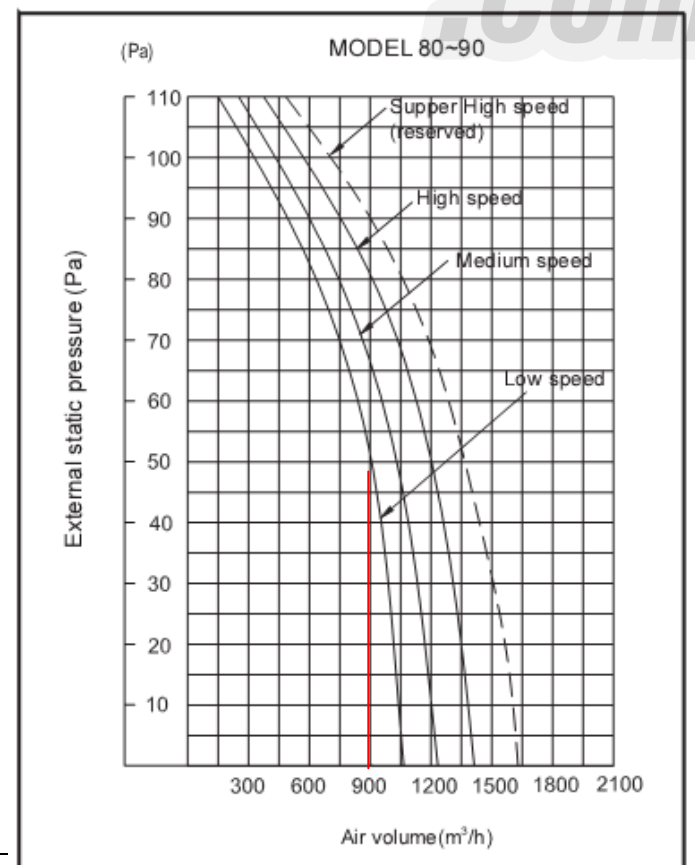
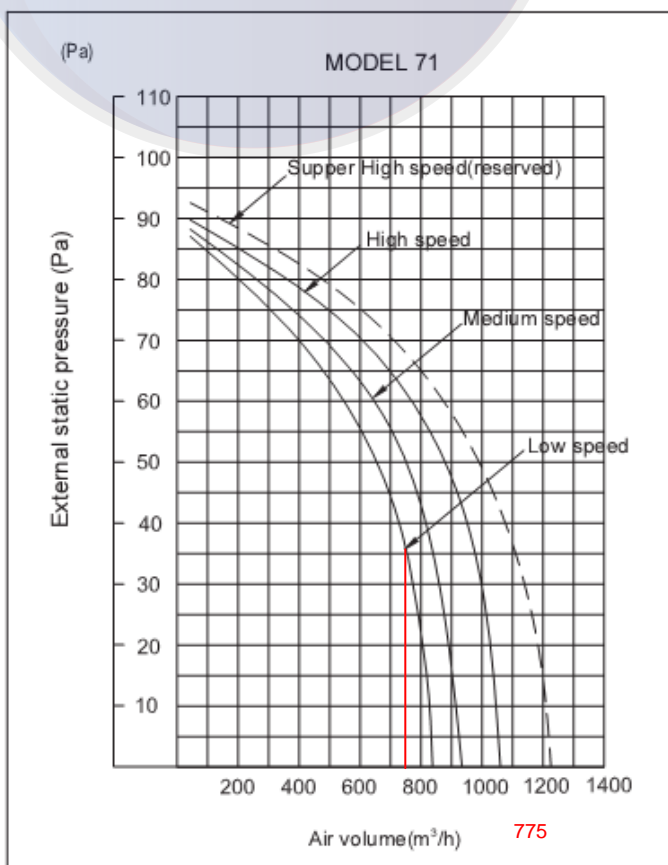
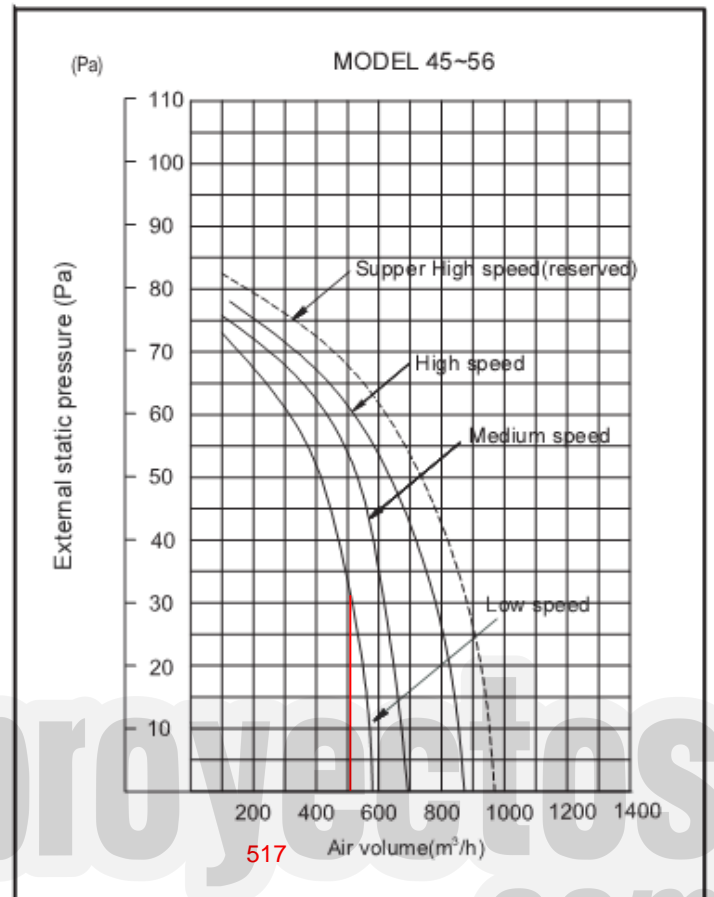
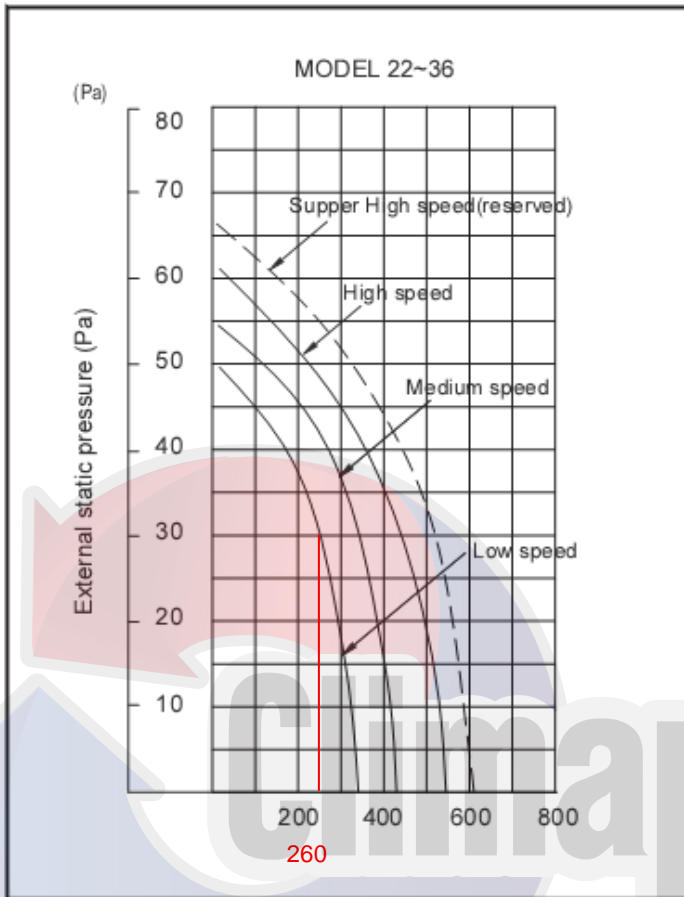

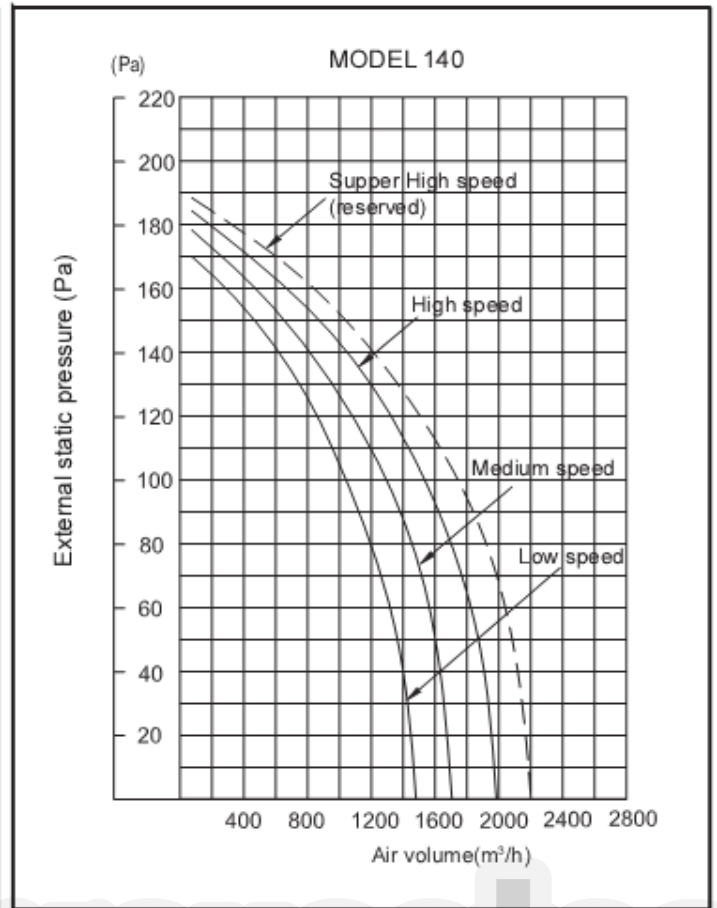
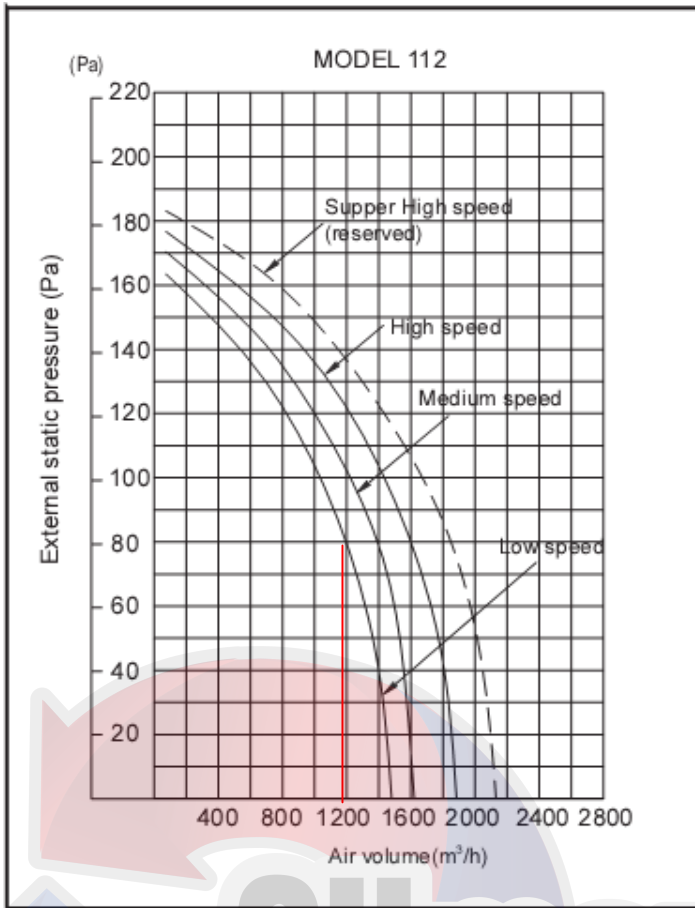

- If the external static pressure is too great (due to long extension of duct, for example), the air flow volume may drop too low at each air outlet.
- So there's a limit air flow volume line for each speed, which is the min. airflow of this duct unit. At this flow volume, the fan achieve the max. ESP, and indoor evaporator may protect by low temp.
- As well, there's a limit airflow volume, which is the max. Value at each speed. It requests the unit to connect duct for air-inlet and outlet, to prevent damage from the high temp. of motor/evaporator

8. Capacity Tables

8.1 Cooling TC: Total capacity SC: Sensible capacity WB: Wet-bulb temperature DB: Dry-bulb temperature

Indoor Unit size (kW)	Outdoor temperature (°FDB)	Indoor temperature (°FWB/DB)													
		57.2/68		60.8/73.4		64.4/78.8		66.2/80.6		68/82.4		71.6/86		75.2/89.6	
		TC	SC	TC	SC	TC	SC	TC	SC	TC	SC	TC	SC	TC	SC
		kW	kW	kW	kW	kW	kW	kW	kW	kW	kW	kW	kW	kW	kW
2.2	50	1.5	1.4	1.8	1.5	2.1	1.6	2.2	1.6	2.3	1.7	2.6	1.7	2.9	1.7
	53.6	1.5	1.4	1.8	1.5	2.1	1.6	2.2	1.6	2.3	1.7	2.6	1.7	2.8	1.6
	57.2	1.5	1.4	1.8	1.5	2.1	1.6	2.2	1.6	2.3	1.7	2.6	1.7	2.8	1.6
	60.8	1.5	1.4	1.8	1.5	2.1	1.6	2.2	1.6	2.3	1.7	2.6	1.7	2.8	1.6
	64.4	1.5	1.4	1.8	1.5	2.1	1.6	2.2	1.6	2.3	1.7	2.6	1.7	2.8	1.6
	68	1.5	1.4	1.8	1.5	2.1	1.6	2.2	1.6	2.3	1.7	2.6	1.7	2.7	1.5
	69.8	1.5	1.4	1.8	1.5	2.1	1.6	2.2	1.6	2.3	1.7	2.6	1.7	2.7	1.5
	73.4	1.5	1.4	1.8	1.5	2.1	1.6	2.2	1.6	2.3	1.7	2.5	1.6	2.7	1.5
	77	1.5	1.4	1.8	1.5	2.1	1.6	2.2	1.6	2.3	1.7	2.5	1.6	2.6	1.5
	80.6	1.5	1.4	1.8	1.5	2.1	1.6	2.2	1.6	2.3	1.7	2.5	1.6	2.6	1.5
	84.2	1.5	1.4	1.8	1.5	2.1	1.6	2.2	1.6	2.3	1.7	2.4	1.5	2.5	1.5
	87.8	1.5	1.4	1.8	1.5	2.1	1.6	2.2	1.6	2.3	1.7	2.4	1.5	2.5	1.5
	91.4	1.5	1.4	1.8	1.5	2.1	1.6	2.2	1.6	2.3	1.7	2.4	1.5	2.4	1.5
	95	1.5	1.4	1.8	1.5	2.1	1.6	2.2	1.6	2.3	1.7	2.3	1.5	2.4	1.5
	98.6	1.5	1.4	1.8	1.5	2.1	1.6	2.2	1.6	2.3	1.7	2.3	1.5	2.3	1.5
	102.2	1.5	1.4	1.8	1.5	2.1	1.6	2.2	1.6	2.2	1.6	2.3	1.5	2.3	1.5
	107.6	1.5	1.4	1.8	1.5	2.1	1.6	2.2	1.6	2.2	1.6	2.3	1.5	2.3	1.5
	111.2	1.5	1.4	1.8	1.5	2.1	1.6	2.2	1.6	2.2	1.6	2.3	1.5	2.3	1.5
114.8	1.5	1.4	1.8	1.5	2.1	1.6	2.2	1.6	2.2	1.6	2.3	1.5	2.3	1.5	
2.8	50	1.9	1.7	2.3	1.9	2.6	2.1	2.8	2.1	3.0	2.1	3.3	2.2	3.7	2.2
	53.6	1.9	1.7	2.3	1.9	2.6	2.1	2.8	2.1	3.0	2.1	3.3	2.2	3.6	2.1
	57.2	1.9	1.7	2.3	1.9	2.6	2.1	2.8	2.1	3.0	2.1	3.3	2.2	3.6	2.1
	60.8	1.9	1.7	2.3	1.9	2.6	2.1	2.8	2.1	3.0	2.1	3.3	2.2	3.5	2.1
	64.4	1.9	1.7	2.3	1.9	2.6	2.1	2.8	2.1	3.0	2.1	3.3	2.2	3.5	2.1
	68	1.9	1.7	2.3	1.9	2.6	2.1	2.8	2.1	3.0	2.1	3.3	2.2	3.4	2.1
	69.8	1.9	1.7	2.3	1.9	2.6	2.1	2.8	2.1	3.0	2.1	3.3	2.2	3.4	2.1
	73.4	1.9	1.7	2.3	1.9	2.6	2.1	2.8	2.1	3.0	2.1	3.3	2.1	3.4	2.1
	77	1.9	1.7	2.3	1.9	2.6	2.1	2.8	2.1	3.0	2.1	3.2	2.1	3.3	2.0
	80.6	1.9	1.7	2.3	1.9	2.6	2.1	2.8	2.1	3.0	2.1	3.2	2.1	3.3	2.0
	84.2	1.9	1.7	2.3	1.9	2.6	2.1	2.8	2.1	3.0	2.1	3.1	2.0	3.2	1.9
	87.8	1.9	1.7	2.3	1.9	2.6	2.1	2.8	2.1	3.0	2.1	3.1	2.0	3.2	1.9
	91.4	1.9	1.7	2.3	1.9	2.6	2.1	2.8	2.1	3.0	2.1	3.1	2.0	3.1	1.9
	95	1.9	1.7	2.3	1.9	2.6	2.1	2.8	2.1	2.9	2.0	3.0	2.0	3.1	1.9
	98.6	1.9	1.7	2.3	1.9	2.6	2.1	2.8	2.1	2.9	2.0	3.0	2.0	3.0	1.8
	102.2	1.9	1.7	2.3	1.9	2.6	2.1	2.8	2.1	2.9	2.0	3.0	2.1	3.0	1.9
	107.6	1.9	1.7	2.3	1.9	2.6	2.1	2.8	2.1	2.9	2.0	3.0	2.1	3.0	1.9
	111.2	1.9	1.7	2.3	1.9	2.6	2.1	2.8	2.1	2.9	2.0	3.0	2.1	3.0	1.9
114.8	1.9	1.7	2.3	1.9	2.6	2.1	2.8	2.1	2.9	2.0	3.0	2.1	3.0	1.9	
3.6	50	2.5	2.1	2.9	2.3	3.4	2.5	3.6	2.6	3.8	2.7	4.3	2.6	4.7	2.7
	53.6	2.5	2.1	2.9	2.3	3.4	2.5	3.6	2.6	3.8	2.7	4.3	2.6	4.7	2.7
	57.2	2.5	2.1	2.9	2.3	3.4	2.5	3.6	2.6	3.8	2.7	4.3	2.6	4.6	2.6
	60.8	2.5	2.1	2.9	2.3	3.4	2.5	3.6	2.6	3.8	2.7	4.3	2.6	4.5	2.6
	64.4	2.5	2.1	2.9	2.3	3.4	2.5	3.6	2.6	3.8	2.7	4.3	2.6	4.5	2.6
	68	2.5	2.1	2.9	2.3	3.4	2.5	3.6	2.6	3.8	2.7	4.3	2.6	4.4	2.5
	69.8	2.5	2.1	2.9	2.3	3.4	2.5	3.6	2.6	3.8	2.7	4.3	2.6	4.4	2.5
	73.4	2.5	2.1	2.9	2.3	3.4	2.5	3.6	2.6	3.8	2.7	4.1	2.5	4.3	2.4
	77	2.5	2.1	2.9	2.3	3.4	2.5	3.6	2.6	3.8	2.7	4.1	2.5	4.2	2.4
	80.6	2.5	2.1	2.9	2.3	3.4	2.5	3.6	2.6	3.8	2.7	4.0	2.4	4.2	2.4
	84.2	2.5	2.1	2.9	2.3	3.4	2.5	3.6	2.6	3.8	2.7	4.0	2.4	4.1	2.4
	87.8	2.5	2.1	2.9	2.3	3.4	2.5	3.6	2.6	3.8	2.7	4.2	2.8	4.1	2.4
	91.4	2.5	2.1	2.9	2.3	3.4	2.5	3.6	2.6	3.8	2.7	4.2	2.8	3.9	2.3
	95	2.5	2.1	2.9	2.3	3.4	2.5	3.6	2.6	3.8	2.7	4.2	2.8	3.9	2.3
	98.6	2.5	2.1	2.9	2.3	3.4	2.5	3.6	2.6	3.7	2.6	3.8	2.5	3.9	2.3
	102.2	2.5	2.1	2.9	2.3	3.4	2.5	3.6	2.6	3.7	2.6	3.8	2.5	3.8	2.3
	107.6	2.5	2.1	2.9	2.3	3.4	2.5	3.6	2.6	3.7	2.6	3.8	2.5	3.8	2.3
	111.2	2.5	2.1	2.9	2.3	3.4	2.5	3.6	2.6	3.7	2.6	3.8	2.5	3.8	2.3
114.8	2.5	2.1	2.9	2.3	3.4	2.5	3.6	2.6	3.7	2.6	3.8	2.5	3.8	2.3	
4.5	50	3.1	2.6	3.7	2.8	4.2	3.1	4.5	3.2	4.8	3.2	5.3	3.7	5.9	3.3
	53.6	3.1	2.6	3.7	2.8	4.2	3.1	4.5	3.2	4.8	3.2	5.3	3.7	5.9	3.3
	57.2	3.1	2.6	3.7	2.8	4.2	3.1	4.5	3.2	4.8	3.2	5.3	3.7	5.8	3.3

Indoor Unit size (kW)	Outdoor temperature (°FDB)	Indoor temperature (°FWB/DB)													
		57.2/68		60.8/73.4		64.4/78.8		66.2/80.6		68/82.4		71.6/86		75.2/89.6	
		TC	SC	TC	SC	TC	SC	TC	SC	TC	SC	TC	SC	TC	SC
		kW	kW	kW	kW	kW	kW	kW	kW	kW	kW	kW	kW	kW	kW
4.5	60.8	3.1	2.6	3.7	2.8	4.2	3.1	4.5	3.2	4.8	3.2	5.3	3.7	5.6	3.2
	64.4	3.1	2.6	3.7	2.8	4.2	3.1	4.5	3.2	4.8	3.2	5.3	3.7	5.7	3.3
	68	3.1	2.6	3.7	2.8	4.2	3.1	4.5	3.2	4.8	3.2	5.3	3.7	5.7	3.3
	69.8	3.1	2.6	3.7	2.8	4.2	3.1	4.5	3.2	4.8	3.2	5.3	3.7	5.6	3.3
	73.4	3.1	2.6	3.7	2.8	4.2	3.1	4.5	3.2	4.8	3.2	5.3	3.7	5.5	3.2
	77	3.1	2.6	3.7	2.8	4.2	3.1	4.5	3.2	4.8	3.2	5.2	3.3	5.4	3.2
	80.6	3.1	2.6	3.7	2.8	4.2	3.1	4.5	3.2	4.8	3.2	5.1	3.2	5.2	3.0
	84.2	3.1	2.6	3.7	2.8	4.2	3.1	4.5	3.2	4.8	3.2	5.1	3.2	5.2	3.0
	87.8	3.1	2.6	3.7	2.8	4.2	3.1	4.5	3.2	4.8	3.2	5.0	3.1	5.1	2.9
	91.4	3.1	2.6	3.7	2.8	4.2	3.1	4.5	3.2	4.8	3.2	4.9	3.1	5.1	2.9
	95	3.1	2.6	3.7	2.8	4.2	3.1	4.5	3.2	4.8	3.2	4.8	3.0	5.0	2.9
	98.6	3.1	2.6	3.7	2.8	4.2	3.1	4.5	3.2	4.8	3.2	4.8	3.1	4.9	2.8
	102.2	3.1	2.6	3.7	2.8	4.2	3.1	4.5	3.2	4.6	3.1	4.7	3.1	4.8	2.8
	107.6	3.1	2.6	3.7	2.8	4.2	3.1	4.5	3.2	4.6	3.1	4.7	3.1	4.8	2.8
111.2	3.1	2.6	3.7	2.8	4.2	3.1	4.5	3.2	4.6	3.1	4.7	3.1	4.8	2.8	
114.8	3.1	2.6	3.7	2.8	4.2	3.1	4.5	3.2	4.6	3.1	4.7	3.1	4.8	2.8	
5.6	50	3.9	3.0	4.6	3.3	5.3	3.6	5.6	3.7	5.9	3.8	6.6	3.9	7.3	3.9
	53.6	3.9	3.0	4.6	3.3	5.3	3.6	5.6	3.7	5.9	3.8	6.6	3.9	7.2	3.8
	57.2	3.9	3.0	4.6	3.3	5.3	3.6	5.6	3.7	5.9	3.8	6.6	3.9	7.1	3.8
	60.8	3.9	3.0	4.6	3.3	5.3	3.6	5.6	3.7	5.9	3.8	6.6	3.9	7.0	3.7
	64.4	3.9	3.0	4.6	3.3	5.3	3.6	5.6	3.7	5.9	3.8	6.6	3.9	6.8	3.7
	68	3.9	3.0	4.6	3.3	5.3	3.6	5.6	3.7	5.9	3.8	6.6	3.9	6.7	3.6
	69.8	3.9	3.0	4.6	3.3	5.3	3.6	5.6	3.7	5.9	3.8	6.6	3.9	6.6	3.6
	73.4	3.9	3.0	4.6	3.3	5.3	3.6	5.6	3.7	5.9	3.8	6.6	3.9	6.6	3.5
	77	3.9	3.0	4.6	3.3	5.3	3.6	5.6	3.7	5.9	3.8	6.6	3.9	6.5	3.5
	80.6	3.9	3.0	4.6	3.3	5.3	3.6	5.6	3.7	5.9	3.8	6.4	3.8	6.4	3.5
	84.2	3.9	3.0	4.6	3.3	5.3	3.6	5.6	3.7	5.9	3.8	6.3	3.8	6.4	3.6
	87.8	3.9	3.0	4.6	3.3	5.3	3.6	5.6	3.7	5.9	3.8	6.2	3.7	6.2	3.4
	91.4	3.9	3.0	4.6	3.3	5.3	3.6	5.6	3.7	5.9	3.8	6.2	3.7	6.2	3.4
	95	3.9	3.0	4.6	3.3	5.3	3.6	5.6	3.7	5.9	3.8	6.0	3.6	6.0	3.4
98.6	3.9	3.0	4.6	3.3	5.3	3.6	5.6	3.7	5.9	3.8	5.9	3.5	6.0	3.4	
102.2	3.9	3.0	4.6	3.3	5.3	3.6	5.6	3.7	5.7	3.7	5.8	3.5	6.0	3.4	
107.6	3.9	3.0	4.6	3.3	5.3	3.6	5.6	3.7	5.7	3.7	5.8	3.5	6.0	3.4	
111.2	3.9	3.0	4.6	3.3	5.3	3.6	5.6	3.7	5.7	3.7	5.8	3.5	6.0	3.4	
114.8	3.9	3.0	4.6	3.3	5.3	3.6	5.6	3.7	5.7	3.7	5.8	3.5	6.0	3.4	
7.1	50	4.9	3.9	5.8	4.3	6.7	4.7	7.1	4.9	7.5	4.8	8.4	4.9	9.2	5.0
	53.6	4.9	3.9	5.8	4.3	6.7	4.7	7.1	4.9	7.5	4.8	8.4	4.9	9.1	4.9
	57.2	4.9	3.9	5.8	4.3	6.7	4.7	7.1	4.9	7.5	4.8	8.4	4.9	9.0	4.9
	60.8	4.9	3.9	5.8	4.3	6.7	4.7	7.1	4.9	7.5	4.8	8.4	4.9	8.9	4.8
	64.4	4.9	3.9	5.8	4.3	6.7	4.7	7.1	4.9	7.5	4.8	8.4	4.9	8.7	4.7
	68	4.9	3.9	5.8	4.3	6.7	4.7	7.1	4.9	7.5	4.8	8.4	4.9	8.5	4.6
	69.8	4.9	3.9	5.8	4.3	6.7	4.7	7.1	4.9	7.5	4.8	8.4	4.9	8.4	4.5
	73.4	4.9	3.9	5.8	4.3	6.7	4.7	7.1	4.9	7.5	4.8	8.4	4.9	8.3	4.5
	77	4.9	3.9	5.8	4.3	6.7	4.7	7.1	4.9	7.5	4.8	8.4	4.9	8.2	4.4
	80.6	4.9	3.9	5.8	4.3	6.7	4.7	7.1	4.9	7.5	4.8	8.1	4.7	8.2	4.5
	84.2	4.9	3.9	5.8	4.3	6.7	4.7	7.1	4.9	7.5	4.8	8.0	4.7	8.1	4.5
	87.8	4.9	3.9	5.8	4.3	6.7	4.7	7.1	4.9	7.5	4.8	7.9	4.6	7.8	4.3
	91.4	4.9	3.9	5.8	4.3	6.7	4.7	7.1	4.9	7.5	4.8	7.8	4.6	7.8	4.3
	95	4.9	3.9	5.8	4.3	6.7	4.7	7.1	4.9	7.5	4.8	7.6	4.5	7.7	4.2
98.6	4.9	3.9	5.8	4.3	6.7	4.7	7.1	4.9	7.4	4.8	7.5	4.5	7.6	4.3	
102.2	4.9	3.9	5.8	4.3	6.7	4.7	7.1	4.9	7.2	4.7	7.4	4.4	7.6	4.3	
107.6	4.9	3.9	5.8	4.3	6.7	4.7	7.1	4.9	7.2	4.7	7.4	4.4	7.6	4.3	
111.2	4.9	3.9	5.8	4.3	6.7	4.7	7.1	4.9	7.2	4.7	7.4	4.4	7.6	4.3	
114.8	4.9	3.9	5.8	4.3	6.7	4.7	7.1	4.9	7.2	4.7	7.4	4.4	7.6	4.3	
8.0	50	5.5	4.4	6.6	4.9	7.5	5.3	8.0	5.5	8.4	5.4	9.4	5.5	10.4	5.6
	53.6	5.5	4.4	6.6	4.9	7.5	5.3	8.0	5.5	8.4	5.4	9.4	5.5	10.2	5.5
	57.2	5.5	4.4	6.6	4.9	7.5	5.3	8.0	5.5	8.4	5.4	9.4	5.5	10.2	5.5
	60.8	5.5	4.4	6.6	4.9	7.5	5.3	8.0	5.5	8.4	5.4	9.4	5.5	10.0	5.4
	64.4	5.5	4.4	6.6	4.9	7.5	5.3	8.0	5.5	8.4	5.4	9.4	5.5	9.8	5.3
	68	5.5	4.4	6.6	4.9	7.5	5.3	8.0	5.5	8.4	5.4	9.4	5.5	9.6	5.2
	69.8	5.5	4.4	6.6	4.9	7.5	5.3	8.0	5.5	8.4	5.4	9.4	5.5	9.4	5.1
73.4	5.5	4.4	6.6	4.9	7.5	5.3	8.0	5.5	8.4	5.4	9.4	5.5	9.4	5.1	

Indoor Unit size (kW)	Outdoor temperature (°FDB)	Indoor temperature (°FWB/DB)													
		57.2/68		60.8/73.4		64.4/78.8		66.2/80.6		68/82.4		71.6/86		75.2/89.6	
		TC	SC	TC	SC	TC	SC	TC	SC	TC	SC	TC	SC	TC	SC
		kW	kW	kW	kW	kW	kW	kW	kW	kW	kW	kW	kW	kW	kW
8.0	77	5.5	4.4	6.6	4.9	7.5	5.3	8.0	5.5	8.4	5.4	9.4	5.5	9.3	5.0
	80.6	5.5	4.4	6.6	4.9	7.5	5.3	8.0	5.5	8.4	5.4	9.1	5.3	9.2	5.1
	84.2	5.5	4.4	6.6	4.9	7.5	5.3	8.0	5.5	8.4	5.5	9.0	5.3	9.1	5.0
	87.8	5.5	4.4	6.6	4.9	7.5	5.3	8.0	5.5	8.4	5.5	8.9	5.2	8.8	4.8
	91.4	5.5	4.4	6.6	4.9	7.5	5.3	8.0	5.5	8.4	5.5	8.8	5.2	8.8	4.8
	95	5.5	4.4	6.6	4.9	7.5	5.3	8.0	5.5	8.4	5.5	8.6	5.1	8.6	4.8
	98.6	5.5	4.4	6.6	4.9	7.5	5.3	8.0	5.5	8.3	5.4	8.4	5.0	8.6	4.9
	102.2	5.5	4.4	6.6	4.9	7.5	5.3	8.0	5.5	8.1	5.3	8.3	5.0	8.6	4.9
	107.6	5.5	4.4	6.6	4.9	7.5	5.3	8.0	5.5	8.1	5.3	8.3	5.0	8.6	4.9
	111.2	5.5	4.4	6.6	4.9	7.5	5.3	8.0	5.5	8.1	5.3	8.3	5.0	8.6	4.9
114.8	5.5	4.4	6.6	4.9	7.5	5.3	8.0	5.5	8.1	5.3	8.3	5.0	8.6	4.9	
9.0	50	6.2	5.3	7.3	5.8	8.4	6.3	9.0	6.4	9.6	6.5	10.6	6.6	11.7	6.6
	53.6	6.2	5.3	7.3	5.8	8.4	6.3	9.0	6.4	9.6	6.5	10.6	6.6	11.5	6.5
	57.2	6.2	5.3	7.3	5.8	8.4	6.3	9.0	6.4	9.6	6.5	10.6	6.6	11.4	6.4
	60.8	6.2	5.3	7.3	5.8	8.4	6.3	9.0	6.4	9.6	6.5	10.6	6.6	11.3	6.3
	64.4	6.2	5.3	7.3	5.8	8.4	6.3	9.0	6.4	9.6	6.5	10.6	6.6	11.0	6.3
	68	6.2	5.3	7.3	5.8	8.4	6.3	9.0	6.4	9.6	6.5	10.6	6.6	10.8	6.2
	69.8	6.2	5.3	7.3	5.8	8.4	6.3	9.0	6.4	9.6	6.5	10.6	6.6	10.6	6.1
	73.4	6.2	5.3	7.3	5.8	8.4	6.3	9.0	6.4	9.6	6.5	10.6	6.6	10.5	6.0
	77	6.2	5.3	7.3	5.8	8.4	6.3	9.0	6.4	9.6	6.5	10.6	6.6	10.4	6.0
	80.6	6.2	5.3	7.3	5.8	8.4	6.3	9.0	6.4	9.6	6.5	10.3	6.4	10.4	5.9
	84.2	6.2	5.3	7.3	5.8	8.4	6.3	9.0	6.4	9.6	6.5	10.1	6.2	10.3	5.8
	87.8	6.2	5.3	7.3	5.8	8.4	6.3	9.0	6.4	9.6	6.5	10.0	6.2	9.9	5.7
	91.4	6.2	5.3	7.3	5.8	8.4	6.3	9.0	6.4	9.6	6.5	9.9	6.1	9.9	5.7
	95	6.2	5.3	7.3	5.8	8.4	6.3	9.0	6.4	9.5	6.5	9.6	6.0	9.7	5.7
98.6	6.2	5.3	7.3	5.8	8.4	6.3	9.0	6.4	9.3	6.3	9.5	5.9	9.6	5.8	
102.2	6.2	5.3	7.3	5.8	8.4	6.3	9.0	6.4	9.2	6.2	9.4	5.8	9.6	5.8	
107.6	6.2	5.3	7.3	5.8	8.4	6.3	9.0	6.4	9.2	6.2	9.4	5.8	9.6	5.8	
111.2	6.2	5.3	7.3	5.8	8.4	6.3	9.0	6.4	9.2	6.2	9.4	5.8	9.6	5.8	
114.8	6.2	5.3	7.3	5.8	8.4	6.3	9.0	6.4	9.2	6.2	9.4	5.8	9.6	5.8	
11.2	50	7.7	6.4	9.1	7.1	10.5	7.7	11.2	7.8	11.9	8.1	13.3	8.3	15.5	9.0
	53.6	7.7	6.4	9.1	7.1	10.5	7.7	11.2	7.8	11.9	8.1	13.3	8.3	14.4	8.4
	57.2	7.7	6.4	9.1	7.1	10.5	7.7	11.2	7.8	11.9	8.1	13.3	8.3	14.2	8.2
	60.8	7.7	6.4	9.1	7.1	10.5	7.7	11.2	7.8	11.9	8.1	13.3	8.3	14.1	8.2
	64.4	7.7	6.4	9.1	7.1	10.5	7.7	11.2	7.8	11.9	8.1	13.3	8.3	14.0	8.1
	68	7.7	6.4	9.1	7.1	10.5	7.7	11.2	7.8	11.9	8.1	13.3	8.3	13.9	8.1
	69.8	7.7	6.4	9.1	7.1	10.5	7.7	11.2	7.8	11.9	8.1	13.3	8.3	13.8	8.0
	73.4	7.7	6.4	9.1	7.1	10.5	7.7	11.2	7.8	11.9	8.1	13.1	8.1	13.7	7.9
	77	7.7	6.4	9.1	7.1	10.5	7.7	11.2	7.8	11.9	8.1	13.0	8.1	13.6	7.9
	80.6	7.7	6.4	9.1	7.1	10.5	7.7	11.2	7.8	11.9	8.1	12.9	8.0	13.4	7.8
	84.2	7.7	6.4	9.1	7.1	10.5	7.7	11.2	7.8	11.9	8.1	12.8	7.9	13.3	7.9
	87.8	7.7	6.4	9.1	7.1	10.5	7.7	11.2	7.8	11.9	8.1	12.7	7.8	12.8	7.5
	91.4	7.7	6.4	9.1	7.1	10.5	7.7	11.2	7.8	11.9	8.1	12.5	7.8	12.5	7.4
	95	7.7	6.4	9.1	7.1	10.5	7.7	11.2	7.8	11.8	8.0	12.4	7.7	12.3	7.3
98.6	7.7	6.4	9.1	7.1	10.5	7.7	11.2	7.8	11.6	7.9	12.3	7.6	12.1	7.1	
102.2	7.7	6.4	9.1	7.1	10.5	7.7	11.2	7.8	11.4	7.8	12.2	7.6	11.9	7.1	
107.6	7.7	6.6	9.1	7.2	10.4	7.8	11.2	8.0	11.4	7.8	11.6	7.2	12.0	7.2	
111.2	7.7	6.6	9.1	7.2	10.4	7.8	11.2	8.0	11.4	7.8	11.6	7.2	12.0	7.2	
114.8	7.7	6.6	9.1	7.2	10.4	7.8	11.2	8.0	11.4	7.8	11.6	7.2	12.0	7.2	
14.0	50	9.7	7.8	11.3	8.6	13.2	9.6	14.0	9.8	14.8	9.8	16.7	10.2	18.2	10.2
	53.6	9.7	7.8	11.3	8.6	13.2	9.6	14.0	9.8	14.8	9.8	16.7	10.2	17.9	10.0
	57.2	9.7	7.8	11.3	8.6	13.2	9.6	14.0	9.8	14.8	9.8	16.7	10.2	17.8	10.0
	60.8	9.7	7.8	11.3	8.6	13.2	9.6	14.0	9.8	14.8	9.8	16.7	10.2	17.5	9.8
	64.4	9.7	7.8	11.3	8.6	13.2	9.6	14.0	9.8	14.8	9.8	16.7	10.2	17.1	9.6
	68	9.7	7.8	11.3	8.6	13.2	9.6	14.0	9.8	14.8	9.8	16.7	10.2	16.8	9.4
	69.8	9.7	7.8	11.3	8.6	13.2	9.6	14.0	9.8	14.8	9.8	16.7	10.2	16.5	9.3
	73.4	9.7	7.8	11.3	8.6	13.2	9.6	14.0	9.8	14.8	9.8	16.4	10.2	16.4	9.2
	77	9.7	7.8	11.3	8.6	13.2	9.6	14.0	9.8	14.8	9.8	16.2	10.1	16.2	9.1
	80.6	9.7	7.8	11.3	8.6	13.2	9.6	14.0	9.8	14.8	9.8	16.1	10.0	16.1	9.2
	84.2	9.7	7.8	11.3	8.6	13.2	9.6	14.0	9.8	14.8	9.8	16.0	9.9	16.0	9.1
	87.8	9.7	7.8	11.3	8.6	13.2	9.6	14.0	9.8	14.8	9.8	15.8	9.8	15.4	8.8
	91.4	9.7	7.8	11.3	8.6	13.2	9.6	14.0	9.8	14.8	9.8	15.7	9.7	15.4	8.8

Indoor Unit size (kW)	Outdoor temperature (°FDB)	Indoor temperature (°FWB/DB)													
		57.2/68		60.8/73.4		64.4/78.8		66.2/80.6		68/82.4		71.6/86		75.2/89.6	
		TC	SC	TC	SC	TC	SC	TC	SC	TC	SC	TC	SC	TC	SC
		kW	kW	kW	kW	kW	kW	kW	kW	kW	kW	kW	kW	kW	kW
14.0	95	9.7	7.8	11.3	8.6	13.2	9.6	14.0	9.8	14.7	9.7	15.1	9.4	15.1	8.8
	98.6	9.7	7.8	11.3	8.6	13.2	9.6	14.0	9.8	14.6	9.6	15.1	9.4	15.0	8.7
	102.2	9.7	7.8	11.3	8.6	13.2	9.6	14.0	9.8	14.3	9.4	14.6	9.2	15.0	8.8
	107.6	9.7	7.8	11.3	8.6	13.2	9.6	14.0	9.8	14.3	9.4	14.6	9.2	15.0	8.8
	111.2	9.7	7.8	11.3	8.6	13.2	9.6	14.0	9.8	14.3	9.4	14.6	9.2	15.0	8.8
	114.8	9.7	7.8	11.3	8.6	13.2	9.6	14.0	9.8	14.3	9.4	14.6	9.2	15.0	8.8



8.2 Heating

TC: total capacity **WB:** wet-bulb temperature **DB:** dry-bulb temperature

Indoor Unit size(kW)	Outdoor temperature (°F)		Indoor temperature (°F DB)						
			60.8	64.4	68	69.8	71.6	75.2	
	WB	DB	TC	TC	TC	TC	TC	TC	
2.2	-3.64	-4	1.4	1.4	1.4	1.4	1.4	1.4	1.4
	-1.84	-2.2	1.5	1.5	1.5	1.5	1.5	1.5	1.5
	1.94	1.4	1.6	1.6	1.6	1.6	1.6	1.6	1.6
	7.34	5	1.6	1.6	1.6	1.6	1.6	1.6	1.6
	10.76	8.6	1.7	1.7	1.7	1.7	1.7	1.7	1.7
	14.36	12.2	1.8	1.8	1.8	1.8	1.8	1.8	1.8
	14.9	14	1.9	1.9	1.9	1.9	1.9	1.9	1.9
	16.7	15.62	1.9	1.9	1.9	1.9	1.9	1.9	1.9
	19.4	18.32	1.9	1.9	1.9	1.9	1.9	1.9	1.9
	23	21.92	2.0	2.0	2.0	2.0	2.0	2.0	2.0
	26.6	25.34	2.1	2.1	2.1	2.1	2.1	2.1	2.1
	32	30.74	2.3	2.3	2.3	2.3	2.3	2.3	2.1
	37.4	35.96	2.4	2.4	2.4	2.4	2.3	2.1	2.1
	41	39.38	2.5	2.5	2.5	2.5	2.3	2.1	2.1
	44.6	42.8	2.6	2.6	2.6	2.5	2.3	2.1	2.1
	48.2	46.22	2.6	2.6	2.6	2.5	2.3	2.1	2.1
51.8	49.64	2.7	2.7	2.6	2.5	2.3	2.1	2.1	
55.4	53.24	2.8	2.8	2.6	2.5	2.3	2.1	2.1	
59	56.66	2.9	2.8	2.6	2.5	2.3	2.1	2.1	
2.8	-3.64	-4	1.7	1.7	1.7	1.7	1.7	1.7	1.7
	-1.84	-2.2	1.9	1.9	1.9	1.9	1.9	1.9	1.9
	1.94	1.4	2.0	2.0	2.0	2.0	2.0	2.0	2.0
	7.34	5	2.0	2.0	2.0	2.0	2.0	2.0	2.0
	10.76	8.6	2.1	2.1	2.1	2.1	2.1	2.1	2.1
	14.36	12.2	2.2	2.2	2.2	2.2	2.2	2.2	2.2
	14.9	14	2.3	2.3	2.3	2.3	2.3	2.3	2.3
	16.7	15.62	2.4	2.4	2.4	2.4	2.4	2.4	2.4
	19.4	18.32	2.4	2.4	2.4	2.4	2.4	2.4	2.4
	23	21.92	2.5	2.5	2.5	2.5	2.5	2.5	2.5
	26.6	25.34	2.6	2.6	2.6	2.6	2.6	2.6	2.6
	32	30.74	2.8	2.8	2.8	2.8	2.8	2.6	2.6
	37.4	35.96	3.0	3.0	3.0	3.0	2.9	2.6	2.6
	41	39.38	3.1	3.1	3.1	3.1	2.9	2.6	2.6
	44.6	42.8	3.2	3.2	3.2	3.1	2.9	2.6	2.6
	48.2	46.22	3.3	3.3	3.2	3.1	2.9	2.6	2.6
51.8	49.64	3.3	3.3	3.2	3.1	2.9	2.6	2.6	
55.4	53.24	3.5	3.4	3.2	3.1	2.9	2.6	2.6	
59	56.66	3.6	3.4	3.2	3.1	2.9	2.6	2.6	
3.6	-3.64	-4	2.2	2.2	2.2	2.2	2.2	2.2	2.2
	-1.84	-2.2	2.4	2.4	2.4	2.4	2.4	2.4	2.4
	1.94	1.4	2.5	2.5	2.5	2.5	2.5	2.5	2.5
	7.34	5	2.6	2.6	2.6	2.6	2.6	2.6	2.6
	10.76	8.6	2.6	2.6	2.6	2.6	2.6	2.6	2.6
	14.36	12.2	2.8	2.8	2.8	2.8	2.8	2.8	2.8
	14.9	14	2.9	2.9	2.9	2.9	2.9	2.9	2.9
	16.7	15.62	3.0	3.0	3.0	3.0	3.0	3.0	3.0
	19.4	18.32	3.0	3.0	3.0	3.0	3.0	3.0	3.0
	23	21.92	3.1	3.1	3.1	3.1	3.1	3.1	3.1
	26.6	25.34	3.3	3.3	3.3	3.3	3.3	3.3	3.3
	32	30.74	3.5	3.5	3.5	3.5	3.5	3.3	3.3
	37.4	35.96	3.7	3.7	3.7	3.7	3.6	3.3	3.3
	41	39.38	3.8	3.8	3.8	3.8	3.6	3.3	3.3
	44.6	42.8	4.0	4.0	4.0	3.8	3.6	3.3	3.3
	48.2	46.22	4.1	4.1	4.0	3.8	3.6	3.3	3.3
51.8	49.64	4.2	4.2	4.0	3.8	3.6	3.3	3.3	
55.4	53.24	4.4	4.3	4.0	3.8	3.6	3.3	3.3	
59	56.66	4.5	4.3	4.0	3.8	3.6	3.3	3.3	
4.5	-3.64	-4	2.8	2.8	2.8	2.8	2.8	2.8	2.8
	-1.84	-2.2	3.0	3.0	3.0	3.0	3.0	3.0	3.0
	1.94	1.4	3.1	3.1	3.1	3.1	3.1	3.1	3.1

Indoor Unit size(kW)	Outdoor temperature (°F)		Indoor temperature (°F DB)					
			60.8	64.4	68	69.8	71.6	75.2
	WB	DB	TC	TC	TC	TC	TC	TC
			kW	kW	kW	kW	kW	kW
4.5	7.34	5	3.2	3.2	3.2	3.2	3.2	3.2
	10.76	8.6	3.3	3.3	3.3	3.3	3.3	3.3
	14.36	12.2	3.5	3.5	3.5	3.5	3.5	3.5
	14.9	14	3.6	3.6	3.6	3.6	3.6	3.6
	16.7	15.62	3.7	3.7	3.7	3.7	3.7	3.7
	19.4	18.32	3.8	3.8	3.8	3.8	3.8	3.8
	23	21.92	3.9	3.9	3.9	3.9	3.9	3.9
	26.6	25.34	4.1	4.1	4.1	4.1	4.1	4.1
	32	30.74	4.4	4.4	4.4	4.4	4.4	4.2
	37.4	35.96	4.7	4.7	4.7	4.7	4.6	4.2
	41	39.38	4.8	4.8	4.8	4.8	4.6	4.2
	44.6	42.8	5.0	5.0	5.0	4.8	4.6	4.2
	48.2	46.22	5.1	5.1	5.0	4.8	4.6	4.2
	51.8	49.64	5.3	5.3	5.0	4.8	4.6	4.2
	55.4	53.24	5.5	5.4	5.0	4.8	4.6	4.2
59	56.66	5.6	5.4	5.0	4.8	4.6	4.2	
5.6	-3.64	-4	3.5	3.5	3.5	3.5	3.5	3.5
	-1.84	-2.2	3.7	3.7	3.7	3.7	3.7	3.7
	1.94	1.4	3.9	3.9	3.9	3.9	3.9	3.9
	7.34	5	4.1	4.1	4.1	4.1	4.1	4.1
	10.76	8.6	4.2	4.2	4.2	4.2	4.2	4.2
	14.36	12.2	4.4	4.4	4.4	4.4	4.4	4.4
	14.9	14	4.6	4.6	4.6	4.6	4.6	4.6
	16.7	15.62	4.7	4.7	4.7	4.7	4.7	4.7
	19.4	18.32	4.7	4.7	4.7	4.7	4.7	4.7
	23	21.92	4.9	4.9	4.9	4.9	4.9	4.9
	26.6	25.34	5.2	5.2	5.2	5.2	5.2	5.2
	32	30.74	5.6	5.6	5.6	5.6	5.6	5.2
	37.4	35.96	5.9	5.9	5.9	5.9	5.8	5.2
	41	39.38	6.1	6.1	6.1	6.1	5.8	5.2
	44.6	42.8	6.3	6.3	6.3	6.1	5.8	5.2
48.2	46.22	6.4	6.4	6.3	6.1	5.8	5.2	
51.8	49.64	6.6	6.6	6.3	6.1	5.8	5.2	
55.4	53.24	6.9	6.8	6.3	6.1	5.8	5.2	
59	56.66	7.1	6.8	6.3	6.1	5.8	5.2	
7.1	-3.64	-4	4.4	4.4	4.4	4.4	4.4	4.4
	-1.84	-2.2	4.8	4.8	4.8	4.8	4.8	4.8
	1.94	1.4	5.0	5.0	5.0	5.0	5.0	5.0
	7.34	5	5.2	5.2	5.2	5.0	5.2	5.2
	10.76	8.6	5.3	5.3	5.3	5.3	5.3	5.3
	14.36	12.2	5.6	5.6	5.6	5.6	5.6	5.6
	14.9	14	5.8	5.8	5.8	5.8	5.8	5.8
	16.7	15.62	6.0	6.0	6.0	6.0	6.0	6.0
	19.4	18.32	6.0	6.0	6.0	6.0	6.0	6.0
	23	21.92	6.3	6.3	6.3	6.3	6.3	6.3
	26.6	25.34	6.6	6.6	6.6	6.6	6.6	6.6
	32	30.74	7.1	7.1	7.1	7.1	7.1	6.7
	37.4	35.96	7.5	7.5	7.5	7.5	7.3	6.7
	41	39.38	7.7	7.7	7.7	7.7	7.3	6.7
	44.6	42.8	8.0	8.0	8.0	7.7	7.3	6.7
48.2	46.22	8.2	8.2	8.0	7.7	7.3	6.7	
51.8	49.64	8.4	8.4	8.0	7.7	7.3	6.7	
55.4	53.24	8.8	8.6	8.0	7.7	7.3	6.7	
59	56.66	9.0	8.6	8.0	7.7	7.3	6.7	
8.0	-3.64	-4	5.0	5.0	5.0	5.0	5.0	5.0
	-1.84	-2.2	5.4	5.4	5.4	5.4	5.4	5.4
	1.94	1.4	5.6	5.6	5.6	5.6	5.6	5.6
	7.34	5	5.8	5.8	5.8	5.8	5.8	5.8
	10.76	8.6	6.0	6.0	6.0	6.0	6.0	6.0
	14.36	12.2	6.3	6.3	6.3	6.3	6.3	6.3
	14.9	14	6.5	6.5	6.5	6.5	6.5	6.5
	16.7	15.62	6.7	6.7	6.7	6.7	6.7	6.7

Indoor Unit size(kW)	Outdoor temperature (°F)		Indoor temperature (°F DB)					
			60.8	64.4	68	69.8	71.6	75.2
			TC	TC	TC	TC	TC	TC
	WB	DB	kW	kW	kW	kW	kW	kW
8.0	19.4	18.32	6.8	6.8	6.8	6.8	6.8	6.8
	23	21.92	7.1	7.1	7.1	7.1	7.1	7.1
	26.6	25.34	7.4	7.4	7.4	7.4	7.4	7.4
	32	30.74	8.0	8.0	8.0	8.0	8.0	7.5
	37.4	35.96	8.4	8.4	8.4	8.4	8.2	7.5
	41	39.38	8.7	8.7	8.7	8.7	8.2	7.5
	44.6	42.	9.0	9.0	9.0	8.7	8.2	7.5
	48.2	46.22	9.2	9.2	9.0	8.7	8.2	7.5
	51.8	49.64	9.5	9.5	9.0	8.7	8.2	7.5
	55.4	53.24	9.	9.7	9.0	8.7	8.2	7.5
	59	56.66	10.17	9.7	9.0	8.7	8.2	7.5
9.0	-3.64	-4	5.6	5.0	5.6	5.6	5.6	5.6
	-1.84	-2.2	6.0	5.4	6.0	6.0	6.0	6.0
	1.94	1.4	6.3	6.3	6.3	6.3	6.3	6.3
	7.34	5	6.5	6.5	6.5	6.5	6.5	6.5
	10.76	8.6	6.7	6.7	6.7	6.7	6.7	6.7
	14.36	12.2	7.0	7.0	7.0	7.0	7.0	7.0
	14.9	14	7.3	7.3	7.3	7.3	7.3	7.3
	16.7	15.62	7.5	7.5	7.5	7.5	7.5	7.5
	19.4	18.32	7.6	7.6	7.6	7.6	7.6	7.6
	23	21.92	7.9	7.9	7.9	7.9	7.9	7.9
	26.6	25.34	8.3	8.3	8.3	8.3	8.3	8.3
	32	30.74	8.9	8.9	8.9	8.9	8.9	8.4
	37.4	35.96	9.4	9.4	9.4	9.4	9.2	8.4
	41	39.38	9.7	9.7	9.7	9.7	9.2	8.4
	44.6	42.8	10.00	10.00	10.00	9.7	9.2	8.4
	48.2	46.22	10.30	10.30	10.00	9.7	9.2	8.4
	51.8	49.64	10.60	10.60	10.00	9.7	9.2	8.4
55.4	53.24	11.00	10.80	10.00	9.7	9.2	8.4	
59	56.66	11.30	10.80	10.00	9.7	9.2	8.4	
11.2	-3.64	-4	7.0	7.0	7.0	7.0	7.0	7.0
	-1.84	-2.2	7.5	7.5	7.5	7.5	7.5	7.5
	1.94	1.4	7.8	7.8	7.8	7.8	7.8	7.8
	7.34	5	8.1	8.1	8.1	8.1	8.1	8.1
	10.76	8.6	8.3	8.3	8.3	8.3	8.3	8.3
	14.36	12.2	8.7	8.7	8.7	8.7	8.7	8.7
	14.9	14	9.1	9.1	9.1	9.1	9.1	9.1
	16.7	15.62	9.3	9.3	9.3	9.3	9.3	9.3
	19.4	18.32	9.5	9.5	9.5	9.5	9.5	9.5
	23	21.92	9.8	9.8	9.8	9.8	9.8	9.8
	26.6	25.34	10.38	10.38	10.38	10.38	10.38	10.38
	32	30.74	11.13	11.13	11.13	11.13	11.13	10.50
	37.4	35.96	11.75	11.75	11.75	11.75	11.50	10.50
	41	39.38	12.13	12.13	12.13	12.13	11.50	10.50
	44.6	42.8	12.50	12.50	12.50	12.13	11.50	10.50
	48.2	46.22	12.88	12.88	12.50	12.13	11.50	10.50
	51.8	49.64	13.25	13.25	12.50	12.13	11.50	10.50
55.4	53.24	13.75	13.50	12.50	12.13	11.50	10.50	
59	56.66	14.13	13.50	12.50	12.13	11.50	10.50	
14.0	-3.64	-4	8.6	8.6	8.6	8.6	8.6	8.6
	-1.84	-2.2	9.3	9.3	9.3	9.3	9.3	9.3
	1.94	1.4	9.7	9.7	9.7	9.7	9.7	9.7
	7.34	5	10.08	10.08	10.08	10.08	10.08	10.08
	10.76	8.6	10.40	10.40	10.40	10.40	10.40	10.40
	14.36	12.2	10.90	10.90	10.90	10.90	10.90	10.90
	14.9	14	11.30	11.30	11.30	11.30	11.30	11.30
	16.7	15.62	11.60	11.60	11.60	11.60	11.60	11.60
	19.4	18.32	11.80	11.80	11.80	11.80	11.80	11.80
	23	21.92	12.30	12.30	12.30	12.30	12.30	12.30
	26.6	25.34	12.90	12.90	12.90	12.90	12.90	12.90
	32	30.74	13.80	13.80	13.80	13.80	13.80	13.00
	37.4	35.96	14.60	14.60	14.60	14.60	14.30	13.00
	41	39.38	15.00	15.00	15.00	15.00	14.30	13.00

Indoor Unit size(kW)	Outdoor temperature k(°F)		Indoor temperature (°F DB)					
			60.8	64.4	68	69.8	71.6	75.2
	WB	DB	TC	TC	TC	TC	TC	TC
14.0	44.6	42.8	15.50	15.50	15.50	15.00	14.30	13.00
	48.2	46.22	16.00	16.00	15.50	15.00	14.30	13.00
	51.8	49.64	16.40	16.40	15.50	15.00	14.30	13.00
	55.4	53.24	17.10	16.70	15.50	15.00	14.30	13.00
	59	56.66	17.50	16.70	15.50	15.00	14.30	13.00



9. Electrical Characteristics

Model	Indoor Unit				Power Supply		IFM	
	Hz	Voltage	Min.	Max.	MCA	MFA	KW	FLA
MDV-D22T2/VN1-BA5	60	208-230	207	253	0.35	5	0.027	0.275
MDV-D28T2/VN1-BA5	60	208-230	207	253	0.35	5	0.027	0.275
MDV-D36T2/VN1-BA5	60	208-230	207	253	0.42	5	0.027	0.33
MDV-D45T2/VN1-BA5	60	208-230	207	253	0.64	5	0.047	0.51
MDV-D56T2/VN1-BA5	60	208-230	207	253	0.64	5	0.047	0.51
MDV-D71T2/VN1-BA5	60	208-230	207	253	1.06	5	0.056	0.85
MDV-D80T2/VN1-BA5	60	208-230	207	253	1.39	5	0.075	1.11
MDV-D90T2/VN1-BA5	60	208-230	207	253	1.39	5	0.075	1.11
MDV-D112T2/VN1-BA5	60	208-230	207	253	2.35	5	0.18	1.88
MDV-D140T2/VN1-BA5	60	208-230	207	253	1.99	5	0.145	1.59

Remark:

MCA: Min. Current Amps.

(A) MFA: Max. Fuse Amps.

(A)

KW: Fan Motor Rated Output

(kW) FLA: Full Load Amps. (A)

IFM: Indoor Fan Motor



Climaproyectos
.com

10. Sound Levels

10.1 Test condition

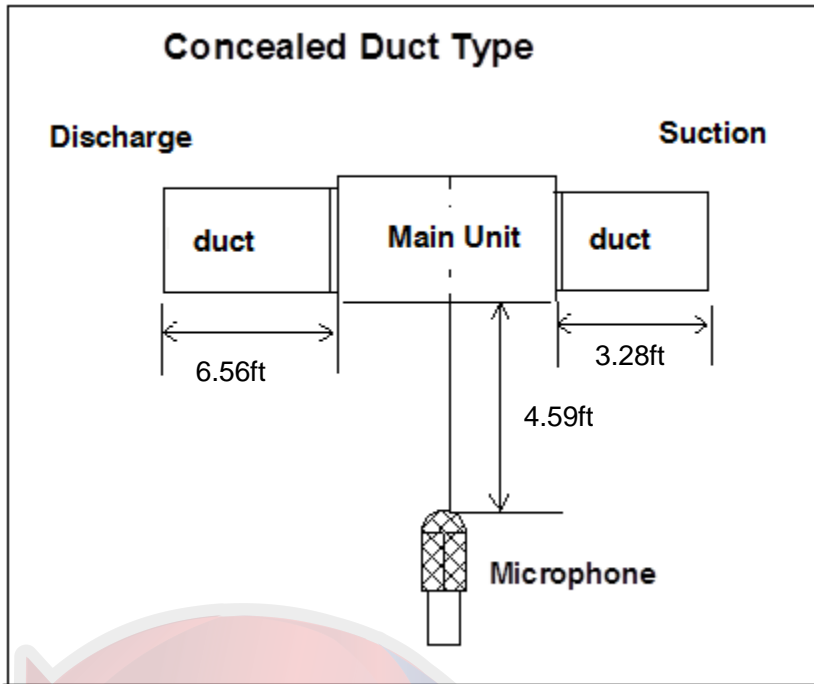

8000

10.2 Test value

Model	Noise test value dB(A)		
	H	M	L
MDV-D22T2/VN1-BA5	38	35	32
MDV-D28T2/VN1-BA5	38	35	32
MDV-D36T2/VN1-BA5	40	38	36
MDV-D45T2/VN1-BA5	41	38.9	36
MDV-D56T2/VN1-BA5	41	38.9	36
MDV-D71T2/VN1-BA5	42	40	36
MDV-D80T2/VN1-BA5	45.4	39.8	37
MDV-D90T2/VN1-BA5	45.4	39.8	37
MDV-D112T2/VN1-BA5	48.0	41.9	38
MDV-D140T2/VN1-BA5	47.7	43.2	39

MDV-D22(28)T2/VN1-BA5

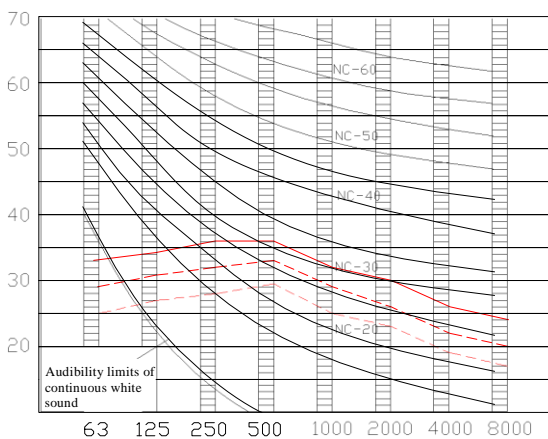

Octave band center frequency (Hz)

MDV-D36T2/VN1-BA5

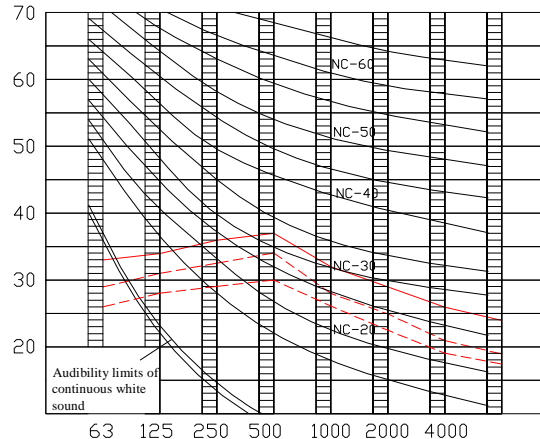

Octave band center frequency (Hz)

MDV-D45 (56)T2/VN1-BA5

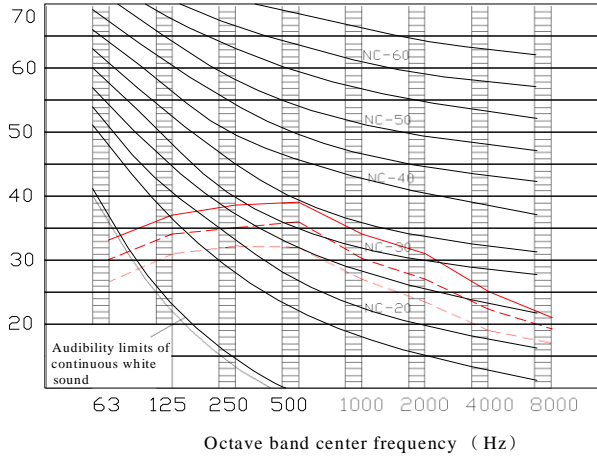

MDV-D71T2/VN1-BA5

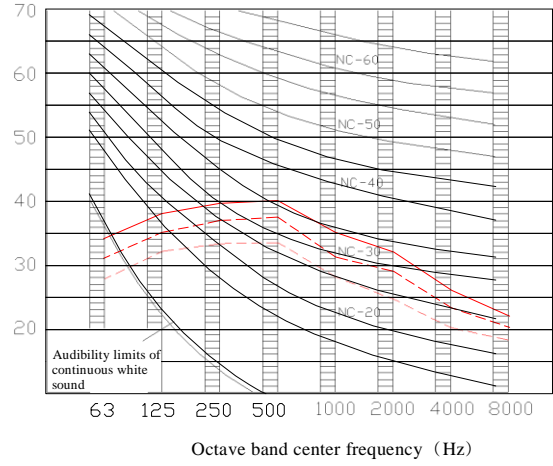

MDV-D80 (90)T2/VN1-BA5

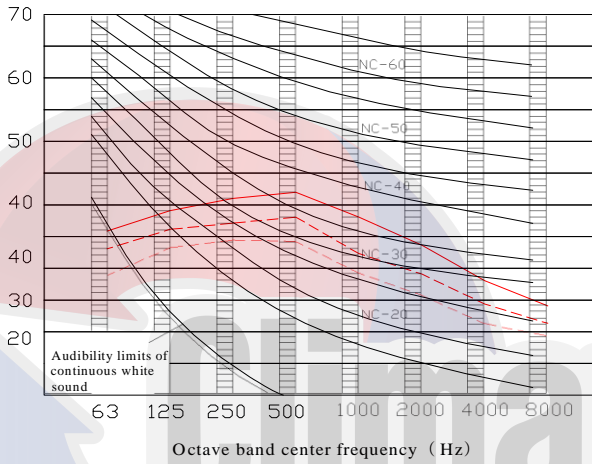

MDV-D112T2/VN1-BA5

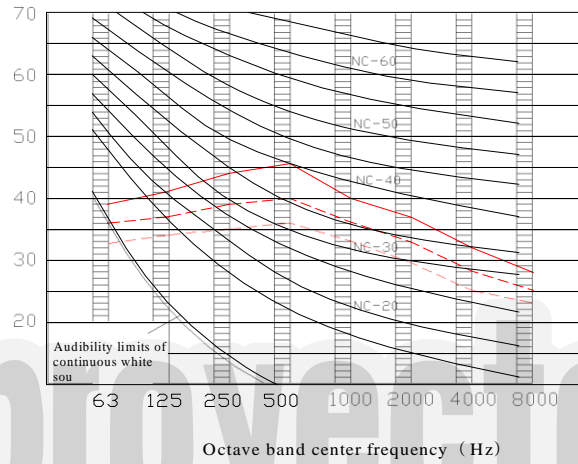



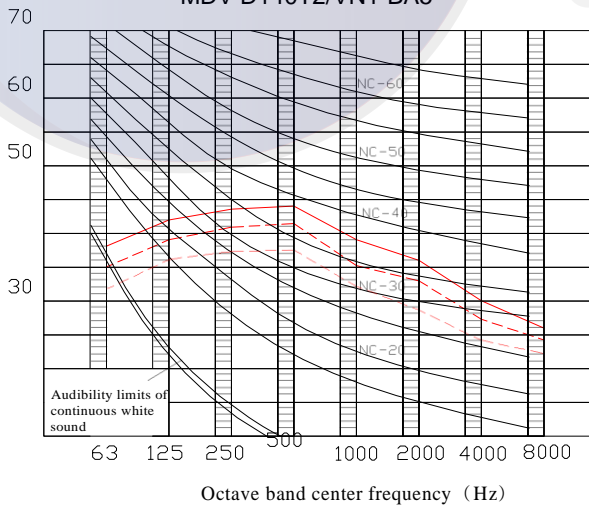



MDV-D140T2/VN1-BA5

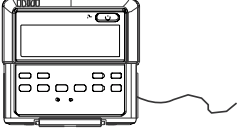
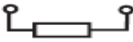

11. Accessories

11.1 Standard accessories

Name	Quantity	Shape	Usage
Installation manual	1	/	/
Pipe insulation material	2		Heat insulation
Adhesive tape for seal	2		To connect drain pipe
Wired controller	1		/
Network matching wire	1		The indoor unit with at the terminal of communication system should connect a impedance between port p and port Q
Water outlet joint	1		For drainage
Clasp	1		Chucking the joint which connect the drain hose and the outlet of indoor unit
Signal receiver display board (already fixed inside control box)	1		Receive signal

11.2 Optional accessories

Name	Model	Code	Usage
Wireless remote controller	RM05/BG(T)E-A	203355091418	Which can be used to set the indoor unit's address

High static pressure duct unit

1. Features	74
2. Specifications	76
3. Dimensions	79
4. Service Spaces	86
5. Piping Diagrams	87
6. Wiring Diagrams	88
7. Fan Performance	91
8. Capacity Tables	93
9. Electrical Characteristics	99
10. Sound Levels	100
11. Accessories	103

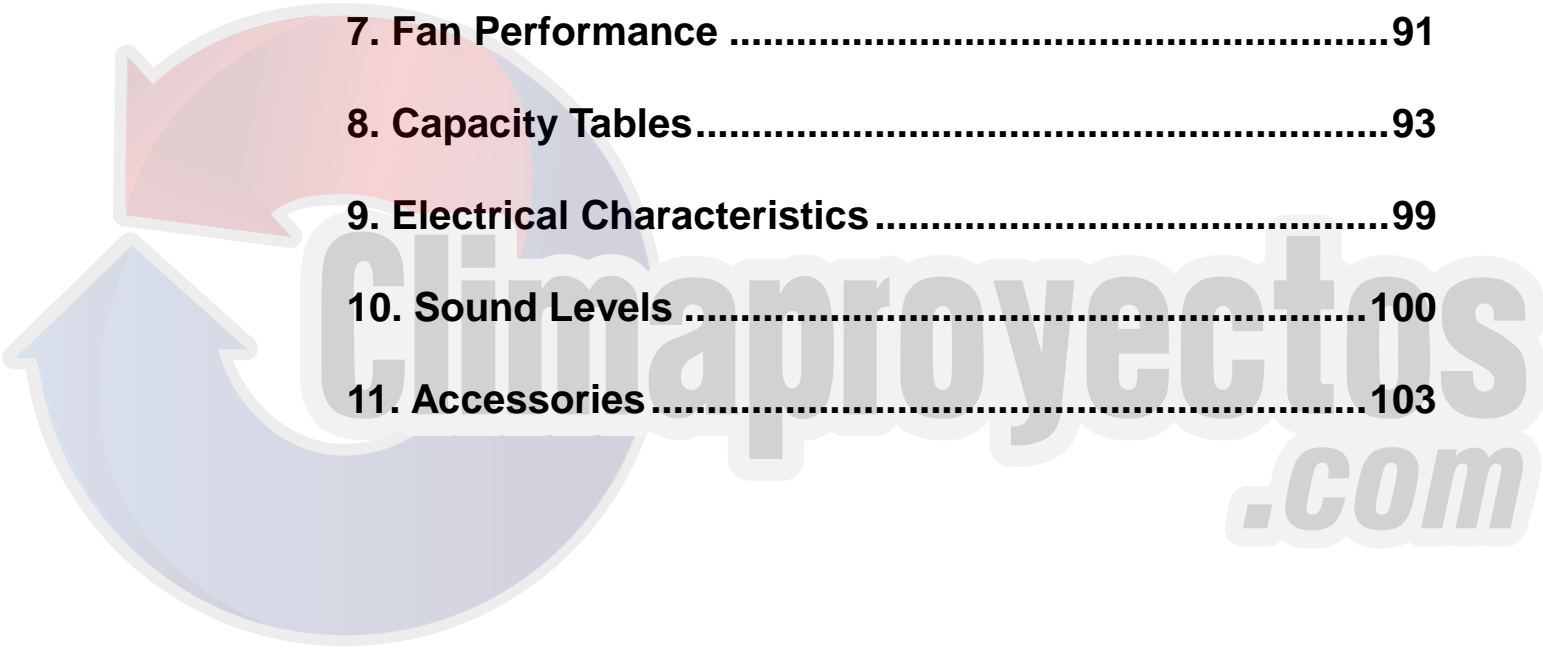

1. Features

1.1 High static pressure allows flexible duct design



1.1.1 External static pressure of Indoor Unit can be up to 280 Pa, which allows extensive duct work for flexible applications. So the cool air can be delivered to each corner even in a super-high ceiling.

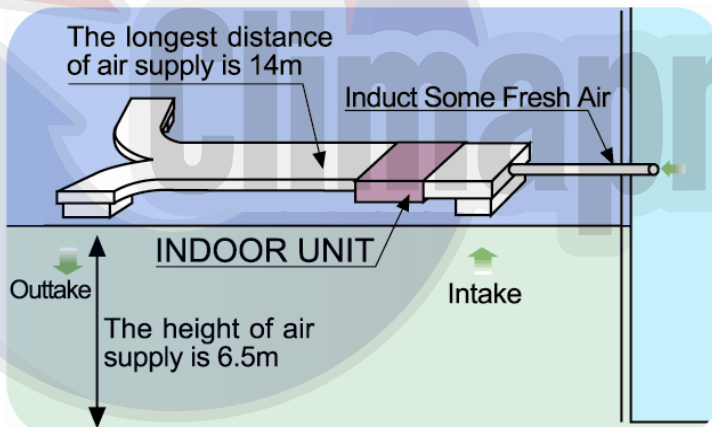

1.1.2 With 16-17/32in (420mm) (71~160 model) thickness body, the minimum distance above the ceiling is (17-23/32in) 450mm.

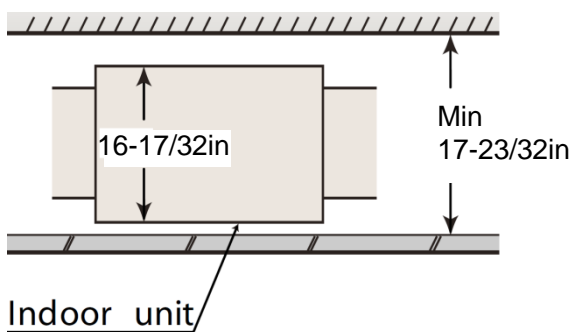

1.2 Wide capacity range

—The capacity ranges from (24200 Btu/h ~136520Btu/h)7.1KW to 45.0KW, totally 8 models.

1.3 Convenient installation

- 1.3.1 The EXV is fixed inside the indoor unit ((for 71~160 model), no need extra connection.
- 1.3.2 Standard filter with aluminum frame, which is removable downward from bottom.
- 1.3.3 Air plenum is included as standard equipment
- 1.3.4 Flange for air in/outlet duct connection is standard.
- 1.3.5 Optional drain pump(for 71~160 model)

Drain pump is equipped as optional accessory with 29-17/32in(750 mm) lift.

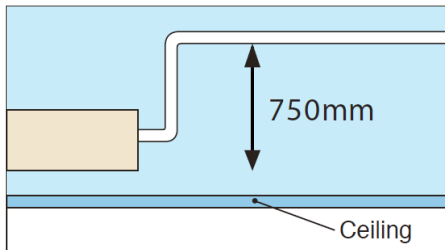

- 1.3.6 Easy to access the motor and do the maintenance. Possible to replace the motor without removing the whole unit.
- 1.3.7 Integrated electric control box structure which is convenient for maintenance and installation.

1.4 Flexible control and convenient for maintenance

- 1.4.1 Standard wired remote controller KJR-29B1/BK-E, and wireless remote controller RM05/BG(T)E-A is as an option.
- 1.4.2 For 71~160 model, the display board is connected with the E-box in factory, which makes trouble-shooting easier by LED display. For 400~450 model, it has a new display transfer board, which is used in indoor units to collect the information of control boards. If one board breaks down, the indoor units will stop and return the malfunction code.
- 1.4.3 Standard functional port such as remote On/Off dry contact.

2. Specifications

Model			MDV-D71T1/VN1-B	MDV-D80T1/VN1-B	MDV-D90T1/VN1-B
Power supply		V- Ph-Hz	208-230V~, 1Ph, 60Hz		
Cooling	Capacity	kW	7.1	8.0	9.0
		Btu/h	24200	27300	30700
	Input	W	414	402	409
	Rated current	A	1.9	1.9	2.01
Heating	Capacity	kW	8.0	9.0	10.0
		Btu/h	27300	30700	34100
	Input	W	414	402	409
	Rated current	A	1.9	1.9	2.01
Max. input consumption		W	420	420	420
Max. current		A	1.9	1.9	2.01
Indoor fan motor	Model		YDK160-4M	YDK160-4M	YDK200-6CB-1
	Type		AC Motor		
	Brand		WELLING	WELLING	WELLING
	Input	W	392	392	359
	Capacitor	μF	10μF/450V	10μF/450V	15μF/450V
	Speed (h/m/l)	r/min	1285/1210/1140	1285/1210/1140	1060/1030/935
	Indoor coil	Number of rows		2	2
Tube pitch(a) xrow pitch(b)		in.(mm)	1x7/8 (25.4x22)	1x7/8 (25.4x22)	1x7/8 (25.4x22)
Fin spacing		in.(mm)	1/16(1.5)	1/16(1.5)	1/16(1.5)
Fin type		Hydrophilic aluminum			
Tube outside diameter and type		in.(mm)	3/8(Φ9.53) inner groove tube		
lengthx height xwidth		in.(mm)	27-9/16x14-1/32x1-23/32 (700x356x44)		27-9/16x14-1/32x2-1/9/32 (700x356x66)
Number of circuits		3	3	7	
Indoor air flow (H/M/L)		m ³ /h	1720/1532/1338	1690/1560/1320	2252/2030/1610
		CFM	1012/902/788	994/918/777	1326/1195/948
*Indoor external static pressure (H)		Pa	25(25~ 196)	37(37~ 196)	37(37~ 196)
Indoor noise level (H/M/L)		dB(A)	48/46/44.5	48/46/44.5	52/49/47
Indoor unit	Dimension (WxHxD)	in.(mm)	37-31/64x16-17/32x27-11/64(952x420x690)		
	Packing (WxHxD)	in.(mm)	42-29/32x17-21/64x30-15/64(1090x440x768)		
	Net/Gross weight	lbs.(Kg)	102.5/114.6 (46.5/52)	102.5/114.6 (46.5/52)	110/124.5 (50/56.5)
Refrigerant type			R410A		
Throttle	Type		Electronic expansion valve		
	Model		BD20FKS(Winding: DZF20XQ-1000-XHP-6)		
Design pressure (H/L)		MPa	4.4/2.6		
Refrigerant piping	Liquid / Gas	in.(mm)	Φ3/8, Φ5/8 (Φ9.53/ Φ15.9)	Φ3/8, Φ5/8 (Φ9.53/ Φ15.9)	
Connecting wiring	Power wiring	mm ²	3x2.5(L≤20m); 3x3.5(L≤50m)		
	Signal wiring	mm ²	3x0.75		
Drainage water pipe diameter		in.(mm)	OD 63/64 (Φ25)		
Controller			Wired controller KJR-29B1/BK-E (6 meters connection wire)		

Notes: 1. Nominal cooling capacities are based on the following conditions: return air temperature : 80.6°F(27°C)DB, 66.2°F(19°C)WB, outdoor air temperature:95°F(35°C)DB, equivalent ref. Piping: 26.25ft(8m)(horizontal).

2. Nominal heating capacities are based on the following conditions: return air temperature: 68°F(20°C)DB, outdoor air temperature: 44.6°F(7°C)DB,42.8°F(6°C)WB, equivalent ref. Piping: 26.25ft(8m)(horizontal).

3. *This is the available static pressure range which means the unit can run stably in this static pressure range, and the optimal static pressure range please refers to the Installation Manual. When choosing any static pressure which is out of optimal static pressure range, risk like bigger noise, lower air flow volume etc. should be considered in advanced.

Model		MDV-D112T1/VN1-B	MDV-D140T1/VN1-B	MDV-D160T1/VN1-B	
Power supply		V- Ph-Hz	208-230V~, 1Ph, 60Hz		
Cooling	Capacity	kW	11.2	14.0	16.0
		Btu/h	38200	47800	51200
	Input	W	409	527	532
	Rated current	A	2.03	2.31	2.2
Heating	Capacity	kW	12.5	16.0	16.5
		Btu/h	42700	54600	56400
	Input	W	409	527	532
	Rated current	A	2.03	2.31	2.2
Max. input consumption		W	528	660	891
Max. current		A	2.03	2.31	2.31
Indoor fan motor	Model		YDK200-6CB-1	YSK300-6M-2	YSK300-6M-2
	Type		AC MOTOR		
	Brand		WELLING	WELLING	WELLING
	Input	W	405	508	508
	Capacitor	μF	15μF/450V	10μF/450V	10μF/450V
	Speed (h/m/l)	r/min	1060/1030/935	985/930/865	985/930/865
Indoor coil	Number of rows		3	4	4
	Tube pitch(a) x row pitch(b)	in.(mm)	1x7/8 (25.4x22)	1x7/8 (25.4x22)	1x7/8 (25.4x22)
	Fin spacing	in.(mm)	1/16(1.6)	1/16(1.6)	1/16(1.6)
	Fin type		Hydrophilic aluminum		
	Tube outside diameter and type	in.(mm)	3/8(Φ9.53) inner groove tube		
	length x height x width	in.(mm)	27-9/16x14-1/32x2-19/32 (700x356x66)	39-7/32x14x3-15/32 (996x355.6x88)	
	Number of circuits		7	7	7
	Indoor air flow (H/M/L)	m ³ /h	2198/1978/1570	2969/2694/2469	2969/2694/2469
CFM		1294/1164/924	1746/1586/1453	1746/1586/1453	
*Indoor external static pressure	Pa	50(50~ 196)	50(50~ 196)	50(50~ 196)	
Indoor noise level (H/M/L)	dB(A)	52/49/47	53/50/48	54/52/50	
Indoor unit	Dimension (WxHxD)	in.(mm)	37-15/32x16-17/32x27-5/32 (952x420x690)	51-3/16x15-3/4x27-5/32(1300x420x690)	
	Packing (WxHxD)	in.(mm)	42-29/32x17-21/64x30-15/64 (1090x440x768)	56-17/32x17-23/32x30-15/64 (1436x450x768)	
	Net/Gross weight	lbs.(Kg)	110.3/124.6(50/56.5)	149.9/154.3(68/70)	153.3/167.6(69.5/76)
Refrigerant type		R410A			
Throttle	Type	Electronic expansion valve			
	Model	BD20FKS(L)(Winding: DZF20XQ-1000-XHP-6)			
Design pressure(H/L)	MPa	4.4/2.6			
Refrigerant piping	Liquid	in.(mm)	Φ3/8,Φ5/8(Φ9.53/15.9)	Φ3/8,Φ5/8(Φ9.53/Φ15.9)	
Connecting wiring	Power	mm ²	3x2.5(L≤20m); 3x3.5(L≤50m)		
	Signal	mm ²	3x0.75		
Drainage water pipe diameter	in.(mm)	OD 63/64 (Φ25)			
Controller		Wired controller KJR-29B1/BK-E (6 meters connection wire)			

Notes: 1. Nominal cooling capacities are based on the following conditions: return air temperature : 80.6°F(27°C)DB, 66.2°F(19°C)WB, outdoor air temperature:95°F(35°C)DB, equivalent ref. Piping: 26.25ft(8m)(horizontal)

2. Nominal heating capacities are based on the following conditions: return air temperature: 68°F(20°C)DB, outdoor air temperature: 44.6°F(7°C)DB,42.8°F(6°C)WB, equivalent ref. Piping: 26.25ft(8m)(horizontal)

3. *This is the available static pressure range which means the unit can run stably in this static pressure range, and the optimal static pressure range please refers to the Installation Manual. When choosing any static pressure which is out of optimal static pressure range, risk like bigger noise, lower air flow volume etc. should be considered in advanced.

Model			MDV-D400T1/N1	MDV-D450T1/N1
Power supply		V- Ph-Hz	208-230V~, 1Ph, 60Hz	
Cooling	Capacity	kW	40	45
		Btu/h	136500	153500
	Input	W	1600	1600
	Rated current	A	7.5	7.5
Heating	Capacity	kW	45	50
		Btu/h	153580	170650
	Input	W	1600	1600
	Rated current	A	7.5	7.5
Max. input consumption		W	1680	1680
Max. current		A	9	9
Indoor fan motor	Model		YDK520-6B(x3)	YDK520-6B(x3)
	Type		AC MOTOR	
	Brand		YongAn	
	Input	W	1650	1650
	Capacitor	μF	20μF/450V (x3)	20μF/450V (x3)
	Speed (h/m/l)	r/min	1050/1000/850(x3)	1050/1000/850(x3)
Indoor coil	Number of rows		5	5
	Tube pitch(a) × row pitch(b)	in.(mm)	53/64×17/32 (21×13.37)	53/64×17/32 (21×13.37)
	Fin spacing	in.(mm)	1/16(1.5)	1/16(1.5)
	Fin type		Hydrophilic aluminum coil	
	Tube outside diameter and type	in.(mm)	9/32(Φ7) inner groove tube	
	length× height ×width	in.(mm)	63-5/64×23-5/32×2-41/64 (1602×588×67)	
	Number of circuits		28	28
Indoor air flow (H/M/L)	m ³ /h		7180/6150/4600	7180/6150/4600
	CFM		4226/3620/2708	4226/3620/2708
*Indoor external static pressure (H)	Pa		200(50~280)	200(50~280)
Indoor noise level (H/M/L)		dB(A)	61/59/56	61/59/56
Indoor unit	Dimension (W×H×D)		77-9/16×15-3/4×35-17/32(1970×668×902.5)	
	Packing (W×H×D)		82-31/64×31-1/2×37-61/64 (2095×800×964)	
	Net/Gross weight		518/551(235/250)	
Refrigerant type			R410A	
Throttle	Type		Electronic expansion valve (4 sets throttle boxes each unit)	
	Model		BD24FKS(L)	BD24FKS(L)
Design pressure(H/L)		MPa	4.4/2.6	
Refrigerant	Liquid / Gas	in.(mm)	Φ3/8, Φ7/8(x2) (Φ9.53/Φ22.2)(x2)	
Connecting wiring	Power wiring	mm ²	3×2.5(L≤20m); 3×3.5(L≤50m)	
	Signal wiring	mm ²	3×0.75	3×0.75
Drainage water pipe diameter		in.(mm)	OD 1-17/64 (Φ32)	
Controller			Wired controller KJR-29B1/BK-E (6 meters connection) wire)	

Notes: 1. Nominal cooling capacities are based on the following conditions: return air temperature: 80.6°F(27°C)DB, 66.2°F(19°C)WB, outdoor air temperature:95°F(35°C)DB, equivalent ref. Piping: 26.25ft(8m)(horizontal)
2. Nominal heating capacities are based on the following conditions: return air temperature: 68°F(20°C)DB, outdoor air temperature: 44.6°F(7°C)DB,42.8°F(6°C)WB, equivalent ref. Piping: 26.25ft(8m)(horizontal)
3. *This is the available static pressure range which means the unit can run stably in this static pressure range, and the optimal static pressure range please refers to the Installation Manual. When choosing any static pressure which is out of optimal static pressure range, risk like bigger noise, lower air flow volume etc. should be considered in advanced.

3. Dimensions

MDV-D71T1/VN1-B MDV-D80T1/VN1-B MDV-D90T1/VN1-B MDV-D112T1/VN1-B
 Front view, top view and rear view: Unit:in (mm)

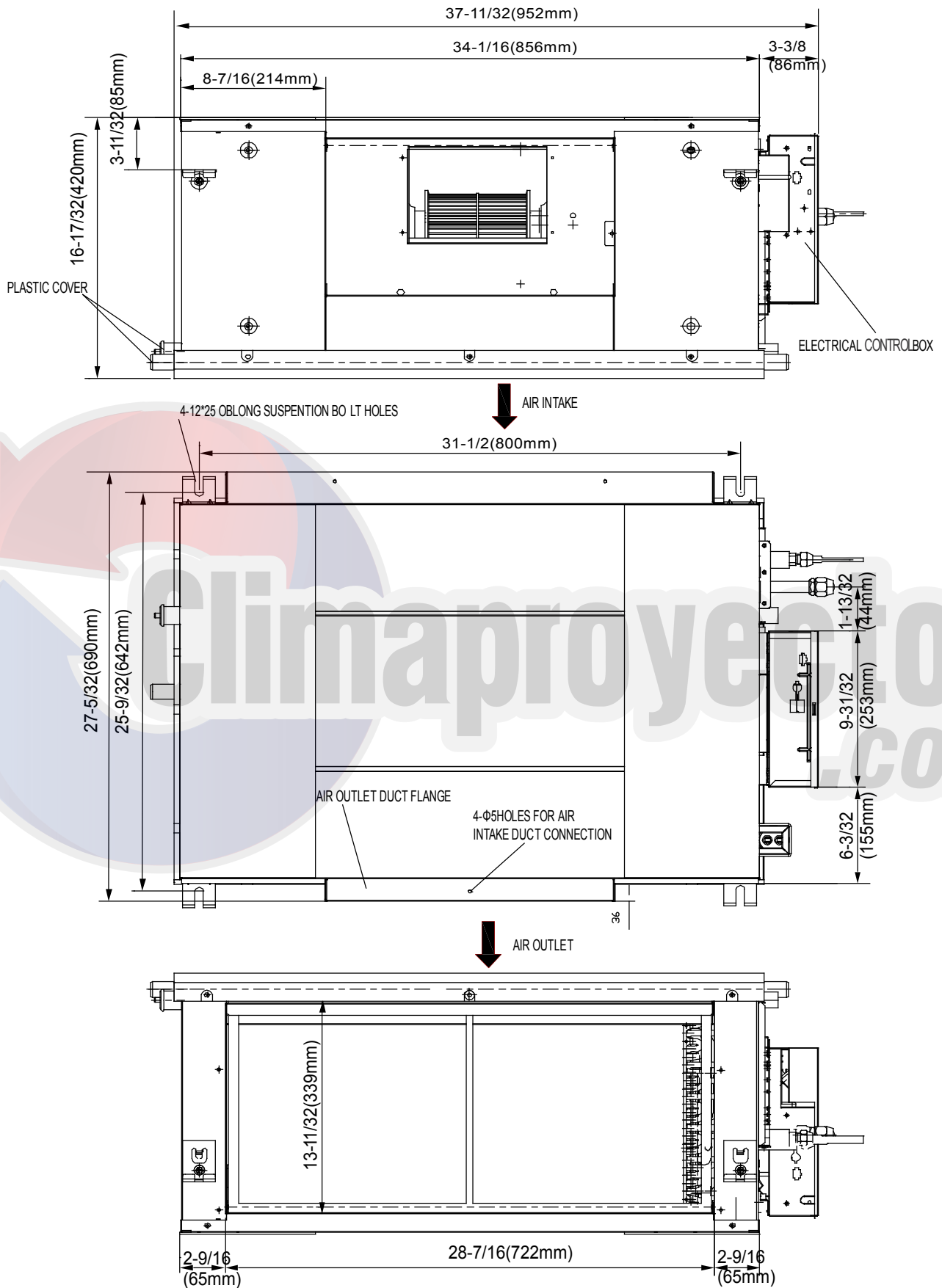

Side view:

- **Left side**

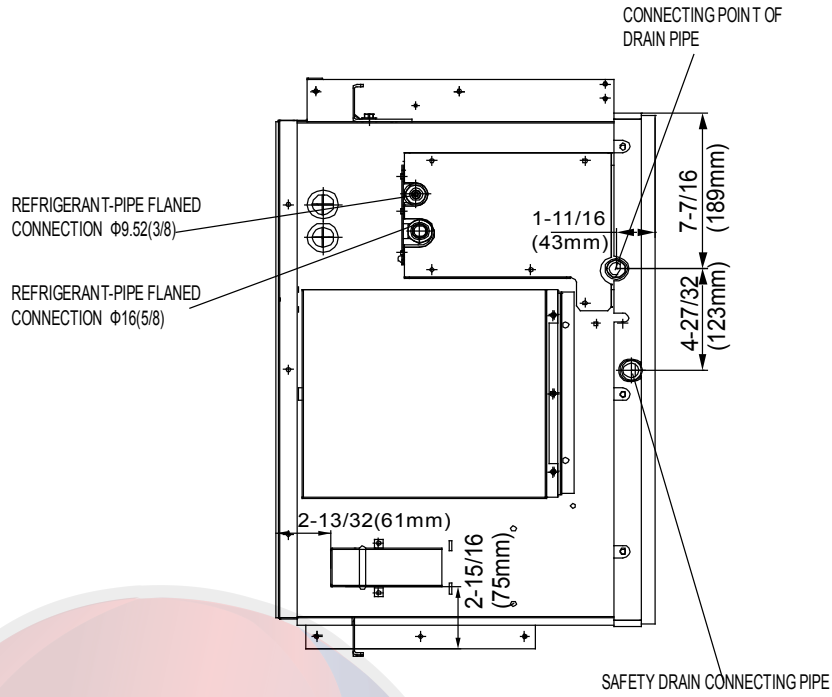

- **Right side**

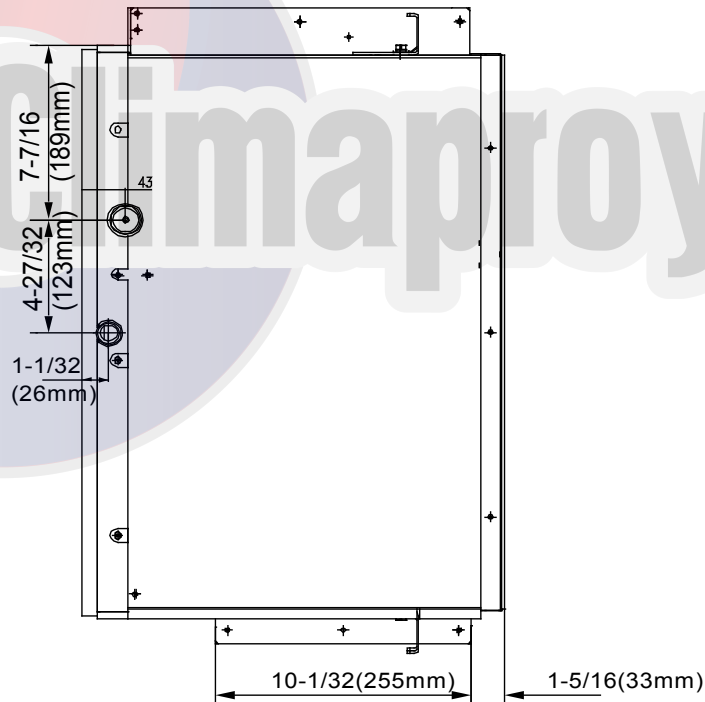

MDV-D140T1/VN1-B MDV-D160T1/VN1-B

Front view, top view and rear view:

Unit: in(mm)

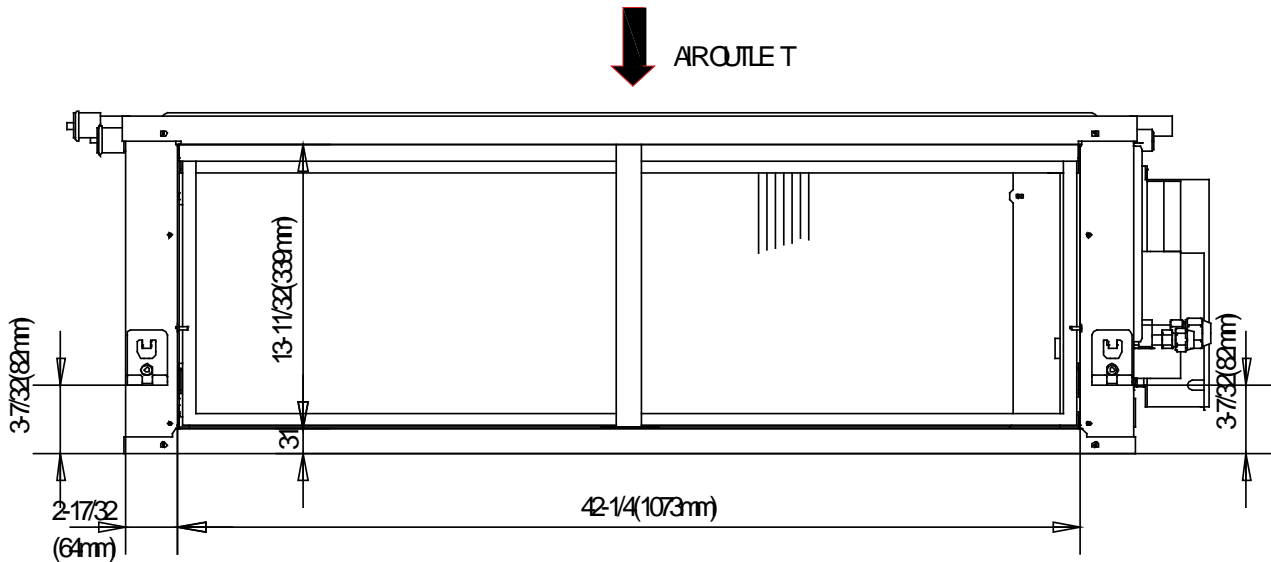
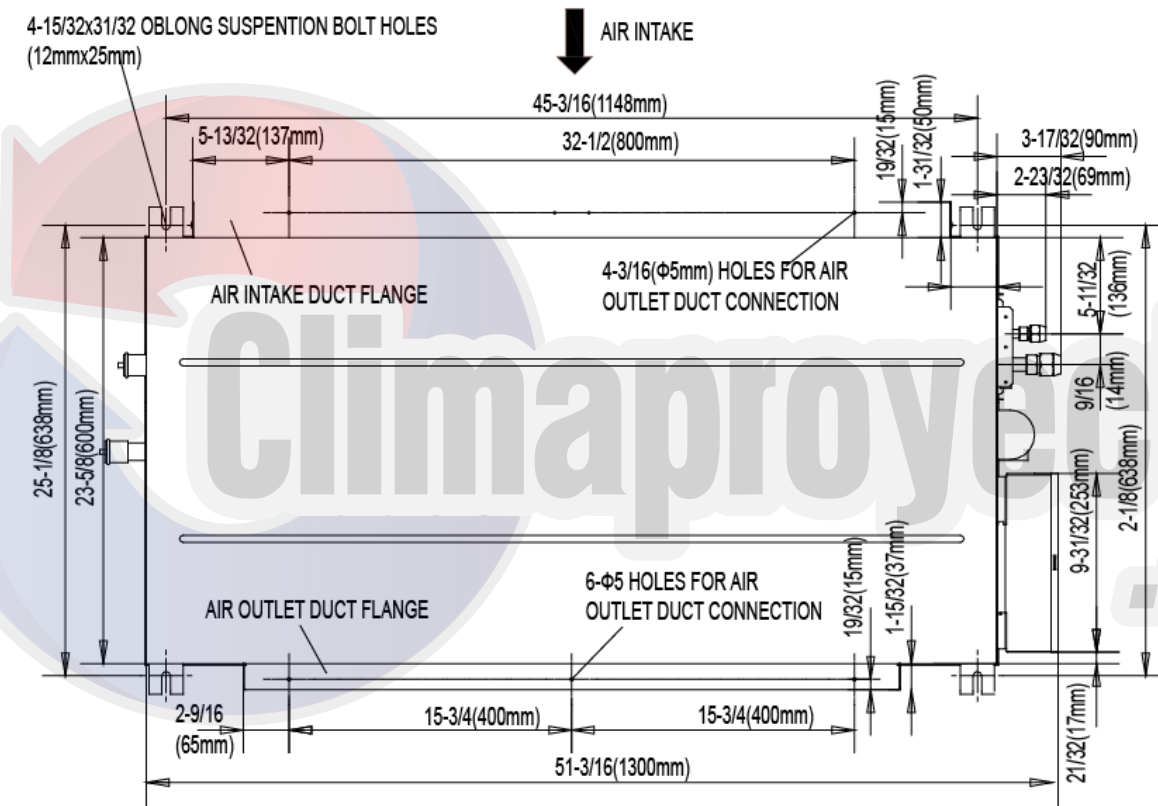
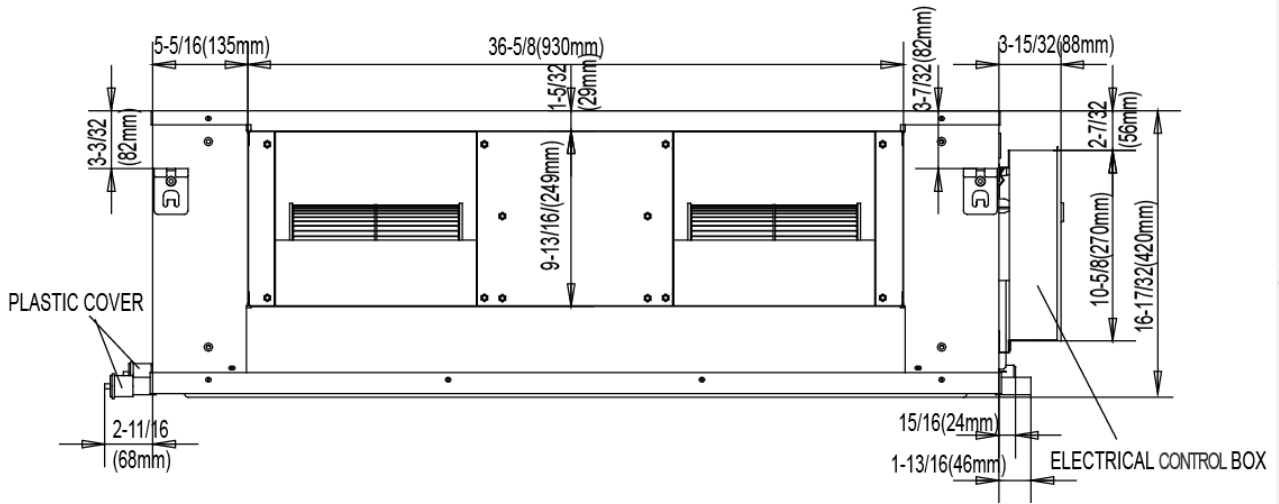

Side view:

- **Left side**

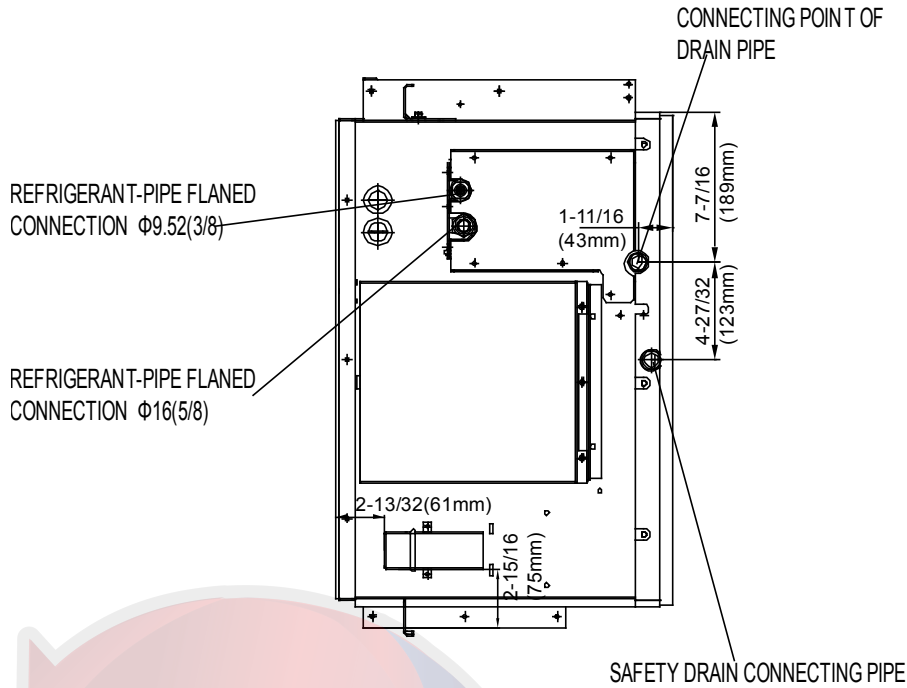

- **Right side**

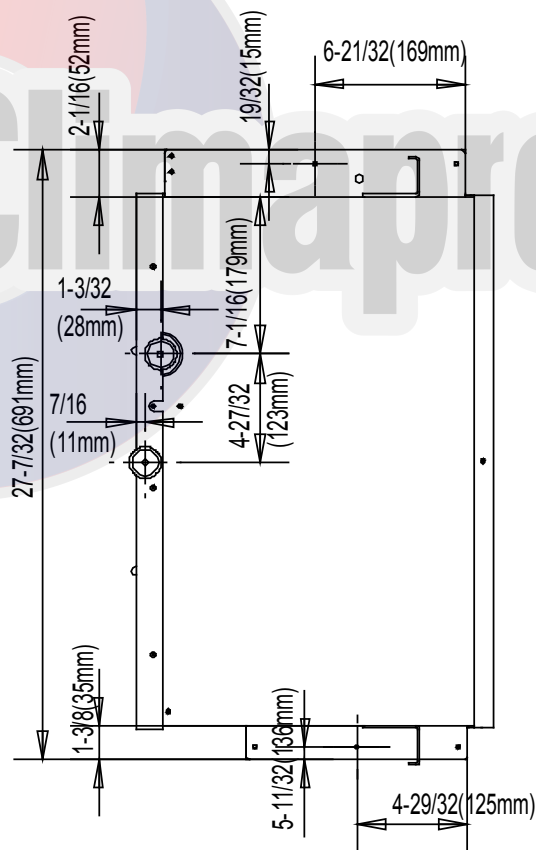

MDV-D400T1/N1 MDV-D450T1/N1

Unit: in(mm)

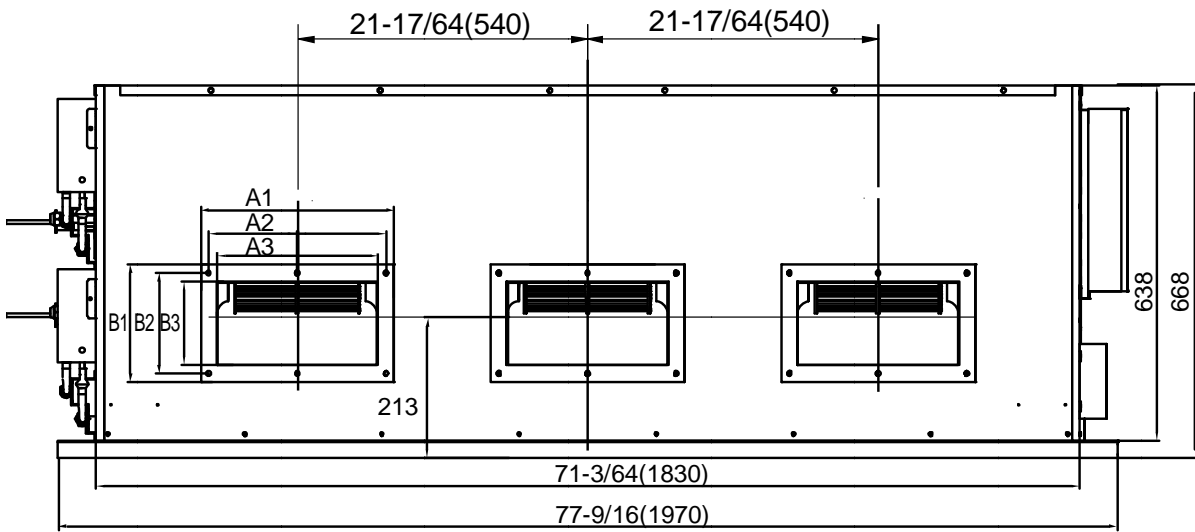

Front View (Air supply outlet)

	MDV-D400T1/N1 (50HZ)	MDV-D450T1/N1 (50HZ)	MDV-D400T1/N1 (60HZ)	MDV-D450T1/N1 (60HZ)
A1	14-11/64(360)		15-33/64(394)	
A2	12-63/64(330)		14-21/64(364)	
A3	11-13/16(300)		13-5/32(334)	
B1	8-17/64(210)		9-23/32(247)	
B2	7-3/32(180)		8-35/64(217)	
B3	5-29/32(150)		7-23/64(187)	

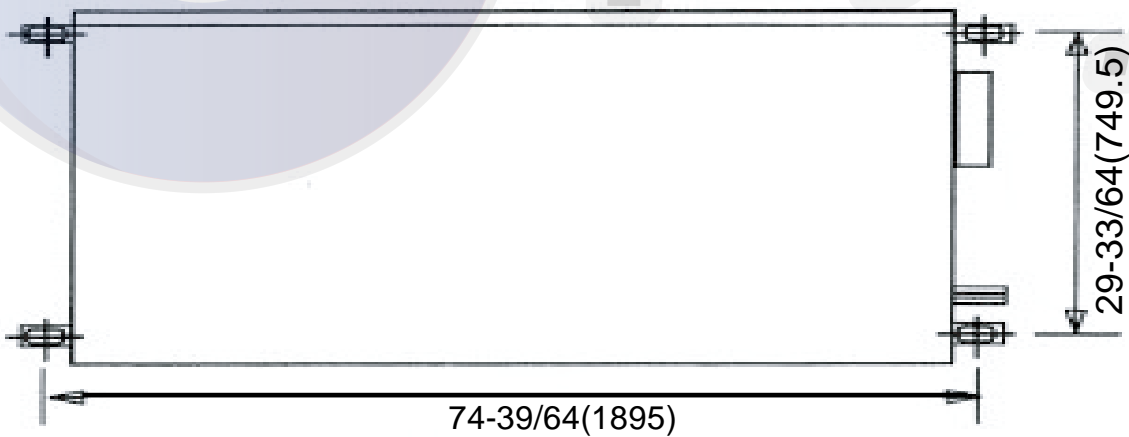

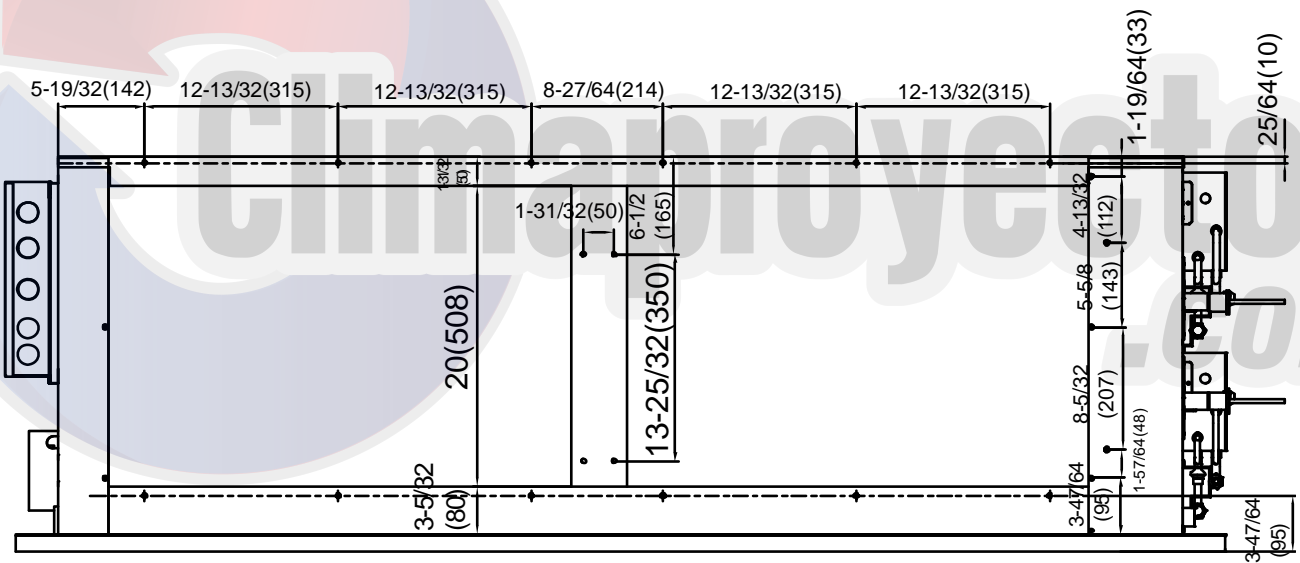
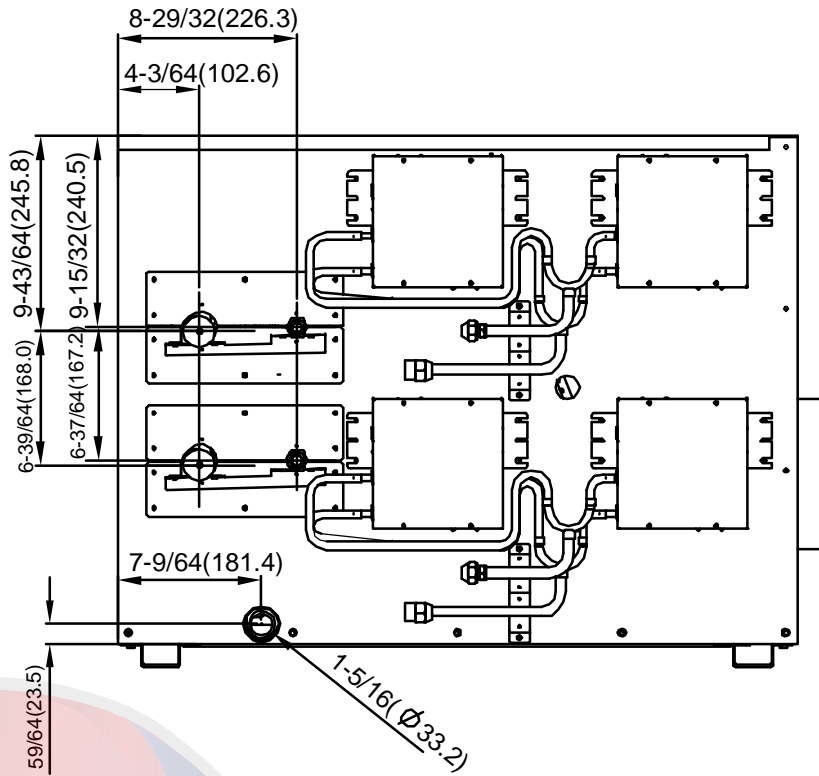

Rear view (Air return vent)

Key points about the 400,450model installation:

There're four sets of EXV boxes in 400& 450 model , as well two groups of pipes (Gas/Liquid), it's necessary to connect the two gas pipes together with the attached branch header BY101N1, as well the liquid pipes.

The branch header (1 set) already includes 1 gas and 1 liquid branch joint. Please kindly check the accessory and follow the instructions while install the indoor units and piping.

For 400 & 450 model

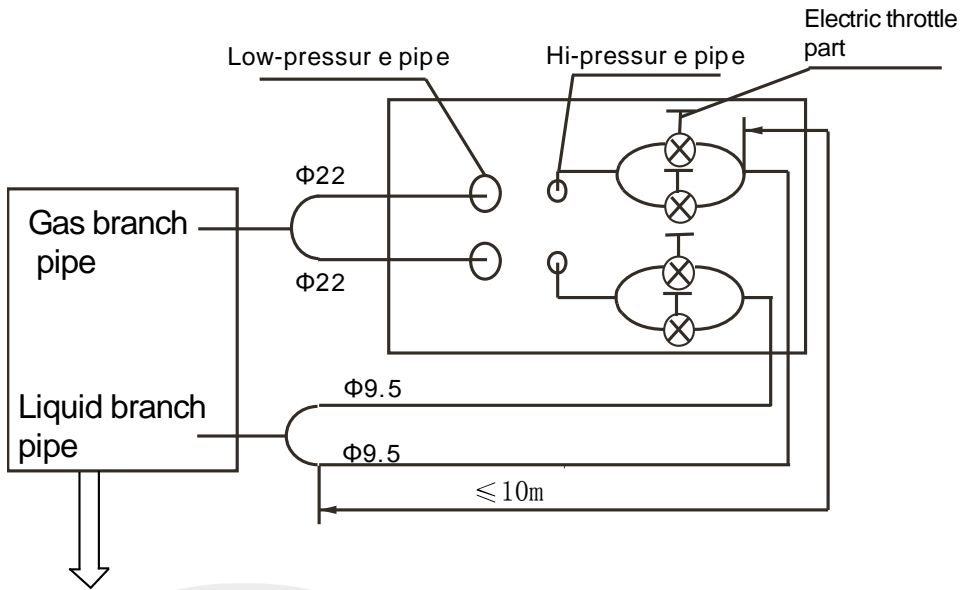

The piping diameter please refer to the manual of the outdoor unit you choose.

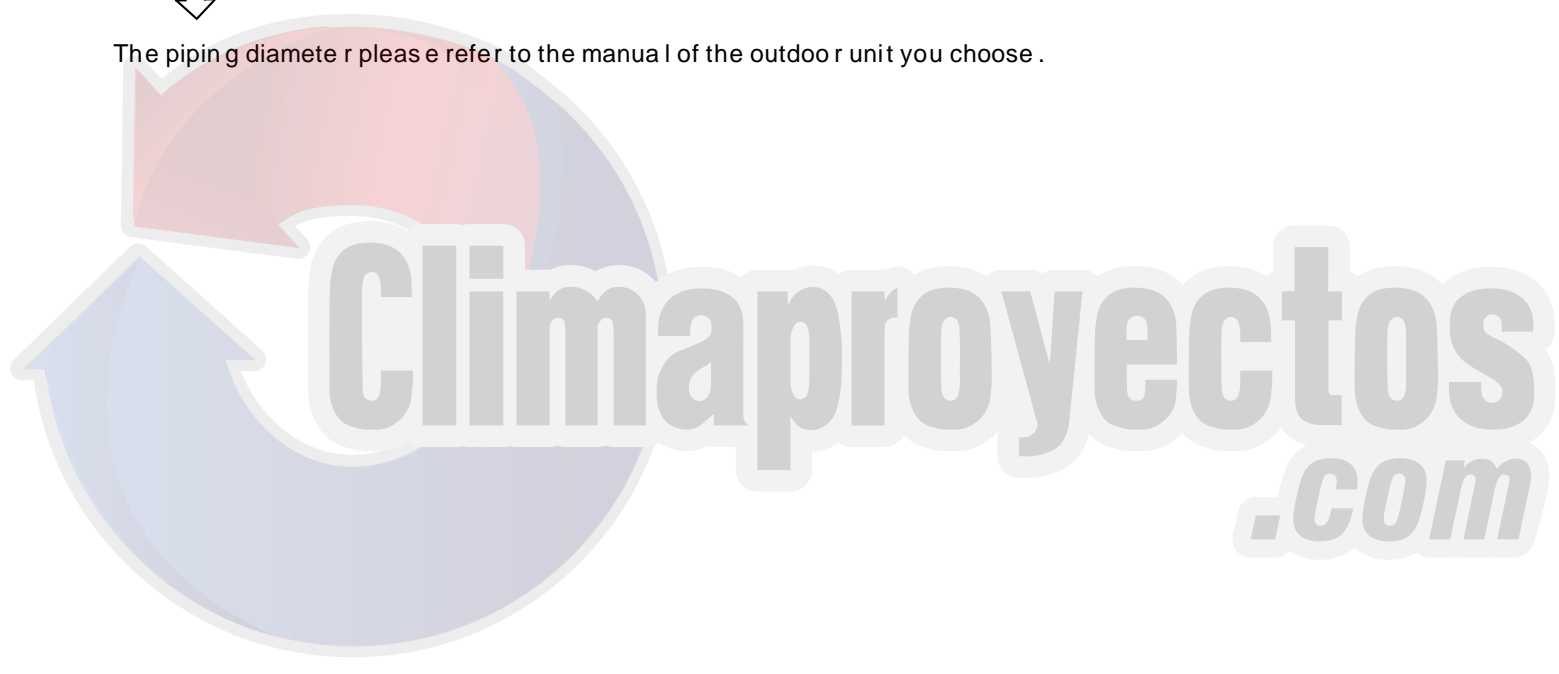

4. Service Spaces

- Ensure the needed spaces for installation and maintenance.
- The ceiling is horizontal, and its structure can endure the weight of the indoor unit.
- The outlet and the inlet are not impeded, and the influence of external air is the least.
- The air flow can reach throughout the room.
- The connecting pipe and drainpipe could be extracted out easily.
- There is no direct radiation from heaters.
- **Below is the recommended duct installation method:**

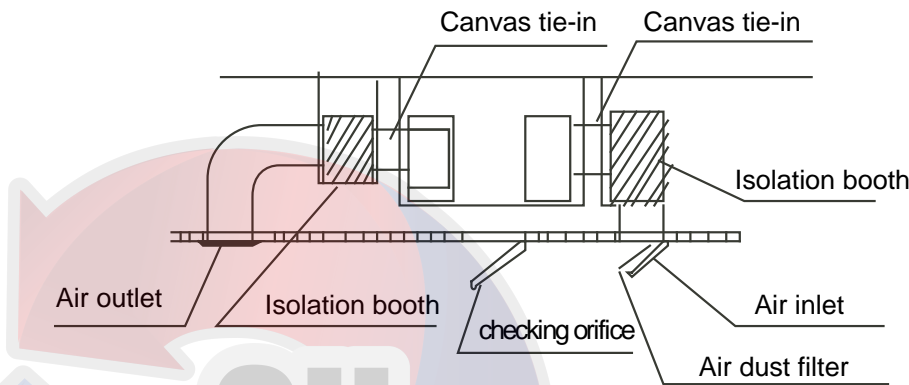

- **Keep min. 600*600 space for checking & maintenance:**

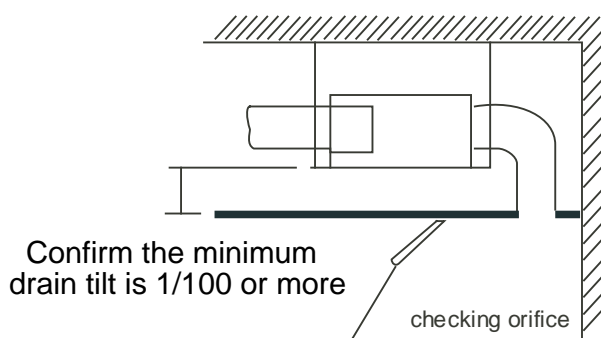
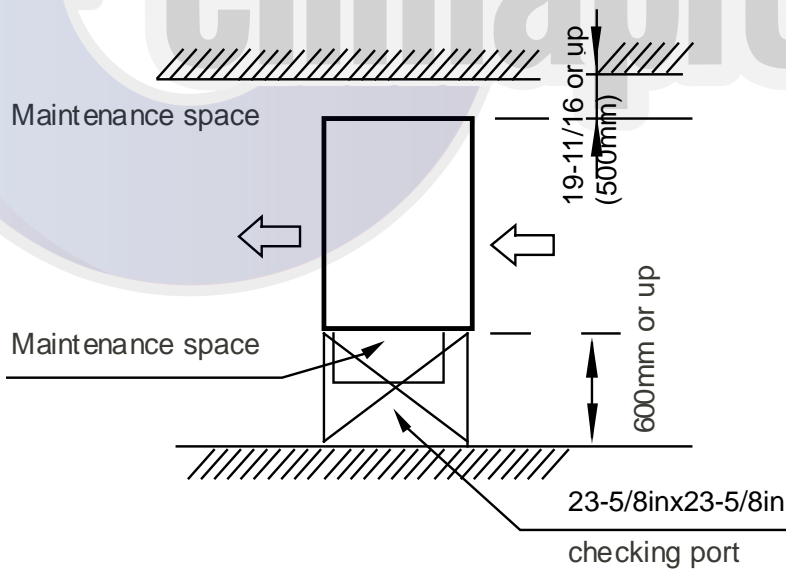

5. Piping Diagrams

MDV-D71T1/VN1-B MDV-D80T1/VN1-B MDV-D90T1/VN1-B MDV-D112T1/VN1-B
 MDV-D140T1/VN1-B MDV-D160T1/VN1-B

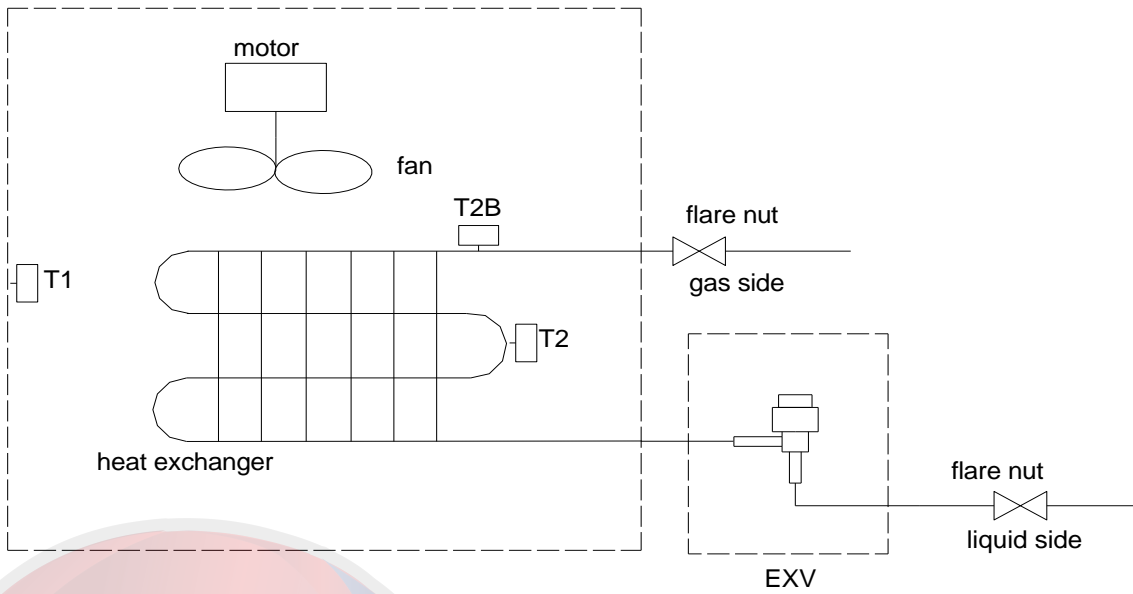

MDV-D400T1/N1 & MDV-D450T1/N1

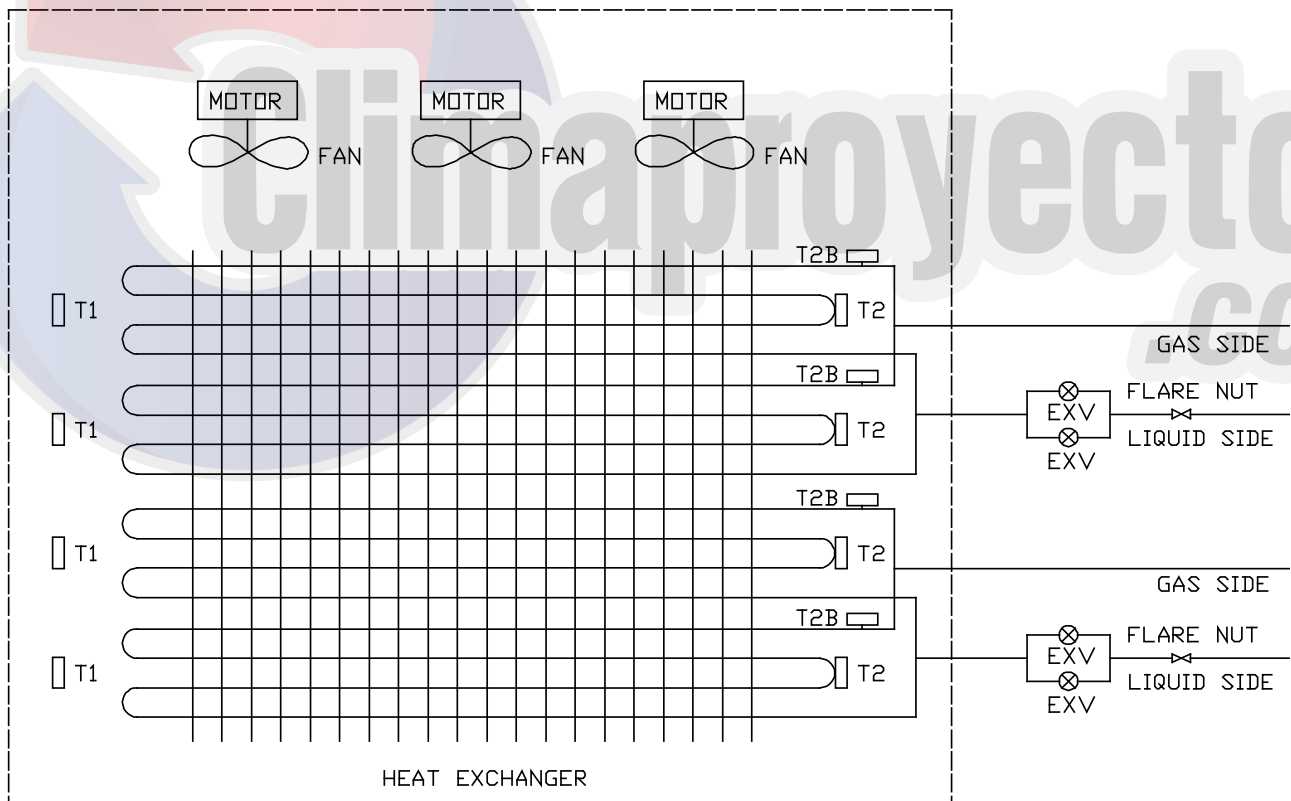

6. Wiring Diagrams

MDV-D71T1/VN1-B, MDV-D80T1/VN1-B, MDV-D90T1/VN1-B, MDV-D112T1/VN1-B

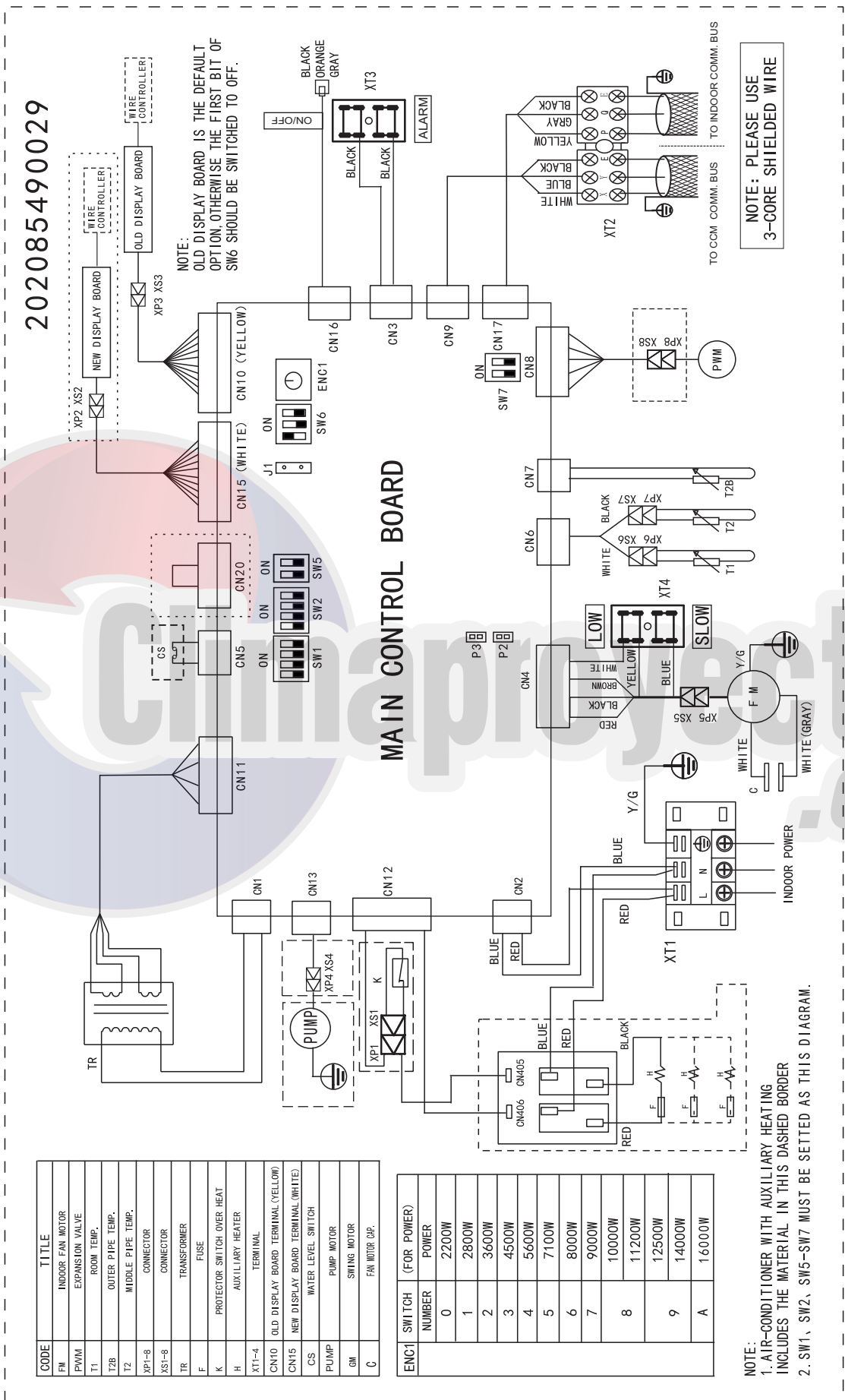

MDV-D140T1/VN1-B, MDV-D160T1/VN1-B

202085790015

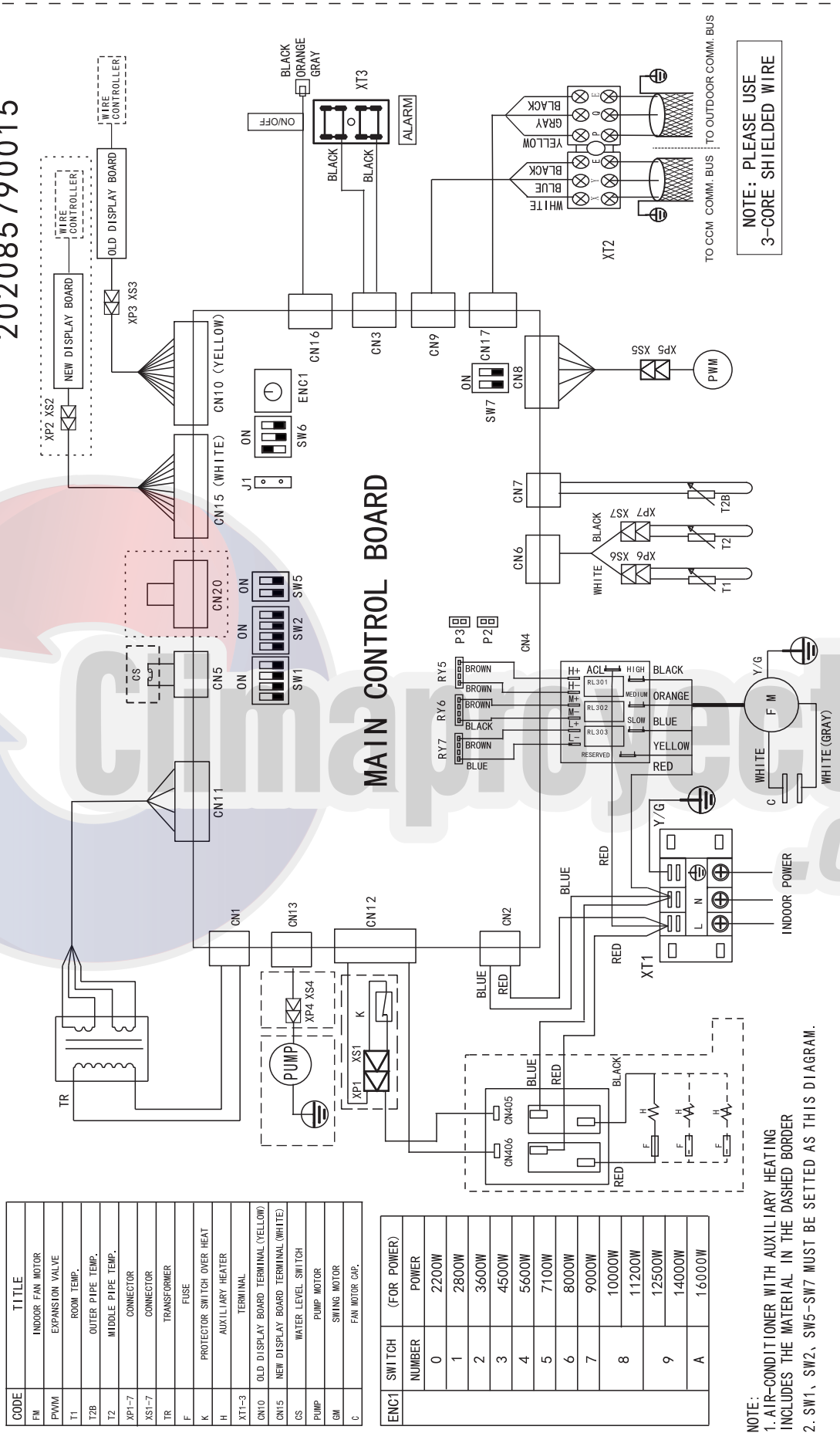

MDV-D400T1/N1, MDV-D450T1/N1

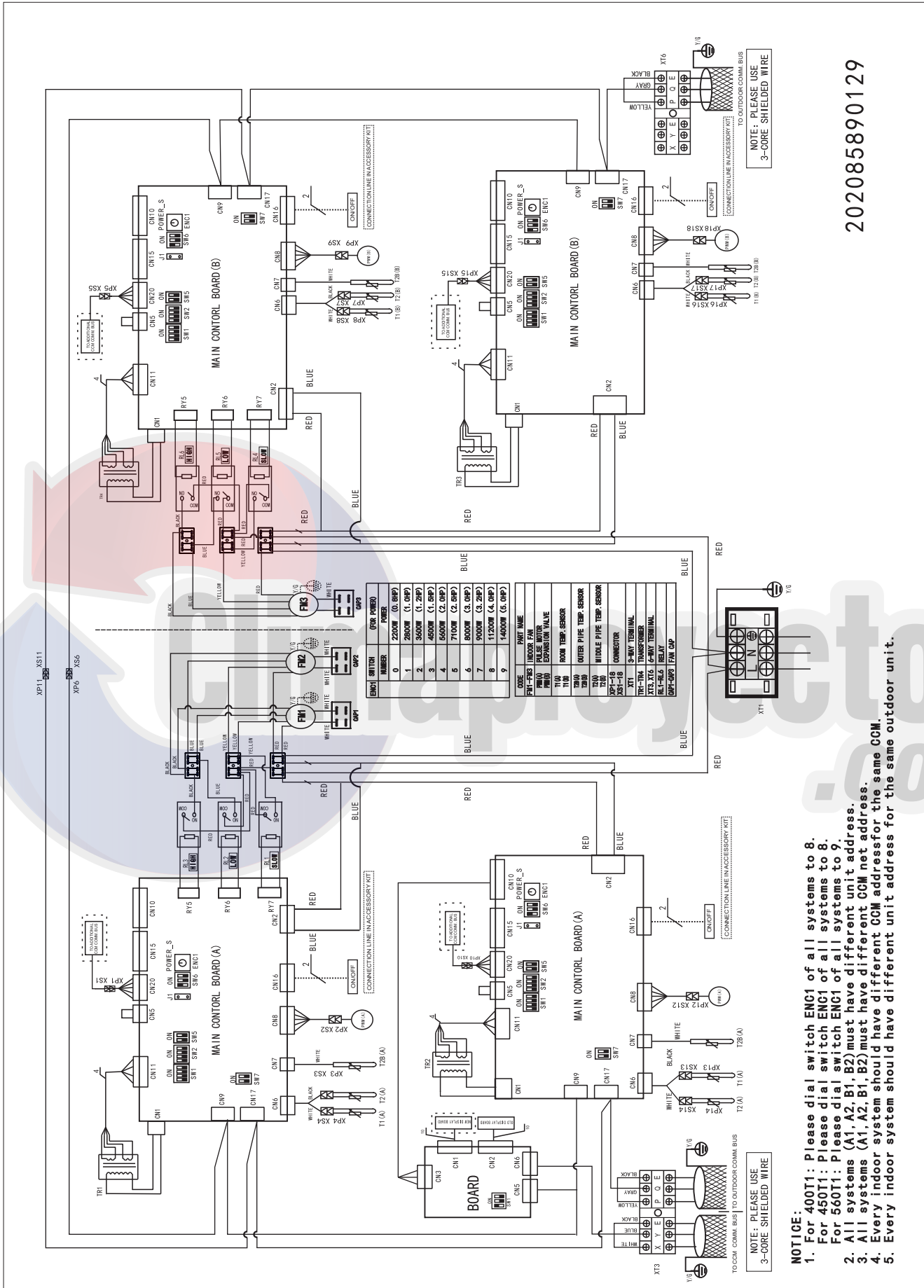

202085890129

- NOTICE:**
1. For 400T1: Please dial switch ENG1 of all systems to 8.
For 450T1: Please dial switch ENG1 of all systems to 8.
 2. All systems (A1, A2, B1, B2) must have different unit address.
 3. All systems (A1, A2, B1, B2) must have different CCM net address.
 4. Every indoor system should have different CCM address for the same CCM.
 5. Every indoor system should have different unit address for the same outdoor unit.

7. Fan Performance

How to Read the Diagram

The vertical axis is the External Static Pressure (**Pa**) while the horizontal axis represents the Air Flow (**CFM**). The characteristic curve for the “H,” “M,” and “L” fan speed control, The nameplate values are shown based on the “H” air flow.

Therefore in the case of **112T1**Type, the air flow is 850 CFM , while the External Static Pressure is 90Pa at “L” position. And 1170 CFM at 90Pa, at“ H” position.

MDV-D71(80)T1/VN1-B

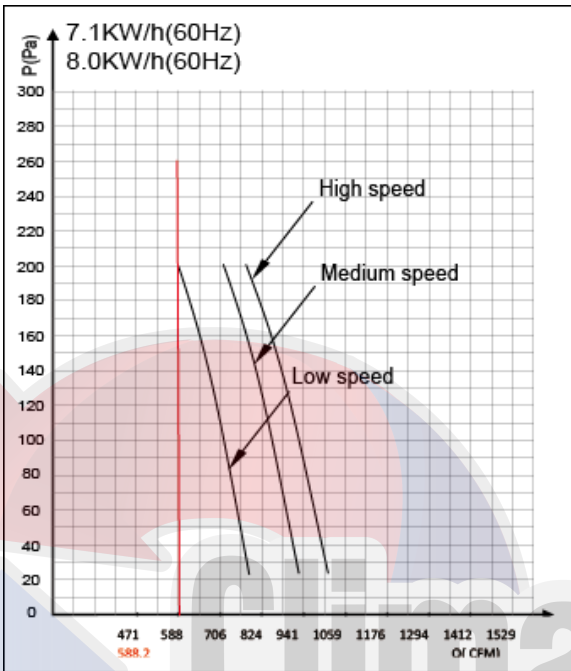

MDV-D90(112)T1/VN1-B

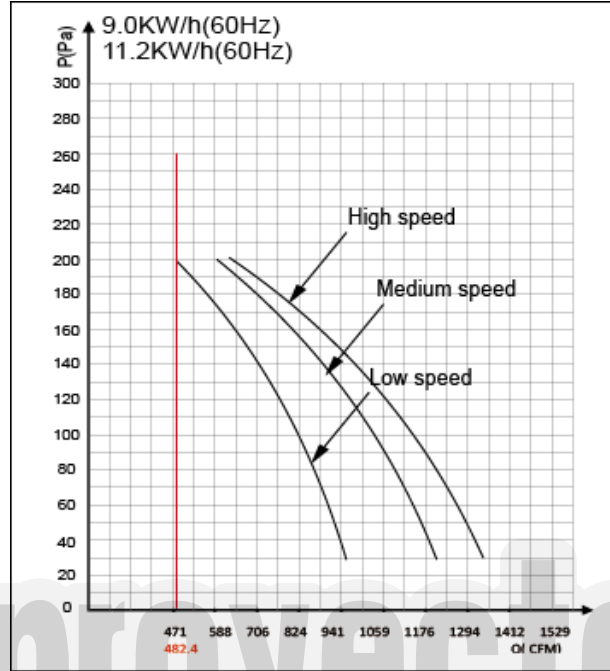

MDV-D140(160)T1/N1-B

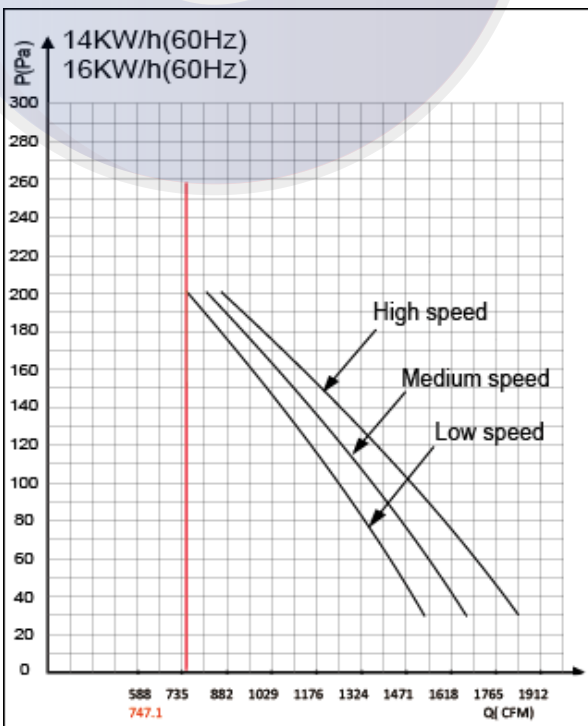

MDV-D400 (450) T1/N1

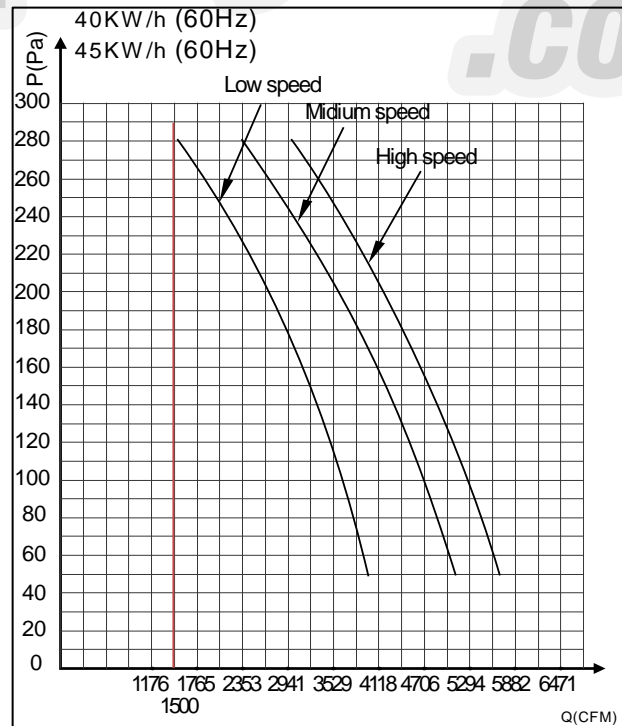

- If the external static pressure is too great (due to long extension of duct, for example), the air flow volume may drop too low at each air outlet.
- So there's a **limit air flow volume** line for each speed, which is the min. Airflow of this duct unit. At this flow volume, the fan achieve the max. ESP, and indoor evaporator may be protected by low temp.
- As well, there's a limit airflow volume, which is the max. Value at each speed. It request the unit to connect duct for air-inlet and outlet, to prevent damage from the high temp. of motor/evaporator.
- This is the available static pressure range which means the unit can run stably in this static pressure range, and the optimal static pressure range please refers to the Installation Manual.
- When choosing any static pressure which is out of optimal static pressure range, risk like bigger noise, lower air flow volume etc. should be considered in advanced.



8. Capacity Tables

8.1 Cooling TC: total capacity SC: sensible capacity WB: wet-bulb temperature DB: dry-bulb temperature

Indoor Unit size (kW)	Outdoor temperature (°FDB)	Indoor temperature (°FWB/DB)													
		57.2/68		60.8/73.4		64.4/78.8		75.2/80.6		68/82.4		71.6/86		75.2/89.6	
		TC	SC	TC	SC	TC	SC	TC	SC	TC	SC	TC	SC	TC	SC
		kW	kW	kW	kW	kW	kW	kW	kW	kW	kW	kW	kW	kW	kW
7.1	50	4.9	4.3	5.8	4.7	6.7	5.3	7.1	5.4	7.5	5.4	8.4	5.6	9.2	5.6
	53.6	4.9	4.3	5.8	4.7	6.7	5.3	7.1	5.4	7.5	5.4	8.4	5.6	9.1	5.5
	57.2	4.9	4.3	5.8	4.7	6.7	5.3	7.1	5.4	7.5	5.4	8.4	5.6	9.0	5.5
	60.8	4.9	4.3	5.8	4.7	6.7	5.3	7.1	5.4	7.5	5.4	8.4	5.6	8.9	5.4
	64.4	4.9	4.3	5.8	4.7	6.7	5.3	7.1	5.4	7.5	5.4	8.4	5.6	8.7	5.2
	68	4.9	4.3	5.8	4.7	6.7	5.3	7.1	5.4	7.5	5.4	8.4	5.6	8.5	5.2
	69.8	4.9	4.3	5.8	4.7	6.7	5.3	7.1	5.4	7.5	5.4	8.4	5.6	8.4	5.1
	73.4	4.9	4.3	5.8	4.7	6.7	5.3	7.1	5.4	7.5	5.4	8.3	5.6	8.3	5.0
	77	4.9	4.3	5.8	4.7	6.7	5.3	7.1	5.4	7.5	5.4	8.2	5.5	8.2	5.0
	80.6	4.9	4.3	5.8	4.7	6.7	5.3	7.1	5.4	7.5	5.4	8.2	5.5	8.2	5.0
	84.2	4.9	4.3	5.8	4.7	6.7	5.3	7.1	5.4	7.5	5.4	8.1	5.4	8.1	5.0
	87.8	4.9	4.3	5.8	4.7	6.7	5.3	7.1	5.4	7.5	5.4	8.0	5.4	7.8	4.8
	91.4	4.9	4.3	5.8	4.7	6.7	5.3	7.1	5.4	7.5	5.4	8.0	5.3	7.8	4.8
	95	4.9	4.3	5.8	4.7	6.7	5.3	7.1	5.4	7.5	5.3	7.7	5.1	7.7	4.8
	98.6	4.9	4.3	5.8	4.7	6.7	5.3	7.1	5.4	7.4	5.3	7.7	5.1	7.6	4.8
	102.2	4.9	4.3	5.8	4.7	6.7	5.3	7.1	5.4	7.2	5.2	7.4	5.0	7.6	4.8
107.6	4.9	4.3	5.8	4.7	6.7	5.3	7.1	5.4	7.2	5.2	7.4	5.0	7.6	4.8	
111.2	4.9	4.3	5.8	4.7	6.7	5.3	7.1	5.4	7.2	5.2	7.4	5.0	7.6	4.8	
114.8	4.9	4.3	5.8	4.7	6.7	5.3	7.1	5.4	7.2	5.2	7.4	5.0	7.6	4.8	
8.0	50	5.5	4.8	6.5	5.3	7.5	5.9	8.0	6.0	8.5	6.0	9.5	6.3	10.4	6.3
	53.6	5.5	4.8	6.5	5.3	7.5	5.9	8.0	6.0	8.5	6.0	9.5	6.3	10.2	6.2
	57.2	5.5	4.8	6.5	5.3	7.5	5.9	8.0	6.0	8.5	6.0	9.5	6.3	10.2	6.1
	60.8	5.5	4.8	6.5	5.3	7.5	5.9	8.0	6.0	8.5	6.0	9.5	6.3	10.0	6.0
	64.4	5.5	4.8	6.5	5.3	7.5	5.9	8.0	6.0	8.5	6.0	9.5	6.3	9.8	5.9
	68	5.5	4.8	6.5	5.3	7.5	5.9	8.0	6.0	8.5	6.0	9.5	6.3	9.6	5.8
	69.8	5.5	4.8	6.5	5.3	7.5	5.9	8.0	6.0	8.5	6.0	9.5	6.3	9.4	5.7
	73.4	5.5	4.8	6.5	5.3	7.5	5.9	8.0	6.0	8.5	6.0	9.4	6.3	9.4	5.7
	77	5.5	4.8	6.5	5.3	7.5	5.9	8.0	6.0	8.5	6.0	9.3	6.2	9.3	5.6
	80.6	5.5	4.8	6.5	5.3	7.5	5.9	8.0	6.0	8.5	6.0	9.2	6.2	9.2	5.7
	84.2	5.5	4.8	6.5	5.3	7.5	5.9	8.0	6.0	8.5	6.0	9.1	6.1	9.1	5.6
	87.8	5.5	4.8	6.5	5.3	7.5	5.9	8.0	6.0	8.5	6.0	9.0	6.1	8.8	5.4
	91.4	5.5	4.8	6.5	5.3	7.5	5.9	8.0	6.0	8.5	6.0	9.0	6.0	8.8	5.4
	95	5.5	4.8	6.5	5.3	7.5	5.9	8.0	6.0	8.4	6.0	8.6	5.8	8.6	5.4
	98.6	5.5	4.8	6.5	5.3	7.5	5.9	8.0	6.0	8.3	5.9	8.6	5.8	8.6	5.4
	102.2	5.5	4.8	6.5	5.3	7.5	5.9	8.0	6.0	8.2	5.8	8.3	5.7	8.6	5.5
107.6	5.5	4.8	6.5	5.3	7.5	5.9	8.0	6.0	8.2	5.8	8.3	5.7	8.6	5.5	
111.2	5.5	4.8	6.5	5.3	7.5	5.9	8.0	6.0	8.2	5.8	8.3	5.7	8.6	5.5	
114.8	5.5	4.8	6.5	5.3	7.5	5.9	8.0	6.0	8.2	5.8	8.3	5.7	8.6	5.5	
9.0	50	6.2	5.4	7.3	6.0	8.5	6.7	9.0	6.8	9.5	6.8	10.7	7.1	11.7	7.1
	53.6	6.2	5.4	7.3	6.0	8.5	6.7	9.0	6.8	9.5	6.8	10.7	7.1	11.5	7.0
	57.2	6.2	5.4	7.3	6.0	8.5	6.7	9.0	6.8	9.5	6.8	10.7	7.1	11.4	6.9
	60.8	6.2	5.4	7.3	6.0	8.5	6.7	9.0	6.8	9.5	6.8	10.7	7.1	11.3	6.8
	64.4	6.2	5.4	7.3	6.0	8.5	6.7	9.0	6.8	9.5	6.8	10.7	7.1	11.0	6.6
	68	6.2	5.4	7.3	6.0	8.5	6.7	9.0	6.8	9.5	6.8	10.7	7.1	10.8	6.5
	69.8	6.2	5.4	7.3	6.0	8.5	6.7	9.0	6.8	9.5	6.8	10.7	7.1	10.6	6.4
	73.4	6.2	5.4	7.3	6.0	8.5	6.7	9.0	6.8	9.5	6.8	10.5	7.1	10.5	6.4
	77	6.2	5.4	7.3	6.0	8.5	6.7	9.0	6.8	9.5	6.8	10.4	7.0	10.4	6.3
	80.6	6.2	5.4	7.3	6.0	8.5	6.7	9.0	6.8	9.5	6.8	10.4	6.9	10.4	6.4
	84.2	6.2	5.4	7.3	6.0	8.5	6.7	9.0	6.8	9.5	6.8	10.3	6.9	10.3	6.3
	87.8	6.2	5.4	7.3	6.0	8.5	6.7	9.0	6.8	9.5	6.8	10.2	6.8	9.9	6.1
	91.4	6.2	5.4	7.3	6.0	8.5	6.7	9.0	6.8	9.5	6.8	10.1	6.7	9.9	6.1
	95	6.2	5.4	7.3	6.0	8.5	6.7	9.0	6.8	9.5	6.7	9.7	6.5	9.7	6.1
	98.6	6.2	5.4	7.3	6.0	8.5	6.7	9.0	6.8	9.4	6.7	9.7	6.5	9.6	6.0
	102.2	6.2	5.4	7.3	6.0	8.5	6.7	9.0	6.8	9.2	6.5	9.4	6.4	9.6	6.1
107.6	6.2	5.4	7.3	6.0	8.5	6.7	9.0	6.8	9.2	6.5	9.4	6.4	9.6	6.1	
111.2	6.2	5.4	7.3	6.0	8.5	6.7	9.0	6.8	9.2	6.5	9.4	6.4	9.6	6.1	
114.8	6.2	5.4	7.3	6.0	8.5	6.7	9.0	6.8	9.2	6.5	9.4	6.4	9.6	6.1	
11.2	50	7.7	6.8	9.1	7.4	10.5	8.3	11.2	8.5	11.9	8.5	13.3	8.8	14.6	8.8
	53.6	7.7	6.8	9.1	7.4	10.5	8.3	11.2	8.5	11.9	8.5	13.3	8.8	14.3	8.7

Indoor Unit size (kW)	Outdoor temperature (°F DB)	Indoor temperature (°FWB/DB)													
		57.2/68		60.8/73.4		64.4/78.8		75.2/80.6		68/82.4		71.6/86		75.2/89.6	
		TC	SC	TC	SC	TC	SC	TC	SC	TC	SC	TC	SC	TC	SC
		kW	kW	kW	kW	kW	kW	kW	kW	kW	kW	kW	kW	kW	kW
11.2	57.2	7.7	6.8	9.1	7.4	10.5	8.3	11.2	8.5	11.9	8.5	13.3	8.8	14.2	8.6
	60.8	7.7	6.8	9.1	7.4	10.5	8.3	11.2	8.5	11.9	8.5	13.3	8.8	14.0	8.5
	64.4	7.7	6.8	9.1	7.4	10.5	8.3	11.2	8.5	11.9	8.5	13.3	8.8	13.7	8.3
	68	7.7	6.8	9.1	7.4	10.5	8.3	11.2	8.5	11.9	8.5	13.3	8.8	13.4	8.1
	69.8	7.7	6.8	9.1	7.4	10.5	8.3	11.2	8.5	11.9	8.5	13.3	8.8	13.2	8.0
	73.4	7.7	6.8	9.1	7.4	10.5	8.3	11.2	8.5	11.9	8.5	13.1	8.8	13.1	7.9
	77	7.7	6.8	9.1	7.4	10.5	8.3	11.2	8.5	11.9	8.5	13.0	8.7	13.0	7.9
	80.6	7.7	6.8	9.1	7.4	10.5	8.3	11.2	8.5	11.9	8.5	12.9	8.6	12.9	7.9
	84.2	7.7	6.8	9.1	7.4	10.5	8.3	11.2	8.5	11.9	8.5	12.8	8.5	12.8	7.9
	87.8	7.7	6.8	9.1	7.4	10.5	8.3	11.2	8.5	11.9	8.5	12.7	8.5	12.3	7.6
	91.4	7.7	6.8	9.1	7.4	10.5	8.3	11.2	8.5	11.9	8.5	12.5	8.4	12.3	7.6
	95	7.7	6.8	9.1	7.4	10.5	8.3	11.2	8.5	11.8	8.4	12.1	8.1	12.1	7.6
	98.6	7.7	6.8	9.1	7.4	10.5	8.3	11.2	8.5	11.6	8.3	12.1	8.1	12.0	7.5
	102.2	7.7	6.8	9.1	7.4	10.5	8.3	11.2	8.5	11.4	8.1	11.6	7.9	12.0	7.6
	107.6	7.7	6.8	9.1	7.4	10.5	8.3	11.2	8.5	11.4	8.1	11.6	7.9	12.0	7.6
111.2	7.7	6.8	9.1	7.4	10.5	8.3	11.2	8.5	11.4	8.1	11.6	7.9	12.0	7.6	
114.8	7.7	6.8	9.1	7.4	10.5	8.3	11.2	8.5	11.4	8.1	11.6	7.9	12.0	7.6	
14.0	50	9.7	8.5	11.3	9.3	13.2	10.4	14.0	10.6	14.8	10.6	16.7	11.0	18.2	11.0
	53.6	9.7	8.5	11.3	9.3	13.2	10.4	14.0	10.6	14.8	10.6	16.7	11.0	17.9	10.8
	57.2	9.7	8.5	11.3	9.3	13.2	10.4	14.0	10.6	14.8	10.6	16.7	11.0	17.8	10.8
	60.8	9.7	8.5	11.3	9.3	13.2	10.4	14.0	10.6	14.8	10.6	16.7	11.0	17.5	10.6
	64.4	9.7	8.5	11.3	9.3	13.2	10.4	14.0	10.6	14.8	10.6	16.7	11.0	17.1	10.3
	68	9.7	8.5	11.3	9.3	13.2	10.4	14.0	10.6	14.8	10.6	16.7	11.0	16.8	10.2
	69.8	9.7	8.5	11.3	9.3	13.2	10.4	14.0	10.6	14.8	10.6	16.7	11.0	16.5	10.0
	73.4	9.7	8.5	11.3	9.3	13.2	10.4	14.0	10.6	14.8	10.6	16.4	11.0	16.4	9.9
	77	9.7	8.5	11.3	9.3	13.2	10.4	14.0	10.6	14.8	10.6	16.2	10.9	16.2	9.8
	80.6	9.7	8.5	11.3	9.3	13.2	10.4	14.0	10.6	14.8	10.6	16.1	10.8	16.1	9.9
	84.2	9.7	8.5	11.3	9.3	13.2	10.4	14.0	10.6	14.8	10.6	16.0	10.7	16.0	9.8
	87.8	9.7	8.5	11.3	9.3	13.2	10.4	14.0	10.6	14.8	10.6	15.8	10.6	15.4	9.5
	91.4	9.7	8.5	11.3	9.3	13.2	10.4	14.0	10.6	14.8	10.6	15.7	10.5	15.4	9.5
	95	9.7	8.5	11.3	9.3	13.2	10.4	14.0	10.6	14.7	10.5	15.1	10.1	15.1	9.5
	98.6	9.7	8.5	11.3	9.3	13.2	10.4	14.0	10.6	14.6	10.4	15.1	10.1	15.0	9.4
102.2	9.7	8.5	11.3	9.3	13.2	10.4	14.0	10.6	14.3	10.2	14.6	9.9	15.0	9.5	
107.6	9.7	8.5	11.3	9.3	13.2	10.4	14.0	10.6	14.3	10.2	14.6	9.9	15.0	9.5	
111.2	9.7	8.5	11.3	9.3	13.2	10.4	14.0	10.6	14.3	10.2	14.6	9.9	15.0	9.5	
114.8	9.7	8.5	11.3	9.3	13.2	10.4	14.0	10.6	14.3	10.2	14.6	9.9	15.0	9.5	
16.0	50	11.0	9.7	13.0	10.6	15.0	11.9	16.0	12.1	17.0	12.1	19.0	12.5	20.8	12.6
	53.6	11.0	9.7	13.0	10.6	15.0	11.9	16.0	12.1	17.0	12.1	19.0	12.5	20.5	12.4
	57.2	11.0	9.7	13.0	10.6	15.0	11.9	16.0	12.1	17.0	12.1	19.0	12.5	20.3	12.3
	60.8	11.0	9.7	13.0	10.6	15.0	11.9	16.0	12.1	17.0	12.1	19.0	12.5	20.0	12.1
	64.4	11.0	9.7	13.0	10.6	15.0	11.9	16.0	12.1	17.0	12.1	19.0	12.5	19.5	11.8
	68	11.0	9.7	13.0	10.6	15.0	11.9	16.0	12.1	17.0	12.1	19.0	12.5	19.2	11.6
	69.8	11.0	9.7	13.0	10.6	15.0	11.9	16.0	12.1	17.0	12.1	19.0	12.5	18.9	11.4
	73.4	11.0	9.7	13.0	10.6	15.0	11.9	16.0	12.1	17.0	12.1	18.7	12.5	18.7	11.3
	77	11.0	9.7	13.0	10.6	15.0	11.9	16.0	12.1	17.0	12.1	18.6	12.4	18.6	11.2
	80.6	11.0	9.7	13.0	10.6	15.0	11.9	16.0	12.1	17.0	12.1	18.4	12.3	18.4	11.3
	84.2	11.0	9.7	13.0	10.6	15.0	11.9	16.0	12.1	17.0	12.1	18.2	12.2	18.2	11.2
	87.8	11.0	9.7	13.0	10.6	15.0	11.9	16.0	12.1	17.0	12.1	18.1	12.1	17.6	10.8
	91.4	11.0	9.7	13.0	10.6	15.0	11.9	16.0	12.1	17.0	12.1	17.9	12.0	17.6	10.8
	95	11.0	9.7	13.0	10.6	15.0	11.9	16.0	12.1	16.8	12.0	17.3	11.6	17.3	10.8
	98.6	11.0	9.7	13.0	10.6	15.0	11.9	16.0	12.1	16.6	11.9	17.3	11.6	17.1	10.7
102.2	11.0	9.7	13.0	10.6	15.0	11.9	16.0	12.1	16.3	11.6	16.6	11.3	17.1	10.9	
107.6	11.0	9.7	13.0	10.6	15.0	11.9	16.0	12.1	16.3	11.6	16.6	11.3	17.1	10.9	
111.2	11.0	9.7	13.0	10.6	15.0	11.9	16.0	12.1	16.3	11.6	16.6	11.3	17.1	10.9	
114.8	11.0	9.7	13.0	10.6	15.0	11.9	16.0	12.1	16.3	11.6	16.6	11.3	17.1	10.9	
40.0	50	27.6	24.1	32.4	26.6	37.6	29.6	40.0	30.2	42.4	30.2	47.6	31.4	52.0	31.4
	53.6	27.6	24.1	32.4	26.6	37.6	29.6	40.0	30.2	42.4	30.2	47.6	31.4	51.2	31.0
	57.2	27.6	24.1	32.4	26.6	37.6	29.6	40.0	30.2	42.4	30.2	47.6	31.4	50.8	30.7
	60.8	27.6	24.1	32.4	26.6	37.6	29.6	40.0	30.2	42.4	30.2	47.6	31.4	50.0	30.2
	64.4	27.6	24.1	32.4	26.6	37.6	29.6	40.0	30.2	42.4	30.2	47.6	31.4	48.8	29.5
	68	27.6	24.1	32.4	26.6	37.6	29.6	40.0	30.2	42.4	30.2	47.6	31.4	48.0	29.0

Indoor Unit size (kW)	Outdoor temperature (°FDB)	Indoor temperature (°FWB/DB)													
		57.2/68		60.8/73.4		64.4/78.8		75.2/80.6		68/82.4		71.6/86		75.2/89.6	
		TC	SC	TC	SC	TC	SC	TC	SC	TC	SC	TC	SC	TC	SC
		kW	kW	kW	kW	kW	kW	kW	kW	kW	kW	kW	kW	kW	kW
40.0	69.8	27.6	24.1	32.4	26.6	37.6	29.6	40.0	30.2	42.4	30.2	47.6	31.4	47.2	28.5
	73.4	27.6	24.1	32.4	26.6	37.6	29.6	40.0	30.2	42.4	30.2	46.8	31.3	46.8	28.3
	77	27.6	24.1	32.4	26.6	37.6	29.6	40.0	30.2	42.4	30.2	46.4	31.1	46.4	28.1
	80.6	27.6	24.1	32.4	26.6	37.6	29.6	40.0	30.2	42.4	30.2	46.0	30.8	46.0	28.3
	84.2	27.6	24.1	32.4	26.6	37.6	29.6	40.0	30.2	42.4	30.2	45.6	30.5	45.6	28.1
	87.8	27.6	24.1	32.4	26.6	37.6	29.6	40.0	30.2	42.4	30.2	45.2	30.3	44.0	27.1
	91.4	27.6	24.1	32.4	26.6	37.6	29.6	40.0	30.2	42.4	30.2	44.8	30.0	44.0	27.1
	95	27.6	24.1	32.4	26.6	37.6	29.6	40.0	30.2	42.0	29.9	43.2	28.9	43.2	27.1
	98.6	27.6	24.1	32.4	26.6	37.6	29.6	40.0	30.2	41.6	29.7	43.2	28.9	42.8	26.8
	102.2	27.6	24.1	32.4	26.6	37.6	29.6	40.0	30.2	40.8	29.1	41.6	28.3	42.8	27.3
	107.6	27.6	24.1	32.4	26.6	37.6	29.6	40.0	30.2	40.8	29.1	41.6	28.3	42.8	27.3
	111.2	27.6	24.1	32.4	26.6	37.6	29.6	40.0	30.2	40.8	29.1	41.6	28.3	42.8	27.3
114.8	27.6	24.1	32.4	26.6	37.6	29.6	40.0	30.2	40.8	29.1	41.6	28.3	42.8	27.3	
45.0	50	31.1	27.2	36.5	29.9	42.3	33.3	45.0	34.0	47.7	34.0	53.6	35.3	58.5	35.4
	53.6	31.1	27.2	36.5	29.9	42.3	33.3	45.0	34.0	47.7	34.0	53.6	35.3	57.6	34.8
	57.2	31.1	27.2	36.5	29.9	42.3	33.3	45.0	34.0	47.7	34.0	53.6	35.3	57.2	34.6
	60.8	31.1	27.2	36.5	29.9	42.3	33.3	45.0	34.0	47.7	34.0	53.6	35.3	56.3	34.0
	64.4	31.1	27.2	36.5	29.9	42.3	33.3	45.0	34.0	47.7	34.0	53.6	35.3	54.9	33.2
	68	31.1	27.2	36.5	29.9	42.3	33.3	45.0	34.0	47.7	34.0	53.6	35.3	54.0	32.7
	69.8	31.1	27.2	36.5	29.9	42.3	33.3	45.0	34.0	47.7	34.0	53.6	35.3	53.1	32.1
	73.4	31.1	27.2	36.5	29.9	42.3	33.3	45.0	34.0	47.7	34.0	52.7	35.3	52.7	31.8
	77	31.1	27.2	36.5	29.9	42.3	33.3	45.0	34.0	47.7	34.0	52.2	35.0	52.2	31.6
	80.6	31.1	27.2	36.5	29.9	42.3	33.3	45.0	34.0	47.7	34.0	51.8	34.7	51.8	31.9
	84.2	31.1	27.2	36.5	29.9	42.3	33.3	45.0	34.0	47.7	34.0	51.3	34.4	51.3	31.6
	87.8	31.1	27.2	36.5	29.9	42.3	33.3	45.0	34.0	47.7	34.0	50.9	34.0	49.5	30.5
	91.4	31.1	27.2	36.5	29.9	42.3	33.3	45.0	34.0	47.7	34.0	50.4	33.7	49.5	30.5
	95	31.1	27.2	36.5	29.9	42.3	33.3	45.0	34.0	47.3	33.7	48.6	32.5	48.6	30.4
	98.6	31.1	27.2	36.5	29.9	42.3	33.3	45.0	34.0	46.8	33.4	48.6	32.5	48.2	30.2
	102.2	31.1	27.2	36.5	29.9	42.3	33.3	45.0	34.0	45.9	32.7	46.8	31.8	48.2	30.7
107.6	31.1	27.2	36.5	29.9	42.3	33.3	45.0	34.0	45.9	32.7	46.8	31.8	48.2	30.7	
111.2	31.1	27.2	36.5	29.9	42.3	33.3	45.0	34.0	45.9	32.7	46.8	31.8	48.2	30.7	
114.8	31.1	27.2	36.5	29.9	42.3	33.3	45.0	34.0	45.9	32.7	46.8	31.8	48.2	30.7	

8.2 Heating

TC: total capacity **WB:** wet-bulb temperature **DB:** dry-bulb temperature

Indoor Unit size (kW)	Outdoor temperature (°F)		Indoor temperature (°F DB)					
			60.8	64.4	68	69.8	71.6	75.2
	WB	DB	TC kW	TC kW	TC kW	TC kW	TC kW	TC kW
7.1	-3.64	-4	3.98	3.98	3.98	3.98	3.98	3.98
	-1.84	-2.2	4.26	4.26	4.26	4.26	4.26	4.26
	1.94	1.4	4.47	4.47	4.47	4.47	4.47	4.47
	7.34	5	4.62	4.62	4.62	4.62	4.62	4.62
	10.76	8.6	4.90	4.90	4.90	4.90	4.90	4.90
	14.36	12.2	4.97	5.04	5.04	5.04	5.04	5.04
	14.9	14	5.18	5.18	5.18	5.18	5.18	5.18
	16.7	15.62	5.33	5.33	5.33	5.33	5.33	5.33
	19.4	18.32	5.40	5.40	5.40	5.40	5.40	5.40
	23	21.92	5.61	5.61	5.61	5.61	5.61	5.61
	26.6	25.34	5.89	5.89	5.89	5.89	5.89	5.89
	32	30.74	6.32	6.32	6.32	6.32	6.32	5.96
	37.4	35.96	6.67	6.67	6.67	6.67	6.53	5.96
	41	39.38	6.89	6.89	6.89	6.89	6.53	5.96
	44.6	42.8	7.10	7.10	7.10	6.89	6.53	5.96
	48.2	46.22	7.31	7.31	7.10	6.89	6.53	5.96
	51.8	49.64	7.53	7.53	7.10	6.89	6.53	5.96
	55.4	53.24	7.81	7.67	7.10	6.89	6.53	5.96
	59	56.66	8.02	7.67	7.10	6.89	6.53	5.96
8.0	-3.64	-4	4.48	4.48	4.48	4.48	4.48	4.48
	-1.84	-2.2	4.80	4.80	4.80	4.80	4.80	4.80
	1.94	1.4	5.04	5.04	5.04	5.04	5.04	5.04
	7.34	5	5.20	5.20	5.20	5.20	5.20	5.20
	10.76	8.6	5.52	5.52	5.52	5.52	5.52	5.52
	14.36	12.2	5.60	5.68	5.68	5.68	5.68	5.68
	14.9	14	5.84	5.84	5.84	5.84	5.84	5.84
	16.7	15.62	6.00	6.00	6.00	6.00	6.00	6.00
	19.4	18.32	6.08	6.08	6.08	6.08	6.08	6.08
	23	21.92	6.32	6.32	6.32	6.32	6.32	6.32
	26.6	25.34	6.64	6.64	6.64	6.64	6.64	6.64
	32	30.74	7.12	7.12	7.12	7.12	7.12	6.72
	37.4	35.96	7.52	7.52	7.52	7.52	7.36	6.72
	41	39.38	7.76	7.76	7.76	7.76	7.36	6.72
	44.6	42.8	8.00	8.00	8.00	7.76	7.36	6.72
	48.2	46.22	8.24	8.24	8.00	7.76	7.36	6.72
	51.8	49.64	8.48	8.48	8.00	7.76	7.36	6.72
	55.4	53.24	8.80	8.64	8.00	7.76	7.36	6.72
	59	56.66	9.04	8.64	8.00	7.76	7.36	6.72
9.0	-3.64	-4	5.04	5.04	5.04	5.04	5.04	5.04
	-1.84	-2.2	5.40	5.40	5.40	5.40	5.40	5.40
	1.94	1.4	5.67	5.67	5.67	5.67	5.67	5.67
	7.34	5	5.85	5.85	5.85	5.85	5.85	5.85
	10.76	8.6	6.21	6.21	6.21	6.21	6.21	6.21
	14.36	12.2	6.30	6.39	6.39	6.39	6.39	6.39
	14.9	14	6.57	6.57	6.57	6.57	6.57	6.57
	16.7	15.62	6.75	6.75	6.75	6.75	6.75	6.75
	19.4	18.32	6.84	6.84	6.84	6.84	6.84	6.84
	23	21.92	7.11	7.11	7.11	7.11	7.11	7.11
	26.6	25.34	7.47	7.47	7.47	7.47	7.47	7.47
	32	30.74	8.01	8.01	8.01	8.01	8.01	7.56
	37.4	35.96	8.46	8.46	8.46	8.46	8.28	7.56
	41	39.38	8.73	8.73	8.73	8.73	8.28	7.56
	44.6	42.8	9.00	9.00	9.00	8.73	8.28	7.56
	48.2	46.22	9.27	9.27	9.00	8.73	8.28	7.56
	51.8	49.64	9.54	9.54	9.00	8.73	8.28	7.56
	55.4	53.24	9.90	9.72	9.00	8.73	8.28	7.56
	59	56.66	10.17	9.72	9.00	8.73	8.28	7.56
11.2	-3.64	-4	6.27	6.27	6.27	6.27	6.27	6.27
	-1.84	-2.2	6.72	6.72	6.72	6.72	6.72	6.72

Indoor Unit size (kW)	Outdoor temperature (°F)		Indoor temperature (°F DB)					
			60.8	64.4	68	69.8	71.6	75.2
	WB	DB	TC kW	TC kW	TC kW	TC kW	TC kW	TC kW
11.2	1.94	1.4	7.06	7.06	7.06	7.06	7.06	7.06
	7.34	5	7.28	7.28	7.28	7.28	7.28	7.28
	10.76	8.6	7.73	7.73	7.73	7.73	7.73	7.73
	14.36	12.2	7.84	7.95	7.95	7.95	7.95	7.95
	14.9	14	8.18	8.18	8.18	8.18	8.18	8.18
	16.7	15.62	8.40	8.40	8.40	8.40	8.40	8.40
	19.4	18.32	8.51	8.51	8.51	8.51	8.51	8.51
	23	21.92	8.85	8.85	8.85	8.85	8.85	8.85
	26.6	25.34	9.30	9.30	9.30	9.30	9.30	9.30
	32	30.74	9.97	9.97	9.97	9.97	9.97	9.41
	37.4	35.96	10.53	10.53	10.53	10.53	10.30	9.41
	41	39.38	10.86	10.86	10.86	10.86	10.30	9.41
	44.6	42.8	11.20	11.20	11.20	10.86	10.30	9.41
	48.2	46.22	11.54	11.54	11.20	10.86	10.30	9.41
	51.8	49.64	11.87	11.87	11.20	10.86	10.30	9.41
	55.4	53.24	12.32	12.10	11.20	10.86	10.30	9.41
59	56.66	12.66	12.10	11.20	10.86	10.30	9.41	
14.0	-3.64	-4	7.84	7.84	7.84	7.84	7.84	7.84
	-1.84	-2.2	8.40	8.40	8.40	8.40	8.40	8.40
	1.94	1.4	8.82	8.82	8.82	8.82	8.82	8.82
	7.34	5	9.10	9.10	9.10	9.10	9.10	9.10
	10.76	8.6	9.66	9.66	9.66	9.66	9.66	9.66
	14.36	12.2	9.80	9.94	9.94	9.94	9.94	9.94
	14.9	14	10.22	10.22	10.22	10.22	10.22	10.22
	16.7	15.62	10.50	10.50	10.50	10.50	10.50	10.50
	19.4	18.32	10.64	10.64	10.64	10.64	10.64	10.64
	23	21.92	11.06	11.06	11.06	11.06	11.06	11.06
	26.6	25.34	11.62	11.62	11.62	11.62	11.62	11.62
	32	30.74	12.46	12.46	12.46	12.46	12.46	11.76
	37.4	35.96	13.16	13.16	13.16	13.16	12.88	11.76
	41	39.38	13.58	13.58	13.58	13.58	12.88	11.76
	44.6	42.8	14.00	14.00	14.00	13.58	12.88	11.76
	48.2	46.22	14.42	14.42	14.00	13.58	12.88	11.76
51.8	49.64	14.84	14.84	14.00	13.58	12.88	11.76	
55.4	53.24	15.40	15.12	14.00	13.58	12.88	11.76	
59	56.66	15.82	15.12	14.00	13.58	12.88	11.76	
16.0	-3.64	-4	8.96	8.96	8.96	8.96	8.96	8.96
	-1.84	-2.2	9.60	9.60	9.60	9.60	9.60	9.60
	1.94	1.4	10.08	10.08	10.08	10.08	10.08	10.08
	7.34	5	10.40	10.40	10.40	10.40	10.40	10.40
	10.76	8.6	11.04	11.04	11.04	11.04	11.04	11.04
	14.36	12.2	11.20	11.36	11.36	11.36	11.36	11.36
	14.9	14	11.68	11.68	11.68	11.68	11.68	11.68
	16.7	15.62	12.00	12.00	12.00	12.00	12.00	12.00
	19.4	18.32	12.16	12.16	12.16	12.16	12.16	12.16
	23	21.92	12.64	12.64	12.64	12.64	12.64	12.64
	26.6	25.34	13.28	13.28	13.28	13.28	13.28	13.28
	32	30.74	14.24	14.24	14.24	14.24	14.24	13.44
	37.4	35.96	15.04	15.04	15.04	15.04	14.72	13.44
	41	39.38	15.52	15.52	15.52	15.52	14.72	13.44
	44.6	42.8	16.00	16.00	16.00	15.52	14.72	13.44
	48.2	46.22	16.48	16.48	16.00	15.52	14.72	13.44
51.8	49.64	16.96	16.96	16.00	15.52	14.72	13.44	
55.4	53.24	17.60	17.28	16.00	15.52	14.72	13.44	
59	56.66	18.08	17.28	16.00	15.52	14.72	13.44	
40.0	-3.64	-4	22.40	22.40	22.40	22.40	22.40	22.40
	-1.84	-2.2	24.00	24.00	24.00	24.00	24.00	24.00
	1.94	1.4	25.20	25.20	25.20	25.20	25.20	25.20
	7.34	5	26.00	26.00	26.00	26.00	26.00	26.00
	10.76	8.6	27.60	27.60	27.60	27.60	27.60	27.60
	14.36	12.2	28.00	28.40	28.40	28.40	28.40	28.40

Indoor Unit size (kW)	Outdoor temperature (°F)		Indoor temperature (°F DB)					
			60.8	64.4	68	69.8	71.6	75.2
	WB	DB	TC	TC	TC	TC	TC	TC
40.0	14.9	14	29.20	29.20	29.20	29.20	29.20	29.20
	16.7	15.62	30.00	30.00	30.00	30.00	30.00	30.00
	19.4	18.32	30.40	30.40	30.40	30.40	30.40	30.40
	23	21.92	31.60	31.60	31.60	31.60	31.60	31.60
	26.6	25.34	33.20	33.20	33.20	33.20	33.20	33.20
	32	30.74	35.60	35.60	35.60	35.60	35.60	33.60
	37.4	35.96	37.60	37.60	37.60	37.60	36.80	33.60
	41	39.38	38.80	38.80	38.80	38.80	36.80	33.60
	44.6	42.8	40.00	40.00	40.00	38.80	36.80	33.60
	48.2	46.22	41.20	41.20	40.00	38.80	36.80	33.60
	51.8	49.64	42.40	42.40	40.00	38.80	36.80	33.60
	55.4	53.24	44.00	43.20	40.00	38.80	36.80	33.60
59	56.66	45.20	43.20	40.00	38.80	36.80	33.60	
45.0	-3.64	-4	25.20	25.20	25.20	25.20	25.20	25.20
	-1.84	-2.2	27.00	27.00	27.00	27.00	27.00	27.00
	1.94	1.4	28.35	28.35	28.35	28.35	28.35	28.35
	7.34	5	29.25	29.25	29.25	29.25	29.25	29.25
	10.76	8.6	31.05	31.05	31.05	31.05	31.05	31.05
	14.36	12.2	31.50	31.95	31.95	31.95	31.95	31.95
	14.9	14	32.85	32.85	32.85	32.85	32.85	32.85
	16.7	15.62	33.75	33.75	33.75	33.75	33.75	33.75
	19.4	18.32	34.20	34.20	34.20	34.20	34.20	34.20
	23	21.92	35.55	35.55	35.55	35.55	35.55	35.55
	26.6	25.34	37.35	37.35	37.35	37.35	37.35	37.35
	32	30.74	40.05	40.05	40.05	40.05	40.05	37.80
	37.4	35.96	42.30	42.30	42.30	42.30	41.40	37.80
	41	39.38	43.65	43.65	43.65	43.65	41.40	37.80
	44.6	42.8	45.00	45.00	45.00	43.65	41.40	37.80
	48.2	46.22	46.35	46.35	45.00	43.65	41.40	37.80
	51.8	49.64	47.70	47.70	45.00	43.65	41.40	37.80
55.4	53.24	49.50	48.60	45.00	43.65	41.40	37.80	
59	56.66	50.85	48.60	45.00	43.65	41.40	37.80	

9. Electrical Characteristics

Model	Indoor Unit				Power Supply		IFM	
	Hz	Voltage	Min.	Max.	MCA	MFA	KW	FLA
MDV-D71T1/VN1-B	60	208-230V	207V	254V	2.3625	5	0.425	1.89
MDV-D80T1/VN1-B	60	208-230V	207V	254V	2.3625	5	0.425	1.89
MDV-D90T1/VN1-B	60	208-230V	207V	254V	2.2875	5	0.405	1.83
MDV-D112T1/VN1-B	60	208-230V	207V	254V	2.2875	5	0.405	1.83
MDV-D140T1/VN1-B	60	208-230V	207V	254V	2.975	5	0.55	2.38
MDV-D160T1/VN1-B	60	208-230V	207V	254V	2.975	6	0.55	2.38
MDV-D400T1/N1	60	208-230V	207V	254V	12.75	20	1.56	10.2
MDV-D450T1/N1	60	208-230V	207V	254V	12.75	20	1.56	10.2

Remark:

MCA: Min. Current Amps. (A)

MFA: Max. Fuse Amps. (A)

KW: Fan Motor Rated Output (kW)

FLA: Full Load Amps. (A)

IFM:Indoor Fan Motor



Climaproyectos
.com

10. Sound Levels

10.1 Test condition

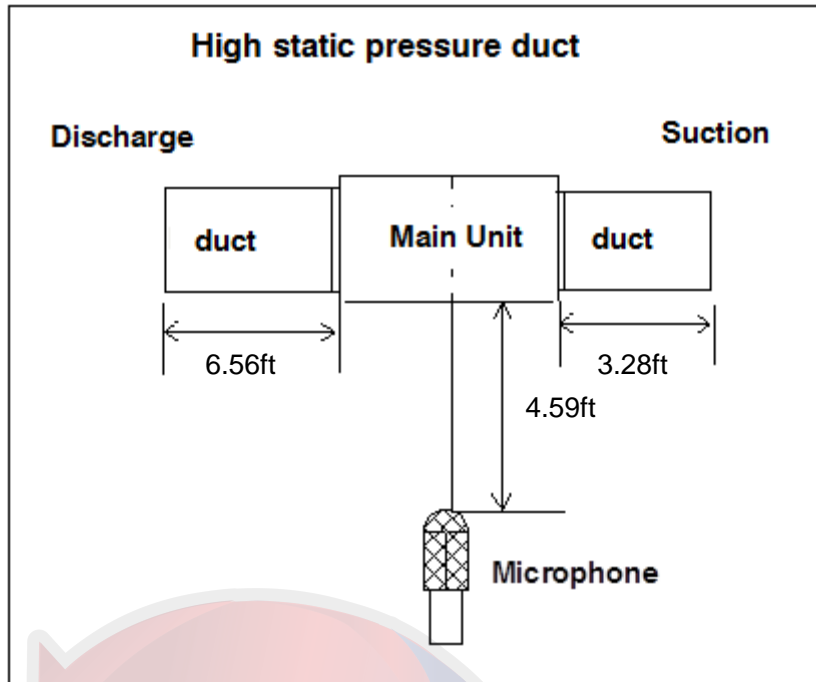

10.2 Test value

Model	Sound test value dB(A)		
	H	M	L
MDV-D71T1/VN1-B	48	46	44.5
MDV-D80T1/VN1-B	48	46	44.5
MDV-D90T1/VN1-B	52	49	47
MDV-D112T1/VN1-B	52	49	47
MDV-D140T1/VN1-B	53	50	48
MDV-D160T1/VN1-B	54	52	50
MDV-D400T1/N1	61	59	56
MDV-D450T1/N1	61	59	56

MDV-D71T1/VN1-B,MDV-D80T1/N1-B

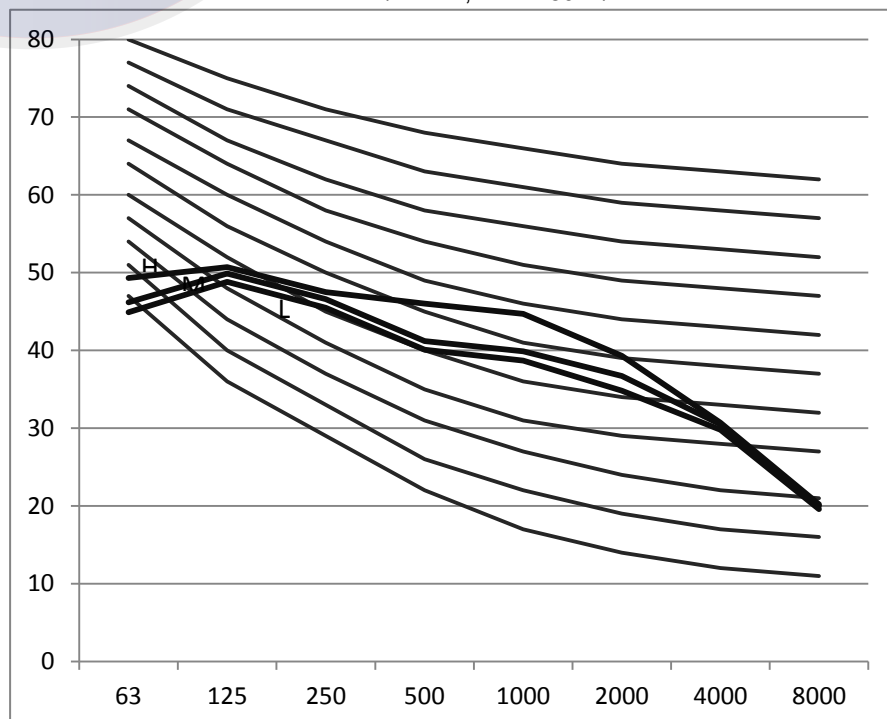

MDV-D90T1/N1-B,MDV-D112T1/N1-B

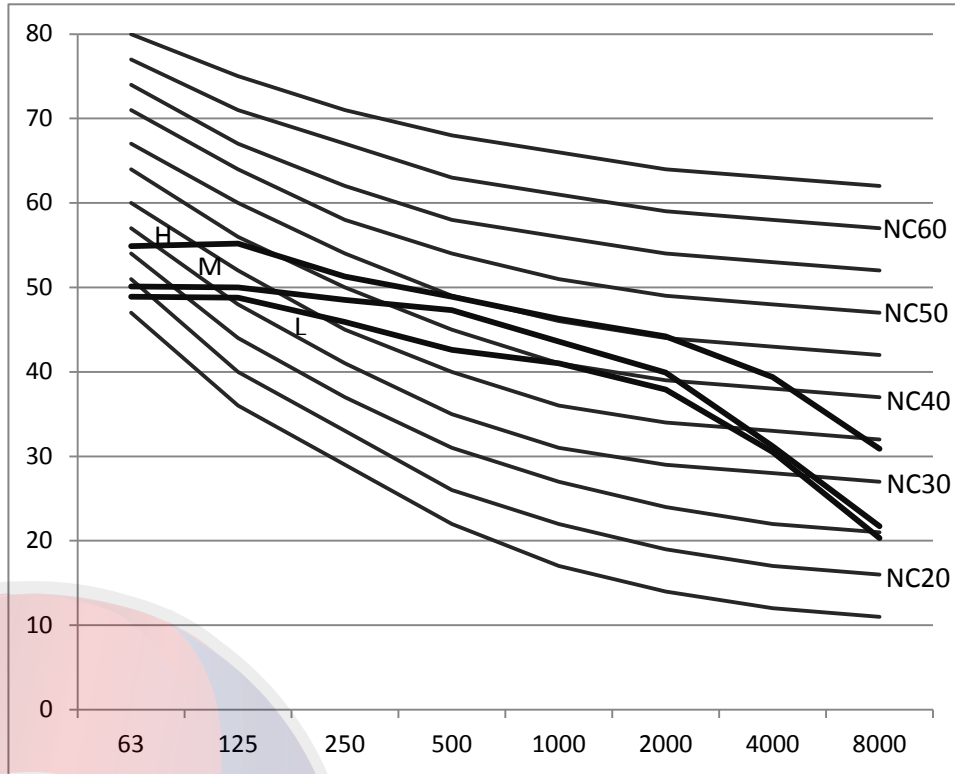

MDV-D140T1/VN1-B

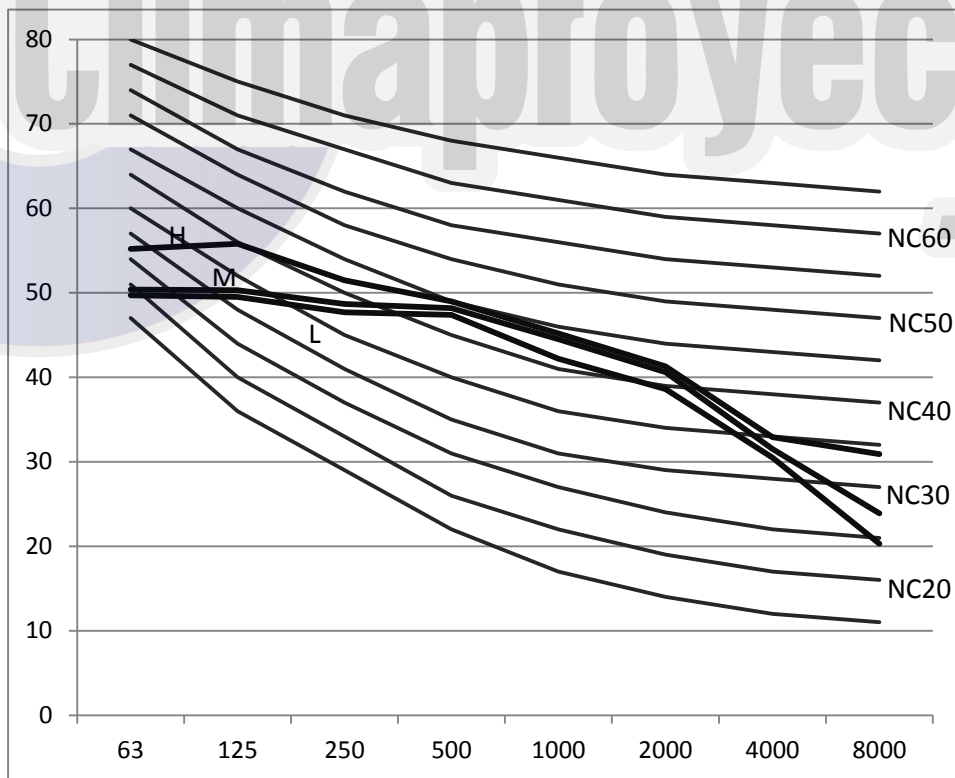

MDV-D160T1/VN1-B

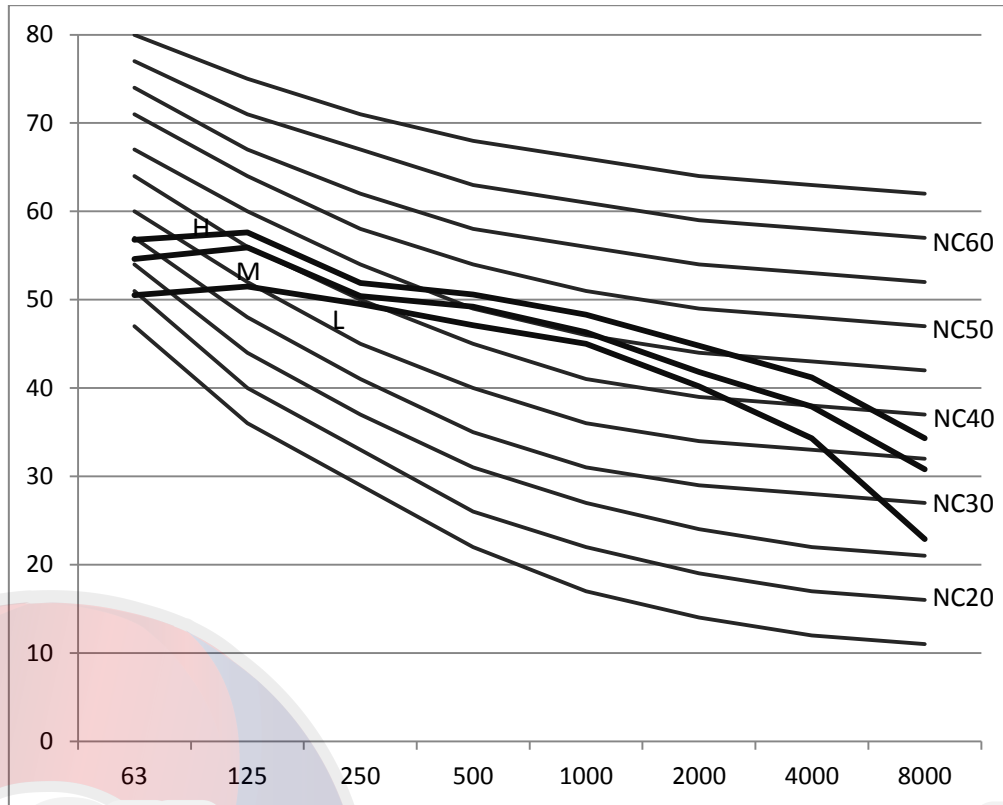



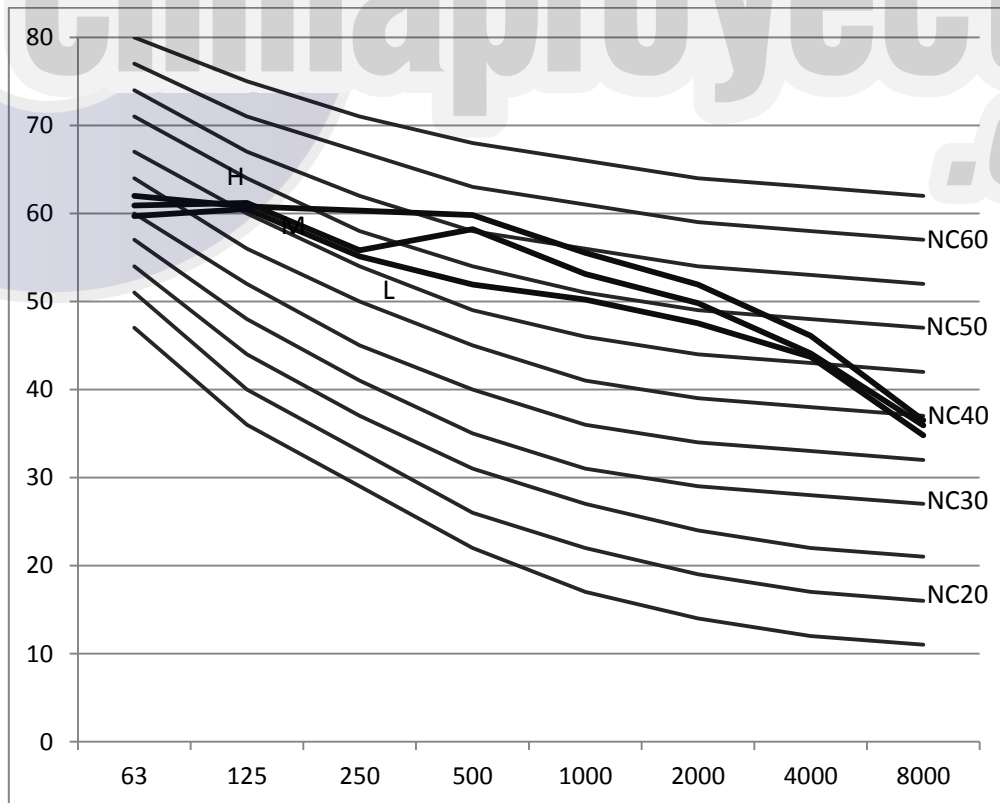



MDV-D400T1/N1, MDV-D450T1/N1

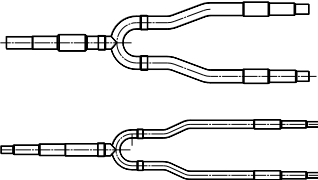
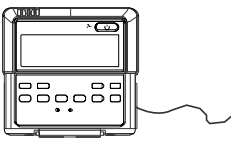
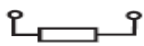

11. Accessories

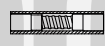
11.1 Standard accessories

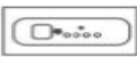
Name	Qty.	Shape	Usage
Installation manual	1	/	/
Pipe insulation material	71~160		Heat insulation
	200 and up		
Adhesive tape for seal	2		To connect drain pipe
Branch header (for 200 and up model) package Code: 201609891015 Model:CE-MDV-BY101N1(MDV-BY101N1)	2		1 liquid and 1 gas branch To connect the two circuits of indoor unit as one system.
Wired controller (KJR-10B/DP(T)-E(A))	1		Control the air conditioner.
Network matching wire	1		The indoor unit witch at the terminal of communication system should connect a impedance between port p and port Q
Water outlet joint (except 400,450 model)	1		For drainage
Water connecting pipe (only for 400,450 model)	1		To connect drain pipe
Clasp	1		Chucking the joint which connect the drain hose and the outlet of indoor unit
EXV connecting pipe ass'y (only for 400,450,560 model)	2		To connect the throttle components.
Signal receiver display board (already fixed inside control box)	1		Receive signal

11.2 Optional accessories

Name	Model	Code	Usage
Wireless remote controller	RM05/BG(T)E-A	203355091418	Which can be used to set the indoor unit's address
Drain pump kit	SBH-04	210095700140	To lift the drain water up

Fresh air processing unit

1. Features	105
2. Specifications	106
3. Dimensions	108
4. Service Spaces	110
5. Piping Diagrams	111
6. Wiring Diagrams	112
7. Capacity Tables	114
8. Electrical Characteristics	119
9. Fan Performance	120
10. Sound Levels	121
11. Accessories	124

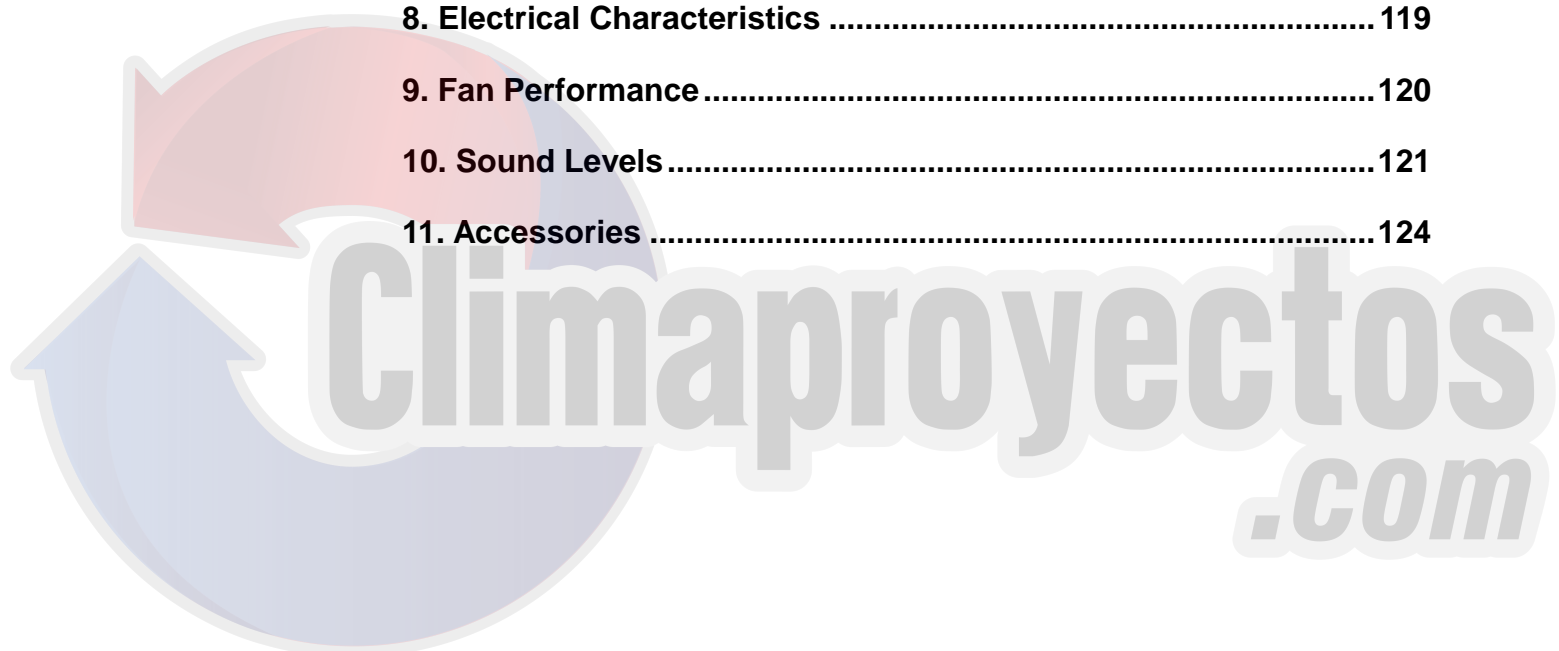

1. Features

(1) 100% Fresh Air Processing Unit

Both fresh air treatment and heating and cooling can be achieved successfully in a single system. Indoor units and fresh air processing unit can be connected to the same refrigerant system, resulting in enhanced design flexibility and a significant reduction in total system costs.

(2) High External Static Pressure

External static pressure of Indoor Unit can be up to 280Pa, which allows extensive duct work for flexible applications. So the cool air can be delivered to every indoor corner even in a super-high ceiling. The maximal distance of air supply is about 14m; the height of air supply is about 6.5m.

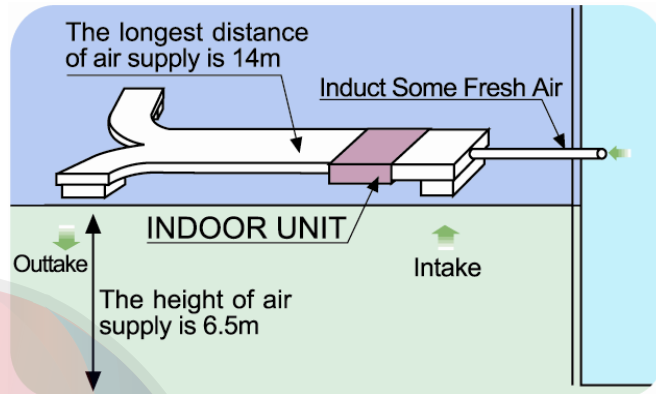

(3) Wired control and group control available.

(4) High capacity of cooling/heating and efficient.

(5) Innovative air supply, which provides homogeneous conditioning of the room temperature.

(6) Can be connected to all Midea VRF systems except heat recovery VRF and 8~26kW side discharge outdoor units.

Layout Example:

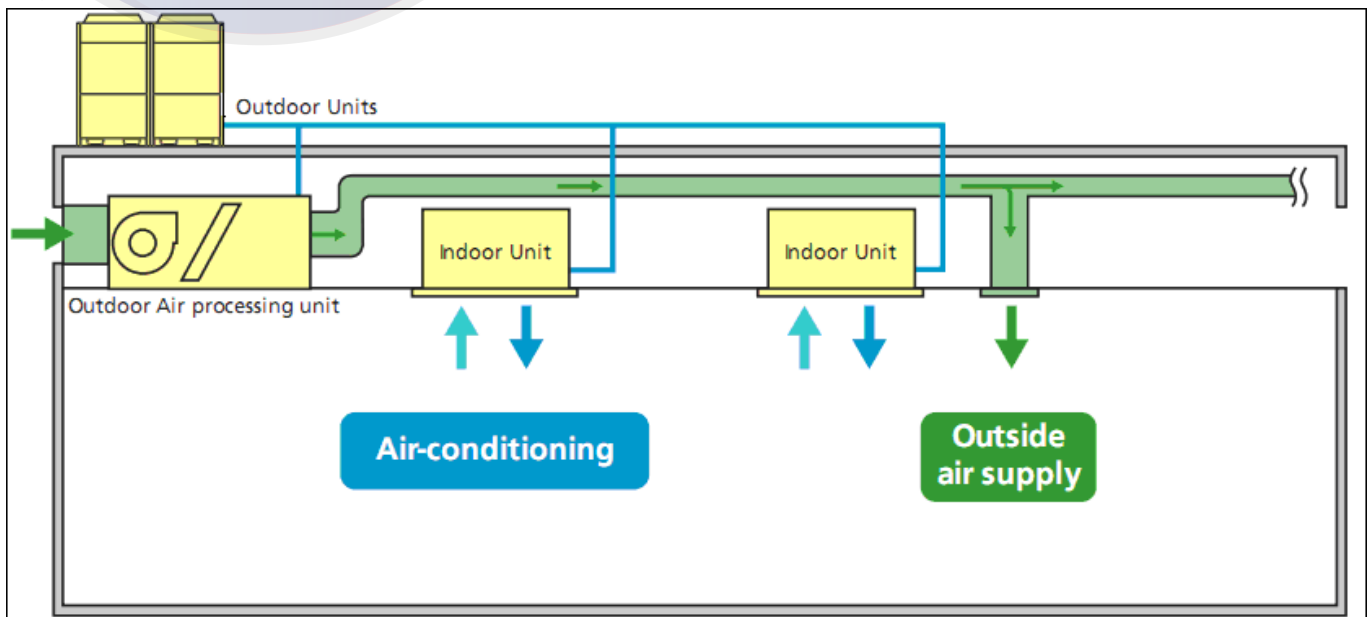

2. Specifications

Sale Model			MDV-D125T1/VN1-FA	MDV-D140T1/VN1-FA
Power supply		V-Ph-Hz	220-240V-1Ph-60Hz	220-240V-1Ph-60Hz
Capacity	Cooling	kW	12.5	14
	Heating	kW	10.5	12
Power input	Cooling	W	455	455
	Heating	W	455	455
Max. current		A	2.4	2.4
Indoor fan motor	Model		YSK300-6M-2	YSK300-6M-2
	Type		Ac Motor	Ac Motor
	Brand		Yong An	Yong An
	Input	W	430	430
	Capacitor	uF	12μF/450V	12μF/450V
	Speed(h/m/l)	r/min	929/868/808	929/868/808
Indoor coil	Number of rows		4	4
	Tube pitch(a)x row pitch(b)	in.(mm)	1×7/8 (25.4×22)	1×7/8 (25.4×22)
	Fin spacing	in.(mm)	1/16(1.6)	1/16(1.6)
	Fin type (code)		hydrophilia arcuate fin aluminum foil	
	Tube outside dia. and type	in.(mm)	3/8(9.52)	3/8(9.52)
			Inner groove tube	Inner groove tube
	Coil length x height x width	mm	996×355.6×88	996×355.6×88
	Number of circuits		7	7
Indoor air flow (H/M/L)		m3/h	2142/1870/1611	2142/1870/1611
		CFM	1261/1101/948	1261/1101/948
*Indoor external static pressure (H)		Pa	50(50~196)	50(50~196)
Indoor noise level (Sound pressure)(H/M/L)		dB(A)	54/52/50	54/52/50
Indoor unit	Dimension (W×H×D)	in.(mm)	51-3/16×16-17/32×27-11/64(1300×420×690)	
	Packing (W×H×D)	in.(mm)	56-17/23×17-23/32×30-1/4(1436×450×768)	
	Net/Gross weight	lbs.(Kg)	153.2/167.5(69.5/76)	153.2/167.5(69.5/76)
Refrigerant type			R410A	R410A
Throttle type			Electronic expansion valve	
Design pressure(H/L)		MPa	4.4/2.6	4.4/2.6
Refrigerant piping	Liquid side/ Gas side	in.(mm)	Φ3/8,Φ5/8(Φ9.53/Φ15.9)	Φ3/8,Φ5/8(Φ9.53/Φ15.9)
Connection wiring	Power wiring	mm ²	2×2.5+1×2.0	2×2.5+1×2.0
	Signal wiring	mm ²	3×0.75	3×0.75
Drainage pipe diameter		in.(mm)	OD1-17/64 (Φ32)	OD1-17/64 (Φ32)
Operation temperature range		°C	Heating: -5~16; Fan only: 16~20; Cooling: 20~43	
Controller			Wire controller KJR-29B1/BK-E	

Notes:

- Nominal cooling capacities are based on the following conditions: outdoor air temperature: 33°C DB, 28°C WB, equivalent ref. piping: 8m (horizontal)
- Nominal heating capacities are based on the following conditions: outdoor temperature: 0°CDB, -2.9°CWB, and equivalent ref. Piping: 8m (horizontal)
- *This is the available static pressure range which means the unit can run stably in this static pressure range, and the optimal static pressure range please refers to the Installation Manual. When choosing any static pressure which is out of optimal static pressure range, risk like bigger noise, lower air flow volume etc. should be considered in advanced.

Sale Model			MDV-D200T1/VN1-FA	MDV-D250T1/VN1-FA	MDV-D280T1/VN1-FA
Power supply		V-Ph-Hz	220V-1Ph-60Hz	220V-1Ph-60Hz	220V-1Ph-60Hz
Capacity	Cooling	kW	20.0	25.0	28.0
	Heating	kW	18.0	20.0	22.0
Power input	Cooling	W	1060(x2)	1126(x2)	1126(x2)
	Heating	W	1060(x2)	1126(x2)	1126(x2)
Max. current		A	4.2	4.4	4.4
Indoor fan motor	Model		YDK195-6B (x2)	YDK195-6B (x2)	YDK195-6B (x2)
	Type		Ac Motor	Ac Motor	Ac Motor
	Brand		Yong An	Yong An	Yong An
	Input	W	1000(x2)	1063(x2)	1063(x2)
	Capacitor	uF	10μF/450V (x2)	12μF/450V (x2)	12μF/450V (x2)
	Speed(h/m/l)	r/min	966/873/781	966/873/781	966/873/781
Indoor coil	Number of rows		4	4	4
	Tube pitch(a)x row pitch(b)	in.(mm)	1x7/8 (25.4x22)	1x7/8 (25.4x22)	1x7/8 (25.4x22)
	Fin spacing	in.(mm)	5/64(1.8)	5/64(1.8)	5/64(1.8)
	Fin type (code)		hydrophilia arcuate fin aluminum foil		
	Tube outside dia. and type	in.(mm)	3/8(Φ9.53)	3/8(Φ9.53)	3/8(Φ9.53)
			Inner groove tube	Inner groove tube	Inner groove tube
	Coil length x height x width	in.(mm)	44-19/64x20-5/32x3-15/32(1125x512x88)		
Number of circuits		20	20	20	
Indoor air flow (H/M/L)		m3/h	2870/2620/2150	3005/2700/2250	3005/2700/2250
		CFM	1689/1542/1265	1766/1589/1324	1766/1589/1324
*Indoor external static pressure (H)		Pa	200(50~280)	200(50~280)	200(50~280)
Indoor noise level (Sound pressure)(H/M/L)		dB(A)	54/53/51	55/54/52	55/54/52
Indoor unit	Dimension (WxHxD)	in.(mm)	56-11/16x19-7/8x36-27/64(1440x505x925)		
	Packing (WxHxD)	in.(mm)	59-13/32x21-32/38x38-31/32(1509x550x990)		
	Net/Gross weight	lbs.(Kg)	251/274(114/124)	251/274(114/124)	251/274(114/124)
Refrigerant type			R410A	R410A	R410A
Throttle type			Electronic expansion valve		
Design pressure(H/L)		MPa	4.2/2.0	4.2/2.0	4.2/2.0
Refrigerant piping	Liquid side/ Gas side	in.(mm)	Φ3/8, Φ5/8(Φ9.53/Φ15.9)		
Connection wiring	Power wiring	mm ²	3x2.5	3x2.5	3x2.5
	Signal wiring	mm ²	3x0.75	3x0.75	3x0.75
Drainage pipe diameter		in.(mm)	OD1-17/64 (Φ32)		
Operation temperature range		°C	Heating: -5~16; Fan only: 16~20; Cooling: 20~43		
Controller			Wire controller KJR-29B1/BK-E		

Notes:

- Nominal cooling capacities are based on the following conditions: outdoor air temperature: 33°C DB, 28°C WB, equivalent ref. piping: 8m (horizontal)
- Nominal heating capacities are based on the following conditions: outdoor temperature: 0°C DB, -2.9°C WB, and equivalent ref. Piping: 8m (horizontal)
- *This is the available static pressure range which means the unit can run stably in this static pressure range, and the optimal static pressure range please refers to the Installation Manual. When choosing any static pressure which is out of optimal static pressure range, risk like bigger noise, lower air flow volume etc. should be considered in advanced.

3. Dimensions

MDV-D125T1/N1-FA, MDV-D140T1/N1-FA

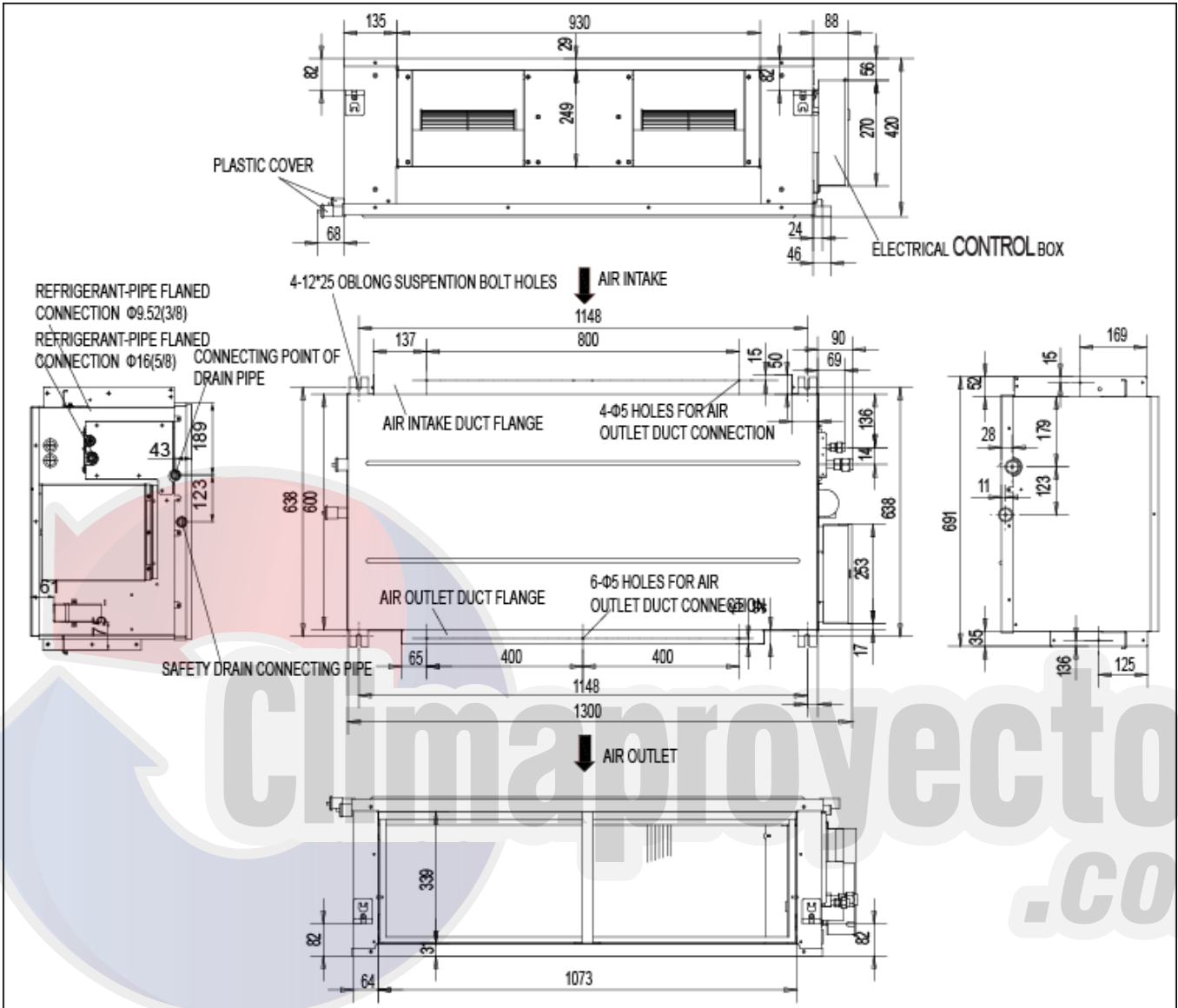

MDV-D200T11/N1-FA, MDV-D250T1/N1-FA, MDV-D280T1/N1-FA

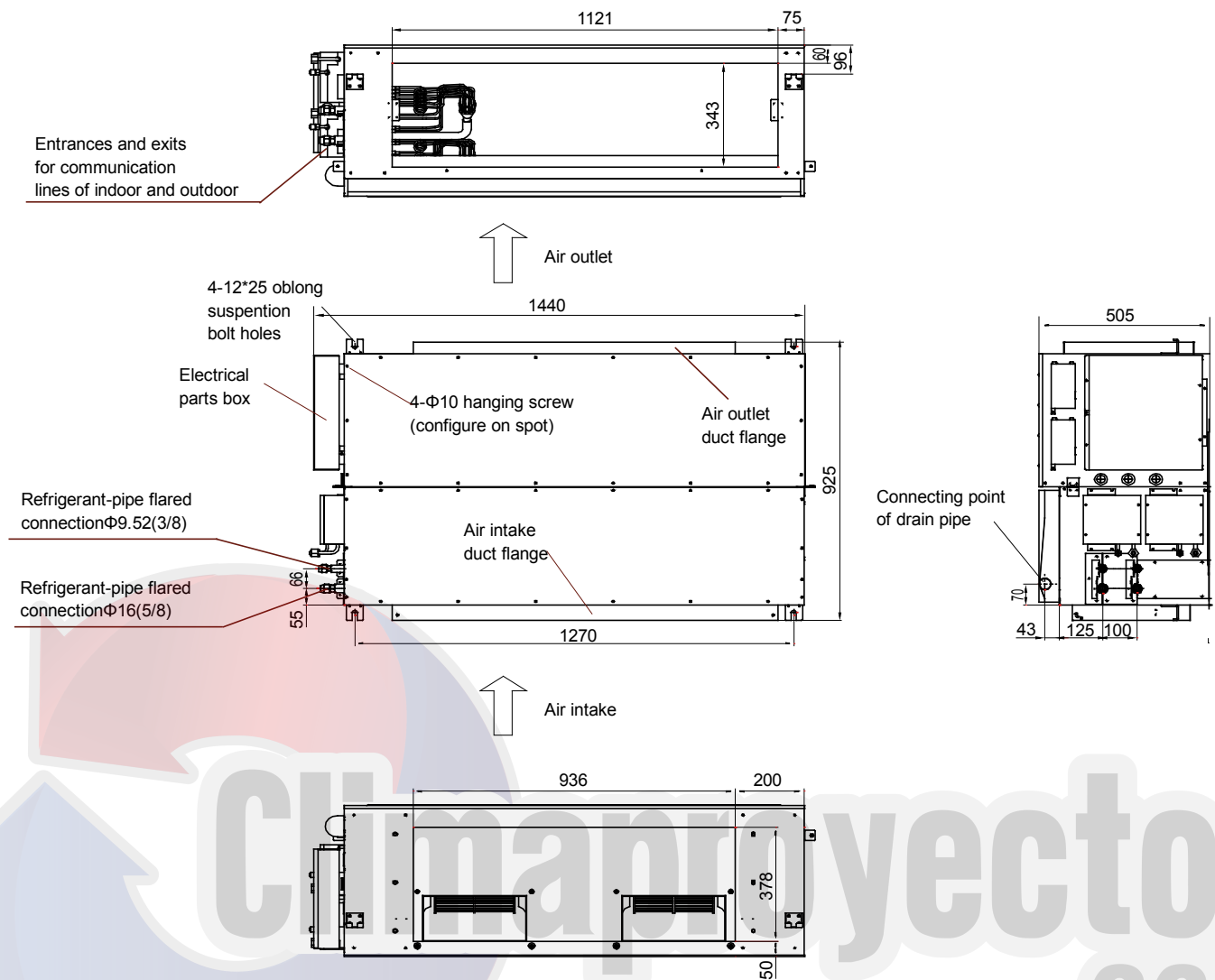

4. Service Spaces

Ensure enough space required for installation and maintenance.

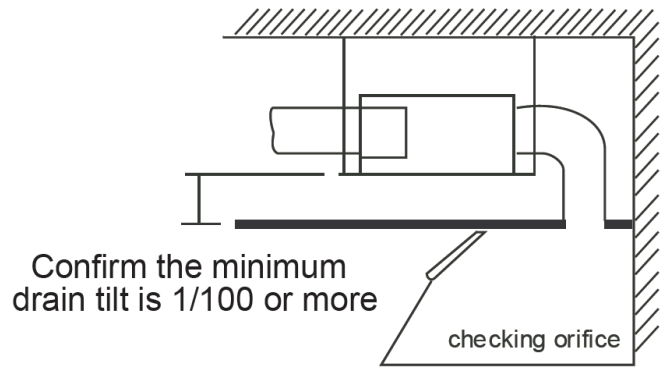
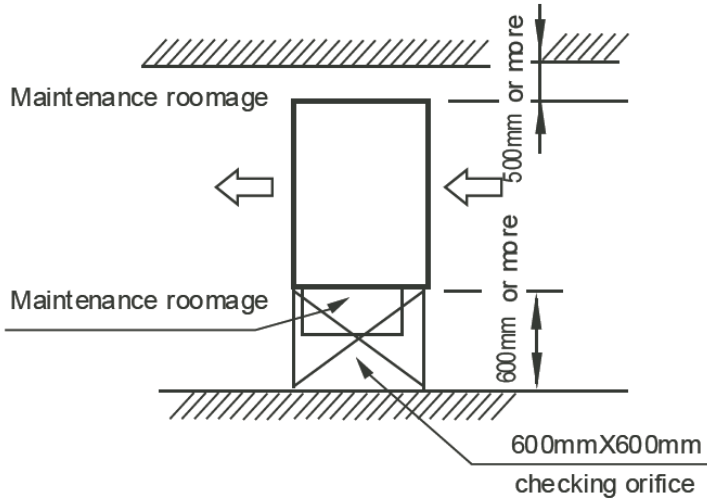

5. Piping Diagrams

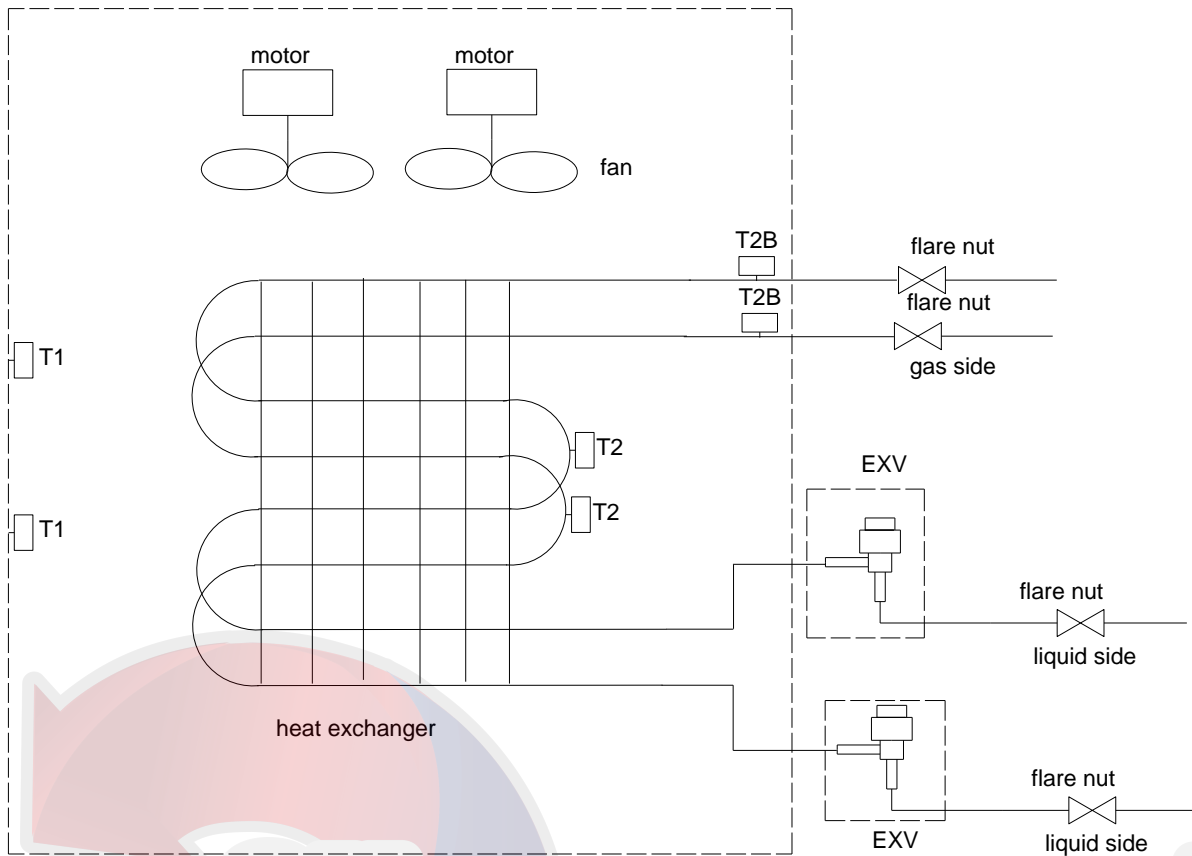

6. Wiring Diagrams

MDV-D125T1/VN1-FA, MDV-D140T1/VN1-FA

202085790026

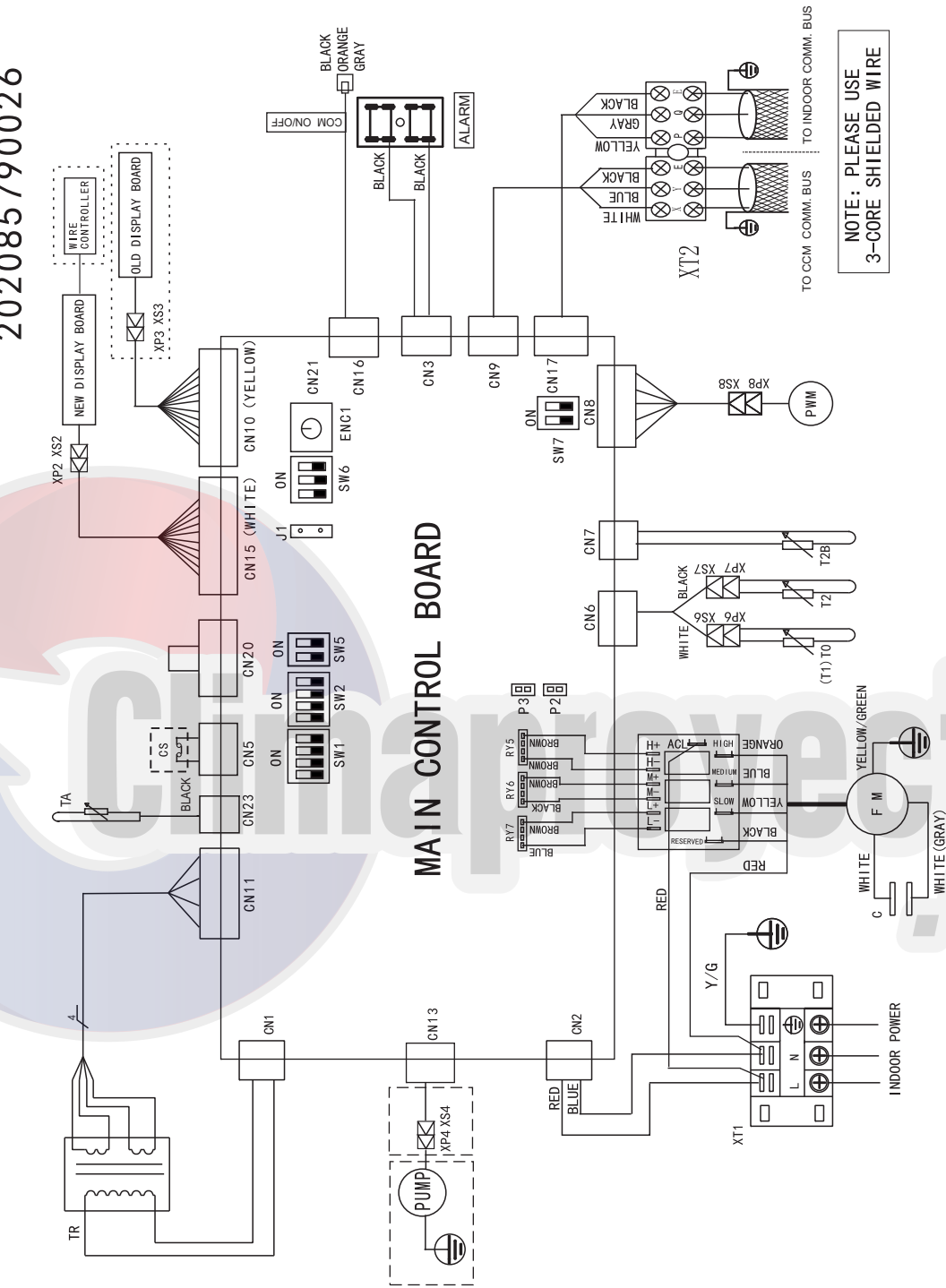

NOTE: PLEASE USE 3-CORE SHIELDED WIRE

CODE	TITLE
FM	INDOOR FAN MOTOR
PWM	PULSE MOTOR EXPANSION VALVE
TA	OUTLET AIR TEMP.
T0, T1	INLET AIR TEMP.
T2B	OUTER PIPE TEMP.
T2	MIDDLE PIPE TEMP.
XP1-8	CONNECTOR
XS1-8	TRANSFORMER
TR	FUSE
F	PROTECTOR SWITCH OVER HEAT
K	AUXILIARY HEATER
H	TERMINAL
XT1-3	OLD DISPLAY BOARD TERMINAL (YELLOW)
CN10	NEW DISPLAY BOARD TERMINAL (WHITE)
CN15	WATER LEVEL SWITCH
CS	PUMP MOTOR
J1	SWING MOTOR
GM	FAN MOTOR CAP.
C	

ENC1 SWITCH NUMBER	(FOR POWER)
0	2200W
1	2800W
2	3600W
3	4500W
4	5600W
5	7100W
6	8000W
7	9000W
8	10000W
	11200W
	12500W
	14000W

MDV-D200T11/VN1-FA, MDV-D250T11/VN1-FA, MDV-D280T11/VN1-FA

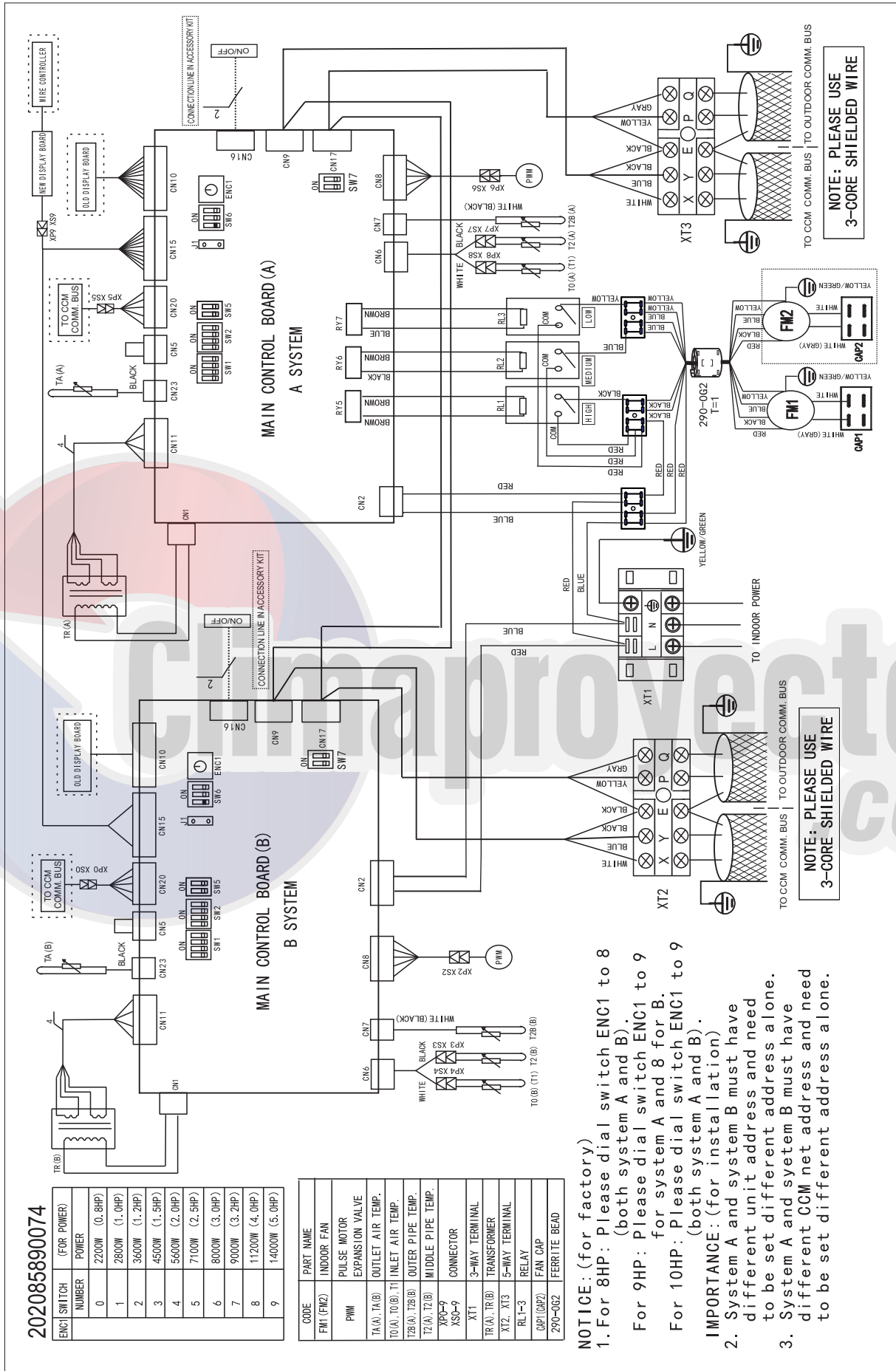

7. Capacity Tables

7.1 MDV-D125T1/VN1-FA

TC: total capacity WB: wet-bulb temperature DB: dry-bulb temperature

Cooling

Outdoor temperature	°C WB							
°C DB	15.0	17.0	20.0	23.0	26.0	28.0	30.0	32.0
	Capacity (TC)							
	KW	KW	KW	KW	KW	KW	KW	KW
20.0	5.6	6.1	/	/	/	/	/	/
22.0	6.3	6.9	7.5	/	/	/	/	/
25.0	6.8	7.5	8.3	8.9	/	/	/	/
27.0	/	8.0	8.8	9.5	/	/	/	/
29.0	/	/	9.2	10.0	10.8	/	/	/
31.0	/	/	9.6	10.5	11.3	12.0	/	/
33.0	/	/	9.9	10.9	11.8	12.5	13.3	/
35.0	/	/	/	11.1	12.2	13.1	13.8	14.4
38.0	/	/	/	/	12.8	13.7	14.4	15.1
43.0	/	/	/	/	13.4	14.3	15.0	15.8

Heating

Outdoor temperature	°C WB								
°C DB	-7.0	-5.2	-2.9	0.0	2.0	4.0	6.0	10.0	14.0
	Capacity (TC)								
	KW	KW	KW	KW	KW	KW	KW	KW	KW
-5.0	8.9	8.7	/	/	/	/	/	/	/
0.0	/	/	10.5	/	/	/	/	/	/
3.0	/	/	11.1	10.9	9.8	/	/	/	/
7.0	/	/	/	/	12.1	12.0	11.8	/	/
11.0	/	/	/	/	/	13.7	13.5	13.4	/
15.0	/	/	/	/	/	/	15.8	15.6	15.4

7.2 MDV-D140T1/VN1-FA

TC: total capacity **WB:** wet-bulb temperature **DB:** dry-bulb temperature

Cooling

Outdoor temperature	°C WB							
°C DB	15.0	17.0	20.0	23.0	26.0	28.0	30.0	32.0
	Capacity (TC)							
	KW	KW	KW	KW	KW	KW	KW	KW
20.0	6.3	6.8	/	/	/	/	/	/
22.0	7.0	7.8	8.4	/	/	/	/	/
25.0	7.6	8.4	9.2	10.0	/	/	/	/
27.0	/	8.9	9.8	10.7	/	/	/	/
29.0	/	/	10.3	11.2	12.1	/	/	/
31.0	/	/	10.7	11.7	12.6	13.5	/	/
33.0	/	/	11.1	12.2	13.2	14.0	14.8	/
35.0	/	/	/	12.5	13.7	14.6	15.4	16.2
38.0	/	/	/	/	14.3	15.3	16.1	16.9
43.0	/	/	/	/	15.0	16.0	16.8	17.7

Heating

Outdoor temperature	°C WB								
°C DB	-7.0	-5.2	-2.9	0.0	2.0	4.0	6.0	10.0	14.0
	Capacity (TC)								
	KW	KW	KW	KW	KW	KW	KW	KW	KW
-5.0	10.2	10.0	/	/	/	/	/	/	/
0.0	/	/	12.0	/	/	/	/	/	/
3.0	/	/	12.7	12.5	11.2	/	/	/	/
7.0	/	/	/	/	13.8	13.7	13.5	/	/
11.0	/	/	/	/	/	15.6	15.4	15.3	/
15.0	/	/	/	/	/	/	18.0	17.8	17.6

7.3 MDV-D200T1/VN1-FA

TC: total capacity WB: wet-bulb temperature DB: dry-bulb temperature

Cooling

Outdoor temperature	°C WB							
°C DB	15.0	17.0	20.0	23.0	26.0	28.0	30.0	32.0
	Capacity (TC)							
	KW	KW	KW	KW	KW	KW	KW	KW
20.0	9.0	9.7	/	/	/	/	/	/
22.0	10.0	11.1	12.0	/	/	/	/	/
25.0	10.8	12.0	13.2	14.3	/	/	/	/
27.0	/	12.7	14.0	15.3	/	/	/	/
29.0	/	/	14.7	16.0	17.3	/	/	/
31.0	/	/	15.3	16.7	18.0	19.3	/	/
33.0	/	/	15.8	17.4	18.8	20.0	21.2	/
35.0	/	/	/	17.8	19.6	20.9	22.0	23.1
38.0	/	/	/	/	20.5	21.8	23.0	24.1
43.0	/	/	/	/	21.4	22.8	24.0	25.2

Heating

Outdoor temperature	°C WB								
°C DB	-7.0	-5.2	-2.9	0.0	2.0	4.0	6.0	10.0	14.0
	Capacity (TC)								
	KW	KW	KW	KW	KW	KW	KW	KW	KW
-5.0	15.2	14.9	/	/	/	/	/	/	/
0.0	/	/	18.0	/	/	/	/	/	/
3.0	/	/	19.1	18.7	16.8	/	/	/	/
7.0	/	/	/	/	20.7	20.5	20.3	/	/
11.0	/	/	/	/	/	23.4	23.2	22.9	/
15.0	/	/	/	/	/	/	27.0	26.7	26.5

7.4 MDV-D250T1/VN1-FA

TC: total capacity **WB:** wet-bulb temperature **DB:** dry-bulb temperature

Cooling

Outdoor temperature	°C WB							
	15.0	17.0	20.0	23.0	26.0	28.0	30.0	32.0
°C DB	Capacity (TC)							
	KW	KW	KW	KW	KW	KW	KW	KW
20.0	11.2	12.1	/	/	/	/	/	/
22.0	12.5	13.9	15.0	/	/	/	/	/
25.0	13.5	15.0	16.5	17.9	/	/	/	/
27.0	/	15.9	17.5	19.1	/	/	/	/
29.0	/	/	18.4	20.0	21.6	/	/	/
31.0	/	/	19.1	20.9	22.5	24.1	/	/
33.0	/	/	19.8	21.8	23.5	25.0	26.5	/
35.0	/	/	/	22.3	24.5	26.1	27.5	28.9
38.0	/	/	/	/	25.6	27.3	28.7	30.2
43.0	/	/	/	/	26.7	28.5	30.0	31.5

Heating

Outdoor temperature	°C WB								
	-7.0	-5.2	-2.9	0.0	2.0	4.0	6.0	10.0	14.0
°C DB	Capacity (TC)								
	KW	KW	KW	KW	KW	KW	KW	KW	KW
-5.0	16.9	16.6	/	/	/	/	/	/	/
0.0	/	/	20.0	/	/	/	/	/	/
3.0	/	/	21.2	20.8	18.7	/	/	/	/
7.0	/	/	/	/	23.0	22.8	22.5	/	/
11.0	/	/	/	/	/	26.0	25.7	25.5	/
15.0	/	/	/	/	/	/	30.0	29.7	29.4

7.5 MDV-D280T1/VN1-FA

TC: total capacity **WB:** wet-bulb temperature **DB:** dry-bulb temperature

Cooling

Outdoor temperature	°C WB							
°C DB	15.0	17.0	20.0	23.0	26.0	28.0	30.0	32.0
	Capacity							
	KW	KW	KW	KW	KW	KW	KW	KW
20.0	12.5	13.6	/	/	/	/	/	/
22.0	14.0	15.5	16.8	/	/	/	/	/
25.0	15.1	16.8	18.5	20.0	/	/	/	/
27.0	/	17.8	19.6	21.4	/	/	/	/
29.0	/	/	20.6	22.4	24.2	/	/	/
31.0	/	/	21.4	23.4	25.2	27.0	/	/
33.0	/	/	22.1	24.4	26.3	28.0	29.7	/
35.0	/	/	/	24.9	27.4	29.3	30.8	32.3
38.0	/	/	/	/	28.6	30.6	32.2	33.8
43.0	/	/	/	/	29.9	32.0	33.6	35.3

Heating

Outdoor temperature	°C WB								
°C DB	-7.0	-5.2	-2.9	0.0	2.0	4.0	6.0	10.0	14.0
	Capacity								
	KW	KW	KW	KW	KW	KW	KW	KW	KW
-5.0	18.6	18.3	/	/	/	/	/	/	/
0.0	/	/	22.0	/	/	/	/	/	/
3.0	/	/	23.3	22.9	20.6	/	/	/	/
7.0	/	/	/	/	25.3	25.0	24.8	/	/
11.0	/	/	/	/	/	28.6	28.3	28.0	/
15.0	/	/	/	/	/	/	33.0	32.7	32.3

8. Electrical Characteristics

Model	Indoor Unit				Power Supply		IFM	
	Hz	Voltage	Min.	Max.	MCA	MFA	KW	FLA
MDV-D125T1/VN1-FA	60	220-240V	198V	254V	2.4	5	0.3	2
MDV-D140T1/VN1-FA	60	220-240V	198V	254V	2.4	5	0.3	2
MDV-D200T11/VN1-FA	60	220-240V	198V	254V	5.3	10	0.25 (×2)	4.8
MDV-D250T1/VN1-FA	60	220-240V	198V	254V	5.6	10	0.25 (×2)	4.8
MDV-D280T1/VN1-FA	60	220-240V	198V	254V	5.6	10	0.25 (×2)	4.8

Remark:

MCA: Min. Current Amps. (A)

MFA: Max. Fuse Amps. (A)

KW: Fan Motor Rated Output (KW)

FLA: Full Load Amps. (A)

IFM: Indoor Fan Motor



9. Fan Performance

How to Read the Diagram

The vertical axis is the External Static Pressure (Pa) while the horizontal axis represents the Air Flow (CFM). The characteristic curve for the “H,” “M,” and “L” fan speed control, The nameplate values are shown based on the “H” air flow.

Therefore in the case of 140T1 Type, the air flow is 436 CFM , while the External Static Pressure is 185Pa at “L” position. And 789 CFM is 185Pa, at ‘H’ position.

MDV-D125T1/VN1-FA MDV-D140T1/VN1-FA

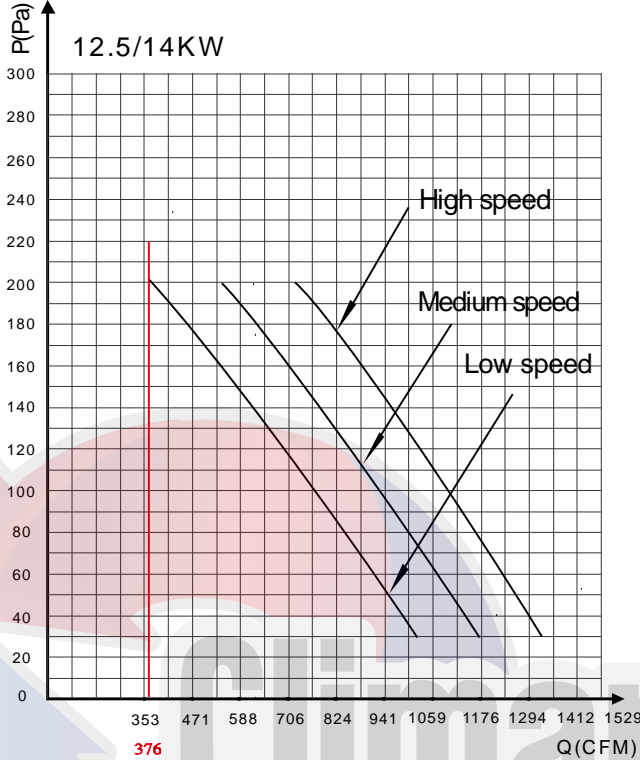

MDV-D200T1/VN1-FA

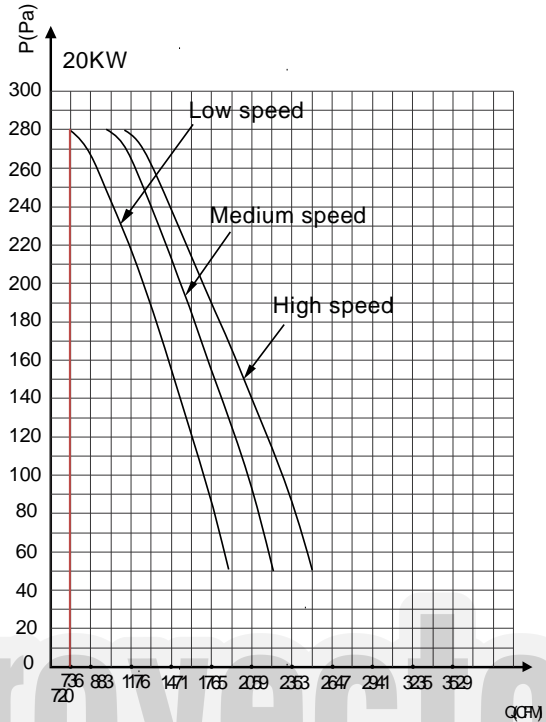

MDV-D250T1/VN1-FA MDV-D280T1/VN1-FA

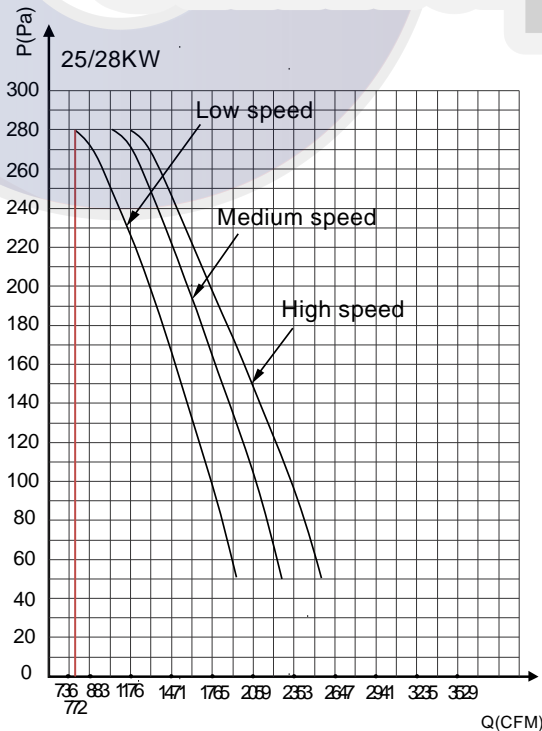

- If the external static pressure is too great (due to long extension of duct, for example), the air flow volume may drop too low at each air outlet.
- So there’s a limit air flow volume line for each speed, which is the min. airflow of this duct unit. At this flow volume, the fan achieves the max. ESP and indoor evaporator may protect by low temp.
- As well, there’s a limit airflow volume, which is the max. Value at each speed. It requests the unit to connect duct for air-inlet and outlet, to prevent damage from the high temp. of motor/evaporator.
- This is the available static pressure range which means the unit can run stably in this static pressure range, and the optimal static pressure range please refers to the Installation Manual.
- When choosing any static pressure which is out of optimal static pressure range, risk like bigger noise, lower air flow volume etc. should be considered in advanced.

10. Sound Levels

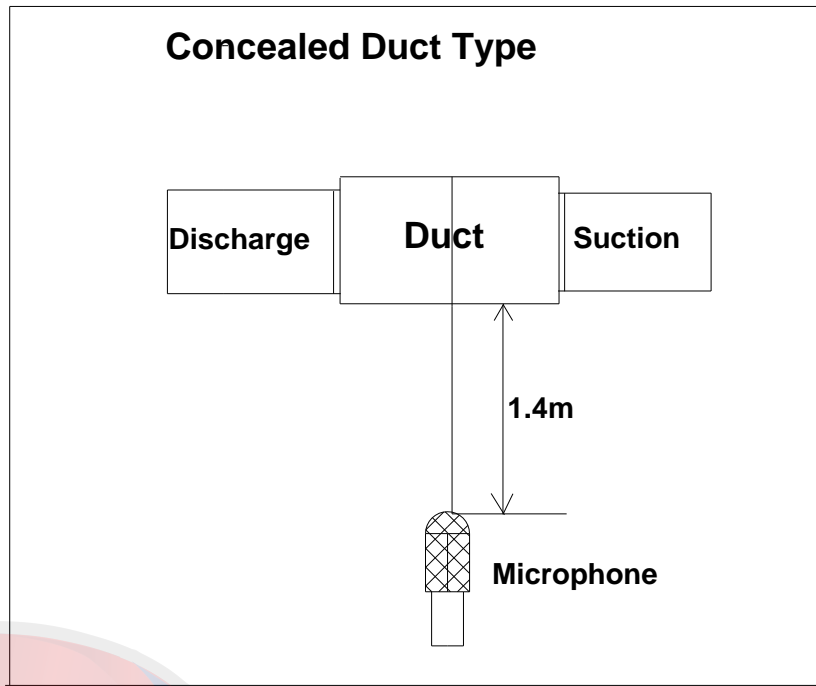

Unit Number	Model	Noise level under three speeds of fan (dB(A))		
		H	M	L
1	MDV-D125T1/VN1-FA	54	52	50
2	MDV-D140T1/VN1-FA	54	52	50
3	MDV-D200T1/VN1-FA	54	53	51
4	MDV-D250T1/VN1-FA	55	54	52
5	MDV-D280T1/VN1-FA	55	54	52

MDV-D125T1/VN1-FA

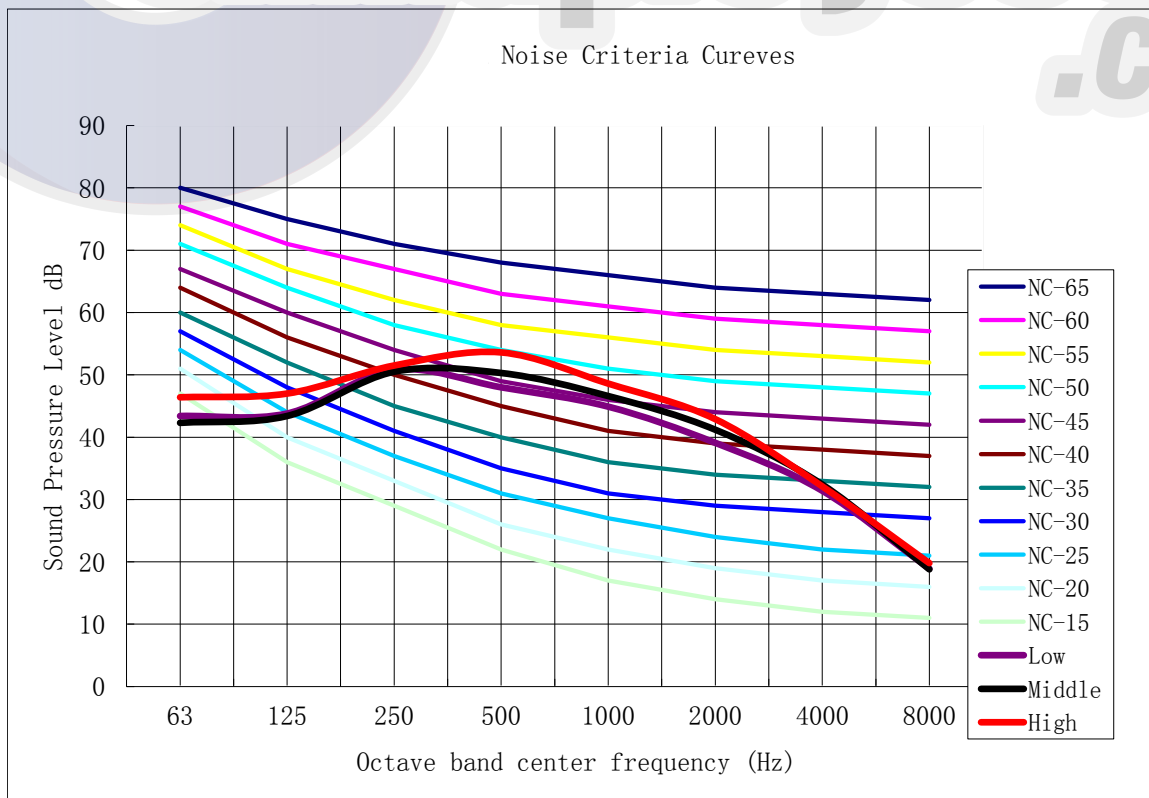

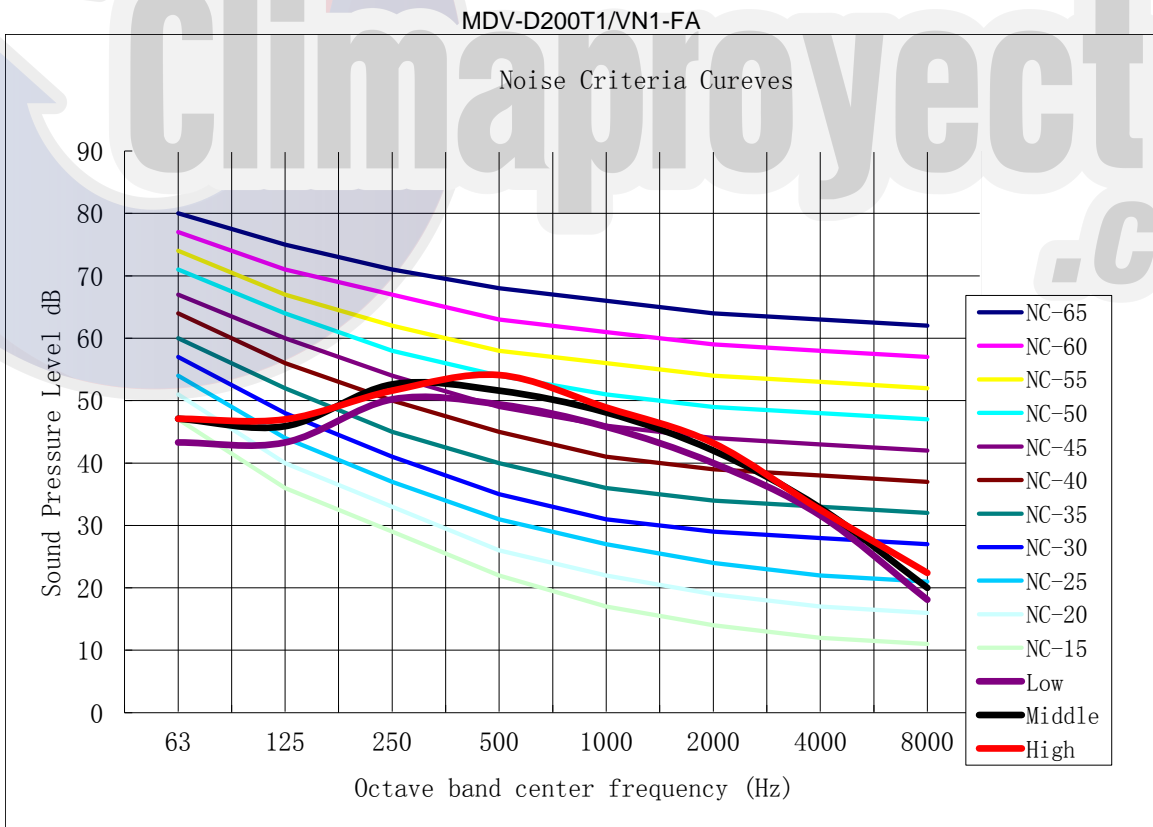
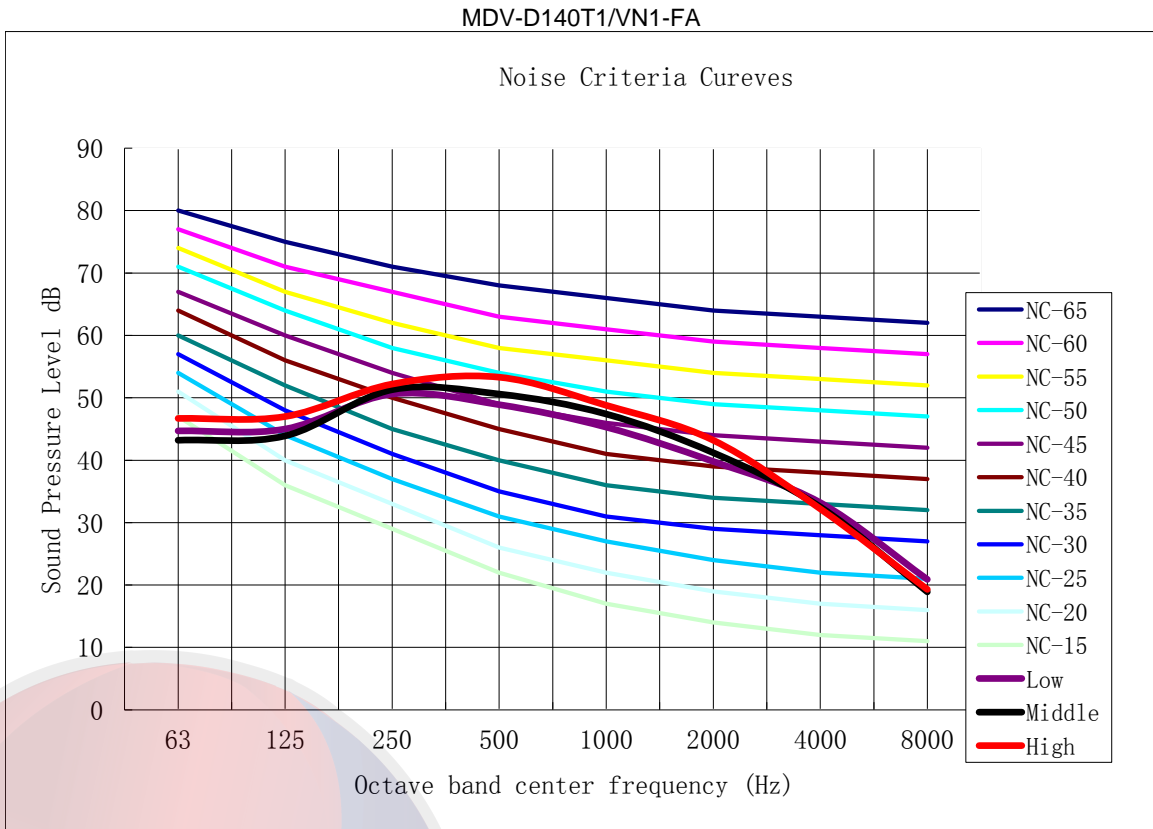

MDV-D250T1/VN1-FA

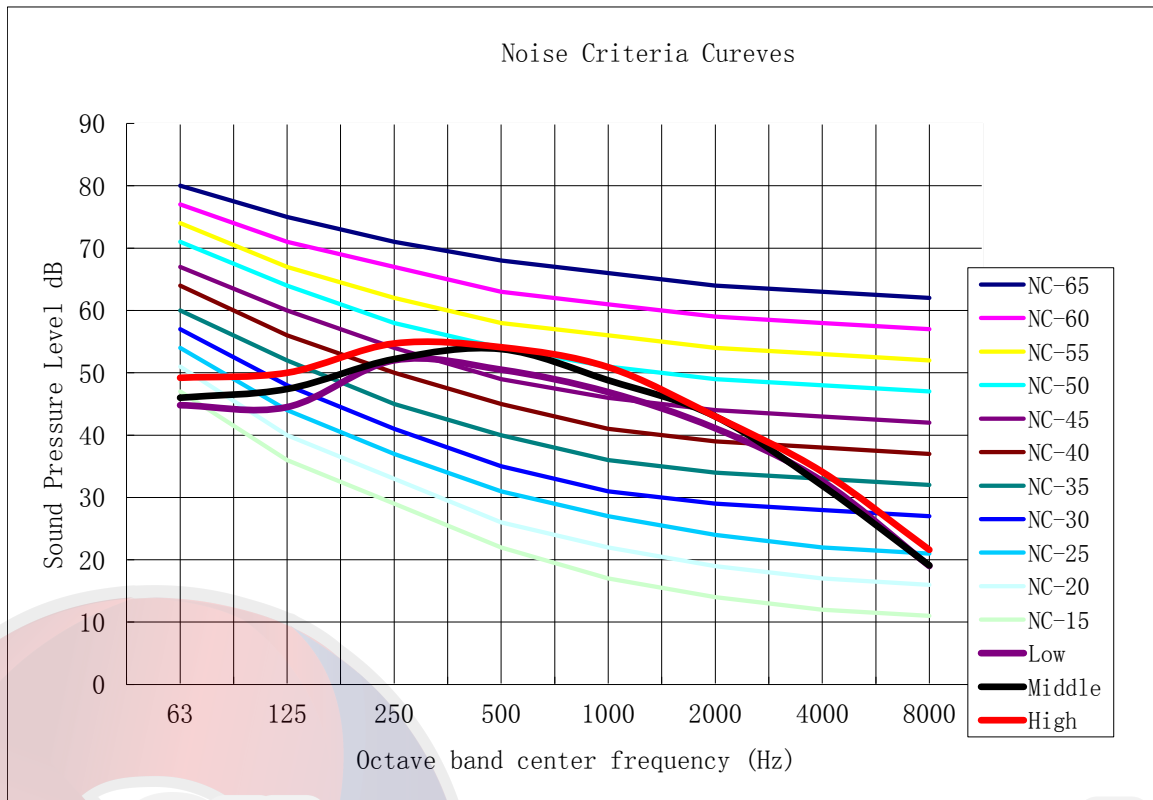

MDV-D280T1/VN1-FA

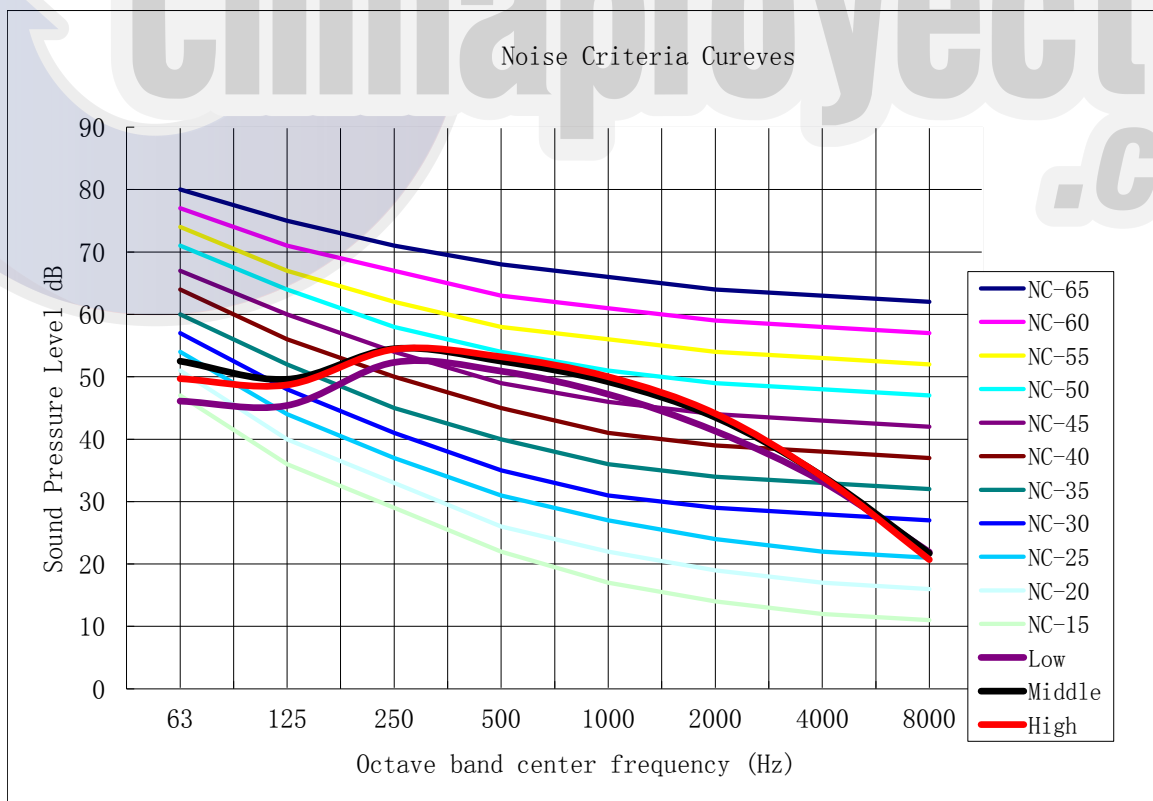

11. Accessories

Name	Quantity	Function
Installation manual	1	/
Pipe insulation material	2	Heat insulation
Accessory drain pipe	1	To connect drain pipe
Adhesive tape for seal	1	To connect drain pipe
Adhesive tape for seal	1	To connect refrigerant pipe
Wire controller(KJR-12B)	1	To control the air-conditioner
Connective pipe	2	To connect electrical restriction assembly
controller manual	1	/





GD Midea Heating & Ventilating Equipment Co., Ltd.
Is certified under the ISO 14001 International standard
for environmental management.
Certificate No.15912E10020R0L



GD Midea Heating & Ventilating Equipment Co., Ltd.
Is certified under the ISO 9001 International standard
for quality assurance.
NO.01 100 019209



GD Midea Heating & Ventilating Equipment Co., Ltd.
Certificate of Occupational Health and Safety Management System
Certificate No. 15912S20006R0L-1.

Commercial Air Conditioner Division Midea Group

Address: Midea Headquarters Building, 6 Midea Avenue, Beijiao, Shunde, Foshan,
Guangdong, China

Postal code: 528311

Tel: +86-757-26338346 Fax: +86-757-22390205

cac.midea.com global.midea.com

Note: The data in this book may be changed without notice for further improvement on
quality and performance.

Midea CAC After-service Application



iOS Version

Midea CAC News Application



Android Version



iOS Version