

Goodman® TECHNICAL MANUAL

GSC13 SEER Condensing Units with R-22

- Refer to Service Manual RS6100004 for installation, operation, and troubleshooting information.
- All safety information must be followed as provided in the Service Manual.
- Refer to the appropriate Parts Catalog for part number information.
- Models listed on page 3.

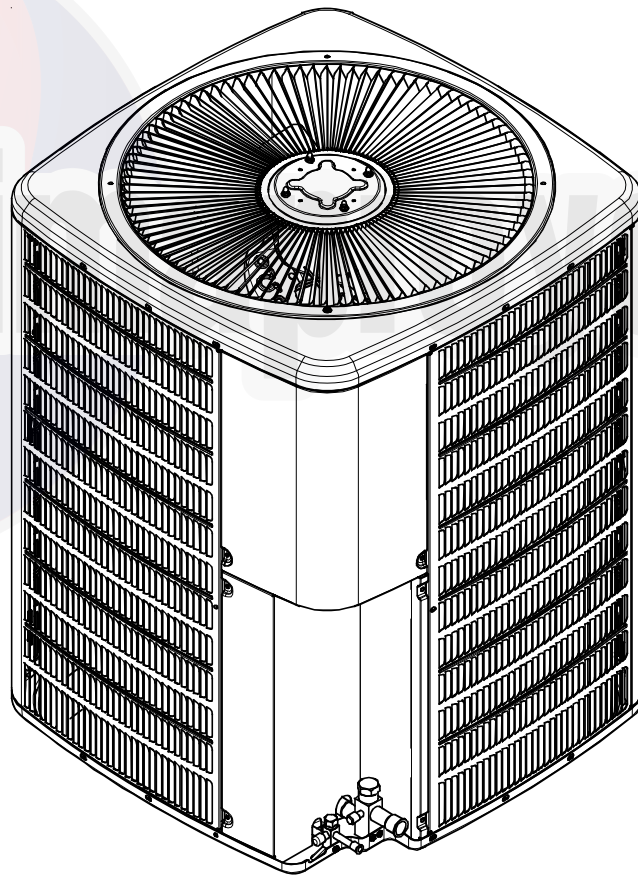

This manual is to be used by qualified, professionally trained HVAC technicians only. Goodman does not assume any responsibility for property damage or personal injury due to improper service procedures or services performed by an unqualified person.

RT6112015r1
August 2014

Copyright © 2011, 2014 Goodman Manufacturing Company, L.P.

PRODUCT IDENTIFICATION

The model number is used for positive identification of component parts used in manufacturing. Please use this number when requesting service or parts information.

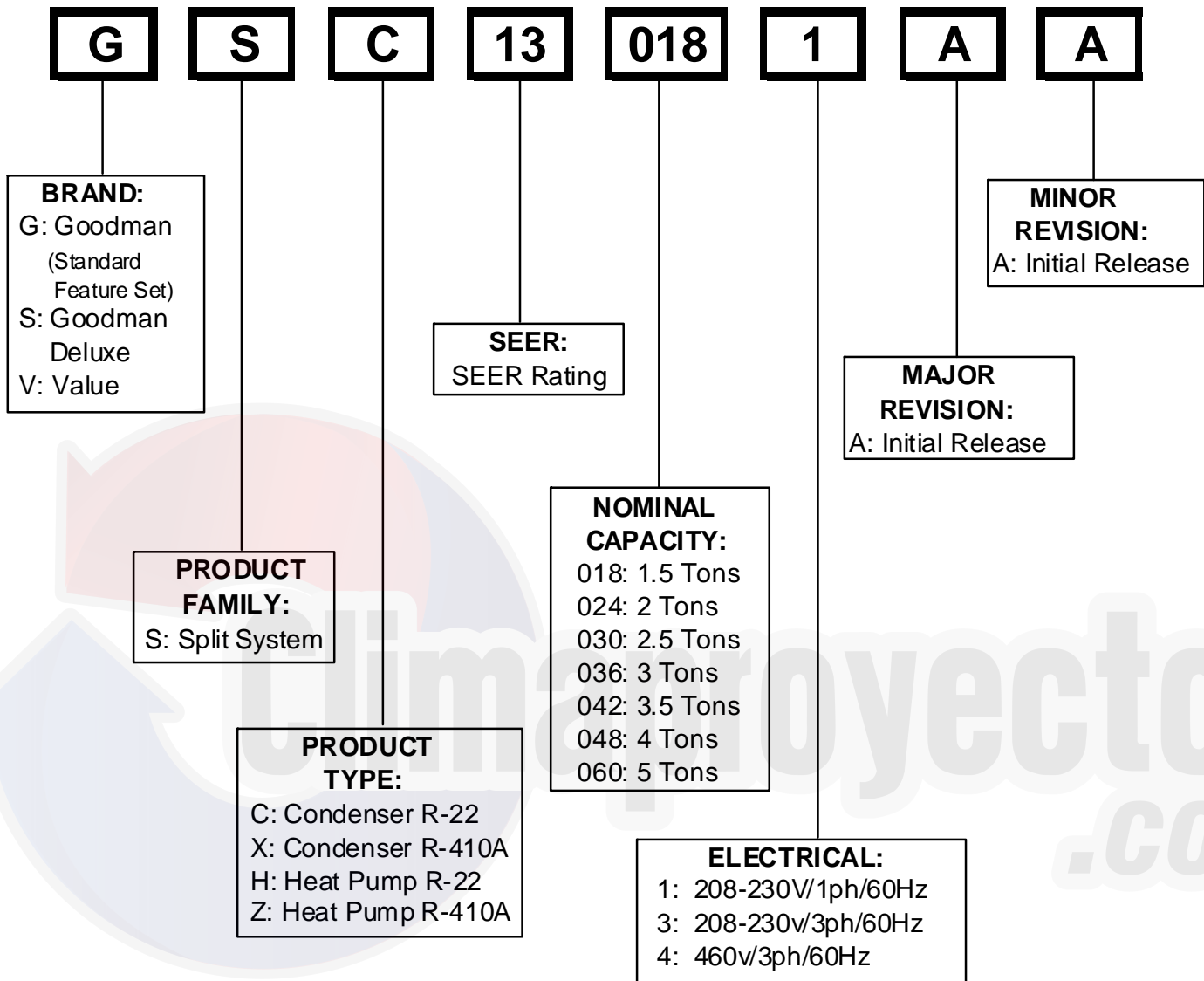

WARNING

HIGH VOLTAGE!

Disconnect ALL power before servicing or installing this unit. Multiple power sources may be present. Failure to do so may cause property damage, personal injury or death.



WARNING

Goodman will not be responsible for any injury or property damage arising from improper service or service procedures. If you install or perform service on this unit, you assume responsibility for any personal injury or property damage which may result. Many jurisdictions require a license to install or service heating and air conditioning equipment.



WARNING

Installation and repair of this unit should be performed ONLY by individuals meeting (at a minimum) the requirements of an "entry level technician" as specified by the Air-Conditioning, Heating, and Refrigeration Institute (AHRI). Attempting to install or repair this unit without such background may result in product damage, personal injury or death.

PRODUCT IDENTIFICATION

The model number is used for positive identification of component parts used in manufacturing. Please use this number when requesting service or parts information.

GSC130181A*
GSC130241A*
GSC130301A*
GSC130421A*
GSC130481A*

GSC130363B*
GSC130483B*
GSC130603B*

GSC130181B*
GSC130421B*
GSC130481B*
GSC130601B*

GSC130484A*
GSC130604A*

GSC130484B*
GSC130604B*

GSC130181C*
GSC130301C*
GSC130601C*

GSC130241D*
GSC130301D*
GSC130361D*

GSC130361F*

GSC130363A*
GSC130483A*
GSC130603A*

** Indicates minor revision & is not used for order entry or inventory management*

 **WARNING**

The United States Environmental Protection Agency (“EPA”) has issued various regulations regarding the introduction and disposal of refrigerants introduced into this unit. Failure to follow these regulations may harm the environment and can lead to the imposition of substantial fines. These regulations may vary by jurisdiction. Should questions arise, contact your local EPA office.

 **WARNING**

Do not connect or use any device that is not design certified by Goodman for use with this unit. Serious property damage, personal injury, reduced unit performance and/or hazardous conditions may result from the use of such non-approved devices.

 **WARNING**

To prevent the risk of property damage, personal injury, or death, do not store combustible materials or use gasoline or other flammable liquids or vapors in the vicinity of this appliance.

PRODUCT DESIGN

GSC 13 SEER models are available in 1 1/2 through 5 ton sizes. They are designed for 208/230 volt single phase applications. Select GSC 3 phase models are available in 230V and/or 460V.

The condenser air is pulled through the condenser coil by a direct drive propeller fan. This condenser air is then discharged out of the top of the cabinet.

These units are designed for free air discharge, so no additional resistance like duct work shall be attached.

The suction and liquid line connections on present models are of the sweat type for field piping with refrigerant type copper. Back seating valves are factory installed to accept the field run copper. The total refrigerant charge for a normal installation is factory installed in the condensing unit. GSC/VSC units are charged for the matching evaporator coil and a 15 foot refrigerant line set.

Systems should be properly sized by heat gain and loss calculations made according to methods of the Air Conditioning Contractors Association (ACCA) or equivalent. It is the contractors responsibility to ensure the system has adequate capacity to heat or cool the conditioned space.

Some GSC condensing units use a mix of Copeland Reciprocating® and Copeland Compliant® Scroll compressors. There are a number of design characteristics which are different from the scroll compared to the traditional reciprocating compressor.

Due to their design Scroll compressors are inherently more tolerant of liquid refrigerant.

NOTE: Even though the compressor section of a Scroll compressor is more tolerant of liquid refrigerant, continued flood-back or flooded start conditions may wash oil from the bearing surfaces causing premature bearing failure.

Copeland Compliant® Scroll compressors use white oil which is compatible with 3GS. 3GS oil may be used if additional oil is required.

The GSC/VSC condensers use new generation scroll compressors, except for the GSC130181C* which use a rotary compressor. The scroll compressors have an internal equalization mechanism and an anti-counter rotation device which allow the scrolls to equalize in approximately 1/2 second at shut down.

Operating pressures, amp draws and minimum circuit ampacity may differ from standard reciprocating compressors. This information may be found in the "Cooling Performance Data" section and should be reviewed prior to installation of the condenser.

GSC130361DF use Bristol® BENCHMARK™ compressors, the most advanced compressors in the industry today. The BENCHMARK™ reciprocating compressor can be recognized by a "J" in the fourth character of the compressor model number. Innovative mechanical design and gas management make the BENCHMARK™ compressor very efficient and remarkably quiet. The sound content (frequency) delivers exceptional acoustical characteristics and the virtually round housing design is compact and also helps to reduce the overall sound and vibration.

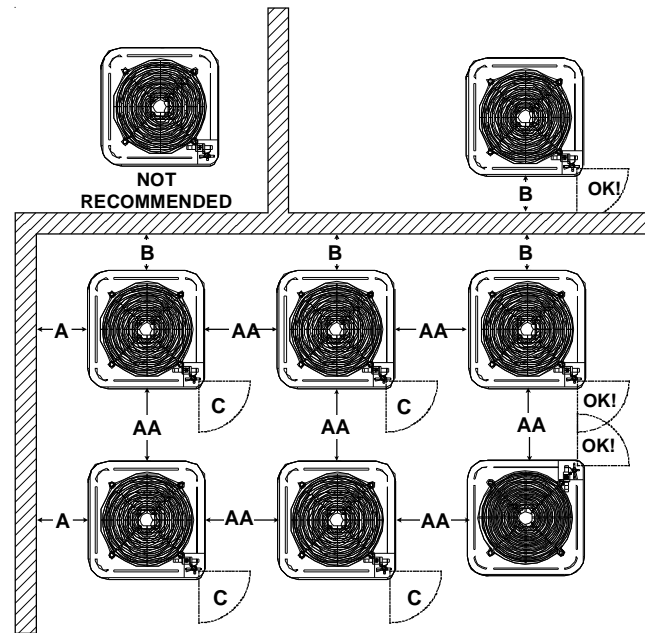

Minimum Airflow Clearances				
Model Type	A	B	C	AA
Residential	10"	10"	18"	20"
Light Commercial	12"	12"	18"	24"

Special consideration must be given to location of the condensing unit(s) in regard to structures, obstructions, other units, and any/all other factors that may interfere with air circulation. Where possible, the top of the unit should be completely unobstructed; however, if vertical conditions require placement beneath an obstruction **there should be a minimum of 60 inches between the top of the unit and the obstruction(s)**. The specified dimensions meet requirements for air circulation only. Consult all appropriate regulatory codes prior to determining final clearances.

Another important consideration in selecting a location for the unit(s) is the angle to obstructions. Either side adjacent the valves can be placed toward the structure provided the side away from the structure maintains minimum service clearance. Corner installations are strongly discouraged.

DO NOT locate the unit:

- Directly under a vent termination for a gas appliance.
- Within 3 feet of a clothes dryer vent.
- Where the refreezing of defrost water would create a hazard.
- Where water may rise into the unit.

PRODUCT DESIGN

GSC130[18-60]**

Dimensions

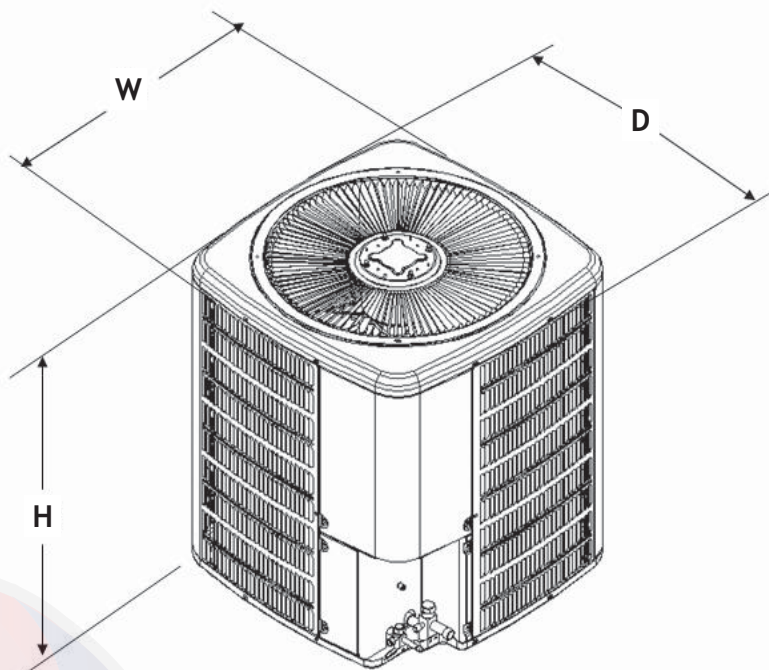

Model	Dimensions W x D x H
GSC130181A*	26 x 26 x 29¼
GSC130181B*/C*	26 x 26 x 27½
GSC130241A*	26 x 26 x 34¼
GSC130241D*	26 x 26 x 27½
GSC130301A*	26 x 26 x 34¼
GSC130301C*	26 x 26 x 34¼
GSC130301D*	26 x 26 x 30¼
GSC130361D*	29 x 29 x 34¼
GSC130361F*	29 x 29 x 30¼
GSC130421A*	29 x 29 x 34¼
GSC130421B*	29 x 29 x 30¼
GSC130481A*	29 x 29 x 38¼
GSC130481B*	29 x 29 x 34¼
GSC130601B*	35½ x 35½ x 38¼
GSC130601C*	29 x 29 x 40

Model	Dimensions W x D x H
GSC130363A*	29 x 29 x 34¼
GSC130363B*	29 x 29 x 30¼
GSC130483A*	29 x 29 x 38¼
GSC130483B*	29 x 29 x 34¼
GSC130603A*	35½ x 35½ x 38¼
GSC130603B*	29 x 29 x 40
GSC130484A*	29 x 29 x 38¼
GSC130484B*	29 x 29 x 34¼
GSC130604A*	35½ x 35½ x 38¼
GSC130604B*	29 x 29 x 40

CONDENSING UNIT SPECIFICATIONS

GSC130[18-36]1*

GSC130181A* - GSC130181D*

	GSC130181A*	GSC130181BA	GSC130181C*	GSC130241A*	GSC130241D*
Nominal Cooling Capacity, BTUH	18,000	18,000	18,000	24,000	24,000
Compressor					
R.L. Amps	6.2	6.2	6.78	7.7	7.8
L.R. Amps	35	35	40	40	40
Condenser Fan Motor					
Horsepower	1/6	1/6	1/6	1/6	1/6
F.L. Amps	1.5	1.5	1.5	1.5	1.1
Refrigerant Line Size					
Liquid Line, Inches O.D.	3/8"	3/8"	3/8"	3/8"	3/8"
Suction Line, Inches O.D.	3/4"	3/4"	3/4"	3/4"	3/4"
Refrigerant Connection Size					
Liquid Valve Size O.D.	3/8"	3/8"	3/8"	3/8"	3/8"
Suction Valve Size O.D.	3/4"	3/4"	3/4"	3/4"	3/4"
Refrigerant Charge	89	81	67	93	83
Power Supply	208/230-60-1	208/230-60-1	208/230-60-1	208/230-60-1	208/230-60-1
Minimum Circuit Ampacity ⁽¹⁾	9.3	9.3	9.98	11.2	10.9
Maximum Overcurrent Device ⁽²⁾	15	15	15	15	15
Electrical Conduit Size					
Power Supply (Inches)	1/2 or 3/4	1/2 or 3/4	1/2 or 3/4	1/2 or 3/4	1/2 or 3/4
Approximate Shipping Weight	173	145	128	195	195

GSC130241A* - GSC130301D*

	GSC130301A*	GSC130301C*	GSC130301D*	GSC130361DE	GSC130361DF	GSC130361F*
Nominal Cooling Capacity, BTUH	30,000	30,000	30,000	36,000	36,000	36,000
Compressor						
R.L. Amps	9.7	9.7	9.7	12.2	12.1	12.2
L.R. Amps	49	49	49	73	68	73
Condenser Fan Motor						
Horsepower	1/6	1/6	1/6	1/6	1/6	1/6
F.L. Amps	1.5	1.1	1.1	1.5	1.5	1.1
Refrigerant Line Size						
Liquid Line, Inches O.D.	3/8"	3/8"	3/8"	3/8"	3/8"	3/8"
Suction Line, Inches O.D.	3/4"	3/4"	3/4"	7/8"	7/8"	7/8"
Refrigerant Connection Size						
Liquid Valve Size O.D.	3/8"	3/8"	3/8"	3/8"	3/8"	3/8"
Suction Valve Size O.D.	3/4"	3/4"	3/4" ⁽³⁾	3/4" ⁽³⁾	3/4" ⁽³⁾	3/4" ⁽³⁾
Refrigerant Charge	117	106	87	119	120	83
Power Supply	208/230-60-1	208/230-60-1	208/230-60-1	208/230-60-1	208/230-60-1	208/230-60-1
Minimum Circuit Ampacity ⁽¹⁾	13.6	13.0	13.2	16.8	15.5	16.4
Maximum Overcurrent Device ⁽²⁾	20	20	20	25	25	25
Electrical Conduit Size						
Power Supply (Inches)	1/2 or 3/4	1/2 or 3/4	1/2 or 3/4	1/2 or 3/4	1/2 or 3/4	1/2 or 3/4
Approximate Shipping Weight	195	172	172	199	205	205

⁽¹⁾ Wire size should be determined in accordance with National Electrical Codes; extensive wire runs will require larger wire sizes.

⁽²⁾ Maximum Overcurrent Protection Device:

MUST use Time Delay Fuse or HACR type Circuit Breaker of the same size as noted.

⁽³⁾ Installer will need to supply 3/4" to 7/8" adapters for suction line connectors

⁽⁴⁾ Installer will need to supply 7/8" to 1-1/8" adapters for suction line connections.

NOTE: This data is provided as a guide, it is important to electrically connect the unit and properly size fuses/circuit breakers and wires in accordance with all national and/or local electrical codes. Use copper wire only.

CONDENSING UNIT SPECIFICATIONS

GSC130361DE - GSC130421B*

	GSC130421A*	GSC130421B*	GSC130481A*	GSC130481AG	GSC130481B*
Nominal Cooling Capacity, BTUH	42,000	42,000	48,000	48,000	48,000
Compressor					
R.L. Amps	14.7	19.2	17.9	16.9	17.9
L.R. Amps	77	104	104	86	104
Condenser Fan Motor					
Horsepower	1/4	1/4	1/4	1/4	1/4
F.L. Amps	1.8	1.5	1.8	1.5	1.5
Refrigerant Line Size					
Liquid Line, Inches O.D.	3/8"	3/8"	3/8"	3/8"	3/8"
Suction Line, Inches O.D.	1-1/8"	1-1/8"	1-1/8"	1-1/8"	1-1/8"
Refrigerant Connection Size					
Liquid Valve Size O.D.	3/8"	3/8"	3/8"	3/8"	3/8"
Suction Valve Size O.D.	7/8" ⁴	7/8" ⁴	7/8" ⁴	7/8" ⁴	7/8" ⁴
Refrigerant Charge	135	95	158	145	102
Power Supply	208/230-60-1	208/230-60-1	208/230-60-1	208/230-60-1	208/230-60-1
Minimum Circuit Ampacity ⁽¹⁾	20.2	25.5	24.2	22.7	23.9
Maximum Overcurrent Device ⁽²⁾	30	40	40	40	40
Electrical Conduit Size					
Power Supply (Inches)	1/2 or 3/4	1/2 or 3/4	1/2 or 3/4	1/2 or 3/4	1/2 or 3/4
Approximate Shipping Weight	199	199	198	198	210

GSC130481A* - GSC130601C*

	GSC130601B*	GSC130601C*
Nominal Cooling Capacity, BTUH	60,000	57,000
Compressor		
R.L. Amps	25.0	19.9
L.R. Amps	148	137
Condenser Fan Motor		
Horsepower	1/6	1/4
F.L. Amps	1.1	1.5
Refrigerant Line Size		
Liquid Line, Inches O.D.	3/8"	3/8"
Suction Line, Inches O.D.	1-1/8"	1-1/8"
Refrigerant Connection Size		
Liquid Valve Size O.D.	3/8"	3/8"
Suction Valve Size O.D.	7/8" ⁴	7/8" ⁴
Refrigerant Charge	167	131
Power Supply	208/230-60-1	208/230-60-1
Minimum Circuit Ampacity ⁽¹⁾	32.3	26.4
Maximum Overcurrent Device ⁽²⁾	50	45
Electrical Conduit Size		
Power Supply (Inches)	1/2 or 3/4	1/2 or 3/4
Approximate Shipping Weight	242	242

⁽¹⁾ Wire size should be determined in accordance with National Electrical Codes; extensive wire runs will require larger wire sizes.

⁽²⁾ Maximum Overcurrent Protection Device:

MUST use Time Delay Fuse or HACR type Circuit Breaker of the same size as noted.

⁽³⁾ Installer will need to supply 3/4" to 7/8" adapters for suction line connectors

⁽⁴⁾ Installer will need to supply 7/8" to 1-1/8" adapters for suction line connections.

NOTE: This data is provided as a guide, it is important to electrically connect the unit and properly size fuses/circuit breakers and wires in accordance with all national and/or local electrical codes. Use copper wire only.

CONDENSING UNIT SPECIFICATIONS

GSC130363* - GSC130603*

	GSC130363A*	GSC130363B*	GSC130483A*	GSC130483B*	GSC130603A*	GSC130603B*
Nominal Cooling Capacity, BTUH	36,000	36,000	48,000	48,000	60,000	57,000
Compressor						
R.L. Amps	9.0	9.0	12.4	12.4	17.3	14.7
L.R. Amps	65.5	65.5	88.0	88.0	123.0	91.0
Condenser Fan Motor						
Horsepower	1/6	1/6	1/4	1/4	1/6	1/4
F.L. Amps	1.5	1.1	1.6	1.5	1.1	1.5
Refrigerant Line Size						
Liquid Line, Inches O.D.	3/8"	3/8"	3/8"	3/8"	3/8"	3/8"
Suction Line, Inches O.D.	7/8"	7/8"	1-1/8"	1-1/8"	1-1/8"	1-1/8"
Refrigerant Connection Size						
Liquid Valve Size O.D.	3/8"	3/8"	3/8"	3/8"	3/8"	3/8"
Suction Valve Size O.D.	3/4" ³	3/4" ³	7/8" ⁴	7/8" ⁴	7/8" ⁴	7/8" ⁴
Refrigerant Charge	119	83	150	102	167	131
Power Supply	208/230-60-3	208/230-60-3	208/230-60-3	208/230-60-3	208/230-60-3	208/230-60-3
Minimum Circuit Ampacity ⁽¹⁾	12.7	12.4	17.2	17	22.7	19.9
Maximum Overcurrent Device ⁽²⁾	20	20	20	20	40	30
Electrical Conduit Size						
Power Supply (Inches)	1/2 or 3/4	1/2 or 3/4	1/2 or 3/4	1/2 or 3/4	1/2 or 3/4	1/2 or 3/4
Approximate Shipping Weight	198	214	207	207	242	196

GSC130484* - GSC130604*

	GSC130484A*	GSC130484B*	GSC130604A*	GSC130604B*
Nominal Cooling Capacity, BTUH	48,000	48,000	60,000	60,000
Compressor				
R.L. Amps	5.8	5.8	6.7	7.1
L.R. Amps	44.0	44.0	49.5	50.0
Condenser Fan Motor				
Horsepower	1/4	1/4	1/6	1/4
F.L. Amps	0.8	0.8	0.6	0.8
Refrigerant Line Size				
Liquid Line, Inches O.D.	3/8"	3/8"	3/8"	3/8"
Suction Line, Inches O.D.	1-1/8"	1-1/8"	1-1/8"	1-1/8"
Refrigerant Connection Size				
Liquid Valve Size O.D.	3/8"	3/8"	3/8"	3/8"
Suction Valve Size O.D.	7/8" ⁴	7/8" ⁴	7/8" ⁴	7/8" ⁴
Refrigerant Charge	150	102	167	131
Power Supply	460	460	460	460
Minimum Circuit Ampacity ⁽¹⁾	8.0	8.1	9.0	9.7
Maximum Overcurrent Device ⁽²⁾	15	15	15	15
Electrical Conduit Size				
Power Supply (Inches)	1/2 or 3/4	1/2 or 3/4	1/2 or 3/4	1/2 or 3/4
Approximate Shipping Weight	207	189	242	185

⁽¹⁾ Wire size should be determined in accordance with National Electrical Codes; extensive wire runs will require larger wire sizes.

⁽²⁾ Maximum Overcurrent Protection Device:

MUST use Time Delay Fuse or HACR type Circuit Breaker of the same size as noted.

⁽³⁾ Installer will need to supply 3/4" to 7/8" adapters for suction line connectors

⁽⁴⁾ Installer will need to supply 7/8" to 1-1/8" adapters for suction line connections.

NOTE: This data is provided as a guide, it is important to electrically connect the unit and properly size fuses/circuit breakers and wires in accordance with all national and/or local electrical codes. Use copper wire only.

COOLING PERFORMANCE DATA

GSC130181A*

EXPANDED PERFORMANCE DATA

COOLING OPERATION

MODEL: GSC130181A* / CAUF1824A6A

IDB*	Airflow	Outdoor Ambient Temperature																								
		65				75				85				95				105				115				
		59	63	67	71	59	63	67	71	59	63	67	71	59	63	67	71	59	63	67	71	59	63	67	71	
70	675	MBh	18.6	19.3	21.1	-	18.2	18.8	20.7	-	17.8	18.4	20.2	-	17.3	18.0	19.7	-	16.5	17.1	18.7	-	15.2	15.8	17.3	-
		S/T	0.71	0.59	0.41	-	0.73	0.61	0.43	-	0.75	0.63	0.44	-	0.78	0.65	0.45	-	0.81	0.67	0.47	-	0.81	0.68	0.47	-
		Delta T	18	16	12	-	18	16	12	-	18	16	12	-	18	16	12	-	18	16	12	-	17	15	11	-
		KW	1.38	1.40	1.44	-	1.47	1.49	1.53	-	1.54	1.57	1.61	-	1.60	1.63	1.68	-	1.66	1.69	1.74	-	1.71	1.74	1.79	-
		AMPS	4.4	4.5	4.6	-	4.7	4.8	5.0	-	5.1	5.2	5.4	-	5.4	5.6	5.7	-	5.8	5.9	6.1	-	6.1	6.3	6.5	-
	600	HIPR	137	148	156	-	154	166	175	-	175	189	199	-	200	215	227	-	225	242	255	-	248	267	282	-
		LOPR	62	66	72	-	66	70	76	-	68	73	79	-	72	76	83	-	75	80	87	-	78	83	90	-
		MBh	18.1	18.7	20.5	-	17.7	18.3	20.0	-	17.2	17.9	19.6	-	16.8	17.4	19.1	-	16.0	16.6	18.1	-	14.8	15.3	16.8	-
		S/T	0.68	0.56	0.39	-	0.70	0.59	0.41	-	0.72	0.60	0.42	-	0.74	0.62	0.43	-	0.77	0.64	0.45	-	0.78	0.65	0.45	-
		Delta T	19	16	12	-	19	16	12	-	19	16	12	-	19	17	13	-	19	16	12	-	18	15	12	-
525	KW	1.37	1.40	1.43	-	1.46	1.48	1.52	-	1.53	1.56	1.60	-	1.59	1.62	1.67	-	1.65	1.68	1.72	-	1.70	1.73	1.77	-	
	AMPS	4.3	4.4	4.6	-	4.7	4.8	4.9	-	5.0	5.2	5.3	-	5.4	5.5	5.7	-	5.7	5.9	6.0	-	6.1	6.2	6.4	-	
	HIPR	136	146	155	-	153	164	173	-	174	187	197	-	198	213	225	-	222	239	253	-	246	264	279	-	
	LOPR	62	65	71	-	65	69	75	-	68	72	78	-	71	75	82	-	74	79	86	-	77	82	89	-	
	MBh	16.7	17.3	18.9	-	16.3	16.9	18.5	-	15.9	16.5	18.1	-	15.5	16.1	17.6	-	14.7	15.3	16.7	-	13.7	14.2	15.5	-	
75	675	S/T	0.65	0.54	0.38	-	0.68	0.56	0.39	-	0.69	0.58	0.40	-	0.72	0.60	0.41	-	0.74	0.62	0.43	-	0.75	0.63	0.43	-
		Delta T	19	16	13	-	19	17	13	-	19	17	13	-	19	17	13	-	19	17	13	-	18	16	12	-
		KW	1.35	1.37	1.40	-	1.43	1.45	1.49	-	1.50	1.52	1.56	-	1.56	1.59	1.63	-	1.61	1.64	1.69	-	1.66	1.69	1.74	-
		AMPS	4.2	4.3	4.4	-	4.5	4.6	4.8	-	4.9	5.0	5.2	-	5.2	5.4	5.5	-	5.6	5.7	5.9	-	5.9	6.0	6.2	-
		HIPR	132	142	150	-	148	159	168	-	168	181	191	-	192	206	218	-	216	232	245	-	238	257	271	-
	600	LOPR	60	63	69	-	63	67	73	-	66	70	76	-	69	73	80	-	72	77	84	-	75	79	87	-
		MBh	18.9	19.5	21.1	22.6	18.5	19.0	20.6	22.1	18.1	18.6	20.1	21.6	17.6	18.1	19.6	21.1	16.7	17.2	18.6	20.0	15.5	16.0	17.3	18.5
		S/T	0.81	0.72	0.55	0.35	0.84	0.75	0.57	0.36	0.86	0.77	0.58	0.37	0.88	0.79	0.60	0.39	0.92	0.82	0.62	0.40	0.93	0.83	0.63	0.40
		Delta T	21	19	16	11	21	19	16	11	21	19	16	11	21	20	16	11	21	19	16	11	20	18	15	10
		KW	1.39	1.41	1.45	1.49	1.47	1.50	1.54	1.58	1.55	1.58	1.62	1.66	1.62	1.64	1.69	1.74	1.67	1.70	1.75	1.80	1.72	1.75	1.80	1.85
525	AMPS	4.4	4.5	4.6	4.8	4.7	4.8	5.0	5.2	5.1	5.3	5.4	5.6	5.5	5.6	5.8	6.0	5.8	6.0	6.2	6.4	6.2	6.3	6.5	6.8	
	HIPR	139	149	158	164	156	168	177	185	177	191	201	210	202	217	229	239	227	244	258	269	251	270	285	297	
	LOPR	63	67	73	78	66	71	77	82	69	73	80	85	72	77	84	90	76	81	88	94	78	83	91	97	
	MBh	18.4	18.9	20.5	22.0	18.0	18.5	20.0	21.5	17.5	18.0	19.5	21.0	17.1	17.6	19.1	20.5	16.2	16.7	18.1	19.4	15.0	15.5	16.8	18.0	
	S/T	0.77	0.69	0.52	0.33	0.80	0.71	0.54	0.35	0.82	0.73	0.55	0.36	0.84	0.75	0.57	0.37	0.88	0.78	0.59	0.38	0.88	0.79	0.60	0.38	
70	675	Delta T	22	20	16	11	22	20	17	11	22	20	17	11	22	20	17	12	22	20	16	11	20	19	15	11
		KW	1.38	1.40	1.44	1.48	1.47	1.49	1.53	1.57	1.54	1.57	1.61	1.65	1.60	1.63	1.68	1.72	1.66	1.69	1.74	1.78	1.71	1.74	1.79	1.84
		AMPS	4.4	4.5	4.6	4.8	4.7	4.8	5.0	5.1	5.1	5.2	5.4	5.6	5.4	5.6	5.7	6.0	5.8	5.9	6.1	6.3	6.1	6.3	6.5	6.7
		HIPR	137	148	156	163	154	166	175	183	175	189	199	208	200	215	227	237	225	242	255	266	248	267	282	294
		LOPR	62	66	72	77	66	70	76	81	68	73	79	84	72	76	83	89	75	80	87	93	78	83	90	96
	600	MBh	17.0	17.5	18.9	20.3	16.6	17.1	18.5	19.8	16.2	16.7	18.0	19.4	15.8	16.3	17.6	18.9	15.0	15.4	16.7	17.9	13.9	14.3	15.5	16.6
		S/T	0.74	0.66	0.50	0.32	0.77	0.69	0.52	0.33	0.79	0.70	0.53	0.34	0.81	0.73	0.55	0.35	0.84	0.75	0.57	0.37	0.85	0.76	0.58	0.37
		Delta T	22	20	17	11	22	21	17	12	22	21	17	12	22	21	17	12	22	20	17	12	21	19	16	11
		KW	1.36	1.38	1.41	1.45	1.44	1.46	1.50	1.54	1.51	1.53	1.58	1.62	1.57	1.60	1.64	1.69	1.63	1.65	1.70	1.75	1.67	1.70	1.75	1.80
		AMPS	4.2	4.3	4.5	4.6	4.6	4.7	4.8	5.0	5.0	5.1	5.2	5.4	5.3	5.4	5.6	5.8	5.6	5.7	5.9	6.2	5.9	6.1	6.3	6.5
525	HIPR	133	143	151	158	150	161	170	177	170	183	193	202	194	208	220	230	218	235	248	258	241	259	274	285	
	LOPR	60	64	70	75	64	68	74	79	66	70	77	82	70	74	81	86	73	78	85	90	75	80	88	93	

* Entering Indoor Dry Bulb Temperature
NOTE: Shaded area is ACCA (TVA) conditions

COOLING PERFORMANCE DATA

GSC130181A*

EXPANDED PERFORMANCE DATA

COOLING OPERATION

MODEL: GSC130181A* / CAUF1824A6A

IDB*	Airflow	Outdoor Ambient Temperature																								
		65				75				85				95				105				115				
		59	63	67	71	59	63	67	71	59	63	67	71	59	63	67	71	59	63	67	71	59	63	67	71	
80	675	MBh	19.3	19.7	21.0	22.5	18.8	19.2	20.5	22.0	18.4	18.8	20.1	21.4	17.9	18.3	19.6	20.9	17.0	17.4	18.6	19.9	15.8	16.1	17.2	18.4
		S/T	0.88	0.83	0.67	0.50	0.92	0.86	0.70	0.52	0.94	0.88	0.72	0.54	0.97	0.91	0.74	0.55	1.00	0.94	0.77	0.57	1.00	0.95	0.77	0.58
		Delta T	23	22	19	15	23	23	20	16	24	23	20	16	24	23	20	16	23	22	19	16	21	21	18	15
		KW	1.40	1.42	1.46	1.50	1.48	1.51	1.55	1.59	1.56	1.59	1.63	1.67	1.63	1.66	1.70	1.75	1.68	1.71	1.76	1.81	1.73	1.76	1.81	1.86
		AMPS	4.4	4.5	4.7	4.8	4.8	4.9	5.0	5.2	5.2	5.3	5.5	5.7	5.5	5.7	5.8	6.1	5.9	6.0	6.2	6.4	6.2	6.4	6.6	6.8
		HIPR	140	151	159	166	157	169	179	186	179	193	203	212	204	219	232	242	229	247	260	272	253	273	288	300
		LOPR	63	67	74	78	67	71	78	83	70	74	81	86	73	78	85	90	77	82	89	95	79	84	92	98
		MBh	18.7	19.1	20.4	21.8	18.3	18.7	20.0	21.3	17.8	18.2	19.5	20.8	17.4	17.8	19.0	20.3	16.5	16.9	18.1	19.3	15.3	15.6	16.7	17.9
		S/T	0.84	0.79	0.64	0.48	0.87	0.82	0.67	0.50	0.90	0.84	0.68	0.51	0.92	0.87	0.71	0.53	0.96	0.90	0.73	0.55	0.97	0.91	0.74	0.55
		Delta T	24	23	20	16	24	23	20	16	24	23	20	16	25	24	21	16	24	23	20	16	23	22	19	15
KW	1.39	1.41	1.45	1.49	1.47	1.50	1.54	1.58	1.55	1.58	1.62	1.66	1.62	1.64	1.69	1.74	1.67	1.70	1.75	1.80	1.72	1.75	1.80	1.85		
AMPS	4.4	4.5	4.6	4.8	4.7	4.8	5.0	5.2	5.1	5.3	5.4	5.6	5.5	5.6	5.8	6.0	5.8	6.0	6.2	6.4	6.2	6.3	6.5	6.8		
HIPR	139	149	158	165	156	168	177	185	177	191	201	210	202	217	229	239	227	244	258	269	251	270	285	297		
LOPR	63	67	73	78	66	71	77	82	69	73	80	85	72	77	84	90	76	81	88	94	78	84	91	97		
MBh	17.3	17.6	18.9	20.2	16.9	17.2	18.4	19.7	16.5	16.8	18.0	19.2	16.1	16.4	17.5	18.7	15.3	15.6	16.7	17.8	14.1	14.4	15.4	16.5		
S/T	0.81	0.76	0.62	0.46	0.84	0.79	0.64	0.48	0.86	0.81	0.66	0.49	0.89	0.84	0.68	0.51	0.93	0.87	0.71	0.53	0.93	0.88	0.71	0.53		
Delta T	25	24	20	16	25	24	21	17	25	24	21	17	25	24	21	17	25	24	21	16	23	22	19	15		
KW	1.36	1.39	1.42	1.46	1.45	1.47	1.51	1.55	1.52	1.55	1.59	1.63	1.58	1.61	1.65	1.70	1.64	1.67	1.71	1.76	1.68	1.71	1.76	1.81		
AMPS	4.3	4.4	4.5	4.7	4.6	4.7	4.9	5.0	5.0	5.1	5.3	5.5	5.3	5.5	5.6	5.8	5.7	5.8	6.0	6.2	6.0	6.1	6.3	6.6		
HIPR	135	145	153	160	151	163	172	179	172	185	195	204	196	211	222	232	220	237	250	261	243	262	276	288		
LOPR	61	65	71	75	64	68	75	80	67	71	78	83	70	75	82	87	74	78	85	91	76	81	88	94		

85	675	MBh	19.6	20.0	20.9	22.3	19.2	19.5	20.4	21.8	18.7	19.1	20.0	21.3	18.2	18.6	19.5	20.8	17.3	17.7	18.5	19.7	16.1	16.4	17.1	18.3
		S/T	0.93	0.89	0.81	0.65	0.96	0.93	0.84	0.68	0.98	0.95	0.86	0.70	1.00	0.98	0.89	0.72	1.00	1.00	0.92	0.75	1.00	1.00	0.93	0.75
		Delta T	25	24	23	20	25	25	23	20	25	25	23	20	25	25	23	20	24	24	23	20	22	22	22	19
		KW	1.41	1.43	1.47	1.51	1.49	1.52	1.56	1.60	1.57	1.60	1.64	1.69	1.64	1.67	1.71	1.76	1.69	1.73	1.77	1.82	1.74	1.78	1.83	1.88
		AMPS	4.5	4.6	4.7	4.9	4.8	4.9	5.1	5.3	5.2	5.4	5.5	5.7	5.6	5.7	5.9	6.1	5.9	6.1	6.3	6.5	6.3	6.4	6.6	6.9
		HIPR	142	152	161	168	159	171	181	188	181	194	205	214	206	221	234	244	232	249	263	274	256	275	291	303
		LOPR	64	68	74	79	68	72	79	84	70	75	82	87	74	79	86	91	77	82	90	96	80	85	93	99
		MBh	19.0	19.4	20.3	21.7	18.6	19.0	19.9	21.2	18.2	18.5	19.4	20.7	17.7	18.1	18.9	20.2	16.8	17.1	18.0	19.2	15.6	15.9	16.6	17.7
		S/T	0.88	0.85	0.77	0.62	0.92	0.88	0.80	0.65	0.94	0.91	0.82	0.66	0.97	0.94	0.84	0.69	1.00	0.97	0.88	0.71	1.00	0.98	0.88	0.72
		Delta T	26	25	24	21	26	26	24	21	26	26	24	21	26	26	24	21	26	26	24	21	24	24	23	19
KW	1.40	1.42	1.46	1.50	1.48	1.51	1.55	1.59	1.56	1.59	1.63	1.67	1.63	1.66	1.70	1.75	1.68	1.71	1.76	1.81	1.73	1.76	1.81	1.86		
AMPS	4.4	4.5	4.7	4.8	4.8	4.9	5.0	5.2	5.2	5.3	5.5	5.7	5.5	5.7	5.8	6.1	5.9	6.0	6.2	6.4	6.2	6.4	6.6	6.8		
HIPR	140	151	159	166	157	169	179	186	179	193	203	212	204	219	232	242	229	247	260	272	253	273	288	300		
LOPR	63	67	74	78	67	71	78	83	70	74	81	86	73	78	85	90	77	82	89	95	79	84	92	98		
MBh	17.6	17.9	18.8	20.0	17.2	17.5	18.3	19.5	16.8	17.1	17.9	19.1	16.3	16.7	17.4	18.6	15.5	15.8	16.6	17.7	14.4	14.7	15.4	16.4		
S/T	0.85	0.82	0.74	0.60	0.88	0.85	0.77	0.62	0.91	0.87	0.79	0.64	0.93	0.90	0.81	0.66	0.97	0.94	0.85	0.69	0.98	0.94	0.85	0.69		
Delta T	26	26	24	21	27	26	25	21	27	26	25	21	27	26	25	22	26	26	25	21	25	24	23	20		
KW	1.37	1.40	1.43	1.47	1.46	1.48	1.52	1.56	1.53	1.56	1.60	1.64	1.59	1.62	1.67	1.71	1.65	1.68	1.72	1.77	1.69	1.73	1.77	1.82		
AMPS	4.3	4.4	4.6	4.7	4.7	4.8	4.9	5.1	5.0	5.2	5.3	5.5	5.4	5.5	5.7	5.9	5.7	5.9	6.0	6.3	6.0	6.2	6.4	6.6		
HIPR	136	146	155	161	153	164	173	181	174	187	197	206	198	213	225	234	222	239	253	264	246	264	279	291		
LOPR	62	65	71	76	65	69	75	80	68	72	78	84	71	75	82	88	74	79	86	92	77	82	89	95		

* Entering Indoor Dry Bulb Temperature

NOTE: Shaded area is AHRI Rating Conditions

COOLING PERFORMANCE DATA

GSC130181B*

EXPANDED PERFORMANCE DATA

COOLING OPERATION

MODEL: GSC130181 / CA*F1824*6B*

IDB*	Airflow	Outdoor Ambient Temperature																								
		65				75				85				95				105				115				
		59	63	67	71	59	63	67	71	59	63	67	71	59	63	67	71	59	63	67	71	59	63	67	71	
70	525	MBh	16.7	17.3	18.9	-	16.3	16.9	18.5	-	15.9	16.5	18.1	-	15.5	16.1	17.6	-	14.7	15.3	16.7	-	13.7	14.2	15.5	-
		S/T	0.67	0.56	0.39	-	0.69	0.58	0.40	-	0.71	0.59	0.41	-	0.73	0.61	0.42	-	0.76	0.64	0.44	-	0.77	0.64	0.44	-
		Delta T	20	17	13	-	20	17	13	-	20	17	13	-	20	17	13	-	20	17	13	-	18	16	12	-
		KW	1.26	1.29	1.32	-	1.35	1.38	1.42	-	1.43	1.46	1.50	-	1.50	1.53	1.57	-	1.56	1.59	1.64	-	1.61	1.64	1.69	-
		AMPS	4.5	4.6	4.7	-	4.8	5.0	5.1	-	5.3	5.4	5.6	-	5.6	5.7	5.9	-	6.0	6.1	6.3	-	6.3	6.5	6.7	-
		HIPR	129	139	146	-	145	156	164	-	164	177	187	-	187	201	213	-	211	227	239	-	233	250	264	-
		LOPR	60	64	70	-	63	67	74	-	66	70	77	-	69	74	80	-	73	77	84	-	75	80	87	-
70	600	MBh	18.1	18.7	20.5	-	17.7	18.3	20.0	-	17.2	17.9	19.6	-	16.8	17.4	19.1	-	16.0	16.6	18.1	-	14.8	15.3	16.8	-
		S/T	0.69	0.58	0.40	-	0.72	0.60	0.42	-	0.74	0.61	0.43	-	0.76	0.63	0.44	-	0.79	0.66	0.46	-	0.80	0.66	0.46	-
		Delta T	19	17	13	-	19	17	13	-	19	17	13	-	20	17	13	-	19	17	13	-	18	16	12	-
		KW	1.29	1.32	1.35	-	1.38	1.41	1.45	-	1.46	1.49	1.54	-	1.53	1.56	1.61	-	1.59	1.63	1.68	-	1.65	1.68	1.73	-
		AMPS	4.6	4.7	4.9	-	5.0	5.1	5.3	-	5.4	5.5	5.7	-	5.8	5.9	6.1	-	6.1	6.3	6.5	-	6.5	6.6	6.9	-
		HIPR	133	143	151	-	149	160	169	-	169	182	193	-	193	208	219	-	217	234	247	-	240	258	273	-
		LOPR	62	66	72	-	65	70	76	-	68	72	79	-	71	76	83	-	75	80	87	-	77	82	90	-
70	675	MBh	18.6	19.3	21.1	-	18.2	18.8	20.7	-	17.8	18.4	20.2	-	17.3	18.0	19.7	-	16.5	17.1	18.7	-	15.2	15.8	17.3	-
		S/T	0.73	0.61	0.42	-	0.75	0.63	0.44	-	0.77	0.64	0.45	-	0.80	0.67	0.46	-	0.83	0.69	0.48	-	0.83	0.70	0.48	-
		Delta T	18	16	12	-	19	16	12	-	19	16	12	-	19	16	12	-	19	16	12	-	17	15	11	-
		KW	1.30	1.33	1.36	-	1.39	1.42	1.46	-	1.47	1.50	1.55	-	1.54	1.58	1.62	-	1.61	1.64	1.69	-	1.66	1.69	1.75	-
		AMPS	4.7	4.8	4.9	-	5.0	5.1	5.3	-	5.4	5.6	5.8	-	5.8	5.9	6.1	-	6.2	6.3	6.5	-	6.5	6.7	6.9	-
		HIPR	134	144	152	-	150	162	171	-	171	184	194	-	195	210	222	-	219	236	249	-	242	261	275	-
		LOPR	63	67	73	-	66	70	77	-	69	73	80	-	72	77	84	-	76	80	88	-	78	83	91	-
75	525	MBh	17.0	17.5	18.9	20.3	16.6	17.1	18.5	19.8	16.2	16.7	18.0	19.4	15.8	16.3	17.6	18.9	15.0	15.4	16.7	17.9	13.9	14.3	15.5	16.6
		S/T	0.76	0.68	0.51	0.33	0.79	0.70	0.53	0.34	0.81	0.72	0.55	0.35	0.83	0.74	0.56	0.36	0.86	0.77	0.59	0.38	0.87	0.78	0.59	0.38
		Delta T	23	21	17	12	23	21	17	12	23	21	17	12	23	21	17	12	23	21	17	12	21	20	16	11
		KW	1.27	1.30	1.33	1.37	1.36	1.39	1.43	1.47	1.44	1.47	1.51	1.56	1.51	1.54	1.59	1.64	1.57	1.60	1.65	1.70	1.62	1.65	1.70	1.76
		AMPS	4.5	4.6	4.8	5.0	4.9	5.0	5.2	5.4	5.3	5.4	5.6	5.8	5.7	5.8	6.0	6.2	6.0	6.2	6.4	6.6	6.4	6.5	6.7	7.0
		HIPR	130	140	148	154	146	157	166	173	166	179	189	197	189	204	215	224	213	229	242	252	235	253	267	279
		LOPR	61	65	70	75	64	68	74	79	67	71	77	82	70	74	81	87	73	78	85	91	76	81	88	94
75	600	MBh	18.4	18.9	20.5	22.0	18.0	18.5	20.0	21.5	17.5	18.0	19.5	21.0	17.1	17.6	19.1	20.5	16.2	16.7	18.1	19.4	15.0	15.5	16.8	18.0
		S/T	0.79	0.70	0.53	0.34	0.82	0.73	0.55	0.36	0.84	0.75	0.57	0.36	0.86	0.77	0.58	0.38	0.90	0.80	0.61	0.39	0.90	0.81	0.61	0.39
		Delta T	22	20	17	12	22	21	17	12	22	21	17	12	23	21	17	12	22	21	17	12	21	19	16	11
		KW	1.30	1.33	1.36	1.40	1.39	1.42	1.46	1.51	1.47	1.50	1.55	1.60	1.55	1.58	1.63	1.68	1.61	1.64	1.69	1.74	1.66	1.69	1.75	1.80
		AMPS	4.7	4.8	4.9	5.1	5.0	5.1	5.3	5.5	5.4	5.6	5.8	6.0	5.8	5.9	6.1	6.4	6.2	6.3	6.5	6.8	6.5	6.7	6.9	7.2
		HIPR	134	144	152	159	151	162	171	178	171	184	195	203	195	210	222	231	219	236	249	260	242	261	275	287
		LOPR	63	67	73	77	66	70	77	82	69	73	80	85	72	77	84	89	76	80	88	93	78	83	91	97
75	675	MBh	18.9	19.5	21.1	22.6	18.5	19.0	20.6	22.1	18.1	18.6	20.1	21.6	17.6	18.1	19.6	21.1	16.7	17.2	18.6	20.0	15.5	16.0	17.3	18.5
		S/T	0.83	0.74	0.56	0.36	0.86	0.77	0.58	0.37	0.88	0.78	0.59	0.38	0.91	0.81	0.61	0.39	0.94	0.84	0.64	0.41	0.95	0.85	0.64	0.41
		Delta T	21	20	16	11	22	20	16	11	22	20	16	11	22	20	16	11	21	20	16	11	20	18	15	10
		KW	1.31	1.34	1.37	1.42	1.40	1.43	1.47	1.52	1.48	1.51	1.56	1.61	1.56	1.59	1.64	1.69	1.62	1.65	1.70	1.76	1.67	1.71	1.76	1.82
		AMPS	4.7	4.8	5.0	5.1	5.1	5.2	5.4	5.5	5.5	5.6	5.8	6.0	5.9	6.0	6.2	6.4	6.2	6.4	6.6	6.8	6.6	6.8	7.0	7.2
		HIPR	135	146	154	161	152	164	173	180	173	186	196	205	197	212	224	233	222	238	252	263	245	263	278	290
		LOPR	63	67	73	78	67	71	77	83	69	74	81	86	73	77	85	90	76	81	89	94	79	84	92	98

* Entering Indoor Dry Bulb Temperature

NOTE: Shaded area is ACCA (TVA) conditions

COOLING PERFORMANCE DATA

GSC130181B*

EXPANDED PERFORMANCE DATA

COOLING OPERATION

MODEL: GSC130181 / CA*F1824*6B*

IDB*	Airflow	Outdoor Ambient Temperature																													
		65					75					85					95					105					115				
		59	63	67	71	75	59	63	67	71	75	59	63	67	71	75	59	63	67	71	75	59	63	67	71	75	59	63	67	71	75
80	525	MBh	17.3	17.6	18.9	20.2	16.9	17.2	18.4	19.7	16.5	16.8	18.0	19.2	16.1	16.4	17.5	18.7	15.3	15.6	16.7	17.8	14.1	14.4	15.4	16.5					
		S/T	0.83	0.78	0.64	0.48	0.86	0.81	0.66	0.49	0.88	0.83	0.68	0.50	0.91	0.86	0.70	0.52	0.95	0.89	0.72	0.54	0.96	0.90	0.73	0.55					
		Delta T	25	24	21	17	25	24	21	17	26	24	21	17	26	25	21	17	25	24	21	17	24	23	20	16					
		KW	1.28	1.31	1.34	1.38	1.37	1.40	1.44	1.48	1.45	1.48	1.52	1.57	1.52	1.55	1.60	1.65	1.58	1.61	1.66	1.72	1.63	1.67	1.72	1.77					
		AMPS	4.6	4.7	4.8	5.0	4.9	5.1	5.2	5.4	5.3	5.5	5.7	5.9	5.7	5.8	6.0	6.3	6.1	6.2	6.4	6.7	6.4	6.6	6.8	7.0					
	600	HIPR	131	141	149	156	147	159	168	175	168	180	191	199	191	206	217	226	215	231	244	255	237	256	270	281					
		LOPR	61	65	71	76	65	69	75	80	67	72	78	83	71	75	82	87	74	79	86	92	77	81	89	95					
		MBh	18.7	19.1	20.4	21.8	18.3	18.7	20.0	21.3	17.8	18.2	19.5	20.8	17.4	17.8	19.0	20.3	16.5	16.9	18.1	19.3	15.3	15.6	16.7	17.9					
		S/T	0.86	0.81	0.66	0.49	0.89	0.84	0.68	0.51	0.92	0.86	0.70	0.52	0.95	0.89	0.72	0.54	0.98	0.92	0.75	0.56	0.99	0.93	0.76	0.57					
		Delta T	25	24	21	16	25	24	21	17	25	24	21	17	25	24	21	17	25	24	21	17	23	22	19	15					
675	KW	1.31	1.34	1.37	1.42	1.40	1.43	1.47	1.52	1.48	1.52	1.56	1.61	1.56	1.59	1.64	1.69	1.62	1.65	1.70	1.76	1.67	1.71	1.76	1.82						
	AMPS	4.7	4.8	5.0	5.1	5.1	5.2	5.4	5.5	5.5	5.6	5.8	6.0	5.9	6.0	6.2	6.4	6.2	6.4	6.6	6.8	6.6	6.8	7.0	7.2						
	HIPR	135	146	154	161	152	164	173	180	173	186	196	205	197	212	222	233	222	238	252	263	245	263	278	290						
	LOPR	63	67	73	78	67	71	77	83	69	74	81	86	73	77	85	90	76	81	89	94	79	84	92	98						
	MBh	19.3	19.7	21.0	22.5	18.8	19.2	20.5	22.0	18.4	18.8	20.1	21.4	17.9	18.3	19.6	20.9	17.0	17.4	18.6	19.9	15.8	16.1	17.2	18.4						

85	525	MBh	17.6	17.9	18.8	20.0	17.2	17.5	18.3	19.5	16.8	17.1	17.9	19.1	16.3	16.7	17.4	18.6	15.5	15.8	16.6	17.7	14.4	14.7	15.4	16.4
		S/T	0.87	0.84	0.76	0.62	0.90	0.87	0.79	0.64	0.93	0.90	0.81	0.66	0.96	0.92	0.83	0.68	0.99	0.96	0.87	0.70	1.00	0.97	0.87	0.71
		Delta T	27	26	25	22	27	27	25	22	27	27	25	22	27	27	25	22	27	27	25	22	25	25	23	20
		KW	1.29	1.32	1.35	1.39	1.38	1.41	1.45	1.49	1.46	1.49	1.54	1.58	1.53	1.56	1.61	1.66	1.59	1.63	1.68	1.73	1.64	1.68	1.73	1.79
		AMPS	4.6	4.7	4.9	5.0	5.0	5.1	5.3	5.4	5.4	5.5	5.7	5.9	5.8	5.9	6.1	6.3	6.1	6.3	6.5	6.7	6.5	6.6	6.8	7.1
	600	HIPR	133	143	151	157	149	160	169	177	169	182	193	201	193	208	219	229	217	234	247	257	240	258	273	284
		LOPR	62	66	72	77	65	70	76	81	68	72	79	84	71	76	83	88	75	80	87	93	77	82	90	96
		MBh	19.0	19.4	20.3	21.7	18.6	19.0	19.9	21.2	18.2	18.5	19.4	20.7	17.7	18.1	18.9	20.2	16.8	17.1	18.0	19.2	15.6	15.9	16.6	17.7
		S/T	0.91	0.87	0.79	0.64	0.94	0.91	0.82	0.66	0.96	0.93	0.84	0.68	0.99	0.96	0.86	0.70	1.00	0.99	0.90	0.73	1.00	1.00	0.90	0.73
		Delta T	26	26	25	21	27	26	25	22	27	26	25	22	27	27	25	22	26	26	25	21	24	24	23	20
675	KW	1.32	1.35	1.38	1.43	1.41	1.44	1.48	1.53	1.50	1.53	1.57	1.62	1.57	1.60	1.65	1.70	1.63	1.67	1.72	1.77	1.68	1.72	1.77	1.83	
	AMPS	4.7	4.9	5.0	5.2	5.1	5.2	5.4	5.6	5.5	5.7	5.9	6.1	5.9	6.1	6.3	6.5	6.3	6.4	6.7	6.9	6.7	6.8	7.0	7.3	
	HIPR	137	147	156	162	154	165	175	182	175	188	198	207	199	214	226	236	224	241	254	265	247	266	281	293	
	LOPR	64	68	74	79	67	72	78	83	70	75	81	87	74	78	85	91	77	82	90	95	80	85	93	99	
	MBh	19.6	20.0	20.9	22.3	19.2	19.5	20.4	21.8	18.7	19.1	20.0	21.3	18.2	18.6	19.5	20.8	17.3	17.7	18.5	19.7	16.1	16.4	17.1	18.3	

* Entering Indoor Dry Bulb Temperature

NOTE: Shaded area is AHRI Rating Conditions

COOLING PERFORMANCE DATA

GSC130181C*

EXPANDED PERFORMANCE DATA

COOLING OPERATION

MODEL: GSC130181C* / CA*F1824*6**+EEP

IDB*	Airflow	Outdoor Ambient Temperature																								
		65				75				85				95				105				115				
		59	63	67	71	59	63	67	71	59	63	67	71	59	63	67	71	59	63	67	71	59	63	67	71	
70	675	MBh	18.6	19.3	21.1	-	18.2	18.8	20.7	-	17.8	18.4	20.2	-	17.3	18.0	19.7	-	16.5	17.1	18.7	-	15.2	15.8	17.3	-
		S/T	0.73	0.61	0.42	-	0.76	0.63	0.44	-	0.78	0.65	0.45	-	0.80	0.67	0.47	-	0.83	0.70	0.48	-	0.84	0.70	0.49	-
		Delta T	19	16	12	-	19	16	12	-	19	16	12	-	19	16	12	-	19	16	12	-	17	15	11	-
		KW	1.26	1.28	1.32	-	1.35	1.37	1.41	-	1.42	1.45	1.50	-	1.49	1.52	1.57	-	1.55	1.58	1.63	-	1.60	1.64	1.69	-
		AMPS	4.6	4.7	4.9	-	5.0	5.1	5.2	-	5.4	5.5	5.7	-	5.7	5.9	6.0	-	6.1	6.2	6.4	-	6.4	6.6	6.8	-
		HIPR	133	143	151	-	149	161	170	-	170	183	193	-	193	208	220	-	218	234	247	-	240	259	273	-
	600	LOPR	62	66	72	-	65	69	76	-	68	72	79	-	71	76	83	-	75	79	87	-	77	82	90	-
		MBh	18.1	18.7	20.5	-	17.7	18.3	20.0	-	17.2	17.9	19.6	-	16.8	17.4	19.1	-	16.0	16.6	18.1	-	14.8	15.3	16.8	-
		S/T	0.70	0.58	0.40	-	0.72	0.61	0.42	-	0.74	0.62	0.43	-	0.77	0.64	0.44	-	0.80	0.66	0.46	-	0.80	0.67	0.46	-
		Delta T	19	17	13	-	20	17	13	-	20	17	13	-	20	17	13	-	19	17	13	-	18	16	12	-
		KW	1.25	1.27	1.31	-	1.34	1.36	1.40	-	1.41	1.44	1.49	-	1.48	1.51	1.56	-	1.54	1.57	1.62	-	1.59	1.62	1.67	-
		AMPS	4.6	4.7	4.8	-	4.9	5.0	5.2	-	5.3	5.4	5.6	-	5.7	5.8	6.0	-	6.0	6.2	6.4	-	6.4	6.5	6.7	-
525	HIPR	132	142	150	-	148	159	168	-	168	181	191	-	191	206	218	-	215	232	245	-	238	256	270	-	
	LOPR	61	65	71	-	65	69	75	-	67	71	78	-	70	75	82	-	74	79	86	-	76	81	89	-	
	MBh	16.7	17.3	18.9	-	16.3	16.9	18.5	-	15.9	16.5	18.1	-	15.5	16.1	17.6	-	14.7	15.3	16.7	-	13.7	14.2	15.5	-	
	S/T	0.67	0.56	0.39	-	0.70	0.58	0.40	-	0.72	0.60	0.41	-	0.74	0.62	0.43	-	0.77	0.64	0.44	-	0.77	0.65	0.45	-	
	Delta T	20	17	13	-	20	17	13	-	20	17	13	-	20	17	13	-	20	17	13	-	19	16	12	-	
	KW	1.22	1.24	1.28	-	1.31	1.33	1.37	-	1.38	1.41	1.45	-	1.45	1.48	1.52	-	1.50	1.53	1.58	-	1.55	1.58	1.63	-	
75	675	MBh	18.9	19.5	21.1	22.6	18.5	19.0	20.6	22.1	18.1	18.6	20.1	21.6	17.6	18.1	19.6	21.1	16.7	17.2	18.6	20.0	15.5	16.0	17.3	18.5
		S/T	0.83	0.75	0.56	0.36	0.86	0.77	0.58	0.38	0.89	0.79	0.60	0.39	0.91	0.82	0.62	0.40	0.95	0.85	0.64	0.41	0.96	0.86	0.65	0.42
		Delta T	21	20	16	11	22	20	16	11	22	20	16	11	22	20	17	11	22	20	16	11	20	19	15	11
		KW	1.27	1.29	1.33	1.37	1.36	1.38	1.42	1.47	1.44	1.46	1.51	1.56	1.50	1.54	1.58	1.63	1.56	1.60	1.65	1.70	1.62	1.65	1.70	1.75
		AMPS	4.7	4.8	4.9	5.1	5.0	5.1	5.3	5.5	5.4	5.5	5.7	5.9	5.8	5.9	6.1	6.3	6.1	6.3	6.5	6.7	6.5	6.6	6.8	7.1
		HIPR	134	145	153	159	151	162	171	179	172	185	195	203	195	210	222	232	220	236	250	260	243	261	276	288
	600	LOPR	62	66	72	77	66	70	76	81	68	73	79	85	72	76	83	89	75	80	87	93	78	83	91	96
		MBh	18.4	18.9	20.5	22.0	18.0	18.5	20.0	21.5	17.5	18.0	19.5	21.0	17.1	17.6	19.1	20.5	16.2	16.7	18.1	19.4	15.0	15.5	16.8	18.0
		S/T	0.79	0.71	0.54	0.35	0.82	0.74	0.56	0.36	0.84	0.76	0.57	0.37	0.87	0.78	0.59	0.38	0.90	0.81	0.61	0.39	0.91	0.82	0.62	0.40
		Delta T	22	21	17	12	23	21	17	12	23	21	17	12	23	21	17	12	23	21	17	12	21	19	16	11
		KW	1.26	1.28	1.32	1.36	1.35	1.37	1.41	1.46	1.42	1.45	1.50	1.54	1.49	1.52	1.57	1.62	1.55	1.58	1.63	1.68	1.60	1.64	1.69	1.74
		AMPS	4.6	4.7	4.9	5.0	5.0	5.1	5.2	5.4	5.4	5.5	5.7	5.9	5.7	5.9	6.0	6.3	6.1	6.2	6.4	6.7	6.4	6.6	6.8	7.0
525	HIPR	133	143	151	158	149	161	170	177	170	183	193	201	193	208	220	229	218	234	247	258	240	259	273	285	
	LOPR	62	66	72	76	65	69	76	81	68	72	79	84	71	76	83	88	75	79	87	92	77	82	90	95	
	MBh	17.0	17.5	18.9	20.3	16.6	17.1	18.5	19.8	16.2	16.7	18.0	19.4	15.8	16.3	17.6	18.9	15.0	15.4	16.7	17.9	13.9	14.3	15.5	16.6	
	S/T	0.77	0.69	0.52	0.33	0.79	0.71	0.54	0.35	0.81	0.73	0.55	0.35	0.84	0.75	0.57	0.37	0.87	0.78	0.59	0.38	0.88	0.79	0.60	0.38	
	Delta T	23	21	17	12	23	21	17	12	23	21	17	12	23	21	18	12	23	21	17	12	21	20	16	11	
	KW	1.23	1.25	1.29	1.33	1.32	1.34	1.38	1.42	1.39	1.42	1.46	1.51	1.46	1.49	1.53	1.58	1.52	1.55	1.59	1.64	1.56	1.60	1.65	1.70	
AMPS	4.5	4.6	4.7	4.9	4.8	4.9	5.1	5.3	5.2	5.4	5.5	5.7	5.6	5.7	5.9	6.1	5.9	6.1	6.2	6.5	6.3	6.4	6.6	6.8		
HIPR	129	139	147	153	145	156	165	172	165	177	187	195	188	202	213	222	211	227	240	250	233	251	265	276		
LOPR	60	64	70	74	63	67	73	78	66	70	76	81	69	73	80	85	72	77	84	89	75	80	87	93		

* Entering Indoor Dry Bulb Temperature

NOTE: Shaded area is ACOA (TVA) conditions

COOLING PERFORMANCE DATA

GSC130181C*

EXPANDED PERFORMANCE DATA

EXPANDED PERFORMANCE DATA

MODEL: GSC130181C* / CA*F1824*6**+EEP

IDB*	Airflow	Outdoor Ambient Temperature																																			
		65						75						85						95						105						115					
		59	63	67	71	75	79	59	63	67	71	75	79	59	63	67	71	75	79	59	63	67	71	75	79	59	63	67	71	75	79	59	63	67	71	75	79
80	675	MBh	19.3	19.7	21.0	22.5	18.8	19.2	20.5	22.0	18.4	18.8	20.1	21.4	17.9	18.3	19.6	20.9	17.0	17.4	18.6	19.9	15.8	16.1	17.2	18.4											
		S/T	0.91	0.86	0.70	0.52	0.95	0.89	0.72	0.54	1.00	0.91	0.74	0.55	1.00	0.94	0.77	0.57	1.00	1.00	0.79	0.59	1.00	1.00	0.80	0.60											
		Delta T	24	23	20	16	24	23	20	16	25	23	20	16	24	23	20	16	23	24	20	16	21	22	19	15											
		KW	1.28	1.30	1.34	1.38	1.37	1.39	1.44	1.48	1.45	1.48	1.52	1.57	1.52	1.55	1.60	1.65	1.58	1.61	1.66	1.71	1.63	1.66	1.71	1.77											
		AMPS	4.7	4.8	4.9	5.1	5.1	5.2	5.3	5.5	5.5	5.6	5.8	6.0	5.8	6.0	6.2	6.4	6.2	6.3	6.5	6.8	6.5	6.7	6.9	7.2											
		HIPR	136	146	154	161	152	164	173	181	173	186	197	205	197	212	224	234	222	239	252	263	245	264	279	291											
LOPR	63	67	73	78	67	71	77	82	69	74	80	86	73	77	84	90	76	81	88	94	79	84	91	97													
80	600	MBh	18.7	19.1	20.4	21.8	18.3	18.7	20.0	21.3	17.8	18.2	19.5	20.8	17.4	17.8	19.0	20.3	16.5	16.9	18.1	19.3	15.3	15.6	16.7	17.9											
		S/T	0.87	0.82	0.67	0.50	0.90	0.85	0.69	0.52	0.93	0.87	0.71	0.53	0.96	0.90	0.73	0.55	0.99	0.93	0.76	0.57	1.00	0.94	0.76	0.57											
		Delta T	25	24	21	17	25	24	21	17	25	24	21	17	26	24	21	17	25	24	21	17	23	23	20	16											
		KW	1.27	1.29	1.33	1.37	1.36	1.38	1.42	1.47	1.44	1.46	1.51	1.56	1.50	1.54	1.58	1.63	1.56	1.60	1.65	1.70	1.62	1.65	1.70	1.76											
		AMPS	4.7	4.8	4.9	5.1	5.0	5.1	5.3	5.5	5.4	5.5	5.7	5.9	5.8	5.9	6.1	6.3	6.1	6.3	6.5	6.7	6.5	6.6	6.9	7.1											
		HIPR	134	145	153	159	151	162	171	179	172	185	195	203	195	210	222	232	220	237	250	260	243	261	276	288											
LOPR	62	66	72	77	66	70	76	81	68	73	79	85	72	76	84	89	75	80	88	93	78	83	91	96													
80	525	MBh	17.3	17.6	18.9	20.2	16.9	17.2	18.4	19.7	16.5	16.8	18.0	19.2	16.1	16.4	17.5	18.7	15.3	15.6	16.7	17.8	14.1	14.4	15.4	16.5											
		S/T	0.84	0.79	0.64	0.48	0.87	0.82	0.67	0.50	0.89	0.84	0.68	0.51	0.92	0.86	0.70	0.53	0.96	0.90	0.73	0.55	0.97	0.91	0.74	0.55											
		Delta T	25	24	21	17	26	25	21	17	26	25	21	17	26	25	22	17	26	25	21	17	24	23	20	16											
		KW	1.24	1.26	1.30	1.34	1.33	1.35	1.39	1.43	1.40	1.43	1.47	1.52	1.47	1.50	1.55	1.59	1.53	1.56	1.61	1.66	1.58	1.61	1.66	1.71											
		AMPS	4.5	4.6	4.8	4.9	4.9	5.0	5.1	5.3	5.3	5.4	5.6	5.8	5.6	5.8	5.9	6.2	6.0	6.1	6.3	6.5	6.3	6.5	6.7	6.9											
		HIPR	130	140	148	155	146	157	166	173	166	179	189	197	189	204	215	225	213	229	242	253	236	253	268	279											
LOPR	60	64	70	75	64	68	74	79	66	71	77	82	70	74	81	86	73	78	85	90	76	80	88	94													

85	675	MBh	19.6	20.0	20.9	22.3	19.2	19.5	20.4	21.8	18.7	19.1	20.0	21.3	18.2	18.6	19.5	20.8	17.3	17.7	18.5	19.7	16.1	16.4	17.1	18.3
		S/T	0.96	0.92	0.83	0.68	0.99	0.96	0.86	0.70	1.00	0.98	0.89	0.72	1.00	1.00	0.92	0.74	1.00	1.00	0.95	0.77	1.00	1.00	0.96	0.78
		Delta T	26	25	24	21	26	25	24	21	25	26	24	21	25	25	24	21	24	24	24	21	22	22	22	19
		KW	1.29	1.31	1.35	1.39	1.38	1.40	1.45	1.49	1.46	1.49	1.53	1.58	1.53	1.56	1.61	1.66	1.59	1.62	1.67	1.73	1.64	1.68	1.73	1.78
		AMPS	4.7	4.8	5.0	5.2	5.1	5.2	5.4	5.6	5.5	5.6	5.8	6.0	5.9	6.0	6.2	6.4	6.2	6.4	6.6	6.8	6.6	6.8	7.0	7.2
		HIPR	137	148	156	163	154	166	175	182	175	188	199	207	199	214	226	236	224	241	255	266	248	267	281	294
LOPR	64	68	74	79	67	71	78	83	70	74	81	86	73	78	85	91	77	82	89	95	79	85	92	98		
85	600	MBh	19.0	19.4	20.3	21.7	18.6	19.0	19.9	21.2	18.2	18.5	19.4	20.7	17.7	18.1	18.9	20.2	16.8	17.1	18.0	19.2	15.6	15.9	16.6	17.7
		S/T	0.91	0.88	0.80	0.65	0.95	0.91	0.82	0.67	0.97	0.94	0.85	0.69	1.00	0.97	0.87	0.71	1.00	1.00	0.91	0.74	1.00	1.00	0.91	0.74
		Delta T	27	26	25	21	27	27	25	22	27	27	25	22	27	27	25	22	26	26	25	22	24	24	23	20
		KW	1.28	1.30	1.34	1.38	1.37	1.39	1.44	1.48	1.45	1.48	1.52	1.57	1.52	1.55	1.60	1.65	1.58	1.61	1.66	1.71	1.63	1.66	1.71	1.77
		AMPS	4.7	4.8	4.9	5.1	5.1	5.2	5.3	5.5	5.5	5.6	5.8	6.0	5.8	6.0	6.2	6.4	6.2	6.3	6.5	6.8	6.5	6.7	6.9	7.2
		HIPR	136	146	154	161	152	164	173	181	173	186	197	205	197	212	224	234	222	239	252	263	245	264	279	291
LOPR	63	67	73	78	67	71	77	82	69	74	80	86	73	77	84	90	76	81	88	94	79	84	91	97		
85	525	MBh	17.6	17.9	18.8	20.0	17.2	17.5	18.3	19.5	16.8	17.1	17.9	19.1	16.3	16.7	17.4	18.6	15.5	15.8	16.6	17.7	14.4	14.7	15.4	16.4
		S/T	0.88	0.85	0.77	0.62	0.91	0.88	0.80	0.65	0.94	0.90	0.82	0.66	0.97	0.93	0.84	0.68	1.00	0.97	0.87	0.71	1.00	0.98	0.88	0.71
		Delta T	27	27	25	22	27	27	26	22	27	27	26	22	28	27	26	22	27	27	25	22	25	25	24	21
		KW	1.25	1.27	1.31	1.35	1.34	1.36	1.40	1.44	1.41	1.44	1.48	1.53	1.48	1.51	1.56	1.61	1.54	1.57	1.62	1.67	1.59	1.62	1.67	1.73
		AMPS	4.6	4.7	4.8	5.0	4.9	5.0	5.2	5.4	5.3	5.4	5.6	5.8	5.7	5.8	6.0	6.2	6.0	6.2	6.4	6.6	6.4	6.5	6.7	7.0
		HIPR	132	142	150	156	148	159	168	175	168	181	191	199	191	206	217	227	215	232	245	255	238	256	270	282
LOPR	61	65	71	76	65	69	75	80	67	71	78	83	70	75	82	87	74	79	86	91	76	81	89	94		

* Entering Indoor Dry Bulb Temperature

NOTE: Shaded area is AHRI Rating Conditions



COOLING PERFORMANCE DATA

GSC130241A*

EXPANDED PERFORMANCE DATA

COOLING OPERATION

MODEL: GSC13024-1A* / CA*F1824*6**+EEP

IDB*	Airflow	Outdoor Ambient Temperature																								
		65				75				85				95				105				115				
		59	63	67	71	59	63	67	71	59	63	67	71	59	63	67	71	59	63	67	71	59	63	67	71	
70	955	MBh	23.0	23.8	26.1	-	22.4	23.3	25.5	-	21.9	22.7	24.9	-	21.4	22.1	24.3	-	20.3	21.0	23.0	-	18.8	19.5	21.4	-
		S/T	0.74	0.62	0.43	-	0.77	0.64	0.45	-	0.79	0.66	0.46	-	0.82	0.68	0.47	-	0.85	0.71	0.49	-	0.85	0.71	0.49	-
		Delta T	16	14	11	-	17	14	11	-	17	14	11	-	17	15	11	-	17	14	11	-	15	13	10	-
		KW	1.63	1.66	1.71	-	1.74	1.78	1.83	-	1.84	1.88	1.94	-	1.93	1.97	2.03	-	2.01	2.05	2.11	-	2.07	2.12	2.18	-
		AMPS	5.7	5.9	6.1	-	6.2	6.3	6.6	-	6.7	6.9	7.1	-	7.2	7.4	7.6	-	7.7	7.8	8.1	-	8.1	8.3	8.6	-
		HIPR	139	150	159	-	157	168	178	-	178	192	202	-	203	218	230	-	228	245	259	-	252	271	286	-
		LO PR	62	66	72	-	65	69	76	-	68	72	79	-	71	76	83	-	75	79	87	-	77	82	90	-
		MBh	22.3	23.1	25.3	-	21.8	22.6	24.7	-	21.3	22.0	24.1	-	20.7	21.5	23.6	-	19.7	20.4	22.4	-	18.3	18.9	20.7	-
		S/T	0.71	0.59	0.41	-	0.74	0.61	0.43	-	0.75	0.63	0.44	-	0.78	0.65	0.45	-	0.81	0.67	0.47	-	0.81	0.68	0.47	-
		Delta T	17	15	11	-	17	15	11	-	17	15	11	-	17	15	11	-	17	15	11	-	16	14	11	-
70	849	MBh	1.62	1.65	1.69	-	1.73	1.76	1.82	-	1.83	1.87	1.92	-	1.92	1.96	2.02	-	1.99	2.03	2.10	-	2.06	2.10	2.17	-
		AMPS	5.7	5.8	6.0	-	6.1	6.3	6.5	-	6.7	6.8	7.1	-	7.1	7.3	7.5	-	7.6	7.8	8.0	-	8.0	8.2	8.5	-
		HIPR	138	149	157	-	155	167	176	-	176	190	200	-	201	216	228	-	226	243	257	-	250	269	284	-
		LO PR	61	65	71	-	65	69	75	-	67	71	78	-	71	75	82	-	74	79	86	-	76	81	89	-
		MBh	20.6	21.3	23.4	-	20.1	20.8	22.8	-	19.6	20.3	22.3	-	19.1	19.8	21.7	-	18.2	18.9	20.7	-	16.8	17.5	19.1	-
		S/T	0.68	0.57	0.40	-	0.71	0.59	0.41	-	0.73	0.61	0.42	-	0.75	0.63	0.43	-	0.78	0.65	0.45	-	0.79	0.66	0.45	-
		Delta T	17	15	11	-	18	15	12	-	18	15	12	-	18	15	12	-	18	15	12	-	16	14	11	-
		KW	1.58	1.61	1.66	-	1.69	1.72	1.77	-	1.79	1.82	1.88	-	1.87	1.91	1.97	-	1.95	1.99	2.05	-	2.01	2.05	2.12	-
		AMPS	5.5	5.7	5.8	-	6.0	6.1	6.3	-	6.5	6.6	6.9	-	6.9	7.1	7.3	-	7.4	7.6	7.8	-	7.8	8.0	8.3	-
		HIPR	134	144	152	-	150	162	171	-	171	184	194	-	195	210	221	-	219	236	249	-	242	260	275	-
LO PR	59	63	69	-	63	67	73	-	65	69	76	-	68	73	79	-	72	76	83	-	74	79	86	-		
75	955	MBh	23.4	24.0	26.0	27.9	22.8	23.5	25.4	27.3	22.3	22.9	24.8	26.6	21.7	22.4	24.2	26.0	20.6	21.3	23.0	24.7	19.1	19.7	21.3	22.9
		S/T	0.85	0.76	0.57	0.37	0.88	0.78	0.59	0.38	0.90	0.80	0.61	0.39	0.93	0.83	0.63	0.40	0.96	0.86	0.65	0.42	0.97	0.87	0.66	0.42
		Delta T	19	18	14	10	19	18	15	10	19	18	15	10	19	18	15	10	19	18	14	10	18	16	13	9
		KW	1.64	1.67	1.72	1.77	1.76	1.79	1.84	1.90	1.86	1.90	1.95	2.01	1.95	1.99	2.05	2.11	2.02	2.07	2.13	2.20	2.09	2.14	2.20	2.27
		AMPS	5.8	5.9	6.1	6.3	6.3	6.4	6.6	6.9	6.8	7.0	7.2	7.5	7.3	7.4	7.7	8.0	7.7	7.9	8.2	8.5	8.2	8.4	8.7	9.0
		HIPR	141	152	160	167	158	170	180	187	180	194	204	213	205	220	233	243	230	248	262	273	255	274	289	302
		LO PR	62	66	72	77	66	70	77	82	69	73	80	85	72	77	84	89	75	80	88	93	78	83	91	96
		MBh	22.7	23.3	25.3	27.1	22.1	22.8	24.7	26.5	21.6	22.3	24.1	25.9	21.1	21.7	23.5	25.2	20.0	20.6	22.3	24.0	18.6	19.1	20.7	22.2
		S/T	0.81	0.72	0.55	0.35	0.84	0.75	0.57	0.36	0.86	0.77	0.58	0.37	0.88	0.79	0.60	0.39	0.92	0.82	0.62	0.40	0.93	0.83	0.63	0.40
		Delta T	20	18	15	10	20	18	15	10	20	18	15	10	20	19	15	11	20	18	15	10	19	17	14	10
75	849	KW	1.63	1.66	1.71	1.76	1.74	1.78	1.83	1.89	1.84	1.88	1.94	2.00	1.93	1.97	2.03	2.10	2.01	2.05	2.11	2.18	2.07	2.12	2.18	2.25
		AMPS	5.7	5.9	6.1	6.3	6.2	6.3	6.6	6.8	6.7	6.9	7.1	7.4	7.2	7.4	7.6	7.9	7.7	7.8	8.1	8.4	8.1	8.3	8.6	8.9
		HIPR	140	150	159	165	157	168	178	186	178	192	202	211	203	218	230	240	228	246	259	270	252	271	286	299
		LO PR	62	66	72	76	65	69	76	81	68	72	79	84	71	76	83	88	75	79	87	92	77	82	90	96
		MBh	20.9	21.5	23.3	25.0	20.4	21.0	22.8	24.5	20.0	20.5	22.2	23.9	19.5	20.0	21.7	23.3	18.5	19.0	20.6	22.1	17.1	17.6	19.1	20.5
		S/T	0.78	0.70	0.53	0.34	0.81	0.72	0.55	0.35	0.83	0.74	0.56	0.36	0.85	0.76	0.58	0.37	0.89	0.79	0.60	0.39	0.89	0.80	0.60	0.39
		Delta T	20	19	15	10	20	19	15	11	20	19	15	11	21	19	16	11	20	19	15	11	19	17	14	10
		KW	1.59	1.62	1.67	1.72	1.70	1.74	1.79	1.84	1.80	1.84	1.89	1.95	1.89	1.93	1.99	2.05	1.96	2.00	2.06	2.13	2.03	2.07	2.13	2.20
		AMPS	5.6	5.7	5.9	6.1	6.0	6.2	6.4	6.6	6.5	6.7	6.9	7.2	7.0	7.2	7.4	7.7	7.4	7.6	7.9	8.2	7.9	8.1	8.4	8.7
		HIPR	135	146	154	160	152	163	173	180	173	186	196	205	197	212	224	233	221	238	251	262	245	263	278	290
LO PR	60	64	70	74	63	67	74	78	66	70	76	81	69	74	80	85	72	77	84	90	75	80	87	93		

NOTE: Shaded area is AOCA (TVA) conditions

* Entering Indoor Dry Bulb Temperature

COOLING PERFORMANCE DATA

GSC130241A*

EXPANDED PERFORMANCE DATA

COOLING OPERATION

MODEL: GSC13024-1A* / CA*F1824*6**+EEP

IDB*	Airflow	Outdoor Ambient Temperature																								
		65				75				85				95				105				115				
		59	63	67	71	59	63	67	71	59	63	67	71	59	63	67	71	59	63	67	71	59	63	67	71	
80	955	MBh	23.8	24.3	26.0	27.7	23.2	23.7	25.3	27.1	22.7	23.2	24.7	26.5	22.1	22.6	24.1	25.8	21.0	21.5	22.9	24.5	19.5	19.9	21.2	22.7
		S/T	0.93	0.87	0.71	0.53	0.96	0.90	0.73	0.55	1.00	0.92	0.75	0.56	1.00	0.95	0.78	0.58	1.00	1.00	0.81	0.60	1.00	1.00	0.81	0.61
		Delta T	21	20	18	14	21	21	18	14	22	21	18	14	21	21	18	14	20	21	18	14	19	19	17	13
		KW	1.65	1.68	1.73	1.78	1.77	1.80	1.86	1.91	1.87	1.91	1.97	2.03	1.96	2.00	2.07	2.13	2.04	2.08	2.15	2.22	2.11	2.15	2.22	2.29
		AMPS	5.8	6.0	6.2	6.4	6.3	6.5	6.7	6.9	6.9	7.0	7.3	7.5	7.3	7.5	7.8	8.1	7.8	8.0	8.3	8.6	8.3	8.5	8.8	9.1
	849	HI PR	142	153	162	169	160	172	182	189	182	195	206	215	207	223	235	245	233	250	264	276	257	277	292	305
		LO PR	63	67	73	78	67	71	77	82	69	74	80	86	73	77	84	90	76	81	88	94	79	84	92	97
		MBh	23.1	23.6	25.2	26.9	22.5	23.0	24.6	26.3	22.0	22.5	24.0	25.7	21.5	21.9	23.4	25.1	20.4	20.8	22.3	23.8	18.9	19.3	20.6	22.0
		S/T	0.88	0.83	0.68	0.50	0.92	0.86	0.70	0.52	0.94	0.88	0.72	0.54	0.97	0.91	0.74	0.55	1.00	0.94	0.77	0.57	1.00	0.95	0.78	0.58
		Delta T	22	21	18	15	22	21	19	15	22	21	19	15	23	22	19	15	22	21	19	15	20	20	17	14
743	KW	1.64	1.67	1.72	1.77	1.76	1.79	1.84	1.90	1.86	1.90	1.95	2.01	1.95	1.99	2.05	2.11	2.02	2.07	2.13	2.20	2.09	2.14	2.20	2.27	
	AMPS	5.8	5.9	6.1	6.3	6.3	6.4	6.6	6.9	6.8	7.0	7.2	7.5	7.3	7.4	7.7	8.0	7.7	7.9	8.2	8.5	8.2	8.4	8.7	9.0	
	HI PR	141	152	160	167	158	170	180	187	180	194	204	213	205	220	233	243	230	248	262	273	255	274	289	302	
	LO PR	62	66	72	77	66	70	77	82	69	73	80	85	72	77	84	89	75	80	88	93	78	83	91	96	
	MBh	21.3	21.8	23.3	24.9	20.8	21.3	22.7	24.3	20.3	20.8	22.2	23.7	19.8	20.2	21.6	23.1	18.8	19.2	20.6	22.0	17.4	17.8	19.0	20.4	

85	955	MBh	24.2	24.7	25.8	27.5	23.6	24.1	25.2	26.9	23.1	23.5	24.6	26.3	22.5	22.9	24.0	25.6	21.4	21.8	22.8	24.3	19.8	20.2	21.1	22.6
		S/T	0.97	0.94	0.85	0.69	1.00	0.97	0.88	0.71	1.00	1.00	0.90	0.73	1.00	1.00	0.93	0.75	1.00	1.00	0.96	0.78	1.00	1.00	0.97	0.79
		Delta T	23	22	21	18	23	23	21	18	22	23	21	18	22	22	21	19	21	21	21	18	19	19	20	17
		KW	1.66	1.70	1.75	1.80	1.78	1.82	1.87	1.93	1.89	1.92	1.98	2.04	1.98	2.02	2.08	2.15	2.06	2.10	2.17	2.23	2.12	2.17	2.24	2.31
		AMPS	5.9	6.0	6.2	6.5	6.4	6.5	6.7	7.0	6.9	7.1	7.3	7.6	7.4	7.6	7.8	8.1	7.9	8.1	8.3	8.7	8.3	8.6	8.8	9.2
	849	HI PR	144	155	163	170	161	174	183	191	183	197	208	217	209	225	237	248	235	253	267	279	260	280	295	308
		LO PR	64	68	74	79	67	72	78	83	70	74	81	86	73	78	85	91	77	82	89	95	80	85	92	98
		MBh	23.5	23.9	25.1	26.7	22.9	23.4	24.5	26.1	22.4	22.8	23.9	25.5	21.8	22.3	23.3	24.9	20.8	21.2	22.2	23.6	19.2	19.6	20.5	21.9
		S/T	0.93	0.89	0.81	0.66	0.96	0.93	0.84	0.68	0.99	0.95	0.86	0.70	1.00	0.98	0.89	0.72	1.00	1.00	0.92	0.75	1.00	1.00	0.93	0.75
		Delta T	24	23	22	19	24	23	22	19	24	23	22	19	24	24	22	19	22	23	22	19	21	21	21	18
743	KW	1.65	1.68	1.73	1.78	1.77	1.80	1.86	1.91	1.87	1.91	1.97	2.03	1.96	2.00	2.07	2.13	2.04	2.08	2.15	2.22	2.11	2.15	2.22	2.29	
	AMPS	5.8	6.0	6.2	6.4	6.3	6.5	6.7	6.9	6.9	7.0	7.3	7.5	7.3	7.5	7.8	8.1	7.8	8.0	8.3	8.6	8.3	8.5	8.8	9.1	
	HI PR	142	153	162	169	160	172	182	189	182	195	206	215	207	223	235	245	233	250	264	276	257	277	292	305	
	LO PR	63	67	73	78	67	71	77	82	69	74	80	86	73	77	84	90	76	81	88	94	79	84	92	97	
	MBh	21.7	22.1	23.1	24.7	21.2	21.6	22.6	24.1	20.7	21.1	22.1	23.5	20.2	20.6	21.5	23.0	19.2	19.5	20.4	21.8	17.7	18.1	18.9	20.2	

* Entering Indoor Dry Bulb Temperature

NOTE: Shaded area is AHRI Rating Conditions

COOLING PERFORMANCE DATA

GSC130241D*

EXPANDED PERFORMANCE DATA

COOLING OPERATION

MODEL: GSC130241D* / CAUF1824*6B

IDB*	Airflow	Outdoor Ambient Temperature												Entering Indoor Wet Bulb Temperature												
		65				75				85				95				105				115				
		59	63	67	71	59	63	67	71	59	63	67	71	59	63	67	71	59	63	67	71	59	63	67	71	
70	MBh	21.4	22.1	24.3	-	20.9	21.6	23.7	-	20.4	21.1	23.1	-	19.9	20.6	22.6	-	18.9	19.6	21.4	-	17.5	18.1	19.9	-	
	ST	0.68	0.57	0.39	-	0.71	0.59	0.41	-	0.72	0.60	0.42	-	0.75	0.62	0.43	-	0.78	0.65	0.45	-	0.78	0.65	0.45	-	
	Delta T	19	17	13	-	19	17	13	-	19	17	13	-	19	17	13	-	19	17	13	-	18	16	12	-	
	KW	1.49	1.52	1.57	-	1.60	1.64	1.69	-	1.70	1.74	1.79	-	1.79	1.83	1.89	-	1.86	1.90	1.97	-	1.93	1.97	2.03	-	
	AMPS	5.4	5.5	5.6	-	5.7	5.8	6.0	-	6.1	6.2	6.4	-	6.5	6.6	6.8	-	6.8	7.0	7.2	-	7.2	7.3	7.5	-	
	HI PR	138	148	156	-	154	166	176	-	176	189	200	-	200	215	227	-	225	242	256	-	249	268	283	-	
	LO PR	60	64	70	-	64	68	74	-	66	71	77	-	70	74	81	-	73	78	85	-	76	80	88	-	
	MBh	21.7	22.5	24.6	-	21.2	22.0	24.1	-	20.7	21.4	23.5	-	20.2	20.9	22.9	-	19.2	19.9	21.8	-	17.8	18.4	20.2	-	
	ST	0.71	0.59	0.41	-	0.73	0.61	0.42	-	0.75	0.63	0.43	-	0.77	0.65	0.45	-	0.80	0.67	0.47	-	0.81	0.68	0.47	-	
	Delta T	19	16	12	-	19	16	12	-	19	16	12	-	19	17	13	-	19	16	12	-	18	15	12	-	
KW	1.51	1.54	1.59	-	1.63	1.66	1.71	-	1.73	1.76	1.82	-	1.81	1.85	1.91	-	1.89	1.93	1.99	-	1.95	2.00	2.06	-		
AMPS	5.4	5.5	5.7	-	5.8	5.9	6.1	-	6.2	6.3	6.5	-	6.6	6.7	6.9	-	6.9	7.1	7.3	-	7.3	7.4	7.7	-		
HI PR	140	151	159	-	157	169	179	-	179	192	203	-	204	219	231	-	229	246	260	-	253	272	287	-		
LO PR	61	65	71	-	65	69	75	-	67	72	78	-	71	75	82	-	74	79	86	-	77	82	89	-		
75	MBh	22.3	23.2	25.4	-	21.8	22.6	24.8	-	21.3	22.1	24.2	-	20.8	21.5	23.6	-	19.7	20.5	22.4	-	18.3	19.0	20.8	-	
	ST	0.74	0.62	0.43	-	0.77	0.64	0.44	-	0.79	0.66	0.46	-	0.81	0.68	0.47	-	0.84	0.70	0.49	-	0.85	0.71	0.49	-	
	Delta T	18	15	12	-	18	16	12	-	18	16	12	-	18	16	12	-	18	16	12	-	17	15	11	-	
	KW	1.52	1.56	1.60	-	1.64	1.67	1.73	-	1.74	1.78	1.83	-	1.83	1.87	1.93	-	1.91	1.95	2.01	-	1.97	2.01	2.08	-	
	AMPS	5.5	5.6	5.7	-	5.8	5.9	6.1	-	6.2	6.4	6.6	-	6.6	6.7	6.9	-	7.0	7.1	7.3	-	7.3	7.5	7.7	-	
	HI PR	141	152	161	-	159	171	180	-	180	194	205	-	206	221	234	-	231	249	263	-	256	275	290	-	
	LO PR	62	66	72	-	66	70	76	-	68	73	79	-	72	76	83	-	75	80	87	-	78	83	90	-	
	80	MBh	21.7	22.4	24.2	26.0	21.2	21.9	23.7	25.4	20.7	21.3	23.1	24.8	20.2	20.8	22.5	24.2	19.2	19.8	21.4	23.0	17.8	18.3	19.8	21.3
		ST	0.77	0.69	0.52	0.34	0.80	0.72	0.54	0.35	0.82	0.74	0.56	0.36	0.85	0.76	0.57	0.37	0.88	0.79	0.60	0.38	0.89	0.79	0.60	0.39
		Delta T	22	20	17	12	22	21	17	12	22	21	17	12	23	21	17	12	22	20	17	12	21	19	16	11
KW		1.51	1.54	1.58	1.63	1.62	1.65	1.70	1.76	1.72	1.75	1.81	1.87	1.80	1.84	1.90	1.97	1.88	1.92	1.98	2.05	1.94	1.99	2.05	2.12	
AMPS		5.4	5.5	5.6	5.8	5.7	5.9	6.0	6.2	6.2	6.3	6.5	6.7	6.5	6.7	6.8	7.1	6.9	7.0	7.2	7.5	7.2	7.4	7.6	7.9	
HI PR		139	150	158	165	156	168	177	185	177	191	202	210	202	217	230	240	227	245	258	269	251	270	285	298	
LO PR		61	65	71	75	64	69	75	80	67	71	78	83	70	75	82	87	74	78	86	91	76	81	89	94	
MBh		22.1	22.7	24.6	26.4	21.5	22.2	24.0	25.8	21.0	21.7	23.4	25.2	20.5	21.1	22.9	24.5	19.5	20.1	21.7	23.3	18.1	18.6	20.1	21.6	
ST		0.80	0.72	0.54	0.35	0.83	0.74	0.56	0.36	0.85	0.76	0.58	0.37	0.88	0.79	0.60	0.38	0.91	0.82	0.62	0.40	0.92	0.82	0.62	0.40	
Delta T		22	20	16	11	22	20	17	11	22	20	17	11	22	20	17	12	22	20	16	11	20	19	15	11	
KW	1.53	1.56	1.60	1.66	1.64	1.67	1.73	1.78	1.74	1.78	1.83	1.89	1.83	1.87	1.93	1.99	1.91	1.95	2.01	2.08	1.97	2.01	2.08	2.15		
AMPS	5.5	5.6	5.7	5.9	5.8	5.9	6.1	6.3	6.2	6.4	6.6	6.8	6.6	6.7	6.9	7.2	7.0	7.1	7.3	7.6	7.3	7.5	7.7	8.0		
HI PR	141	152	161	168	159	171	180	188	181	194	205	214	206	221	234	244	231	249	263	274	256	275	290	303		
LO PR	62	66	72	77	66	70	76	81	68	73	79	84	72	76	83	89	75	80	87	93	78	83	90	96		
85	MBh	22.7	23.4	25.3	27.2	22.2	22.8	24.7	26.5	21.7	22.3	24.1	25.9	21.1	21.8	23.6	25.3	20.1	20.7	22.4	24.0	18.6	19.1	20.7	22.2	
	ST	0.84	0.75	0.57	0.37	0.87	0.78	0.59	0.38	0.89	0.80	0.61	0.39	0.92	0.83	0.62	0.40	0.96	0.86	0.65	0.42	0.97	0.86	0.65	0.42	
	Delta T	21	19	16	11	21	19	16	11	21	19	16	11	21	19	16	11	21	19	16	11	19	18	15	10	
	KW	1.54	1.57	1.62	1.67	1.65	1.69	1.74	1.80	1.75	1.79	1.85	1.91	1.84	1.88	1.95	2.01	1.92	1.96	2.03	2.09	1.99	2.03	2.10	2.17	
	AMPS	5.5	5.6	5.8	5.9	5.9	6.0	6.2	6.3	6.3	6.4	6.6	6.8	6.7	6.8	7.0	7.2	7.0	7.2	7.4	7.6	7.4	7.6	7.8	8.0	
	HI PR	143	154	162	169	160	173	182	190	182	196	207	216	208	223	236	246	234	251	265	277	258	278	293	306	
	LO PR	63	67	73	78	66	70	77	82	69	73	80	85	72	77	84	89	76	81	88	94	78	83	91	97	

* Entering Indoor Dry Bulb Temperature

NOTE: Shaded area is ACCA (TVA) conditions

COOLING PERFORMANCE DATA

GSC130241D*

EXPANDED PERFORMANCE DATA

COOLING OPERATION

MODEL: GSC130241D* / CAUF1824*6B

IDB*	Airflow	Outdoor Ambient Temperature																													
		65					75					85					95					105					115				
		59	63	67	71	75	59	63	67	71	75	59	63	67	71	75	59	63	67	71	75	59	63	67	71	75	59	63	67	71	75
80	700	MBh	22.1	22.6	24.1	25.8	21.6	22.1	23.6	25.2	21.1	21.5	23.0	24.6	20.6	21.0	22.5	24.0	20.6	21.0	22.5	24.0	19.5	20.0	21.3	22.8	18.1	18.5	19.8	21.1	
		ST	0.85	0.80	0.65	0.48	0.88	0.83	0.67	0.50	0.90	0.85	0.69	0.51	0.93	0.87	0.71	0.53	0.93	0.87	0.71	0.53	0.97	0.91	0.74	0.55	0.97	0.91	0.74	0.56	
		Delta T	25	24	21	16	25	24	21	17	25	24	21	17	25	24	21	17	25	24	21	17	25	24	21	17	23	22	19	15	
		KW	1.52	1.55	1.60	1.65	1.63	1.66	1.72	1.77	1.82	1.73	1.77	1.82	1.88	1.82	1.86	1.92	1.98	1.82	1.86	1.92	1.98	1.89	1.94	2.00	2.07	1.96	2.00	2.07	2.14
		AMPS	5.4	5.5	5.7	5.9	5.8	5.9	6.1	6.3	6.2	6.3	6.5	6.7	6.6	6.7	6.9	7.1	6.9	7.1	7.3	7.5	7.3	7.5	7.7	7.5	7.3	7.5	7.7	7.9	
	750	HI PR	140	151	160	166	158	170	179	187	179	193	204	212	204	220	232	242	230	247	261	272	254	273	288	301					
		LO PR	62	66	72	76	65	69	76	81	68	72	79	84	71	76	83	88	75	79	87	92	77	82	90	95					
		MBh	22.5	22.9	24.5	26.2	21.9	22.4	23.9	25.6	21.4	21.9	23.4	25.0	20.9	21.3	22.8	24.4	19.8	20.3	21.7	23.2	18.4	18.8	20.1	21.4					
		ST	0.88	0.83	0.67	0.50	0.91	0.86	0.70	0.52	0.94	0.88	0.71	0.53	0.97	0.91	0.74	0.55	1.00	0.94	0.76	0.57	1.00	0.95	0.77	0.58					
		Delta T	24	23	20	16	25	23	20	16	25	24	20	16	25	24	21	16	24	23	20	16	24	23	20	16	23	22	19	15	
850	700	KW	1.54	1.57	1.62	1.67	1.65	1.69	1.74	1.80	1.75	1.79	1.85	1.91	1.85	1.89	1.95	2.01	1.85	1.89	1.95	2.01	1.92	1.96	2.03	2.10	1.99	2.03	2.10	2.17	
		AMPS	5.5	5.6	5.8	5.9	5.9	6.0	6.2	6.3	6.3	6.4	6.6	6.8	6.7	6.8	7.0	7.2	7.0	7.2	7.4	7.6	7.4	7.6	7.8	8.0					
		HI PR	143	154	162	169	160	173	182	190	182	196	207	216	208	223	236	246	234	251	266	277	258	278	293	306					
		LO PR	63	67	73	78	66	70	77	82	69	73	80	85	72	77	84	89	76	81	88	94	78	83	91	97					
		MBh	23.1	23.6	25.2	27.0	22.6	23.1	24.7	26.4	22.0	22.5	24.1	25.7	21.5	22.0	23.5	25.1	20.4	20.9	22.3	23.8	18.9	19.3	20.7	22.1					
	750	ST	0.92	0.87	0.70	0.53	0.96	0.90	0.73	0.55	1.00	0.92	0.75	0.56	1.00	0.95	0.77	0.58	1.00	0.90	0.80	0.60	1.00	0.95	0.77	0.58					
		Delta T	23	22	19	15	23	22	19	16	24	22	19	16	23	23	20	16	22	23	19	15	20	21	18	14					
		KW	1.55	1.58	1.63	1.68	1.67	1.70	1.75	1.81	1.77	1.81	1.86	1.93	1.86	1.90	1.96	2.03	1.94	1.98	2.04	2.11	2.00	2.05	2.12	2.19					
		AMPS	5.5	5.7	5.8	6.0	5.9	6.0	6.2	6.4	6.3	6.5	6.7	6.9	6.7	6.9	7.1	7.3	7.1	7.2	7.5	7.7	7.5	7.6	7.8	8.1					
		HI PR	144	155	164	171	162	174	184	192	184	198	209	218	210	226	238	249	236	254	268	280	261	281	296	309					
85	700	LO PR	63	67	74	78	67	71	78	83	70	74	81	86	73	78	85	90	77	81	89	96	79	84	92	98					
		MBh	22.5	22.9	24.0	25.6	22.0	22.4	23.5	25.0	21.5	21.9	22.9	24.4	20.9	21.3	22.3	23.8	19.9	20.3	21.2	22.6	18.4	18.8	19.7	21.0					
		ST	0.89	0.86	0.77	0.63	0.92	0.89	0.80	0.65	0.95	0.91	0.82	0.67	0.98	0.94	0.85	0.69	1.00	0.98	0.88	0.72	1.00	0.99	0.89	0.72					
		Delta T	26	26	24	21	27	26	25	21	27	26	25	21	27	26	25	22	26	26	25	21	24	24	23	20					
		KW	1.53	1.56	1.61	1.66	1.64	1.68	1.73	1.79	1.74	1.78	1.84	1.90	1.83	1.87	1.93	2.00	1.91	1.95	2.02	2.08	1.98	2.02	2.09	2.16					
	750	AMPS	5.5	5.6	5.7	5.9	5.8	6.0	6.1	6.3	6.3	6.4	6.6	6.8	6.6	6.8	7.0	7.2	7.0	7.1	7.3	7.6	7.4	7.5	7.7	8.0					
		HI PR	142	153	161	168	159	171	181	189	181	195	206	215	206	222	234	244	232	250	264	275	256	276	291	304					
		LO PR	62	66	72	77	66	70	76	81	68	73	79	85	72	76	83	89	75	80	87	93	78	83	90	96					
		MBh	22.8	23.3	24.4	26.0	22.3	22.7	23.8	25.4	21.8	22.2	23.3	24.8	21.2	21.7	22.7	24.2	20.2	20.6	21.6	23.0	18.7	19.1	20.0	21.3					
		ST	0.92	0.89	0.80	0.65	0.96	0.92	0.83	0.68	0.98	0.95	0.85	0.69	1.00	0.98	0.88	0.72	1.00	1.00	0.91	0.74	1.00	1.00	0.92	0.75					
850	700	Delta T	26	25	24	21	26	26	24	21	26	26	24	21	26	26	25	21	25	25	24	21	23	23	20						
		KW	1.55	1.58	1.63	1.68	1.67	1.70	1.75	1.81	1.77	1.81	1.86	1.93	1.86	1.90	1.96	2.03	1.94	1.98	2.04	2.11	2.00	2.05	2.12	2.19					
		AMPS	5.5	5.7	5.8	6.0	5.9	6.0	6.2	6.4	6.3	6.5	6.7	6.9	6.7	6.9	7.1	7.3	7.1	7.2	7.5	7.7	7.5	7.6	7.8	8.1					
		HI PR	144	155	164	171	162	174	184	192	184	198	209	218	210	226	238	249	236	254	268	280	261	281	296	309					
		LO PR	63	67	74	78	67	71	78	83	70	74	81	86	73	78	85	90	77	81	89	95	79	84	92	98					
	750	MBh	23.5	24.0	25.1	26.8	23.0	23.4	24.5	26.2	22.4	22.9	24.0	25.6	21.9	22.3	23.4	24.9	20.8	21.2	22.2	23.7	19.3	19.6	20.6	21.9					
		ST	0.97	0.93	0.84	0.68	1.00	0.97	0.87	0.71	1.00	0.99	0.90	0.73	1.00	1.00	0.92	0.75	1.00	1.00	0.96	0.78	1.00	1.00	0.97	0.78					
		Delta T	25	24	23	20	25	25	23	20	24	25	23	20	24	24	23	20	22	23	23	20	21	21	22	19					
		KW	1.56	1.59	1.64	1.70	1.68	1.71	1.77	1.83	1.78	1.82	1.88	1.94	1.88	1.92	1.98	2.04	1.95	2.00	2.06	2.13	2.02	2.07	2.13	2.21					
		AMPS	5.6	5.7	5.9	6.0	6.0	6.1	6.2	6.4	6.4	6.5	6.7	6.9	6.8	6.9	7.1	7.3	7.1	7.3	7.5	7.8	7.5	7.7	7.9	8.2					
850	HI PR	146	157	166	173	164	176	186	194	186	200	211	220	212	228	241	251	238	256	271	282	263	283	299	312						
	LO PR	64	68	74	79	68	72	78	84	70	75	82	87	74	78	86	91	77	82	90	96	80	85	93	99						

NOTE: Shaded area is AHRI Rating Conditions

* Entering Indoor Dry Bulb Temperature

COOLING PERFORMANCE DATA

GSC130301A*

EXPANDED PERFORMANCE DATA

COOLING OPERATION

MODEL: GSC130301A* / CAUF3131C6A

IDB*	Airflow	Outdoor Ambient Temperature																													
		65					75					85					95					105					115				
		59	63	67	71	75	59	63	67	71	75	59	63	67	71	75	59	63	67	71	75	59	63	67	71	75	59	63	67	71	75
70	1182	MBh	28.4	29.5	32.3	-	27.8	28.8	31.5	-	27.1	28.1	30.8	-	26.4	27.4	30.0	-	25.1	26.0	28.5	-	23.3	24.1	26.4	-					
		S/T	0.75	0.62	0.43	-	0.77	0.65	0.45	-	0.79	0.66	0.46	-	0.82	0.68	0.47	-	0.85	0.71	0.49	-	0.86	0.72	0.50	-					
		Delta T	17	14	11	-	17	14	11	-	17	14	11	-	17	15	11	-	17	14	11	-	16	13	10	-					
		KW	1.99	2.03	2.08	-	2.13	2.17	2.23	-	2.25	2.29	2.36	-	2.36	2.40	2.48	-	2.45	2.50	2.57	-	2.53	2.58	2.66	-					
		AMPS	7.0	7.1	7.4	-	7.5	7.7	8.0	-	8.2	8.4	8.6	-	8.7	8.9	9.2	-	9.3	9.5	9.8	-	9.8	10.1	10.4	-					
	1050	HI PR	142	153	162	-	160	172	182	-	182	196	206	-	207	223	235	-	233	251	265	-	257	277	292	-					
		LO PR	64	68	74	-	67	71	78	-	70	74	81	-	73	78	85	-	77	82	89	-	79	84	92	-					
		MBh	27.6	28.6	31.3	-	26.9	27.9	30.6	-	26.3	27.3	29.9	-	25.7	26.6	29.1	-	24.4	25.3	27.7	-	22.6	23.4	25.6	-					
		S/T	0.71	0.60	0.41	-	0.74	0.62	0.43	-	0.76	0.63	0.44	-	0.78	0.65	0.45	-	0.81	0.68	0.47	-	0.82	0.68	0.47	-					
		Delta T	17	15	11	-	17	15	11	-	17	15	11	-	18	15	12	-	17	15	11	-	16	14	11	-					
919	1050	KW	1.97	2.01	2.07	-	2.11	2.15	2.21	-	2.23	2.28	2.34	-	2.34	2.39	2.46	-	2.43	2.48	2.55	-	2.51	2.56	2.64	-					
		AMPS	6.9	7.1	7.3	-	7.5	7.6	7.9	-	8.1	8.3	8.6	-	8.6	8.9	9.1	-	9.2	9.4	9.7	-	9.7	10.0	10.3	-					
		HI PR	141	152	160	-	158	170	180	-	180	194	204	-	205	220	233	-	231	248	262	-	255	274	289	-					
		LO PR	63	67	73	-	66	71	77	-	69	73	80	-	73	77	84	-	76	81	88	-	79	84	91	-					
		MBh	25.5	26.4	28.9	-	24.9	25.8	28.2	-	24.3	25.2	27.6	-	23.7	24.6	26.9	-	22.5	23.3	25.6	-	20.8	21.6	23.7	-					
	919	S/T	0.69	0.57	0.40	-	0.71	0.59	0.41	-	0.73	0.61	0.42	-	0.75	0.63	0.44	-	0.78	0.65	0.45	-	0.79	0.66	0.46	-					
		Delta T	18	15	12	-	18	15	12	-	18	15	12	-	18	15	12	-	18	15	12	-	16	14	11	-					
		KW	1.93	1.97	2.02	-	2.06	2.10	2.16	-	2.18	2.22	2.29	-	2.28	2.33	2.40	-	2.37	2.42	2.49	-	2.45	2.50	2.57	-					
		AMPS	6.7	6.9	7.1	-	7.3	7.4	7.7	-	7.9	8.1	8.3	-	8.4	8.6	8.9	-	8.9	9.2	9.5	-	9.5	9.7	10.0	-					
		HI PR	137	147	155	-	153	165	174	-	175	188	198	-	199	214	226	-	224	241	254	-	247	266	281	-					
LO PR	61	65	71	-	64	69	75	-	67	71	78	-	70	75	82	-	74	78	86	-	76	81	89	-							

75	1182	MBh	28.9	29.8	32.2	34.6	28.2	29.1	31.5	33.8	27.6	28.4	30.7	33.0	26.9	27.7	30.0	32.2	25.5	26.3	28.5	30.5	23.7	24.4	26.4	28.3
		S/T	0.85	0.76	0.58	0.37	0.88	0.79	0.60	0.38	0.90	0.81	0.61	0.39	0.93	0.83	0.63	0.41	0.97	0.87	0.65	0.42	0.98	0.87	0.66	0.42
		Delta T	19	18	14	10	19	18	15	10	19	18	15	10	19	18	15	10	19	18	14	10	18	17	14	9
		KW	2.00	2.04	2.10	2.16	2.14	2.18	2.25	2.32	2.26	2.31	2.38	2.45	2.37	2.42	2.50	2.57	2.47	2.52	2.59	2.68	2.55	2.60	2.68	2.76
		AMPS	7.0	7.2	7.4	7.7	7.6	7.8	8.0	8.3	8.2	8.4	8.7	9.0	8.8	9.0	9.3	9.7	9.4	9.6	9.9	10.3	9.9	10.2	10.5	10.9
	1050	HI PR	144	155	163	170	161	174	183	191	184	198	209	218	209	225	238	248	235	253	267	279	260	280	295	308
		LO PR	64	68	75	79	68	72	79	84	70	75	82	87	74	79	86	92	78	83	90	96	80	85	93	99
		MBh	28.1	28.9	31.3	33.6	27.4	28.2	30.5	32.8	26.8	27.5	29.8	32.0	26.1	26.9	29.1	31.2	24.8	25.5	27.6	29.7	23.0	23.6	25.6	27.5
		S/T	0.81	0.72	0.55	0.35	0.84	0.75	0.57	0.37	0.86	0.77	0.58	0.37	0.89	0.79	0.60	0.39	0.92	0.83	0.62	0.40	0.93	0.83	0.63	0.41
		Delta T	20	18	15	10	20	19	15	10	20	19	15	11	20	19	15	11	20	18	15	10	19	17	14	10
919	KW	1.99	2.03	2.08	2.14	2.13	2.17	2.23	2.30	2.25	2.29	2.36	2.43	2.36	2.40	2.48	2.55	2.45	2.50	2.57	2.65	2.53	2.58	2.66	2.74	
	AMPS	7.0	7.1	7.4	7.6	7.5	7.7	8.0	8.2	8.2	8.4	8.6	9.0	8.7	8.9	9.2	9.6	9.3	9.5	9.8	10.2	9.8	10.1	10.4	10.8	
	HI PR	142	153	162	169	160	172	182	189	182	196	207	215	207	223	235	245	233	251	265	276	257	277	292	305	
	LO PR	64	68	74	79	67	71	78	83	70	74	81	86	73	78	85	91	77	82	89	95	79	85	92	98	
	MBh	25.9	26.7	28.9	31.0	25.3	26.0	28.2	30.3	24.7	25.4	27.5	29.5	24.1	24.8	26.8	28.8	22.9	23.6	25.5	27.4	21.2	21.8	23.6	25.4	
919	S/T	0.78	0.70	0.53	0.34	0.81	0.72	0.55	0.35	0.83	0.74	0.56	0.36	0.86	0.77	0.58	0.37	0.89	0.80	0.60	0.39	0.90	0.80	0.61	0.39	
	Delta T	20	19	15	11	20	19	15	11	21	19	15	11	21	19	16	11	20	19	15	11	19	18	14	10	
	KW	1.95	1.98	2.04	2.10	2.08	2.12	2.18	2.25	2.20	2.24	2.31	2.38	2.30	2.35	2.42	2.49	2.39	2.44	2.51	2.59	2.47	2.52	2.60	2.68	
	AMPS	6.8	6.9	7.2	7.4	7.3	7.5	7.7	8.0	7.9	8.1	8.4	8.7	8.5	8.7	9.0	9.3	9.0	9.2	9.5	9.9	9.6	9.8	10.1	10.5	
	HI PR	138	149	157	164	155	167	176	184	176	190	200	209	201	216	228	238	226	243	257	268	250	269	284	296	
LO PR	62	66	72	76	65	69	76	81	68	72	79	84	71	76	83	88	74	79	87	92	77	82	89	95		

NOTE: Shaded area is ACCA (TVA) conditions

* Entering Indoor Dry Bulb Temperature

COOLING PERFORMANCE DATA

GSC130301A*

EXPANDED PERFORMANCE DATA

COOLING OPERATION

MODEL: GSC130301A* / CAUF3131C6A

IDB*	Airflow	Outdoor Ambient Temperature																								
		65				75				85				95				105				115				
		59	63	67	71	59	63	67	71	59	63	67	71	59	63	67	71	59	63	67	71	59	63	67	71	
80	1182	MBh	29.4	30.1	32.1	34.3	28.7	29.4	31.4	33.5	28.0	28.7	30.6	32.7	27.4	28.0	29.9	31.9	26.0	26.6	28.4	30.3	24.1	24.6	26.3	28.1
		S/T	0.93	0.87	0.71	0.53	0.97	0.91	0.74	0.55	1.00	0.93	0.76	0.56	1.00	0.96	0.78	0.58	1.00	1.00	0.81	0.61	1.00	1.00	0.82	0.61
		Delta T	21	20	18	14	22	21	18	14	22	21	18	14	21	21	18	14	20	21	18	14	19	19	17	13
		KW	2.02	2.06	2.11	2.18	2.16	2.20	2.27	2.33	2.28	2.33	2.40	2.47	2.39	2.44	2.52	2.59	2.49	2.54	2.61	2.70	2.57	2.62	2.70	2.79
		AMPS	7.1	7.3	7.5	7.8	7.7	7.8	8.1	8.4	8.3	8.5	8.8	9.1	8.9	9.1	9.4	9.8	9.4	9.7	10.0	10.4	10.0	10.3	10.6	11.0
	1050	LO PR	145	156	165	172	163	175	185	193	185	200	211	220	211	227	240	250	238	256	270	282	262	282	298	311
		MBh	65	69	75	80	68	73	80	85	71	76	83	88	75	80	87	92	78	83	91	97	81	86	94	100
		S/T	28.6	29.2	31.2	33.3	27.9	28.5	30.5	32.6	27.2	27.8	29.7	31.8	26.6	27.1	29.0	31.0	25.2	25.8	27.6	29.5	23.4	23.9	25.5	27.3
		Delta T	22	21	19	15	22	22	19	15	23	22	19	15	23	22	19	15	22	21	19	15	20	20	17	14
		KW	2.00	2.04	2.10	2.16	2.14	2.18	2.25	2.32	2.27	2.31	2.38	2.45	2.37	2.42	2.50	2.57	2.47	2.52	2.59	2.68	2.55	2.60	2.68	2.76
919	AMPS	7.0	7.2	7.4	7.7	7.6	7.8	8.0	8.3	8.2	8.4	8.7	9.0	8.8	9.0	9.3	9.7	9.4	9.6	9.9	10.3	9.9	10.2	10.5	10.9	
	HI PR	144	155	163	170	161	174	183	191	184	198	209	218	209	225	238	248	235	253	267	279	260	280	295	308	
	LO PR	64	68	75	79	68	72	79	84	70	75	82	87	74	79	86	92	78	83	90	96	80	85	93	99	
	MBh	26.4	26.9	28.8	30.8	25.7	26.3	28.1	30.0	25.1	25.7	27.4	29.3	24.5	25.1	26.8	28.6	23.3	23.8	25.4	27.2	21.6	22.0	23.6	25.2	
	S/T	0.86	0.80	0.65	0.49	0.89	0.83	0.68	0.51	0.91	0.85	0.70	0.52	0.94	0.88	0.72	0.54	0.98	0.91	0.74	0.56	0.98	0.92	0.75	0.56	

85	1182	MBh	29.1	29.6	31.0	33.1	28.4	28.9	30.3	32.3	27.7	28.2	29.6	31.6	27.0	27.6	28.9	30.8	25.7	26.2	27.4	29.2	23.8	24.2	25.4	27.1
		S/T	0.93	0.90	0.81	0.66	0.97	0.93	0.84	0.68	0.99	0.96	0.86	0.70	1.00	0.99	0.89	0.72	1.00	1.00	0.92	0.75	1.00	1.00	0.93	0.76
		Delta T	24	23	22	19	24	24	22	19	24	24	22	19	24	24	22	19	22	23	22	19	21	21	21	18
		KW	2.02	2.06	2.11	2.18	2.16	2.20	2.27	2.33	2.28	2.33	2.40	2.47	2.39	2.44	2.52	2.59	2.49	2.54	2.61	2.70	2.57	2.62	2.70	2.79
		AMPS	7.1	7.3	7.5	7.8	7.7	7.8	8.1	8.4	8.3	8.5	8.8	9.1	8.9	9.1	9.4	9.8	9.4	9.7	10.0	10.4	10.0	10.3	10.6	11.0
	1050	HI PR	145	156	165	172	163	175	185	193	185	200	211	220	211	227	240	250	238	256	270	282	262	282	298	311
		LO PR	65	69	75	80	68	73	80	85	71	76	83	88	75	80	87	92	78	83	91	97	81	86	94	100
		MBh	26.8	27.3	28.6	30.5	26.2	26.7	28.0	29.8	25.6	26.1	27.3	29.1	24.9	25.4	26.6	28.4	23.7	24.2	25.3	27.0	22.0	22.4	23.4	25.0
		S/T	0.90	0.87	0.78	0.63	0.93	0.90	0.81	0.66	0.95	0.92	0.83	0.67	0.99	0.95	0.86	0.70	1.00	0.99	0.89	0.72	1.00	1.00	0.90	0.73
		Delta T	24	24	22	19	24	24	23	20	24	24	22	19	25	24	23	20	24	24	23	20	22	22	21	18
919	KW	1.97	2.01	2.07	2.13	2.11	2.15	2.21	2.28	2.23	2.28	2.34	2.41	2.34	2.38	2.46	2.53	2.43	2.48	2.55	2.63	2.51	2.56	2.64	2.72	
	AMPS	6.9	7.1	7.3	7.6	7.5	7.6	7.9	8.2	8.1	8.3	8.6	8.9	8.6	8.8	9.1	9.5	9.2	9.4	9.7	10.1	9.7	10.0	10.3	10.7	
	HI PR	141	152	160	167	158	170	180	187	180	194	204	213	205	220	233	243	230	248	262	273	255	274	289	302	
	LO PR	63	67	73	78	66	71	77	82	69	73	80	85	73	77	84	90	76	81	88	94	79	84	91	97	

* Entering Indoor Dry Bulb Temperature

NOTE: Shaded area is AHRI Rating Conditions

COOLING PERFORMANCE DATA

GSC130301C*

EXPANDED PERFORMANCE DATA

COOLING OPERATION

MODEL: GSC130301C* / CA*F303016** / CR23K7-PFV

IDB*	Airflow	Outdoor Ambient Temperature																													
		65					75					85					95					105					115				
		59	63	67	71	75	59	63	67	71	75	59	63	67	71	75	59	63	67	71	75	59	63	67	71	75	59	63	67	71	75
70	1182	MBh	28.4	29.5	32.3	-	27.8	28.8	31.5	-	27.1	28.1	30.8	-	26.4	27.4	30.0	-	25.1	26.0	28.5	-	23.3	24.1	26.4	-					
		S/T	0.75	0.62	0.43	-	0.77	0.65	0.45	-	0.79	0.66	0.46	-	0.82	0.68	0.47	-	0.85	0.71	0.49	-	0.86	0.72	0.50	-					
		Delta T	17	14	11	-	17	14	11	-	17	14	11	-	17	15	11	-	17	14	11	-	16	13	10	-					
		KW	1.95	1.99	2.05	-	2.09	2.13	2.20	-	2.21	2.26	2.33	-	2.32	2.37	2.44	-	2.41	2.46	2.54	-	2.49	2.54	2.62	-					
		AMPS	6.5	6.7	6.9	-	7.0	7.2	7.4	-	7.6	7.8	8.0	-	8.1	8.3	8.6	-	8.6	8.8	9.1	-	9.1	9.3	9.6	-					
		HI PR	137	148	156	-	154	166	175	-	175	188	199	-	199	215	227	-	224	241	255	-	248	267	282	-					
70	1050	LO PR	63	67	73	-	66	71	77	-	69	73	80	-	72	77	84	-	76	81	88	-	79	84	91	-					
		MBh	27.6	28.6	31.3	-	26.9	27.9	30.6	-	26.3	27.3	29.9	-	25.7	26.6	29.1	-	24.4	25.3	27.7	-	22.6	23.4	25.6	-					
		S/T	0.71	0.60	0.41	-	0.74	0.62	0.43	-	0.76	0.63	0.44	-	0.78	0.65	0.45	-	0.81	0.68	0.47	-	0.82	0.68	0.47	-					
		Delta T	17	15	11	-	17	15	11	-	17	15	11	-	18	15	12	-	17	15	11	-	16	14	11	-					
		KW	1.94	1.98	2.03	-	2.07	2.12	2.18	-	2.20	2.24	2.31	-	2.30	2.35	2.42	-	2.39	2.44	2.52	-	2.47	2.52	2.60	-					
		AMPS	6.5	6.6	6.8	-	7.0	7.1	7.3	-	7.5	7.7	8.0	-	8.0	8.2	8.5	-	8.5	8.7	9.0	-	9.0	9.2	9.6	-					
70	919	HI PR	136	146	154	-	152	164	173	-	173	187	197	-	197	213	224	-	222	239	252	-	245	264	279	-					
		LO PR	62	66	72	-	66	70	76	-	68	73	79	-	72	76	83	-	75	80	87	-	78	83	90	-					
		MBh	25.5	26.4	28.9	-	24.9	25.8	28.2	-	24.3	25.2	27.6	-	23.7	24.6	26.9	-	22.5	23.3	25.6	-	20.8	21.6	23.7	-					
		S/T	0.69	0.57	0.40	-	0.71	0.59	0.41	-	0.73	0.61	0.42	-	0.75	0.63	0.44	-	0.78	0.65	0.45	-	0.79	0.66	0.46	-					
		Delta T	18	15	12	-	18	15	12	-	18	15	12	-	18	15	12	-	18	15	12	-	16	14	11	-					
		KW	1.90	1.93	1.99	-	2.03	2.07	2.13	-	2.15	2.19	2.25	-	2.25	2.29	2.36	-	2.34	2.38	2.46	-	2.41	2.46	2.54	-					
75	1182	AMPS	6.3	6.4	6.6	-	6.8	6.9	7.2	-	7.3	7.5	7.8	-	7.8	8.0	8.3	-	8.3	8.5	8.8	-	8.8	9.0	9.3	-					
		HI PR	132	142	150	-	148	159	168	-	168	181	191	-	192	206	218	-	216	232	245	-	238	256	271	-					
		LO PR	60	64	70	-	64	68	74	-	66	70	77	-	70	74	81	-	73	78	85	-	75	80	88	-					
		MBh	28.9	29.8	32.2	34.6	28.2	29.1	31.5	33.8	27.6	28.4	30.7	33.0	26.9	27.7	30.0	32.2	25.5	26.3	28.5	30.5	23.7	24.4	26.4	28.3					
		S/T	0.85	0.76	0.58	0.37	0.88	0.79	0.60	0.38	0.90	0.81	0.61	0.39	0.93	0.83	0.63	0.41	0.97	0.87	0.65	0.42	0.98	0.87	0.66	0.42					
		Delta T	19	18	14	10	19	18	15	10	19	18	15	10	19	18	15	10	19	18	14	10	18	17	14	9					
75	1050	KW	1.97	2.01	2.06	2.12	2.11	2.15	2.21	2.28	2.23	2.27	2.34	2.42	2.34	2.39	2.46	2.54	2.43	2.48	2.56	2.64	2.51	2.56	2.64	2.73					
		AMPS	6.6	6.7	6.9	7.2	7.1	7.2	7.5	7.7	7.7	7.9	8.1	8.4	8.2	8.4	8.6	9.0	8.7	8.9	9.2	9.5	9.2	9.4	9.7	10.1					
		HI PR	139	149	158	164	156	167	177	184	177	190	201	210	201	217	229	239	227	244	258	269	250	270	285	297					
		LO PR	63	67	74	78	67	71	78	83	70	74	81	86	73	78	85	91	77	82	89	95	79	84	92	98					
		MBh	28.1	28.9	31.3	33.6	27.4	28.2	30.5	32.8	26.8	27.5	29.8	32.0	26.1	26.9	29.1	31.2	24.8	25.5	27.6	29.7	23.0	23.6	25.6	27.5					
		S/T	0.81	0.72	0.55	0.35	0.84	0.75	0.57	0.37	0.86	0.77	0.58	0.37	0.89	0.79	0.60	0.39	0.92	0.83	0.62	0.40	0.93	0.83	0.63	0.41					
75	919	Delta T	20	18	15	10	20	19	15	10	20	19	15	11	20	19	15	11	20	18	15	10	19	17	14	10					
		KW	1.95	1.99	2.05	2.11	2.09	2.13	2.20	2.26	2.21	2.26	2.33	2.40	2.32	2.37	2.44	2.52	2.41	2.46	2.54	2.62	2.49	2.54	2.62	2.71					
		AMPS	6.5	6.7	6.9	7.1	7.0	7.2	7.4	7.7	7.6	7.8	8.0	8.3	8.1	8.3	8.6	8.9	8.6	8.8	9.1	9.4	9.1	9.3	9.6	10.0					
		HI PR	137	148	156	163	154	166	175	183	175	189	199	208	200	215	227	236	224	242	255	266	248	267	282	294					
		LO PR	63	67	73	78	66	71	77	82	69	73	80	85	72	77	84	90	76	81	88	94	79	84	91	97					
		MBh	25.9	26.7	28.9	31.0	25.3	26.0	28.2	30.3	24.7	25.4	27.5	29.5	24.1	24.8	26.8	28.8	22.9	23.6	25.5	27.4	21.2	21.8	23.6	25.4					
75	919	S/T	0.78	0.70	0.53	0.34	0.81	0.72	0.55	0.35	0.83	0.74	0.56	0.36	0.86	0.77	0.58	0.37	0.89	0.80	0.60	0.39	0.90	0.80	0.61	0.39					
		Delta T	20	19	15	11	20	19	15	11	21	19	15	11	21	19	16	11	20	19	15	11	19	18	14	10					
		KW	1.91	1.95	2.00	2.06	2.04	2.08	2.15	2.21	2.16	2.21	2.27	2.34	2.27	2.31	2.38	2.46	2.35	2.40	2.48	2.56	2.43	2.48	2.56	2.64					
		AMPS	6.3	6.5	6.7	6.9	6.8	7.0	7.2	7.5	7.4	7.6	7.8	8.1	7.9	8.1	8.3	8.6	8.4	8.6	8.9	9.2	8.9	9.1	9.4	9.7					
		HI PR	133	143	151	158	149	161	170	177	170	183	193	201	194	208	220	229	218	234	247	258	241	259	273	285					
		LO PR	61	65	71	75	64	68	75	80	67	71	78	83	70	75	82	87	74	78	86	91	76	81	88	94					

* Entering Indoor Dry Bulb Temperature

NOTE: Shaded area is ACCA (TVA) conditions

COOLING PERFORMANCE DATA

GSC130301C*

EXPANDED PERFORMANCE DATA

COOLING OPERATION

MODEL: GSC130301C* / CA*F303016** / CR23K7-PFV

IDB*	Airflow	Outdoor Ambient Temperature																								
		65				75				85				95				105				115				
		59	63	67	71	59	63	67	71	59	63	67	71	59	63	67	71	59	63	67	71	59	63	67	71	
80	1182	MBh	29.4	30.1	32.1	34.3	28.7	29.4	31.4	33.5	28.0	28.7	30.6	32.7	27.4	28.0	29.9	31.9	26.0	26.6	28.4	30.3	24.1	24.6	26.3	28.1
		S/T	0.93	0.87	0.71	0.53	0.97	0.91	0.74	0.55	1.00	0.93	0.76	0.56	1.00	0.96	0.78	0.58	1.00	1.00	0.81	0.61	1.00	1.00	0.82	0.61
		Delta T	21	20	18	14	22	21	18	14	21	21	18	14	21	21	18	14	20	21	18	14	19	19	17	13
		KW	1.98	2.02	2.08	2.14	2.12	2.16	2.23	2.30	2.25	2.29	2.36	2.44	2.36	2.41	2.48	2.56	2.45	2.50	2.58	2.66	2.53	2.58	2.66	2.75
		AMPS	6.6	6.8	7.0	7.2	7.1	7.3	7.5	7.8	7.7	7.9	8.2	8.5	8.3	8.5	8.7	9.0	8.8	9.0	9.3	9.6	9.3	9.5	9.8	10.2
	1050	HI PR	140	151	159	166	157	169	179	186	179	192	203	212	204	219	231	241	229	246	260	271	253	272	287	300
		LO PR	64	68	74	79	68	72	79	84	70	75	82	87	74	79	86	91	77	82	90	96	80	85	93	99
		MBh	28.6	29.2	31.2	33.3	27.9	28.5	30.5	32.6	27.2	27.8	29.7	31.8	26.6	27.1	29.0	31.0	25.2	25.8	27.6	29.5	23.4	23.9	25.5	27.3
		S/T	0.89	0.83	0.68	0.51	0.92	0.86	0.70	0.53	0.94	0.89	0.72	0.54	0.97	0.91	0.74	0.56	1.00	0.95	0.77	0.58	1.00	0.96	0.78	0.58
		Delta T	22	21	19	15	22	22	19	15	23	22	19	15	23	22	19	15	22	21	19	15	20	20	17	14
919	1050	KW	1.97	2.01	2.06	2.13	2.11	2.15	2.21	2.28	2.23	2.27	2.34	2.42	2.34	2.39	2.46	2.54	2.43	2.48	2.56	2.64	2.51	2.56	2.64	2.73
		AMPS	6.6	6.7	6.9	7.2	7.1	7.2	7.5	7.7	7.7	7.9	8.1	8.4	8.2	8.4	8.7	9.0	8.7	8.9	9.2	9.5	9.2	9.4	9.7	10.1
		HI PR	139	149	158	164	156	167	177	184	177	190	201	210	202	217	229	239	227	244	258	269	250	270	285	297
		LO PR	63	68	74	78	67	71	78	83	70	74	81	86	73	78	85	91	77	82	89	95	79	84	92	98
		MBh	26.4	26.9	28.8	30.8	25.7	26.3	28.1	30.0	25.1	25.7	27.4	29.3	24.5	25.1	26.8	28.6	23.3	23.8	25.4	27.2	21.6	22.0	23.6	25.2
	919	S/T	0.86	0.80	0.65	0.49	0.89	0.83	0.68	0.51	0.91	0.85	0.70	0.52	0.94	0.88	0.72	0.54	0.98	0.91	0.74	0.56	0.98	0.92	0.75	0.56
		Delta T	23	22	19	15	23	22	19	15	23	22	19	15	23	22	19	15	23	22	19	15	21	21	18	14
		KW	1.92	1.96	2.02	2.08	2.06	2.10	2.16	2.23	2.18	2.22	2.29	2.36	2.28	2.33	2.40	2.48	2.37	2.42	2.50	2.58	2.45	2.50	2.58	2.66
		AMPS	6.4	6.6	6.8	7.0	6.9	7.1	7.3	7.5	7.5	7.6	7.9	8.2	8.0	8.2	8.4	8.7	8.5	8.7	8.9	9.3	8.9	9.2	9.5	9.8
		HI PR	134	145	153	159	151	162	171	179	172	185	195	203	195	210	222	232	220	237	250	261	243	261	276	288
85	1182	LO PR	62	65	71	76	65	69	76	80	68	72	78	84	71	76	82	88	74	79	86	92	77	82	89	95
		MBh	29.9	30.5	31.9	34.1	29.2	29.8	31.2	33.3	28.5	29.1	30.5	32.5	27.8	28.4	29.7	31.7	26.4	27.0	28.2	30.1	24.5	25.0	26.2	27.9
		S/T	0.98	0.94	0.85	0.69	1.00	0.98	0.88	0.72	1.00	1.00	0.90	0.73	1.00	1.00	0.93	0.76	1.00	1.00	0.97	0.79	1.00	1.00	0.98	0.79
		Delta T	23	22	21	18	23	23	21	19	22	23	21	19	22	22	22	19	21	21	21	18	19	19	20	17
		KW	2.00	2.03	2.09	2.16	2.14	2.18	2.25	2.32	2.26	2.31	2.38	2.45	2.37	2.42	2.50	2.58	2.47	2.52	2.60	2.68	2.55	2.60	2.69	2.77
	1050	AMPS	6.7	6.8	7.1	7.3	7.2	7.4	7.6	7.9	7.8	8.0	8.3	8.6	8.3	8.5	8.8	9.1	8.9	9.1	9.4	9.7	9.4	9.6	9.9	10.3
		HI PR	141	152	161	168	159	171	180	188	180	194	205	214	206	221	234	244	231	249	263	274	256	275	290	303
		LO PR	65	69	75	80	68	73	79	85	71	76	83	88	75	79	87	92	78	83	91	97	81	86	94	100
		MBh	29.1	29.6	31.0	33.1	28.4	28.9	30.3	32.3	27.7	28.2	29.6	31.6	27.0	27.6	28.9	30.8	25.7	26.2	27.4	29.2	23.8	24.2	25.4	27.1
		S/T	0.93	0.90	0.81	0.66	0.97	0.93	0.84	0.68	0.99	0.96	0.86	0.70	1.00	0.99	0.89	0.72	1.00	1.00	0.92	0.75	1.00	1.00	0.93	0.76
919	1050	Delta T	24	23	22	19	24	24	22	19	24	24	22	19	24	24	22	19	22	23	22	19	21	21	21	18
		KW	1.98	2.02	2.08	2.14	2.12	2.16	2.23	2.30	2.25	2.29	2.36	2.44	2.36	2.41	2.48	2.56	2.45	2.50	2.58	2.66	2.53	2.58	2.66	2.75
		AMPS	6.6	6.8	7.0	7.2	7.1	7.3	7.5	7.8	7.7	7.9	8.2	8.5	8.3	8.5	8.7	9.0	8.8	9.0	9.3	9.6	9.3	9.5	9.8	10.2
		HI PR	140	151	159	166	157	169	179	186	179	192	203	212	204	219	231	241	229	246	260	271	253	272	287	300
		LO PR	64	68	74	79	68	72	79	84	70	75	82	87	74	79	86	91	77	82	90	96	80	85	93	99
	919	MBh	26.8	27.3	28.6	30.5	26.2	26.7	28.0	29.8	25.6	26.1	27.3	29.1	24.9	25.4	26.6	28.4	23.7	24.2	25.3	27.0	22.0	22.4	23.4	25.0
		S/T	0.90	0.87	0.78	0.63	0.93	0.90	0.81	0.66	0.95	0.92	0.83	0.67	0.99	0.95	0.86	0.70	1.00	0.99	0.89	0.72	1.00	1.00	0.90	0.73
		Delta T	24	24	22	19	24	24	23	20	24	24	23	20	24	24	23	20	24	24	23	20	22	22	21	18
		KW	1.94	1.98	2.03	2.09	2.07	2.12	2.18	2.24	2.19	2.24	2.31	2.38	2.30	2.35	2.42	2.50	2.39	2.44	2.52	2.60	2.47	2.52	2.60	2.68
		AMPS	6.5	6.6	6.8	7.1	7.0	7.1	7.3	7.6	7.5	7.7	8.0	8.3	8.0	8.2	8.5	8.8	8.5	8.7	9.0	9.4	9.0	9.2	9.5	9.9
HI PR	136	146	154	161	152	164	173	181	173	187	197	205	197	212	224	234	222	239	252	263	245	264	279	291		
LO PR	62	66	72	77	66	70	76	81	68	73	79	84	72	76	83	89	75	80	87	93	78	83	90	96		

NOTE: Shaded area is AHRI Rating Conditions

* Entering Indoor Dry Bulb Temperature

COOLING PERFORMANCE DATA

GSC130301D*

EXPANDED PERFORMANCE DATA

COOLING OPERATION

MODEL: GSC130301 / CA*F3030*6C*

IDB*	Airflow	Outdoor Ambient Temperature																								
		65				75				85				95				105				115				
		59	63	67	71	59	63	67	71	59	63	67	71	59	63	67	71	59	63	67	71	59	63	67	71	
70	875	MBh	25.1	26.0	28.5	-	24.5	25.4	27.9	-	23.9	24.8	27.2	-	23.4	24.2	26.5	-	22.2	23.0	25.2	-	20.6	21.3	23.3	-
		S/T	0.71	0.59	0.41	-	0.73	0.61	0.42	-	0.75	0.63	0.44	-	0.78	0.65	0.45	-	0.81	0.67	0.47	-	0.81	0.68	0.47	-
		Delta T	19	16	12	-	19	16	12	-	19	16	12	-	19	17	13	-	19	16	12	-	18	15	12	-
		KW	1.90	1.94	1.99	-	2.03	2.07	2.13	-	2.15	2.19	2.26	-	2.25	2.30	2.37	-	2.34	2.39	2.46	-	2.41	2.46	2.54	-
		AMPS	6.3	6.5	6.7	-	6.8	7.0	7.2	-	7.4	7.6	7.9	-	7.9	8.1	8.4	-	8.4	8.7	8.9	-	8.9	9.2	9.5	-
		HIPR	132	142	150	-	149	160	169	-	169	182	192	-	192	207	219	-	216	233	246	-	239	257	272	-
		LOPR	59	63	69	-	63	67	73	-	65	69	75	-	68	73	79	-	72	76	83	-	74	79	86	-
		MBh	27.2	28.2	30.9	-	26.6	27.5	30.2	-	25.9	26.9	29.5	-	25.3	26.2	28.7	-	24.0	24.9	27.3	-	22.3	23.1	25.3	-
		S/T	0.73	0.61	0.43	-	0.76	0.64	0.44	-	0.78	0.65	0.45	-	0.81	0.67	0.47	-	0.84	0.70	0.48	-	0.84	0.70	0.49	-
		Delta T	17	15	11	-	18	15	12	-	18	15	12	-	18	15	12	-	17	15	11	-	16	14	11	-
70	1060	KW	1.94	1.98	2.04	-	2.08	2.12	2.18	-	2.20	2.24	2.31	-	2.31	2.35	2.42	-	2.40	2.44	2.52	-	2.47	2.52	2.60	-
		AMPS	6.5	6.7	6.9	-	7.0	7.2	7.4	-	7.6	7.8	8.1	-	8.2	8.4	8.6	-	8.7	8.9	9.2	-	9.2	9.4	9.7	-
		HIPR	136	147	155	-	153	165	174	-	174	187	198	-	198	213	225	-	223	240	254	-	247	265	280	-
		LOPR	61	65	71	-	64	69	75	-	67	71	78	-	70	75	82	-	74	78	86	-	76	81	89	-
		MBh	27.5	28.5	31.2	-	26.8	27.8	30.5	-	26.2	27.2	29.8	-	25.6	26.5	29.0	-	24.3	25.2	27.6	-	22.5	23.3	25.5	-
		S/T	0.75	0.63	0.43	-	0.78	0.65	0.45	-	0.80	0.67	0.46	-	0.82	0.69	0.48	-	0.85	0.71	0.49	-	0.86	0.72	0.50	-
		Delta T	17	15	11	-	17	15	11	-	17	15	11	-	17	15	11	-	17	15	11	-	16	14	10	-
		KW	1.95	1.99	2.04	-	2.08	2.13	2.19	-	2.20	2.25	2.32	-	2.31	2.36	2.43	-	2.40	2.45	2.53	-	2.48	2.53	2.61	-
		AMPS	6.5	6.7	6.9	-	7.1	7.2	7.5	-	7.7	7.8	8.1	-	8.2	8.4	8.7	-	8.7	8.9	9.2	-	9.2	9.5	9.8	-
		HIPR	137	147	156	-	154	165	175	-	175	188	198	-	199	214	226	-	224	241	254	-	247	266	281	-
LOPR	61	65	71	-	65	69	75	-	67	71	78	-	71	75	82	-	74	79	86	-	77	81	89	-		

75	875	MBh	25.5	26.3	28.5	30.5	24.9	25.7	27.8	29.8	24.4	25.1	27.1	29.1	23.8	24.5	26.5	28.4	22.6	23.2	25.2	27.0	20.9	21.5	23.3	25.0
		S/T	0.81	0.72	0.55	0.35	0.83	0.75	0.56	0.36	0.86	0.77	0.58	0.37	0.88	0.79	0.60	0.38	0.92	0.82	0.62	0.40	0.92	0.83	0.63	0.40
		Delta T	22	20	16	11	22	20	17	11	22	20	17	11	22	20	17	11	22	20	16	11	20	19	15	11
		KW	1.92	1.95	2.01	2.07	2.05	2.09	2.15	2.21	2.17	2.21	2.28	2.34	2.27	2.32	2.39	2.46	2.36	2.41	2.48	2.56	2.43	2.48	2.56	2.64
		AMPS	6.4	6.5	6.8	7.0	6.9	7.1	7.3	7.6	7.5	7.7	7.9	8.2	8.0	8.2	8.5	8.8	8.5	8.7	9.0	9.4	9.0	9.2	9.6	9.9
		HIPR	134	144	152	158	150	161	171	178	171	184	194	202	194	209	221	230	219	235	248	259	242	260	275	286
		LOPR	60	64	69	74	63	67	73	78	66	70	76	81	69	73	80	85	72	77	84	89	75	80	87	92
		MBh	27.7	28.5	30.8	33.1	27.0	27.8	30.1	32.3	26.4	27.2	29.4	31.6	25.7	26.5	28.7	30.8	24.5	25.2	27.3	29.2	22.7	23.3	25.2	27.1
		S/T	0.84	0.75	0.57	0.36	0.87	0.77	0.59	0.38	0.89	0.79	0.60	0.39	0.92	0.82	0.62	0.40	0.95	0.85	0.64	0.41	0.96	0.86	0.65	0.42
		Delta T	20	18	15	10	20	19	15	11	20	19	15	11	20	19	15	11	20	19	15	11	19	17	14	10
75	1060	KW	1.96	2.00	2.05	2.11	2.10	2.14	2.20	2.27	2.22	2.26	2.33	2.40	2.32	2.37	2.44	2.52	2.41	2.46	2.54	2.62	2.49	2.54	2.62	2.71
		AMPS	6.6	6.7	6.9	7.2	7.1	7.3	7.5	7.8	7.7	7.9	8.2	8.5	8.2	8.4	8.7	9.0	8.8	9.0	9.3	9.6	9.3	9.5	9.8	10.2
		HIPR	138	148	157	163	155	166	176	183	176	189	200	209	200	216	228	237	225	243	256	267	249	268	283	295
		LOPR	62	66	72	76	65	69	76	81	68	72	79	84	71	76	83	88	75	79	87	92	77	82	90	95
		MBh	27.9	28.8	31.1	33.4	27.3	28.1	30.4	32.7	26.6	27.4	29.7	31.9	26.0	26.8	29.0	31.1	24.7	25.4	27.5	29.5	22.9	23.6	25.5	27.4
		S/T	0.85	0.76	0.58	0.37	0.88	0.79	0.60	0.38	0.91	0.81	0.61	0.39	0.93	0.84	0.63	0.41	0.97	0.87	0.66	0.42	0.98	0.87	0.66	0.43
		Delta T	19	18	15	10	20	18	15	10	20	18	15	10	20	18	15	10	20	18	15	10	18	17	14	10
		KW	1.96	2.00	2.06	2.12	2.10	2.14	2.20	2.27	2.22	2.27	2.33	2.41	2.33	2.38	2.45	2.52	2.42	2.47	2.55	2.63	2.50	2.55	2.63	2.71
		AMPS	6.6	6.7	7.0	7.2	7.1	7.3	7.5	7.8	7.7	7.9	8.2	8.5	8.3	8.5	8.7	9.1	8.8	9.0	9.3	9.7	9.3	9.5	9.9	10.2
		HIPR	138	149	157	164	155	167	176	184	176	190	201	209	201	216	228	238	226	243	257	268	250	269	284	296
LOPR	62	66	72	76	65	69	76	81	68	72	79	84	71	76	83	88	75	79	87	92	77	82	90	96		

* Entering Indoor Dry Bulb Temperature

NOTE: Shaded area is AOCA (TVA) conditions

COOLING PERFORMANCE DATA

GSC130301D*

EXPANDED PERFORMANCE DATA

COOLING OPERATION

MODEL: GSC130301 / CA*F3030*6C*

IDB*	Airflow	Outdoor Ambient Temperature																								
		65				75				85				95				105				115				
		59	63	67	71	59	63	67	71	59	63	67	71	59	63	67	71	59	63	67	71	59	63	67	71	
80	875	MBh	26.0	26.6	28.4	30.3	25.4	25.9	27.7	29.6	24.8	25.3	27.1	28.9	24.2	24.7	26.4	28.2	23.0	23.5	25.1	26.8	21.3	21.7	23.2	24.8
		S/T	0.88	0.83	0.67	0.50	0.92	0.86	0.70	0.52	0.94	0.88	0.72	0.54	0.97	0.91	0.74	0.55	1.01	0.94	0.77	0.57	1.01	0.95	0.77	0.58
		Delta T	24	23	20	16	24	23	20	16	24	23	20	16	25	24	21	16	24	23	20	16	23	22	19	15
		KW	1.93	1.97	2.02	2.08	2.06	2.10	2.17	2.23	2.18	2.23	2.29	2.36	2.29	2.33	2.40	2.48	2.38	2.43	2.50	2.58	2.45	2.50	2.58	2.66
		AMPS	6.5	6.6	6.8	7.1	7.0	7.1	7.4	7.6	7.6	7.8	8.0	8.3	8.1	8.3	8.6	8.9	8.6	8.8	9.1	9.5	9.1	9.3	9.6	10.0
	1060	LO PR	135	145	153	160	152	163	172	180	172	186	196	204	196	211	223	233	221	238	251	262	244	263	277	289
		MBh	28.2	28.8	30.7	32.9	27.5	28.1	30.0	32.1	26.9	27.4	29.3	31.3	26.2	26.8	28.6	30.6	24.9	25.4	27.2	29.0	23.1	23.6	25.2	26.9
		S/T	0.92	0.86	0.70	0.52	0.95	0.89	0.72	0.54	0.97	0.91	0.74	0.56	1.00	0.94	0.77	0.57	1.00	0.98	0.80	0.60	1.00	0.99	0.80	0.60
		Delta T	22	21	19	15	23	22	19	15	23	22	19	15	23	22	19	15	22	22	19	15	20	20	18	14
		KW	1.97	2.01	2.07	2.13	2.11	2.15	2.22	2.28	2.23	2.28	2.35	2.42	2.34	2.39	2.46	2.54	2.43	2.48	2.56	2.64	2.51	2.56	2.64	2.73
1125	AMPS	6.6	6.8	7.0	7.3	7.2	7.3	7.6	7.9	7.8	8.0	8.2	8.5	8.3	8.5	8.8	9.1	8.8	9.1	9.4	9.7	9.4	9.6	9.9	10.3	
	HIPR	139	150	158	165	156	168	178	185	178	191	202	211	202	218	230	240	228	245	259	270	252	271	286	298	
	LO PR	62	66	72	77	66	70	76	81	68	73	79	85	72	76	83	89	75	80	87	93	78	83	90	96	
	MBh	28.4	29.1	31.1	33.2	27.8	28.4	30.3	32.4	27.1	27.7	29.6	31.7	26.5	27.0	28.9	30.9	25.1	25.7	27.4	29.3	23.3	23.8	25.4	27.2	
	S/T	0.93	0.88	0.71	0.53	0.97	0.91	0.74	0.55	1.00	0.93	0.76	0.57	1.00	0.96	0.78	0.58	1.00	1.00	0.81	0.61	1.00	1.00	0.82	0.61	

85	875	MBh	26.4	27.0	28.2	30.1	25.8	26.3	27.6	29.4	25.2	25.7	26.9	28.7	24.6	25.1	26.3	28.0	23.4	23.8	25.0	26.6	21.7	22.1	23.1	24.7
		S/T	0.93	0.89	0.81	0.65	0.96	0.93	0.84	0.68	0.98	0.95	0.86	0.70	1.00	0.98	0.88	0.72	1.00	1.00	0.92	0.74	1.00	1.00	0.93	0.75
		Delta T	26	25	24	21	26	26	24	21	26	26	24	21	26	26	24	21	25	25	24	21	23	23	22	19
		KW	1.94	1.98	2.04	2.10	2.08	2.12	2.18	2.25	2.20	2.24	2.31	2.38	2.30	2.35	2.42	2.50	2.39	2.44	2.52	2.60	2.47	2.52	2.60	2.68
		AMPS	6.5	6.7	6.9	7.1	7.0	7.2	7.4	7.7	7.6	7.8	8.1	8.4	8.2	8.4	8.6	9.0	8.7	8.9	9.2	9.5	9.2	9.4	9.7	10.1
	1060	HIPR	136	147	155	162	153	165	174	181	174	187	198	206	198	213	225	235	223	240	253	264	246	265	280	292
		LO PR	61	65	71	75	64	69	75	80	67	71	78	83	70	75	82	87	74	78	86	91	76	81	89	94
		MBh	28.7	29.2	30.6	32.6	28.0	28.5	29.9	31.9	27.3	27.9	29.2	31.1	26.7	27.2	28.5	30.4	25.3	25.8	27.0	28.8	23.5	23.9	25.0	26.7
		S/T	0.96	0.93	0.84	0.68	1.00	0.96	0.87	0.70	1.00	0.98	0.89	0.72	1.00	1.00	0.92	0.74	1.00	1.00	0.95	0.77	1.00	1.00	0.96	0.78
		Delta T	24	23	22	19	24	24	22	19	24	24	22	19	23	24	23	20	22	22	22	19	20	21	21	18
1125	KW	1.99	2.03	2.08	2.15	2.13	2.17	2.23	2.30	2.25	2.30	2.36	2.44	2.36	2.41	2.48	2.56	2.45	2.50	2.58	2.66	2.53	2.58	2.67	2.75	
	AMPS	6.7	6.8	7.1	7.3	7.2	7.4	7.6	7.9	7.9	8.0	8.3	8.6	8.4	8.6	8.9	9.2	8.9	9.1	9.5	9.8	9.5	9.7	10.0	10.4	
	HIPR	141	151	160	167	158	170	179	187	179	193	204	213	204	220	232	242	230	247	261	273	254	273	289	301	
	LO PR	63	67	73	78	66	71	77	82	69	73	80	85	73	77	84	90	76	81	88	94	79	84	91	97	
	MBh	28.9	29.5	30.9	33.0	28.3	28.8	30.2	32.2	27.6	28.1	29.5	31.4	26.9	27.4	28.7	30.7	25.6	26.1	27.3	29.1	23.7	24.1	25.3	27.0	

* Entering Indoor Dry Bulb Temperature

NOTE: Shaded area is AHR1 Rating Conditions

COOLING PERFORMANCE DATA

GSC130361D*

EXPANDED PERFORMANCE DATA

COOLING OPERATION

MODEL: GSC130361D* / CAUF3636B6A

IDB*	Airflow	Outdoor Ambient Temperature												Entering Indoor Wet Bulb Temperature												
		65				75				85				95				105				115				
		59	63	67	71	59	63	67	71	59	63	67	71	59	63	67	71	59	63	67	71	59	63	67	71	
70	1350	MBh	34.3	35.5	38.9	-	32.7	33.9	37.1	-	31.9	33.1	36.2	-	30.3	31.4	34.4	-	28.1	29.1	31.9	-	28.1	29.1	31.9	-
		S/T	0.72	0.60	0.42	-	0.75	0.63	0.43	-	0.77	0.64	0.46	-	0.79	0.66	0.48	-	0.82	0.69	0.48	-	0.83	0.69	0.48	-
		Delta T	17	15	11	-	17	15	11	-	17	15	11	-	17	15	11	-	17	15	11	-	16	14	10	-
		KW	2.40	2.44	2.52	-	2.57	2.62	2.70	-	2.72	2.78	2.86	-	2.85	2.91	3.00	-	2.97	3.03	3.13	-	3.07	3.13	3.23	-
		AMPS	8.6	8.8	9.1	-	9.3	9.5	9.9	-	10.1	10.4	10.7	-	10.8	11.1	11.5	-	11.5	11.8	12.2	-	12.2	12.5	13.0	-
	1200	HI PR	142	153	161	-	159	171	181	-	181	195	206	-	206	222	234	-	232	250	264	-	256	276	291	-
		LO PR	62	66	72	-	66	70	76	-	68	73	79	-	72	76	83	-	75	80	87	-	78	83	90	-
		MBh	33.3	34.5	37.8	-	32.5	33.7	36.9	-	31.7	32.9	36.1	-	31.0	32.1	35.2	-	29.4	30.5	33.4	-	27.3	28.3	31.0	-
		S/T	0.69	0.58	0.40	-	0.71	0.60	0.41	-	0.73	0.61	0.42	-	0.76	0.63	0.44	-	0.79	0.66	0.45	-	0.79	0.66	0.46	-
		Delta T	18	15	12	-	18	15	12	-	18	15	12	-	18	16	12	-	18	15	12	-	17	14	11	-
1050	KW	2.38	2.43	2.50	-	2.55	2.60	2.68	-	2.70	2.76	2.84	-	2.83	2.89	2.98	-	2.95	3.01	3.10	-	3.04	3.11	3.21	-	
	AMPS	8.5	8.7	9.0	-	9.2	9.5	9.8	-	10.0	10.3	10.6	-	10.7	11.0	11.4	-	11.4	11.7	12.1	-	12.1	12.4	12.8	-	
	HI PR	141	151	160	-	158	170	179	-	179	193	204	-	204	220	232	-	230	247	261	-	254	273	289	-	
	LO PR	62	66	72	-	65	69	76	-	68	72	79	-	71	76	83	-	75	79	87	-	77	82	90	-	
	MBh	30.7	31.9	34.9	-	30.0	31.1	34.1	-	29.3	30.4	33.3	-	28.6	29.6	32.5	-	27.2	28.2	30.8	-	25.2	26.1	28.6	-	
75	1350	S/T	0.67	0.56	0.38	-	0.69	0.58	0.40	-	0.71	0.59	0.41	-	0.73	0.61	0.42	-	0.76	0.63	0.44	-	0.76	0.63	0.44	-
		Delta T	18	15	12	-	18	16	12	-	18	16	12	-	18	16	12	-	18	16	12	-	17	15	11	-
		KW	2.33	2.37	2.44	-	2.49	2.54	2.62	-	2.64	2.69	2.77	-	2.77	2.82	2.91	-	2.88	2.94	3.03	-	2.97	3.03	3.13	-
		AMPS	8.3	8.5	8.8	-	9.0	9.2	9.5	-	9.8	10.0	10.3	-	10.4	10.7	11.0	-	11.1	11.4	11.8	-	11.8	12.1	12.5	-
		HI PR	136	147	155	-	153	165	174	-	174	187	198	-	198	213	225	-	223	240	253	-	246	265	280	-
	1200	LO PR	60	64	69	-	63	67	73	-	66	70	76	-	69	73	80	-	72	77	84	-	75	80	87	-
		MBh	34.9	35.9	38.9	41.7	34.1	35.1	38.0	40.7	33.3	34.2	37.1	39.8	32.4	33.4	36.2	38.8	30.8	31.7	34.4	36.9	28.6	29.4	31.8	34.2
		S/T	0.82	0.74	0.56	0.36	0.85	0.76	0.58	0.37	0.87	0.78	0.59	0.38	0.90	0.81	0.61	0.39	0.94	0.84	0.63	0.41	0.94	0.84	0.64	0.41
		Delta T	20	18	15	10	20	18	15	10	20	18	15	10	20	18	15	10	20	18	15	10	18	17	14	10
		KW	2.41	2.46	2.54	2.61	2.59	2.64	2.72	2.80	2.74	2.80	2.88	2.98	2.88	2.94	3.03	3.13	2.99	3.06	3.15	3.25	3.09	3.16	3.26	3.36
1050	AMPS	8.7	8.9	9.2	9.5	9.4	9.6	9.9	10.3	10.2	10.5	10.8	11.2	10.9	11.2	11.6	12.0	11.6	11.9	12.3	12.8	12.3	12.6	13.1	13.6	
	HI PR	143	154	163	170	161	173	183	191	183	197	208	217	208	224	237	247	234	252	266	278	259	279	294	307	
	LO PR	63	67	73	78	66	71	77	82	69	74	80	85	73	77	84	90	76	81	88	94	79	84	91	97	
	MBh	33.9	34.9	37.7	40.5	33.1	34.1	36.9	39.6	32.3	33.2	36.0	38.6	31.5	32.4	35.1	37.7	29.9	30.8	33.3	35.8	27.7	28.5	30.9	33.2	
	S/T	0.78	0.70	0.53	0.34	0.81	0.73	0.55	0.35	0.83	0.75	0.56	0.36	0.86	0.77	0.58	0.37	0.89	0.80	0.60	0.39	0.90	0.81	0.61	0.39	
70	1350	Delta T	20	19	15	11	21	19	16	11	21	19	16	11	21	19	16	11	20	19	15	11	19	18	14	10
		KW	2.40	2.44	2.52	2.59	2.57	2.62	2.70	2.78	2.72	2.78	2.86	2.95	2.85	2.91	3.01	3.10	2.97	3.03	3.13	3.23	3.07	3.13	3.23	3.34
		AMPS	8.6	8.8	9.1	9.4	9.3	9.5	9.9	10.2	10.1	10.4	10.7	11.1	10.8	11.1	11.5	11.9	11.5	11.8	12.2	12.7	12.2	12.5	13.0	13.5
		HI PR	142	153	161	168	159	171	181	189	181	195	206	215	206	222	235	245	232	250	264	275	257	276	292	304
		LO PR	62	66	72	77	66	70	76	81	68	73	79	85	72	76	83	89	75	80	87	93	78	83	90	96
	1200	MBh	31.3	32.2	34.8	37.4	30.5	31.4	34.0	36.5	29.8	30.7	33.2	35.6	29.1	29.9	32.4	34.8	27.6	28.4	30.8	33.0	25.6	26.3	28.5	30.6
		S/T	0.76	0.68	0.51	0.33	0.78	0.70	0.53	0.34	0.80	0.72	0.54	0.35	0.83	0.74	0.56	0.36	0.86	0.77	0.58	0.37	0.87	0.78	0.59	0.38
		Delta T	21	19	16	11	21	19	16	11	21	19	16	11	21	19	16	11	21	19	16	11	19	18	15	10
		KW	2.34	2.39	2.46	2.53	2.51	2.56	2.64	2.72	2.66	2.71	2.79	2.88	2.79	2.85	2.93	3.03	2.90	2.96	3.05	3.15	2.99	3.06	3.15	3.25
		AMPS	8.4	8.6	8.9	9.2	9.1	9.3	9.6	9.9	9.8	10.1	10.4	10.8	10.5	10.8	11.1	11.6	11.2	11.5	11.9	12.3	11.9	12.2	12.6	13.1
1050	HI PR	138	148	157	163	155	166	176	183	176	189	200	208	200	215	227	237	225	242	256	267	249	268	283	295	
	LO PR	60	64	70	75	64	68	74	79	66	71	77	82	70	74	81	86	73	78	85	90	76	80	88	93	

* Entering Indoor Dry Bulb Temperature

NOTE: Shaded area is ACCA (TVA) conditions

COOLING PERFORMANCE DATA

GSC130361D*

EXPANDED PERFORMANCE DATA

COOLING OPERATION

MODEL: GSC130361D* / CAUF3636B6A

IDB*	Airflow	Outdoor Ambient Temperature																								
		65				75				85				95				105				115				
		59	63	67	71	59	63	67	71	59	63	67	71	59	63	67	71	59	63	67	71	59	63	67	71	
80	1350	MBh	35.5	36.3	38.8	41.4	34.7	35.4	37.9	40.5	33.8	34.6	37.0	39.5	33.0	33.7	36.1	38.5	31.4	32.1	34.2	36.6	29.1	29.7	31.7	33.9
		S/T	0.90	0.85	0.69	0.51	0.93	0.88	0.71	0.53	0.96	0.90	0.73	0.55	1.00	0.93	0.76	0.56	1.00	0.96	0.78	0.59	1.00	1.00	0.79	0.59
		Delta T	22	21	18	15	22	21	18	15	22	21	19	15	22	21	19	15	21	21	18	15	20	20	17	14
		KW	2.43	2.48	2.55	2.63	2.61	2.66	2.74	2.83	2.76	2.82	2.91	3.00	2.90	2.96	3.05	3.15	3.02	3.08	3.18	3.28	3.12	3.18	3.28	3.39
		AMPS	8.8	9.0	9.3	9.6	9.5	9.7	10.0	10.4	10.3	10.6	10.9	11.3	11.0	11.3	11.7	12.1	11.7	12.0	12.4	12.9	12.5	12.8	13.2	13.7
	1200	HI PR	145	156	165	172	163	175	185	193	185	199	210	219	211	227	239	250	237	255	269	281	262	282	297	310
		LO PR	64	68	74	79	67	71	78	83	70	74	81	86	73	78	85	91	77	82	89	95	79	85	92	98
		MBh	34.5	35.2	37.6	40.2	33.7	34.4	36.8	39.3	32.9	33.6	35.9	38.4	32.1	32.8	35.0	37.4	30.5	31.1	33.3	35.5	28.2	28.8	30.8	32.9
		S/T	0.86	0.81	0.66	0.49	0.89	0.84	0.68	0.51	0.91	0.86	0.70	0.52	0.94	0.88	0.72	0.54	0.98	0.92	0.75	0.56	0.99	0.93	0.75	0.56
		Delta T	23	22	19	15	23	22	19	15	23	22	19	15	23	22	19	15	23	22	19	15	21	20	18	14
1050	1350	KW	2.41	2.46	2.54	2.61	2.59	2.64	2.72	2.80	2.74	2.80	2.88	2.98	2.88	2.94	3.03	3.13	2.99	3.06	3.15	3.25	3.09	3.16	3.26	3.36
		AMPS	8.7	8.9	9.2	9.5	9.4	9.6	9.9	10.3	10.2	10.5	10.8	11.2	10.9	11.2	11.6	12.0	11.6	11.9	12.3	12.8	12.3	12.6	13.1	13.6
		HI PR	143	154	163	170	161	173	183	191	183	197	208	217	208	224	237	247	235	252	267	278	259	279	294	307
		LO PR	63	67	73	78	66	71	77	82	69	74	80	85	73	77	84	90	76	81	88	94	79	84	91	97
		MBh	31.8	32.5	34.7	37.1	31.1	31.7	33.9	36.3	30.3	31.0	33.1	35.4	29.6	30.2	32.3	34.5	28.1	28.7	30.7	32.8	26.0	26.6	28.4	30.4
	1200	S/T	0.83	0.78	0.63	0.47	0.86	0.81	0.66	0.49	0.88	0.83	0.67	0.50	0.91	0.85	0.69	0.52	0.94	0.89	0.72	0.54	0.95	0.89	0.73	0.54
		Delta T	23	22	19	15	23	22	19	16	23	22	20	16	24	23	20	16	23	22	19	15	22	21	18	14
		KW	2.36	2.41	2.48	2.55	2.53	2.58	2.66	2.74	2.68	2.73	2.82	2.90	2.81	2.87	2.96	3.05	2.92	2.98	3.08	3.17	3.02	3.08	3.18	3.28
		AMPS	8.5	8.7	8.9	9.3	9.1	9.4	9.7	10.0	9.9	10.2	10.5	10.9	10.6	10.9	11.3	11.7	11.3	11.6	12.0	12.4	12.0	12.3	12.7	13.2
		HI PR	139	150	158	165	156	168	177	185	178	191	202	210	202	218	230	240	227	245	259	270	251	270	286	298
85	1350	LO PR	61	65	71	76	64	69	75	80	67	71	78	83	70	75	82	87	74	78	86	91	76	81	89	94
		MBh	36.1	36.8	38.6	41.1	35.3	36.0	37.7	40.2	34.4	35.1	36.8	39.2	33.6	34.2	35.9	38.3	31.9	32.5	34.1	36.4	29.6	30.1	31.6	33.7
		S/T	0.95	0.91	0.82	0.67	0.98	0.95	0.85	0.69	1.00	0.97	0.87	0.71	1.00	1.00	0.90	0.73	1.00	1.00	0.94	0.76	1.00	1.00	0.95	0.77
		Delta T	23	23	22	19	24	23	22	19	23	23	22	19	23	23	22	19	22	22	22	19	20	21	20	18
		KW	2.45	2.50	2.57	2.65	2.63	2.68	2.76	2.85	2.78	2.84	2.93	3.02	2.92	2.98	3.08	3.18	3.04	3.10	3.20	3.31	3.14	3.21	3.31	3.42
	1200	AMPS	8.8	9.1	9.4	9.7	9.6	9.8	10.1	10.5	10.4	10.7	11.0	11.4	11.1	11.4	11.8	12.2	11.9	12.2	12.6	13.0	12.6	12.9	13.3	13.8
		HI PR	146	157	166	173	164	177	187	195	187	201	212	221	213	229	242	252	239	257	272	284	264	284	300	313
		LO PR	64	68	75	79	68	72	79	84	70	75	82	87	74	79	86	92	78	83	90	96	80	85	93	99
		MBh	35.1	35.7	37.4	39.9	34.3	34.9	36.6	39.0	33.4	34.1	35.7	38.1	32.6	33.3	34.8	37.2	31.0	31.6	33.1	35.3	28.7	29.3	30.6	32.7
		S/T	0.90	0.87	0.79	0.64	0.93	0.90	0.81	0.66	0.96	0.92	0.83	0.68	0.99	0.95	0.86	0.70	1.00	0.99	0.89	0.73	1.00	1.00	0.90	0.73
1050	1350	Delta T	24	24	23	19	25	24	23	20	25	24	23	20	25	24	23	20	24	24	23	20	22	22	21	18
		KW	2.43	2.48	2.55	2.63	2.61	2.66	2.74	2.83	2.76	2.82	2.91	3.00	2.90	2.96	3.05	3.15	3.02	3.08	3.18	3.28	3.12	3.18	3.28	3.39
		AMPS	8.8	9.0	9.3	9.6	9.5	9.7	10.0	10.4	10.3	10.6	10.9	11.3	11.0	11.3	11.7	12.1	11.7	12.0	12.4	12.9	12.5	12.8	13.2	13.7
		HI PR	145	156	165	172	163	175	185	193	185	199	210	219	211	227	239	250	237	255	269	281	262	282	297	310
		LO PR	64	68	74	79	67	71	78	83	70	74	81	86	73	78	85	91	77	82	89	95	79	85	92	98
	1200	MBh	32.4	33.0	34.6	36.9	31.6	32.2	33.8	36.0	30.9	31.5	32.9	35.1	30.1	30.7	32.1	34.3	28.6	29.2	30.5	32.6	26.5	27.0	28.3	30.2
		S/T	0.87	0.84	0.76	0.61	0.90	0.87	0.78	0.64	0.92	0.89	0.80	0.65	0.95	0.92	0.83	0.67	0.99	0.96	0.86	0.70	1.00	0.96	0.87	0.71
		Delta T	25	24	23	20	25	25	23	20	25	25	23	20	25	25	23	20	25	24	23	20	23	23	22	19
		KW	2.38	2.43	2.50	2.57	2.55	2.60	2.68	2.76	2.70	2.75	2.84	2.93	2.83	2.89	2.98	3.07	2.83	2.89	3.01	3.10	3.04	3.11	3.20	3.31
		AMPS	8.5	8.7	9.0	9.4	9.2	9.4	9.8	10.1	10.0	10.3	10.6	11.0	10.7	11.0	11.4	11.8	11.4	11.7	12.1	12.6	12.1	12.4	12.8	13.3
1050	HI PR	141	151	160	167	158	170	179	187	179	193	204	213	204	220	232	242	230	247	261	272	254	273	288	301	
	LO PR	62	66	72	76	65	69	76	81	68	72	79	84	71	76	83	88	75	79	87	92	77	82	90	95	

NOTE: Shaded area is AHRI Rating Conditions

* Entering Indoor Dry Bulb Temperature

COOLING PERFORMANCE DATA

GSC130361F*

EXPANDED PERFORMANCE DATA

EXPANDED PERFORMANCE DATA

MODEL: GSC130361/CA*F3636*6C*

IDB*	Airflow	Outdoor Ambient Temperature																								
		65				75				85				95				105				115				
		59	63	67	71	59	63	67	71	59	63	67	71	59	63	67	71	59	63	67	71	59	63	67	71	
70	1100	MBh	32.6	33.8	37.0	-	31.9	33.0	36.2	-	31.1	32.2	35.3	-	30.3	31.4	34.4	-	28.8	29.9	32.7	-	26.7	27.7	30.3	-
		ST	0.69	0.58	0.40	-	0.72	0.60	0.42	-	0.74	0.61	0.43	-	0.76	0.63	0.44	-	0.79	0.66	0.46	-	0.80	0.66	0.46	-
		Delta T	19	16	12	-	19	17	13	-	19	17	13	-	19	17	13	-	19	16	12	-	18	15	12	-
		KW	2.34	2.38	2.45	-	2.49	2.54	2.61	-	2.62	2.67	2.75	-	2.74	2.79	2.87	-	2.84	2.89	2.98	-	2.93	2.98	3.07	-
		AMPS	9.6	9.7	9.8	-	9.9	10.0	10.2	-	10.3	10.4	10.6	-	10.7	10.8	11.0	-	11.0	11.2	11.4	-	11.4	11.5	11.7	-
	1200	HI PR	140	151	159	-	157	169	179	-	179	193	203	-	204	219	232	-	229	247	261	-	253	273	288	-
		LO PR	60	63	69	-	63	67	73	-	65	70	76	-	69	73	80	-	72	77	84	-	75	79	87	-
		MBh	33.1	34.3	37.6	-	32.3	33.5	36.7	-	31.6	32.7	35.8	-	30.8	31.9	35.0	-	29.3	30.3	33.2	-	27.1	28.1	30.8	-
		ST	0.72	0.60	0.42	-	0.74	0.62	0.43	-	0.76	0.64	0.44	-	0.79	0.66	0.46	-	0.82	0.68	0.47	-	0.82	0.69	0.48	-
		Delta T	18	16	12	-	18	16	12	-	18	16	12	-	19	16	12	-	18	16	12	-	17	15	11	-
1300	KW	2.37	2.41	2.47	-	2.52	2.57	2.64	-	2.66	2.70	2.78	-	2.77	2.83	2.91	-	2.87	2.93	3.01	-	2.96	3.02	3.11	-	
	AMPS	9.6	9.7	9.9	-	10.0	10.1	10.3	-	10.4	10.5	10.7	-	10.8	10.9	11.1	-	11.1	11.3	11.5	-	11.5	11.6	11.9	-	
	HI PR	143	153	162	-	160	172	182	-	182	196	207	-	207	223	236	-	233	251	265	-	258	277	293	-	
	LO PR	61	65	70	-	64	68	74	-	67	71	77	-	70	74	81	-	73	78	85	-	76	81	88	-	
	MBh	33.4	34.7	38.0	-	32.7	33.9	37.1	-	31.9	33.0	36.2	-	31.1	32.2	35.3	-	29.6	30.6	33.6	-	27.4	28.4	31.1	-	

IDB*	Airflow	Outdoor Ambient Temperature																								
		65				75				85				95				105				115				
		59	63	67	71	59	63	67	71	59	63	67	71	59	63	67	71	59	63	67	71	59	63	67	71	
75	1100	MBh	33.2	34.1	37.0	39.7	32.4	33.4	36.1	38.7	31.6	32.6	35.2	37.8	30.9	31.8	34.4	36.9	29.3	30.2	32.7	35.1	27.1	28.0	30.3	32.5
		ST	0.79	0.70	0.53	0.34	0.82	0.73	0.55	0.36	0.84	0.75	0.57	0.36	0.86	0.77	0.58	0.38	0.90	0.80	0.61	0.39	0.90	0.81	0.61	0.39
		Delta T	22	20	16	11	22	20	17	12	22	20	17	12	22	21	17	12	22	20	17	11	21	19	15	11
		KW	2.36	2.40	2.46	2.53	2.51	2.55	2.62	2.70	2.64	2.69	2.77	2.85	2.76	2.81	2.89	2.98	2.86	2.92	3.00	3.09	2.95	3.00	3.09	3.18
		AMPS	9.6	9.7	9.8	10.0	9.9	10.1	10.2	10.4	10.4	10.5	10.7	10.9	10.7	10.9	11.0	11.3	11.1	11.2	11.4	11.7	11.4	11.6	11.8	12.1
	1200	HI PR	142	152	161	168	159	171	181	188	181	195	205	214	206	222	234	244	232	249	263	275	256	275	291	303
		LO PR	60	64	70	74	64	68	74	79	66	70	77	82	69	74	81	86	73	77	85	90	75	80	87	93
		MBh	33.7	34.7	37.5	40.3	32.9	33.9	36.6	39.3	32.1	33.1	35.8	38.4	31.3	32.2	34.9	37.5	29.8	30.6	33.2	35.6	27.6	28.4	30.7	33.0
		ST	0.82	0.73	0.55	0.36	0.85	0.76	0.57	0.37	0.87	0.78	0.59	0.38	0.90	0.80	0.61	0.39	0.93	0.83	0.63	0.40	0.94	0.84	0.63	0.41
		Delta T	21	19	16	11	21	20	16	11	21	20	16	11	21	20	16	11	21	20	16	11	20	18	15	10
1300	KW	2.38	2.43	2.49	2.56	2.54	2.59	2.66	2.73	2.67	2.72	2.80	2.88	2.79	2.85	2.93	3.01	2.90	2.95	3.04	3.13	2.98	3.04	3.13	3.22	
	AMPS	9.7	9.8	9.9	10.1	10.0	10.1	10.3	10.5	10.4	10.6	10.8	11.0	10.8	10.9	11.1	11.4	11.2	11.3	11.5	11.8	11.5	11.7	11.9	12.2	
	HI PR	144	155	164	171	162	174	184	192	184	198	209	218	209	225	238	248	236	254	268	279	260	280	296	309	
	LO PR	61	65	71	76	65	69	75	80	67	72	78	83	71	75	82	87	74	79	86	92	77	81	89	95	
	MBh	34.0	35.0	37.9	40.7	33.2	34.2	37.0	39.7	32.4	33.4	36.1	38.8	31.6	32.6	35.3	37.8	30.1	30.9	33.5	35.9	27.8	28.7	31.0	33.3	

* Entering Indoor Dry Bulb Temperature

NOTE: Shaded area is ACCA (TVA) conditions

COOLING PERFORMANCE DATA

GSC130361F*

EXPANDED PERFORMANCE DATA

EXPANDED PERFORMANCE DATA

MODEL: GSC130361/CA*F3636*6C*

IDB*	Airflow	Outdoor Ambient Temperature																								
		65				75				85				95				105				115				
		59	63	67	71	59	63	67	71	59	63	67	71	59	63	67	71	59	63	67	71	59	63	67	71	
80	1100	MBh	33.8	34.5	36.8	39.4	33.0	33.7	36.0	38.5	32.2	32.9	35.1	37.6	31.4	32.1	34.3	36.6	29.8	30.5	32.6	34.8	27.6	28.2	30.2	32.2
		ST	0.86	0.81	0.66	0.49	0.90	0.84	0.68	0.51	0.92	0.86	0.70	0.52	0.95	0.89	0.72	0.54	0.98	0.92	0.75	0.56	0.99	0.93	0.76	0.57
		Delta T	24	23	20	16	25	24	21	16	25	24	21	16	25	24	21	17	25	23	20	16	23	22	19	15
		KW	2.37	2.42	2.48	2.55	2.53	2.57	2.64	2.72	2.66	2.71	2.79	2.87	2.78	2.83	2.91	3.00	2.88	2.94	3.02	3.11	2.97	3.03	3.11	3.21
		AMPS	9.6	9.7	9.9	10.1	10.0	10.1	10.3	10.5	10.4	10.5	10.7	10.9	10.8	10.9	11.1	11.3	11.1	11.3	11.5	11.7	11.5	11.7	11.9	12.1
	1200	HI PR	143	154	163	170	161	173	182	190	183	196	207	216	208	224	236	246	234	252	266	277	258	278	294	306
		LO PR	61	65	71	75	64	68	75	79	67	71	78	83	70	75	81	87	74	78	85	91	76	81	88	94
		MBh	34.3	35.0	37.4	40.0	33.5	34.2	36.5	39.1	32.7	33.4	35.7	38.1	31.9	32.6	34.8	37.2	30.3	30.9	33.1	35.3	28.1	28.7	30.6	32.7
		ST	0.90	0.84	0.68	0.51	0.93	0.87	0.71	0.53	0.95	0.89	0.73	0.54	0.98	0.92	0.75	0.56	1.00	0.96	0.78	0.58	1.00	0.96	0.78	0.59
		Delta T	24	23	20	16	24	23	20	16	24	23	20	16	24	23	20	16	23	23	20	16	21	21	18	15
1300	KW	2.40	2.44	2.51	2.58	2.56	2.60	2.67	2.75	2.69	2.74	2.82	2.90	2.81	2.87	2.95	3.04	2.92	2.97	3.06	3.15	3.01	3.06	3.15	3.25	
	AMPS	9.7	9.8	10.0	10.1	10.1	10.2	10.4	10.5	10.5	10.6	10.8	11.0	10.9	11.0	11.2	11.4	11.2	11.4	11.6	11.8	11.6	11.8	12.0	12.2	
	HI PR	146	157	165	173	163	176	186	194	186	200	211	220	212	228	240	251	238	256	270	282	263	283	299	312	
	LO PR	62	66	72	77	65	70	76	81	68	72	79	84	71	76	83	88	75	80	87	93	77	82	90	96	
	MBh	34.6	35.4	37.8	40.4	33.8	34.5	36.9	39.5	33.0	33.7	36.0	38.5	32.2	32.9	35.1	37.6	30.6	31.3	33.4	35.7	28.3	29.0	30.9	33.1	

85	1100	MBh	34.3	35.0	36.7	39.1	33.5	34.2	35.8	38.2	32.7	33.4	35.0	37.3	31.9	32.6	34.1	36.4	30.3	30.9	32.4	34.6	28.1	28.7	30.0	32.0
		ST	0.91	0.87	0.79	0.64	0.94	0.91	0.82	0.66	0.96	0.93	0.84	0.68	0.99	0.96	0.87	0.70	1.00	0.99	0.90	0.73	1.00	1.00	0.91	0.73
		Delta T	26	26	24	21	26	26	24	21	26	26	24	21	27	26	25	21	25	26	24	21	23	24	23	20
		KW	2.39	2.43	2.50	2.56	2.54	2.59	2.66	2.74	2.68	2.73	2.81	2.89	2.80	2.85	2.93	3.02	2.90	2.96	3.04	3.13	2.99	3.05	3.14	3.23
		AMPS	9.7	9.8	9.9	10.1	10.0	10.2	10.3	10.5	10.5	10.6	10.8	11.0	10.8	11.0	11.2	11.4	11.2	11.3	11.5	11.8	11.6	11.7	11.9	12.2
	1200	HI PR	145	156	164	171	162	174	184	192	184	198	210	219	210	226	239	249	236	254	269	280	261	281	297	309
		LO PR	61	65	71	76	65	69	75	80	67	72	78	83	71	75	82	88	74	79	86	92	77	82	89	95
		MBh	34.9	35.5	37.2	39.7	34.1	34.7	36.4	38.8	33.2	33.9	35.5	37.9	32.4	33.1	34.6	36.9	30.8	31.4	32.9	35.1	28.5	29.1	30.5	32.5
		ST	0.94	0.91	0.82	0.66	0.97	0.94	0.85	0.69	1.00	0.96	0.87	0.71	1.00	0.99	0.90	0.73	1.00	1.00	0.93	0.76	1.00	1.00	0.94	0.76
		Delta T	25	25	23	20	25	25	24	20	25	25	24	20	25	25	24	21	24	24	23	20	22	22	22	19
1300	KW	2.42	2.46	2.53	2.59	2.57	2.62	2.69	2.77	2.71	2.76	2.84	2.92	2.83	2.89	2.97	3.06	2.94	3.00	3.08	3.17	3.03	3.09	3.18	3.27	
	AMPS	9.7	9.9	10.0	10.2	10.1	10.2	10.4	10.6	10.5	10.7	10.9	11.1	10.9	11.1	11.3	11.5	11.3	11.4	11.7	11.9	11.7	11.8	12.0	12.3	
	HI PR	147	158	167	174	165	178	187	196	188	202	213	222	214	230	243	253	240	259	273	285	266	286	302	315	
	LO PR	63	66	73	77	66	70	77	82	69	73	80	85	72	77	84	89	76	80	88	93	78	83	91	97	
	MBh	35.2	35.9	37.6	40.1	34.4	35.1	36.7	39.2	33.6	34.2	35.8	38.2	32.8	33.4	35.0	37.3	31.1	31.7	33.2	35.4	28.8	29.4	30.8	32.8	

* Entering Indoor Dry Bulb Temperature

NOTE: Shaded area is AHRI Rating Conditions

COOLING PERFORMANCE DATA

GSC130421A*

EXPANDED PERFORMANCE DATA

COOLING OPERATION

MODEL: GSC130421A* / CPUF3642C6A

IDB*	Airflow	Outdoor Ambient Temperature																													
		65					75					85					95					105					115				
		59	63	67	71	75	59	63	67	71	75	59	63	67	71	75	59	63	67	71	75	59	63	67	71	75	59	63	67	71	75
70	MBh	39.7	41.1	45.1	-	38.8	40.2	44.0	-	37.8	39.2	43.0	-	36.9	38.3	41.9	-	35.1	36.4	39.8	-	35.1	36.4	39.8	-	32.5	33.7	36.9	-		
	ST	0.76	0.63	0.44	-	0.78	0.66	0.45	-	0.80	0.67	0.47	-	0.83	0.69	0.48	-	0.86	0.72	0.50	-	0.86	0.72	0.50	-	0.87	0.73	0.50	-		
	Delta T	17	15	11	-	17	15	11	-	17	15	11	-	17	15	11	-	17	15	11	-	17	15	11	-	16	14	10	-		
	KW	2.74	2.79	2.87	-	2.93	2.98	3.07	-	3.09	3.15	3.24	-	3.24	3.30	3.40	-	3.36	3.43	3.53	-	3.36	3.43	3.53	-	3.46	3.54	3.64	-		
	AMPS	9.6	9.8	10.1	-	10.4	10.6	10.9	-	11.2	11.5	11.9	-	12.0	12.3	12.6	-	12.7	13.0	13.4	-	12.7	13.0	13.4	-	13.4	13.8	14.2	-		
	HI PR	142	153	161	-	159	171	181	-	181	195	206	-	206	222	234	-	232	250	264	-	232	250	264	-	256	276	291	-		
	LO PR	62	66	73	-	66	70	77	-	69	73	80	-	72	77	84	-	75	80	88	-	75	80	88	-	78	83	91	-		
	MBh	38.5	39.9	43.8	-	37.6	39.0	42.7	-	36.7	38.1	41.7	-	35.8	37.1	40.7	-	34.1	35.3	38.7	-	34.1	35.3	38.7	-	31.5	32.7	35.8	-		
	ST	0.72	0.60	0.42	-	0.75	0.62	0.43	-	0.77	0.64	0.44	-	0.79	0.66	0.46	-	0.82	0.69	0.48	-	0.82	0.69	0.48	-	0.83	0.69	0.48	-		
	Delta T	18	15	12	-	18	15	12	-	18	15	12	-	18	16	12	-	18	15	12	-	18	15	12	-	17	14	11	-		
KW	2.72	2.77	2.85	-	2.91	2.96	3.05	-	3.07	3.13	3.22	-	3.21	3.28	3.37	-	3.33	3.40	3.50	-	3.33	3.40	3.50	-	3.44	3.51	3.61	-			
AMPS	9.5	9.7	10.1	-	10.3	10.5	10.8	-	11.1	11.4	11.7	-	11.9	12.1	12.5	-	12.6	12.9	13.3	-	12.6	12.9	13.3	-	13.3	13.6	14.1	-			
HI PR	141	151	160	-	158	170	179	-	179	193	204	-	204	220	232	-	230	247	261	-	230	247	261	-	254	273	288	-			
LO PR	62	66	72	-	65	69	76	-	68	72	79	-	71	76	83	-	75	79	87	-	75	79	87	-	77	82	90	-			
MBh	35.6	36.9	40.4	-	34.7	36.0	39.4	-	33.9	35.1	38.5	-	33.1	34.3	37.6	-	31.4	32.6	35.7	-	31.4	32.6	35.7	-	29.1	30.2	33.1	-			
ST	0.70	0.58	0.40	-	0.72	0.60	0.42	-	0.74	0.62	0.43	-	0.76	0.64	0.44	-	0.79	0.66	0.46	-	0.79	0.66	0.46	-	0.80	0.67	0.46	-			
Delta T	18	16	12	-	18	16	12	-	18	16	12	-	18	16	12	-	18	16	12	-	18	16	12	-	17	15	11	-			
KW	2.67	2.72	2.79	-	2.85	2.90	2.98	-	3.00	3.06	3.15	-	3.14	3.20	3.30	-	3.26	3.32	3.42	-	3.26	3.32	3.42	-	3.36	3.43	3.53	-			
AMPS	9.3	9.5	9.8	-	10.0	10.2	10.6	-	10.8	11.1	11.4	-	11.5	11.8	12.2	-	12.3	12.6	13.0	-	12.3	12.6	13.0	-	13.0	13.3	13.7	-			
HI PR	136	147	155	-	153	165	174	-	174	187	198	-	198	213	225	-	223	240	253	-	223	240	253	-	246	265	280	-			
LO PR	60	64	70	-	63	67	74	-	66	70	76	-	69	74	80	-	72	77	84	-	72	77	84	-	75	80	87	-			

75	MBh	40.4	41.6	45.0	48.3	39.4	40.6	43.9	47.2	38.5	39.6	42.9	46.0	37.5	38.7	41.8	44.9	35.7	36.7	39.7	42.7	33.0	34.0	36.8	39.5
	ST	0.86	0.77	0.58	0.37	0.89	0.80	0.60	0.39	0.91	0.82	0.62	0.40	0.94	0.84	0.64	0.41	0.98	0.88	0.66	0.43	0.99	0.88	0.67	0.43
	Delta T	20	18	15	10	20	18	15	10	20	18	15	10	20	18	15	10	20	18	15	10	18	17	14	10
	KW	2.76	2.81	2.89	2.98	2.95	3.01	3.09	3.18	3.12	3.18	3.27	3.37	3.26	3.33	3.42	3.53	3.38	3.45	3.56	3.67	3.49	3.56	3.67	3.78
	AMPS	9.7	9.9	10.2	10.6	10.4	10.7	11.0	11.4	11.3	11.6	12.0	12.4	12.1	12.4	12.8	13.2	12.8	13.1	13.6	14.1	13.6	13.9	14.4	14.9
	HI PR	143	154	163	170	161	173	183	191	183	197	208	217	208	224	237	247	234	252	266	278	259	279	294	307
	LO PR	63	67	73	78	67	71	77	82	69	74	80	86	73	77	84	90	76	81	89	94	79	84	92	98
	MBh	39.2	40.3	43.7	46.9	38.3	39.4	42.7	45.8	37.4	38.5	41.6	44.7	36.5	37.5	40.6	43.6	34.6	35.7	38.6	41.4	32.1	33.0	35.7	38.4
	ST	0.82	0.73	0.56	0.36	0.85	0.76	0.58	0.37	0.87	0.78	0.59	0.38	0.90	0.81	0.61	0.39	0.93	0.84	0.63	0.41	0.94	0.84	0.64	0.41
	Delta T	20	19	15	11	21	19	16	11	21	19	16	11	21	19	16	11	21	19	15	11	19	18	14	10
KW	2.74	2.79	2.87	2.95	2.93	2.98	3.07	3.16	3.09	3.15	3.24	3.34	3.24	3.30	3.40	3.50	3.36	3.43	3.53	3.64	3.47	3.54	3.64	3.76	
AMPS	9.6	9.8	10.1	10.5	10.4	10.6	10.9	11.3	11.2	11.5	11.9	12.3	12.0	12.3	12.6	13.1	12.7	13.0	13.4	13.9	13.5	13.8	14.2	14.8	
HI PR	142	153	161	168	159	171	181	189	181	195	206	215	206	222	234	245	232	250	264	275	256	276	291	304	
LO PR	62	66	73	77	66	70	77	82	69	73	80	85	72	77	84	89	75	80	88	93	78	83	91	97	
MBh	36.2	37.2	40.3	43.3	35.3	36.4	39.4	42.3	34.5	35.5	38.4	41.2	33.6	34.6	37.5	40.2	32.0	32.9	35.6	38.2	29.6	30.5	33.0	35.4	
ST	0.79	0.71	0.54	0.34	0.82	0.73	0.56	0.36	0.84	0.75	0.57	0.37	0.87	0.78	0.59	0.38	0.90	0.81	0.61	0.39	0.91	0.81	0.62	0.40	
Delta T	21	19	16	11	21	19	16	11	21	19	16	11	21	19	16	11	21	19	16	11	19	18	15	10	
KW	2.69	2.74	2.81	2.89	2.87	2.92	3.00	3.09	3.02	3.08	3.17	3.27	3.16	3.23	3.32	3.42	3.28	3.35	3.45	3.55	3.39	3.45	3.56	3.67	
AMPS	9.4	9.6	9.9	10.2	10.1	10.3	10.6	11.0	10.9	11.2	11.5	12.0	11.6	11.9	12.3	12.8	12.4	12.7	13.1	13.6	13.1	13.4	13.8	14.4	
HI PR	138	148	156	163	154	166	176	183	176	189	200	208	200	215	227	237	225	242	256	267	249	268	283	295	
LO PR	61	64	70	75	64	68	74	79	67	71	77	82	70	74	81	86	73	78	85	91	76	81	88	94	

NOTE: Shaded area is ACCA (TVA) conditions

* Entering Indoor Dry Bulb Temperature

COOLING PERFORMANCE DATA

GSC130421A*

EXPANDED PERFORMANCE DATA

COOLING OPERATION

MODEL: GSC130421A* / CPUF3642C6A

IDB*	Airflow	Outdoor Ambient Temperature																								
		65				75				85				95				105				115				
		59	63	67	71	59	63	67	71	59	63	67	71	59	63	67	71	59	63	67	71	59	63	67	71	
80	1631	MBh	41.1	42.0	44.8	47.9	40.1	41.0	43.8	46.8	39.2	40.0	42.8	45.7	38.2	39.0	41.7	44.6	36.3	37.1	39.6	42.4	33.6	34.4	36.7	39.2
		S/T	0.94	0.89	0.72	0.54	1.00	0.92	0.75	0.56	1.00	0.94	0.77	0.57	1.00	1.00	0.79	0.59	1.00	1.00	0.82	0.61	1.00	1.00	0.83	0.62
		Delta T	22	21	18	15	23	21	18	15	22	21	18	15	22	22	19	15	20	21	18	15	19	19	17	14
		KW	2.78	2.83	2.91	3.00	2.97	3.03	3.12	3.21	3.14	3.20	3.29	3.39	3.29	3.35	3.45	3.56	3.41	3.48	3.58	3.69	3.52	3.59	3.70	3.81
		AMPS	9.8	10.0	10.3	10.7	10.5	10.8	11.1	11.5	11.4	11.7	12.1	12.5	12.2	12.5	12.9	13.4	12.9	13.3	13.7	14.2	13.7	14.0	14.5	15.0
	1450	HIPR	145	156	165	172	162	175	185	193	185	199	210	219	210	227	239	249	237	255	269	281	262	282	297	310
		LOPR	64	68	74	79	67	72	78	83	70	74	81	87	73	78	85	91	77	82	89	95	80	85	93	99
		MBh	39.9	40.8	43.5	46.5	39.0	39.8	42.5	45.5	38.0	38.9	41.5	44.4	37.1	37.9	40.5	43.3	35.2	36.0	38.5	41.1	32.6	33.4	35.6	38.1
		S/T	0.90	0.84	0.69	0.51	0.93	0.87	0.71	0.53	0.96	0.90	0.73	0.55	0.99	0.93	0.75	0.56	1.00	0.96	0.78	0.58	1.00	0.97	0.79	0.59
		Delta T	23	22	19	15	23	22	19	15	23	22	19	15	23	22	19	15	22	22	19	15	21	20	18	14
1269	KW	2.76	2.81	2.89	2.98	2.95	3.01	3.09	3.18	3.12	3.18	3.27	3.37	3.26	3.33	3.42	3.53	3.39	3.45	3.56	3.67	3.49	3.56	3.67	3.78	
	AMPS	9.7	9.9	10.2	10.6	10.4	10.7	11.0	11.4	11.3	11.6	12.0	12.4	12.1	12.4	12.8	13.2	12.8	13.1	13.6	14.1	13.6	13.9	14.4	14.9	
	HIPR	143	154	163	170	161	173	183	191	183	197	208	217	208	224	237	247	234	252	266	278	259	279	294	307	
	LOPR	63	67	73	78	67	71	77	82	69	74	80	86	73	77	84	90	76	81	89	94	79	84	92	98	
	MBh	36.8	37.6	40.2	43.0	36.0	36.7	39.3	42.0	35.1	35.9	38.3	41.0	34.2	35.0	37.4	40.0	32.5	33.2	35.5	38.0	30.1	30.8	32.9	35.2	

85	1631	MBh	41.8	42.6	44.6	47.6	40.8	41.6	43.6	46.5	39.9	40.6	42.5	45.4	38.9	39.6	41.5	44.3	36.9	37.6	39.4	42.1	34.2	34.9	36.5	39.0
		S/T	0.99	0.95	0.86	0.70	1.00	0.99	0.89	0.72	1.00	1.00	0.92	0.74	1.00	1.00	0.95	0.77	1.00	1.00	0.98	0.80	1.00	1.00	0.99	0.80
		Delta T	23	23	22	19	23	23	22	19	22	23	22	19	22	22	22	19	21	21	22	19	19	20	20	18
		KW	2.80	2.85	2.93	3.02	2.99	3.05	3.14	3.23	3.16	3.22	3.32	3.42	3.31	3.38	3.48	3.58	3.44	3.51	3.61	3.72	3.55	3.62	3.73	3.84
		AMPS	9.9	10.1	10.4	10.8	10.6	10.9	11.2	11.6	11.5	11.8	12.2	12.6	12.3	12.6	13.0	13.5	13.1	13.4	13.8	14.3	13.8	14.2	14.6	15.2
	1450	HIPR	146	157	166	173	164	177	186	195	187	201	212	221	213	229	242	252	239	257	272	283	264	284	300	313
		LOPR	64	68	75	80	68	72	79	84	71	75	82	87	74	79	86	92	78	83	90	96	80	86	93	100
		MBh	40.6	41.4	43.3	46.2	39.6	40.4	42.3	45.1	38.7	39.4	41.3	44.1	37.7	38.5	40.3	43.0	35.9	36.6	38.3	40.8	33.2	33.9	35.5	37.8
		S/T	0.94	0.91	0.82	0.67	0.98	0.94	0.85	0.69	1.00	0.97	0.87	0.71	1.00	1.00	0.90	0.73	1.00	1.00	0.94	0.76	1.00	1.00	0.94	0.77
		Delta T	24	24	23	20	25	24	23	20	25	24	23	20	24	24	23	20	23	23	23	20	21	21	21	18
1269	KW	2.78	2.83	2.91	3.00	2.97	3.03	3.12	3.21	3.14	3.20	3.29	3.39	3.29	3.35	3.45	3.56	3.41	3.48	3.58	3.69	3.52	3.59	3.70	3.81	
	AMPS	9.8	10.0	10.3	10.7	10.5	10.8	11.1	11.5	11.4	11.7	12.1	12.5	12.2	12.5	12.9	13.4	12.9	13.3	13.7	14.2	13.7	14.0	14.5	15.0	
	HIPR	145	156	165	172	162	175	185	193	185	199	210	219	210	227	239	249	237	255	269	281	262	282	297	310	
	LOPR	64	68	74	79	67	72	78	83	70	74	81	87	73	78	85	91	77	82	89	95	80	85	93	99	
	MBh	37.5	38.2	40.0	42.7	36.6	37.3	39.1	41.7	35.7	36.4	38.1	40.7	34.8	35.5	37.2	39.7	33.1	33.7	35.3	37.7	30.7	31.3	32.7	34.9	

* Entering Indoor Dry Bulb Temperature

NOTE: Shaded area is AHRI Rating Conditions

COOLING PERFORMANCE DATA

GSC130421B*

EXPANDED PERFORMANCE DATA

COOLING OPERATION

MODEL: GSC130421B*/CA*F3642*6D*

IDB*	Airflow	Outdoor Ambient Temperature																								
		65				75				85				95				105				115				
		59	63	67	71	59	63	67	71	59	63	67	71	59	63	67	71	59	63	67	71	59	63	67	71	
70	1225	MBh	38.4	39.8	43.6	-	37.5	38.9	42.6	-	36.6	38.0	41.6	-	35.7	37.0	40.6	-	34.0	35.2	38.6	-	31.5	32.6	35.7	-
		S/T	0.67	0.56	0.39	-	0.69	0.58	0.40	-	0.71	0.59	0.41	-	0.73	0.61	0.43	-	0.76	0.64	0.44	-	0.77	0.64	0.44	-
		Delta T	19	17	13	-	20	17	13	-	20	17	13	-	20	17	13	-	19	17	13	-	18	16	12	-
		KW	2.69	2.76	2.86	-	2.93	3.00	3.11	-	3.14	3.22	3.34	-	3.33	3.41	3.53	-	3.48	3.57	3.70	-	3.62	3.71	3.85	-
		AMPS	11.5	11.8	12.2	-	12.5	12.8	13.2	-	13.5	13.9	14.3	-	14.5	14.9	15.4	-	15.4	15.8	16.4	-	16.4	16.8	17.3	-
		HIPR	148	159	168	-	166	178	188	-	188	203	214	-	214	231	244	-	241	260	274	-	267	287	303	-
		LOPR	58	62	68	-	62	66	72	-	64	68	75	-	67	72	78	-	71	75	82	-	73	78	85	-
		MBh	39.0	40.4	44.3	-	38.1	39.5	43.3	-	37.2	38.5	42.2	-	36.3	37.6	41.2	-	34.5	35.7	39.1	-	31.9	33.1	36.3	-
		S/T	0.69	0.58	0.40	-	0.72	0.60	0.42	-	0.74	0.62	0.43	-	0.76	0.64	0.44	-	0.79	0.66	0.46	-	0.80	0.67	0.46	-
		Delta T	19	17	13	-	19	17	13	-	19	17	13	-	20	17	13	-	19	17	13	-	18	16	12	-
KW	2.74	2.80	2.90	-	2.98	3.05	3.16	-	3.19	3.27	3.39	-	3.38	3.46	3.59	-	3.54	3.63	3.76	-	3.68	3.77	3.91	-		
AMPS	11.7	12.0	12.4	-	12.7	13.0	13.4	-	13.8	14.1	14.6	-	14.7	15.1	15.6	-	15.7	16.1	16.6	-	16.6	17.0	17.6	-		
HIPR	150	162	171	-	168	181	191	-	192	206	218	-	218	235	248	-	245	264	279	-	271	292	308	-		
LOPR	59	63	69	-	63	67	73	-	65	69	76	-	69	73	80	-	72	76	83	-	74	79	86	-		
MBh	40.4	41.8	45.8	-	39.4	40.9	44.8	-	38.5	39.9	43.7	-	37.6	38.9	42.6	-	36.7	37.0	40.5	-	33.0	34.3	37.5	-		
S/T	0.74	0.62	0.43	-	0.76	0.64	0.44	-	0.78	0.66	0.45	-	0.81	0.68	0.47	-	0.84	0.70	0.49	-	0.85	0.71	0.49	-		
Delta T	17	15	11	-	18	15	12	-	18	15	12	-	18	15	12	-	18	15	11	-	16	14	11	-		
KW	2.79	2.85	2.96	-	3.03	3.11	3.22	-	3.25	3.33	3.46	-	3.44	3.53	3.66	-	3.61	3.70	3.83	-	3.75	3.84	3.98	-		
AMPS	11.9	12.2	12.6	-	12.9	13.2	13.6	-	14.0	14.4	14.9	-	15.0	15.4	15.9	-	16.0	16.4	16.9	-	16.9	17.4	18.0	-		
HIPR	153	165	174	-	172	185	195	-	195	210	222	-	223	239	253	-	250	269	285	-	277	298	314	-		
LOPR	61	65	70	-	64	68	74	-	67	71	77	-	70	74	81	-	73	78	85	-	76	81	88	-		

75	1225	MBh	39.1	40.2	43.5	46.7	38.2	39.3	42.5	45.6	37.3	38.4	41.5	44.6	36.3	37.4	40.5	43.5	34.5	35.6	38.5	41.3	32.0	32.9	35.6	38.3	
		S/T	0.76	0.68	0.52	0.33	0.79	0.71	0.53	0.34	0.81	0.72	0.55	0.35	0.84	0.75	0.57	0.36	0.87	0.78	0.59	0.38	0.87	0.81	0.61	0.39	0.87
		Delta T	22	21	17	12	23	21	17	12	23	21	17	12	23	21	17	12	23	21	17	12	22	21	17	12	21
		KW	2.72	2.79	2.89	2.99	2.96	3.03	3.14	3.26	3.17	3.25	3.37	3.49	3.36	3.44	3.57	3.70	3.52	3.61	3.74	3.88	3.65	3.75	3.88	4.03	4.03
		AMPS	11.6	11.9	12.3	12.8	12.6	12.9	13.3	13.8	13.7	14.0	14.5	15.0	14.6	15.0	15.5	16.1	15.6	16.0	16.5	17.2	16.5	16.9	17.5	18.2	18.2
		HIPR	149	160	169	177	167	180	190	198	190	205	216	225	217	233	246	257	244	262	277	289	269	290	306	319	319
		LOPR	59	63	69	73	62	66	72	77	65	69	75	80	68	72	79	84	71	76	83	88	74	79	86	91	91
		MBh	39.7	40.8	44.2	47.4	38.7	39.9	43.2	46.3	37.8	38.9	42.2	45.2	36.9	38.0	41.1	44.1	35.1	36.1	39.1	41.9	32.5	33.4	36.2	38.8	38.8
		S/T	0.79	0.71	0.53	0.34	0.82	0.73	0.55	0.36	0.84	0.75	0.57	0.37	0.87	0.77	0.59	0.38	0.90	0.80	0.61	0.39	0.91	0.81	0.61	0.39	0.91
		Delta T	22	20	17	12	22	21	17	12	22	21	17	12	22	21	17	12	22	21	17	12	21	19	16	11	11
KW	2.76	2.83	2.93	3.04	3.01	3.08	3.19	3.31	3.22	3.30	3.42	3.55	3.41	3.50	3.63	3.76	3.57	3.66	3.80	3.94	3.71	3.81	3.95	4.10	4.10		
AMPS	11.8	12.1	12.5	13.0	12.8	13.1	13.5	14.0	13.9	14.2	14.7	15.3	14.9	15.2	15.8	16.4	15.8	16.2	16.8	17.4	16.8	17.2	17.8	18.5	18.5		
HIPR	152	163	172	180	170	183	193	202	194	208	220	229	220	237	250	261	248	267	282	294	274	295	311	325	325		
LOPR	60	64	70	74	63	68	74	79	66	70	77	82	69	74	80	86	73	77	84	90	75	80	87	93	93		
MBh	41.1	42.3	45.8	49.1	40.1	41.3	44.7	48.0	39.1	40.3	43.6	46.8	38.2	39.3	42.6	45.7	36.3	37.4	40.4	43.4	33.6	34.6	37.5	40.2	40.2		
S/T	0.84	0.75	0.57	0.37	0.87	0.78	0.59	0.38	0.89	0.80	0.60	0.39	0.92	0.82	0.62	0.40	0.96	0.85	0.65	0.42	0.96	0.86	0.65	0.42	0.96		
Delta T	20	19	15	10	20	19	15	11	20	19	15	11	20	19	15	11	20	19	15	11	19	17	14	10	10		
KW	2.81	2.88	2.99	3.10	3.06	3.14	3.25	3.37	3.28	3.36	3.49	3.62	3.48	3.56	3.69	3.83	3.64	3.73	3.87	4.01	3.78	3.88	4.02	4.17	4.17		
AMPS	12.0	12.3	12.7	13.2	13.0	13.3	13.8	14.3	14.2	14.5	15.0	15.6	15.1	15.5	16.0	16.7	16.1	16.5	17.1	17.8	17.1	17.5	18.1	18.8	18.8		
HIPR	155	166	176	183	174	187	197	206	197	212	224	234	225	242	255	266	253	272	287	300	279	301	318	331	331		
LOPR	61	65	71	76	65	69	75	80	67	72	78	83	71	75	82	87	74	79	86	92	77	82	89	95	95		

NOTE: Shaded area is ACCA (ITVA) conditions

* Entering Indoor Dry Bulb Temperature

COOLING PERFORMANCE DATA

GSC130421B*

EXPANDED PERFORMANCE DATA

COOLING OPERATION

MODEL: GSC130421B*/CA*F3642*6D*

IDB*	Airflow	Outdoor Ambient Temperature																								
		65				75				85				95				105				115				
		59	63	67	71	59	63	67	71	59	63	67	71	59	63	67	71	59	63	67	71	59	63	67	71	
80	1225	MBh	39.8	40.6	43.4	46.4	38.8	39.7	42.4	45.3	37.9	38.7	41.4	44.3	37.0	37.8	40.4	43.2	35.1	35.9	38.4	41.0	32.6	33.3	35.5	38.0
		S/T	0.84	0.78	0.64	0.48	0.87	0.81	0.66	0.49	0.89	0.83	0.68	0.51	0.92	0.86	0.70	0.52	0.95	0.89	0.73	0.54	0.96	0.90	0.73	0.55
		Delta T	25	24	21	17	25	24	21	17	25	24	21	17	25	24	21	17	25	24	21	17	23	22	20	16
		KW	2.74	2.81	2.91	3.02	2.99	3.06	3.17	3.29	3.20	3.28	3.40	3.53	3.39	3.47	3.60	3.74	3.55	3.64	3.77	3.91	3.69	3.78	3.92	4.07
		AMPS	11.7	12.0	12.4	12.9	12.7	13.0	13.4	13.9	13.8	14.1	14.6	15.2	14.8	15.1	15.6	16.2	15.7	16.1	16.7	17.3	16.7	17.1	17.7	18.4
	1300	HIPR	151	162	171	178	169	182	192	200	192	207	218	228	219	236	249	259	246	265	280	292	272	293	309	322
		LOPR	60	63	69	74	63	67	73	78	66	70	76	81	69	73	80	85	72	77	84	89	75	79	87	92
		MBh	40.4	41.3	44.1	47.1	39.4	40.3	43.1	46.0	38.5	39.3	42.0	44.9	37.6	38.4	41.0	43.8	35.7	36.5	39.0	41.6	33.0	33.8	36.1	38.6
		S/T	0.87	0.81	0.66	0.49	0.90	0.84	0.68	0.51	0.92	0.86	0.70	0.52	0.95	0.89	0.73	0.54	0.99	0.92	0.75	0.56	0.99	0.93	0.76	0.57
		Delta T	25	24	21	16	25	24	21	17	25	24	21	17	25	24	21	17	25	24	21	17	23	22	19	15
1575	KW	2.79	2.86	2.96	3.07	3.03	3.11	3.22	3.34	3.25	3.33	3.45	3.58	3.44	3.53	3.66	3.80	3.61	3.70	3.83	3.98	3.75	3.84	3.98	4.13	
	AMPS	11.9	12.2	12.6	13.1	12.9	13.2	13.7	14.2	14.0	14.4	14.9	15.4	15.0	15.4	15.9	16.5	16.0	16.4	16.9	17.6	17.0	17.4	18.0	18.7	
	HIPR	153	165	174	182	172	185	195	204	195	210	222	232	223	240	253	264	250	270	285	297	277	298	314	328	
	LOPR	61	65	70	75	64	68	74	79	67	71	77	82	70	74	81	87	73	78	85	91	76	81	88	94	
	MBh	41.8	42.7	45.6	48.8	40.8	41.7	44.6	47.6	39.8	40.7	43.5	46.5	38.9	39.7	42.4	45.4	36.9	37.7	40.3	43.1	34.2	35.0	37.3	39.9	

85	1225	MBh	40.5	41.2	43.2	46.1	39.5	40.3	42.2	45.0	38.6	39.3	41.2	43.9	37.6	38.4	40.2	42.9	35.8	36.4	38.2	40.7	33.1	33.8	35.4	37.7
		S/T	0.88	0.84	0.76	0.62	0.91	0.88	0.79	0.64	0.93	0.90	0.81	0.66	0.96	0.93	0.84	0.68	1.00	0.96	0.87	0.70	1.00	1.00	0.97	0.88
		Delta T	27	26	25	21	27	26	25	22	27	26	25	22	27	27	25	22	27	26	25	22	25	25	23	20
		KW	2.77	2.84	2.94	3.05	3.01	3.09	3.20	3.32	3.23	3.31	3.43	3.56	3.42	3.51	3.64	3.77	3.58	3.67	3.81	3.95	3.72	3.82	3.96	4.11
		AMPS	11.8	12.1	12.5	13.0	12.8	13.1	13.6	14.1	13.9	14.3	14.8	15.3	14.9	15.3	15.8	16.4	15.9	16.3	16.8	17.5	16.8	17.3	17.8	18.5
	1300	HIPR	152	164	173	180	171	184	194	202	194	209	221	230	221	238	251	262	249	268	283	295	275	296	312	326
		LOPR	60	64	70	75	64	68	74	79	66	70	77	82	69	74	81	86	73	77	85	90	75	80	87	93
		MBh	41.1	41.9	43.9	46.8	40.1	40.9	42.8	45.7	39.2	39.9	41.8	44.6	38.2	39.0	40.8	43.5	36.3	37.0	38.8	41.3	33.6	34.3	35.9	38.3
		S/T	0.91	0.88	0.79	0.64	0.94	0.91	0.82	0.66	0.96	0.93	0.84	0.68	1.00	0.96	0.87	0.70	1.00	1.00	0.90	0.73	1.00	1.00	0.91	0.74
		Delta T	26	26	25	21	27	26	25	21	27	26	25	21	27	26	25	22	26	26	25	21	24	24	23	20
1575	KW	2.81	2.88	2.99	3.10	3.06	3.14	3.25	3.37	3.28	3.36	3.49	3.62	3.48	3.56	3.69	3.83	3.64	3.73	3.87	4.02	3.78	3.88	4.02	4.17	
	AMPS	12.0	12.3	12.7	13.2	13.0	13.3	13.8	14.3	14.2	14.5	15.0	15.6	15.1	15.5	16.0	16.7	16.1	16.5	17.1	17.8	17.1	17.5	18.1	18.8	
	HIPR	155	166	176	183	174	187	197	206	197	212	224	234	225	242	256	267	253	272	287	300	280	301	318	331	
	LOPR	61	65	71	76	65	69	75	80	67	72	78	83	71	75	82	87	74	79	86	92	77	82	89	95	
	MBh	42.5	43.3	45.4	48.4	41.5	42.3	44.3	47.3	40.5	41.3	43.3	46.2	39.5	40.3	42.2	45.0	37.6	38.3	40.1	42.8	34.8	35.5	37.2	39.6	

* Entering Indoor Dry Bulb Temperature

NOTE: Shaded area is AHRI Rating Conditions

COOLING PERFORMANCE DATA

GSC130481A*

EXPANDED PERFORMANCE DATA

COOLING OPERATION

MODEL: GSC130481A* / CAUF4860C6A

IDB*	Airflow	Outdoor Ambient Temperature																													
		65					75					85					95					105					115				
		59	63	67	71	75	59	63	67	71	75	59	63	67	71	75	59	63	67	71	75	59	63	67	71	75	59	63	67	71	75
70	1688	MBh	44.6	46.2	50.6	-	43.5	45.1	49.5	-	42.5	44.1	48.3	-	41.5	43.0	47.1	-	39.4	40.8	44.7	-	36.5	37.8	41.4	-					
		S/T	0.74	0.62	0.43	-	0.77	0.64	0.44	-	0.79	0.66	0.45	-	0.81	0.68	0.47	-	0.84	0.70	0.49	-	0.85	0.71	0.49	-					
		Delta T	18	16	12	-	18	16	12	-	18	16	12	-	18	16	12	-	18	16	12	-	17	15	11	-					
		KW	3.21	3.27	3.37	-	3.44	3.51	3.62	-	3.65	3.72	3.84	-	3.83	3.91	4.03	-	3.98	4.06	4.19	-	4.11	4.20	4.33	-					
		AMPS	12.5	12.8	13.2	-	13.5	13.9	14.3	-	14.7	15.1	15.6	-	15.7	16.1	16.6	-	16.7	17.1	17.7	-	17.7	18.1	18.8	-					
		HI PR	144	155	164	-	162	174	184	-	184	198	209	-	210	226	238	-	236	254	268	-	261	281	296	-					
		LO PR	63	67	73	-	66	71	77	-	69	73	80	-	73	77	84	-	76	81	88	-	79	84	91	-					
		MBh	43.3	44.9	49.2	-	42.3	43.8	48.0	-	41.3	42.8	46.9	-	40.3	41.7	45.7	-	38.3	39.6	43.4	-	35.4	36.7	40.2	-					
		S/T	0.71	0.59	0.41	-	0.73	0.61	0.42	-	0.75	0.63	0.43	-	0.77	0.65	0.45	-	0.80	0.67	0.46	-	0.81	0.68	0.47	-					
		Delta T	19	16	12	-	19	16	12	-	19	16	12	-	19	17	13	-	19	16	12	-	18	15	12	-					
KW	3.19	3.25	3.35	-	3.42	3.49	3.59	-	3.62	3.69	3.81	-	3.80	3.88	4.00	-	3.95	4.03	4.16	-	4.08	4.17	4.30	-							
AMPS	12.4	12.7	13.1	-	13.4	13.7	14.2	-	14.6	14.9	15.4	-	15.6	15.9	16.5	-	16.6	17.0	17.5	-	17.5	18.0	18.6	-							
HI PR	143	154	162	-	160	173	182	-	182	196	207	-	208	224	236	-	234	252	266	-	258	278	293	-							
LO PR	62	66	72	-	66	70	76	-	68	73	79	-	72	76	83	-	75	80	87	-	78	83	90	-							
MBh	40.0	41.4	45.4	-	39.0	40.4	44.3	-	38.1	39.5	43.3	-	37.2	38.5	42.2	-	35.3	36.6	40.1	-	32.7	33.9	37.1	-							
S/T	0.68	0.57	0.39	-	0.71	0.59	0.41	-	0.72	0.60	0.42	-	0.75	0.62	0.43	-	0.77	0.65	0.45	-	0.78	0.65	0.45	-							
Delta T	19	16	13	-	19	17	13	-	19	17	13	-	19	17	13	-	19	17	13	-	18	15	12	-							
KW	3.12	3.18	3.27	-	3.34	3.41	3.51	-	3.53	3.61	3.72	-	3.71	3.78	3.90	-	3.85	3.94	4.06	-	3.98	4.07	4.19	-							
AMPS	12.1	12.4	12.8	-	13.1	13.4	13.8	-	14.2	14.5	15.0	-	15.1	15.5	16.0	-	16.1	16.5	17.1	-	17.1	17.5	18.1	-							
HI PR	139	149	158	-	156	167	177	-	177	190	201	-	202	217	229	-	227	244	258	-	251	270	285	-							
LO PR	60	64	70	-	64	68	74	-	66	71	77	-	70	74	81	-	73	78	85	-	76	80	88	-							
75	1688	MBh	45.3	46.7	50.5	54.2	44.3	45.6	49.4	53.0	43.2	44.5	48.2	51.7	42.2	43.4	47.0	50.4	40.1	41.3	44.7	47.9	37.1	38.2	41.4	44.4					
		S/T	0.84	0.75	0.57	0.37	0.87	0.78	0.59	0.38	0.89	0.80	0.60	0.39	0.92	0.83	0.62	0.40	0.96	0.86	0.65	0.42	0.97	0.86	0.65	0.42					
		Delta T	21	19	16	11	21	19	16	11	21	19	16	11	21	20	16	11	21	21	19	16	11	20	18	15	10				
		KW	3.24	3.30	3.40	3.50	3.47	3.54	3.65	3.76	3.68	3.75	3.87	3.99	3.86	3.94	4.06	4.19	4.01	4.10	4.23	4.36	4.15	4.23	4.37	4.51					
		AMPS	12.6	12.9	13.4	13.9	13.7	14.0	14.4	15.0	14.8	15.2	15.7	16.3	15.9	16.2	16.8	17.4	16.9	17.3	17.9	18.5	17.9	18.3	18.9	19.7					
		HI PR	146	157	166	173	164	176	186	194	186	200	212	221	212	228	241	251	238	257	271	283	264	284	299	312					
		LO PR	64	68	74	79	67	71	78	83	70	74	81	86	73	78	85	91	77	82	89	95	79	85	92	98					
		MBh	44.0	45.3	49.1	52.7	43.0	44.3	47.9	51.4	42.0	43.2	46.8	50.2	41.0	42.2	45.6	49.0	38.9	40.1	43.4	46.5	36.0	37.1	40.2	43.1					
		S/T	0.80	0.72	0.54	0.35	0.83	0.74	0.56	0.36	0.85	0.76	0.58	0.37	0.88	0.79	0.60	0.38	0.91	0.82	0.62	0.40	0.92	0.82	0.62	0.40					
		Delta T	22	20	16	11	22	20	17	11	22	20	17	11	22	20	17	12	22	20	16	11	20	19	15	11					
KW	3.21	3.27	3.37	3.47	3.44	3.51	3.62	3.73	3.65	3.72	3.84	3.96	3.83	3.91	4.03	4.16	3.98	4.06	4.19	4.33	4.11	4.20	4.33	4.47							
AMPS	12.5	12.8	13.2	13.7	13.5	13.9	14.3	14.9	14.7	15.1	15.6	16.1	15.7	16.1	16.6	17.3	16.7	17.1	17.7	18.4	17.7	18.2	18.8	19.5							
HI PR	144	155	164	171	162	174	184	192	184	198	209	218	210	226	239	249	236	254	268	280	261	281	296	309							
LO PR	63	67	73	78	66	71	77	82	69	74	80	85	73	77	84	90	76	81	88	94	79	84	91	97							
MBh	40.6	41.8	45.3	48.6	39.7	40.9	44.2	47.5	38.7	39.9	43.2	46.3	37.8	38.9	42.1	45.2	35.9	37.0	40.0	42.9	33.3	34.2	37.1	39.8							
S/T	0.77	0.69	0.52	0.34	0.80	0.72	0.54	0.35	0.82	0.74	0.56	0.36	0.85	0.76	0.57	0.37	0.88	0.79	0.60	0.38	0.89	0.79	0.60	0.39							
Delta T	22	20	17	11	22	21	17	12	22	21	17	12	22	21	17	12	22	20	17	12	21	19	16	11							
KW	3.14	3.20	3.30	3.39	3.36	3.43	3.53	3.64	3.56	3.64	3.75	3.86	3.74	3.81	3.93	4.06	3.89	3.97	4.09	4.22	4.01	4.10	4.23	4.36							
AMPS	12.2	12.5	12.9	13.4	13.2	13.5	13.9	14.4	14.3	14.6	15.1	15.7	15.3	15.7	16.2	16.8	16.3	16.7	17.2	17.9	17.2	17.6	18.2	18.9							
HI PR	140	151	159	166	157	169	179	186	179	192	203	212	204	219	231	241	229	246	260	271	253	272	288	300							
LO PR	61	65	71	76	64	69	75	80	67	71	78	83	70	75	82	87	74	78	86	91	76	81	89	94							

NOTE: Shaded area is ACCA (TVA) conditions

* Entering Indoor Dry Bulb Temperature

COOLING PERFORMANCE DATA

GSC130481A*

EXPANDED PERFORMANCE DATA

COOLING OPERATION

MODEL: GSC130481A* / CAUF4860C6A

IDB*	Airflow	Outdoor Ambient Temperature																									
		65				75				85				95				105				115					
		59	63	67	71	59	63	67	71	59	63	67	71	59	63	67	71	59	63	67	71	59	63	67	71		
80	1688	MBh	46.1	47.2	50.4	53.9	45.1	46.1	49.2	52.6	44.0	45.0	48.0	51.4	42.9	43.9	46.9	50.1	40.8	41.7	44.5	47.6	37.8	38.6	41.2	44.1	
		S/T	0.92	0.86	0.70	0.53	0.96	0.90	0.73	0.55	1.00	0.92	0.75	0.56	1.00	0.95	0.77	0.58	1.00	1.00	0.80	0.60	1.00	1.00	0.81	0.60	
		Delta T	23	22	19	15	23	22	20	16	24	23	20	16	23	23	20	16	22	22	23	19	16	21	21	18	15
		KW	3.26	3.32	3.42	3.53	3.50	3.57	3.68	3.79	3.70	3.78	3.90	4.02	3.89	3.97	4.09	4.22	4.04	4.04	4.13	4.26	4.40	4.18	4.27	4.40	4.55
		AMPS	12.8	13.1	13.5	14.0	13.8	14.1	14.6	15.1	15.0	15.3	15.8	16.4	16.0	16.4	16.9	17.6	17.0	17.0	17.5	18.0	18.7	18.0	18.5	19.1	19.8
	1500	HIPR	147	159	167	175	165	178	188	196	188	202	214	223	214	230	243	254	241	259	274	286	266	286	302	315	
		LO PR	64	68	75	79	68	72	79	84	70	75	82	87	74	79	86	92	78	83	90	96	80	85	93	99	
		MBh	44.8	45.8	48.9	52.3	43.8	44.7	47.8	51.1	42.7	43.7	46.6	49.9	41.7	42.6	45.5	48.6	39.6	40.5	43.2	46.2	36.7	37.5	40.0	42.8	
		S/T	0.88	0.82	0.67	0.50	0.91	0.85	0.70	0.52	0.93	0.88	0.71	0.53	0.96	0.90	0.74	0.55	1.00	0.94	0.76	0.57	1.00	0.95	0.77	0.58	
		Delta T	24	23	20	16	24	23	20	16	24	23	20	16	25	24	21	16	24	24	23	20	16	22	22	19	15
1313	KW	3.24	3.30	3.40	3.50	3.47	3.54	3.65	3.76	3.68	3.75	3.87	3.99	3.86	3.94	4.06	4.19	4.01	4.10	4.23	4.36	4.15	4.23	4.37	4.51		
	AMPS	12.6	12.9	13.4	13.9	13.7	14.0	14.5	15.0	14.8	15.2	15.7	16.3	15.9	16.2	16.8	17.4	16.9	17.3	17.9	18.5	17.9	18.3	18.9	19.7		
	HIPR	146	157	166	173	164	176	186	194	186	200	212	221	212	228	241	251	239	257	271	283	264	284	299	312		
	LO PR	64	68	74	79	67	71	78	83	70	74	81	86	71	76	83	88	77	82	89	95	79	85	92	98		
	MBh	41.4	42.3	45.1	48.3	40.4	41.3	44.1	47.1	39.4	40.3	43.0	46.0	38.5	39.3	42.0	44.9	36.5	37.3	39.9	42.6	33.9	34.6	37.0	39.5		

85	1688	MBh	47.0	47.9	50.1	53.5	45.9	46.7	49.0	52.2	44.8	45.6	47.8	51.0	43.7	44.5	46.6	49.7	41.5	42.3	44.3	47.3	38.4	39.2	41.0	43.8
		S/T	0.97	0.93	0.84	0.68	1.00	0.97	0.87	0.71	1.00	0.99	0.89	0.73	1.00	1.00	0.92	0.75	1.00	1.00	0.96	0.78	1.00	1.00	0.97	0.78
		Delta T	25	24	23	20	25	25	23	20	24	24	25	23	20	24	24	23	20	23	23	20	21	21	22	19
		KW	3.28	3.35	3.45	3.55	3.52	3.59	3.70	3.82	3.73	3.81	3.93	4.05	3.92	4.00	4.13	4.26	4.08	4.16	4.30	4.43	4.21	4.30	4.44	4.59
		AMPS	12.9	13.2	13.6	14.1	13.9	14.2	14.7	15.3	15.1	15.5	16.0	16.6	16.2	16.5	17.1	17.7	17.2	17.6	18.2	18.9	18.2	18.7	19.3	20.0
	1500	HIPR	149	160	169	176	167	180	190	198	190	204	216	225	216	233	246	256	243	262	276	288	269	289	305	319
		LO PR	65	69	75	80	69	73	80	85	71	76	83	88	75	80	87	93	78	83	91	97	81	86	94	100
		MBh	45.6	46.5	48.7	51.9	44.5	45.4	47.5	50.7	43.5	44.3	46.4	49.5	42.4	43.2	45.3	48.3	40.3	41.1	43.0	45.9	37.3	38.0	39.8	42.5
		S/T	0.92	0.89	0.80	0.65	0.96	0.92	0.83	0.68	0.98	0.95	0.85	0.69	1.00	0.98	0.88	0.71	1.00	1.00	0.91	0.74	1.00	1.00	0.92	0.75
		Delta T	26	25	24	21	26	26	24	21	26	26	24	21	26	26	24	21	26	25	24	21	23	23	23	19
1313	KW	3.26	3.32	3.42	3.53	3.50	3.57	3.68	3.79	3.70	3.78	3.90	4.02	3.89	3.97	4.09	4.22	4.04	4.13	4.26	4.40	4.18	4.27	4.40	4.55	
	AMPS	12.8	13.1	13.5	14.0	13.8	14.1	14.6	15.1	15.0	15.3	15.8	16.4	16.0	16.4	16.9	17.6	17.0	17.5	18.0	18.7	18.0	18.5	19.1	19.8	
	HIPR	147	159	167	175	165	178	188	196	188	202	214	223	214	230	243	254	241	259	274	286	266	286	302	315	
	LO PR	64	68	75	79	68	72	79	84	70	75	82	87	74	79	86	92	78	83	90	96	80	85	93	99	
	MBh	42.1	42.9	44.9	47.9	41.1	41.9	43.9	46.8	40.1	40.9	42.8	45.7	39.1	39.9	41.8	44.6	37.2	37.9	39.7	42.4	34.4	35.1	36.8	39.2	

* Entering Indoor Dry Bulb Temperature

NOTE: Shaded area is AHRI Rating Conditions

COOLING PERFORMANCE DATA

GSC130481B*

EXPANDED PERFORMANCE DATA

COOLING OPERATION

MODEL: GSC130481B* / CA*F4860*6D*

IDB*	Airflow	Outdoor Ambient Temperature																								
		65				75				85				95				105				115				
		59	63	67	71	59	63	67	71	59	63	67	71	59	63	67	71	59	63	67	71	59	63	67	71	
70	1400	MBh	43.1	44.7	49.0	-	42.1	43.6	47.8	-	41.1	42.6	46.7	-	40.1	41.6	45.5	-	38.1	39.5	43.3	-	35.3	36.6	40.1	-
		S/T	0.69	0.58	0.40	-	0.72	0.60	0.42	-	0.74	0.61	0.43	-	0.76	0.63	0.44	-	0.79	0.66	0.46	-	0.80	0.66	0.46	-
		Delta T	20	17	13	-	20	17	13	-	20	17	13	-	20	17	13	-	20	17	13	-	18	16	12	-
		KW	2.94	3.01	3.12	-	3.20	3.28	3.40	-	3.43	3.51	3.64	-	3.63	3.72	3.86	-	3.81	3.90	4.05	-	3.96	4.06	4.21	-
		AMPS	12.6	12.9	13.3	-	13.6	13.9	14.4	-	14.8	15.2	15.7	-	15.9	16.2	16.8	-	16.9	17.3	17.9	-	17.9	18.4	19.0	-
		HIPR	146	158	166	-	164	177	187	-	187	201	212	-	213	229	242	-	239	258	272	-	264	285	301	-
		LO PR	61	65	71	-	64	69	75	-	67	71	78	-	70	75	82	-	74	78	86	-	76	81	89	-
70	1550	MBh	43.8	45.4	49.7	-	42.7	44.3	48.5	-	41.7	43.2	47.4	-	40.7	42.2	46.2	-	38.7	40.1	43.9	-	35.8	37.1	40.7	-
		S/T	0.72	0.60	0.42	-	0.74	0.62	0.43	-	0.76	0.64	0.44	-	0.79	0.66	0.46	-	0.82	0.68	0.47	-	0.82	0.69	0.48	-
		Delta T	19	16	12	-	19	16	12	-	19	16	12	-	19	16	13	-	19	16	12	-	18	15	12	-
		KW	2.98	3.06	3.17	-	3.25	3.33	3.45	-	3.48	3.57	3.70	-	3.69	3.78	3.92	-	3.87	3.97	4.11	-	4.02	4.12	4.28	-
		AMPS	12.8	13.1	13.5	-	13.8	14.2	14.6	-	15.1	15.4	15.9	-	16.1	16.5	17.1	-	17.2	17.6	18.2	-	18.2	18.7	19.3	-
		HIPR	149	160	169	-	167	180	190	-	190	205	216	-	216	233	246	-	244	262	277	-	269	290	306	-
		LO PR	62	66	72	-	66	70	76	-	68	72	79	-	72	76	83	-	75	80	87	-	78	83	90	-
70	1800	MBh	45.1	46.7	51.2	-	44.0	45.6	50.0	-	43.0	44.5	48.8	-	41.9	43.5	47.6	-	39.8	41.3	45.2	-	36.9	38.2	41.9	-
		S/T	0.75	0.63	0.44	-	0.78	0.65	0.45	-	0.80	0.67	0.46	-	0.83	0.69	0.48	-	0.86	0.72	0.50	-	0.86	0.72	0.50	-
		Delta T	17	15	11	-	18	15	12	-	18	15	12	-	18	15	12	-	17	15	11	-	16	14	11	-
		KW	3.01	3.08	3.20	-	3.28	3.36	3.48	-	3.52	3.60	3.74	-	3.73	3.82	3.96	-	3.90	4.00	4.15	-	4.06	4.16	4.32	-
		AMPS	12.9	13.2	13.6	-	14.0	14.3	14.8	-	15.2	15.6	16.1	-	16.3	16.7	17.2	-	17.3	17.8	18.4	-	18.4	18.8	19.5	-
		HIPR	150	162	171	-	169	182	192	-	192	207	218	-	219	235	248	-	246	265	279	-	272	292	309	-
		LO PR	63	67	73	-	66	70	77	-	69	73	80	-	72	77	84	-	76	81	88	-	78	83	91	-

75	1400	MBh	43.8	45.1	48.9	52.4	42.8	44.1	47.7	51.2	41.8	43.0	46.6	50.0	40.8	42.0	45.4	48.8	38.7	39.9	43.2	46.3	35.9	36.9	40.0	42.9
		S/T	0.79	0.70	0.53	0.34	0.82	0.73	0.55	0.36	0.84	0.75	0.57	0.36	0.86	0.77	0.58	0.38	0.90	0.80	0.61	0.39	0.90	0.81	0.61	0.39
		Delta T	23	21	17	12	23	21	17	12	23	21	17	12	23	21	17	12	23	21	17	12	21	20	16	11
		KW	2.96	3.04	3.15	3.26	3.23	3.31	3.43	3.56	3.46	3.55	3.68	3.82	3.67	3.76	3.90	4.05	3.84	3.94	4.09	4.24	3.99	4.09	4.25	4.41
		AMPS	12.7	13.0	13.4	13.9	13.7	14.1	14.6	15.1	15.0	15.3	15.8	16.5	16.0	16.4	17.0	17.6	17.1	17.5	18.1	18.8	18.1	18.5	19.2	19.9
		HIPR	148	159	168	175	166	179	189	197	189	203	214	224	215	231	244	255	242	260	275	287	267	288	304	317
		LO PR	62	66	72	76	65	69	76	81	68	72	79	84	71	76	83	88	74	79	86	92	77	82	89	95
75	1550	MBh	44.5	45.8	49.6	53.2	43.5	44.8	48.4	52.0	42.4	43.7	47.3	50.8	41.4	42.6	46.1	49.5	39.3	40.5	43.8	47.0	36.4	37.5	40.6	43.6
		S/T	0.82	0.73	0.55	0.36	0.85	0.76	0.57	0.37	0.87	0.78	0.59	0.38	0.90	0.80	0.61	0.39	0.93	0.83	0.63	0.40	0.94	0.84	0.63	0.41
		Delta T	22	20	16	11	22	20	16	11	22	20	16	11	22	20	17	11	22	20	16	11	20	19	15	11
		KW	3.01	3.08	3.20	3.32	3.28	3.36	3.48	3.61	3.52	3.61	3.74	3.88	3.73	3.82	3.96	4.11	3.91	4.00	4.15	4.31	4.06	4.16	4.32	4.48
		AMPS	12.9	13.2	13.6	14.2	14.0	14.3	14.8	15.3	15.2	15.6	16.1	16.7	16.3	16.7	17.2	17.9	17.3	17.8	18.4	19.1	18.4	18.8	19.5	20.3
		HIPR	150	162	171	178	169	182	192	200	192	207	218	228	219	235	248	259	246	265	280	292	272	293	309	322
		LO PR	63	67	73	78	66	70	77	82	69	73	80	85	72	77	84	89	76	81	88	94	78	83	91	97
75	1800	MBh	45.8	47.2	51.1	54.8	44.8	46.1	49.9	53.6	43.7	45.0	48.7	52.3	42.6	43.9	47.5	51.0	40.5	41.7	45.1	48.5	37.5	38.6	41.8	44.9
		S/T	0.86	0.77	0.58	0.37	0.89	0.79	0.60	0.39	0.91	0.81	0.62	0.40	0.94	0.84	0.64	0.41	0.97	0.87	0.66	0.42	0.98	0.88	0.67	0.43
		Delta T	20	18	15	10	20	19	15	11	20	19	15	11	20	19	15	11	20	19	15	11	19	17	14	10
		KW	3.04	3.11	3.23	3.35	3.31	3.39	3.52	3.65	3.55	3.64	3.77	3.92	3.76	3.86	4.00	4.15	3.94	4.04	4.19	4.35	4.10	4.20	4.36	4.52
		AMPS	13.0	13.3	13.8	14.3	14.1	14.4	14.9	15.5	15.3	15.7	16.3	16.9	16.4	16.8	17.4	18.1	17.5	17.9	18.5	19.3	18.6	19.0	19.7	20.4
		HIPR	152	164	173	180	171	183	194	202	194	209	220	230	221	238	251	262	248	267	282	294	275	295	312	325
		LO PR	63	67	74	78	67	71	78	83	70	74	81	86	73	78	85	90	77	81	89	95	79	84	92	98

* Entering Indoor Dry Bulb Temperature

NOTE: Shaded area is ACOA (TVA) conditions

COOLING PERFORMANCE DATA

GSC130481B*

EXPANDED PERFORMANCE DATA

COOLING OPERATION

MODEL: GSC130481B* / CA*F4860*6D*

IDB*	Airflow	Outdoor Ambient Temperature																													
		65					75					85					95					105					115				
		59	63	67	71	75	59	63	67	71	75	59	63	67	71	75	59	63	67	71	75	59	63	67	71	75	59	63	67	71	75
80	1400	MBh	44.6	45.6	48.7	52.1	43.6	44.5	47.6	50.9	42.5	43.5	46.4	49.6	41.5	42.4	45.3	48.4	39.4	40.3	43.0	46.0	36.5	37.3	39.9	42.6					
		S/T	0.86	0.81	0.66	0.49	0.90	0.84	0.68	0.51	0.92	0.86	0.70	0.52	0.95	0.89	0.72	0.54	0.98	0.92	0.75	0.56	0.99	0.93	0.76	0.57					
		Delta T	25	24	21	17	26	25	21	17	26	25	21	17	26	25	22	17	25	24	21	17	24	23	20	16					
		KW	2.99	3.06	3.18	3.29	3.26	3.34	3.46	3.59	3.49	3.58	3.71	3.85	3.70	3.80	3.94	4.08	3.88	3.98	4.12	4.28	4.03	4.13	4.29	4.45					
		AMPS	12.8	13.1	13.6	14.1	13.9	14.2	14.7	15.2	15.1	15.5	16.0	16.6	16.2	16.6	17.1	17.8	17.2	17.6	18.2	19.0	18.3	18.7	19.4	20.1					
	1550	HIPR	149	161	170	177	168	180	190	199	191	205	217	226	217	234	247	257	244	263	278	290	270	290	307	320					
		LO PR	62	66	72	77	66	70	76	81	68	73	79	85	72	76	83	89	75	80	87	93	78	83	90	96					
		MBh	45.3	46.3	49.5	52.9	44.2	45.2	48.3	51.6	43.2	44.1	47.2	50.4	42.1	43.1	46.0	49.2	40.0	40.9	43.7	46.7	37.1	37.9	40.5	43.3					
		S/T	0.90	0.84	0.68	0.51	0.93	0.87	0.71	0.53	0.95	0.89	0.73	0.54	0.98	0.92	0.75	0.56	1.00	0.96	0.78	0.58	1.00	0.96	0.78	0.59					
		Delta T	24	23	20	16	24	23	20	16	24	23	20	16	24	23	20	16	24	23	20	16	22	22	19	15					
1800	KW	3.04	3.11	3.23	3.35	3.31	3.39	3.52	3.65	3.55	3.64	3.77	3.92	3.76	3.86	4.00	4.15	3.94	4.04	4.19	4.35	4.10	4.20	4.36	4.52						
	AMPS	13.0	13.3	13.8	14.3	14.1	14.4	14.9	15.5	15.3	15.7	16.3	16.9	16.4	16.8	17.4	18.1	17.5	17.9	18.5	19.3	18.6	19.0	19.7	20.4						
	HIPR	152	164	173	180	171	184	194	202	194	209	220	230	221	238	251	262	248	267	282	295	275	295	312	325						
	LO PR	63	67	74	78	67	71	78	83	70	74	81	86	73	78	85	90	77	81	89	95	79	84	92	98						
	MBh	46.7	47.7	50.9	54.4	45.6	46.6	49.7	53.2	44.5	45.5	48.6	51.9	43.4	44.3	47.4	50.6	41.2	42.1	45.0	48.1	38.2	39.0	41.7	44.6						

85	1400	MBh	45.4	46.3	48.5	51.7	44.3	45.2	47.3	50.5	43.3	44.1	46.2	49.3	42.2	43.0	45.1	48.1	40.1	40.9	42.8	45.7	37.2	37.9	39.7	42.3
		S/T	0.91	0.87	0.79	0.64	0.94	0.91	0.82	0.66	0.96	0.93	0.84	0.68	0.99	0.96	0.87	0.70	1.00	0.99	0.90	0.73	1.00	1.00	0.91	0.73
		Delta T	27	27	25	22	27	27	25	22	27	27	25	22	28	27	26	22	26	27	25	22	24	25	24	20
		KW	3.02	3.09	3.21	3.32	3.29	3.37	3.49	3.62	3.53	3.61	3.75	3.89	3.74	3.83	3.97	4.12	3.92	4.01	4.16	4.32	4.07	4.17	4.33	4.49
		AMPS	12.9	13.2	13.7	14.2	14.0	14.3	14.8	15.4	15.2	15.6	16.1	16.8	16.3	16.7	17.3	17.9	17.4	17.8	18.4	19.1	18.4	18.9	19.5	20.3
	1550	HIPR	151	162	171	179	169	182	192	201	193	207	219	228	219	236	249	260	247	265	280	292	273	293	310	323
		LO PR	63	67	73	78	66	71	77	82	69	73	80	85	72	77	84	90	76	81	88	94	79	84	91	97
		MBh	46.1	47.0	49.2	52.5	45.0	45.9	48.1	51.3	43.9	44.8	46.9	50.1	42.9	43.7	45.8	48.8	40.7	41.5	43.5	46.4	37.7	38.5	40.3	43.0
		S/T	0.94	0.91	0.82	0.66	0.97	0.94	0.85	0.69	1.00	0.96	0.87	0.71	1.00	0.99	0.90	0.73	1.00	1.00	0.93	0.76	1.00	1.00	0.94	0.76
		Delta T	26	25	24	21	26	26	24	21	26	26	24	21	25	26	24	21	24	25	24	21	22	23	22	19
1800	KW	3.07	3.14	3.26	3.38	3.34	3.42	3.55	3.68	3.58	3.67	3.81	3.95	3.80	3.89	4.04	4.19	3.98	4.08	4.23	4.39	4.14	4.24	4.40	4.57	
	AMPS	13.1	13.5	13.9	14.4	14.2	14.6	15.1	15.6	15.5	15.9	16.4	17.0	16.6	17.0	17.6	18.2	17.7	18.1	18.7	19.5	18.7	19.2	19.9	20.6	
	HIPR	153	165	174	182	172	185	196	204	196	211	223	232	223	240	254	264	251	270	285	297	277	298	315	329	
	LO PR	64	68	74	79	68	72	78	84	70	75	82	87	74	78	86	91	77	82	90	96	80	85	93	99	
	MBh	47.5	48.4	50.7	54.1	46.4	47.3	49.5	52.8	45.3	46.1	48.3	51.6	44.2	45.0	47.1	50.3	42.0	42.8	44.8	47.8	38.9	39.6	41.5	44.3	

NOTE: Shaded area is AHR1 Rating Conditions

* Entering Indoor Dry Bulb Temperature

COOLING PERFORMANCE DATA

GSC130601B*

EXPANDED PERFORMANCE DATA

COOLING OPERATION

MODEL: GSC130601B* / CAUF4860C6A

IDB*	Airflow	Outdoor Ambient Temperature																								
		65				75				85				95				105				115				
		59	63	67	71	59	63	67	71	59	63	67	71	59	63	67	71	59	63	67	71	59	63	67	71	
70	1913	MBh	54.9	56.9	62.3	-	53.6	55.6	60.9	-	52.3	54.2	59.4	-	51.0	52.9	58.0	-	48.5	50.3	55.1	-	44.9	46.6	51.0	-
		S/T	0.72	0.60	0.42	-	0.75	0.62	0.43	-	0.77	0.64	0.44	-	0.79	0.66	0.46	-	0.82	0.68	0.47	-	0.83	0.69	0.48	-
		Delta T	19	16	12	-	19	17	13	-	19	17	13	-	19	17	13	-	19	17	13	-	18	15	12	-
		KW	3.96	4.03	4.14	-	4.23	4.31	4.43	-	4.47	4.56	4.69	-	4.68	4.77	4.92	-	4.86	4.96	5.11	-	5.01	5.12	5.27	-
		AMPS	13.6	14.0	14.4	-	14.7	15.1	15.6	-	16.0	16.4	16.9	-	17.1	17.5	18.1	-	18.2	18.6	19.3	-	19.3	19.7	20.4	-
		HI PR	146	157	166	-	163	176	186	-	186	200	211	-	212	228	241	-	238	256	271	-	263	283	299	-
	LO PR	59	63	69	-	63	67	73	-	65	69	76	-	69	73	80	-	72	76	83	-	74	79	86	-	
	1700	MBh	53.3	55.2	60.5	-	52.0	53.9	59.1	-	50.8	52.7	57.7	-	49.6	51.4	56.3	-	47.1	48.8	53.5	-	43.6	45.2	49.5	-
		S/T	0.69	0.57	0.40	-	0.71	0.59	0.41	-	0.73	0.61	0.42	-	0.75	0.63	0.44	-	0.78	0.65	0.45	-	0.79	0.66	0.46	-
		Delta T	20	17	13	-	20	17	13	-	20	17	13	-	20	17	13	-	20	17	13	-	19	16	12	-
		KW	3.93	4.00	4.11	-	4.20	4.28	4.40	-	4.43	4.52	4.66	-	4.64	4.74	4.88	-	4.82	4.92	5.07	-	4.98	5.08	5.23	-
		AMPS	13.5	13.8	14.3	-	14.6	14.9	15.4	-	15.9	16.2	16.8	-	16.9	17.4	17.9	-	18.0	18.5	19.1	-	19.1	19.6	20.2	-
HI PR		144	155	164	-	162	174	184	-	184	198	209	-	210	226	238	-	236	254	268	-	261	280	296	-	
LO PR	59	63	68	-	62	66	72	-	65	69	75	-	68	72	79	-	71	76	83	-	74	78	85	-		
1488	MBh	49.2	51.0	55.8	-	48.0	49.8	54.5	-	46.9	48.6	53.2	-	45.7	47.4	51.9	-	43.5	45.0	49.3	-	40.3	41.7	45.7	-	
	S/T	0.66	0.55	0.38	-	0.69	0.57	0.40	-	0.70	0.59	0.41	-	0.73	0.61	0.42	-	0.75	0.63	0.44	-	0.76	0.64	0.44	-	
	Delta T	20	17	13	-	20	18	13	-	20	18	13	-	21	18	13	-	20	18	13	-	19	16	12	-	
	KW	3.84	3.92	4.03	-	4.11	4.18	4.30	-	4.34	4.42	4.55	-	4.54	4.63	4.77	-	4.71	4.81	4.95	-	4.86	4.96	5.11	-	
	AMPS	13.1	13.5	13.9	-	14.2	14.5	15.0	-	15.4	15.8	16.3	-	16.5	16.9	17.4	-	17.5	18.0	18.6	-	18.6	19.0	19.7	-	
	HI PR	140	151	159	-	157	169	178	-	179	192	203	-	203	219	231	-	229	246	260	-	253	272	287	-	
LO PR	57	61	66	-	60	64	70	-	63	67	73	-	66	70	76	-	69	73	80	-	71	76	83	-		
75	1913	MBh	55.8	57.5	62.2	66.7	54.5	56.1	60.7	65.2	53.2	54.8	59.3	63.6	51.9	53.4	57.9	62.1	49.3	50.8	55.0	59.0	45.7	47.0	50.9	54.6
		S/T	0.82	0.73	0.55	0.36	0.85	0.76	0.57	0.37	0.87	0.78	0.59	0.38	0.90	0.80	0.61	0.39	0.93	0.83	0.63	0.41	0.94	0.84	0.64	0.41
		Delta T	22	20	17	11	22	20	17	12	22	20	17	12	22	21	17	12	22	20	17	12	21	19	16	11
		KW	3.98	4.06	4.18	4.30	4.26	4.34	4.47	4.60	4.50	4.59	4.73	4.87	4.72	4.81	4.95	5.11	4.90	5.00	5.15	5.31	5.05	5.16	5.32	5.48
		AMPS	13.8	14.1	14.5	15.1	14.9	15.2	15.7	16.3	16.1	16.5	17.1	17.7	17.3	17.7	18.3	19.0	18.4	18.8	19.4	20.2	19.5	19.9	20.6	21.4
		HI PR	147	158	167	174	165	178	188	196	188	202	213	223	214	230	243	254	241	259	273	285	266	286	302	315
	LO PR	60	64	70	74	63	67	74	78	66	70	77	82	69	74	80	86	73	77	84	90	75	80	87	93	
	1700	MBh	54.2	55.8	60.4	64.8	52.9	54.5	59.0	63.3	51.7	53.2	57.6	61.8	50.4	51.9	56.2	60.3	47.9	49.3	53.4	57.3	44.4	45.7	49.4	53.0
		S/T	0.78	0.70	0.53	0.34	0.81	0.72	0.55	0.35	0.83	0.74	0.56	0.36	0.86	0.77	0.58	0.37	0.89	0.80	0.60	0.39	0.90	0.80	0.61	0.39
		Delta T	23	21	17	12	23	21	17	12	23	21	17	12	23	21	18	12	23	21	17	12	22	20	16	11
		KW	3.96	4.03	4.15	4.26	4.23	4.31	4.44	4.57	4.47	4.56	4.69	4.83	4.68	4.77	4.92	5.07	4.86	4.96	5.11	5.27	5.02	5.12	5.27	5.44
		AMPS	13.6	14.0	14.4	14.9	14.7	15.1	15.6	16.2	16.0	16.4	16.9	17.6	17.1	17.5	18.1	18.8	18.2	18.6	19.3	20.0	19.3	19.8	20.4	21.2
HI PR		146	157	166	173	164	176	186	194	186	200	211	220	212	228	241	251	238	256	271	282	263	283	299	312	
LO PR	59	63	69	74	63	67	73	78	65	69	76	81	69	73	80	85	72	76	83	89	74	79	86	92		
1488	MBh	50.0	51.5	55.7	59.8	48.8	50.3	54.4	58.4	47.7	49.1	53.1	57.0	46.5	47.9	51.8	55.6	44.2	45.5	49.3	52.9	40.9	42.1	45.6	49.0	
	S/T	0.75	0.67	0.51	0.33	0.78	0.70	0.53	0.34	0.80	0.72	0.54	0.35	0.83	0.74	0.56	0.36	0.86	0.77	0.58	0.37	0.86	0.77	0.59	0.38	
	Delta T	23	21	18	12	24	22	18	12	24	22	18	12	24	22	18	12	23	22	18	12	22	20	16	11	
	KW	3.87	3.94	4.06	4.17	4.14	4.22	4.34	4.46	4.37	4.45	4.58	4.72	4.57	4.67	4.80	4.95	4.75	4.84	4.99	5.14	4.90	5.00	5.15	5.31	
	AMPS	13.3	13.6	14.0	14.5	14.3	14.7	15.2	15.7	15.6	15.9	16.5	17.1	16.6	17.0	17.6	18.3	17.7	18.1	18.7	19.4	18.7	19.2	19.8	20.6	
	HI PR	141	152	161	168	159	171	180	188	180	194	205	214	205	221	233	243	231	249	263	274	255	275	290	303	
LO PR	58	61	67	71	61	65	71	75	63	67	74	78	67	71	77	82	70	74	81	86	72	77	84	89		

* Entering Indoor Dry Bulb Temperature

NOTE: Shaded area is ACCA (TVA) conditions

COOLING PERFORMANCE DATA

GSC130601B*

EXPANDED PERFORMANCE DATA

COOLING OPERATION

MODEL: GSC130601B* / CAUF4860C6A

IDB*	Airflow	Outdoor Ambient Temperature																								
		65				75				85				95				105				115				
		59	63	67	71	59	63	67	71	59	63	67	71	59	63	67	71	59	63	67	71	59	63	67	71	
80	1913	MBh	56.8	58.0	62.0	66.3	55.5	56.7	60.6	64.7	54.2	55.3	59.1	63.2	52.8	54.0	57.7	61.7	50.2	51.3	54.8	58.6	46.5	47.5	50.8	54.3
		S/T	0.90	0.84	0.69	0.51	0.93	0.87	0.71	0.53	0.95	0.89	0.73	0.54	1.00	0.92	0.75	0.56	1.00	0.96	0.78	0.58	1.00	0.97	0.79	0.59
		Delta T	25	23	20	16	25	24	21	17	25	24	21	17	25	24	21	17	24	24	21	16	22	22	19	15
		KW	4.01	4.09	4.21	4.33	4.29	4.37	4.50	4.64	4.54	4.63	4.76	4.91	4.75	4.85	4.99	5.15	4.93	5.04	5.19	5.35	5.09	5.20	5.36	5.53
		AMPS	13.9	14.2	14.7	15.2	15.0	15.4	15.9	16.5	16.3	16.7	17.2	17.9	17.4	17.8	18.4	19.1	18.5	19.0	19.6	20.4	19.6	20.1	20.8	21.6
		HIPR	149	160	169	176	167	180	190	198	190	204	216	225	216	233	246	256	243	262	276	288	269	289	305	318
		LOPR	61	65	70	75	64	68	74	79	67	71	77	82	70	74	81	87	73	78	85	91	76	81	88	94
		MBh	55.1	56.3	60.2	64.4	53.9	55.0	58.8	62.9	52.6	53.7	57.4	61.4	51.3	52.4	56.0	59.9	48.7	49.8	53.2	56.9	45.1	46.1	49.3	52.7
		S/T	0.86	0.80	0.65	0.49	0.89	0.83	0.68	0.51	0.91	0.85	0.69	0.52	0.94	0.88	0.72	0.54	0.97	0.91	0.74	0.56	0.98	0.92	0.75	0.56
		Delta T	26	24	21	17	26	25	22	17	26	25	22	17	26	25	22	17	26	25	21	17	24	23	20	16
KW	3.98	4.06	4.18	4.30	4.26	4.34	4.47	4.60	4.50	4.59	4.73	4.87	4.72	4.81	4.96	5.11	4.90	5.00	5.15	5.31	5.05	5.16	5.32	5.48		
AMPS	13.8	14.1	14.5	15.1	14.9	15.2	15.7	16.3	16.1	16.5	17.1	17.7	17.3	17.7	18.3	19.0	18.4	18.8	19.4	20.2	19.5	19.9	20.6	21.4		
HIPR	147	158	167	174	165	178	188	196	188	202	213	223	214	230	243	254	241	259	273	285	266	286	302	315		
LOPR	60	64	70	74	63	68	74	78	66	70	77	82	69	74	80	86	73	77	84	90	75	80	87	93		
MBh	50.9	52.0	55.6	59.4	49.7	50.8	54.3	58.0	48.5	49.6	53.0	56.6	47.3	48.4	51.7	55.3	45.0	46.0	49.1	52.5	41.7	42.6	45.5	48.6		
S/T	0.83	0.77	0.63	0.47	0.86	0.80	0.65	0.49	0.88	0.82	0.67	0.50	0.91	0.85	0.69	0.52	0.94	0.88	0.72	0.54	0.95	0.89	0.72	0.54		
Delta T	26	25	22	17	26	25	22	18	26	25	22	18	27	25	22	18	26	25	22	17	24	23	20	16		
KW	3.90	3.97	4.08	4.20	4.17	4.25	4.37	4.50	4.40	4.49	4.62	4.76	4.61	4.70	4.84	4.99	4.78	4.88	5.03	5.18	4.94	5.04	5.19	5.35		
AMPS	13.4	13.7	14.1	14.7	14.5	14.8	15.3	15.9	15.7	16.1	16.6	17.2	16.8	17.2	17.8	18.4	17.9	18.3	18.9	19.6	18.9	19.4	20.0	20.8		
HIPR	143	154	162	169	160	172	182	190	182	196	207	216	208	223	236	246	233	251	265	277	258	278	293	306		
LOPR	58	62	68	72	62	65	71	76	64	68	74	79	67	71	78	83	70	75	82	87	73	77	85	90		

85	1913	MBh	57.8	58.9	61.7	65.8	56.4	57.5	60.3	64.3	55.1	56.2	58.8	62.8	53.8	54.8	57.4	61.2	51.1	52.1	54.5	58.2	47.3	48.2	50.5	53.9
		S/T	0.94	0.91	0.82	0.67	0.98	0.94	0.85	0.69	1.00	0.97	0.87	0.71	1.00	1.00	0.90	0.73	1.00	1.00	0.93	0.76	1.00	1.00	0.94	0.76
		Delta T	26	26	24	21	26	26	25	21	26	26	25	21	26	26	25	21	25	25	24	21	23	23	23	20
		KW	4.04	4.12	4.24	4.36	4.32	4.41	4.53	4.67	4.57	4.66	4.80	4.94	4.79	4.88	5.03	5.19	4.97	5.07	5.23	5.39	5.13	5.24	5.40	5.57
		AMPS	14.0	14.3	14.8	15.4	15.1	15.5	16.0	16.6	16.4	16.8	17.4	18.1	17.6	18.0	18.6	19.3	18.7	19.2	19.8	20.6	19.8	20.3	21.0	21.8
		HIPR	150	162	171	178	168	181	191	200	192	206	218	227	218	235	248	259	246	264	279	291	271	292	308	322
		LOPR	61	65	71	76	65	69	75	80	67	72	78	83	71	75	82	87	74	79	86	92	77	81	89	95
		MBh	56.1	57.2	59.9	63.9	54.8	55.9	58.5	62.4	53.5	54.5	57.1	60.9	52.2	53.2	55.7	59.4	49.6	50.5	52.9	56.5	45.9	46.8	49.0	52.3
		S/T	0.90	0.87	0.78	0.63	0.93	0.90	0.81	0.66	0.95	0.92	0.83	0.67	0.98	0.95	0.86	0.70	1.00	0.99	0.89	0.72	1.00	0.99	0.90	0.73
		Delta T	27	27	25	22	28	27	26	22	28	27	26	22	28	27	26	22	27	27	25	22	25	25	24	21
KW	4.01	4.09	4.21	4.33	4.29	4.37	4.50	4.64	4.54	4.63	4.76	4.91	4.75	4.85	4.99	5.15	4.93	5.04	5.19	5.35	5.09	5.20	5.36	5.53		
AMPS	13.9	14.2	14.7	15.2	15.0	15.4	15.9	16.5	16.3	16.7	17.2	17.9	17.4	17.8	18.4	19.1	18.5	19.0	19.6	20.4	19.6	20.1	20.8	21.6		
HIPR	149	160	169	176	167	180	190	198	190	204	216	225	216	233	246	256	243	262	276	288	269	289	305	318		
LOPR	61	65	70	75	64	68	74	79	67	71	77	82	70	74	81	87	73	78	85	91	76	81	88	94		
MBh	51.8	52.8	55.3	59.0	50.6	51.6	54.0	57.6	49.4	50.3	52.7	56.2	48.2	49.1	51.4	54.9	45.8	46.7	48.9	52.1	42.4	43.2	45.3	48.3		
S/T	0.87	0.84	0.75	0.61	0.90	0.87	0.78	0.63	0.92	0.89	0.80	0.65	0.95	0.92	0.83	0.67	0.99	0.95	0.86	0.70	0.99	0.96	0.87	0.70		
Delta T	28	27	26	22	28	28	26	23	28	28	26	23	28	28	26	23	28	27	26	22	26	26	24	21		
KW	3.93	4.00	4.11	4.23	4.20	4.28	4.40	4.53	4.43	4.52	4.65	4.79	4.64	4.74	4.88	5.03	4.82	4.92	5.07	5.22	4.97	5.08	5.23	5.40		
AMPS	13.5	13.8	14.3	14.8	14.6	14.9	15.4	16.0	15.8	16.2	16.8	17.4	16.9	17.3	17.9	18.6	18.0	18.5	19.1	19.8	19.1	19.6	20.2	21.0		
HIPR	144	155	164	171	162	174	184	192	184	198	209	218	210	226	238	248	236	254	268	279	261	280	296	309		
LOPR	59	63	68	73	62	66	72	77	65	69	75	80	68	72	79	84	71	76	83	88	74	78	85	91		

* Entering Indoor Dry Bulb Temperature

NOTE: Shaded area is AHRI Rating Conditions

COOLING PERFORMANCE DATA

GSC130601C*

EXPANDED PERFORMANCE DATA

COOLING OPERATION

MODEL: GSC130601C* / CA*F4961*6A*

IDB*	Airflow	Outdoor Ambient Temperature																								
		65				75				85				95				105				115				
		59	63	67	71	59	63	67	71	59	63	67	71	59	63	67	71	59	63	67	71	59	63	67	71	
70	1600	MBh	50.1	51.9	56.8	-	48.9	50.7	55.5	-	47.7	49.5	54.2	-	46.6	48.3	52.9	-	44.2	45.8	50.2	-	41.0	42.5	46.5	-
		S/T	0.67	0.56	0.39	-	0.70	0.58	0.40	-	0.72	0.60	0.41	-	0.74	0.62	0.43	-	0.77	0.64	0.44	-	0.77	0.65	0.45	-
		Delta T	19	17	13	-	20	17	13	-	20	17	13	-	20	17	13	-	20	17	13	-	18	16	12	-
		KW	3.79	3.86	3.98	-	4.06	4.15	4.27	-	4.31	4.40	4.53	-	4.52	4.61	4.76	-	4.70	4.80	4.95	-	4.86	4.96	5.12	-
		AMPS	13.7	14.0	14.5	-	14.8	15.2	15.7	-	16.1	16.5	17.0	-	17.2	17.6	18.2	-	18.3	18.8	19.4	-	19.4	19.9	20.6	-
		LO PR	141	152	160	-	158	170	180	-	180	194	205	-	205	221	233	-	231	248	262	-	255	274	290	-
70	1900	MBh	60	63	69	-	63	67	73	-	66	70	76	-	69	73	80	-	72	77	84	-	75	79	87	-
		S/T	0.70	0.58	0.40	-	0.72	0.61	0.42	-	0.74	0.62	0.43	-	0.77	0.64	0.44	-	0.80	0.66	0.46	-	0.80	0.67	0.46	-
		Delta T	18	16	12	-	19	16	12	-	19	16	12	-	19	16	12	-	18	16	12	-	17	15	11	-
		KW	3.88	3.95	4.07	-	4.16	4.24	4.37	-	4.41	4.50	4.64	-	4.63	4.73	4.88	-	4.82	4.92	5.08	-	4.98	5.09	5.25	-
		AMPS	14.1	14.4	14.9	-	15.2	15.6	16.1	-	16.5	17.0	17.5	-	17.7	18.1	18.7	-	18.8	19.3	20.0	-	20.0	20.5	21.2	-
		LO PR	146	157	165	-	163	176	186	-	186	200	211	-	212	228	240	-	238	256	270	-	263	283	299	-
70	2000	MBh	62	65	71	-	65	69	75	-	68	72	78	-	71	75	82	-	74	79	86	-	77	82	89	-
		S/T	0.71	0.60	0.41	-	0.74	0.62	0.43	-	0.76	0.63	0.44	-	0.78	0.65	0.45	-	0.81	0.68	0.47	-	0.82	0.68	0.47	-
		Delta T	18	16	12	-	18	16	12	-	18	16	12	-	18	16	12	-	18	16	12	-	17	15	11	-
		KW	3.89	3.96	4.08	-	4.17	4.25	4.39	-	4.42	4.51	4.65	-	4.64	4.74	4.89	-	4.83	4.93	5.09	-	4.99	5.10	5.26	-
		AMPS	14.1	14.5	14.9	-	15.3	15.6	16.2	-	16.6	17.0	17.6	-	17.7	18.2	18.8	-	18.9	19.4	20.0	-	20.0	20.5	21.2	-
		LO PR	146	157	166	-	164	176	186	-	186	200	212	-	212	228	241	-	239	257	271	-	264	284	300	-

75	1600	MBh	50.9	52.4	56.7	60.9	49.7	51.2	55.4	59.5	48.5	50.0	54.1	58.1	47.3	48.8	52.8	56.6	45.0	46.3	50.1	53.8	41.7	42.9	46.4	49.8
		S/T	0.77	0.69	0.52	0.33	0.79	0.71	0.54	0.35	0.81	0.73	0.55	0.35	0.84	0.75	0.57	0.37	0.87	0.78	0.59	0.38	0.88	0.79	0.60	0.38
		Delta T	22	21	17	12	23	21	17	12	23	21	17	12	23	21	17	12	23	21	17	12	21	19	16	11
		KW	3.82	3.89	4.01	4.13	4.10	4.18	4.31	4.44	4.34	4.43	4.57	4.71	4.56	4.65	4.80	4.95	4.74	4.84	4.99	5.16	4.90	5.00	5.16	5.33
		AMPS	13.8	14.1	14.6	15.2	14.9	15.3	15.8	16.4	16.2	16.6	17.2	17.8	17.4	17.8	18.4	19.1	18.5	18.9	19.6	20.3	19.6	20.1	20.8	21.6
		LO PR	143	153	162	169	160	172	182	190	182	196	207	216	207	223	236	246	233	251	265	276	258	277	293	305
75	1900	MBh	55.1	56.8	61.5	66.0	53.9	55.5	60.0	64.4	52.6	54.1	58.6	62.9	51.3	52.8	57.2	61.4	48.7	50.2	54.3	58.3	45.1	46.5	50.3	54.0
		S/T	0.79	0.71	0.54	0.35	0.82	0.74	0.56	0.36	0.84	0.76	0.57	0.37	0.87	0.78	0.59	0.38	0.90	0.81	0.61	0.39	0.91	0.82	0.62	0.40
		Delta T	21	20	16	11	21	20	16	11	21	20	16	11	22	20	16	11	21	20	16	11	20	18	15	10
		KW	3.91	3.99	4.10	4.23	4.19	4.28	4.41	4.55	4.44	4.54	4.68	4.83	4.67	4.77	4.92	5.07	4.86	4.96	5.12	5.28	5.02	5.13	5.29	5.47
		AMPS	14.2	14.5	15.0	15.6	15.4	15.7	16.3	16.9	16.7	17.1	17.7	18.4	17.9	18.3	18.9	19.6	19.0	19.5	20.2	20.9	20.2	20.7	21.4	22.2
		LO PR	147	158	167	174	165	178	187	196	188	202	213	222	214	230	243	253	240	259	273	285	266	286	302	315
75	2000	MBh	55.7	57.3	62.1	66.6	54.4	56.0	60.6	65.1	53.1	54.7	59.2	63.5	51.8	53.3	57.7	62.0	49.2	50.7	54.9	58.9	45.6	46.9	50.8	54.5
		S/T	0.81	0.73	0.55	0.35	0.84	0.75	0.57	0.37	0.86	0.77	0.58	0.38	0.89	0.80	0.60	0.39	0.92	0.83	0.62	0.40	0.93	0.83	0.63	0.41
		Delta T	21	19	16	11	21	19	16	11	21	19	16	11	21	20	16	11	21	19	16	11	20	18	15	10
		KW	3.92	3.99	4.11	4.24	4.20	4.29	4.42	4.56	4.45	4.55	4.69	4.84	4.68	4.78	4.93	5.09	4.87	4.97	5.13	5.30	5.03	5.14	5.31	5.48
		AMPS	14.2	14.6	15.1	15.6	15.4	15.8	16.3	16.9	16.8	17.2	17.7	18.4	17.9	18.4	19.0	19.7	19.1	19.6	20.2	21.0	20.2	20.7	21.4	22.3
		LO PR	147	159	168	175	165	178	188	196	188	203	214	223	214	231	244	254	241	259	274	286	266	287	303	316

* Entering Indoor Dry Bulb Temperature

NOTE: Shaded area is AOCA (TVA) conditions

COOLING PERFORMANCE DATA

GSC130601C*

EXPANDED PERFORMANCE DATA

COOLING OPERATION

MODEL: GSC130601C* / CA*F4961*6A*

IDB*	Airflow	Outdoor Ambient Temperature																								
		65				75				85				95				105				115				
		59	63	67	71	59	63	67	71	59	63	67	71	59	63	67	71	59	63	67	71	59	63	67	71	
80	1600	MBh	51.8	52.9	56.6	60.5	50.6	51.7	55.2	59.1	49.4	50.5	53.9	57.6	48.2	49.2	52.6	56.2	45.8	46.8	50.0	53.4	42.4	43.3	46.3	49.5
		S/T	0.84	0.79	0.64	0.48	0.87	0.82	0.67	0.50	0.89	0.84	0.68	0.51	0.92	0.86	0.70	0.53	0.96	0.90	0.73	0.55	0.97	0.91	0.74	0.55
		Delta T	25	24	21	17	25	24	21	17	25	24	21	17	26	24	21	17	25	24	21	17	24	23	20	16
		KW	3.85	3.92	4.04	4.16	4.13	4.21	4.34	4.48	4.37	4.47	4.60	4.75	4.59	4.69	4.84	4.99	4.78	4.88	5.03	5.20	4.94	5.04	5.21	5.38
		AMPS	13.9	14.3	14.8	15.3	15.1	15.4	16.0	16.6	16.4	16.8	17.4	18.0	17.5	18.0	18.6	19.3	18.7	19.1	19.8	20.5	19.8	20.3	21.0	21.8
	1900	HIPR	144	155	164	171	162	174	184	192	184	198	209	218	209	225	238	248	236	253	268	279	260	280	296	308
		LO PR	61	65	71	75	64	68	75	80	67	71	78	83	70	75	82	87	74	78	85	91	76	81	88	94
		MBh	56.1	57.4	61.3	65.5	54.8	56.0	59.9	64.0	53.5	54.7	58.4	62.5	52.2	53.4	57.0	60.9	49.6	50.7	54.2	57.9	45.9	46.9	50.2	53.6
		S/T	0.87	0.82	0.67	0.50	0.90	0.85	0.69	0.52	0.93	0.87	0.71	0.53	0.96	0.90	0.73	0.55	0.99	0.93	0.76	0.57	1.00	0.94	0.76	0.57
		Delta T	24	23	20	16	24	23	20	16	24	23	20	16	24	23	20	16	24	23	20	16	22	21	19	15
2000	KW	3.94	4.02	4.14	4.26	4.22	4.31	4.44	4.58	4.48	4.57	4.72	4.87	4.70	4.80	4.96	5.12	4.90	5.00	5.16	5.33	5.06	5.17	5.34	5.51	
	AMPS	14.3	14.7	15.2	15.7	15.5	15.9	16.4	17.0	16.9	17.3	17.9	18.5	18.0	18.5	19.1	19.8	19.2	19.7	20.3	21.1	20.4	20.9	21.6	22.4	
	HIPR	149	160	169	177	167	179	189	198	190	204	215	225	216	232	245	256	243	261	276	288	268	289	305	318	
	LO PR	63	67	73	78	66	71	77	82	69	73	80	85	72	77	84	90	76	81	88	94	78	84	91	97	
	MBh	56.7	57.9	61.9	66.2	55.4	56.6	60.4	64.6	54.1	55.2	59.0	63.1	52.7	53.9	57.6	61.5	50.1	51.2	54.7	58.5	46.4	47.4	50.7	54.2	

85	1600	MBh	52.7	53.7	56.3	60.0	51.5	52.5	55.0	58.6	50.3	51.2	53.7	57.2	49.0	50.0	52.3	55.8	46.6	47.5	49.7	53.1	43.1	44.0	46.1	49.1
		S/T	0.88	0.85	0.77	0.62	0.91	0.88	0.80	0.65	0.94	0.90	0.82	0.66	0.97	0.93	0.84	0.68	1.00	0.97	0.87	0.71	1.00	0.98	0.88	0.71
		Delta T	27	26	25	21	27	27	25	22	27	27	25	22	27	27	25	22	27	26	25	22	25	25	23	20
		KW	3.88	3.95	4.07	4.20	4.16	4.24	4.37	4.51	4.41	4.50	4.64	4.79	4.63	4.73	4.88	5.03	4.82	4.92	5.08	5.24	4.98	5.08	5.25	5.42
		AMPS	14.1	14.4	14.9	15.4	15.2	15.6	16.1	16.7	16.5	17.0	17.5	18.2	17.7	18.1	18.7	19.5	18.8	19.3	20.0	20.7	20.0	20.5	21.2	22.0
	1900	HIPR	145	157	165	172	163	176	186	194	186	200	211	220	211	228	240	251	238	256	270	282	263	283	299	312
		LO PR	62	65	71	76	65	69	75	80	68	72	78	84	71	75	82	88	74	79	86	92	77	82	89	95
		MBh	57.1	58.2	61.0	65.0	55.8	56.9	59.6	63.5	54.5	55.5	58.1	62.0	53.1	54.2	56.7	60.5	50.5	51.4	53.9	57.5	46.7	47.7	49.9	53.2
		S/T	0.91	0.88	0.80	0.65	0.95	0.91	0.82	0.67	0.97	0.94	0.85	0.69	1.00	0.97	0.87	0.71	1.00	1.00	0.91	0.74	1.00	1.00	0.91	0.74
		Delta T	25	25	23	20	26	25	24	21	26	25	24	21	26	25	24	21	24	25	24	20	23	23	22	19
2000	KW	3.97	4.05	4.17	4.30	4.26	4.35	4.48	4.62	4.51	4.61	4.75	4.91	4.74	4.84	5.00	5.16	4.94	5.04	5.20	5.37	5.10	5.21	5.38	5.56	
	AMPS	14.5	14.8	15.3	15.9	15.6	16.0	16.6	17.2	17.0	17.4	18.0	18.7	18.2	18.6	19.3	20.0	19.4	19.9	20.5	21.3	20.5	21.1	21.8	22.6	
	HIPR	150	161	170	178	168	181	191	199	191	206	218	227	218	235	248	258	245	264	279	291	271	292	308	321	
	LO PR	63	67	74	78	67	71	78	83	70	74	81	86	73	78	85	90	77	82	89	95	79	84	92	98	
	MBh	57.7	58.8	61.6	65.7	56.3	57.4	60.1	64.2	55.0	56.1	58.7	62.6	53.7	54.7	57.3	61.1	51.0	52.0	54.4	58.1	47.2	48.1	50.4	53.8	

* Entering Indoor Dry Bulb Temperature

NOTE: Shaded area is AHRI Rating Conditions

COOLING PERFORMANCE DATA

GSC130363A*

EXPANDED PERFORMANCE DATA

COOLING OPERATION

MODEL: GSC130363A* / CA*F3636*6**+EEP

IDB*	Airflow	Outdoor Ambient Temperature																								
		65				75				85				95				105				115				
		59	63	67	71	59	63	67	71	59	63	67	71	59	63	67	71	59	63	67	71	59	63	67	71	
70	1434	MBh	34.3	35.5	38.9	-	33.5	34.7	38.0	-	32.7	33.9	37.1	-	31.9	33.1	36.2	-	30.3	31.4	34.4	-	28.1	29.1	31.9	-
		S/T	0.75	0.63	0.43	-	0.78	0.65	0.45	-	0.80	0.67	0.46	-	0.82	0.69	0.48	-	0.85	0.71	0.49	-	0.86	0.72	0.50	-
		Delta T	16	14	11	-	17	14	11	-	17	14	11	-	17	15	11	-	17	14	11	-	15	13	10	-
		KW	2.27	2.32	2.40	-	2.46	2.52	2.61	-	2.64	2.70	2.80	-	2.79	2.86	2.96	-	2.92	2.99	3.10	-	3.03	3.11	3.22	-
		AMPS	7.5	7.6	7.9	-	8.1	8.3	8.5	-	8.8	9.0	9.3	-	9.4	9.6	9.9	-	10.0	10.2	10.6	-	10.6	10.8	11.2	-
		HI PR	137	148	156	-	154	166	175	-	175	188	199	-	199	215	227	-	224	241	255	-	248	267	282	-
		LO PR	63	67	73	-	67	71	78	-	69	74	81	-	73	78	85	-	76	81	89	-	79	84	92	-
		MBh	33.3	34.5	37.8	-	32.5	33.7	36.9	-	31.7	32.9	36.1	-	31.0	32.1	35.2	-	29.4	30.5	33.4	-	27.3	28.3	31.0	-
		S/T	0.71	0.60	0.41	-	0.74	0.62	0.43	-	0.76	0.63	0.44	-	0.78	0.65	0.45	-	0.81	0.68	0.47	-	0.82	0.69	0.47	-
		Delta T	17	15	11	-	17	15	11	-	17	15	11	-	18	15	12	-	17	15	11	-	16	14	11	-
KW	2.25	2.30	2.38	-	2.44	2.50	2.59	-	2.61	2.68	2.77	-	2.77	2.83	2.94	-	2.89	2.97	3.07	-	3.01	3.08	3.19	-		
AMPS	7.4	7.6	7.8	-	8.0	8.2	8.5	-	8.7	8.9	9.2	-	9.3	9.5	9.8	-	9.9	10.1	10.5	-	10.5	10.7	11.1	-		
HI PR	136	146	154	-	152	164	173	-	173	187	197	-	197	212	224	-	222	239	252	-	245	264	279	-		
LO PR	63	67	73	-	66	70	77	-	69	73	80	-	72	77	84	-	76	80	88	-	78	83	91	-		
75	1434	MBh	34.9	35.9	38.9	41.7	34.1	35.1	38.0	40.7	33.3	34.2	37.1	39.8	32.4	33.4	36.2	38.8	30.8	31.7	34.4	36.9	28.6	29.4	31.8	34.2
		S/T	0.85	0.76	0.58	0.37	0.88	0.79	0.60	0.38	0.91	0.81	0.61	0.39	0.93	0.84	0.63	0.41	0.97	0.87	0.66	0.42	0.98	0.87	0.66	0.43
		Delta T	19	18	14	10	19	18	15	10	19	18	15	10	19	18	15	10	19	18	14	10	18	16	14	9
		KW	2.29	2.34	2.43	2.51	2.49	2.55	2.64	2.73	2.66	2.73	2.83	2.93	2.82	2.89	2.99	3.10	2.95	3.02	3.13	3.25	3.06	3.14	3.25	3.37
		AMPS	7.5	7.7	8.0	8.3	8.1	8.3	8.6	8.9	8.8	9.1	9.4	9.7	9.5	9.7	10.0	10.4	10.1	10.3	10.7	11.1	10.7	10.9	11.3	11.7
		HI PR	139	149	157	164	155	167	177	184	177	190	201	210	201	217	229	239	227	244	257	269	250	269	284	297
		LO PR	64	68	74	79	67	72	78	83	70	75	81	87	74	78	86	91	77	82	90	95	80	85	93	99
		MBh	33.9	34.9	37.7	40.5	33.1	34.1	36.9	39.6	32.3	33.2	36.0	38.6	31.5	32.4	35.1	37.7	29.9	30.8	33.3	35.8	27.7	28.5	30.9	33.2
		S/T	0.81	0.73	0.55	0.35	0.84	0.75	0.57	0.37	0.86	0.77	0.58	0.38	0.89	0.80	0.60	0.39	0.92	0.83	0.63	0.40	0.93	0.83	0.63	0.41
		Delta T	20	18	15	10	20	18	15	10	20	19	15	10	20	19	15	11	20	18	15	10	19	17	14	10
KW	2.27	2.32	2.40	2.49	2.46	2.52	2.61	2.71	2.64	2.70	2.80	2.90	2.79	2.86	2.96	3.07	2.92	2.99	3.10	3.22	3.03	3.11	3.22	3.34		
AMPS	7.5	7.7	7.9	8.2	8.1	8.3	8.5	8.9	8.8	9.0	9.3	9.6	9.4	9.6	9.9	10.3	10.0	10.2	10.6	11.0	10.6	10.8	11.2	11.6		
HI PR	137	148	156	163	154	166	175	182	175	188	199	208	199	215	227	236	224	241	255	266	248	267	282	294		
LO PR	63	67	73	78	67	71	78	83	69	74	81	86	73	78	85	90	76	81	89	95	79	84	92	98		
75	1116	MBh	31.3	32.2	34.8	37.4	30.5	31.4	34.0	36.5	29.8	30.7	33.2	35.6	29.1	29.9	32.4	34.8	27.6	28.4	30.8	33.0	25.6	26.3	28.5	30.6
		S/T	0.78	0.70	0.53	0.34	0.81	0.73	0.55	0.35	0.83	0.74	0.56	0.36	0.86	0.77	0.58	0.37	0.89	0.80	0.60	0.39	0.90	0.80	0.61	0.39
		Delta T	20	19	15	11	20	19	15	11	20	19	15	11	21	19	16	11	20	19	15	11	19	17	14	10
		KW	2.21	2.26	2.34	2.42	2.40	2.45	2.54	2.63	2.57	2.63	2.72	2.82	2.71	2.78	2.88	2.99	2.84	2.91	3.02	3.13	2.95	3.02	3.13	3.25
		AMPS	7.3	7.4	7.7	8.0	7.9	8.0	8.3	8.6	8.5	8.7	9.0	9.4	9.1	9.3	9.6	10.0	9.7	9.9	10.3	10.7	10.3	10.5	10.9	11.3
		HI PR	133	143	151	158	149	161	170	177	170	183	193	201	193	208	220	229	218	234	247	258	240	259	273	285
		LO PR	61	65	71	76	65	69	75	80	67	72	78	83	71	75	82	87	74	79	86	92	77	82	89	95

* Entering Indoor Dry Bulb Temperature NOTE: Shaded area is ACOA (TVA) conditions

COOLING PERFORMANCE DATA

GSC130363A*

EXPANDED PERFORMANCE DATA

COOLING OPERATION

MODEL: GSC130363A*/CA*F3636**6**+EEP

IDB*	Airflow	Outdoor Ambient Temperature																								
		65				75				85				95				105				115				
		59	63	67	71	59	63	67	71	59	63	67	71	59	63	67	71	59	63	67	71	59	63	67	71	
80	1434	MBh	35.5	36.3	38.8	41.4	34.7	35.4	37.9	40.5	33.8	34.6	37.0	39.5	33.0	33.7	36.1	38.5	31.4	32.1	34.2	36.6	29.1	29.7	31.7	33.9
		S/T	0.93	0.88	0.71	0.53	0.97	0.91	0.74	0.55	1.00	0.93	0.76	0.57	1.00	0.96	0.78	0.58	1.00	1.00	0.81	0.61	1.00	1.00	0.82	0.61
		Delta T	21	20	18	14	22	21	18	14	22	21	18	14	21	21	18	14	20	21	18	14	19	19	17	13
		KW	2.31	2.36	2.45	2.54	2.51	2.57	2.66	2.76	2.69	2.75	2.85	2.96	2.84	2.91	3.02	3.13	2.98	3.05	3.16	3.28	3.09	3.17	3.28	3.40
		AMPS	7.6	7.8	8.0	8.3	8.2	8.4	8.7	9.0	8.9	9.1	9.5	9.8	9.5	9.8	10.1	10.5	10.2	10.4	10.8	11.2	10.8	11.0	11.4	11.8
	1275	HI PR	140	151	159	166	157	169	178	186	179	192	203	212	203	219	231	241	229	246	260	271	253	272	287	300
		LO PR	64	69	75	80	68	72	79	84	71	75	82	88	74	79	86	92	78	83	91	96	81	86	94	100
		MBh	34.5	35.2	37.6	40.2	33.7	34.4	36.8	39.3	32.9	33.6	35.9	38.4	32.1	32.8	35.0	37.4	30.5	31.1	33.3	35.5	28.2	28.8	30.8	32.9
		S/T	0.89	0.84	0.68	0.51	0.92	0.87	0.70	0.53	0.95	0.89	0.72	0.54	0.98	0.92	0.75	0.56	1.00	0.95	0.77	0.58	1.00	0.96	0.78	0.58
		Delta T	22	21	18	15	22	21	19	15	22	22	19	15	23	22	19	15	22	21	19	15	20	20	17	14
1116	KW	2.29	2.34	2.43	2.51	2.49	2.55	2.64	2.73	2.66	2.73	2.83	2.93	2.82	2.89	2.99	3.10	2.95	3.02	3.13	3.25	3.06	3.14	3.25	3.37	
	AMPS	7.5	7.7	8.0	8.3	8.1	8.3	8.6	8.9	8.8	9.1	9.4	9.7	9.5	9.7	10.0	10.4	10.1	10.3	10.7	11.1	10.7	10.9	11.3	11.7	
	HI PR	139	149	157	164	156	167	177	184	177	190	201	210	201	217	229	239	227	244	258	269	250	269	285	297	
	LO PR	64	68	74	79	67	72	78	83	70	75	81	87	74	78	86	91	77	82	90	96	80	85	93	99	
	MBh	31.8	32.5	34.7	37.1	31.1	31.7	33.9	36.3	30.3	31.0	33.1	35.4	29.6	30.2	32.3	34.5	28.1	28.7	30.7	32.8	26.0	26.6	28.4	30.4	

85	1434	MBh	36.1	36.8	38.6	41.1	35.3	36.0	37.7	40.2	34.4	35.1	36.8	39.2	33.6	34.2	35.9	38.3	31.9	32.5	34.1	36.4	29.6	30.1	31.6	33.7
		S/T	0.98	0.95	0.85	0.69	1.00	0.98	0.88	0.72	1.00	1.00	0.91	0.74	1.00	1.00	0.94	0.76	1.00	1.00	0.97	0.79	1.00	1.00	0.98	0.79
		Delta T	23	22	21	18	23	23	21	18	22	23	21	18	22	22	22	19	20	21	21	18	19	19	20	17
		KW	2.33	2.38	2.47	2.56	2.53	2.59	2.69	2.78	2.71	2.78	2.88	2.98	2.87	2.94	3.05	3.16	3.00	3.08	3.19	3.31	3.12	3.20	3.31	3.44
		AMPS	7.7	7.9	8.1	8.4	8.3	8.5	8.8	9.1	9.0	9.2	9.5	9.9	9.6	9.9	10.2	10.6	10.3	10.5	10.9	11.3	10.9	11.1	11.5	11.9
	1275	HI PR	141	152	161	168	159	171	180	188	180	194	205	214	205	221	234	244	231	249	263	274	255	275	290	303
		LO PR	65	69	76	81	69	73	80	85	72	76	83	88	75	80	87	93	79	84	91	97	81	87	95	101
		MBh	35.1	35.7	37.4	39.9	34.3	34.9	36.6	39.0	33.4	34.1	35.7	38.1	32.6	33.3	34.8	37.2	31.0	31.6	33.1	35.3	28.7	29.3	30.6	32.7
		S/T	0.93	0.90	0.81	0.66	0.97	0.93	0.84	0.68	0.99	0.96	0.86	0.70	1.00	0.99	0.89	0.72	1.00	1.00	0.93	0.75	1.00	1.00	0.93	0.76
		Delta T	24	23	22	19	24	24	22	19	24	24	22	19	24	24	22	19	22	23	22	19	21	21	21	18
1116	KW	2.31	2.36	2.45	2.54	2.51	2.57	2.66	2.76	2.69	2.75	2.85	2.96	2.84	2.91	3.02	3.13	2.98	3.05	3.16	3.28	3.09	3.17	3.28	3.40	
	AMPS	7.6	7.8	8.0	8.3	8.2	8.4	8.7	9.0	8.9	9.1	9.5	9.8	9.5	9.8	10.1	10.5	10.2	10.4	10.8	11.2	10.8	11.0	11.4	11.8	
	HI PR	140	151	159	166	157	169	178	186	179	192	203	212	203	219	231	241	229	246	260	271	253	272	287	300	
	LO PR	64	69	75	80	68	72	79	84	71	75	82	88	74	79	86	92	78	83	91	96	81	86	94	100	
	MBh	32.4	33.0	34.6	36.9	31.6	32.2	33.8	36.0	30.9	31.5	32.9	35.1	30.1	30.7	32.1	34.3	28.6	29.2	30.5	32.6	26.5	27.0	28.3	30.2	

* Entering Indoor Dry Bulb Temperature

NOTE: Shaded area is AHRI Rating Conditions

COOLING PERFORMANCE DATA

GSC130363B*

EXPANDED PERFORMANCE DATA

COOLING OPERATION

MODEL: GSC130363B*/CA*F3636*6C*

IDB*	Airflow	Outdoor Ambient Temperature																								
		65				75				85				95				105				115				
		59	63	67	71	59	63	67	71	59	63	67	71	59	63	67	71	59	63	67	71	59	63	67	71	
70	1100	MBh	32.6	33.8	37.0	-	31.1	32.2	35.3	-	30.3	31.4	34.4	-	28.8	29.9	32.7	-	26.7	27.7	30.3	-	26.7	27.7	30.3	-
		S/T	0.69	0.58	0.40	-	0.74	0.61	0.43	-	0.76	0.63	0.44	-	0.79	0.66	0.46	-	0.80	0.66	0.46	-	0.80	0.66	0.46	-
		Delta T	19	16	12	-	19	17	13	-	19	17	13	-	19	16	12	-	18	15	12	-	18	15	12	-
		KW	2.34	2.38	2.45	-	2.49	2.54	2.61	-	2.62	2.67	2.75	-	2.74	2.79	2.87	-	2.84	2.89	2.98	-	2.93	2.98	3.07	-
		AMPS	6.2	6.3	6.5	-	6.6	6.8	7.0	-	7.2	7.4	7.6	-	7.7	7.9	8.1	-	8.2	8.4	8.6	-	8.6	8.8	9.1	-
		HI PR	135	145	153	-	151	163	172	-	172	185	195	-	196	211	222	-	220	237	250	-	243	262	276	-
	LO PR	60	63	69	-	63	67	73	-	65	70	76	-	69	73	80	-	72	77	84	-	75	79	87	-	
	1200	MBh	33.1	34.3	37.6	-	32.3	33.5	36.7	-	31.6	32.7	35.8	-	30.8	31.9	35.0	-	29.3	30.3	33.2	-	27.1	28.1	30.8	-
		S/T	0.72	0.60	0.42	-	0.74	0.62	0.43	-	0.76	0.64	0.44	-	0.79	0.66	0.46	-	0.82	0.68	0.47	-	0.82	0.69	0.48	-
		Delta T	18	16	12	-	18	16	12	-	18	16	12	-	19	16	12	-	18	16	12	-	17	15	11	-
		KW	2.37	2.41	2.47	-	2.52	2.57	2.64	-	2.66	2.70	2.78	-	2.77	2.83	2.91	-	2.87	2.93	3.01	-	2.96	3.02	3.11	-
		AMPS	6.3	6.4	6.6	-	6.7	6.9	7.1	-	7.3	7.5	7.7	-	7.8	8.0	8.2	-	8.3	8.5	8.8	-	8.8	9.0	9.3	-
HI PR		137	147	156	-	154	165	175	-	175	188	199	-	199	214	226	-	224	241	254	-	247	266	281	-	
LO PR	61	65	71	-	64	68	74	-	67	71	77	-	70	74	81	-	73	78	85	-	76	81	88	-		
1300	MBh	33.4	34.7	38.0	-	32.7	33.9	37.1	-	31.9	33.0	36.2	-	31.1	32.2	35.3	-	29.6	30.6	33.6	-	27.4	28.4	31.1	-	
	S/T	0.73	0.61	0.42	-	0.76	0.63	0.44	-	0.78	0.65	0.45	-	0.80	0.67	0.46	-	0.83	0.70	0.48	-	0.84	0.70	0.49	-	
	Delta T	17	15	11	-	18	15	12	-	18	15	12	-	18	15	12	-	17	15	11	-	16	14	11	-	
	KW	2.37	2.42	2.48	-	2.53	2.57	2.64	-	2.66	2.71	2.79	-	2.78	2.83	2.91	-	2.88	2.94	3.02	-	2.97	3.03	3.11	-	
	AMPS	6.3	6.4	6.6	-	6.8	6.9	7.1	-	7.3	7.5	7.7	-	7.8	8.0	8.3	-	8.3	8.5	8.8	-	8.8	9.0	9.3	-	
	HI PR	137	148	156	-	154	166	175	-	175	189	199	-	200	215	227	-	225	242	255	-	248	267	282	-	
LO PR	61	65	71	-	64	68	75	-	67	71	78	-	70	75	81	-	74	78	85	-	76	81	88	-		
75	1100	MBh	33.2	34.1	37.0	39.7	32.4	33.4	36.1	38.7	31.6	32.6	35.2	37.8	30.9	31.8	34.4	36.9	29.3	30.2	32.7	35.1	27.1	28.0	30.3	32.5
		S/T	0.79	0.70	0.53	0.34	0.82	0.73	0.55	0.36	0.84	0.75	0.57	0.36	0.86	0.77	0.58	0.38	0.90	0.80	0.61	0.39	0.90	0.81	0.61	0.39
		Delta T	22	20	16	11	22	20	17	12	22	20	17	12	22	21	17	12	22	20	17	11	21	19	15	11
		KW	2.36	2.40	2.46	2.53	2.51	2.55	2.62	2.70	2.64	2.69	2.77	2.85	2.76	2.81	2.89	2.98	2.86	2.92	3.00	3.09	2.95	3.00	3.09	3.18
		AMPS	6.2	6.4	6.6	6.8	6.7	6.9	7.1	7.3	7.3	7.4	7.7	8.0	7.8	7.9	8.2	8.5	8.2	8.4	8.7	9.0	8.7	8.9	9.2	9.6
		HI PR	136	146	155	161	153	164	173	181	174	187	197	206	198	213	225	234	222	239	253	264	246	264	279	291
	LO PR	60	64	70	74	64	68	74	79	66	70	77	82	69	74	81	86	73	77	85	90	75	80	87	93	
	1200	MBh	33.7	34.7	37.5	40.3	32.9	33.9	36.6	39.3	32.1	33.1	35.8	38.4	31.3	32.2	34.9	37.5	29.8	30.6	33.2	35.6	27.6	28.4	30.7	33.0
		S/T	0.82	0.73	0.55	0.36	0.85	0.76	0.57	0.37	0.87	0.78	0.59	0.38	0.90	0.80	0.61	0.39	0.93	0.83	0.63	0.40	0.94	0.84	0.63	0.41
		Delta T	21	19	16	11	21	20	16	11	21	20	16	11	21	20	16	11	21	20	16	11	20	18	15	10
		KW	2.38	2.43	2.49	2.56	2.54	2.59	2.66	2.73	2.67	2.72	2.80	2.88	2.79	2.85	2.93	3.01	2.90	2.95	3.04	3.13	2.98	3.04	3.13	3.22
		AMPS	6.3	6.5	6.7	6.9	6.8	7.0	7.2	7.4	7.4	7.6	7.8	8.1	7.9	8.1	8.3	8.6	8.4	8.6	8.9	9.2	8.9	9.1	9.4	9.7
HI PR		138	149	157	164	155	167	176	184	177	190	201	209	201	216	228	238	226	243	257	268	250	269	284	296	
LO PR	61	65	71	76	65	69	75	80	67	72	78	83	71	75	82	87	74	79	86	92	77	81	89	95		
1300	MBh	34.0	35.0	37.9	40.7	33.2	34.2	37.0	39.7	32.4	33.4	36.1	38.8	31.6	32.6	35.3	37.8	30.1	30.9	33.5	35.9	27.8	28.7	31.0	33.3	
	S/T	0.83	0.74	0.56	0.36	0.86	0.77	0.58	0.38	0.89	0.79	0.60	0.39	0.91	0.82	0.62	0.40	0.95	0.85	0.64	0.41	0.96	0.86	0.65	0.42	
	Delta T	20	18	15	10	20	19	15	11	20	19	15	11	20	19	15	11	20	19	15	10	19	17	14	10	
	KW	2.39	2.43	2.50	2.56	2.54	2.59	2.66	2.74	2.68	2.73	2.81	2.89	2.80	2.85	2.93	3.02	2.90	2.96	3.04	3.13	2.99	3.05	3.14	3.23	
	AMPS	6.3	6.5	6.7	6.9	6.8	7.0	7.2	7.5	7.4	7.6	7.8	8.1	7.9	8.1	8.3	8.7	8.4	8.6	8.9	9.2	8.9	9.1	9.4	9.7	
	HI PR	139	149	158	164	156	168	177	185	177	191	201	210	202	217	229	239	227	244	258	269	251	270	285	297	
LO PR	61	65	71	76	65	69	75	80	67	72	78	83	71	75	82	88	74	79	86	92	77	82	89	95		

* Entering Indoor Dry Bulb Temperature

NOTE: Shaded area is ACOA (TVA) conditions

COOLING PERFORMANCE DATA

GSC130363B*

EXPANDED PERFORMANCE DATA

COOLING OPERATION

MODEL: GSC130363B*/CA*F3636*6C*

IDB*	Airflow	Outdoor Ambient Temperature																																				
		65						75						85						95						105						115						
		59	63	67	71	75	79	59	63	67	71	75	79	59	63	67	71	75	79	59	63	67	71	75	79	59	63	67	71	75	79	59	63	67	71	75	79	
80	1100	MBh	33.8	34.5	36.8	39.4	33.0	33.7	36.0	38.5	32.2	32.9	35.1	37.6	31.4	32.1	34.3	36.6	29.8	30.5	32.6	34.8	27.6	28.2	30.2	32.2	25.2	25.8	27.8	29.8	27.6	28.2	30.2	32.2	25.2	25.8	27.8	29.8
		S/T	0.96	0.81	0.66	0.49	0.90	0.84	0.68	0.51	0.92	0.86	0.70	0.52	0.95	0.89	0.72	0.54	0.98	0.92	0.75	0.56	0.99	0.93	0.76	0.57	0.99	0.93	0.76	0.57	0.99	0.93	0.76	0.57	0.99	0.93	0.76	0.57
		Delta T	24	23	20	16	25	24	21	16	25	24	21	16	25	24	21	17	25	23	20	16	23	22	19	15	23	22	19	15	23	22	19	15	23	22	19	15
		KW	2.37	2.42	2.48	2.55	2.53	2.57	2.64	2.72	2.66	2.71	2.79	2.87	2.78	2.83	2.91	3.00	2.88	2.94	3.02	3.11	2.97	3.03	3.11	3.21	2.97	3.03	3.11	3.21	2.97	3.03	3.11	3.21	2.97	3.03	3.11	3.21
		AMPS	6.3	6.4	6.6	6.9	6.8	6.9	7.1	7.4	7.3	7.5	7.7	8.0	7.8	8.0	8.3	8.6	8.3	8.5	8.8	9.1	8.8	9.0	9.3	9.7	8.8	9.0	9.3	9.7	8.8	9.0	9.3	9.7	8.8	9.0	9.3	9.7
	LO PR	137	148	156	163	154	166	175	183	175	189	199	208	200	215	227	237	225	242	255	266	248	267	282	294	248	267	282	294	248	267	282	294	248	267	282	294	
	LO PR	61	65	71	75	64	68	75	79	67	71	78	83	70	75	81	87	74	78	85	91	76	81	88	94	76	81	88	94	76	81	88	94	76	81	88	94	
	MBh	34.3	35.0	37.4	40.0	33.5	34.2	36.5	39.1	32.7	33.4	35.7	38.1	31.9	32.6	34.8	37.2	30.3	30.9	33.1	35.3	28.1	28.7	30.6	32.7	25.8	26.4	28.3	30.3	28.1	28.7	30.6	32.7	25.8	26.4	28.3	30.3	
	S/T	0.90	0.84	0.68	0.51	0.93	0.87	0.71	0.53	0.95	0.89	0.73	0.54	0.98	0.92	0.75	0.56	1.00	0.96	0.78	0.58	1.00	0.96	0.78	0.58	1.00	0.96	0.78	0.58	1.00	0.96	0.78	0.58	1.00	0.96	0.78	0.58	
	Delta T	24	23	20	16	24	23	20	16	24	23	20	16	24	23	20	16	23	23	20	16	21	21	18	15	21	21	18	15	21	21	18	15	21	21	18	15	
KW	2.40	2.44	2.51	2.58	2.56	2.60	2.67	2.75	2.69	2.74	2.82	2.90	2.81	2.87	2.95	3.04	2.92	2.97	3.06	3.15	3.01	3.06	3.15	3.25	3.01	3.06	3.15	3.25	3.01	3.06	3.15	3.25	3.01	3.06	3.15	3.25		
AMPS	6.4	6.5	6.7	7.0	6.9	7.0	7.3	7.5	7.4	7.6	7.9	8.2	7.9	8.1	8.4	8.7	8.4	8.6	8.9	9.3	8.9	9.2	9.5	9.8	8.9	9.2	9.5	9.8	8.9	9.2	9.5	9.8	8.9	9.2	9.5	9.8		
HI PR	140	151	159	166	157	169	178	186	178	192	203	211	203	219	231	241	228	246	260	271	252	272	287	299	252	272	287	299	252	272	287	299	252	272	287	299		
LO PR	62	66	72	77	65	70	76	81	68	73	79	84	71	76	83	88	75	80	87	93	77	82	89	96	77	82	89	96	77	82	89	96	77	82	89	96		
MBh	34.6	35.4	37.8	40.4	33.8	34.5	36.9	39.5	33.0	33.7	36.0	38.5	32.2	32.9	35.1	37.6	30.6	31.3	33.4	35.7	28.3	29.0	30.9	33.1	25.9	26.6	28.5	30.5	28.3	29.0	30.9	33.1	25.9	26.6	28.5	30.5		
S/T	0.91	0.86	0.70	0.52	0.95	0.89	0.72	0.54	0.97	0.91	0.74	0.55	1.00	0.94	0.76	0.57	1.00	0.98	0.79	0.59	1.00	0.98	0.79	0.59	1.00	0.98	0.79	0.59	1.00	0.98	0.79	0.59	1.00	0.98	0.79	0.59		
Delta T	22	21	19	15	23	22	19	15	23	22	19	15	23	22	19	15	22	22	19	15	20	20	18	14	20	20	18	14	20	20	18	14	20	20	18	14		
KW	2.41	2.45	2.51	2.58	2.56	2.61	2.68	2.76	2.70	2.75	2.83	2.91	2.82	2.87	2.96	3.04	2.92	2.98	3.07	3.16	3.01	3.07	3.16	3.26	3.01	3.07	3.16	3.26	3.01	3.07	3.16	3.26	3.01	3.07	3.16	3.26		
AMPS	6.4	6.5	6.7	7.0	6.9	7.0	7.3	7.5	7.5	7.6	7.9	8.2	8.0	8.2	8.4	8.7	8.5	8.7	9.0	9.3	9.0	9.2	9.5	9.8	9.0	9.2	9.5	9.8	9.0	9.2	9.5	9.8	9.0	9.2	9.5	9.8		
HI PR	140	151	159	166	157	169	179	186	179	192	203	212	204	219	231	241	229	247	260	272	253	272	288	300	253	272	288	300	253	272	288	300	253	272	288	300		
LO PR	62	66	72	77	66	70	76	81	68	73	79	84	72	76	83	89	75	80	87	93	78	83	90	96	78	83	90	96	78	83	90	96	78	83	90	96		

85	1100	MBh	34.3	35.0	36.7	39.1	33.5	34.2	35.8	38.2	32.7	33.4	35.0	37.3	31.9	32.6	34.1	36.4	30.3	30.9	32.4	34.6	28.1	28.7	30.0	32.0	25.8	26.4	28.3	30.3	28.1	28.7	30.0	32.0
		S/T	0.91	0.87	0.79	0.64	0.94	0.91	0.82	0.66	0.96	0.93	0.84	0.68	0.99	0.96	0.87	0.70	1.00	0.99	0.90	0.73	1.00	1.00	0.91	0.73	1.00	1.00	0.91	0.73	1.00	1.00	0.91	0.73
		Delta T	26	26	24	21	26	26	24	21	26	26	24	21	27	26	25	21	25	26	24	21	23	24	23	20	23	24	23	20	23	24	23	20
		KW	2.39	2.43	2.50	2.56	2.54	2.59	2.66	2.74	2.68	2.73	2.81	2.89	2.80	2.85	2.93	3.02	2.90	2.96	3.04	3.13	2.99	3.05	3.14	3.23	2.99	3.05	3.14	3.23	2.99	3.05	3.14	3.23
		AMPS	6.3	6.5	6.7	6.9	6.8	7.0	7.2	7.5	7.4	7.6	7.8	8.1	7.9	8.1	8.3	8.7	8.4	8.6	8.9	9.2	8.9	9.1	9.4	9.7	8.9	9.1	9.4	9.7	8.9	9.1	9.4	9.7
	LO PR	139	149	158	164	156	168	177	185	177	191	201	210	202	217	229	239	227	244	258	269	251	270	285	297	251	270	285	297	251	270	285	297	
	LO PR	61	65	71	76	65	69	75	80	67	72	78	83	71	75	82	88	74	79	86	92	77	82	89	95	77	82	89	95	77	82	89	95	
	MBh	34.9	35.5	37.2	39.7	34.1	34.7	36.4	38.8	33.2	33.9	35.5	37.9	32.4	33.1	34.6	36.9	30.8	31.4	32.9	35.1	28.5	29.1	30.5	32.5	25.9	26.6	28.5	30.5	28.5	29.1	30.5	32.5	
	S/T	0.94	0.91	0.82	0.66	0.97	0.94	0.85	0.69	1.00	0.96	0.87	0.71	1.00	0.99	0.90	0.73	1.00	1.00	0.93	0.76	1.00	1.00	0.94	0.76	1.00	1.00	0.94	0.76	1.00	1.00	0.94	0.76	
	Delta T	25	25	23	20	25	25	24	20	25	25	24	20	25	25	24	21	24	24	23	20	22	22	22	19	22	22	22	19	22	22	22	19	
KW	2.42	2.46	2.53	2.59	2.57	2.62	2.69	2.77	2.71	2.76	2.84	2.92	2.83	2.89	2.97	3.06	2.94	3.00	3.08	3.17	3.03	3.09	3.18	3.27	3.03	3.09	3.18	3.27	3.03	3.09	3.18	3.27		
AMPS	6.4	6.6	6.8	7.0	6.9	7.1	7.3	7.6	7.5	7.7	7.9	8.2	8.0	8.2	8.5	8.8	8.5	8.7	9.0	9.4	9.0	9.2	9.5	9.9	9.0	9.2	9.5	9.9	9.0	9.2	9.5	9.9		
HI PR	141	152	160	167	158	170	180	188	180	194	205	213	205	221	233	243	231	248	262	274	255	274	290	302	255	274	290	302	255	274	290	302		
LO PR	63	66	73	77	66	70	77	82	69	73	80	85	72	77	84	89	76	80	88	93	78	83	91	97	78	83	91	97	78	83	91	97		
MBh	35.2	35.9	37.6	40.1	34.4	35.1	36.7	39.2	33.6	34.2	35.8	38.2	32.8	33.4	35.0	37.3	31.1	31.7	33.2	35.4	28.8	29.4	30.8	32.8	25.9	26.6	28.5	30.5	28.8	29.4	30.8	32.8		
S/T	0.96	0.92	0.83	0.68	0.99	0.96	0.86	0.70	1.00	0.98	0.89	0.72	1.00	1.00	0.91	0.74	1.00	1.00	0.95	0.77	1.00	1.00	0.96	0.78	1.00	1.00	0.96	0.78	1.00	1.00	0.96	0.78		
Delta T	24	23	22	19	24	24	22	19	24	24	22	19	24	24	23	20	22	22	22	19	20	21	21	18	20	21	21	18	20	21	21	18		
KW	2.42	2.47	2.53	2.60	2.58	2.63	2.70	2.77	2.72	2.77	2.85	2.93	2.84	2.90	2.98																			

COOLING PERFORMANCE DATA

GSC130483A*

EXPANDED PERFORMANCE DATA

COOLING OPERATION

MODEL: GSC130483A* / CA*F4860*6**+EEP

IDB*	Airflow	Outdoor Ambient Temperature																								
		65				75				85				95				105				115				
		59	63	67	71	59	63	67	71	59	63	67	71	59	63	67	71	59	63	67	71	59	63	67	71	
70	1800	MBh	44.6	46.2	50.7	-	43.6	45.2	49.5	-	42.5	44.1	48.3	-	41.5	43.0	47.1	-	39.4	40.9	44.8	-	36.5	37.8	41.5	-
		S/T	0.77	0.64	0.44	-	0.80	0.66	0.46	-	0.82	0.68	0.47	-	0.84	0.70	0.49	-	0.87	0.73	0.51	-	0.88	0.74	0.51	-
		Delta T	18	15	11	-	18	15	12	-	18	15	12	-	18	15	12	-	18	15	12	-	16	14	11	-
		KW	3.10	3.17	3.27	-	3.34	3.41	3.52	-	3.55	3.62	3.74	-	3.73	3.81	3.94	-	3.89	3.97	4.10	-	4.02	4.11	4.25	-
		AMPS	10.0	10.2	10.5	-	10.8	11.0	11.4	-	11.7	11.9	12.3	-	12.5	12.7	13.2	-	13.2	13.5	14.0	-	14.0	14.3	14.8	-
		HI PR	152	164	173	-	171	184	194	-	194	209	221	-	221	238	251	-	249	268	283	-	275	296	312	-
	LO PR	63	67	73	-	67	71	78	-	69	74	81	-	73	78	85	-	76	81	89	-	79	84	92	-	
	1600	MBh	43.3	44.9	49.2	-	42.3	43.8	48.0	-	41.3	42.8	46.9	-	40.3	41.8	45.8	-	38.3	39.7	43.5	-	35.5	36.7	40.3	-
		S/T	0.73	0.61	0.42	-	0.76	0.63	0.44	-	0.78	0.65	0.45	-	0.80	0.67	0.46	-	0.83	0.70	0.48	-	0.84	0.70	0.49	-
		Delta T	18	16	12	-	18	16	12	-	18	16	12	-	19	16	12	-	18	16	12	-	17	15	11	-
		KW	3.08	3.14	3.24	-	3.31	3.38	3.49	-	3.52	3.59	3.71	-	3.70	3.78	3.90	-	3.85	3.94	4.07	-	3.99	4.08	4.21	-
		AMPS	9.9	10.1	10.5	-	10.7	10.9	11.3	-	11.6	11.8	12.2	-	12.3	12.6	13.0	-	13.1	13.4	13.9	-	13.9	14.2	14.7	-
HI PR		151	162	171	-	169	182	192	-	192	207	219	-	219	236	249	-	246	265	280	-	272	293	309	-	
LO PR	63	67	73	-	66	70	77	-	69	73	80	-	72	77	84	-	76	80	88	-	78	83	91	-		
1400	MBh	40.0	41.4	45.4	-	39.0	40.5	44.3	-	38.1	39.5	43.3	-	37.2	38.5	42.2	-	36.3	36.6	40.1	-	32.7	33.9	37.2	-	
	S/T	0.71	0.59	0.41	-	0.73	0.61	0.42	-	0.75	0.63	0.43	-	0.77	0.65	0.45	-	0.80	0.67	0.47	-	0.81	0.68	0.47	-	
	Delta T	19	16	12	-	19	16	12	-	19	16	12	-	19	16	12	-	19	16	12	-	17	15	11	-	
	KW	3.01	3.07	3.16	-	3.23	3.30	3.41	-	3.43	3.51	3.62	-	3.61	3.69	3.81	-	3.76	3.84	3.97	-	3.89	3.97	4.10	-	
	AMPS	9.6	9.9	10.2	-	10.4	10.6	11.0	-	11.3	11.5	11.9	-	12.0	12.3	12.7	-	12.8	13.1	13.5	-	13.5	13.8	14.3	-	
	HI PR	146	157	166	-	164	177	186	-	187	201	212	-	212	229	241	-	239	257	272	-	264	284	300	-	
LO PR	61	65	70	-	64	68	74	-	67	71	77	-	70	74	81	-	73	78	85	-	76	81	88	-		
75	1800	MBh	45.4	46.7	50.6	54.3	44.3	45.6	49.4	53.0	43.3	44.5	48.2	51.7	42.2	43.4	47.0	50.5	40.1	41.3	44.7	48.0	37.1	38.2	41.4	44.4
		S/T	0.87	0.78	0.59	0.38	0.90	0.81	0.61	0.39	0.93	0.83	0.63	0.40	0.96	0.86	0.65	0.42	0.99	0.89	0.67	0.43	1.00	0.90	0.68	0.44
		Delta T	20	19	15	11	20	19	15	11	20	19	15	11	21	19	16	11	20	19	15	11	19	18	14	10
		KW	3.13	3.19	3.29	3.40	3.37	3.44	3.55	3.66	3.58	3.65	3.77	3.90	3.76	3.84	3.97	4.10	3.92	4.01	4.14	4.28	4.05	4.15	4.28	4.43
		AMPS	10.1	10.3	10.6	11.0	10.9	11.1	11.5	11.9	11.8	12.1	12.4	12.9	12.6	12.9	13.3	13.8	13.4	13.7	14.1	14.6	14.1	14.5	14.8	15.5
		HI PR	154	165	175	182	173	186	196	204	196	211	223	233	223	240	254	265	251	271	286	298	278	299	316	329
	LO PR	64	68	74	79	67	72	78	83	70	75	81	87	74	78	85	91	77	82	90	95	80	85	93	99	
	1600	MBh	44.0	45.3	49.1	52.7	43.0	44.3	47.9	51.5	42.0	43.2	46.8	50.2	41.0	42.2	45.7	49.0	38.9	40.1	43.4	46.6	36.1	37.1	40.2	43.1
		S/T	0.83	0.74	0.56	0.36	0.86	0.77	0.58	0.38	0.88	0.79	0.60	0.39	0.91	0.82	0.62	0.40	0.95	0.85	0.64	0.41	0.96	0.86	0.65	0.42
		Delta T	21	19	16	11	21	20	16	11	21	20	16	11	22	20	16	11	21	20	16	11	20	18	15	10
		KW	3.10	3.17	3.27	3.37	3.34	3.41	3.52	3.63	3.55	3.62	3.74	3.86	3.73	3.81	3.94	4.07	3.89	3.97	4.10	4.24	4.02	4.11	4.25	4.39
		AMPS	10.0	10.2	10.5	10.9	10.8	11.0	11.4	11.8	11.7	12.0	12.3	12.8	12.5	12.8	13.2	13.7	13.2	13.6	14.0	14.5	14.0	14.3	14.8	15.4
HI PR		152	164	173	180	171	184	194	202	194	209	221	230	221	238	251	262	249	268	283	295	275	296	313	326	
LO PR	63	67	73	78	67	71	78	83	69	74	81	86	73	78	85	90	76	81	89	94	79	84	92	98		
1400	MBh	40.7	41.9	45.3	48.6	39.7	40.9	44.3	47.5	38.8	39.9	43.2	46.4	37.8	38.9	42.1	45.2	35.9	37.0	40.0	43.0	33.3	34.3	37.1	39.8	
	S/T	0.80	0.72	0.54	0.35	0.83	0.74	0.56	0.36	0.85	0.76	0.58	0.37	0.88	0.79	0.60	0.38	0.91	0.82	0.62	0.40	0.92	0.82	0.62	0.40	
	Delta T	21	20	16	11	22	20	16	11	22	20	16	11	22	20	17	11	22	20	16	11	20	19	15	10	
	KW	3.03	3.09	3.19	3.29	3.26	3.33	3.43	3.54	3.46	3.54	3.65	3.77	3.64	3.72	3.84	3.97	3.79	3.87	4.00	4.13	3.92	4.01	4.14	4.28	
	AMPS	9.7	10.0	10.3	10.6	10.5	10.7	11.1	11.5	11.4	11.6	12.0	12.4	12.1	12.4	12.8	13.3	12.9	13.2	13.6	14.1	13.6	14.0	14.4	14.9	
	HI PR	148	159	168	175	166	178	188	196	188	203	214	223	215	231	244	254	241	260	274	286	267	287	303	316	
LO PR	61	65	71	76	65	69	75	80	67	72	78	83	71	75	82	87	74	79	86	92	77	82	89	95		

NOTE: Shaded area is ACOA (TVA) conditions

* Entering Indoor Dry Bulb Temperature

COOLING PERFORMANCE DATA

GSC130483A*

EXPANDED PERFORMANCE DATA

COOLING OPERATION

MODEL: GSC130483A* / CA*F4860*6**+EEP

IDB*	Airflow	Outdoor Ambient Temperature																													
		65					75					85					95					105					115				
		59	63	67	71	75	59	63	67	71	75	59	63	67	71	75	59	63	67	71	75	59	63	67	71	75	59	63	67	71	75
80	1800	MBh	46.2	47.2	50.4	53.9	45.1	46.1	49.2	52.6	44.0	45.0	48.1	51.4	43.0	43.9	46.9	50.1	40.8	41.7	44.5	47.6	37.8	38.6	41.3	44.1					
		S/T	0.96	0.90	0.73	0.55	1.00	0.93	0.76	0.57	1.00	0.95	0.78	0.58	1.00	1.00	0.80	0.60	1.00	1.00	0.83	0.62	1.00	1.00	0.84	0.63					
		Delta T	23	22	19	15	23	22	19	15	22	22	19	15	22	22	19	15	21	21	19	15	19	20	18	14					
		KW	3.15	3.22	3.32	3.43	3.39	3.47	3.58	3.69	3.61	3.68	3.80	3.93	3.79	3.88	4.00	4.14	3.95	4.04	4.17	4.31	4.09	4.18	4.32	4.46					
		AMPS	10.2	10.4	10.7	11.1	11.0	11.2	11.6	12.0	11.9	12.2	12.6	13.0	12.7	13.0	13.4	13.9	13.5	13.8	14.3	14.8	14.3	14.6	15.1	15.7					
	1600	HI PR	155	167	176	184	174	188	198	207	198	213	225	235	226	243	257	268	254	273	289	301	281	302	319	333					
		LO PR	64	69	75	80	68	72	79	84	71	75	82	88	74	79	86	92	78	83	90	96	81	86	94	100					
		MBh	44.8	45.8	48.9	52.3	43.8	44.7	47.8	51.1	42.7	43.7	46.7	49.9	41.7	42.6	45.5	48.7	39.6	40.5	43.2	46.2	36.7	37.5	40.1	42.8					
		S/T	0.91	0.86	0.70	0.52	0.95	0.89	0.72	0.54	0.97	0.91	0.74	0.55	1.00	0.94	0.76	0.57	1.00	0.98	0.79	0.59	1.00	0.98	0.80	0.60					
		Delta T	24	23	20	16	24	23	20	16	24	23	20	16	24	23	20	16	23	23	20	16	21	21	18	15					
1400	KW	3.13	3.19	3.29	3.40	3.37	3.44	3.55	3.66	3.58	3.65	3.77	3.90	3.76	3.84	3.97	4.10	3.92	4.01	4.14	4.28	4.06	4.15	4.28	4.43						
	AMPS	10.1	10.3	10.6	11.0	10.9	11.1	11.5	11.9	11.8	12.1	12.4	12.9	12.6	12.9	13.3	13.8	13.4	13.7	14.1	14.6	14.1	14.5	14.9	15.5						
	HI PR	154	165	175	182	173	186	196	204	196	211	223	233	223	241	254	265	251	271	286	298	278	299	316	329						
	LO PR	64	68	74	79	67	72	78	83	70	75	81	87	74	78	85	91	77	82	90	96	80	85	93	99						
	MBh	41.4	42.3	45.2	48.3	40.4	41.3	44.1	47.2	39.5	40.3	43.1	46.0	38.5	39.3	42.0	44.9	36.6	37.4	39.9	42.7	33.9	34.6	37.0	39.5						

85	1800	MBh	47.0	47.9	50.2	53.5	45.9	46.8	49.0	52.3	44.8	45.7	47.8	51.0	43.7	44.5	46.7	49.8	41.5	42.3	44.3	47.3	38.5	39.2	41.1	43.8
		S/T	1.00	0.97	0.87	0.71	1.00	1.00	0.91	0.74	1.00	1.00	0.93	0.75	1.00	1.00	0.96	0.78	1.00	1.00	0.81	0.61	1.00	1.00	0.81	0.81
		Delta T	24	24	22	19	23	24	23	20	23	23	23	20	22	23	23	20	21	22	23	20	20	20	21	18
		KW	3.18	3.24	3.35	3.45	3.42	3.49	3.61	3.72	3.63	3.71	3.83	3.96	3.82	3.91	4.04	4.17	3.98	4.07	4.21	4.35	4.12	4.22	4.36	4.50
		AMPS	10.3	10.5	10.8	11.2	11.1	11.3	11.7	12.1	12.0	12.3	12.7	13.1	12.8	13.1	13.5	14.0	13.6	13.9	14.4	14.9	14.4	14.7	15.2	15.8
	1600	HI PR	157	169	178	186	176	189	200	209	200	215	227	237	228	245	259	270	256	276	291	304	283	305	322	336
		LO PR	65	69	76	81	69	73	80	85	71	76	83	88	75	80	87	93	79	84	91	97	81	87	95	101
		MBh	45.6	46.5	48.7	51.9	44.5	45.4	47.6	50.7	43.5	44.3	46.4	49.5	42.4	43.2	45.3	48.3	40.3	41.1	43.0	45.9	37.3	38.1	39.9	42.5
		S/T	0.96	0.92	0.83	0.68	0.99	0.96	0.86	0.70	1.00	0.98	0.89	0.72	1.00	1.00	0.91	0.74	1.00	1.00	0.95	0.77	1.00	1.00	0.96	0.78
		Delta T	25	25	23	20	25	25	24	20	25	25	24	20	24	25	24	21	23	24	23	20	21	22	22	19
1400	KW	3.15	3.22	3.32	3.43	3.39	3.47	3.58	3.69	3.61	3.68	3.80	3.93	3.79	3.88	4.00	4.14	3.95	4.04	4.17	4.31	4.09	4.18	4.32	4.46	
	AMPS	10.2	10.4	10.7	11.1	11.0	11.2	11.6	12.0	11.9	12.2	12.6	13.0	12.7	13.0	13.4	13.9	13.5	13.8	14.3	14.8	14.3	14.6	15.1	15.7	
	HI PR	155	167	176	184	174	188	198	207	198	213	225	235	226	243	257	268	254	273	289	301	281	302	319	333	
	LO PR	64	69	75	80	68	72	79	84	71	75	82	88	74	79	86	92	78	83	90	96	81	86	94	100	
	MBh	42.1	42.9	44.9	47.9	41.1	41.9	43.9	46.8	40.1	40.9	42.9	45.7	39.2	39.9	41.8	44.6	37.2	37.9	39.7	42.4	34.5	35.1	36.8	39.3	

NOTE: Shaded area is AHRI Rating Conditions

* Entering Indoor Dry Bulb Temperature

COOLING PERFORMANCE DATA

GSC130483B*

EXPANDED PERFORMANCE DATA

COOLING OPERATION

MODEL: GSC130483B* / CA*F4860*6D

IDB*	Airflow	Outdoor Ambient Temperature																								
		65				75				85				95				105				115				
		59	63	67	71	59	63	67	71	59	63	67	71	59	63	67	71	59	63	67	71	59	63	67	71	
70	1400	MBh	43.1	44.7	49.0	-	42.1	43.6	47.8	-	41.1	42.6	46.7	-	40.1	41.6	45.5	-	38.1	39.5	43.3	-	35.3	36.6	40.1	-
		S/T	0.69	0.58	0.40	-	0.72	0.60	0.42	-	0.74	0.61	0.43	-	0.76	0.63	0.44	-	0.79	0.66	0.46	-	0.80	0.66	0.46	-
		Delta T	20	17	13	-	20	17	13	-	20	17	13	-	20	17	13	-	20	17	13	-	18	16	12	-
		KW	2.94	3.01	3.12	-	3.20	3.28	3.40	-	3.43	3.51	3.64	-	3.63	3.72	3.86	-	3.81	3.90	4.05	-	3.96	4.06	4.21	-
		AMPS	8.7	9.0	9.3	-	9.5	9.7	10.0	-	10.3	10.6	10.9	-	11.0	11.3	11.7	-	11.7	12.0	12.5	-	12.5	12.8	13.2	-
	1550	HI PR	146	158	166	-	164	177	187	-	187	201	212	-	213	229	242	-	239	258	272	-	264	285	301	-
		LO PR	61	65	71	-	64	69	75	-	67	71	78	-	70	75	82	-	74	78	86	-	76	81	89	-
		MBh	43.8	45.4	49.7	-	42.7	44.3	48.5	-	41.7	43.2	47.4	-	40.7	42.2	46.2	-	38.7	40.1	43.9	-	35.8	37.1	40.7	-
		S/T	0.72	0.60	0.42	-	0.74	0.62	0.43	-	0.76	0.64	0.44	-	0.79	0.66	0.46	-	0.82	0.68	0.47	-	0.82	0.69	0.48	-
		Delta T	19	16	12	-	19	16	12	-	19	16	12	-	19	16	12	-	19	16	12	-	18	15	12	-
1800	KW	2.98	3.06	3.17	-	3.25	3.33	3.45	-	3.48	3.57	3.70	-	3.69	3.78	3.92	-	3.87	3.97	4.11	-	4.02	4.12	4.28	-	
	AMPS	8.9	9.1	9.4	-	9.6	9.9	10.2	-	10.5	10.7	11.1	-	11.2	11.5	11.9	-	11.9	12.2	12.7	-	12.7	13.0	13.4	-	
	HI PR	149	160	169	-	167	180	190	-	190	205	216	-	216	233	246	-	244	262	277	-	269	290	306	-	
	LO PR	62	66	72	-	66	70	76	-	68	72	79	-	72	76	83	-	75	80	87	-	78	83	90	-	
	MBh	45.1	46.7	51.2	-	44.0	45.6	50.0	-	43.0	44.5	48.8	-	41.9	43.5	47.6	-	39.8	41.3	45.2	-	36.9	38.2	41.9	-	
75	1400	S/T	0.75	0.63	0.44	-	0.78	0.65	0.45	-	0.80	0.67	0.46	-	0.83	0.69	0.48	-	0.86	0.72	0.50	-	0.86	0.72	0.50	-
		Delta T	17	15	11	-	18	15	12	-	18	15	12	-	18	15	12	-	17	15	11	-	16	14	11	-
		KW	3.01	3.08	3.20	-	3.28	3.36	3.48	-	3.52	3.60	3.74	-	3.73	3.82	3.96	-	3.90	4.00	4.15	-	4.06	4.16	4.32	-
		AMPS	9.0	9.2	9.5	-	9.7	9.9	10.3	-	10.6	10.8	11.2	-	11.3	11.6	12.0	-	12.0	12.4	12.8	-	12.8	13.1	13.6	-
		HI PR	150	162	171	-	169	182	192	-	192	207	218	-	219	235	248	-	246	265	279	-	272	292	309	-
	1550	LO PR	63	67	73	-	66	70	77	-	69	73	80	-	72	77	84	-	76	81	88	-	78	83	91	-
		MBh	43.8	45.1	48.9	52.4	42.8	44.1	47.7	51.2	41.8	43.0	46.6	50.0	40.8	42.0	45.4	48.8	38.7	39.9	43.2	46.3	35.9	36.9	40.0	42.9
		S/T	0.79	0.70	0.53	0.34	0.82	0.73	0.55	0.36	0.84	0.75	0.57	0.36	0.86	0.77	0.58	0.38	0.90	0.80	0.61	0.39	0.90	0.81	0.61	0.39
		Delta T	23	21	17	12	23	21	17	12	23	21	17	12	23	21	17	12	23	21	17	12	21	20	16	11
		KW	2.96	3.04	3.15	3.26	3.23	3.31	3.43	3.56	3.46	3.55	3.68	3.82	3.67	3.76	3.90	4.05	3.84	3.94	4.09	4.24	3.99	4.09	4.25	4.41
1800	AMPS	8.8	9.0	9.3	9.7	9.6	9.8	10.1	10.5	10.4	10.7	11.0	11.4	11.1	11.4	11.8	12.2	11.9	12.2	12.6	13.1	12.6	12.9	13.3	13.9	
	HI PR	148	159	168	175	166	179	189	197	189	203	214	224	215	231	244	255	242	260	275	287	267	288	304	317	
	LO PR	62	66	72	76	65	69	76	81	68	72	79	84	71	76	83	88	74	79	86	92	77	82	89	95	
	MBh	44.5	45.8	49.6	53.2	43.5	44.8	48.4	52.0	42.4	43.7	47.3	50.8	41.4	42.6	46.1	49.5	39.3	40.5	43.8	47.0	36.4	37.5	40.6	43.6	
	S/T	0.82	0.73	0.55	0.36	0.85	0.76	0.57	0.37	0.87	0.78	0.59	0.38	0.90	0.80	0.61	0.39	0.93	0.83	0.63	0.40	0.94	0.84	0.63	0.41	
75	1400	Delta T	22	20	16	11	22	20	16	11	22	20	16	11	22	20	16	11	22	20	16	11	20	19	15	11
		KW	3.01	3.08	3.20	3.32	3.28	3.36	3.48	3.61	3.52	3.61	3.74	3.88	3.73	3.82	3.96	4.11	3.91	4.00	4.15	4.31	4.06	4.16	4.32	4.48
		AMPS	9.0	9.2	9.5	9.9	9.7	9.9	10.3	10.7	10.6	10.8	11.2	11.6	11.3	11.6	12.0	12.4	12.1	12.4	12.8	13.3	12.8	13.1	13.6	14.1
		HI PR	150	162	171	178	169	182	192	200	192	207	218	228	219	235	248	259	246	265	280	292	272	293	309	322
		LO PR	63	67	73	78	66	70	77	82	69	73	80	85	72	77	84	89	76	81	88	94	78	83	91	97
	1550	MBh	45.8	47.2	51.1	54.8	44.8	46.1	49.9	53.6	43.7	45.0	48.7	52.3	42.6	43.9	47.5	51.0	40.5	41.7	45.1	48.5	37.5	38.6	41.8	44.9
		S/T	0.86	0.77	0.58	0.37	0.89	0.79	0.60	0.39	0.91	0.81	0.62	0.40	0.94	0.84	0.64	0.41	0.97	0.87	0.66	0.42	0.98	0.88	0.67	0.43
		Delta T	20	18	15	10	20	19	15	11	20	19	15	11	20	19	15	11	20	19	15	11	19	17	14	10
		KW	3.04	3.11	3.23	3.35	3.31	3.39	3.52	3.65	3.55	3.64	3.77	3.92	3.76	3.86	4.00	4.15	3.94	4.04	4.19	4.35	4.10	4.20	4.36	4.52
		AMPS	9.0	9.3	9.6	9.9	9.8	10.0	10.4	10.8	10.7	10.9	11.3	11.7	11.4	11.7	12.1	12.6	12.2	12.5	12.9	13.4	12.9	13.2	13.7	14.2
1800	HI PR	152	164	173	180	171	183	194	202	194	209	220	230	221	238	251	262	248	267	282	294	275	295	312	325	
	LO PR	63	67	74	78	67	71	78	83	70	74	81	86	73	78	85	90	77	81	89	95	79	84	92	98	

NOTE: Shaded area is ACOA (TVA) conditions

* Entering Indoor Dry Bulb Temperature

COOLING PERFORMANCE DATA

GSC130483B*

EXPANDED PERFORMANCE DATA

COOLING OPERATION

MODEL: GSC130483B* / CA*F4860*6D

IDB*	Airflow	Outdoor Ambient Temperature																												
		65				75				85				95				105				115								
		59	63	67	71	59	63	67	71	59	63	67	71	59	63	67	71	59	63	67	71	59	63	67	71					
80	1400	MBh	44.6	45.6	48.7	52.1	43.6	44.5	47.6	50.9	42.5	43.5	46.4	49.6	41.5	42.4	45.3	48.4	45.3	48.4	39.4	40.3	43.0	46.0	36.5	37.3	39.9	42.6		
		S/T	0.86	0.81	0.66	0.49	0.90	0.84	0.68	0.51	0.92	0.86	0.70	0.52	0.95	0.89	0.72	0.54	0.98	0.92	0.75	0.56	0.92	0.75	0.56	0.99	0.93	0.76	0.57	
		Delta T	25	24	21	17	26	25	21	17	26	25	21	17	26	25	22	17	25	24	21	17	25	24	21	17	24	23	20	16
		KW	2.99	3.06	3.18	3.29	3.26	3.34	3.46	3.59	3.49	3.58	3.71	3.85	3.70	3.80	3.94	4.08	3.88	3.98	4.12	4.28	4.03	4.13	4.28	4.03	4.13	4.29	4.45	
		AMPS	8.9	9.1	9.4	9.8	9.6	9.9	10.2	10.6	10.5	10.8	11.1	11.5	11.2	11.5	11.9	12.4	12.0	12.3	12.7	13.2	12.7	13.0	13.5	14.0	12.7	13.0	13.5	14.0
	1550	HI PR	149	161	170	177	168	180	190	199	191	205	217	226	217	234	247	257	244	263	278	290	270	290	307	320	270	290	307	320
		LO PR	62	66	72	77	66	70	76	81	68	73	79	85	72	76	83	89	75	80	87	93	78	83	90	96	78	83	90	96
		MBh	45.3	46.3	49.5	52.9	44.2	45.2	48.3	51.6	43.2	44.1	47.2	50.4	42.1	43.1	46.0	49.2	40.0	40.9	43.7	46.7	37.1	37.9	40.5	43.3	37.1	37.9	40.5	43.3
		S/T	0.90	0.84	0.68	0.51	0.93	0.87	0.71	0.53	0.95	0.89	0.73	0.54	0.98	0.92	0.75	0.56	1.00	0.96	0.78	0.58	1.00	0.96	0.78	0.58	1.00	0.96	0.78	0.59
		Delta T	24	23	20	16	24	23	20	16	24	23	20	16	24	23	20	16	24	23	20	16	24	23	20	16	24	23	20	15
1800	KW	3.04	3.11	3.23	3.35	3.31	3.39	3.52	3.65	3.55	3.64	3.77	3.92	3.76	3.86	4.00	4.15	3.94	4.04	4.19	4.35	4.10	4.20	4.36	4.52	4.10	4.20	4.36	4.52	
	AMPS	9.0	9.3	9.6	9.9	9.8	10.0	10.4	10.8	10.7	10.9	11.3	11.7	11.4	11.7	12.1	12.6	12.2	12.5	12.9	13.4	12.9	13.2	13.7	14.2	12.9	13.2	13.7	14.2	
	HI PR	152	164	173	180	171	184	194	202	194	209	220	230	221	238	251	262	248	267	282	295	275	295	312	325	275	295	312	325	
	LO PR	63	67	74	78	67	71	78	83	70	74	81	86	73	78	85	90	77	81	89	96	79	84	92	98	79	84	92	98	
	MBh	46.7	47.7	50.9	54.4	45.6	46.6	49.7	53.2	44.5	45.5	48.6	51.9	43.4	44.3	47.4	50.6	41.2	42.1	45.0	48.1	38.2	39.0	41.7	44.6	38.2	39.0	41.7	44.6	

85	1400	MBh	45.4	46.3	48.5	51.7	44.3	45.2	47.3	50.5	43.3	44.1	46.2	49.3	42.2	43.0	45.1	48.1	45.1	48.1	40.1	40.9	42.8	45.7	37.2	37.9	39.7	42.3		
		S/T	0.91	0.87	0.79	0.64	0.94	0.91	0.82	0.66	0.96	0.93	0.84	0.68	0.99	0.96	0.87	0.70	1.00	0.96	0.87	0.70	1.00	0.99	0.90	0.73	1.00	1.00	0.91	0.73
		Delta T	27	27	25	22	27	27	25	22	27	27	25	22	28	27	26	22	26	27	25	22	26	27	25	22	24	25	24	20
		KW	3.02	3.09	3.21	3.32	3.29	3.37	3.49	3.62	3.53	3.61	3.75	3.89	3.74	3.83	3.97	4.12	3.92	4.01	4.16	4.32	4.07	4.17	4.33	4.49	4.07	4.17	4.33	4.49
		AMPS	9.0	9.2	9.5	9.9	9.7	10.0	10.3	10.7	10.6	10.9	11.2	11.7	11.3	11.6	12.0	12.5	12.1	12.4	12.8	13.3	12.8	13.1	13.6	14.1	12.8	13.1	13.6	14.1
	1550	HI PR	151	162	171	179	169	182	192	201	193	207	219	228	219	236	249	260	247	265	280	292	273	293	310	323	273	293	310	323
		LO PR	63	67	73	78	66	71	77	82	69	73	80	85	72	77	84	90	76	81	88	94	79	84	91	97	79	84	91	97
		MBh	46.1	47.0	49.2	52.5	45.0	45.9	48.1	51.3	43.9	44.8	46.9	50.1	42.9	43.7	45.8	48.8	40.7	41.5	43.5	46.4	37.7	38.5	40.3	43.0	37.7	38.5	40.3	43.0
		S/T	0.94	0.91	0.82	0.66	0.97	0.94	0.85	0.69	1.00	0.96	0.87	0.71	1.00	0.99	0.90	0.73	1.00	1.00	0.93	0.76	1.00	1.00	0.93	0.76	1.00	1.00	0.94	0.76
		Delta T	26	25	24	21	26	26	24	21	26	26	24	21	25	26	24	21	24	25	24	21	24	25	24	21	22	23	22	19
1800	KW	3.07	3.14	3.26	3.38	3.34	3.42	3.55	3.68	3.58	3.67	3.81	3.95	3.80	3.89	4.04	4.19	3.98	4.08	4.23	4.39	4.14	4.24	4.40	4.57	4.14	4.24	4.40	4.57	
	AMPS	9.1	9.4	9.7	10.0	9.9	10.1	10.5	10.9	10.8	11.0	11.4	11.8	11.5	11.8	12.2	12.7	12.3	12.6	13.0	13.5	13.0	13.4	13.8	14.4	13.0	13.4	13.8	14.4	
	HI PR	153	165	174	182	172	185	196	204	196	211	223	232	223	240	254	264	251	270	285	297	277	298	315	329	277	298	315	329	
	LO PR	64	68	74	79	68	72	78	84	70	75	82	87	74	78	86	91	77	82	90	96	80	85	93	99	80	85	93	99	
	MBh	47.5	48.4	50.7	54.1	46.4	47.3	49.5	52.8	45.3	46.1	48.3	51.6	44.2	45.0	47.1	50.3	42.0	42.8	44.8	47.8	38.9	39.6	41.5	44.3	38.9	39.6	41.5	44.3	

NOTE: Shaded area is AHRI Rating Conditions

* Entering Indoor Dry Bulb Temperature

COOLING PERFORMANCE DATA

GSC130603A*

EXPANDED PERFORMANCE DATA

COOLING OPERATION

MODEL: GSC130603A* / CA*F061*2* / CA*F4860*6**

IDB*	Airflow	Outdoor Ambient Temperature																								
		65				75				85				95				105				115				
		59	63	67	71	59	63	67	71	59	63	67	71	59	63	67	71	59	63	67	71	59	63	67	71	
70	1913	MBh	55.9	57.9	63.4	-	54.6	56.5	62.0	-	53.3	55.2	60.5	-	52.0	53.9	59.0	-	49.4	51.2	56.1	-	45.7	47.4	51.9	-
		S/T	0.70	0.58	0.40	-	0.72	0.60	0.42	-	0.74	0.62	0.43	-	0.77	0.64	0.44	-	0.80	0.66	0.46	-	0.80	0.67	0.46	-
		Delta T	19	16	12	-	19	16	12	-	19	16	12	-	19	17	13	-	19	16	12	-	18	15	12	-
		KW	3.97	4.06	4.19	-	4.29	4.38	4.53	-	4.57	4.67	4.83	-	4.81	4.92	5.09	-	5.02	5.14	5.31	-	5.20	5.32	5.50	-
		AMPS	8.5	8.7	9.0	-	9.1	9.3	9.6	-	9.9	10.1	10.4	-	10.5	10.8	11.1	-	11.2	11.4	11.8	-	11.8	12.1	12.4	-
		HI PR	144	155	163	-	161	174	183	-	183	197	208	-	209	225	237	-	235	253	267	-	260	279	295	-
		LO PR	58	61	67	-	61	65	71	-	63	68	74	-	67	71	77	-	70	74	81	-	72	77	84	-
		MBh	54.2	56.2	61.6	-	53.0	54.9	60.1	-	51.7	53.6	58.7	-	50.4	52.3	57.3	-	47.9	49.7	54.4	-	44.4	46.0	50.4	-
		S/T	0.67	0.56	0.39	-	0.69	0.58	0.40	-	0.71	0.59	0.41	-	0.73	0.61	0.42	-	0.76	0.63	0.44	-	0.76	0.64	0.44	-
		Delta T	20	17	13	-	20	17	13	-	20	17	13	-	20	17	13	-	20	17	13	-	18	16	12	-
70	1700	KW	3.94	4.03	4.16	-	4.25	4.35	4.49	-	4.53	4.63	4.78	-	4.77	4.88	5.04	-	4.98	5.09	5.26	-	5.16	5.28	5.45	-
		AMPS	8.4	8.6	8.9	-	9.1	9.3	9.6	-	9.8	10.0	10.3	-	10.4	10.7	11.0	-	11.1	11.3	11.7	-	11.7	12.0	12.3	-
		HI PR	142	153	162	-	160	172	181	-	182	195	206	-	207	223	235	-	233	250	264	-	257	277	292	-
		LO PR	57	61	66	-	60	64	70	-	63	67	73	-	66	70	77	-	69	74	80	-	72	76	83	-
		MBh	50.1	51.9	56.8	-	48.9	50.7	55.5	-	47.7	49.5	54.2	-	46.6	48.3	52.9	-	44.2	45.8	50.2	-	41.0	42.5	46.5	-
		S/T	0.64	0.54	0.37	-	0.67	0.56	0.39	-	0.68	0.57	0.40	-	0.70	0.59	0.41	-	0.73	0.61	0.42	-	0.74	0.62	0.43	-
		Delta T	20	17	13	-	20	17	13	-	20	17	13	-	20	18	13	-	20	17	13	-	19	16	12	-
		KW	3.84	3.93	4.05	-	4.15	4.24	4.38	-	4.41	4.51	4.66	-	4.65	4.76	4.91	-	4.85	4.96	5.13	-	5.02	5.14	5.31	-
		AMPS	8.2	8.4	8.7	-	8.8	9.0	9.3	-	9.5	9.8	10.1	-	10.2	10.4	10.7	-	10.8	11.0	11.4	-	11.4	11.6	12.0	-
		HI PR	138	149	157	-	155	167	176	-	176	190	200	-	201	216	228	-	226	243	256	-	249	268	283	-
LO PR	56	59	64	-	59	62	68	-	61	65	71	-	64	68	74	-	67	71	78	-	69	74	81	-		
75	1913	MBh	56.8	58.5	63.3	67.9	55.5	57.1	61.8	66.4	54.2	55.8	60.4	64.8	52.8	54.4	58.9	63.2	50.2	51.7	55.9	60.0	46.5	47.9	51.8	55.6
		S/T	0.79	0.71	0.54	0.35	0.82	0.74	0.56	0.36	0.84	0.75	0.57	0.37	0.87	0.78	0.59	0.38	0.90	0.81	0.61	0.39	0.91	0.82	0.62	0.40
		Delta T	22	20	16	11	22	20	17	11	22	20	17	11	22	20	17	12	22	20	16	11	20	19	15	11
		KW	4.01	4.09	4.23	4.37	4.33	4.42	4.57	4.72	4.61	4.71	4.87	5.03	4.85	4.96	5.13	5.31	5.06	5.18	5.36	5.54	5.25	5.37	5.55	5.74
		AMPS	8.6	8.8	9.0	9.3	9.2	9.4	9.7	10.1	10.0	10.2	10.5	10.9	10.6	10.9	11.2	11.6	11.3	11.5	11.9	12.3	11.9	12.2	12.6	13.0
		HI PR	145	156	165	172	163	175	185	193	185	199	211	220	211	227	240	250	237	255	270	281	262	282	298	311
		LO PR	58	62	68	72	62	66	72	76	64	68	74	79	67	72	78	83	71	75	82	87	73	78	85	90
		MBh	55.1	56.8	61.5	66.0	53.9	55.5	60.0	64.4	52.6	54.1	58.6	62.9	51.3	52.8	57.2	61.4	48.7	50.2	54.3	58.3	45.1	46.5	50.3	54.0
		S/T	0.76	0.68	0.51	0.33	0.78	0.70	0.53	0.34	0.80	0.72	0.54	0.35	0.83	0.74	0.56	0.36	0.86	0.77	0.58	0.38	0.87	0.78	0.59	0.38
		Delta T	23	21	17	12	23	21	17	12	23	21	17	12	23	21	17	12	23	21	17	12	21	20	16	11
75	1700	KW	3.97	4.06	4.19	4.33	4.29	4.38	4.53	4.68	4.57	4.67	4.83	4.99	4.81	4.92	5.09	5.26	5.02	5.14	5.31	5.49	5.20	5.32	5.50	5.69
		AMPS	8.5	8.7	9.0	9.3	9.1	9.3	9.6	10.0	9.9	10.1	10.4	10.8	10.5	10.8	11.1	11.5	11.2	11.4	11.8	12.2	11.8	12.1	12.5	12.9
		HI PR	144	155	163	170	161	174	183	191	183	197	208	217	209	225	237	248	235	253	267	279	260	279	295	308
		LO PR	58	62	67	72	61	65	71	76	63	68	74	79	67	71	77	82	70	74	81	86	72	77	84	89
		MBh	50.9	52.4	56.7	60.9	49.7	51.2	55.4	59.5	48.5	50.0	54.1	58.1	47.3	48.8	52.8	56.6	45.0	46.3	50.1	53.8	41.7	42.9	46.4	49.8
		S/T	0.73	0.65	0.49	0.32	0.76	0.68	0.51	0.33	0.78	0.69	0.53	0.34	0.80	0.72	0.54	0.35	0.83	0.74	0.56	0.36	0.84	0.75	0.57	0.37
		Delta T	23	21	17	12	23	21	18	12	23	21	18	12	23	21	18	12	23	21	17	12	22	20	16	11
		KW	3.88	3.96	4.09	4.22	4.18	4.27	4.42	4.56	4.45	4.55	4.70	4.86	4.69	4.80	4.96	5.13	4.89	5.00	5.17	5.35	5.07	5.18	5.36	5.55
		AMPS	8.3	8.5	8.7	9.0	8.9	9.1	9.4	9.7	9.6	9.8	10.2	10.5	10.2	10.5	10.8	11.2	10.9	11.1	11.5	11.9	11.5	11.7	12.1	12.6
		HI PR	139	150	158	165	156	168	178	185	178	191	202	211	203	218	230	240	228	245	259	270	252	271	286	299
LO PR	56	60	65	69	59	63	69	73	62	66	72	76	65	69	75	80	68	72	79	84	70	75	81	87		

* Entering Indoor Dry Bulb Temperature

NOTE: Shaded area is ACOA (TVA) conditions

COOLING PERFORMANCE DATA

GSC130603A*

EXPANDED PERFORMANCE DATA

COOLING OPERATION

MODEL: GSC130603A* / CA*F061*2 / CA*F4860*6**

IDB*	Airflow	Outdoor Ambient Temperature																													
		65					75					85					95					105					115				
		59	63	67	71	75	59	63	67	71	75	59	63	67	71	75	59	63	67	71	75	59	63	67	71	75	59	63	67	71	75
80	1913	MBh	57.8	59.1	63.1	67.5	56.5	57.7	61.6	65.9	55.1	56.3	60.2	64.3	53.8	55.0	58.7	62.8	67.1	71.4	51.1	52.2	55.8	59.6	47.3	48.4	51.7	55.2			
		S/T	0.87	0.82	0.66	0.50	0.90	0.85	0.69	0.51	0.93	0.87	0.71	0.53	0.96	0.90	0.73	0.55	1.00	1.00	0.93	0.76	0.57	1.00	0.94	0.76	0.57				
		Delta T	24	23	20	16	25	23	20	16	25	24	20	16	25	24	21	16	11	11	11	11	16	23	22	19	15				
		KW	4.04	4.13	4.26	4.40	4.36	4.46	4.61	4.76	4.65	4.75	4.91	5.08	4.90	5.01	5.18	5.35	5.51	5.68	5.84	5.11	5.23	5.40	5.59	5.29	5.41	5.60	5.80		
		AMPS	8.6	8.8	9.1	9.4	9.3	9.5	9.8	10.1	10.1	10.3	10.6	11.0	10.7	11.0	11.3	11.7	12.1	12.4	12.7	11.4	11.6	12.0	12.4	12.0	12.3	12.7	13.1		
	1700	HI PR	147	158	167	174	165	177	187	195	187	201	213	222	213	229	242	253	260	268	276	240	258	272	284	265	285	301	314		
		LO PR	59	63	68	73	62	66	72	77	65	69	75	80	68	72	79	84	74	78	83	71	76	83	88	74	78	86	91		
		MBh	56.1	57.4	61.3	65.5	54.8	56.0	59.9	64.0	53.5	54.7	58.4	62.5	52.2	53.4	57.0	60.9	64.8	68.7	72.6	49.6	50.7	54.2	57.9	45.9	46.9	50.2	53.6		
		S/T	0.83	0.78	0.63	0.47	0.86	0.81	0.66	0.49	0.88	0.83	0.67	0.50	0.91	0.85	0.70	0.52	0.95	0.95	0.89	0.72	0.54	0.95	0.89	0.73	0.54				
		Delta T	25	24	21	17	26	24	21	17	26	24	21	17	26	25	22	17	11	11	11	11	17	24	23	20	16				
1488	KW	4.01	4.09	4.23	4.37	4.33	4.42	4.57	4.72	4.61	4.71	4.87	5.03	4.85	4.96	5.13	5.31	5.47	5.64	5.81	5.07	5.18	5.36	5.54	5.25	5.37	5.55	5.74			
	AMPS	8.6	8.8	9.0	9.3	9.2	9.4	9.7	10.1	10.0	10.2	10.5	10.9	10.6	10.9	11.2	11.6	11.9	12.2	12.5	11.3	11.5	11.9	12.3	11.9	12.2	12.6	13.0			
	HI PR	145	156	165	172	163	175	185	193	185	199	211	220	211	227	240	250	257	265	273	237	255	270	281	262	282	298	311			
	LO PR	58	62	68	72	62	66	72	76	64	68	74	79	67	72	78	83	71	75	82	68	73	80	85	73	78	85	90			
	MBh	51.8	52.9	56.6	60.5	50.6	51.7	55.2	59.1	49.4	50.5	53.9	57.6	48.2	49.2	52.6	56.2	59.8	63.4	67.0	46.8	46.8	50.0	53.4	42.4	43.3	46.3	49.5			
85	1913	S/T	0.80	0.75	0.61	0.46	0.83	0.78	0.63	0.47	0.85	0.80	0.65	0.49	0.88	0.82	0.67	0.50	0.91	0.91	0.86	0.70	0.52	0.92	0.86	0.70	0.52				
		Delta T	26	25	21	17	26	25	22	17	26	25	22	17	26	25	22	17	11	11	11	11	17	24	23	20	16				
		KW	3.91	3.99	4.12	4.26	4.22	4.31	4.45	4.60	4.49	4.59	4.74	4.90	4.73	4.84	5.00	5.17	5.34	5.51	5.68	4.94	5.05	5.22	5.40	5.11	5.23	5.41	5.59		
		AMPS	8.4	8.5	8.8	9.1	9.0	9.2	9.5	9.8	9.7	9.9	10.2	10.6	10.3	10.6	10.9	11.3	11.6	11.9	12.2	11.0	11.2	11.6	12.0	11.6	11.8	12.2	12.7		
		HI PR	141	152	160	167	158	170	180	187	180	193	204	213	205	220	233	243	230	248	262	237	255	270	281	254	274	289	302		
	1700	LO PR	57	60	66	70	60	64	70	74	62	66	72	77	65	70	76	81	68	73	80	68	73	80	85	71	75	82	88		
		MBh	58.8	60.0	62.8	67.0	57.5	58.6	61.3	65.4	56.1	57.2	59.9	63.9	54.7	55.8	58.4	62.3	66.2	70.1	74.0	52.0	53.0	55.5	59.2	48.2	49.1	51.4	54.8		
		S/T	0.91	0.88	0.80	0.65	0.95	0.91	0.82	0.67	0.97	0.94	0.84	0.69	1.00	0.97	0.87	0.71	1.00	1.00	0.96	0.86	0.70	1.00	0.96	0.87	0.71				
		Delta T	26	25	24	21	26	26	24	21	26	26	24	21	26	26	24	21	11	11	11	11	17	24	23	24	23	20			
		KW	4.07	4.16	4.30	4.44	4.40	4.50	4.65	4.80	4.68	4.79	4.95	5.12	4.94	5.05	5.22	5.40	5.57	5.74	5.91	5.15	5.27	5.45	5.64	5.34	5.46	5.65	5.85		
1488	AMPS	8.7	8.9	9.2	9.5	9.4	9.6	9.9	10.2	10.1	10.4	10.7	11.1	10.8	11.0	11.4	11.8	12.1	12.4	12.7	11.4	11.7	12.1	12.5	12.1	12.4	12.8	13.3			
	HI PR	148	159	168	176	166	179	189	197	189	203	215	224	215	232	245	255	242	261	275	242	261	275	287	268	288	304	317			
	LO PR	60	63	69	74	63	67	73	78	65	70	76	81	69	73	80	85	72	77	84	68	73	80	89	74	79	86	92			
	MBh	57.1	58.2	61.0	65.0	55.8	56.9	59.6	63.5	54.5	55.5	58.1	62.0	53.1	54.2	56.7	60.5	64.4	68.3	72.2	50.5	51.4	53.9	57.5	46.7	47.7	49.9	53.2			
	S/T	0.87	0.84	0.76	0.62	0.90	0.87	0.79	0.64	0.93	0.89	0.81	0.65	0.96	0.92	0.83	0.67	0.99	0.99	0.96	0.86	0.70	1.00	0.96	0.87	0.71					
88	1700	Delta T	27	26	25	22	27	27	25	22	27	27	25	22	27	27	26	22	11	11	11	11	17	24	23	20	16				
		KW	4.04	4.13	4.26	4.40	4.36	4.46	4.61	4.76	4.65	4.75	4.91	5.08	4.90	5.01	5.18	5.35	5.51	5.68	5.11	5.23	5.40	5.59	5.29	5.41	5.60	5.80			
		AMPS	8.6	8.8	9.1	9.4	9.3	9.5	9.8	10.1	10.1	10.3	10.6	11.0	10.7	11.0	11.3	11.7	12.1	12.4	12.7	11.4	11.6	12.0	12.4	12.0	12.3	12.7	13.1		
		HI PR	147	158	167	174	165	177	187	195	187	201	213	222	213	229	242	253	260	268	276	240	258	272	284	265	285	301	314		
		LO PR	59	63	68	73	62	66	72	77	65	69	75	80	68	72	79	84	71	76	83	68	73	80	88	74	78	86	91		
	1488	MBh	52.7	53.7	56.3	60.0	51.5	52.5	55.0	58.6	50.3	51.2	53.7	57.2	49.0	50.0	52.3	55.8	59.3	62.8	66.3	46.6	47.5	49.7	53.1	43.1	44.0	46.1	49.1		
		S/T	0.84	0.81	0.73	0.59	0.87	0.84	0.76	0.61	0.89	0.86	0.78	0.63	0.92	0.89	0.80	0.65	0.96	0.96	0.92	0.83	0.68	0.96	0.93	0.84	0.68				
		Delta T	27	27	25	22	28	27	26	22	28	27	26	22	28	27	26	22	11	11	11	11	17	24	23	24	21				
		KW	3.94	4.03	4.16	4.29	4.25	4.35	4.49	4.64	4.53	4.63	4.78	4.95	4.77	4.88	5.04	5.22	5.39	5.57	5.74	4.98	5.09	5.26	5.45	5.16	5.27	5.45	5.64		
		AMPS	8.4	8.6	8.9	9.2	9.1	9.3	9.6	9.9	9.8	10.0	10.3	10.7	10.4	10.7	11.0	11.4	11.7	12.1	12.4	11.1	11.3	11.7	12.1	11.7	12.0	12.3	12.8		
88	HI PR	142	153	162	169	160	172	181	189	182	195	206	215	207	222	235	245	233	250	264	233	250	264	276	257	277	292	305			
	LO PR	57	61	66	71	60	64	70	75	63	67	73	78	66	70	77	82	69	74	80	68	73	80	86	72	76	83	88			

* Entering Indoor Dry Bulb Temperature

NOTE: Shaded area is AHRI Rating Conditions

COOLING PERFORMANCE DATA

GSC130603B*

EXPANDED PERFORMANCE DATA

COOLING OPERATION

MODEL: GSC130603B* / CA*F4961*6A*

IDB*	Airflow	Outdoor Ambient Temperature																								
		65				75				85				95				105				115				
		59	63	67	71	59	63	67	71	59	63	67	71	59	63	67	71	59	63	67	71	59	63	67	71	
70	1600	MBh	50.1	51.9	56.8	-	48.9	50.7	55.5	-	47.7	49.5	54.2	-	46.6	48.3	52.9	-	44.2	45.8	50.2	-	41.0	42.5	46.5	-
		S/T	0.67	0.56	0.39	-	0.70	0.58	0.40	-	0.72	0.60	0.41	-	0.74	0.62	0.43	-	0.77	0.64	0.44	-	0.77	0.65	0.45	-
		Delta T	19	17	13	-	20	17	13	-	20	17	13	-	20	17	13	-	20	17	13	-	18	16	12	-
		KW	3.79	3.86	3.98	-	4.06	4.15	4.27	-	4.31	4.40	4.53	-	4.52	4.61	4.76	-	4.70	4.80	4.95	-	4.86	4.96	5.12	-
		AMPS	9.5	9.7	10.0	-	10.3	10.5	10.8	-	11.1	11.4	11.7	-	11.8	12.1	12.5	-	12.6	12.9	13.3	-	13.3	13.6	14.1	-
		HI PR	141	152	160	-	158	170	180	-	180	194	205	-	205	221	233	-	231	248	262	-	255	274	290	-
	LO PR	60	63	69	-	63	67	73	-	66	70	76	-	69	73	80	-	72	77	84	-	75	79	87	-	
	1900	MBh	54.2	56.2	61.6	-	53.0	54.9	60.1	-	51.7	53.6	58.7	-	50.4	52.3	57.3	-	47.9	49.7	54.4	-	44.4	46.0	50.4	-
		S/T	0.70	0.58	0.40	-	0.72	0.61	0.42	-	0.74	0.62	0.43	-	0.77	0.64	0.44	-	0.80	0.66	0.46	-	0.80	0.67	0.46	-
		Delta T	18	16	12	-	19	16	12	-	19	16	12	-	19	16	12	-	18	16	12	-	17	15	11	-
		KW	3.88	3.95	4.07	-	4.16	4.24	4.37	-	4.41	4.50	4.64	-	4.63	4.73	4.88	-	4.82	4.92	5.08	-	4.98	5.09	5.25	-
		AMPS	9.8	10.0	10.3	-	10.5	10.8	11.1	-	11.4	11.7	12.1	-	12.2	12.5	12.9	-	12.9	13.2	13.7	-	13.7	14.0	14.5	-
HI PR		146	157	165	-	163	176	186	-	186	200	211	-	212	228	240	-	238	256	270	-	263	283	299	-	
LO PR	62	65	71	-	65	69	75	-	68	72	78	-	71	75	82	-	74	79	86	-	77	82	89	-		
2000	MBh	54.8	56.8	62.2	-	53.5	55.4	60.8	-	52.2	54.1	59.3	-	50.9	52.8	57.9	-	48.4	50.2	55.0	-	44.8	46.5	50.9	-	
	S/T	0.71	0.60	0.41	-	0.74	0.62	0.43	-	0.76	0.63	0.44	-	0.78	0.65	0.45	-	0.81	0.68	0.47	-	0.82	0.68	0.47	-	
	Delta T	18	16	12	-	18	16	12	-	18	16	12	-	18	16	12	-	18	16	12	-	17	15	11	-	
	KW	3.89	3.96	4.08	-	4.17	4.25	4.39	-	4.42	4.51	4.65	-	4.64	4.74	4.89	-	4.83	4.93	5.09	-	4.99	5.10	5.26	-	
	AMPS	9.8	10.0	10.3	-	10.6	10.8	11.1	-	11.4	11.7	12.1	-	12.2	12.5	12.9	-	13.0	13.3	13.7	-	13.7	14.0	14.5	-	
	HI PR	146	157	166	-	164	176	186	-	186	200	212	-	212	228	241	-	239	257	271	-	264	284	300	-	
LO PR	62	66	72	-	65	69	76	-	68	72	79	-	71	76	83	-	75	79	87	-	77	82	90	-		
75	1600	MBh	50.9	52.4	56.7	60.9	49.7	51.2	55.4	59.5	48.5	50.0	54.1	58.1	47.3	48.8	52.8	56.6	45.0	46.3	50.1	53.8	41.7	42.9	46.4	49.8
		S/T	0.77	0.69	0.52	0.33	0.79	0.71	0.54	0.35	0.81	0.73	0.55	0.35	0.84	0.75	0.57	0.37	0.87	0.78	0.59	0.38	0.88	0.79	0.60	0.38
		Delta T	22	21	17	12	23	21	17	12	23	21	17	12	23	21	17	12	23	21	17	12	21	19	16	11
		KW	3.82	3.89	4.01	4.13	4.10	4.18	4.31	4.44	4.34	4.43	4.57	4.71	4.56	4.65	4.80	4.95	4.74	4.84	4.99	5.16	4.90	5.00	5.16	5.33
		AMPS	9.6	9.8	10.1	10.5	10.3	10.6	10.9	11.3	11.2	11.5	11.8	12.3	12.0	12.2	12.6	13.1	12.7	13.0	13.4	13.9	13.4	13.8	14.2	14.7
		HI PR	143	153	162	169	160	172	182	190	182	196	207	216	207	223	236	246	233	251	265	276	258	277	293	305
	LO PR	60	64	70	75	64	68	74	79	66	70	77	82	70	74	81	86	73	78	85	90	75	80	88	93	
	1900	MBh	55.1	56.8	61.5	66.0	53.9	55.5	60.0	64.4	52.6	54.1	58.6	62.9	51.3	52.8	57.2	61.4	48.7	50.2	54.3	58.3	45.1	46.5	50.3	54.0
		S/T	0.79	0.71	0.54	0.35	0.82	0.74	0.56	0.36	0.84	0.76	0.57	0.37	0.87	0.78	0.59	0.38	0.90	0.81	0.61	0.39	0.91	0.82	0.62	0.40
		Delta T	21	20	16	11	21	20	16	11	21	20	16	11	22	20	16	11	21	20	16	11	20	18	15	10
		KW	3.91	3.99	4.10	4.23	4.19	4.28	4.41	4.55	4.44	4.54	4.68	4.83	4.67	4.77	4.92	5.07	4.86	4.96	5.12	5.28	5.02	5.13	5.29	5.47
		AMPS	9.9	10.1	10.4	10.8	10.6	10.9	11.2	11.6	11.5	11.8	12.2	12.6	12.3	12.6	13.0	13.5	13.0	13.4	13.8	14.3	13.8	14.1	14.6	15.2
HI PR		147	158	167	174	165	178	187	196	188	202	213	222	214	230	243	253	240	259	273	285	266	286	302	315	
LO PR	62	66	72	77	66	70	76	81	68	73	79	84	72	76	83	89	75	80	87	93	78	83	90	96		
2000	MBh	55.7	57.3	62.1	66.6	54.4	56.0	60.6	65.1	53.1	54.7	59.2	63.5	51.8	53.3	57.7	62.0	49.2	50.7	54.9	58.9	45.6	46.9	50.8	54.5	
	S/T	0.81	0.73	0.55	0.35	0.84	0.75	0.57	0.37	0.86	0.77	0.58	0.38	0.89	0.80	0.60	0.39	0.92	0.83	0.62	0.40	0.93	0.83	0.63	0.41	
	Delta T	21	19	16	11	21	19	16	11	21	19	16	11	21	20	16	11	21	19	16	11	20	18	15	10	
	KW	3.92	3.99	4.11	4.24	4.20	4.29	4.42	4.56	4.45	4.55	4.69	4.84	4.68	4.78	4.93	5.09	4.87	4.97	5.13	5.30	5.03	5.14	5.31	5.48	
	AMPS	9.9	10.1	10.4	10.8	10.7	10.9	11.2	11.7	11.5	11.8	12.2	12.6	12.3	12.6	13.0	13.5	13.1	13.4	13.8	14.4	13.8	14.2	14.6	15.2	
	HI PR	147	159	168	175	165	178	188	196	188	203	214	223	214	231	244	254	241	259	274	286	266	287	303	316	
LO PR	62	66	72	77	66	70	76	81	68	73	80	85	72	76	84	89	75	80	88	93	78	83	91	96		

* Entering Indoor Dry Bulb Temperature

NOTE: Shaded area is ACOA (TVA) conditions

COOLING PERFORMANCE DATA

GSC130603B*

EXPANDED PERFORMANCE DATA

COOLING OPERATION

MODEL: GSC130603B* / CA*F4961*6A*

IDB*	Airflow	Outdoor Ambient Temperature																												
		65				75				85				95				105				115								
		59	63	67	71	59	63	67	71	59	63	67	71	59	63	67	71	59	63	67	71	59	63	67	71					
80	1600	MBh	51.8	52.9	56.6	60.5	50.6	51.7	55.2	59.1	49.4	50.5	53.9	57.6	48.2	49.2	52.6	56.2	46.8	46.8	50.0	53.4	45.8	46.8	50.0	53.4	42.4	43.3	46.3	49.5
		S/T	0.84	0.79	0.64	0.48	0.87	0.82	0.67	0.50	0.89	0.84	0.68	0.51	0.92	0.86	0.70	0.53	0.96	0.90	0.73	0.55	0.97	0.91	0.74	0.55	0.97	0.91	0.74	0.55
		Delta T	25	24	21	17	25	24	21	17	25	24	21	17	26	24	21	17	25	24	21	17	24	23	20	16	24	23	20	16
		KW	3.85	3.92	4.04	4.16	4.13	4.21	4.34	4.48	4.37	4.47	4.60	4.75	4.59	4.69	4.84	4.99	4.78	4.88	5.03	5.20	4.94	5.04	5.21	5.38	4.94	5.04	5.21	5.38
		AMPS	9.7	9.9	10.2	10.6	10.4	10.7	11.0	11.4	11.3	11.6	11.9	12.4	12.1	12.3	12.7	13.2	12.8	13.1	13.5	14.0	13.6	13.9	14.3	14.9	13.6	13.9	14.3	14.9
	1900	HI PR	144	155	164	171	162	174	184	192	184	198	209	218	209	225	238	248	236	253	268	279	260	280	296	308	260	280	296	308
		LO PR	61	65	71	75	64	68	75	80	67	71	78	83	70	75	82	87	74	78	85	91	76	81	88	94	76	81	88	94
		MBh	56.1	57.4	61.3	66.5	54.8	56.0	59.9	64.0	53.5	54.7	58.4	62.5	52.2	53.4	57.0	60.9	49.6	50.7	54.2	57.9	45.9	46.9	50.2	53.6	45.9	46.9	50.2	53.6
		S/T	0.87	0.82	0.67	0.50	0.90	0.85	0.69	0.52	0.93	0.87	0.71	0.53	0.96	0.90	0.73	0.55	0.99	0.93	0.76	0.57	1.00	0.94	0.76	0.57	1.00	0.94	0.76	0.57
		Delta T	24	23	20	16	24	23	20	16	24	23	20	16	24	23	20	16	24	23	20	16	22	21	19	15	22	21	19	15
2000	KW	3.94	4.02	4.14	4.26	4.22	4.31	4.44	4.58	4.48	4.57	4.72	4.87	4.70	4.80	4.96	5.12	4.90	5.00	5.16	5.33	5.06	5.17	5.34	5.51	5.06	5.17	5.34	5.51	
	AMPS	9.9	10.2	10.5	10.9	10.7	11.0	11.3	11.7	11.6	11.9	12.3	12.7	12.4	12.7	13.1	13.6	13.2	13.5	13.9	14.4	13.9	14.3	14.7	15.3	13.9	14.3	14.7	15.3	
	HI PR	149	160	169	176	167	179	189	198	190	204	215	225	216	232	245	256	243	261	276	288	268	289	305	318	268	289	305	318	
	LO PR	63	67	73	78	66	71	77	82	69	73	80	85	72	77	84	90	76	81	88	94	78	84	91	97	78	84	91	97	
	MBh	56.7	57.9	61.9	66.2	55.4	56.6	60.4	64.6	54.1	55.2	59.0	63.1	52.7	53.9	57.6	61.5	50.1	51.2	54.7	58.5	46.4	47.4	50.7	54.2	46.4	47.4	50.7	54.2	

1600	MBh	52.7	53.7	56.3	60.0	51.5	52.5	55.0	58.6	50.3	51.2	53.7	57.2	49.0	50.0	52.3	55.8	46.6	47.5	49.7	53.1	43.1	44.0	46.1	49.1
	S/T	0.88	0.85	0.77	0.62	0.91	0.88	0.80	0.65	0.94	0.90	0.82	0.66	0.97	0.93	0.84	0.68	1.00	0.97	0.87	0.71	1.00	0.98	0.88	0.71
	Delta T	27	26	25	21	27	27	25	22	27	27	25	22	27	27	25	22	27	26	25	22	25	25	23	20
	KW	3.88	3.95	4.07	4.20	4.16	4.24	4.37	4.51	4.41	4.50	4.64	4.79	4.63	4.73	4.88	5.03	4.82	4.92	5.08	5.24	4.98	5.08	5.25	5.42
	AMPS	9.8	10.0	10.3	10.7	10.5	10.8	11.1	11.5	11.4	11.7	12.1	12.5	12.2	12.5	12.9	13.3	12.9	13.2	13.7	14.2	13.7	14.0	14.5	15.0
	HI PR	145	157	165	172	163	176	186	194	186	200	211	220	211	228	240	251	238	256	270	282	263	283	299	312
	LO PR	62	65	71	76	65	69	75	80	68	72	78	84	71	75	82	88	74	79	86	92	77	82	89	95
	MBh	57.1	58.2	61.0	65.0	55.8	56.9	59.6	63.5	54.5	55.5	58.1	62.0	53.1	54.2	56.7	60.5	50.5	51.4	53.9	57.5	46.7	47.7	49.9	53.2
	S/T	0.91	0.88	0.80	0.65	0.95	0.91	0.82	0.67	0.97	0.94	0.85	0.69	1.00	0.97	0.87	0.71	1.00	1.00	0.91	0.74	1.00	1.00	0.91	0.74
	Delta T	25	25	23	20	26	25	24	21	26	25	24	21	26	25	24	21	24	25	24	20	23	23	22	19
1900	KW	3.97	4.05	4.17	4.30	4.26	4.35	4.48	4.62	4.51	4.61	4.75	4.91	4.74	4.84	5.00	5.16	4.94	5.04	5.20	5.37	5.10	5.21	5.38	5.56
	AMPS	10.0	10.3	10.6	11.0	10.8	11.1	11.4	11.8	11.7	12.0	12.4	12.8	12.5	12.8	13.2	13.7	13.3	13.6	14.1	14.6	14.1	14.4	14.9	15.4
	HI PR	150	161	170	178	168	181	191	199	191	206	218	227	218	235	248	258	245	264	279	291	271	292	308	321
	LO PR	63	67	74	78	67	71	78	83	70	74	81	86	73	78	85	90	77	82	89	95	79	84	92	98
	MBh	57.7	58.8	61.6	65.7	56.3	57.4	60.1	64.2	55.0	56.1	58.7	62.6	53.7	54.7	57.3	61.1	51.0	52.0	54.4	58.1	47.2	48.1	50.4	53.8
2000	S/T	0.93	0.90	0.81	0.66	0.97	0.93	0.84	0.68	0.99	0.96	0.86	0.70	1.00	0.99	0.89	0.72	1.00	1.00	0.92	0.75	1.00	1.00	0.93	0.76
	Delta T	25	24	23	20	25	25	23	20	25	25	23	20	25	25	23	20	23	24	23	20	22	22	22	19
	KW	3.98	4.06	4.18	4.31	4.27	4.36	4.49	4.63	4.53	4.62	4.77	4.92	4.75	4.85	5.01	5.17	4.95	5.05	5.22	5.39	5.11	5.22	5.39	5.57
	AMPS	10.1	10.3	10.6	11.0	10.8	11.1	11.4	11.9	11.7	12.0	12.4	12.9	12.5	12.8	13.3	13.7	13.3	13.6	14.1	14.6	14.1	14.4	14.9	15.5
	HI PR	150	162	171	178	169	182	192	200	192	207	218	228	219	235	248	259	246	265	280	292	272	293	309	322
LO PR	64	68	74	79	67	71	78	83	70	74	81	86	73	78	85	91	77	82	89	95	80	85	92	98	

* Entering Indoor Dry Bulb Temperature NOTE: Shaded area is AHRI Rating Conditions

COOLING PERFORMANCE DATA

GSC130484A*

EXPANDED PERFORMANCE DATA

COOLING OPERATION

MODEL: GSC130484A* & / CA*F4860*6**+EEP

IDB*	Airflow	Outdoor Ambient Temperature																								
		65				75				85				95				105				115				
		59	63	67	71	59	63	67	71	59	63	67	71	59	63	67	71	59	63	67	71	59	63	67	71	
70	1688	MBh	44.6	46.2	50.6	-	43.5	45.1	49.5	-	42.5	44.1	48.3	-	41.5	43.0	47.1	-	39.4	40.8	44.7	-	36.5	37.8	41.4	-
		S/T	0.75	0.62	0.43	-	0.77	0.65	0.45	-	0.79	0.66	0.46	-	0.82	0.68	0.47	-	0.85	0.71	0.49	-	0.86	0.72	0.50	-
		Delta T	18	16	12	-	18	16	12	-	18	16	12	-	18	16	12	-	18	16	12	-	17	15	11	-
		KW	2.98	3.05	3.16	-	3.24	3.32	3.44	-	3.47	3.56	3.69	-	3.68	3.77	3.90	-	3.85	3.94	4.09	-	4.00	4.10	4.25	-
		AMPS	3.9	4.0	4.1	-	4.2	4.3	4.4	-	4.5	4.7	4.8	-	4.9	5.0	5.1	-	5.2	5.3	5.5	-	5.5	5.6	5.8	-
	1500	HI PR	154	166	175	-	173	186	197	-	197	212	224	-	224	241	255	-	252	271	286	-	278	300	316	-
		LO PR	62	66	72	-	66	70	76	-	68	73	79	-	72	76	83	-	75	80	87	-	78	83	90	-
		MBh	43.3	44.9	49.2	-	42.3	43.8	48.0	-	41.3	42.8	46.9	-	40.3	41.7	45.7	-	38.3	39.6	43.4	-	35.4	36.7	40.2	-
		S/T	0.71	0.59	0.41	-	0.74	0.62	0.43	-	0.76	0.63	0.44	-	0.78	0.65	0.45	-	0.81	0.68	0.47	-	0.82	0.68	0.47	-
		Delta T	19	16	12	-	19	17	13	-	19	17	13	-	19	17	13	-	19	16	12	-	18	15	12	-
75	1688	MBh	45.3	46.7	50.5	54.2	44.3	45.6	49.4	53.0	43.2	44.5	48.2	51.7	42.2	43.4	47.0	50.4	40.1	41.3	44.7	47.9	37.1	38.2	41.4	44.4
		S/T	0.85	0.76	0.57	0.37	0.88	0.79	0.60	0.38	0.90	0.81	0.61	0.39	0.93	0.83	0.63	0.41	0.97	0.86	0.65	0.42	0.97	0.87	0.66	0.42
		Delta T	21	19	16	11	21	20	16	11	21	20	16	11	21	20	16	11	21	19	16	11	20	18	15	10
		KW	3.00	3.08	3.19	3.31	3.27	3.35	3.47	3.60	3.50	3.59	3.72	3.86	3.71	3.80	3.94	4.09	3.89	3.98	4.13	4.28	4.04	4.14	4.29	4.45
		AMPS	3.9	4.0	4.1	4.3	4.2	4.3	4.5	4.6	4.6	4.7	4.9	5.0	4.9	5.0	5.2	5.4	5.2	5.3	5.5	5.7	5.5	5.7	5.8	6.1
	1500	HI PR	156	168	177	185	175	188	199	207	199	214	226	235	226	244	257	268	255	274	289	302	281	303	320	333
		LO PR	63	67	73	78	66	71	77	82	69	73	80	85	72	77	84	90	76	81	88	94	79	84	91	97
		MBh	44.0	45.3	49.1	52.7	43.0	44.3	47.9	51.4	42.0	43.2	46.8	50.2	41.0	42.2	45.6	49.0	38.9	40.1	43.4	46.5	36.0	37.1	40.2	43.1
		S/T	0.81	0.72	0.55	0.35	0.84	0.75	0.57	0.37	0.86	0.77	0.58	0.37	0.89	0.79	0.60	0.39	0.92	0.82	0.62	0.40	0.93	0.83	0.63	0.40
		Delta T	22	20	16	11	22	20	17	12	22	20	17	12	22	21	17	12	22	20	17	11	21	19	15	11
1313	KW	2.98	3.05	3.16	3.28	3.24	3.32	3.44	3.57	3.47	3.56	3.69	3.82	3.68	3.77	3.90	4.05	3.85	3.95	4.09	4.24	4.00	4.10	4.25	4.41	
	AMPS	3.9	4.0	4.1	4.2	4.2	4.3	4.4	4.6	4.5	4.7	4.8	5.0	4.9	5.0	5.1	5.3	5.2	5.3	5.5	5.7	5.5	5.6	5.8	6.0	
	HI PR	154	166	175	183	173	186	197	205	197	212	224	233	224	241	255	266	252	271	286	299	279	300	316	330	
	LO PR	62	66	72	77	66	70	76	81	68	73	79	84	72	76	83	89	75	80	87	93	78	83	90	96	
	MBh	40.6	41.8	45.3	48.6	39.7	40.9	44.2	47.5	38.7	39.9	43.2	46.3	37.8	38.9	42.1	45.2	35.9	37.0	40.0	42.9	33.3	34.2	37.1	39.8	
1313	S/T	0.78	0.70	0.53	0.34	0.81	0.72	0.55	0.35	0.83	0.74	0.56	0.36	0.86	0.77	0.58	0.37	0.89	0.79	0.60	0.39	0.90	0.80	0.61	0.39	
	Delta T	22	20	17	12	22	21	17	12	22	21	17	12	23	21	17	12	22	21	17	12	21	19	16	11	
	KW	2.90	2.97	3.07	3.19	3.15	3.23	3.34	3.47	3.38	3.46	3.58	3.72	3.57	3.66	3.80	3.94	3.74	3.83	3.98	4.12	3.89	3.98	4.13	4.29	
	AMPS	3.8	3.9	4.0	4.1	4.1	4.2	4.3	4.5	4.4	4.5	4.7	4.8	4.7	4.8	5.0	5.2	5.0	5.1	5.3	5.5	5.3	5.4	5.6	5.8	
	HI PR	150	161	170	177	168	181	191	199	191	205	217	226	217	234	247	258	245	263	278	290	270	291	307	320	
LO PR	60	64	70	75	64	68	74	79	66	70	77	82	70	74	81	86	73	78	85	90	75	80	88	93		

* Entering Indoor Dry Bulb Temperature

NOTE: Shaded area is ACOA (TVA) conditions

COOLING PERFORMANCE DATA

GSC130484A*

EXPANDED PERFORMANCE DATA

COOLING OPERATION

MODEL: GSC130484A* & / CA*F4860*6**+EEP

IDB*	Airflow	Outdoor Ambient Temperature																								
		65				75				85				95				105				115				
		59	63	67	71	59	63	67	71	59	63	67	71	59	63	67	71	59	63	67	71	59	63	67	71	
80	1688	MBh	46.1	47.2	50.4	53.9	45.1	46.1	49.2	52.6	44.0	45.0	48.0	51.4	42.9	43.9	46.9	50.1	40.8	41.7	44.5	47.6	37.8	38.6	41.2	44.1
		S/T	0.93	0.87	0.71	0.53	0.96	0.90	0.74	0.55	1.00	0.93	0.75	0.56	1.00	0.96	0.78	0.58	1.00	1.00	0.81	0.60	1.00	1.00	0.82	0.61
		Delta T	23	22	19	16	24	23	20	16	24	23	20	16	23	23	20	16	22	23	20	16	21	21	18	15
		KW	3.03	3.11	3.22	3.34	3.30	3.38	3.50	3.63	3.54	3.62	3.76	3.90	3.74	3.84	3.98	4.13	3.92	4.02	4.17	4.32	4.07	4.18	4.33	4.49
		AMPS	3.9	4.0	4.2	4.3	4.3	4.4	4.5	4.7	4.6	4.7	4.9	5.1	4.9	5.1	5.2	5.4	5.3	5.4	5.6	5.8	5.6	5.7	5.9	6.1
	1500	HI PR	157	169	179	186	176	190	201	209	201	216	228	238	229	246	260	271	257	277	292	305	284	306	323	337
		LO PR	63	68	74	78	67	71	78	83	70	74	81	86	73	78	85	91	77	82	89	95	79	84	92	98
		MBh	44.8	45.8	48.9	52.3	43.8	44.7	47.8	51.1	42.7	43.7	46.6	49.9	41.7	42.6	45.5	48.6	39.6	40.5	43.2	46.2	36.7	37.5	40.0	42.8
		S/T	0.89	0.83	0.68	0.51	0.92	0.86	0.70	0.52	0.94	0.88	0.72	0.54	0.97	0.91	0.74	0.56	1.00	0.95	0.77	0.58	1.00	0.96	0.78	0.58
		Delta T	24	23	20	16	25	24	21	16	25	24	21	16	25	24	21	17	24	23	20	16	22	22	19	15
1313	1688	KW	3.01	3.08	3.19	3.31	3.27	3.35	3.47	3.60	3.50	3.59	3.72	3.86	3.71	3.80	3.94	4.09	3.89	3.98	4.13	4.28	4.04	4.14	4.29	4.45
		AMPS	3.9	4.0	4.1	4.3	4.2	4.3	4.5	4.6	4.6	4.7	4.9	5.0	4.9	5.0	5.2	5.4	5.2	5.3	5.5	5.7	5.5	5.7	5.8	6.1
		HI PR	156	168	177	185	175	188	199	207	199	214	226	236	226	244	257	268	255	274	289	302	281	303	320	333
		LO PR	63	67	73	78	66	71	77	82	69	73	80	85	72	77	84	90	76	81	88	94	79	84	91	97
		MBh	41.4	42.3	45.1	48.3	40.4	41.3	44.1	47.1	39.4	40.3	43.0	46.0	38.5	39.3	42.0	44.9	36.5	37.3	39.9	42.6	33.9	34.6	37.0	39.5
	1500	S/T	0.86	0.80	0.65	0.49	0.89	0.83	0.68	0.51	0.91	0.85	0.69	0.52	0.94	0.88	0.72	0.54	0.97	0.91	0.74	0.56	0.98	0.92	0.75	0.56
		Delta T	25	24	21	16	25	24	21	17	25	24	21	17	25	24	21	17	25	24	21	17	23	22	19	16
		KW	2.92	2.99	3.10	3.21	3.18	3.26	3.38	3.50	3.41	3.49	3.62	3.75	3.61	3.70	3.83	3.97	3.78	3.87	4.01	4.16	3.92	4.02	4.17	4.33
		AMPS	3.8	3.9	4.0	4.2	4.1	4.2	4.3	4.5	4.5	4.6	4.7	4.9	4.8	4.9	5.0	5.2	5.1	5.2	5.4	5.6	5.4	5.5	5.7	5.9
		HI PR	151	163	172	179	169	182	193	201	193	207	219	228	220	236	249	260	247	266	281	293	273	294	310	323
85	1688	LO PR	61	65	71	75	64	69	75	80	67	71	78	83	70	75	82	87	74	78	86	91	76	81	89	94
		MBh	47.0	47.9	50.1	53.5	45.9	46.7	49.0	52.2	44.8	45.6	47.8	51.0	43.7	44.5	46.6	49.7	41.5	42.3	44.3	47.3	38.4	39.2	41.0	43.8
		S/T	0.98	0.94	0.85	0.69	1.00	0.98	0.88	0.71	1.00	1.00	0.90	0.73	1.00	1.00	0.93	0.76	1.00	1.00	0.97	0.78	1.00	1.00	0.97	0.79
		Delta T	25	25	23	20	25	25	23	20	24	25	24	20	24	24	24	20	23	23	23	20	21	21	22	19
		KW	3.06	3.13	3.25	3.37	3.33	3.41	3.54	3.67	3.57	3.66	3.79	3.93	3.78	3.87	4.02	4.17	3.96	4.06	4.21	4.36	4.11	4.22	4.37	4.54
	1500	AMPS	4.0	4.1	4.2	4.4	4.3	4.4	4.5	4.7	4.7	4.8	4.9	5.1	5.0	5.1	5.3	5.5	5.3	5.4	5.6	5.8	5.6	5.8	6.0	6.2
		HI PR	159	171	180	188	178	192	203	211	203	218	230	240	231	248	262	274	260	280	295	308	287	309	326	340
		LO PR	64	68	74	79	68	72	79	84	70	75	82	87	74	79	86	91	77	82	90	96	80	85	93	99
		MBh	45.6	46.5	48.7	51.9	44.5	45.4	47.5	50.7	43.5	44.3	46.4	49.5	42.4	43.2	45.3	48.3	40.3	41.1	43.0	45.9	37.3	38.0	39.8	42.5
		S/T	0.93	0.90	0.81	0.66	0.96	0.93	0.84	0.68	0.99	0.95	0.86	0.70	1.00	0.98	0.89	0.72	1.00	1.00	0.92	0.75	1.00	1.00	0.93	0.75
1313	1688	Delta T	26	26	24	21	26	26	24	21	26	26	24	21	26	26	25	21	25	25	24	21	23	23	23	20
		KW	3.03	3.11	3.22	3.34	3.30	3.38	3.50	3.63	3.54	3.62	3.76	3.90	3.74	3.84	3.98	4.13	3.92	4.02	4.17	4.32	4.07	4.18	4.33	4.49
		AMPS	3.9	4.0	4.2	4.3	4.3	4.4	4.5	4.7	4.6	4.7	4.9	5.1	4.9	5.1	5.2	5.4	5.3	5.4	5.6	5.8	5.6	5.7	5.9	6.1
		HI PR	157	169	179	186	176	190	201	209	201	216	228	238	229	246	260	271	257	277	292	305	284	306	323	337
		LO PR	63	68	74	78	67	71	78	83	70	74	81	86	73	78	85	91	77	82	89	95	79	84	92	98
	1500	MBh	42.1	42.9	44.9	47.9	41.1	41.9	43.9	46.8	40.1	40.9	42.8	45.7	39.1	39.9	41.8	44.6	37.2	37.9	39.7	42.4	34.4	35.1	36.8	39.2
		S/T	0.90	0.87	0.78	0.63	0.93	0.90	0.81	0.66	0.95	0.92	0.83	0.67	0.98	0.95	0.86	0.70	1.00	0.99	0.89	0.72	1.00	0.99	0.90	0.73
		Delta T	26	26	25	21	27	26	25	22	27	26	25	22	27	27	25	22	26	26	25	21	24	24	23	20
		KW	2.95	3.02	3.13	3.24	3.21	3.29	3.41	3.53	3.44	3.52	3.65	3.79	3.64	3.73	3.87	4.01	3.81	3.91	4.05	4.20	3.96	4.06	4.21	4.37
		AMPS	3.8	3.9	4.1	4.2	4.1	4.2	4.4	4.5	4.5	4.6	4.8	4.9	4.8	4.9	5.1	5.3	5.1	5.2	5.4	5.6	5.4	5.5	5.7	6.0
85	1313	HI PR	153	164	173	181	171	184	195	203	195	209	221	231	222	239	252	263	249	268	283	296	276	297	313	327
		LO PR	62	65	71	76	65	69	76	80	68	72	79	84	71	76	82	88	74	79	86	92	77	82	89	95

NOTE: Shaded area is AHRI Rating Conditions

* Entering Indoor Dry Bulb Temperature

COOLING PERFORMANCE DATA

GSC130484B*

EXPANDED PERFORMANCE DATA

EXPANDED PERFORMANCE DATA

MODEL: GSC130484B* & CA*F4860*6D*

IDB*	Airflow	Outdoor Ambient Temperature												Cooling Operation												
		65				75				85				95				105				115				
		59	63	67	71	59	63	67	71	59	63	67	71	59	63	67	71	59	63	67	71	59	63	67	71	
70	1400	MBh	42.6	44.2	48.4	-	41.6	43.2	47.3	-	40.7	42.1	46.2	-	39.7	41.1	45.0	-	37.7	39.1	42.8	-	34.9	36.2	39.6	-
		S/T	0.69	0.58	0.40	-	0.72	0.60	0.42	-	0.74	0.61	0.43	-	0.76	0.63	0.44	-	0.79	0.66	0.46	-	0.80	0.66	0.46	-
		Delta T	19	17	13	-	20	17	13	-	20	17	13	-	20	17	13	-	20	17	13	-	18	16	12	-
		KW	2.94	3.01	3.12	-	3.20	3.28	3.40	-	3.43	3.51	3.64	-	3.63	3.72	3.86	-	3.81	3.90	4.05	-	3.96	4.06	4.21	-
		AMPS	4.4	4.5	4.6	-	4.7	4.8	5.0	-	5.1	5.2	5.4	-	5.5	5.6	5.8	-	5.8	6.0	6.2	-	6.2	6.3	6.5	-
		HI PR	146	158	166	-	164	177	187	-	187	201	212	-	213	229	242	-	239	258	272	-	264	285	301	-
		LO PR	61	65	71	-	64	69	75	-	67	71	78	-	70	75	82	-	74	78	86	-	76	81	89	-
		MBh	43.3	44.9	49.2	-	42.3	43.8	48.0	-	41.3	42.8	46.9	-	40.3	41.7	45.7	-	38.3	39.6	43.4	-	35.4	36.7	40.2	-
		S/T	0.72	0.60	0.42	-	0.74	0.62	0.43	-	0.76	0.64	0.44	-	0.79	0.66	0.46	-	0.82	0.68	0.47	-	0.82	0.69	0.48	-
		Delta T	18	16	12	-	19	16	12	-	19	16	12	-	19	16	12	-	19	16	12	-	17	15	11	-
1550	1400	KW	2.98	3.06	3.17	-	3.25	3.33	3.45	-	3.48	3.57	3.70	-	3.69	3.78	3.92	-	3.87	3.97	4.11	-	4.02	4.12	4.28	-
		AMPS	4.4	4.5	4.7	-	4.8	4.9	5.1	-	5.2	5.3	5.5	-	5.6	5.7	5.9	-	5.9	6.1	6.3	-	6.3	6.4	6.7	-
		HI PR	149	160	169	-	167	180	190	-	190	205	216	-	216	233	246	-	244	262	277	-	269	290	306	-
		LO PR	62	66	72	-	66	70	76	-	68	72	79	-	72	76	83	-	75	80	87	-	78	83	90	-
		MBh	44.6	46.2	50.6	-	43.5	45.1	49.5	-	42.5	44.1	48.3	-	41.5	43.0	47.1	-	39.4	40.8	44.7	-	36.5	37.8	41.4	-
		S/T	0.75	0.63	0.44	-	0.78	0.65	0.45	-	0.80	0.67	0.46	-	0.83	0.69	0.48	-	0.86	0.72	0.50	-	0.86	0.72	0.50	-
		Delta T	17	15	11	-	17	15	11	-	17	15	11	-	18	15	12	-	17	15	11	-	16	14	11	-
		KW	3.01	3.08	3.20	-	3.28	3.36	3.48	-	3.52	3.60	3.74	-	3.73	3.82	3.96	-	3.90	4.00	4.15	-	4.06	4.16	4.32	-
		AMPS	4.5	4.6	4.7	-	4.8	4.9	5.1	-	5.2	5.4	5.6	-	5.6	5.7	5.9	-	6.0	6.1	6.3	-	6.3	6.5	6.7	-
		HI PR	150	162	171	-	169	182	192	-	192	207	218	-	219	235	248	-	246	265	279	-	272	292	309	-
LO PR	63	67	73	-	66	70	77	-	69	73	80	-	72	77	84	-	76	81	88	-	78	83	91	-		

75	1400	MBh	43.4	44.6	48.3	51.9	42.4	43.6	47.2	50.7	41.3	42.6	46.1	49.5	40.3	41.5	45.0	48.2	38.3	39.5	42.7	45.8	35.5	36.5	39.6	42.5
		S/T	0.79	0.70	0.53	0.34	0.82	0.73	0.55	0.36	0.84	0.75	0.57	0.36	0.86	0.77	0.58	0.38	0.90	0.80	0.61	0.39	0.90	0.81	0.61	0.39
		Delta T	22	21	17	12	23	21	17	12	23	21	17	12	23	21	17	12	23	21	17	12	21	19	16	11
		KW	2.96	3.04	3.15	3.26	3.23	3.31	3.43	3.56	3.46	3.55	3.68	3.82	3.67	3.76	3.90	4.05	3.84	3.94	4.09	4.24	3.99	4.09	4.25	4.41
		AMPS	4.4	4.5	4.6	4.8	4.7	4.9	5.0	5.2	5.2	5.3	5.5	5.7	5.5	5.7	5.8	6.1	5.9	6.0	6.2	6.5	6.2	6.4	6.6	6.9
		HI PR	148	159	168	175	166	179	189	197	189	203	214	224	215	231	244	255	242	260	275	287	267	288	304	317
		LO PR	62	66	72	76	65	69	76	81	68	72	79	84	71	76	83	88	74	79	86	92	77	82	89	95
		MBh	44.0	45.3	49.1	52.7	43.0	44.3	47.9	51.4	42.0	43.2	46.8	50.2	41.0	42.2	45.6	49.0	38.9	40.1	43.4	46.5	36.0	37.1	40.2	43.1
		S/T	0.82	0.73	0.55	0.36	0.85	0.76	0.57	0.37	0.87	0.78	0.59	0.38	0.90	0.80	0.61	0.39	0.93	0.83	0.63	0.40	0.94	0.84	0.63	0.41
		Delta T	21	20	16	11	22	20	16	11	22	20	16	11	22	20	16	11	21	20	16	11	20	18	15	10
1550	1400	KW	3.01	3.08	3.20	3.32	3.28	3.36	3.48	3.61	3.52	3.61	3.74	3.88	3.73	3.82	3.96	4.11	3.91	4.00	4.15	4.31	4.06	4.16	4.32	4.48
		AMPS	4.5	4.6	4.7	4.9	4.8	4.9	5.1	5.3	5.2	5.4	5.6	5.8	5.6	5.7	5.9	6.2	6.0	6.1	6.3	6.6	6.3	6.5	6.7	7.0
		HI PR	150	162	171	178	169	182	192	200	192	207	218	228	219	235	248	259	246	265	280	292	272	293	309	322
		LO PR	63	67	73	78	66	70	77	82	69	73	80	85	72	77	84	89	76	81	88	94	78	83	91	97
		MBh	45.3	46.7	50.5	54.2	44.3	45.6	49.4	53.0	43.2	44.5	48.2	51.7	42.2	43.4	47.0	50.4	40.1	41.3	44.7	47.9	37.1	38.2	41.4	44.4
		S/T	0.86	0.77	0.58	0.37	0.89	0.79	0.60	0.39	0.91	0.81	0.62	0.40	0.94	0.84	0.64	0.41	0.97	0.87	0.66	0.42	0.98	0.88	0.67	0.43
		Delta T	20	18	15	10	20	18	15	10	20	19	15	10	20	19	15	11	20	18	15	10	19	17	14	10
		KW	3.04	3.11	3.23	3.35	3.31	3.39	3.52	3.65	3.55	3.64	3.77	3.92	3.76	3.86	4.00	4.15	3.94	4.04	4.19	4.35	4.10	4.20	4.36	4.52
		AMPS	4.5	4.6	4.8	4.9	4.9	5.0	5.2	5.3	5.3	5.4	5.6	5.8	5.7	5.8	6.0	6.2	6.0	6.2	6.4	6.6	6.4	6.6	6.8	7.0
		HI PR	152	164	173	180	171	183	194	202	194	209	220	230	221	238	251	262	248	267	282	294	275	295	312	325
LO PR	63	67	74	78	67	71	78	83	70	74	81	86	73	78	85	90	77	81	89	95	79	84	92	98		

* Entering Indoor Dry Bulb Temperature

NOTE: Shaded area is ACOA (TVA) conditions

COOLING PERFORMANCE DATA

GSC130484B*

EXPANDED PERFORMANCE DATA

COOLING OPERATION

MODEL: GSC130484B* & CA*F4860*6D*

IDB*	Airflow	Outdoor Ambient Temperature																													
		65					75					85					95					105					115				
		59	63	67	71	75	59	63	67	71	75	59	63	67	71	75	59	63	67	71	75	59	63	67	71	75	59	63	67	71	75
80	1400	MBh	44.1	45.1	48.2	51.5	43.1	44.0	47.1	50.3	42.1	43.0	45.9	49.1	41.1	41.9	44.8	47.9	39.0	39.9	42.6	45.5	36.1	36.9	39.4	42.2					
		S/T	0.86	0.81	0.66	0.49	0.90	0.84	0.68	0.51	0.92	0.86	0.70	0.52	0.95	0.89	0.72	0.54	0.98	0.92	0.75	0.56	0.99	0.93	0.76	0.57					
		Delta T	25	24	21	17	25	24	21	17	25	24	21	17	26	24	21	17	25	24	21	17	24	23	20	16					
		KW	2.99	3.06	3.18	3.29	3.26	3.34	3.46	3.59	3.49	3.58	3.71	3.85	3.70	3.80	3.94	4.08	3.88	3.98	4.12	4.28	4.03	4.13	4.29	4.45					
		AMPS	4.4	4.5	4.7	4.9	4.8	4.9	5.1	5.3	5.2	5.3	5.5	5.7	5.6	5.7	5.9	6.1	5.9	6.1	6.3	6.5	6.3	6.5	6.7	6.9					
	1550	HI PR	149	161	170	177	168	180	190	199	191	205	217	226	217	234	247	257	244	263	278	290	270	290	307	320					
		LO PR	62	66	72	77	66	70	76	81	68	73	79	85	72	76	83	89	75	80	87	93	78	83	90	96					
		MBh	44.8	45.8	48.9	52.3	43.8	44.7	47.8	51.1	42.7	43.7	46.6	49.9	41.7	42.6	45.5	48.6	39.6	40.5	43.2	46.2	36.7	37.5	40.0	42.8					
		S/T	0.90	0.84	0.68	0.51	0.93	0.87	0.71	0.53	0.95	0.89	0.73	0.54	0.98	0.92	0.75	0.56	1.00	0.96	0.78	0.58	1.00	0.96	0.78	0.59					
		Delta T	24	23	20	16	24	23	20	16	24	23	20	16	24	23	20	16	23	23	20	16	22	21	19	15					
1800	KW	3.04	3.11	3.23	3.35	3.31	3.39	3.52	3.65	3.55	3.64	3.77	3.92	3.76	3.86	4.00	4.15	3.94	4.04	4.19	4.35	4.10	4.20	4.36	4.52						
	AMPS	4.5	4.6	4.8	4.9	4.9	5.0	5.2	5.3	5.3	5.4	5.6	5.8	5.7	5.8	6.0	6.2	6.0	6.2	6.4	6.6	6.4	6.6	6.8	7.0						
	HI PR	152	164	173	180	171	184	194	202	194	209	220	230	221	238	251	262	248	267	282	295	275	295	312	325						
	LO PR	63	67	74	78	67	71	78	83	70	74	81	86	73	78	85	90	77	81	89	96	79	84	92	98						
	MBh	46.1	47.2	50.4	53.9	45.1	46.1	49.2	52.6	44.0	45.0	48.0	51.4	42.9	43.9	46.9	50.1	40.8	41.7	44.5	47.6	37.8	38.6	41.2	44.1						
1400	S/T	0.94	0.88	0.72	0.54	1.00	0.91	0.74	0.56	1.00	0.94	0.76	0.57	1.00	0.97	0.79	0.59	1.00	1.00	0.82	0.61	1.00	1.00	0.82	0.62						
	Delta T	22	21	18	15	23	21	19	15	22	21	19	15	22	22	19	15	21	21	19	15	19	20	17	14						
	KW	3.07	3.14	3.26	3.38	3.34	3.42	3.55	3.68	3.58	3.67	3.81	3.95	3.80	3.89	4.04	4.19	3.98	4.08	4.23	4.39	4.14	4.24	4.40	4.57						
	AMPS	4.5	4.7	4.8	5.0	4.9	5.0	5.2	5.4	5.3	5.5	5.7	5.9	5.7	5.9	6.1	6.3	6.1	6.2	6.5	6.7	6.5	6.6	6.8	7.1						
	HI PR	153	165	174	182	172	185	196	204	196	211	223	232	223	240	254	264	251	270	285	297	277	298	315	329						
LO PR	64	68	74	79	68	72	78	84	70	75	82	87	74	78	86	91	77	82	90	96	79	85	93	99							

1400	MBh	44.9	45.8	47.9	51.1	43.9	44.7	46.8	50.0	42.8	43.6	45.7	48.8	41.8	42.6	44.6	47.6	39.7	40.4	42.4	45.2	36.8	37.5	39.2	41.9	
	S/T	0.91	0.87	0.79	0.64	0.94	0.91	0.82	0.66	0.96	0.93	0.84	0.68	0.99	0.96	0.87	0.70	1.00	1.00	0.99	0.90	0.73	1.00	1.00	0.91	0.73
	Delta T	27	26	25	21	27	27	25	22	27	27	25	22	27	27	25	22	26	26	25	22	24	25	23	20	
	KW	3.02	3.09	3.21	3.32	3.29	3.37	3.49	3.62	3.53	3.61	3.75	3.89	3.74	3.83	3.97	4.12	3.92	4.01	4.16	4.32	4.07	4.17	4.33	4.49	
	AMPS	4.5	4.6	4.7	4.9	4.8	5.0	5.1	5.3	5.3	5.4	5.6	5.8	5.6	5.8	6.0	6.2	6.0	6.1	6.3	6.6	6.4	6.5	6.7	7.0	
1550	HI PR	151	162	171	179	169	182	192	201	193	207	219	228	219	236	249	260	247	265	280	292	273	293	310	323	
	LO PR	63	67	73	78	66	71	77	82	69	73	80	85	72	77	84	90	76	81	88	94	79	84	91	97	
	MBh	45.6	46.5	48.7	51.9	44.5	45.4	47.5	50.7	43.5	44.3	46.4	49.5	42.4	43.2	45.3	48.3	40.3	41.1	43.0	45.9	37.3	38.0	39.8	42.5	
	S/T	0.94	0.91	0.82	0.66	0.97	0.94	0.85	0.69	1.00	0.96	0.87	0.71	1.00	0.99	0.90	0.73	1.00	1.00	0.93	0.76	1.00	1.00	0.94	0.76	
	Delta T	25	25	24	20	26	25	24	21	26	25	24	21	25	25	24	21	24	24	24	21	22	23	22	19	
1800	KW	3.07	3.14	3.26	3.38	3.34	3.42	3.55	3.68	3.58	3.67	3.81	3.95	3.80	3.89	4.04	4.19	3.98	4.08	4.23	4.39	4.14	4.24	4.40	4.57	
	AMPS	4.5	4.7	4.8	5.0	4.9	5.0	5.2	5.4	5.3	5.5	5.7	5.9	5.7	5.9	6.1	6.3	6.1	6.2	6.5	6.7	6.5	6.6	6.8	7.1	
	HI PR	153	165	174	182	172	185	196	204	196	211	223	232	223	240	254	264	251	270	285	297	277	298	315	329	
	LO PR	64	68	74	79	68	72	78	84	70	75	82	87	74	78	86	91	77	82	90	96	80	85	93	99	
	MBh	47.0	47.9	50.1	53.5	45.9	46.7	49.0	52.2	44.8	45.6	47.8	51.0	43.7	44.5	46.6	49.7	41.5	42.3	44.3	47.3	38.4	39.2	41.0	43.8	
1400	S/T	0.98	0.95	0.86	0.70	1.00	0.98	0.89	0.72	1.00	1.00	0.91	0.74	1.00	1.00	0.94	0.76	1.00	1.00	0.98	0.79	1.00	1.00	0.98	0.80	
	Delta T	24	23	22	19	23	24	22	19	23	23	22	19	22	23	22	19	21	22	22	19	20	20	21	18	
	KW	3.09	3.17	3.29	3.41	3.37	3.46	3.58	3.72	3.62	3.71	3.85	3.99	3.83	3.93	4.08	4.23	4.02	4.12	4.27	4.43	4.18	4.28	4.44	4.61	
	AMPS	4.6	4.7	4.9	5.0	5.0	5.1	5.2	5.4	5.4	5.5	5.7	5.9	5.8	5.9	6.1	6.3	6.1	6.3	6.5	6.8	6.5	6.7	6.9	7.2	
	HI PR	155	167	176	184	174	187	198	206	198	213	225	234	225	242	256	267	253	273	288	300	280	301	318	332	
LO PR	65	69	75	80	68	73	79	84	71	75	82	88	74	79	87	92	78	83	91	97	81	86	94	100		

NOTE: Shaded area is AHRI Rating Conditions

* Entering Indoor Dry Bulb Temperature

COOLING PERFORMANCE DATA

GSC130604A*

EXPANDED PERFORMANCE DATA

COOLING OPERATION

MODEL: GSC130604A* / CA*F061*2* / CA*F4860*6**

IDB*	Airflow	Outdoor Ambient Temperature																										
		65				75				85				95				105				115						
		59	63	67	71	59	63	67	71	59	63	67	71	59	63	67	71	59	63	67	71	59	63	67	71			
70	1913	MBh	55.9	57.9	63.4	-	54.6	56.5	62.0	-	53.3	55.2	60.5	-	52.0	53.9	59.0	-	49.4	51.2	56.1	-	45.7	47.4	51.9	-		
		S/T	0.73	0.61	0.42	-	0.75	0.63	0.43	-	0.77	0.64	0.45	-	0.80	0.66	0.46	-	0.83	0.69	0.48	-	0.83	0.70	0.48	-		
		Delta T	19	17	13	-	20	17	13	-	20	17	13	-	20	17	13	-	20	17	13	-	18	16	12	-		
		KW	3.72	3.81	3.95	-	4.05	4.15	4.31	-	4.35	4.46	4.62	-	4.61	4.72	4.90	-	4.83	4.95	5.13	-	5.02	5.15	5.34	-		
		AMPS	4.7	4.8	4.9	-	5.1	5.2	5.4	-	5.5	5.6	5.8	-	5.9	6.0	6.2	-	6.3	6.4	6.6	-	6.7	6.8	7.1	-		
		HI PR	146	157	166	-	163	176	186	-	186	200	211	-	212	228	241	-	238	256	271	-	263	283	299	-		
		LO PR	59	63	69	-	63	67	73	-	65	69	76	-	69	73	80	-	72	76	83	-	74	79	86	-		
		MBh	54.2	56.2	61.6	-	53.0	54.9	60.1	-	51.7	53.6	58.7	-	50.4	52.3	57.3	-	47.9	49.7	54.4	-	44.4	46.0	50.4	-		
		S/T	0.69	0.58	0.40	-	0.72	0.60	0.41	-	0.74	0.61	0.43	-	0.76	0.63	0.44	-	0.79	0.66	0.46	-	0.79	0.66	0.46	-		
		Delta T	20	18	13	-	21	18	13	-	21	18	14	-	21	18	14	-	20	18	13	-	19	17	13	-		
75	1700	MBh	50.1	51.9	56.8	-	48.9	50.7	55.5	-	47.7	49.5	54.2	-	46.6	48.3	52.9	-	44.2	45.8	50.2	-	41.0	42.5	46.5	-		
		S/T	0.67	0.56	0.39	-	0.69	0.58	0.40	-	0.71	0.59	0.41	-	0.73	0.61	0.42	-	0.76	0.63	0.44	-	0.77	0.64	0.44	-		
		Delta T	21	18	14	-	21	18	14	-	21	18	14	-	21	18	14	-	21	18	14	-	19	17	13	-		
		KW	3.58	3.67	3.81	-	3.90	4.00	4.15	-	4.19	4.29	4.45	-	4.44	4.55	4.72	-	4.65	4.76	4.94	-	4.83	4.95	5.14	-		
		AMPS	4.5	4.6	4.8	-	4.9	5.0	5.2	-	5.3	5.4	5.6	-	5.7	5.8	6.0	-	6.0	6.2	6.4	-	6.4	6.6	6.8	-		
		HI PR	140	151	159	-	157	169	178	-	179	192	203	-	203	219	231	-	229	246	260	-	253	272	287	-		
		LO PR	57	61	66	-	60	64	70	-	63	67	73	-	66	70	76	-	69	73	80	-	71	76	83	-		
		MBh	56.8	58.5	63.3	67.9	55.5	57.1	61.8	66.4	54.2	55.8	60.4	64.8	52.8	54.4	58.9	63.2	50.2	51.7	55.9	60.0	46.5	47.9	51.8	55.6		
		S/T	0.82	0.74	0.56	0.36	0.85	0.76	0.58	0.37	0.88	0.78	0.59	0.38	0.90	0.81	0.61	0.39	0.94	0.84	0.64	0.41	0.95	0.85	0.64	0.41		
		Delta T	23	21	17	12	23	21	17	12	23	21	17	12	23	21	17	12	23	21	17	12	21	19	16	11		
75	1913	KW	3.75	3.85	3.99	4.14	4.09	4.19	4.35	4.51	4.39	4.50	4.67	4.84	4.65	4.77	4.95	5.13	4.87	5.00	5.18	5.38	5.07	5.19	5.39	5.59		
		AMPS	4.7	4.8	5.0	5.2	5.1	5.2	5.4	5.6	5.6	5.7	5.9	6.1	5.9	6.1	6.3	6.5	6.3	6.5	6.7	7.0	6.7	6.9	7.1	7.4		
		HI PR	147	158	167	174	165	178	188	196	188	202	213	223	214	230	243	254	241	259	273	285	266	286	302	315		
		LO PR	60	64	70	74	63	67	74	78	66	70	77	82	69	74	80	86	73	77	84	90	75	80	87	93		
		MBh	55.1	56.8	61.5	66.0	53.9	55.5	60.0	64.4	52.6	54.1	58.6	62.9	51.3	52.8	57.2	61.4	48.7	50.2	54.3	58.3	45.1	46.5	50.3	54.0		
		S/T	0.79	0.70	0.53	0.34	0.81	0.73	0.55	0.35	0.84	0.75	0.57	0.36	0.86	0.77	0.58	0.38	0.90	0.80	0.61	0.39	0.90	0.81	0.61	0.39		
		Delta T	23	22	18	12	24	22	18	12	24	22	18	12	24	22	18	12	24	22	18	12	22	20	17	11		
		75	1700	KW	3.72	3.81	3.95	4.10	4.05	4.15	4.31	4.47	4.35	4.46	4.62	4.80	4.61	4.72	4.90	5.08	4.83	4.95	5.14	5.33	5.02	5.15	5.34	5.54
				AMPS	4.7	4.8	5.0	5.1	5.1	5.2	5.4	5.6	5.5	5.6	5.8	6.1	5.9	6.0	6.2	6.5	6.3	6.4	6.6	6.9	6.7	6.8	7.1	7.3
				HI PR	146	157	166	173	164	176	186	194	186	200	211	220	212	228	241	251	238	256	271	282	263	283	299	312
LO PR	59			63	69	74	63	67	73	78	65	69	76	81	69	73	80	85	72	76	83	89	74	79	86	92		
MBh	50.9			52.4	56.7	60.9	49.7	51.2	55.4	59.5	48.5	50.0	54.1	58.1	47.3	48.8	52.8	56.6	45.0	46.3	50.1	53.8	41.7	42.9	46.4	49.8		
S/T	0.76			0.68	0.51	0.33	0.79	0.70	0.53	0.34	0.81	0.72	0.55	0.35	0.83	0.74	0.56	0.36	0.86	0.77	0.58	0.38	0.87	0.78	0.59	0.38		
Delta T	24			22	18	12	24	22	18	13	24	22	18	13	24	22	18	13	24	22	18	12	22	21	17	12		
75	1488			KW	3.62	3.71	3.84	3.98	3.94	4.04	4.19	4.34	4.23	4.33	4.49	4.66	4.48	4.59	4.76	4.94	4.69	4.81	4.99	5.18	4.88	5.00	5.19	5.38
				AMPS	4.5	4.7	4.8	5.0	4.9	5.0	5.2	5.4	5.4	5.5	5.7	5.9	5.7	5.9	6.1	6.3	6.1	6.3	6.5	6.7	6.5	6.6	6.9	7.1
				HI PR	141	152	161	168	159	171	180	188	180	194	205	214	205	221	233	243	231	249	263	274	255	275	290	303
		LO PR	58	61	67	71	61	65	71	75	63	67	74	78	67	71	77	82	70	74	81	86	72	77	84	89		

* Entering Indoor Dry Bulb Temperature

NOTE: Shaded area is ACOA (TVA) conditions

COOLING PERFORMANCE DATA

GSC130604A*

EXPANDED PERFORMANCE DATA

COOLING OPERATION

MODEL: GSC130604A* / CA*F061*2 / CA*F4860*6**

IDB*	Airflow	Outdoor Ambient Temperature																													
		65					75					85					95					105					115				
		59	63	67	71	75	59	63	67	71	75	59	63	67	71	75	59	63	67	71	75	59	63	67	71	75	59	63	67	71	75
80	1913	MBh	57.8	59.1	63.1	67.5	56.5	57.7	61.6	65.9	55.1	56.3	60.2	64.3	53.8	55.0	58.7	62.8	62.8	51.1	52.2	55.8	59.6	47.3	48.4	51.7	55.2				
		S/T	0.90	0.85	0.89	0.52	0.94	0.88	0.72	0.53	0.96	0.90	0.73	0.55	1.00	0.93	0.76	0.57	1.00	0.97	0.79	0.59	1.00	1.00	1.00	0.79	0.59				
		Delta T	25	24	21	17	25	24	21	17	25	24	21	17	26	25	21	17	25	24	21	17	23	23	20	16					
		KW	3.79	3.88	4.03	4.18	4.13	4.23	4.39	4.55	4.43	4.54	4.71	4.89	4.70	4.81	4.99	5.18	4.92	5.04	5.23	5.43	5.12	5.24	5.44	5.65					
		AMPS	4.8	4.9	5.0	5.2	5.2	5.3	5.5	5.7	5.6	5.7	5.9	6.2	6.0	6.2	6.4	6.6	6.4	6.6	6.8	7.0	6.8	6.9	7.2	7.5					
	HI PR	149	160	169	176	167	180	190	198	190	204	216	225	216	233	246	256	243	262	276	288	269	289	305	318						
	LO PR	61	65	70	75	64	68	74	79	67	71	77	82	70	74	81	87	73	78	85	91	76	81	88	94						
	1700	MBh	56.1	57.4	61.3	66.5	54.8	56.0	59.9	64.0	53.5	54.7	58.4	62.5	52.2	53.4	57.0	60.9	49.6	50.7	54.2	57.9	45.9	46.9	50.2	53.6					
		S/T	0.86	0.81	0.86	0.49	0.89	0.84	0.68	0.51	0.92	0.86	0.70	0.52	0.95	0.89	0.72	0.54	0.98	0.92	0.75	0.56	0.99	0.93	0.76	0.56					
		Delta T	26	25	22	17	26	25	22	18	27	25	22	18	27	26	22	18	26	25	22	18	25	24	20	16					
KW		3.76	3.85	3.99	4.14	4.09	4.19	4.35	4.51	4.39	4.50	4.67	4.84	4.65	4.77	4.95	5.13	4.88	5.00	5.18	5.38	5.07	5.20	5.39	5.59						
AMPS		4.7	4.8	5.0	5.2	5.1	5.2	5.4	5.6	5.6	5.7	5.9	6.1	5.9	6.1	6.3	6.5	6.3	6.5	6.7	7.0	6.7	6.9	7.1	7.4						
HI PR	147	158	167	174	165	178	188	196	188	202	213	223	214	230	243	254	241	259	273	285	266	286	302	315							
LO PR	60	64	70	74	63	68	74	78	66	70	77	82	69	74	80	86	73	77	84	90	75	80	87	93							
85	1913	MBh	58.8	60.0	62.8	67.0	57.5	58.6	61.3	65.4	56.1	57.2	59.9	63.9	54.7	55.8	58.4	62.3	52.0	53.0	55.5	59.2	48.2	49.1	51.4	54.8					
		S/T	0.95	0.91	0.83	0.67	0.98	0.95	0.86	0.69	1.00	0.97	0.88	0.71	1.00	1.00	0.91	0.73	1.00	1.00	0.94	0.76	1.00	1.00	0.95	0.77					
		Delta T	27	26	25	22	27	27	25	22	27	27	25	22	26	27	25	22	26	25	25	22	23	24	23	20					
		KW	3.82	3.92	4.06	4.22	4.17	4.27	4.43	4.60	4.47	4.58	4.75	4.93	4.74	4.86	5.04	5.23	4.97	5.09	5.28	5.48	5.16	5.29	5.49	5.70					
		AMPS	4.8	4.9	5.1	5.3	5.2	5.3	5.5	5.7	5.7	5.8	6.0	6.2	6.1	6.2	6.4	6.7	6.5	6.6	6.8	7.1	6.8	7.0	7.3	7.5					
	HI PR	150	162	171	178	168	181	191	200	192	206	218	227	218	235	248	259	246	264	279	291	271	292	308	322						
	LO PR	61	65	71	76	65	69	75	80	67	72	78	83	71	75	82	87	74	79	86	92	77	81	89	95						
	1700	MBh	57.1	58.2	61.0	65.0	55.8	56.9	59.6	63.5	54.5	55.5	58.1	62.0	53.1	54.2	56.7	60.5	50.5	51.4	53.9	57.5	46.7	47.7	49.9	53.2					
		S/T	0.90	0.87	0.79	0.64	0.94	0.90	0.82	0.66	0.96	0.93	0.84	0.68	0.99	0.96	0.86	0.70	1.00	0.99	0.90	0.73	1.00	1.00	0.90	0.73					
		Delta T	28	27	26	22	28	28	26	23	28	28	26	23	28	28	26	23	27	28	26	23	25	26	24	21					
KW		3.79	3.88	4.03	4.18	4.13	4.23	4.39	4.55	4.43	4.54	4.71	4.89	4.70	4.81	4.99	5.18	4.92	5.04	5.23	5.43	5.12	5.24	5.44	5.65						
AMPS		4.8	4.9	5.0	5.2	5.2	5.3	5.5	5.7	5.6	5.7	5.9	6.2	6.0	6.2	6.4	6.6	6.4	6.6	6.8	7.0	6.8	6.9	7.2	7.5						
HI PR	149	160	169	176	167	180	190	198	190	204	216	225	216	233	246	256	243	262	276	288	269	289	305	318							
LO PR	61	65	70	75	64	68	74	79	67	71	77	82	70	74	81	87	73	78	85	91	76	81	88	94							
1488	MBh	52.7	53.7	56.3	60.0	51.5	52.5	55.0	58.6	50.3	51.2	53.7	57.2	49.0	50.0	52.3	55.8	46.6	47.5	49.7	53.1	43.1	44.0	46.1	49.1						
	S/T	0.87	0.84	0.76	0.62	0.90	0.87	0.79	0.64	0.93	0.89	0.81	0.65	0.96	0.92	0.83	0.68	0.99	0.96	0.86	0.70	1.00	0.97	0.87	0.71						
	Delta T	28	28	26	23	29	28	27	23	29	28	27	23	29	29	27	23	29	28	27	23	27	26	25	21						
	KW	3.68	3.78	3.91	4.06	4.01	4.11	4.27	4.43	4.31	4.41	4.58	4.75	4.56	4.68	4.85	5.03	4.78	4.90	5.08	5.28	4.97	5.10	5.29	5.49						
	AMPS	4.6	4.7	4.9	5.1	5.0	5.1	5.3	5.5	5.5	5.6	5.8	6.0	5.8	6.0	6.2	6.4	6.2	6.4	6.6	6.8	6.6	6.8	7.0	7.3						
HI PR	144	155	164	171	162	174	184	192	184	198	209	218	210	226	238	248	236	254	268	279	261	280	296	309							
LO PR	59	63	68	73	62	66	72	77	65	69	75	80	68	72	79	84	71	76	83	88	74	78	85	91							

NOTE: Shaded area is AHRI Rating Conditions

* Entering Indoor Dry Bulb Temperature

COOLING PERFORMANCE DATA

GSC130604B*

EXPANDED PERFORMANCE DATA

COOLING OPERATION

MODEL: GSC130604B* / CA*F4961*6A*

IDB*	Airflow	Outdoor Ambient Temperature																								
		65				75				85				95				105				115				
		59	63	67	71	59	63	67	71	59	63	67	71	59	63	67	71	59	63	67	71	59	63	67	71	
70	1600	MBh	50.1	51.9	56.8	-	48.9	50.7	55.5	-	47.7	49.5	54.2	-	46.6	48.3	52.9	-	44.2	45.8	50.2	-	41.0	42.5	46.5	-
		S/T	0.67	0.56	0.39	-	0.70	0.58	0.40	-	0.72	0.60	0.41	-	0.74	0.62	0.43	-	0.77	0.64	0.44	-	0.77	0.65	0.45	-
		Delta T	19	17	13	-	20	17	13	-	20	17	13	-	20	17	13	-	20	17	13	-	18	16	12	-
		KW	3.79	3.86	3.98	-	4.06	4.15	4.27	-	4.31	4.40	4.53	-	4.52	4.61	4.76	-	4.70	4.80	4.95	-	4.86	4.96	5.12	-
		AMPS	5.1	5.2	5.4	-	5.5	5.6	5.8	-	6.0	6.1	6.3	-	6.3	6.5	6.7	-	6.7	6.9	7.1	-	7.1	7.3	7.5	-
		HI PR	141	152	160	-	158	170	180	-	180	194	205	-	205	221	233	-	231	248	262	-	255	274	290	-
70	1900	LO PR	60	63	69	-	63	67	73	-	66	70	76	-	69	73	80	-	72	77	84	-	75	79	87	-
		MBh	54.2	56.2	61.6	-	53.0	54.9	60.1	-	51.7	53.6	58.7	-	50.4	52.3	57.3	-	47.9	49.7	54.4	-	44.4	46.0	50.4	-
		S/T	0.70	0.58	0.40	-	0.72	0.61	0.42	-	0.74	0.62	0.43	-	0.77	0.64	0.44	-	0.80	0.66	0.46	-	0.80	0.67	0.46	-
		Delta T	18	16	12	-	19	16	12	-	19	16	12	-	19	16	12	-	18	16	12	-	17	15	11	-
		KW	3.88	3.95	4.07	-	4.16	4.24	4.37	-	4.41	4.50	4.64	-	4.63	4.73	4.88	-	4.82	4.92	5.08	-	4.98	5.09	5.25	-
		AMPS	5.2	5.4	5.5	-	5.6	5.8	6.0	-	6.1	6.3	6.5	-	6.5	6.7	6.9	-	6.9	7.1	7.3	-	7.3	7.5	7.7	-
70	2000	HI PR	146	157	165	-	163	176	186	-	186	200	211	-	212	228	240	-	238	256	270	-	263	283	299	-
		LO PR	62	65	71	-	65	69	75	-	68	72	78	-	71	75	82	-	74	79	86	-	77	82	89	-
		MBh	54.8	56.8	62.2	-	53.5	55.4	60.8	-	52.2	54.1	59.3	-	50.9	52.8	57.9	-	48.4	50.2	55.0	-	44.8	46.5	50.9	-
		S/T	0.71	0.60	0.41	-	0.74	0.62	0.43	-	0.76	0.63	0.44	-	0.78	0.65	0.45	-	0.81	0.68	0.47	-	0.82	0.68	0.47	-
		Delta T	18	16	12	-	18	16	12	-	18	16	12	-	18	16	12	-	18	16	12	-	17	15	11	-
		KW	3.89	3.96	4.08	-	4.17	4.25	4.39	-	4.42	4.51	4.65	-	4.64	4.74	4.89	-	4.83	4.93	5.09	-	4.99	5.10	5.26	-
75	1600	AMPS	5.3	5.4	5.5	-	5.7	5.8	6.0	-	6.1	6.3	6.5	-	6.5	6.7	6.9	-	6.9	7.1	7.3	-	7.3	7.5	7.7	-
		HI PR	146	157	166	-	164	176	186	-	186	200	212	-	212	228	241	-	239	257	271	-	264	284	300	-
		LO PR	62	66	72	-	65	69	76	-	68	72	79	-	71	76	83	-	75	79	87	-	77	82	90	-
		MBh	50.9	52.4	56.7	60.9	49.7	51.2	55.4	59.5	48.5	50.0	54.1	58.1	47.3	48.8	52.8	56.6	45.0	46.3	50.1	53.8	41.7	42.9	46.4	49.8
		S/T	0.77	0.69	0.52	0.33	0.79	0.71	0.54	0.35	0.81	0.73	0.55	0.35	0.84	0.75	0.57	0.37	0.87	0.78	0.59	0.38	0.88	0.79	0.60	0.38
		Delta T	22	21	17	12	23	21	17	12	23	21	17	12	23	21	17	12	23	21	17	12	21	19	16	11
75	1900	KW	3.82	3.89	4.01	4.13	4.10	4.18	4.31	4.44	4.34	4.43	4.57	4.71	4.56	4.65	4.80	4.95	4.74	4.84	4.99	5.16	4.90	5.00	5.16	5.33
		AMPS	5.2	5.3	5.4	5.6	5.6	5.7	5.9	6.1	6.0	6.1	6.3	6.6	6.4	6.5	6.8	7.0	6.8	6.9	7.2	7.4	7.2	7.3	7.6	7.9
		HI PR	143	153	162	169	160	172	182	190	182	196	207	216	207	223	236	246	233	251	265	276	258	277	293	305
		LO PR	60	64	70	75	64	68	74	79	66	70	77	82	70	74	81	86	73	78	85	90	75	80	88	93
		MBh	55.1	56.8	61.5	66.0	53.9	55.5	60.0	64.4	52.6	54.1	58.6	62.9	51.3	52.8	57.2	61.4	48.7	50.2	54.3	58.3	45.1	46.5	50.3	54.0
		S/T	0.79	0.71	0.54	0.35	0.82	0.74	0.56	0.36	0.84	0.76	0.57	0.37	0.87	0.78	0.59	0.38	0.90	0.81	0.61	0.39	0.91	0.82	0.62	0.40
75	2000	Delta T	21	20	16	11	21	20	16	11	21	20	16	11	22	20	16	11	21	20	16	11	20	18	15	10
		KW	3.91	3.99	4.10	4.23	4.19	4.28	4.41	4.55	4.44	4.54	4.68	4.83	4.67	4.77	4.92	5.07	4.86	4.96	5.12	5.28	5.02	5.13	5.29	5.47
		AMPS	5.3	5.4	5.6	5.8	5.7	5.8	6.0	6.2	6.2	6.3	6.5	6.7	6.6	6.7	6.9	7.2	7.0	7.1	7.4	7.6	7.4	7.5	7.8	8.1
		HI PR	147	158	167	174	165	178	187	196	188	202	213	222	214	230	243	253	240	259	273	285	266	286	302	315
		LO PR	62	66	72	77	66	70	76	81	68	73	79	84	72	76	83	89	75	80	87	93	78	83	90	96
		MBh	55.7	57.3	62.1	66.6	54.4	56.0	60.6	65.1	53.1	54.7	59.2	63.5	51.8	53.3	57.7	62.0	49.2	50.7	54.9	58.9	45.6	46.9	50.8	54.5
S/T	0.81	0.73	0.55	0.35	0.84	0.75	0.57	0.37	0.86	0.77	0.58	0.38	0.89	0.80	0.60	0.39	0.92	0.83	0.62	0.40	0.93	0.83	0.63	0.41		
75	2000	Delta T	21	19	16	11	21	19	16	11	21	19	16	11	21	20	16	11	21	19	16	11	20	18	15	10
		KW	3.92	3.99	4.11	4.24	4.20	4.29	4.42	4.56	4.45	4.55	4.69	4.84	4.68	4.78	4.93	5.09	4.87	4.97	5.13	5.30	5.03	5.14	5.31	5.48
		AMPS	5.3	5.4	5.6	5.8	5.7	5.8	6.0	6.2	6.2	6.3	6.5	6.8	6.6	6.7	7.0	7.2	7.0	7.2	7.4	7.7	7.4	7.6	7.8	8.1
		HI PR	147	159	168	175	165	178	188	196	188	203	214	223	214	231	244	254	241	259	274	286	266	287	303	316
		LO PR	62	66	72	77	66	70	76	81	68	73	80	85	72	76	84	89	75	80	88	93	78	83	91	96
		MBh	55.7	57.3	62.1	66.6	54.4	56.0	60.6	65.1	53.1	54.7	59.2	63.5	51.8	53.3	57.7	62.0	49.2	50.7	54.9	58.9	45.6	46.9	50.8	54.5

* Entering Indoor Dry Bulb Temperature NOTE: Shaded area is ACOA (TVA) conditions

COOLING PERFORMANCE DATA

GSC130604B*

EXPANDED PERFORMANCE DATA

EXPANDED PERFORMANCE DATA

MODEL: GSC130604B* / CA*F4961*6A*

IDB*	Airflow	Outdoor Ambient Temperature												115												
		65			75			85			95				105											
		59	63	67	71	59	63	67	71	59	63	67	71		59	63	67	71								
80	1600	MBh	51.8	52.9	56.6	60.5	50.6	51.7	55.2	59.1	49.4	50.5	53.9	57.6	48.2	49.2	52.6	56.2	46.8	46.8	50.0	53.4	42.4	43.3	46.3	49.5
		S/T	0.84	0.79	0.64	0.48	0.87	0.82	0.67	0.50	0.89	0.84	0.68	0.51	0.92	0.86	0.70	0.53	0.96	0.90	0.73	0.55	0.97	0.91	0.74	0.55
		Delta T	25	24	21	17	25	24	21	17	25	24	21	17	26	24	21	17	25	24	21	17	24	23	20	16
		KW	3.85	3.92	4.04	4.16	4.13	4.21	4.34	4.48	4.37	4.47	4.60	4.75	4.59	4.69	4.84	4.99	4.78	4.88	5.03	5.20	4.94	5.04	5.21	5.38
		AMPS	5.2	5.3	5.5	5.7	5.6	5.7	5.9	6.1	6.1	6.2	6.4	6.6	6.5	6.6	6.8	7.1	6.8	7.0	7.2	7.5	7.2	7.4	7.6	7.9
	1900	LO PR	144	155	164	171	162	174	184	192	184	198	209	218	209	225	238	248	236	253	268	279	260	280	296	308
		MBh	56.1	57.4	61.3	66.5	54.8	56.0	59.9	64.0	53.5	54.7	58.4	62.5	52.2	53.4	57.0	60.9	49.6	50.7	54.2	57.9	45.9	46.9	50.2	53.6
		S/T	0.87	0.82	0.67	0.50	0.90	0.85	0.69	0.52	0.93	0.87	0.71	0.53	0.96	0.90	0.73	0.55	0.99	0.93	0.76	0.57	1.00	0.94	0.76	0.57
		Delta T	24	23	20	16	24	23	20	16	24	23	20	16	24	23	20	16	24	23	20	16	22	21	19	15
		KW	3.94	4.02	4.14	4.26	4.22	4.31	4.44	4.58	4.48	4.57	4.72	4.87	4.70	4.80	4.96	5.12	4.90	5.00	5.16	5.33	5.06	5.17	5.34	5.51
2000	AMPS	5.3	5.5	5.6	5.8	5.7	5.9	6.1	6.3	6.2	6.4	6.6	6.8	6.6	6.8	7.0	7.3	7.0	7.2	7.4	7.7	7.4	7.6	7.9	8.2	
	HI PR	149	160	169	176	167	179	189	198	190	204	215	225	216	232	245	256	243	261	276	288	268	289	305	318	
	LO PR	63	67	73	78	66	71	77	82	69	73	80	85	72	77	84	90	76	81	88	94	78	84	91	97	
	MBh	56.7	57.9	61.9	66.2	55.4	56.6	60.4	64.6	54.1	55.2	59.0	63.1	52.7	53.9	57.6	61.5	50.1	51.2	54.7	58.5	46.4	47.4	50.7	54.2	
	S/T	0.89	0.83	0.68	0.51	0.92	0.86	0.70	0.53	0.94	0.89	0.72	0.54	0.98	0.91	0.74	0.56	1.00	0.95	0.77	0.58	1.00	0.96	0.78	0.58	
85	1600	Delta T	23	22	19	15	23	22	20	16	23	22	20	16	24	23	20	16	23	22	19	16	21	21	18	14
		KW	3.95	4.02	4.15	4.27	4.23	4.32	4.46	4.59	4.49	4.58	4.73	4.88	4.72	4.82	4.97	5.13	4.91	5.01	5.17	5.34	5.07	5.18	5.35	5.53
		AMPS	5.4	5.5	5.6	5.8	5.8	5.9	6.1	6.3	6.2	6.4	6.6	6.8	6.6	6.8	7.0	7.3	7.1	7.2	7.5	7.7	7.5	7.6	7.9	8.2
		HI PR	149	160	169	177	167	180	190	198	190	205	216	225	217	233	246	257	244	262	277	289	269	290	306	319
		LO PR	63	67	73	78	67	71	77	82	69	74	80	86	73	77	84	90	76	81	88	94	79	84	91	97
	1900	MBh	57.1	58.2	61.0	65.0	55.8	56.9	59.6	63.5	54.5	55.5	58.1	62.0	53.1	54.2	56.7	60.5	50.5	51.4	53.9	57.5	46.7	47.7	49.9	53.2
		S/T	0.91	0.88	0.80	0.65	0.95	0.91	0.82	0.67	0.97	0.94	0.85	0.69	1.00	0.97	0.87	0.71	1.00	1.00	0.91	0.74	1.00	1.00	0.91	0.74
		Delta T	25	25	23	20	26	25	24	21	26	25	24	21	26	25	24	21	24	25	24	20	23	23	22	19
		KW	3.97	4.05	4.17	4.30	4.26	4.35	4.48	4.62	4.51	4.61	4.75	4.91	4.74	4.84	5.00	5.16	4.94	5.04	5.20	5.37	5.10	5.21	5.38	5.56
		AMPS	5.4	5.5	5.7	5.9	5.8	5.9	6.1	6.3	6.3	6.4	6.6	6.9	6.7	6.8	7.1	7.3	7.1	7.3	7.5	7.8	7.5	7.7	7.9	8.2
2000	HI PR	150	161	170	178	168	181	191	199	191	206	218	227	218	235	248	258	245	264	279	291	271	292	308	321	
	LO PR	63	67	74	78	67	71	78	83	70	74	81	86	73	78	85	90	77	82	89	95	79	84	92	98	
	MBh	57.7	58.8	61.6	65.7	56.3	57.4	60.1	64.2	55.0	56.1	58.7	62.6	53.7	54.7	57.3	61.1	51.0	52.0	54.4	58.1	47.2	48.1	50.4	53.8	
	S/T	0.93	0.90	0.81	0.66	0.97	0.93	0.84	0.68	0.99	0.96	0.86	0.70	1.00	0.99	0.89	0.72	1.00	1.00	0.92	0.75	1.00	1.00	0.93	0.76	
	Delta T	25	24	23	20	25	25	23	20	25	25	23	20	25	25	23	20	23	24	23	20	22	22	22	19	

NOTE: Shaded area is AHRI Rating Conditions

* Entering Indoor Dry Bulb Temperature

COOLING PERFORMANCE DATA

PERFORMANCE TEST

All data based upon listed indoor dry bulb temperature. .00 inches external static pressure on coil of outdoor section. Indoor air cubic feet per minute (CFM) as listed in the Performance Data Sheets:

If conditions vary from this, results will change as follows:

1. As indoor dry bulb temperatures increase, a slight increase will occur in indoor air temperature drop (Delta T). Low and high side pressures and power will not change.
2. As indoor CFM decreases, a slight increase will occur in indoor temperature drop (Delta T). A slight decrease will occur in low and high side pressures and power.

A properly operating unit should be within plus or minus 2 **degrees** of the subcooling value shown in the installation instructions.

A properly operating unit should be within plus or minus 3 **degrees** of the typical (Delta T) value shown.

A properly operating unit should be within plus or minus 10 **PSIG** of the **HI PR** shown.

A properly operating unit should be within plus or minus 5 **PSIG** of the **LO PR** shown.

A properly operating unit should be within plus or minus 3 **Amps** of the typical value shown.

WIRING DIAGRAMS

GSC130[18-60]1**

WARNING

HIGH VOLTAGE! DISCONNECT ALL POWER BEFORE SERVICING OR INSTALLING THIS UNIT. MULTIPLE POWER SOURCES MAY BE PRESENT. FAILURE TO DO SO MAY CAUSE PROPERTY DAMAGE, PERSONAL INJURY OR DEATH.

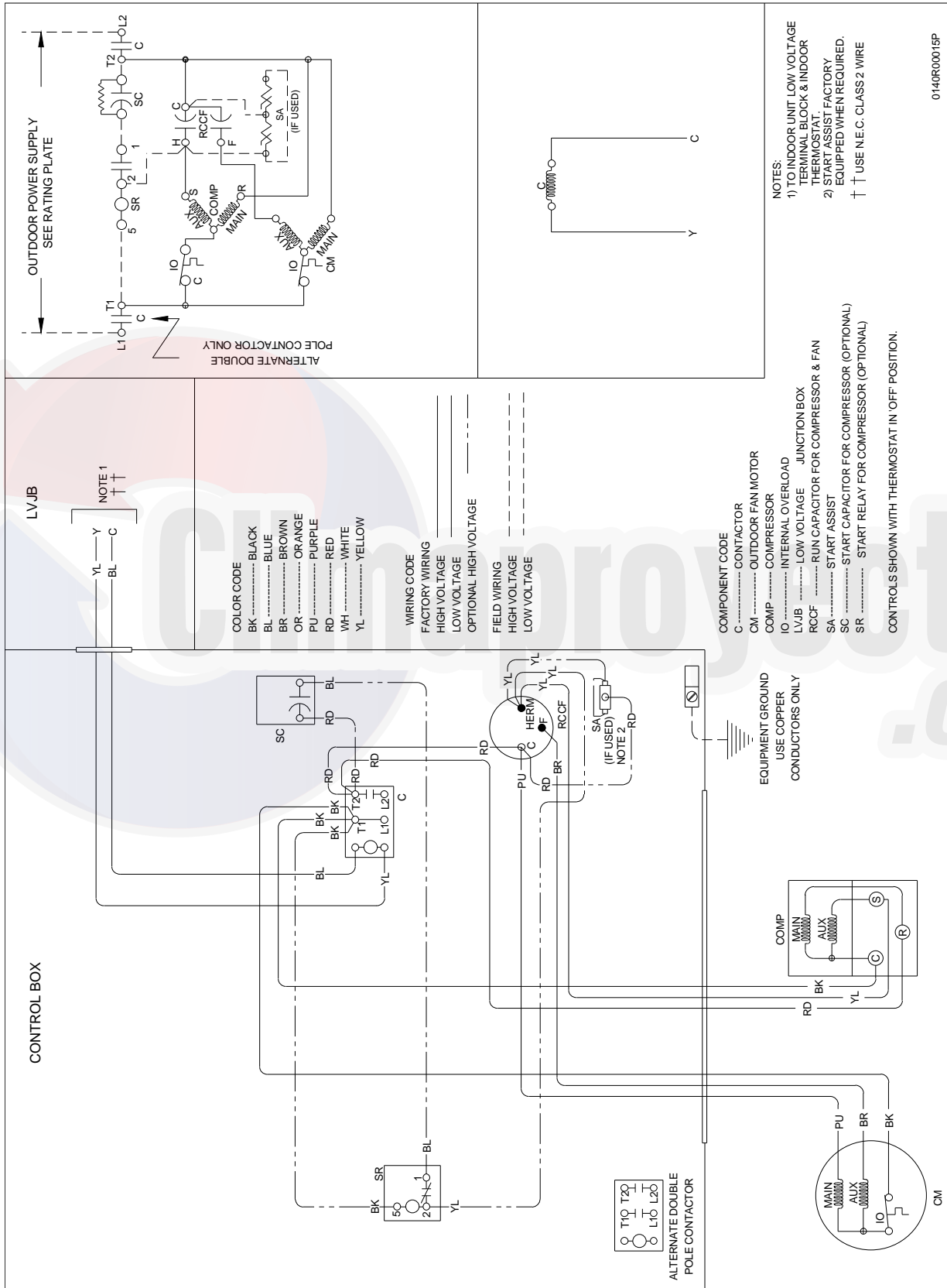

Wiring is subject to change. Always refer to the wiring diagram on the unit for the most up-to-date wiring.

WIRING DIAGRAMS

GSC130[18-60]1**

WARNING

HIGH VOLTAGE!
DISCONNECT ALL POWER BEFORE SERVICING OR INSTALLING THIS UNIT. MULTIPLE POWER SOURCES MAY BE PRESENT. FAILURE TO DO SO MAY CAUSE PROPERTY DAMAGE, PERSONAL INJURY OR DEATH.

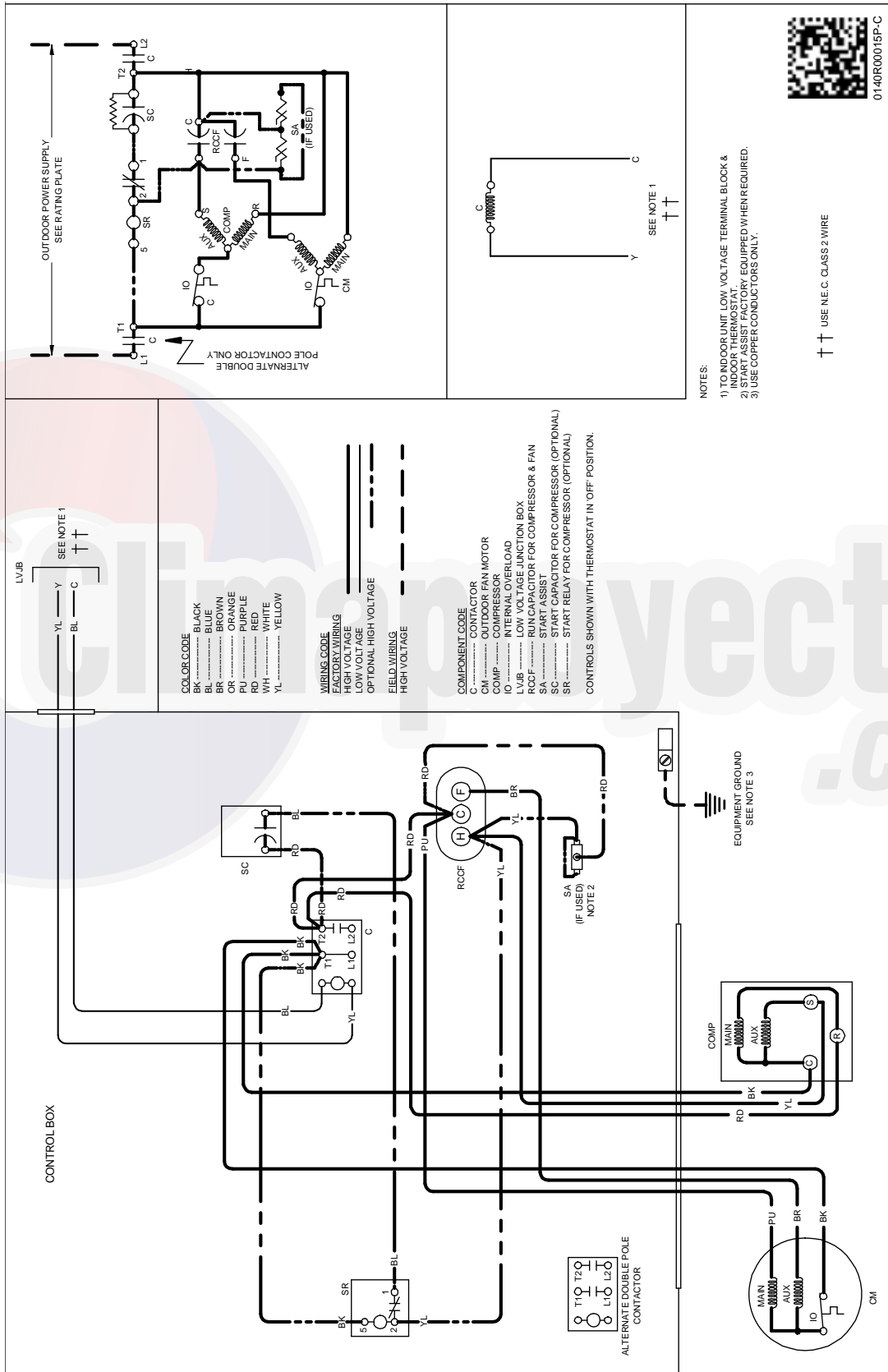

- NOTES:**
- 1) TO INDOOR UNIT, LOW VOLTAGE TERMINAL BLOCK & INTERNAL WIRING.
 - 2) START ASSIST FACTORY EQUIPPED WHEN REQUIRED.
 - 3) USE COPPER CONDUCTORS ONLY.



0140R00015P-C

†† USE N.E.C. CLASS 2 WIRE

Wiring is subject to change. Always refer to the wiring diagram on the unit for the most up-to-date wiring.

WIRING DIAGRAMS

GSC130[36-60]3** & GSC130[48-60]4**

WARNING

HIGH VOLTAGE!
DISCONNECT ALL POWER BEFORE SERVICING OR INSTALLING THIS UNIT. MULTIPLE POWER SOURCES MAY BE PRESENT. FAILURE TO DO SO MAY CAUSE PROPERTY DAMAGE, PERSONAL INJURY OR DEATH.

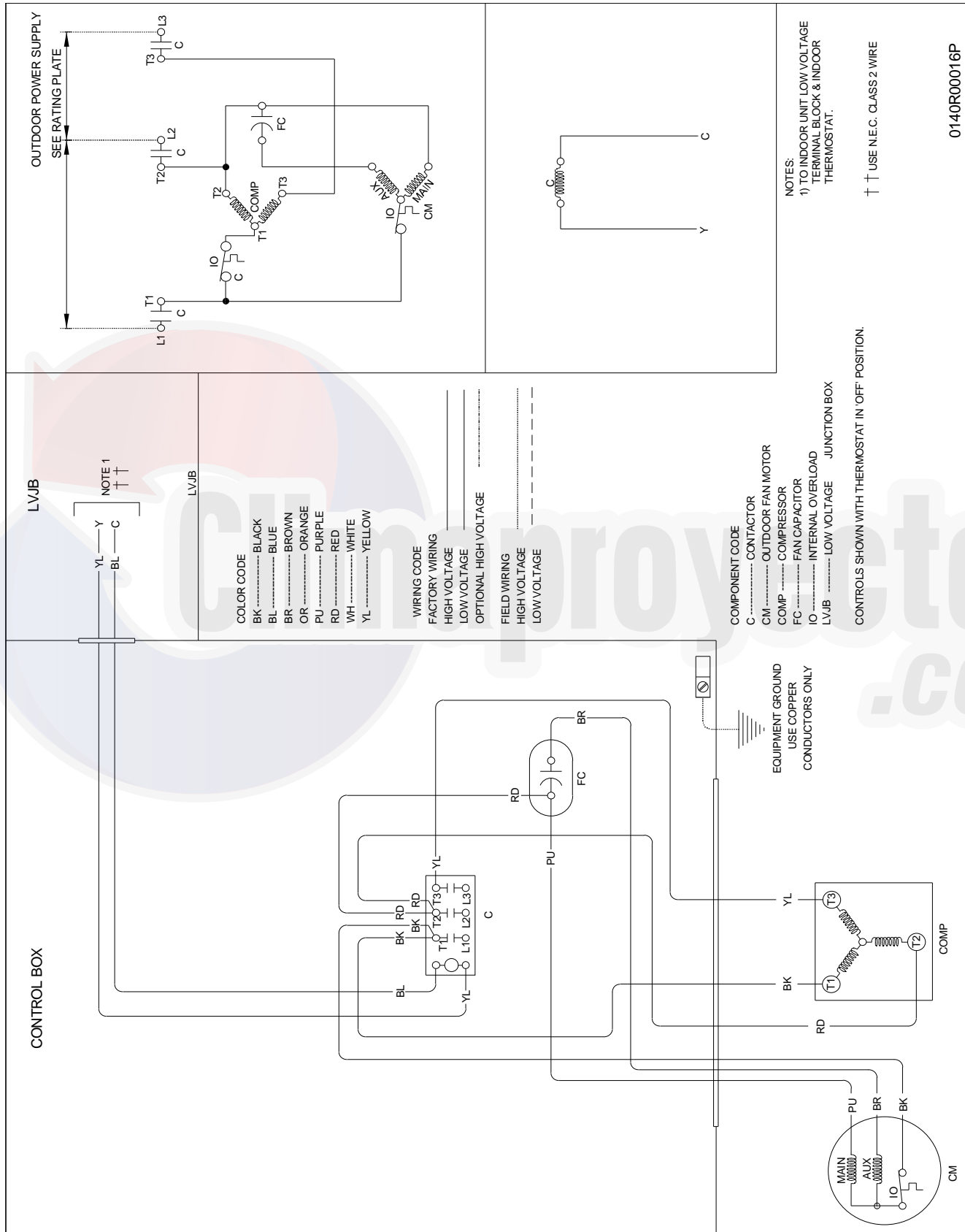

Wiring is subject to change. Always refer to the wiring diagram on the unit for the most up-to-date wiring.

WIRING DIAGRAMS

GSC130[36-60]3** & GSC130[48-60]4**

WARNING

HIGH VOLTAGE!
DISCONNECT ALL POWER BEFORE SERVICING OR INSTALLING THIS UNIT. MULTIPLE POWER SOURCES MAY BE PRESENT. FAILURE TO DO SO MAY CAUSE PROPERTY DAMAGE, PERSONAL INJURY OR DEATH.

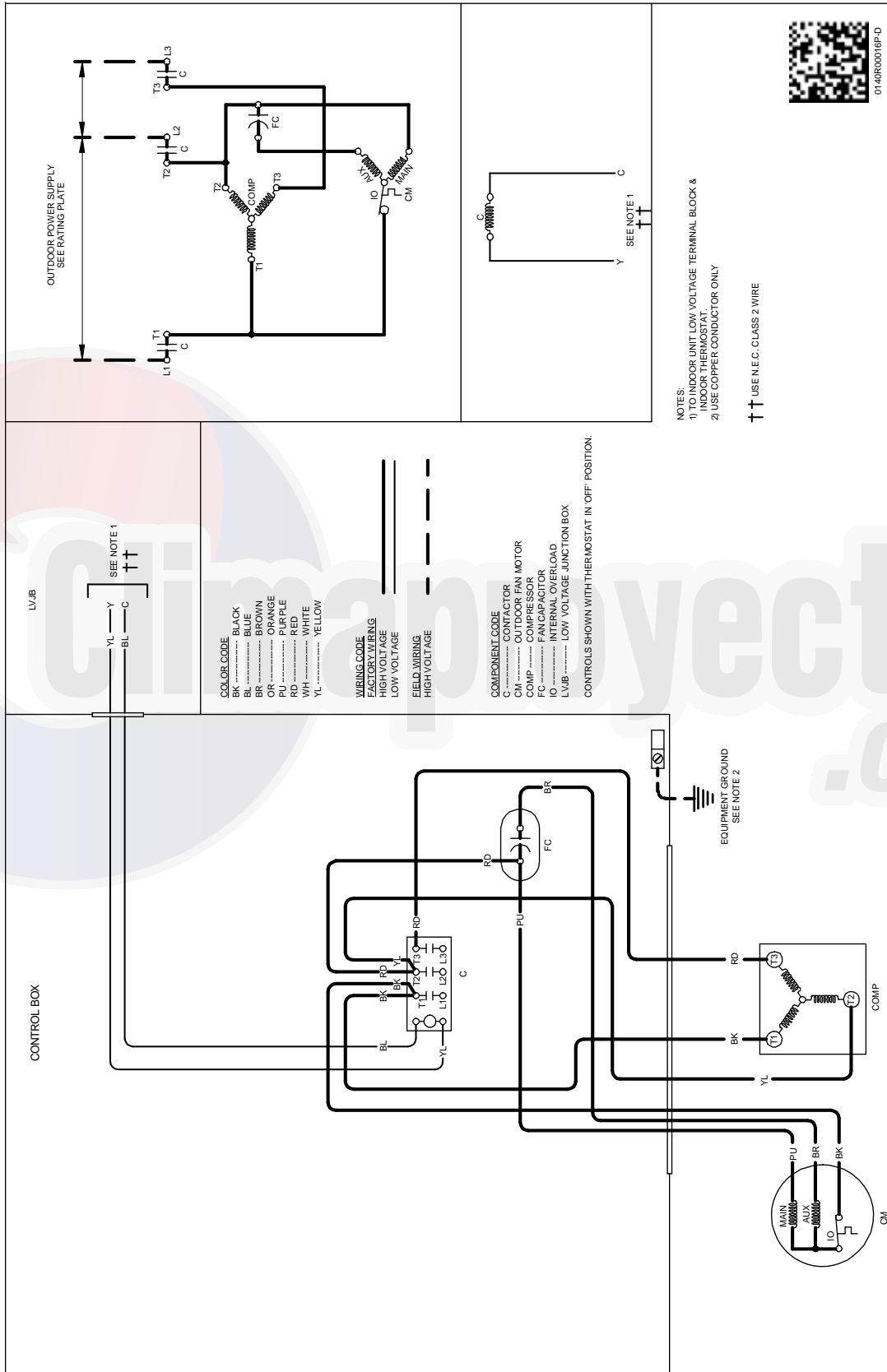

- NOTES:
- 1) TO INDOOR UNIT LOW VOLTAGE TERMINAL BLOCK & FAN MOTOR
 - 2) USE COPPER CONDUCTOR ONLY
- ↑↑ USE N.E.C. CLASS 2 WIRE



Wiring is subject to change. Always refer to the wiring diagram on the unit for the most up-to-date wiring.