



United Technologies

## INSTALLATION, OPERATION AND MAINTENANCE INSTRUCTIONS



Unit with options 23A, 258 and 279

## Air-Cooled Screw Chillers

# 30XA "A"

Nominal cooling capacity: 267-1682 kW

50 Hz

**AQUAFORCE™**

## CONTENTS

<b>1 - INTRODUCTION</b> .....	<b>4</b>
1.1 - Installation safety considerations .....	4
1.2 - Equipment and components under pressure .....	5
1.3 - Maintenance safety considerations .....	5
1.4 - Repair safety considerations .....	7
<b>2 - PRELIMINARY CHECKS</b> .....	<b>8</b>
2.1 - Check equipment received .....	8
2.2 - Moving and siting the unit .....	8
<b>3 - DIMENSIONS, CLEARANCES</b> .....	<b>10</b>
3.1 - 30XA 252-352 - MCHE heat exchanger (standard) and 30XA 252-302 - Cu/Al heat exchanger (option 254/255) ..	10
3.2 - 30XA 402-452-504 - MCHE heat exchanger (standard) and 352-452 - Cu/Al heat exchanger (option 254/255) .....	10
3.3 - 30XA 502 MCHE heat exchanger (standard) and 30XA 502 Cu/Al heat exchanger (option 254/255) .....	11
3.4 - 30XA 602-802-854-904 MCHE heat exchanger (standard) and 30XA 602-702 Cu/Al heat exchanger (option 254/255) .....	11
3.5 - 30XA 852-902 MCHE heat exchanger (standard) and 30XA 752-852 Cu/Al heat exchanger (option 254/255) .....	12
3.6 - 30XA 1002 MCHE heat exchanger (standard) and 30XA 902-1002 Cu/Al heat exchanger (option 254/255) .....	12
3.7 - 30XA 1112, 1212, 1312, 1382 MCHE heat exchanger (standard) and 30XA 1112, 1212, 1312, 1382 Cu/Al heat exchanger (option 254/255) .....	13
3.8 - 30XA 1402-1502 module 1/2 - MCHE heat exchanger (standard) and 30XA 1402-1502 module 1/2 - Cu/Al heat exchanger (option 254/255) .....	14
3.9 - 30XA 1402-1502 module 2/2 - MCHE heat exchanger (standard) and 30XA 1402-1502 module 2/2 - Cu/Al heat exchanger (option 254/255) .....	14
3.10 - 30XA 1702 module 1/2 - MCHE heat exchanger (standard) and 30XA 1702 module 1/2 - Cu/Al heat exchanger (option 254/255) .....	15
3.11 - 30XA 1702 module 2/2 - MCHE heat exchanger (standard) and 30XA 1702 module 2/2 - Cu/Al heat exchanger (option 254/255) .....	15
3.12 - Multiple chiller installation .....	16
3.13 - Distance to the wall .....	16
<b>4 - PHYSICAL AND ELECTRICAL DATA FOR 30XA UNITS</b> .....	<b>17</b>
4.1 - Physical data 30XA 252-852 - standard units and units with option 119* .....	17
4.1 - Physical data 30XA 904-1702 - standard units and units with option 119* (continued) .....	18
4.2 - Physical data 30XA 252-902 - units with option 254 and 255** .....	19
4.2 - Physical data 30XA 1002-1502 - units with option 254 and 255** (continued) .....	20
4.3 - Short-circuit stability current for all units .....	20
4.4 - Electrical data .....	21
4.4 - Electrical data (continued) .....	22
4.4 - Electrical data (continued) .....	23
4.4 - Electrical data (continued) .....	24
4.5 - Compressor electrical data .....	25
4.6 - Compressor usage per circuit (A, B, C, D) .....	25
4.7 - Electrical data, optional hydronic module .....	26
<b>5 - ELECTRICAL CONNECTION</b> .....	<b>27</b>
5.1 - Power supply .....	27
5.2 - Voltage phase imbalance (%) .....	27
5.3 - Power connection/disconnect switch .....	27
5.4 - Recommended wire sections .....	27
5.5 - Power cable entry .....	27
5.6 - Field control wiring .....	28
<b>6 - APPLICATION DATA</b> .....	<b>29</b>
6.1 - Operating range .....	29
6.2 - Minimum chilled water flow (units without hydronic module) .....	29
6.3 - Maximum chilled water flow (units without hydronic module) .....	29
6.4 - Variable flow evaporator .....	30
6.5 - System minimum water volume .....	30
6.6 - Maximum system water volume .....	30
6.7 - Evaporator water flow rate .....	30
6.8 - Evaporator pressure drop curve .....	31

<b>7 - WATER CONNECTIONS .....</b>	<b>32</b>
7.1 - Operating precautions .....	32
7.2 - Victaulic water connections.....	33
7.3 - Flow control.....	34
7.4 - Evaporator water box bolt tightening.....	34
7.5 - Frost protection .....	34
7.6 - Operation of two units in master/slave mode (option 58).....	34
7.7 - Pump characteristics .....	35
<b>8 - FREE-COOLING OPTION (OPTION 118A).....</b>	<b>36</b>
8.1 - Physical data, 30XA units with free-cooling option (option 118A) .....	36
8.2 - Operating limits.....	36
8.3 - Operation .....	36
<b>9 - HEAT RECLAIM CONDENSER OPTION (OPTION 50).....</b>	<b>37</b>
9.1 - Physical data, 30XA units with heat reclaim condenser option.....	37
9.2 - Dimensions, clearances.....	37
9.3 - Condenser location .....	41
9.4 - Condenser water connections.....	41
9.5 - Operating limits for stable operation (no mode changeover) .....	41
9.6 - Operating limits for changeover between modes .....	42
9.7 - Flow control.....	42
9.8 - Heat reclaim operation.....	42
9.9 - Condenser pump selection.....	42
9.10 - Frost protection .....	43
<b>10 - FANS WITH AVAILABLE PRESSURE (OPTION 10).....</b>	<b>43</b>
<b>11 - MAJOR SYSTEM COMPONENTS AND OPERATION DATA .....</b>	<b>43</b>
11.1 - Direct-drive twin-screw compressor with variable capacity slide valve .....	43
11.2 - Pressure vessels.....	43
11.3 - High-pressure safety switch .....	44
11.4 - Condensers.....	44
11.5 - Fans .....	44
11.6 - Electronic expansion valve (EXV) .....	45
11.7 - Moisture indicator.....	45
11.8 - Filter drier .....	45
11.9 - Sensors.....	45
11.10 - Service valve (option 92).....	45
11.11 - Power factor correction capacitors (option 231) .....	45
<b>12 - MAIN OPTIONS.....</b>	<b>47</b>
<b>13 - STANDARD MAINTENANCE.....</b>	<b>49</b>
13.1 - Level 1 maintenance .....	49
13.2 - Level 2 maintenance .....	49
13.3 - Level 3 (or higher) maintenance .....	49
13.4 - Tightening torques for the main electrical connections.....	50
13.5 - Tightening torques for the main bolts and screws.....	50
13.6 - Condenser coil.....	50
13.7 - Evaporator maintenance .....	52
13.8 - Compressor maintenance.....	52
13.9 - Precaution for compressor power supply bus bar connection .....	52
13.10 - Check of power factor correction capacitors .....	52
<b>14 - START-UP CHECKLIST FOR 30XA LIQUID CHILLERS (USE FOR JOB FILE).....</b>	<b>53</b>

**The illustrations on the front cover and inside this document are for illustrative purposes only and not part of any offer for sale or contract.**

## 1 - INTRODUCTION

The 30XA Aquaforce units are designed to cool water for the air conditioning of buildings and industrial processes.

Prior to the initial start-up of the 30XA units, the people involved in the on-site installation, start-up, operation, and maintenance of this unit should be thoroughly familiar with these instructions and the specific project data for the installation site.

They are designed for an operating life of 15 years by assuming a 75% utilisation factor; that is approximately 100,000 operating hours.

The 30XA liquid chillers are designed to provide a very high level of safety during installation, start-up, operation and maintenance. They will provide safe and reliable service when operated within their application range.

This manual provides the necessary information to familiarize yourself with the control system before performing start-up procedures. The procedures in this manual are arranged in the sequence required for machine installation, start-up, operation and maintenance.

Always ensure that all required safety measures are followed, including those in this document, such as, wearing protective clothing (gloves, ear defenders, safety glasses and shoes), using appropriate tools, employing qualified and skilled technicians (electricians, refrigeration engineers) and following local regulations.

To find out, if these products comply with European directives (machine safety, low voltage, electromagnetic compatibility, equipment under pressure etc.) check the declarations of conformity for these products.

### 1.1 - Installation safety considerations

Access to the unit must be reserved to authorised personnel, qualified and trained in monitoring and maintenance. The access limitation device must be installed by the customer (e.g. cut-off, enclosure).

After the unit has been received, when it is ready to be installed or reinstalled, and before it is started up, it must be inspected for damage. Check that the refrigerant circuit(s) is (are) intact, especially that no components or pipes have shifted (e.g. following a shock). If in doubt, carry out a leak tightness check and verify with the manufacturer that the circuit integrity has not been impaired. If damage is detected upon receipt, immediately file a claim with the shipping company.

**Carrier strongly recommends employing a specialised company to unload the machine.**

**Do not remove the skid or the packaging until the unit is in its final position. These units can be moved with a fork lift truck, as long as the forks are positioned in the right place and direction on the unit.**

**The units can also be lifted with slings, using only the designated lifting points marked on the unit.**

**These units are not designed to be lifted from above. Use slings with the correct capacity, and always follow the lifting instructions on the certified drawings supplied with the unit.**

**Safety is only guaranteed, if these instructions are carefully followed. If this is not the case, there is a risk of material deterioration and injuries to personnel.**

**DO NOT COVER ANY PROTECTION DEVICES.**

**This applies to fuse plugs and relief valves (if used) in the refrigerant or heat transfer medium circuits. Check if the original protection plugs are still present at the valve outlets. These plugs are generally made of plastic and should not be used. If they are still present, please remove them. Install devices at the valve outlets or drain piping that prevent the penetration of foreign bodies (dust, building debris, etc.) and atmospheric agents (water can form rust or ice). These devices, as well as the drain piping, must not impair operation and not lead to a pressure drop that is higher than 10% of the control pressure.**

#### Classification and control

**In accordance with the Pressure Equipment Directive and national usage monitoring regulations in the European Union the protection devices for these machines are classified as follows:**

	Safety accessory*	Damage limitation accessory** in case of an external fire
<b>Refrigerant side</b>		
High-pressure switch	x	
External relief valve***		x
Rupture disk		x
Fuse plug		x
<b>Heat transfer fluid side</b>		
External relief valve****	x	x

\* Classified for protection in normal service situations.

\*\* Classified for protection in abnormal service situations.

\*\*\* The instantaneous over-pressure limited to 10% of the operating pressure does not apply to this abnormal service situation. The control pressure can be higher than the service pressure. In this case either the design temperature or the high-pressure switch ensures that the service pressure is not exceeded in normal service situations.

\*\*\*\* The classification of these relief valves must be made by the personnel that completes the whole hydronic installation.

**Do not remove these valves and fuses, even if the fire risk is under control for a particular installation. There is no guarantee that the accessories are re-installed if the installation is changed or for transport with a gas charge.**

**When the unit is subjected to fire, safety devices prevent rupture due to over-pressure by releasing the refrigerant. The fluid may then be decomposed into toxic residues when subjected to the flame:**

- Stay away from the unit.
- Set up warnings and recommendations for personnel in charge to stop the fire.
- Fire extinguishers appropriate to the system and the refrigerant type must be easily accessible

**All factory-installed relief valves are lead-sealed to prevent any calibration change. If the relief valves are installed on a change-over manifold, this is equipped with a relief valve on each of the two outlets. Only one of the two relief valves is in operation, the other one is isolated. Never leave the change-over valve in the intermediate position, i.e. with both ways open (locate the control element in the stop position).**

**If a relief valve is removed for checking or replacement please ensure that there is always an active relief valve on each of the change-over valves installed in the unit.**

**The external relief valves must always be connected to drain pipes for units installed in a closed room. Refer to the installation regulations, for example those of European standard EN 378 and EN 13136.**

**These pipes must be installed in a way that ensures that people and property are not exposed to refrigerant leaks. As the fluids can be diffused in the air, ensure that the outlet is far away from any building air intake, or that they are discharged in a quantity that is appropriate for a suitably absorbing environment.**

**Periodic check of the relief valves: See chapter 1.3 - "Maintenance safety considerations".**

**Provide a drain in the drain pipe, close to each relief valve, to avoid an accumulation of condensate or rain water.**

**All precautions concerning handling of refrigerant must be observed in accordance with local regulations.**

**Ensure good ventilation, as accumulation of refrigerant in an enclosed space can displace oxygen and cause asphyxiation or explosions.**

**Inhalation of high concentrations of vapour is harmful and may cause heart irregularities, unconsciousness, or death. Vapour is heavier than air and reduces the amount of oxygen available for breathing. These products cause eye and skin irritation. Decomposition products are hazardous.**

## **1.2 - Equipment and components under pressure**

These products incorporate equipment or components under pressure, manufactured by Carrier or other manufacturers. We recommend that you consult your appropriate national trade association or the owner of the equipment or components under pressure (declaration, re-qualification, retesting, etc.). The characteristics of this equipment/these components are given on the nameplate or in the required documentation, supplied with the products.

These units are intended to be stored and operated in an environment where the ambient temperature must be not less than the lowest allowable temperature indicated on the nameplate.

Do not introduce significant static or dynamic pressure with regard to the operating pressures used during operation or for tests in the refrigerant circuit or in the heat exchange circuits.

See section "11.2 - Pressure vessels".

## **1.3 - Maintenance safety considerations**

Carrier recommends the following drafting for a logbook (the table below should not be considered as reference and does not involve Carrier responsibility):

Intervention		Name of the commissioning engineer	Applicable national regulations	Verification Organism
Date	Nature <sup>(1)</sup>			

(1) Maintenance, repairs, regular verifications (EN 378), leakage, etc.

Engineers working on the electric or refrigeration components must be authorized, trained and fully qualified to do so.

All refrigerant circuit repairs must be carried out by a trained person, fully qualified to work on these units. He must have been trained and be familiar with the equipment and the installation. All welding operations must be carried out by qualified specialists.

**Any manipulation (opening or closing) of a shut-off valve must be carried out by a qualified and authorised engineer. These procedures must be carried out with the unit shut-down.**

**NOTE: The unit must never be left shut down with the liquid line valve closed, as liquid refrigerant can be trapped between this valve and the expansion device and lead to the risk of a pressure increase. This valve is situated on the liquid line before the filter drier box.**

**During any handling, maintenance and service operations the engineers working on the unit must be equipped with safety gloves, glasses, shoes and protective clothing.**

**Never work on a unit that is still energized.**

**Never work on any of the electrical components, until the general power supply to the unit has been cut using the disconnect switch(es) in the control box(es).**

**If any maintenance operations are carried out on the unit, lock the power supply circuit in the open position ahead of the machine.**

**If the work is interrupted, always ensure that all circuits are still deenergized before resuming the work.**

**ATTENTION: Even if the unit has been switched off, the power circuit remains energized, unless the unit or circuit disconnect switch is open. Refer to the wiring diagram for further details. Attach appropriate safety labels.**

**Units with option 231 are equipped with capacitor batteries with a discharge time of five (5) minutes after disconnecting the power. After disconnecting the power to the control box, wait five minutes before opening the control box. Before any intervention, verify that there is no voltage present at any accessible conducting parts of the power circuit.**

**Operating checks:**

**IMPORTANT INFORMATION REGARDING THE REFRIGERANT USED:**

- **This product contains fluorinated greenhouse gas covered by the Kyoto protocol.**  
**Fluid type: R134a**  
**Global Warming Potential (GWP): 1430**

**CAUTION:**

1. Any intervention on the refrigerant circuit of this product should be performed in accordance with the applicable legislation. In the EU, the regulation is called F-Gas, N°517/2014
2. Ensure that the refrigerant is never released to the atmosphere during installation, maintenance or equipment disposal.
3. The deliberate gas release into the atmosphere is not allowed.
4. If a refrigerant leak is detected, ensure that it is stopped and repaired as quickly as possible.
5. Only a qualified and certified personnel can perform installation operations, maintenance, refrigerant circuit leak test as well as the equipment disposal and the refrigerant recovering.
6. The gas recovery for recycling, regeneration or destruction is at customer charge.
7. Periodic leak tests have to be carried out by the customer or by third parties. The EU regulation set the periodicity here after:

System WITHOUT leakage detection	No check	12 months	6 months	3 months	
System WITH leakage detection	No check	24 months	12 months	6 months	
Refrigerant charge/ circuit (CO <sub>2</sub> equivalent)	< 5 tonnes	5 ≤ charge < 50 tonnes	50 ≤ charge < 500 tonnes	Charge > 500 tonnes*	
Refrigerant charge/ circuit (kg)	R134a (GWP 1430)	Charge < 3.5 kg	3.5 ≤ charge < 34.9 kg	34.9 ≤ charge < 349.7 kg	Charge > 349.7 kg
	R407C (GWP 1774)	Charge < 2.8 kg	2.8 ≤ charge < 28.2 kg	28.2 ≤ charge < 281.9 kg	Charge > 281.9 kg
	R410A (GWP 2088)	Charge < 2.4 kg	2.4 ≤ charge < 23.9 kg	23.9 ≤ charge < 239.5 kg	Charge > 239.5 kg
HFO's : R1234ze	No requirement				

\* From 01/01/2017, units must be equipped with a leakage detection system

8. A logbook must be established for equipments subject to periodic leak tests. It should contain the quantity and the type of fluid present within the installation (added and recovered), the quantity of recycled fluid, regenerated or destroyed, the date and output of the leak test, the designation of the operator and its belonging company, etc.
9. Contact your local dealer or installer if you have any questions.

**The information on operating inspections given in annex C of standard EN 378 can be used if no similar criteria exist in the national regulations.**

**While working in the fan area, especially when grilles or casings are removed, disconnect the fan power supply to prevent their automatic restart.**

**Protection device checks:**

- **If no national regulations exist, check the protection devices on site in accordance with standard EN 378: Once a year for the high-pressure switches, every five years for external relief valves.**

The company or organisation that conducts a pressure switch test must establish and implement detailed procedures for:

- Safety measures
- Measuring equipment calibration
- Validating operation of protective devices
- Test protocols
- Recommissioning of the equipment.

Consult Carrier Service for this type of test. Carrier mentions here only the principle of a test without removing the pressure switch:

- Verify and record the set-points of pressure switches and relief devices (valves and possible rupture discs)
- Be ready to switch-off the main disconnect switch of the power supply if the pressure switch does not trigger (avoid over-pressure or excess gas in case of valves on the high-pressure side with the recovery condensers)
- Connect a pressure gauge protected against pulsations (filled with oil with maximum pointer if mechanical), preferably calibrated (the values displayed on the user interface may be inaccurate in an instant reading because of the scanning delay applied in the control)
- Complete an HP Test as provided by the software (refer to the Control IOM for details).

**If the machine operates in a corrosive environment, inspect the protection devices more frequently.**

**Regularly carry out leak tests and immediately repair any leaks. Ensure regularly that the vibration levels remain acceptable and close to those at the initial unit start-up.**

**Before opening a refrigerant circuit, purge and consult the pressure gauges.**

**Change the refrigerant after an equipment failure, following a procedure such as the one described in NF E29-795 or carry out a refrigerant analysis in a specialist laboratory.**

**Plug all openings whenever the refrigerant circuit is opened for up to one day. For longer openings place a nitrogen charge in the circuit.**

## 1.4 - Repair safety considerations

All installation parts must be maintained by the personnel in charge, in order to avoid material deterioration and injuries to people. Faults and leaks must be repaired immediately. The authorized technician must have the responsibility to repair the fault immediately. After each repair of the unit, check the operation of the protection devices and create a report of the parameter operation at 100%.

Comply with the regulations and recommendations in unit and HVAC installation safety standards, such as: EN 378, ISO 5149, etc.

If a leak occurs or if the refrigerant becomes contaminated (e.g. by a short circuit in a motor) remove the complete charge using a recovery unit and store the refrigerant in mobile containers.

Repair the leak detected and recharge the circuit with the total R-134a charge, as indicated on the unit name plate. Certain parts of the circuit can be isolated. Only charge liquid refrigerant R-134a at the liquid line.

**Ensure that you are using the correct refrigerant type before recharging the unit. Charging any refrigerant other than the original charge type (R-134a) will impair machine operation and even destroy the compressors. The compressors operating with this refrigerant type are lubricated with a synthetic polyolester oil.**

### **RISK OF EXPLOSION:**



**Never use air or a gas containing oxygen during leak tests to purge lines or to pressurise a machine. Pressurised air mixtures or gases containing oxygen can be the cause of an explosion.**

**Only use dry nitrogen for leak tests, possibly with an appropriate tracer gas.**

**If the recommendations above are not observed, this can have serious or even fatal consequences and damage the installation.**

**Never exceed the specified maximum operating pressures. Verify the allowable maximum high- and low-side test pressures by checking the instructions in this manual and the pressures given on the unit name plate.**

**Do not unweld or flame-cut the refrigerant lines or any refrigerant circuit component until all refrigerant (liquid and vapour) as well as the oil have been removed from chiller. Traces of vapour should be displaced with dry air nitrogen. Refrigerant in contact with an open flame produces toxic gases.**

**The necessary protection equipment must be available, and appropriate fire extinguishers for the system and the refrigerant type used must be within easy reach.**

**Do not siphon refrigerant.**

**Avoid spilling liquid refrigerant on skin or splashing it into the eyes. Use safety goggles and safety gloves. Wash any spills from the skin with soap and water. If liquid refrigerant enters the eyes, immediately and abundantly flush the eyes with water and consult a doctor.**

**The accidental releases of the refrigerant, due to small leaks or significant discharges following the rupture of a pipe or an unexpected release from a safety valve, can cause frostbites and burns to personnel exposed. Do not ignore such injuries. Installers, owners and especially service engineers for these units must:**

- **Seek medical attention before treating such injuries.**
- **Have access to a first-aid kit, especially for treating eye injuries.**

**We recommend to apply standard EN 378-3 Annex 3.**

**Never apply an open flame or live steam to a refrigerant container. Dangerous overpressure can result. If it is necessary to heat refrigerant, use only warm water.**

During refrigerant removal and storage operations follow applicable regulations. These regulations, permitting conditioning and recovery of halogenated hydrocarbons under optimum quality conditions for the products and optimum safety conditions for people, property and the environment are described in standard NF E29-795.

Any refrigerant transfer and recovery operations must be carried out using a transfer unit. A 3/8" SAE connector on the manual liquid line valve is supplied with all units for connection to the transfer station. The units must never be modified to add refrigerant and oil charging, removal and purging devices. All these devices are provided with the units. Please refer to the certified dimensional drawings for the units.

**Do not re-use disposable (non-returnable) cylinders or attempt to refill them. It is dangerous and illegal. When cylinders are empty, evacuate the remaining gas pressure, and move the cylinders to a place designated for their recovery. Do not incinerate them.**

**ATTENTION: Only use refrigerant R134a, in accordance with 700 AHRI (Air conditioning, Heating and Refrigeration Institute). The use of any other refrigerant may expose users and operators to unexpected risks.**

**Do not attempt to remove refrigerant circuit components or fittings, while the machine is under pressure or while it is running. Be sure pressure is at 0 kPa and that the unit has been shut-down and de-energised before removing components or opening a circuit.**

**Do not attempt to repair or recondition any safety devices when corrosion or build-up of foreign material (rust, dirt, scale, etc.) is found within the valve body or mechanism. If necessary, replace the device. Do not install relief valves in series or backwards.**

**ATTENTION: No part of the unit must be used as a walk-way, rack or support. Periodically check and repair or if necessary replace any component or piping that shows signs of damage.**

*The refrigerant lines can break under the weight and release refrigerant, causing personal injury.*

*Do not climb on a machine. Use a platform, or staging to work at higher levels.*

*Use mechanical lifting equipment (crane, hoist, winch, etc.) to lift or move heavy components. For lighter components, use lifting equipment when there is a risk of slipping or losing your balance.*

*Use only original replacement parts for any repair or component replacement. Consult the list of replacement parts that corresponds to the specification of the original equipment.*

*Do not drain water circuits containing industrial brines, without informing the technical service department at the installation site or a competent body first.*

*Close the entering and leaving water shutoff valves and purge the unit water circuit, before working on the components installed on the circuit (screen filter, pump, water flow switch, etc.).*

*Do not loosen the water box bolts until the water boxes have been completely drained.*

*Periodically inspect all valves, fittings and pipes of the refrigerant and hydronic circuits to ensure that they do not show any corrosion or any signs of leaks.*

*It is recommended to wear ear defenders, when working near the unit and the unit is in operation.*

## 2 - PRELIMINARY CHECKS

### 2.1 - Check equipment received

- Check that the unit has not been damaged during transport and that no parts are missing. If the unit has been damaged or the shipment is incomplete, send a claim to the shipping company.
- Compare the name plate data with the order. The name plate is attached in two places to the unit:
  - On one of the unit sides on the outside,
  - On the control box door on the inside.
- The unit name plate must include the following information:
  - Version number
  - Model number
  - CE marking
  - Serial number
  - Year of manufacture and test date
  - Fluid being transported
  - Refrigerant used and refrigerant class
  - Refrigerant charge per circuit
  - Containment fluid to be used
  - PS: Min./max. allowable pressure (high and low pressure side)
  - TS: Min./max. allowable temperature (high and low pressure side)
  - Pressure switch cut-out pressure
  - Unit leak test pressure

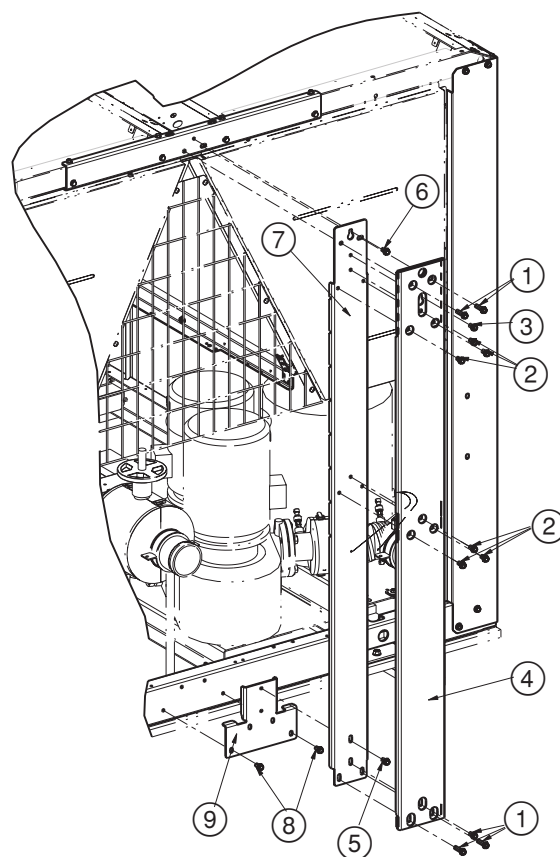

- Voltage, frequency, number of phases
- Maximum current drawn
- Maximum power input
- Unit net weight
- Confirm that all accessories ordered for on-site installation have been supplied, are complete and undamaged.

*The unit must be checked periodically during its whole operating life to ensure that no shocks (handling accessories, tools etc.) have damaged it. If necessary, damaged parts must be repaired or replaced. See also chapter 13 - "Standard maintenance".*

### 2.2 - Moving and siting the unit

#### 2.2.1 - Moving

See chapter 1.1 "Installation safety considerations".

In some cases vertical supports are added for the transport and handling of the unit. These supports can be removed for access or connection, if required.

**IMPORTANT:** Follow the disassembly sequence shown in the disassembly instruction notes.

- Unscrew screws marked 1 and 2.
- Loosen screw 3, and lift and remove support 4.
- Unscrew screw 5 and loosen screw 6.
- Lift and remove support 7.
- Unscrew screw 8 and remove plate 9.

Keep the vertical supports after commissioning the units and re-insert them when the unit is moved.



### 2.2.2 - Siting the unit

The machine must be installed in a place that is not accessible to the public or protected against access by non-authorized persons.

***In case of extra-high units the machine environment must permit easy access for maintenance operations.***

Always refer to the chapter 3 “Dimensions, clearances” to confirm that there is adequate space for all connections and service operations. For the centre of gravity coordinates, the position of the unit mounting holes, and the weight distribution points, refer to the certified dimensional drawing supplied with the unit.

The support points under the chassis must have at least the size of the chassis opening at the lifting point (minimum 220 x 180 mm) in order to prevent a deformation of the chassis.

Typical applications of these units are in refrigeration systems, and they do not require earthquake resistance. Earthquake resistance has not been verified.

***CAUTION: Only use slings at the designated lifting points which are marked on the unit.***

Before siting the unit check that:

- The permitted loading at the site is adequate or that appropriate strengthening measures have been taken.
- The unit is installed level on an even surface (maximum tolerance is 5 mm in both axes).
- There is adequate space above the unit for air flow and to ensure access to the components.
- The number of support points is adequate and that they are in the right places.
- The location is not subject to flooding.
- For outdoor installations, where heavy snowfall is likely and long periods of sub-zero temperatures are normal, provision has to be made to prevent snow accumulating by raising the unit above the height of drifts normally experienced.
- Baffles may be necessary to deflect strong winds. They must not restrict air flow into the unit.

***CAUTION: Before lifting the unit, check that all casing panels are securely fixed in place. Lift and set down the unit with great care. Tilting and jarring can damage the unit and impair unit operation.***

If 30XA units are hoisted with rigging, it is advisable to protect coils against crushing while a unit is being moved. Use struts or spreader bar to spread the slings above the unit. Do not tilt a unit more than 15°.

***WARNING: Never push or lever on any of the enclosure panels of the unit. Only the base of the unit frame is designed to withstand such stresses.***

***If a unit includes a hydronic module (options 116B, C, E, G), the hydronic module and pump piping must be installed in a way that does not submit it to any strain. The hydronic module pipes must be fitted so that the pump does not support the weight of the pipes.***

### 2.2.3 - Checks before system start-up

Before the start-up of the refrigeration system, the complete installation, including the refrigeration system must be verified against the installation drawings, dimensional drawings, system piping and instrumentation diagrams and the wiring diagrams.

For these checks national regulations must be followed. If the national regulation does not specify any details, refer to standard EN 378 as follows:

External visual installation checks:

- Ensure that the machine is charged with refrigerant. Verify on the unit nameplate that the ‘fluid transported’ is R134A and is not nitrogen.
- Compare the complete installation with the refrigeration system and power circuit diagrams.
- Check that all components comply with the design specifications.
- Check that all protection documents and equipment provided by the manufacturer (dimensional drawings, P&ID, declarations etc.) to comply with the regulations are present.
- Verify that the environmental safety and protection and devices and arrangements provided by the manufacturer to comply with the regulations are in place.
- Verify that all documents for pressure containers, certificates, name plates, files, instruction manuals provided by the manufacturer to comply with the regulations are present.
- Verify the free passage of access and safety routes.
- Check that ventilation in the plant room is adequate.
- Check that refrigerant detectors are present.
- Verify the instructions and directives to prevent the deliberate removal of refrigerant gases that are harmful to the environment.
- Verify the installation of connections.
- Verify the supports and fixing elements (materials, routing and connection).
- Verify the quality of welds and other joints.
- Check the protection against mechanical damage.
- Check the protection against heat.
- Check the protection of moving parts.
- Verify the accessibility for maintenance or repair and to check the piping.
- Verify the status of the valves.
- Verify the quality of the thermal insulation and of the vapour barriers.

### 3 - DIMENSIONS, CLEARANCES

#### 3.1 - 30XA 252-352 - MCHE heat exchanger (standard) and 30XA 252-302 - Cu/Al heat exchanger (option 254/255)

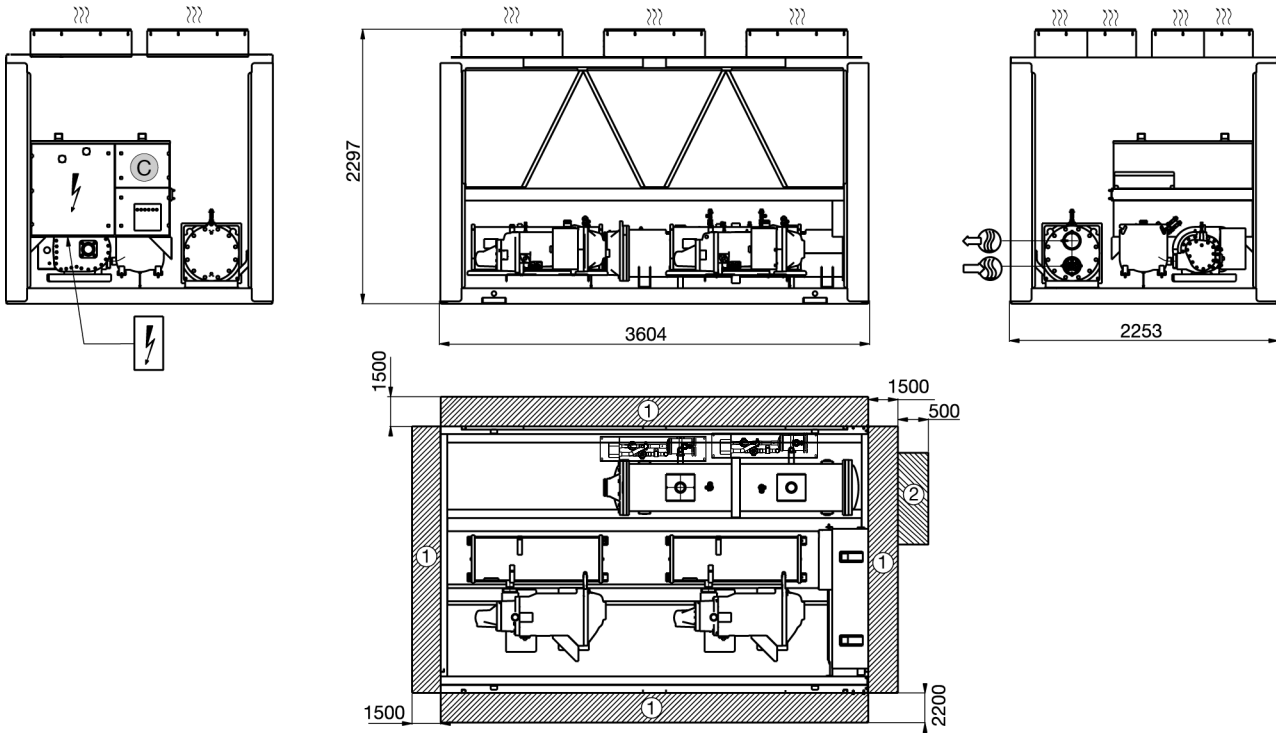



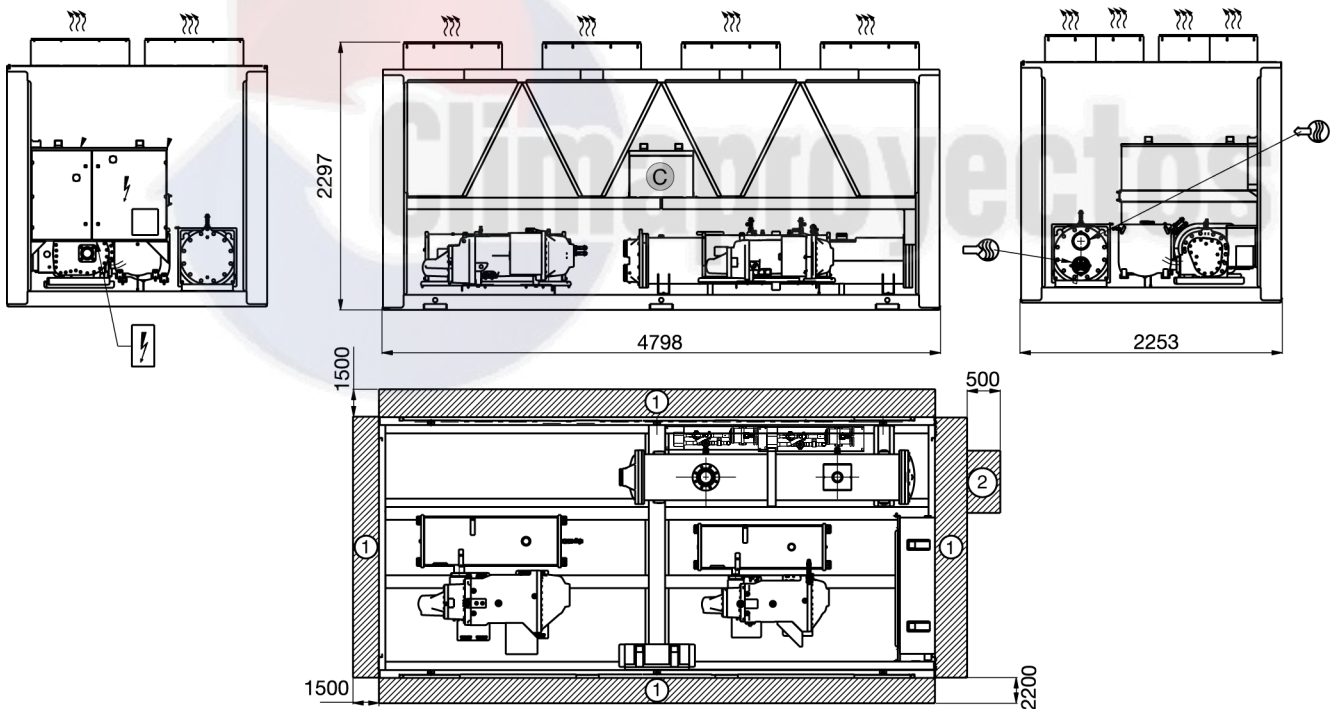

#### 3.2 - 30XA 402-452-504 - MCHE heat exchanger (standard) and 352-452 - Cu/Al heat exchanger (option 254/255)



#### Legend

All dimensions are given in mm.

- ① Required clearances for maintenance (see note)
- ② Recommended space for evaporator tube removal
-  Water inlet for standard unit  
For options 5, 6, 100A, 100C, 107 refer to the certified drawing.
-  Water outlet for standard unit  
For options 5, 6, 100A, 100C, 107 refer to the certified drawing.
-  Air outlet – do not obstruct
-  Power supply and control connection
-  Control circuit connection for option 158

#### NOTES:

- Drawings are not contractually binding.
- Before designing an installation, consult the certified dimensional drawings, available on request.
- For the positioning of the fixing points, weight distribution and centre of gravity coordinates please refer to the dimensional drawings.
- If the installation includes several units or if this (these) is (are) close to walls, please refer to chapters 3.12 - “Multiple chiller installation” and 3.13 - “Distance to the wall” of this document to determine the space required.

**3.3 - 30XA 502 MCHE heat exchanger (standard) and 30XA 502 Cu/Al heat exchanger (option 254/255)**

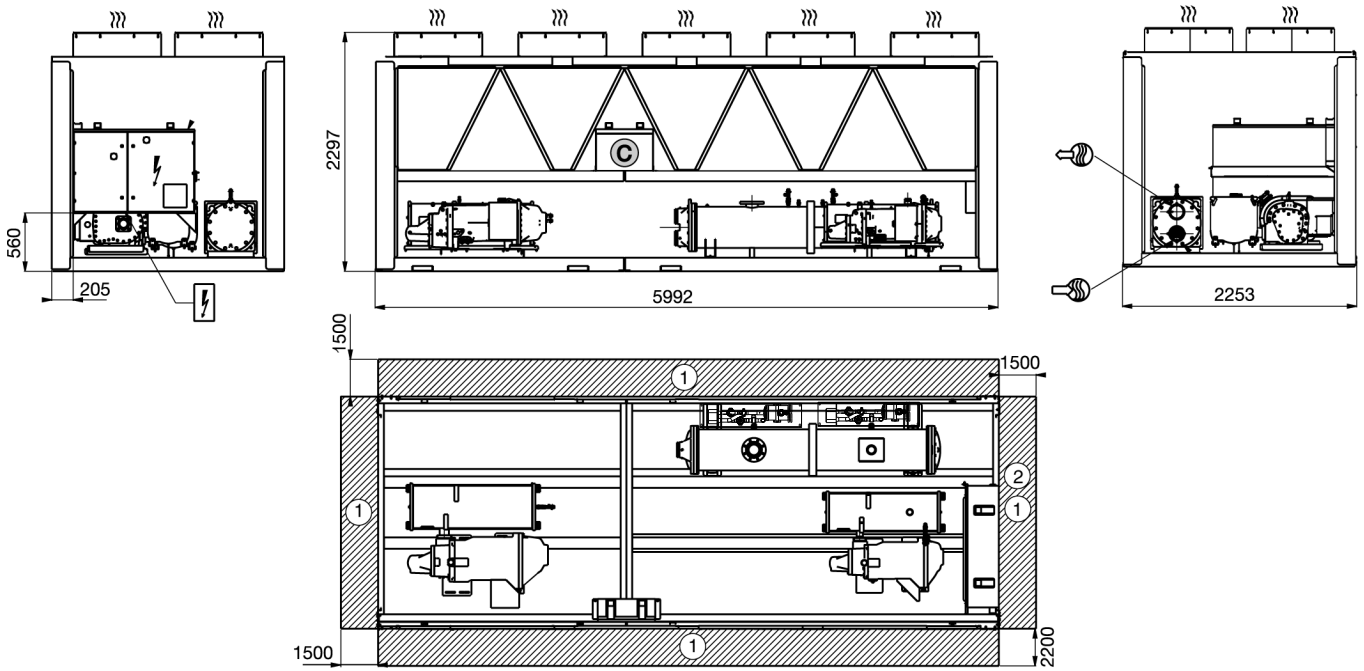

**3.4 - 30XA 602-802-854-904 MCHE heat exchanger (standard) and 30XA 602-702 Cu/Al heat exchanger (option 254/255)**

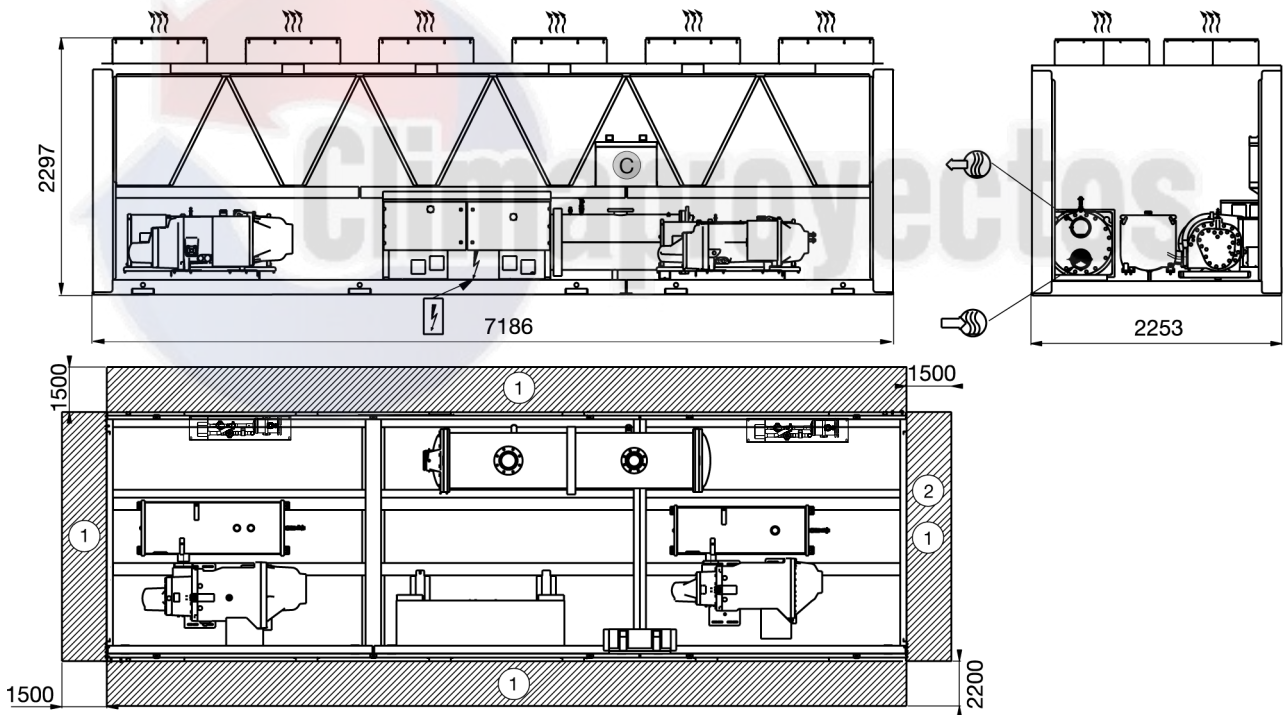

**Legend**

All dimensions are given in mm.

- ① Required clearances for maintenance (see note)
- ② Recommended space for evaporator tube removal
- Water inlet for standard unit  
For options 5, 6, 100A, 100C, 107 refer to the certified drawing.
- Water outlet for standard unit  
For options 5, 6, 100A, 100C, 107 refer to the certified drawing.
- Air outlet – do not obstruct
- Power supply and control connection
- ⓐ Control circuit connection for option 158

**NOTES:**

- Drawings are not contractually binding.
- Before designing an installation, consult the certified dimensional drawings, available on request.
- For the positioning of the fixing points, weight distribution and centre of gravity coordinates please refer to the dimensional drawings.
- If the installation includes several units or if this (these) is (are) close to walls, please refer to chapters 3.12 - “Multiple chiller installation” and 3.13 - “Distance to the wall” of this document to determine the space required.

3.5 - 30XA 852-902 MCHE heat exchanger (standard) and 30XA 752-852 Cu/Al heat exchanger (option 254/255)

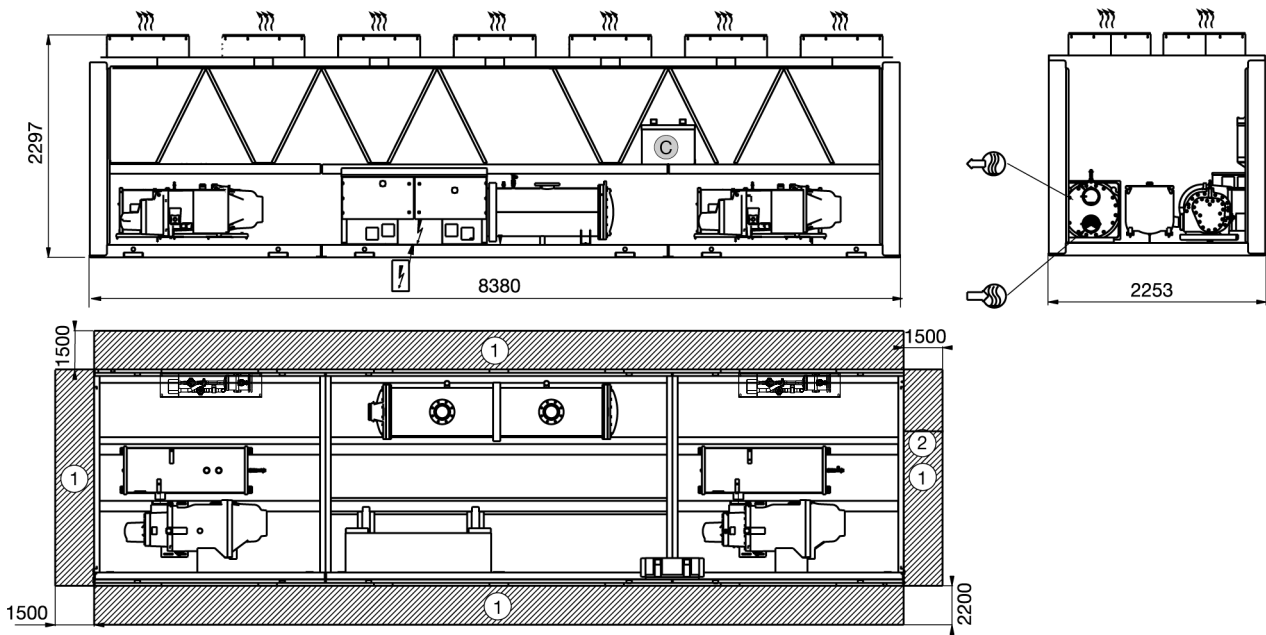



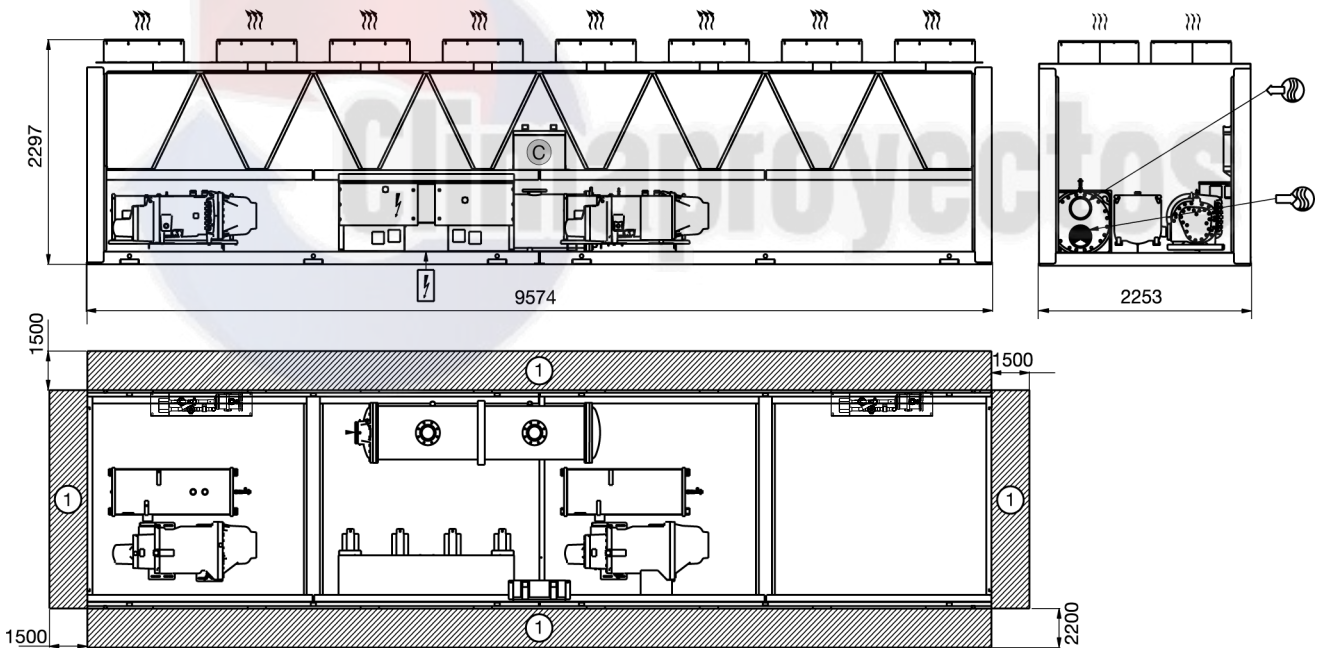

3.6 - 30XA 1002 MCHE heat exchanger (standard) and 30XA 902-1002 Cu/Al heat exchanger (option 254/255)



**Legend**

All dimensions are given in mm.

- ① Required clearances for maintenance (see note)
- ② Recommended space for evaporator tube removal
-  Water inlet for standard unit  
For options 5, 6, 100A, 100C, 107 refer to the certified drawing.
-  Water outlet for standard unit  
For options 5, 6, 100A, 100C, 107 refer to the certified drawing.
-  Air outlet – do not obstruct
-  Power supply and control connection
-  Control circuit connection for option 158

**NOTES:**



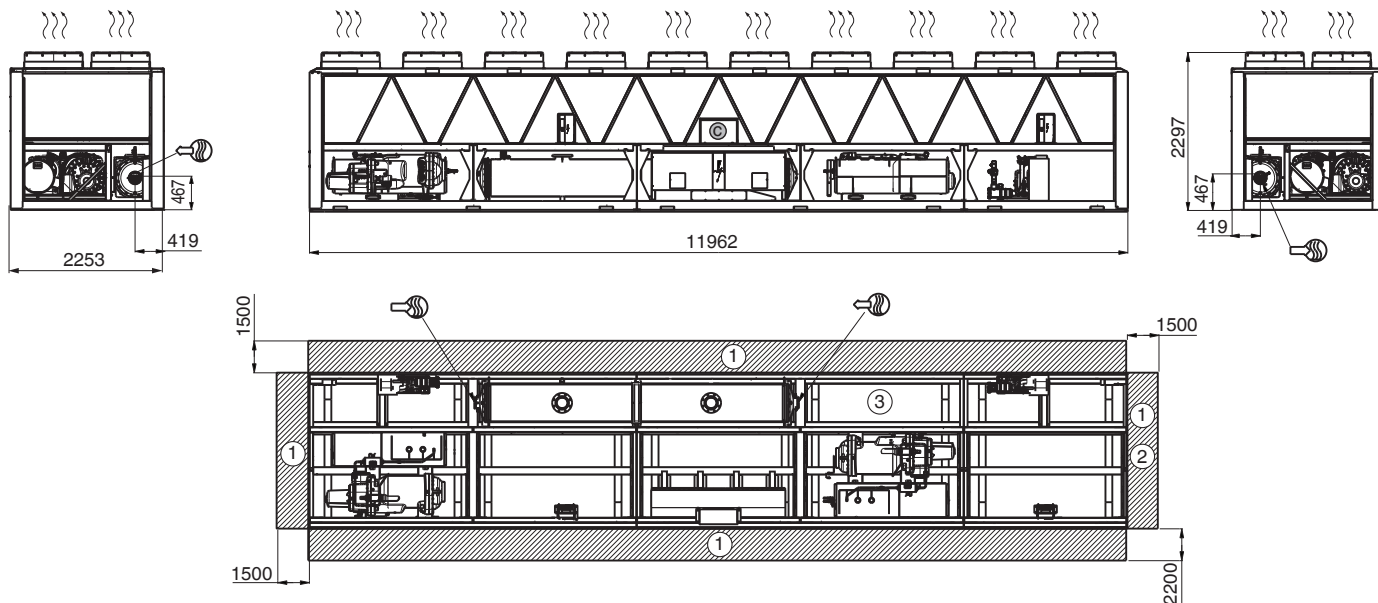

- Drawings are not contractually binding.
- Before designing an installation, consult the certified dimensional drawings, available on request.
- For the positioning of the fixing points, weight distribution and centre of gravity coordinates please refer to the dimensional drawings.
- If the installation includes several units or if this (these) is (are) close to walls, please refer to chapters 3.12 - “Multiple chiller installation” and 3.13 - “Distance to the wall” of this document to determine the space required.

**3.7 - 30XA 1112, 1212, 1312, 1382 MCHC heat exchanger (standard) and 30XA 1112, 1212, 1312, 1382 Cu/Al heat exchanger (option 254/255)**



**Legend**

All dimensions are given in mm.

- ① Required clearances for maintenance (see note)
- ② Recommended space for evaporator tube removal
- ③ Required clearances for maintenance if options 100A + 107 are used together
-  Water inlet for standard unit  
For options 5, 6, 100A, 100C, 107 refer to the certified drawing.
-  Water outlet for standard unit  
For options 5, 6, 100A, 100C, 107 refer to the certified drawing.
-  Air outlet – do not obstruct
-  Power supply and control connection
- © Control circuit connection for option 158

**NOTES:**

- **Drawings are not contractually binding.**
- **Before designing an installation, consult the certified dimensional drawings, available on request.**
- **For the positioning of the fixing points, weight distribution and centre of gravity coordinates please refer to the dimensional drawings.**
- **If the installation includes several units or if this (these) is (are) close to walls, please refer to chapters 3.12 - “Multiple chiller installation” and 3.13 - “Distance to the wall” of this document to determine the space required.**

**3.8 - 30XA 1402-1502 module 1/2 - MCHE heat exchanger (standard) and 30XA 1402-1502 module 1/2 - Cu/Al heat exchanger (option 254/255)**

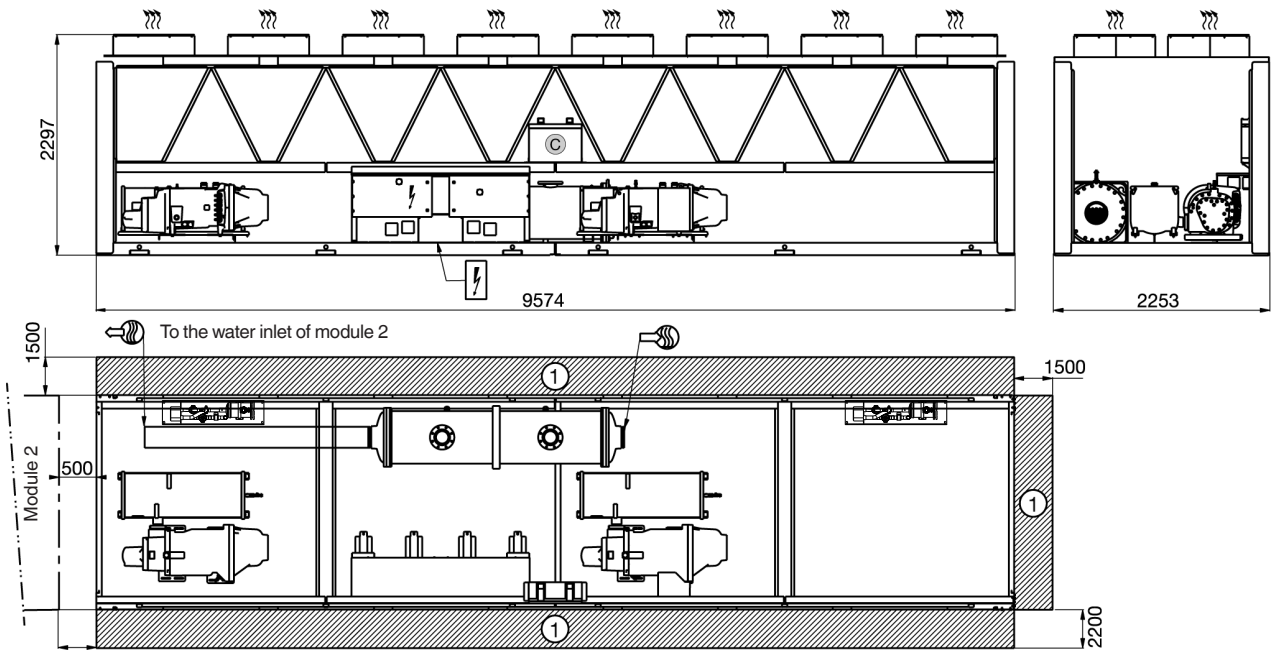



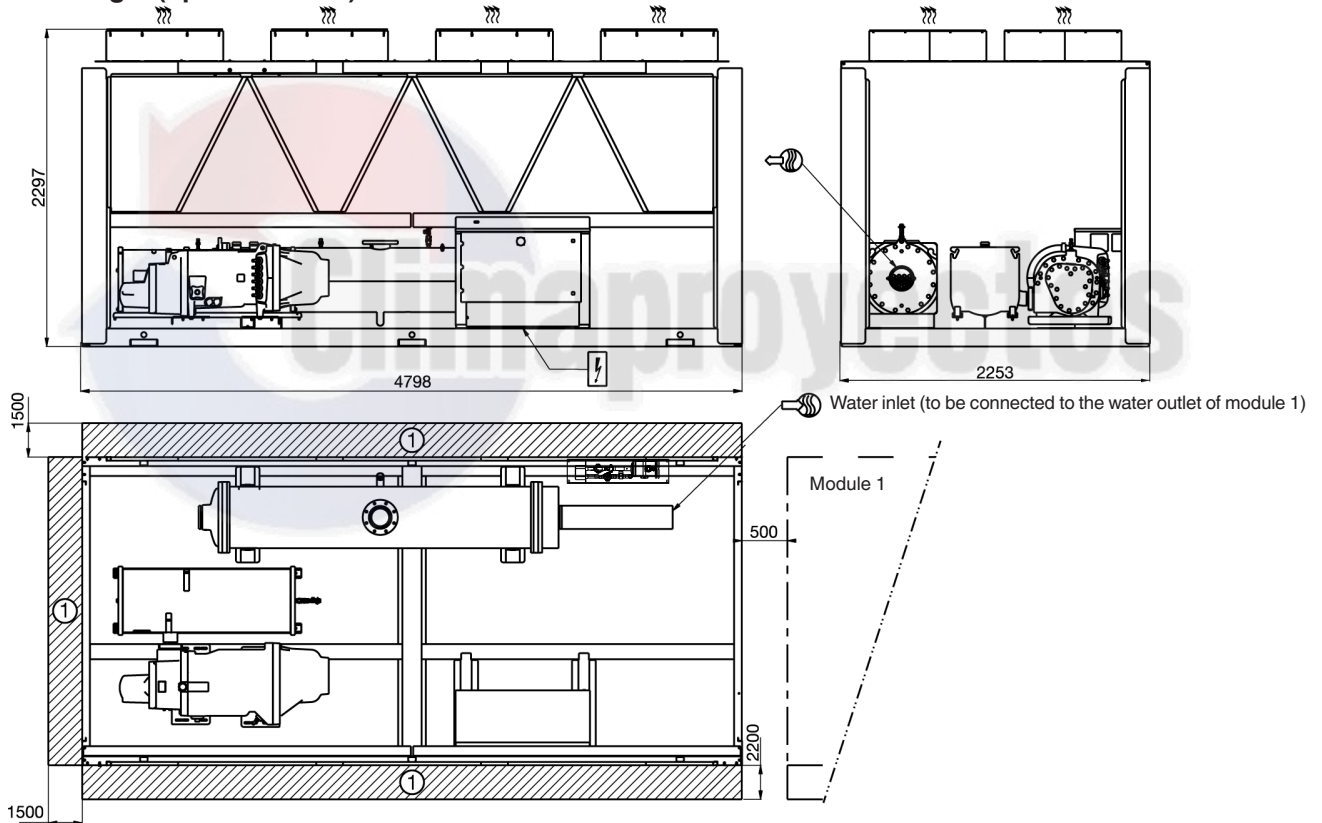

**3.9 - 30XA 1402-1502 module 2/2 - MCHE heat exchanger (standard) and 30XA 1402-1502 module 2/2 - Cu/Al heat exchanger (option 254/255)**



**Legend**

All dimensions are given in mm.

- ① Required clearances for maintenance (see note)
- ② Recommended space for evaporator tube removal
-  Water inlet for standard unit  
For options 5, 6, 100A, 100C, 107 refer to the certified drawing.
-  Water outlet for standard unit  
For options 5, 6, 100A, 100C, 107 refer to the certified drawing.
-  Air outlet – do not obstruct
-  Power supply and control connection
- © Control circuit connection for option 158

**NOTES:**

- Drawings are not contractually binding.
- Before designing an installation, consult the certified dimensional drawings, available on request.
- For the positioning of the fixing points, weight distribution and centre of gravity coordinates please refer to the dimensional drawings.
- If the installation includes several units or if this (these) is (are) close to walls, please refer to chapters 3.12 - “Multiple chiller installation” and 3.13 - “Distance to the wall” of this document to determine the space required.

**3.10 - 30XA 1702 module 1/2 - MCHE heat exchanger (standard) and 30XA 1702 module 1/2 - Cu/Al heat exchanger (option 254/255)**

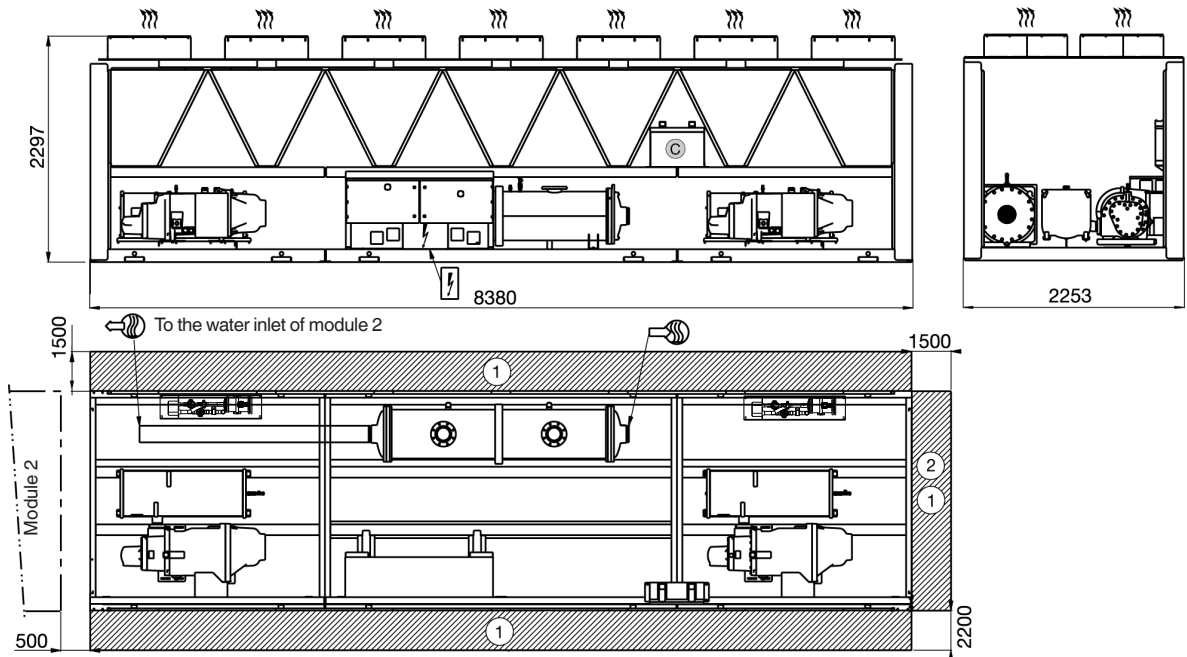

**3.11 - 30XA 1702 module 2/2 - MCHE heat exchanger (standard) and 30XA 1702 module 2/2 - Cu/Al heat exchanger (option 254/255)**

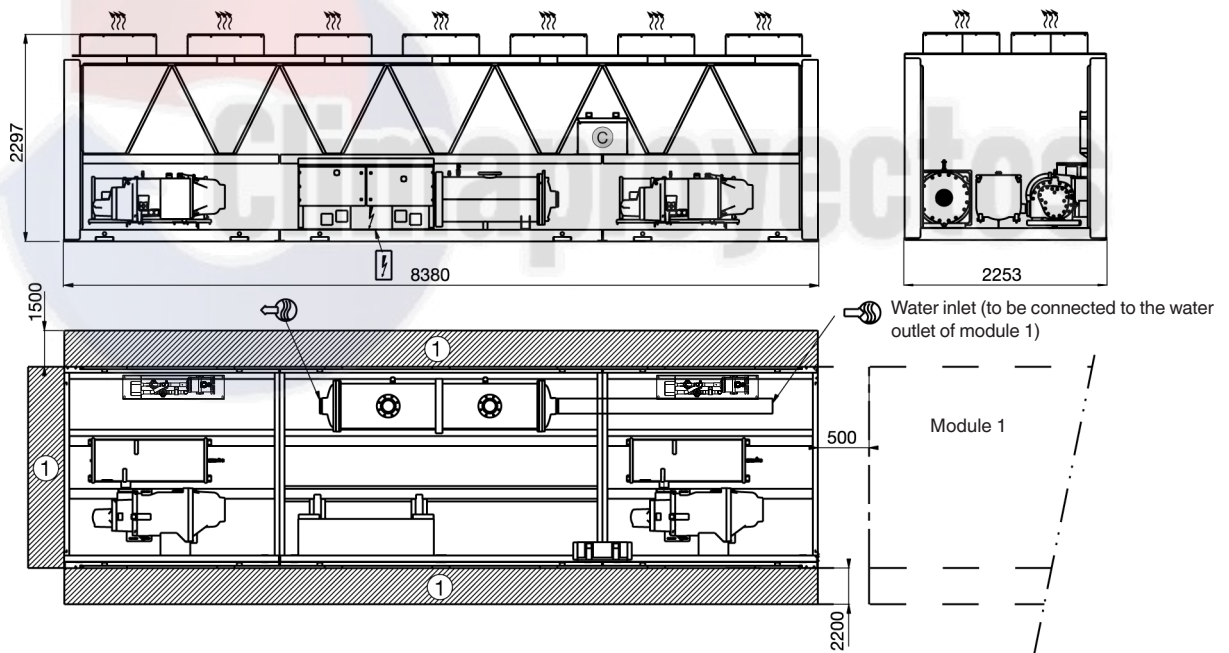

**Legend**

All dimensions are given in mm.

- ① Required clearances for maintenance (see note)
- ② Recommended space for evaporator tube removal
- Water inlet for standard unit  
For options 5, 6, 100A, 100C, 107 refer to the certified drawing.
- Water outlet for standard unit  
For options 5, 6, 100A, 100C, 107 refer to the certified drawing.
- Air outlet – do not obstruct
- Power supply and control connection
- Control circuit connection for option 158

**NOTES:**

- *Drawings are not contractually binding.*
- *Before designing an installation, consult the certified dimensional drawings, available on request.*
- *For the positioning of the fixing points, weight distribution and centre of gravity coordinates please refer to the dimensional drawings.*
- *If the installation includes several units or if this (these) is (are) close to walls, please refer to chapters 3.12 - “Multiple chiller installation” and 3.13 - “Distance to the wall” of this document to determine the space required.*

### 3.12 - Multiple chiller installation

It is recommended to install multiple chillers in a single row, arranged as shown in the example below, to avoid recycling of warm air from one unit to another.



If the situation at the site does not permit this arrangement, contact your Carrier distributor to evaluate the various possible arrangements. In certain situations an accessory (supplied loose at the time of purchase) can be added.

### 3.13 - Distance to the wall

To ensure correct operation for most cases:

If  $h < H$  (2.3 m), minimum  $S = 3$  m

If  $h > H$  or  $S < 3$  m, contact your Carrier distributor to evaluate the various possible arrangements. In certain situations an accessory (supplied loose at the time of purchase) can be added.

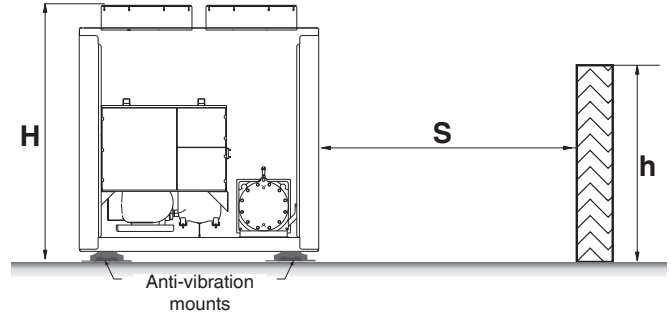



## 4 - PHYSICAL AND ELECTRICAL DATA FOR 30XA UNITS

### 4.1 - Physical data 30XA 252-852 - standard units and units with option 119\*

30XA		252	302	352	402	452	504	502	602	702	752	802	854	852
<b>Sound levels - Standard unit</b>														
Sound power level***	dB(A)	99	99	99	98	101	-	98	100	98	103	102	-	100
Sound pressure level at 10 m****	dB(A)	67	67	67	65	69	-	65	67	65	70	70	-	67
<b>Standard unit + option 279*</b>														
Sound power level***	dB(A)	89	89	89	92	93	-	93	95	94	96	96	-	95
Sound pressure level at 10 m****	dB(A)	57	57	57	60	61	-	61	62	61	63	64	-	63
<b>Standard unit + option 257*</b>														
Sound power level***	dB(A)	87	87	87	90	91	-	91	93	92	94	94	-	94
Sound pressure level at 10 m****	dB(A)	55	55	55	58	59	-	59	60	59	61	61	-	61
<b>Standard unit + option 258*</b>														
Sound power level***	dB(A)	-	-	-	-	89	-	89	91	90	91	92	-	91
Sound pressure level at 10 m****	dB(A)	-	-	-	-	57	-	56	58	57	59	59	-	59
<b>Standard unit + option 119*</b>														
Sound power level***	dB(A)	100	100	100	100	102	100	100	102	100	104	104	102	102
Sound pressure level at 10 m****	dB(A)	68	68	68	68	70	68	68	69	68	71	71	70	69
<b>Standard unit + option 119* + 279*</b>														
Sound power level***	dB(A)	94	94	95	96	96	96	96	98	97	98	99	98	98
Sound pressure level at 10 m****	dB(A)	62	62	63	64	64	64	64	66	64	65	66	65	65
<b>Dimensions - standard unit</b>														
Length	mm	3604	3604	3604	4798	4798	4798	5992	7186	7186	7186	7186	7186	8380
Width	mm	2253	2253	2253	2253	2253	2253	2253	2253	2253	2253	2253	2253	2253
Height	mm	2297	2297	2297	2297	2297	2297	2297	2297	2297	2297	2297	2297	2297
<b>Operating weight**</b>														
Standard unit and unit + option 119*	kg	3410	3450	3490	4313	4883	4524	4814	5707	5857	6157	6457	6662	6958
<b>Compressors</b>														
06T semi-hermetic screw compressors, 50 r/s														
Circuit A		1	1	1	1	1	1	1	1	1	1	1	1	1
Circuit B		1	1	1	1	1	1	1	1	1	1	1	1	1
<b>Refrigerant** -Standard unit</b>														
R-134a														
Circuit A	kg	37	35	35	50.5	52	53.5	58.5	58	58	65	69	69	72
	teqCO <sub>2</sub>	52.9	50.1	50.1	72.2	74.4	76.5	83.7	82.9	82.9	93.0	98.7	98.7	103.0
Circuit B	kg	38.5	36	37	36.5	37	32.5	36	59	62	58	65	65	63
	teqCO <sub>2</sub>	55.1	51.5	52.9	52.2	52.9	46.5	51.5	84.4	88.7	82.9	93.0	93.0	90.1
<b>Oil charge</b>														
Circuit A	l	20.8	20.8	20.8	23.5	23.5	23.5	23.5	23.5	23.5	27.6	27.6	27.6	27.6
Circuit B	l	20.8	20.8	20.8	20.8	20.8	20.8	20.8	23.5	23.5	23.5	23.5	23.5	23.5
<b>Capacity control</b>														
Touch Pilot, electronic expansion valve (EXV)														
Minimum capacity	%	15	15	15	15	15	15	15	15	15	15	15	15	15
<b>Condensers</b>														
All-aluminium microchannel heat exchanger (MCHE)														
<b>Fans - Standard unit</b>														
Axial Flying Bird IV fans with rotating shroud														
Quantity		6	6	6	8	8	-	9	11	12	12	12	-	14
Maximum total air flow	l/s	20500	20500	20500	27333	27333	-	30750	37583	41000	41000	41000	-	47833
Maximum rotation speed	r/s	11.7	11.7	11.7	11.7	11.7	-	11.7	11.7	11.7	11.7	11.7	-	11.7
<b>Standard unit + option 119*</b>														
Quantity		6	6	6	8	8	8	9	11	12	12	12	12	14
Maximum total air flow	l/s	27083	27083	27083	36111	36111	36111	40625	49653	54167	54167	54167	54167	63194
Maximum rotation speed	r/s	15.7	15.7	15.7	15.7	15.7	15.7	15.7	15.7	15.7	15.7	15.7	15.7	15.7
<b>Evaporator</b>														
Flooded multi-pipe type														
Water content	l	58	61	61	66	70	77	77	79	94	98	119	119	119
<b>Without hydronic module</b>														
Water inlet/outlet connections Victaulic														
Nominal diameter	in	5	5	5	5	5	5	5	5	6	6	6	6	6
Actual outside diameter	mm	141.3	141.3	141.3	141.3	141.3	141.3	141.3	141.3	168.3	168.3	168.3	168.3	168.3
Maximum water-side pressure†	kPa	1000	1000	1000	1000	1000	1000	1000	1000	1000	1000	1000	1000	1000
<b>With hydronic module (option 116)</b>														
Water inlet/outlet connections Victaulic														
Nominal diameter	in	4	4	4	4	4	-	4	-	-	-	-	-	-
Actual outside diameter	mm	114.3	114.3	114.3	114.3	114.3	-	114.3	-	-	-	-	-	-
Expansion tank volume	l	50	50	50	50	50	-	80	-	-	-	-	-	-
Maximum water-side pressure	kPa	400	400	400	400	400	-	400	-	-	-	-	-	-
<b>Chassis paint colour Colour</b>														
Colour code: RAL7035														

\* Options: 119 = High energy efficiency, 257 = low noise level, 279 = compressor enclosure, 258, = very low sound level

\*\* Weights are guidelines only. Refer to the unit nameplate.

\*\*\* in dB ref=10-12 W, (A) weighting. Declared dualnumber noise emission values in accordance with ISO 4871 (with an associated uncertainty of +/-3dB(A)). Measured in accordance with ISO 9614-1 and certified by Eurovent.

\*\*\*\* in dB ref 20µPa, (A) weighting. Declared dualnumber noise emission values in accordance with ISO 4871 (with an associated uncertainty of +/-3dB(A)). For information, calculated from the sound power level Lw(A).

† Max. water-side operating pressure without hydronic module.

**Note:** Unit sizes 30XA 1402 to 1702 are supplied in two field-assembled modules.



Eurovent certified values

#### 4.1 - Physical data 30XA 904-1702 - standard units and units with option 119\* (continued)

30XA		904	902	1002	1112	1212	1312	1382	1402	1502	1702
<b>Sound levels - Standard unit</b>											
Sound power level***	dB(A)	-	104	101	103	102	104	104	103	104	103
Sound pressure level at 10 m****	dB(A)	-	71	68	70	69	71	71	69	70	69
<b>Standard unit + option 279*</b>											
Sound power level***	dB(A)	-	97	96	97	96	100	97	97	97	97
Sound pressure level at 10 m****	dB(A)	-	64	63	64	63	67	64	64	64	64
<b>Standard unit + option 257*</b>											
Sound power level***	dB(A)	-	95	94	94	94	99	95	96	96	96
Sound pressure level at 10 m****	dB(A)	-	62	61	61	61	66	62	62	62	62
<b>Standard unit + option 258*</b>											
Sound power level***	dB(A)	-	93	92	93	93	-	94	93	93	93
Sound pressure level at 10 m****	dB(A)	-	60	59	60	60	-	61	60	60	60
<b>Standard unit + option 119*</b>											
Sound power level***	dB(A)	105	105	103	104	103	105	105	105	105	105
Sound pressure level at 10 m****	dB(A)	72	72	70	71	70	72	72	72	72	71
<b>Standard unit + option 119* + 279*</b>											
Sound power level***	dB(A)	100	100	99	99	99	101	100	101	101	101
Sound pressure level at 10 m****	dB(A)	67	67	66	66	66	68	66	68	68	67
<b>Dimensions - standard unit</b>											
Length	mm	7186	8380	9574	11962	11962	11962	11962	9574/4798	9574/4798	8380/8380
Width	mm	2253	2253	2253	2253	2253	2253	2253	2253	2253	2253
Height	mm	2297	2297	2297	2297	2297	2297	2297	2297	2297	2297
<b>Operating weight**</b>											
Standard unit and unit + option 119*	kg	6920	7258	7836	8210	8590	9310	9390	3953/7776	3953/7926	6958/6958
<b>Compressors</b>											
06T semi-hermetic screw compressors, 50 r/s											
Circuit A		1	1	1	1	1	1	1	1	1	1
Circuit B		1	1	1	1	1	1	1	1	1	1
Circuit C		-	-	-	-	-	-	-	1	1	1
Circuit D		-	-	-	-	-	-	-	-	-	1
<b>Refrigerant** - Standard unit</b>											
R-134a											
Circuit A	kg	67	69	75	80	80	110	116	84	85	72
	teqCO <sub>2</sub>	95.8	98.7	107.3	114.4	114.4	157.3	165.9	120.1	121.6	103.0
Circuit B	kg	67	76	79	116	124	116	124	78	88	63
	teqCO <sub>2</sub>	95.8	108.7	113.0	165.9	177.3	165.9	177.3	111.5	125.8	90.1
Circuit C	kg	-	-	-	-	-	-	-	80	80	72
	teqCO <sub>2</sub>	-	-	-	-	-	-	-	114.4	114.4	103.0
Circuit D	kg	-	-	-	-	-	-	-	-	-	63
	teqCO <sub>2</sub>	-	-	-	-	-	-	-	-	-	90.1
<b>Oil charge</b>											
Circuit A	l	27.6	27.6	27.6	27.6	27.6	36	36	27.6	27.6	27.6
Circuit B	l	27.6	27.6	27.6	36	36	36	36	27.6	27.6	23.5
Circuit C	l	-	-	-	-	-	-	-	27.6	27.6	27.6
Circuit D	l	-	-	-	-	-	-	-	-	-	23.5
<b>Capacity control</b>											
Touch Pilot, electronic expansion valve (EXV)											
Minimum capacity	%	15	15	15	8	8	8	8	10	10	8
<b>Condensers</b>											
All-aluminium microchannel heat exchanger (MCHE)											
<b>Fans - Standard unit</b>											
Axial Flying Bird IV fans with rotating shroud											
Quantity		-	14	16	19	20	20	20	24	24	28
Maximum total air flow	l/s	-	47833	54667	64917	68333	68333	68333	82000	82000	95667
Maximum rotation speed	r/s	-	11.7	11.7	11.7	11.7	11.7	11.7	11.7	11.7	11.7
<b>Standard unit + option 119*</b>											
Quantity		12	14	16	19	20	20	20	24	24	28
Maximum total air flow	l/s	54167	63194	72222	85764	90278	90278	90278	108333	108333	126389
Maximum rotation speed	r/s	15.7	15.7	15.7	11.7	11.7	11.7	11.7	15.7	15.7	15.7
<b>Evaporator</b>											
Flooded multi-pipe type											
Water content	l	130	130	140	164	174	180	189	230	240	240
<b>Without hydronic module</b>											
Water inlet/outlet connections											
Victaulic											
Nominal diameter	in	6	6	8	6	6	6	6	8/6	8/6	6
Actual outside diameter	mm	168.3	168.3	219.1	168.3	168.3	168.3	168.3	219.1/168.3	219.1/168.3	168.3
Maximum water-side pressure†	kPa	1000	1000	1000	1000	1000	1000	1000	1000	1000	1000
<b>Chassis paint colour Colour</b>											
Colour code: RAL7035											

\* Options: 119 = High energy efficiency, 257 = low noise level, 279 = compressor enclosure, 258, = very low sound level

\*\* Weights are guidelines only. Refer to the unit nameplate.

\*\*\* in dB ref=10-12 W, (A) weighting. Declared dualnumber noise emission values in accordance with ISO 4871 (with an associated uncertainty of +/-3dB(A)). Measured in accordance with ISO 9614-1 and certified by Eurovent.

\*\*\*\* in dB ref 20µPa, (A) weighting. Declared dualnumber noise emission values in accordance with ISO 4871 (with an associated uncertainty of +/-3dB(A)). For information, calculated from the sound power level Lw(A).

† Max. water-side operating pressure without hydronic module.

**Note:** Unit sizes 30XA 1402 to 1702 are supplied in two field-assembled modules.



Eurovent certified values

## 4.2 - Physical data 30XA 252-902 - units with option 254 and 255\*\*

30XA		252	302	352	402	452	502	602	702	752	802	852	902
<b>Operating weight*</b>	kg	3830	3860	4380	4830	4900	5470	6480	6640	7430	7750	7870	8620
<b>Sound levels</b>													
<b>Standard unit with options 254** or 255**</b>													
Sound power***	dB(A)	99	99	99	98	101	98	100	98	103	102	100	104
Sound pressure at 10 m****	dB(A)	67	67	68	65	69	65	67	65	70	70	67	71
<b>High-energy efficiency unit with option 119** and option 254** or 255**</b>													
Sound power***	dB(A)	100	100	100	100	102	100	102	100	104	104	102	105
Sound pressure at 10 m****	dB(A)	68	68	68	68	70	68	69	68	71	71	69	72
<b>Dimensions - standard unit + options 254/255*</b>													
Length	mm	3604	3604	4798	4798	4798	5992	7186	7186	8380	8380	8380	9574
Width	mm	2253	2253	2253	2253	2253	2253	2253	2253	2253	2253	2253	2253
Height	mm	2297	2297	2297	2297	2297	2297	2297	2297	2297	2297	2297	2297
<b>Refrigerant*</b>													
		R-134a											
Circuit A	kg	60	64	70	85	85	102	102	100	129	112	130	129
	teqCO <sub>2</sub>	85.8	91.5	100.1	121.6	121.6	145.9	145.9	143.0	184.5	160.2	185.9	184.5
Circuit B	kg	64	64	56	56	56	56	88	95	88	95	95	103
	teqCO <sub>2</sub>	91.5	91.5	80.1	80.1	80.1	80.1	125.8	135.9	125.8	135.9	135.9	147.3
<b>Compressors</b>													
		06T semi-hermetic screw compressors, 50 r/s											
Circuit A		1	1	1	1	1	1	1	1	1	1	1	1
Circuit B		1	1	1	1	1	1	1	1	1	1	1	1
Circuit C		-	-	-	-	-	-	-	-	-	-	-	-
Circuit D		-	-	-	-	-	-	-	-	-	-	-	-
<b>Oil charge</b>													
Circuit A	l	20.8	20.8	20.8	23.5	23.5	23.5	23.5	23.5	27.6	27.6	27.6	27.6
Circuit B	l	20.8	20.8	20.8	20.8	20.8	20.8	23.5	23.5	23.5	23.5	23.5	27.6
Circuit C	l	-	-	-	-	-	-	-	-	-	-	-	-
Circuit D	l	-	-	-	-	-	-	-	-	-	-	-	-
<b>Capacity control</b>													
		Touch Pilot, electronic expansion valve (EXV)											
Minimum capacity	%	15	15	15	15	15	15	15	15	15	15	15	15
<b>Condensers</b>													
		Copper/aluminium coil											
<b>Fans</b>													
		Axial Flying Bird IV fans with rotating shroud											
Quantity		6	6	7	8	8	9	11	12	13	13	14	15
Total air flow	l/s	20500	20500	20500	27333	27333	30750	37583	41000	41000	41000	47833	47833
Speed	r/s	11.7	11.7	11.7	11.7	11.7	11.7	11.7	11.7	11.7	11.7	11.7	11.7
<b>Evaporator</b>													
		Flooded multi-pipe type											
Water volume	l	58	61	61	66	70	77	79	94	98	119	119	130
Maximum pressure†	kPa	1000	1000	1000	1000	1000	1000	1000	1000	1000	1000	1000	1000

\* Weights are guidelines only. For sizes 1402 to 1702 weight of modules 1 and 2. The refrigerant charge is given on the unit nameplate.

\*\* Options: 119 = high energy efficiency, 254 = units with copper/aluminium coils, 255 = units with copper/aluminium coils without slots.

\*\*\* In dB ref=10<sup>-12</sup> W, (A) weighting. Declared dualnumber noise emission values in accordance with ISO 4871 (with an associated uncertainty of +/-3dB(A)). Measured in accordance with ISO 9614-1 and certified by Eurovent.

\*\*\*\* In dB ref 20µPa, (A) weighting. Declared dualnumber noise emission values in accordance with ISO 4871 (with an associated uncertainty of +/-3dB(A)). For information, calculated from the sound power level Lw(A).

† Max. water-side operating pressure without hydronic module.

### Notes:

1. Unit sizes 30XA 1402 to 1702 are supplied in two field-assembled modules.

2. Option 119 (high energy efficiency) can be used together with options 254 and 255. Contact your Carrier representative to obtain the performances.

## 4.2 - Physical data 30XA 1002-1702 - units with option 254 and 255\*\* (continued)

30XA		1002	1112	1212	1312	1382	1402	1502	1702
<b>Operating weight*</b>	kg	8870	8920	9330	10050	10140	4460/8830	4460/8950	7880/7880
<b>Sound levels</b>									
<b>Standard unit with options 254** or 255**</b>									
Sound power***	dB(A)	101	103	102	104	104	103	104	103
Sound pressure at 10 m****	dB(A)	68	70	69	71	71	69	70	69
<b>High-energy efficiency unit with option 119** and option 254** or 255**</b>									
Sound power***	dB(A)	103	104	103	105	105	105	105	105
Sound pressure at 10 m****	dB(A)	70	71	70	72	72	72	72	71
<b>Dimensions - standard unit + options 254/255*</b>									
Length	mm	9574	11962	11962	11962	11962	9574/4798	9574/4798	8380/8380
Width	mm	2253	2253	2253	2253	2253	2253	2253	2253
Height	mm	2297	2297	2297	2297	2297	2297	2297	2297
<b>Refrigerant*</b>									
Circuit A	kg	140	-	-	-	-	140	140	130
	teqCO <sub>2</sub>	200.2	-	-	-	-	200.2	200.2	185.9
Circuit B	kg	129	-	-	-	-	103	129	95
	teqCO <sub>2</sub>	184.5	-	-	-	-	147.3	184.5	135.9
Circuit C	kg	-	-	-	-	-	135	135	130
	teqCO <sub>2</sub>	-	-	-	-	-	193.1	193.1	185.9
Circuit D	kg	-	-	-	-	-	-	-	95
	teqCO <sub>2</sub>	-	-	-	-	-	-	-	66.4
<b>Compressors</b>									
06T semi-hermetic screw compressors, 50 r/s									
Circuit A		1	1	1	1	1	1	1	1
Circuit B		1	1	1	1	1	1	1	1
Circuit C		-	-	-	-	-	1	1	1
Circuit D		-	-	-	-	-	-	-	1
<b>Oil charge</b>									
Circuit A	l	27.6	27.6	36	36	36	27.6	27.6	27.6
Circuit B	l	27.6	36	36	36	36	27.6	27.6	23.5
Circuit C	l	-	-	-	-	-	27.6	27.6	27.6
Circuit D	l	-	-	-	-	-	-	-	23.5
<b>Capacity control</b>									
Touch Pilot, electronic expansion valve (EXV)									
Minimum capacity	%	15	-	-	-	-	10	10	8
<b>Condensers</b>									
Copper/aluminium coil									
<b>Fans</b>									
Axial Flying Bird IV fans with rotating shroud									
Quantity		16	19	20	20	20	24	24	28
Total air flow	l/s	54667	64917	68333	68333	68333	82000	82000	95667
Speed	tr/s	11.7	11.7	11.7	11.7	11.7	11.7	11.7	11.7
<b>Evaporator</b>									
Flooded multi-pipe type									
Water volume	l	140	164	174	180	189	230	240	240
Maximum pressure†	kPa	1000	1000	1000	1000	1000	1000	1000	1000

\* Weights are guidelines only. For sizes 1402 to 1702 weight of modules 1 and 2. The refrigerant charge is given on the unit nameplate.

\*\* Options: 119 = high energy efficiency, 254 = units with copper/aluminium coils, 255 = units with copper/aluminium coils without slots.

\*\*\* In dB ref=10-12 W, (A) weighting. Declared dualnumber noise emission values in accordance with ISO 4871 (with an associated uncertainty of +/-3dB(A)). Measured in accordance with ISO 9614-1 and certified by Eurovent.

\*\*\*\* In dB ref 20µPa, (A) weighting. Declared dualnumber noise emission values in accordance with ISO 4871 (with an associated uncertainty of +/-3dB(A)). For information, calculated from the sound power level Lw(A).

† Max. water-side operating pressure without hydronic module.

### Notes:

1. Unit sizes 30XA 1402 to 1702 are supplied in two field-assembled modules.

2. Option 119 (high energy efficiency) can be used together with options 254 and 255. Contact your Carrier representative to obtain the performances.

## 4.3 - Short-circuit stability current for all units

30XA		252	302	352	402	452	504	502	602	702	752	802	854	852	904
<b>Short-circuit stability current (TN system)*</b>															
Circuits A + B**	kA	38	38	38	38	38	38	38	50	50	50	50	50	50	50
Circuits C + D**	kA	-	-	-	-	-	-	-	-	-	-	-	-	-	-
Units with option 81	A	-	-	-	-	-	-	-	-	-	-	-	-	-	-
30XA		902	1002	1112	1212	1312	1382	1402	1502	1702					
<b>Short-circuit stability current (TN system)*</b>															
Circuits A + B**	kA	50	50	50	50	50	50	50	50	50					
Circuits C + D**	kA	-	-	50	50	50	50	50	50	50					
Units with option 81	A	-	-	50	50	50	50	50	50	50					

\* Type of system earthing

\*\* rms value

## 4.4 - Electrical data

### 30XA 252-852 - standard units or units with option 81

30XA		252	302	352	402	452	502	602	702	752	802	852
<b>Power circuit</b>												
Nominal power supply	V-ph-Hz	400-3-50 ± 10%										
<b>Control circuit</b>		24 V via internal transformer										
<b>Maximum start-up current*</b>												
Circuit 1**	A	269	269	287	402	505	505	574	606	773	803	805
Circuit 2**	A	-	-	-	-	-	-	-	-	-	-	-
Option 81	A	-	-	-	-	-	-	-	-	-	-	-
<b>Nominal start-up current***</b>												
Circuit 1**	A	245	245	262	378	480	480	536	562	735	759	761
Circuit 2**	A	-	-	-	-	-	-	-	-	-	-	-
Option 81	A	-	-	-	-	-	-	-	-	-	-	-
<b>Cosine Phi maximum****</b>		0.88	0.88	0.88	0.88	0.88	0.88	0.88	0.88	0.86	0.86	0.87
<b>Cosine Phi nominal†</b>		0.85	0.85	0.84	0.84	0.85	0.85	0.85	0.85	0.83	0.84	0.84
<b>Maximum power input‡</b>												
Circuit 1**	kW	121	131	141	165	185	204	247	267	293	312	343
Circuit 2**	kW	-	-	-	-	-	-	-	-	-	-	-
Option 81	kW	-	-	-	-	-	-	-	-	-	-	-
<b>Nominal unit current draw†</b>												
Circuit 1**	A	151	167	184	210	242	268	325	352	408	433	453
Circuit 2**	A	-	-	-	-	-	-	-	-	-	-	-
Option 81	A	-	-	-	-	-	-	-	-	-	-	-
<b>Maximum unit current draw (Un)‡</b>												
Circuit 1**	A	198	215	233	270	303	335	404	436	492	522	572
Circuit 2**	A	-	-	-	-	-	-	-	-	-	-	-
Option 81	A	-	-	-	-	-	-	-	-	-	-	-
Option 231	A	182	196	211	242	272	305	364	397	448	479	531
<b>Maximum unit current draw (Un-10%)****</b>												
Circuit 1**	A	208	232	251	290	326	360	435	469	529	561	615
Circuit 2**	A	-	-	-	-	-	-	-	-	-	-	-
Option 81	A	-	-	-	-	-	-	-	-	-	-	-

### 30XA 902-1702 - standard units or units with option 81

30XA		902	1002	1112	1212	1312	1382	1402	1502	1702
<b>Power circuit</b>										
Nominal power supply	V-ph-Hz	400-3-50 ± 10%								
<b>Control circuit</b>		24 V via internal transformer								
<b>Maximum start-up current*</b>										
Circuit 1**	A	893	941	587	587	772	772	893	941	805
Circuit 2**	A	-	-	772	772	772	772	587	587	805
Option 81	A	-	-	1085	1131	1198	1228	1248	1294	-
<b>Nominal start-up current**</b>										
Circuit 1**	A	845	865	587	587	772	772	845	865	761
Circuit 2**	A	-	-	772	772	772	772	587	587	761
Option 81	A	-	-	1023	1039	1103	1118	1125	1143	-
<b>Cosine Phi maximum****</b>		0.86	0.87	0.86	0.87	0.87	0.87	0.86	0.87	0.87
<b>Cosine Phi nominal†</b>		0.85	0.85	0.85	0.86	0.87	0.87	0.86	0.85	0.85
<b>Maximum power input‡</b>										
Circuit 1**	kW	359	420	182	211	256	278	390	420	343
Circuit 2**	kW	-	-	279	302	278	299	210	210	343
Option 81	kW	-	-	460	512	531	571	600	630	-
<b>Nominal unit current draw†</b>										
Circuit 1**	A	508	548	258	274	340	356	530	556	452
Circuit 2**	A	-	-	358	392	356	387	278	278	452
Option 81	A	-	-	616	666	696	743	808	834	-
<b>Maximum unit current draw (Un)‡</b>										
Circuit 1**	A	611	707	313	359	426	456	661	707	572
Circuit 2**	A	-	-	459	496	456	491	354	354	572
Option 81	A	-	-	771	855	882	947	1015	1061	-
Option 231	A	855	662	-	-	-	-	-	-	-
<b>Maximum unit current draw (Un-10%)****</b>										
Circuit 1**	A	657	760	332	381	462	494	711	760	615
Circuit 2**	A	-	-	497	527	494	522	380	380	615
Option 81	A	-	-	828	908	956	1016	1091	1141	-

\* Instantaneous start-up current (operating current of the smallest compressor + fan current + locked rotor current in star connection of the largest compressor). Values obtained at operation with maximum unit power input.

\*\* 30XA 1402 to 1702 units: Circuit 1 supplies circuits A and B, circuit 2 supplies circuits C and D. 30XA 1112, 1212, 1312 and 1382 units: Circuit 1 supplies circuit A, circuit 2 supplies circuit B.

\*\*\* Instantaneous start-up current (operating current of the smallest compressor + fan current + locked rotor current in star connection of the largest compressor). Values obtained at standard Eurovent unit operating conditions: air 35 °C, water 12/7 °C

\*\*\*\* Values obtained at operation with maximum unit power input.

† Values obtained at standard Eurovent unit operating conditions: air 35 °C, water 12/7 °C

‡ Values obtained at operation with maximum unit power input. Values given on the unit name plate.

#### Notes:

- Unit sizes 30XA 1112, 1212, 1312, 1382, 1402 to 1702 have two power connection points.

#### 4.4 - Electrical data (continued)

##### 30XA 252-852 - units with option 119 or units with option 119 and option 81

30XA		252	302	352	402	452	504	502	602	702	752	802	854	852
<b>Power circuit</b>														
Nominal power supply	V-ph-Hz	400-3-50 ± 10%												
<b>Control circuit</b>		24 V via internal transformer												
<b>Maximum start-up current*</b>														
Circuit 1**	A	274	274	292	407	510	510	510	583	616	782	812	812	815
Circuit 2**	A	-	-	-	-	-	-	-	-	-	-	-	-	-
Option 81	A	-	-	-	-	-	-	-	-	-	-	-	-	-
<b>Nominal start-up current***</b>														
Circuit 1**	A	246	246	261	379	479	479	479	535	561	734	757	760	760
Circuit 2**	A	-	-	-	-	-	-	-	-	-	-	-	-	-
Option 81	A	-	-	-	-	-	-	-	-	-	-	-	-	-
<b>Cosine Phi maximum****</b>		0.88	0.87	0.87	0.88	0.88	0.88	0.88	0.88	0.88	0.86	0.86	0.86	0.86
<b>Cosine Phi nominal†</b>		0.84	0.84	0.83	0.83	0.84	0.84	0.84	0.84	0.84	0.83	0.83	0.83	0.83
<b>Maximum power input‡</b>														
Circuit 1**	kW	126	136	147	172	192	211	212	257	278	304	323	353	356
Circuit 2**	kW	-	-	-	-	-	-	-	-	-	-	-	-	-
Option 81	kW	-	-	-	-	-	-	-	-	-	-	-	-	-
<b>Nominal unit current draw†</b>														
Circuit 1**	A	151	167	182	210	239	267	267	324	349	409	430	446	446
Circuit 2**	A	-	-	-	-	-	-	-	-	-	-	-	-	-
Option 81	A	-	-	-	-	-	-	-	-	-	-	-	-	-
<b>Maximum unit current draw‡</b>														
Circuit 1**	A	208	226	243	284	316	347	350	423	457	512	542	590	596
Circuit 2**	A	-	-	-	-	-	-	-	-	-	-	-	-	-
Option 81	A	-	-	-	-	-	-	-	-	-	-	-	-	-
Option 231	A	192	207	221	256	285	317	320	383	418	468	499	549	555
<b>Maximum unit current draw (Un-10%)****</b>														
Circuit 1**	A	219	243	262	305	340	373	376	455	491	551	583	634	640
Circuit 2**	A	-	-	-	-	-	-	-	-	-	-	-	-	-
Option 81	A	-	-	-	-	-	-	-	-	-	-	-	-	-

##### 30XA 904-1702 - units with option 119 or units with option 119 and option 81

30XA		904	902	1002	1112	1212	1312	1382	1402	1502	1702
<b>Power circuit</b>											
Nominal power supply	V-ph-Hz	400-3-50 ± 10%									
<b>Control circuit</b>		24 V via internal transformer									
<b>Maximum start-up current*</b>											
Circuit 1**	A	902	905	954	587	587	772	772	905	954	815
Circuit 2**	A	-	-	-	772	772	772	772	587	587	815
Option 81	A	-	-	-	1093	1139	1208	1238	1275	1321	-
<b>Nominal start-up current***</b>											
Circuit 1**	A	843	845	860	587	587	772	772	845	860	760
Circuit 2**	A	-	-	-	772	772	772	772	587	587	760
Option 81	A	-	-	-	1031	1047	1113	1128	1122	1133	-
<b>Cosine Phi maximum****</b>		0.85	0.85	0.86	0.86	0.87	0.87	0.87	0.86	0.86	0.86
<b>Cosine Phi nominal†</b>		0.84	0.84	0.84	0.84	0.84	0.85	0.86	0.84	0.84	0.84
<b>Maximum power input‡</b>											
Circuit 1**	kW	369	372	435	186	216	262	284	405	435	356
Circuit 2**	kW	-	-	-	286	309	284	305	217	217	356
Option 81	kW	-	-	-	471	525	544	584	622	652	-
<b>Nominal unit current draw†</b>											
Circuit 1**	A	511	511	541	259	275	341	356	527	546	446
Circuit 2**	A	-	-	-	360	393	356	386	273	273	446
Option 81	A	-	-	-	619	668	697	742	800	820	-
<b>Maximum unit current draw (Un)‡</b>											
Circuit 1**	A	629	635	734	321	367	436	466	688	734	596
Circuit 2**	A	-	-	-	470	508	466	501	367	367	596
Option 81	A	-	-	-	790	875	902	967	1056	1102	-
Option 231	A	582	588	689	-	-	-	-	-	-	-
<b>Maximum unit current draw (Un-10%)****</b>											
Circuit 1**	A	677	683	790	340	389	472	504	740	790	640
Circuit 2**	A	-	-	-	508	539	504	532	395	395	640
Option 81	A	-	-	-	847	928	976	1036	1135	1185	-

\* Instantaneous start-up current (operating current of the smallest compressor + fan current + locked rotor current in star connection of the largest compressor). Values obtained at operation with maximum unit power input.

\*\* 30XA 1402 to 1702 units: Circuit 1 supplies circuits A and B, circuit 2 supplies circuits C and D. 30XA 1112, 1212, 1312 and 1382 units: Circuit 1 supplies circuit A, circuit 2 supplies circuit B.

\*\*\* Instantaneous start-up current (operating current of the smallest compressor + fan current + locked rotor current in star connection of the largest compressor). Values obtained at standard Eurovent unit operating conditions: air 35 °C, water 12/7 °C

\*\*\*\* Values obtained at operation with maximum unit power input.

† Values obtained at standard Eurovent unit operating conditions: air 35 °C, water 12/7 °C

‡ Values obtained at operation with maximum unit power input. Values given on the unit name plate.

#### Notes:

- Unit sizes 30XA 1112, 1212, 1312, 1382, 1402 to 1702 have two power connection points.

#### 4.4 - Electrical data (continued)

##### 30XA 252-902 - units with options 254 and 255 or units with options 254 and 255 and option 81

30XA		252	302	352	402	452	502	602	702	752	802	852	902
<b>Power circuit</b>													
Nominal power supply	V-ph-Hz	400-3-50 ± 10%											
<b>Control circuit</b>		24 V via internal transformer											
<b>Maximum start-up current*</b>													
Circuit 1**	A	269	269	287	402	505	505	574	606	773	805	805	893
Circuit 2**	A	-	-	-	-	-	-	-	-	-	-	-	-
Option 81	A	-	-	-	-	-	-	-	-	-	-	-	-
<b>Nominal start-up current***</b>													
Circuit 1**	A	245	245	262	378	480	480	536	562	735	761	761	845
Circuit 2**	A	-	-	-	-	-	-	-	-	-	-	-	-
Option 81	A	-	-	-	-	-	-	-	-	-	-	-	-
<b>Cosine Phi maximum****</b>		0.88	0.88	0.87	0.88	0.88	0.88	0.88	0.88	0.86	0.86	0.87	0.86
<b>Cosine Phi nominal†</b>		0.85	0.85	0.84	0.84	0.85	0.85	0.85	0.85	0.83	0.84	0.84	0.85
<b>Maximum power input‡</b>													
Circuit 1**	kW	121	131	142	165	185	204	247	267	294	313	343	360
Circuit 2**	kW	-	-	-	-	-	-	-	-	-	-	-	-
Option 81	kW	-	-	-	-	-	-	-	-	-	-	-	-
<b>Nominal unit current draw†</b>													
Circuit 1**	A	151	167	186	210	242	268	325	352	412	437	453	512
Circuit 2**	A	-	-	-	-	-	-	-	-	-	-	-	-
Option 81	A	-	-	-	-	-	-	-	-	-	-	-	-
<b>Maximum unit current draw (Un)‡</b>													
Circuit 1**	A	198	215	235	270	303	335	404	436	494	524	572	613
Circuit 2**	A	-	-	-	-	-	-	-	-	-	-	-	-
Option 81	A	-	-	-	-	-	-	-	-	-	-	-	-
Option 231	A	182	196	213	242	272	305	364	397	450	481	531	855
<b>Maximum unit current draw (Un-10%)****</b>													
Circuit 1**	A	208	232	253	290	326	360	435	469	531	563	615	659
Circuit 2**	A	-	-	-	-	-	-	-	-	-	-	-	-
Option 81	A	-	-	-	-	-	-	-	-	-	-	-	-

##### 30XA 1002-1702 - units with options 254 and 255 or units with options 254 and 255 and option 81

30XA		1002	1112	1212	1312	1382	1402	1502	1702
<b>Power circuit</b>									
Nominal power supply	V-ph-Hz	400-3-50 ± 10%							
<b>Control circuit</b>		24 V via internal transformer							
<b>Maximum start-up current*</b>									
Circuit 1**	A	941	587	587	772	772	893	941	805
Circuit 2**	A	-	772	772	772	772	587	587	761
Option 81	A	-	1085	1131	1198	1228	1248	1294	-
<b>Nominal start-up current***</b>									
Circuit 1**	A	865	587	587	772	772	845	865	761
Circuit 2**	A	-	772	772	772	772	587	587	761
Option 81	A	-	1023	1039	1103	1118	1125	1143	-
<b>Cosine Phi maximum****</b>		0.87	0.86	0.87	0.87	0.87	0.86	0.87	0.87
<b>Cosine Phi nominal†</b>		0.85	0.85	0.86	0.87	0.87	0.86	0.85	0.85
<b>Maximum power input‡</b>									
Circuit 1**	kW	420	182	211	256	278	390	420	343
Circuit 2**	kW	-	279	302	278	299	210	210	343
Option 81	kW	-	460	512	531	571	600	630	-
<b>Nominal unit current draw†</b>									
Circuit 1**	A	552	258	274	340	356	530	556	452
Circuit 2**	A	-	358	392	356	387	278	278	452
Option 81	A	-	616	666	696	743	808	834	-
<b>Maximum unit current draw (Un)‡</b>									
Circuit 1**	A	707	313	359	426	456	661	707	572
Circuit 2**	A	-	459	496	456	491	354	354	572
Option 81	A	-	771	855	882	947	1015	1061	-
Option 231	A	660	-	-	-	-	-	-	-
<b>Maximum unit current draw (Un-10%)****</b>									
Circuit 1**	A	760	332	381	462	494	711	760	615
Circuit 2**	A	-	497	527	494	522	380	380	615
Option 81	A	-	828	908	956	1016	1091	1141	-

\* Instantaneous start-up current (operating current of the smallest compressor + fan current + locked rotor current in star connection of the largest compressor). Values obtained at operation with maximum unit power input.

\*\* 30XA 1402 to 1702 units: Circuit 1 supplies circuits A and B, circuit 2 supplies circuits C and D. 30XA 1112, 1212, 1312 and 1382 units: Circuit 1 supplies circuit A, circuit 2 supplies circuit B.

\*\*\* Instantaneous start-up current (operating current of the smallest compressor + fan current + locked rotor current in star connection of the largest compressor). Values obtained at standard Eurovent unit operating conditions: air 35 °C, water 12/7 °C

\*\*\*\* Values obtained at operation with maximum unit power input.

† Values obtained at standard Eurovent unit operating conditions: air 35 °C, water 12/7 °C

‡ Values obtained at operation with maximum unit power input. Values given on the unit name plate.

#### Notes:

- Unit sizes 30XA 1112, 1212, 1312, 1382, 1402 to 1702 have two power connection points.

#### 4.4 - Electrical data (continued)

##### 30XA 252-902 - units with options 254 and 255 + option 119 or units with options 254 and 255 + option 119 + option 81

30XA		252	302	352	402	452	502	602	702	752	802	852	902
<b>Power circuit</b>													
Nominal power supply	V-ph-Hz	400-3-50 ± 10%											
<b>Control circuit</b>		24 V via internal transformer											
<b>Maximum start-up current*</b>													
Circuit 1**	A	274	274	292	407	510	510	583	616	782	815	815	905
Circuit 2**	A	-	-	-	-	-	-	-	-	-	-	-	-
Option 81	A	-	-	-	-	-	-	-	-	-	-	-	-
<b>Nominal start-up current***</b>													
Circuit 1**	A	246	246	261	379	479	479	535	561	734	760	760	845
Circuit 2**	A	-	-	-	-	-	-	-	-	-	-	-	-
Option 81	A	-	-	-	-	-	-	-	-	-	-	-	-
<b>Cosine Phi maximum****</b>		0.88	0.87	0.87	0.88	0.88	0.88	0.88	0.88	0.86	0.86	0.86	0.85
<b>Cosine Phi nominal†</b>		0.84	0.84	0.83	0.83	0.84	0.84	0.84	0.84	0.83	0.83	0.83	0.84
<b>Maximum power input‡</b>													
Circuit 1**	kW	126	136	148	172	192	212	257	278	306	325	356	373
Circuit 2**	kW	-	-	-	-	-	-	-	-	-	-	-	-
Option 81	kW	-	-	-	-	-	-	-	-	-	-	-	-
<b>Nominal unit current draw†</b>													
Circuit 1**	A	151	167	185	210	239	267	324	349	411	432	446	513
Circuit 2**	A	-	-	-	-	-	-	-	-	-	-	-	-
Option 81	A	-	-	-	-	-	-	-	-	-	-	-	-
<b>Maximum unit current draw (Un)‡</b>													
Circuit 1**	A	208	226	247	284	316	350	423	457	516	546	596	639
Circuit 2**	A	-	-	-	-	-	-	-	-	-	-	-	-
Option 81	A	-	-	-	-	-	-	-	-	-	-	-	-
Option 231	A	192	207	225	256	285	320	383	418	472	503	555	855
<b>Maximum unit current draw (Un-10%)****</b>													
Circuit 1**	A	219	243	266	305	340	376	455	491	555	587	640	687
Circuit 2**	A	-	-	-	-	-	-	-	-	-	-	-	-
Option 81	A	-	-	-	-	-	-	-	-	-	-	-	-

##### 30XA 1002-1702 - units with options 254 and 255 + option 119 or units with options 254 and 255 + option 119 + option 81

30XA		1002	1112	1212	1312	1382	1402	1502	1702
<b>Power circuit</b>									
Nominal power supply	V-ph-Hz	400-3-50 ± 10%							
<b>Control circuit</b>		24 V via internal transformer							
<b>Maximum start-up current*</b>									
Circuit 1**	A	954	587	587	772	772	905	954	815
Circuit 2**	A	-	772	772	772	772	587	587	815
Option 81	A	-	1093	1139	1208	1238	1275	1321	-
<b>Nominal start-up current***</b>									
Circuit 1**	A	860	587	587	772	772	845	860	760
Circuit 2**	A	-	772	772	772	772	587	587	760
Option 81	A	-	1031	1047	1113	1128	1122	1133	-
<b>Cosine Phi maximum****</b>		0.86	0.86	0.87	0.87	0.87	0.86	0.86	0.86
<b>Cosine Phi nominal†</b>		0.84	0.84	0.84	0.85	0.86	0.84	0.84	0.84
<b>Maximum power input‡</b>									
Circuit 1**	kW	435	186	216	262	284	405	435	356
Circuit 2**	kW	-	286	309	284	305	217	217	356
Option 81	kW	-	471	525	544	584	622	652	-
<b>Nominal unit current draw†</b>									
Circuit 1**	A	541	259	275	341	356	527	546	446
Circuit 2**	A	-	360	393	356	386	273	273	446
Option 81	A	-	619	668	697	742	808	820	-
<b>Maximum unit current draw (Un)‡</b>									
Circuit 1**	A	734	321	367	436	466	688	734	596
Circuit 2**	A	-	470	508	466	501	367	367	596
Option 81	A	-	790	875	902	967	1056	1102	-
Option 231	A	687	-	-	-	-	-	-	-
<b>Maximum unit current draw (Un-10%)****</b>									
Circuit 1**	A	790	340	389	472	504	740	790	640
Circuit 2**	A	-	508	539	504	532	395	395	640
Option 81	A	-	847	928	976	1036	1135	1185	-

\* Instantaneous start-up current (operating current of the smallest compressor + fan current + locked rotor current in star connection of the largest compressor). Values obtained at operation with maximum unit power input.

\*\* 30XA 1402 to 1702 units: Circuit 1 supplies circuits A and B, circuit 2 supplies circuits C and D. 30XA 1112, 1212, 1312 and 1382 units: Circuit 1 supplies circuit A, circuit 2 supplies circuit B.

\*\*\* Instantaneous start-up current (operating current of the smallest compressor + fan current + locked rotor current in star connection of the largest compressor). Values obtained at standard Eurovent unit operating conditions: Air 35 °C, water 12/7 °C

\*\*\*\* Values obtained at operation with maximum unit power input.

† Values obtained at standard Eurovent unit operating conditions: Air 35 °C, water 12/7 °C

‡ Values obtained at operation with maximum unit power input. Values given on the unit name plate.

#### Notes:

- Unit sizes 30XA 1112, 1212, 1312, 1382, 1402 to 1702 have two power connection points.



## 4.5 - Compressor electrical data

Compressor	I Nom* Std/Option 119	I Max** (Un)	MHA	LRYA (Un)	LRDA (Un)	Cosine Phi (max.)**	Cosine Phi (nom.)*
06TSA155	69/64	86	96	170	530	0.90	0.87
06TSA186	87/80	108	120	170	530	0.89	0.86
06TTA266	128/117	158	176	303	945	0.90	0.86
06TTA301	145/132	177	188	388	1210	0.90	0.87
06TTA356	166/153	207	220	388	1210	0.90	0.87
06TUA483	240/225	292	311	587	1828	0.88	0.87
06TUA554	262/241	338	360	587	1828	0.89	0.88
06TVA680	320/302	400	436	772	2315	0.89	0.87
06TVA753	335/315	430	468	772	2315	0.89	0.88
06TVA819	367/347	465	496	772	2315	0.89	0.88

\* Average value for the range (unit at Eurovent conditions)

\*\* Value at maximum capacity and nominal voltage (400 V)

### Legend

**MHA** - Maximum compressor operating current, limited by the unit (current given for maximum capacity at 360 V)

**LRYA** - Locked rotor current for star connection (connection during compressor start-up)

**LRDA** - Locked rotor current for delta connection

## 4.6 - Compressor usage per circuit (A, B, C, D)

Compressor	30XA																							
	252	302	352	402	452	504	502	602	702	752	802	854	852	904	902	1002	1112	1212	1312	1382	1402	1502	1702	
06TSA155	AB	B	—	B	—	—	—	—	—	—	—	—	—	—	—	—	—	—	—	—	—	—	—	—
06TSA186	—	A	AB	—	B	B	—	—	—	—	—	—	—	—	—	—	—	—	—	—	—	—	—	—
06TTA266	—	—	—	A	—	—	—	—	—	—	—	—	—	—	—	—	—	—	—	—	—	—	—	—
06TTA301	—	—	—	—	A	—	—	B	—	B	—	—	—	—	—	—	—	—	—	—	—	—	—	—
06TTA356	—	—	—	—	—	A	A	A	AB	—	B	B	B	—	—	—	—	—	—	—	—	—	—	BD
06TUA483	—	—	—	—	—	—	—	—	—	A	A	—	—	AB	AB	—	A	—	—	—	B	—	—	—
06TUA554	—	—	—	—	—	—	—	—	—	—	—	A	A	—	—	AB	—	A	—	—	AC	ABC	AC	—
06TVA680	—	—	—	—	—	—	—	—	—	—	—	—	—	—	—	—	—	—	A	—	—	—	—	—
06TVA753	—	—	—	—	—	—	—	—	—	—	—	—	—	—	—	—	B	—	B	A	—	—	—	—
06TVA819	—	—	—	—	—	—	—	—	—	—	—	—	—	—	—	—	—	B	—	B	—	—	—	—

### Electrical data notes and operating conditions for 30XA units:

- 30XA 252-1002 units have a single power connection point; 30XA 1112, 1212, 1312, 1382, 1402 to 1702 units have two connection points.
  - The control box includes the following standard features:
    - One general disconnect switch per circuit
    - Starter and motor protection devices for each compressor, the fan(s) and the pump
    - Control devices
  - Field connections:**
    - All connections to the system and the electrical installations must be in full accordance with all applicable local codes.
    - The Carrier 30XA units are designed and built to ensure conformance with these codes. The recommendations of European standard EN 60204-1 (corresponds to IEC 60204-1) (machine safety - electrical machine components - part 1: General regulations) are specifically taken into account, when designing the electrical equipment.
  - IMPORTANT:**
    - Generally the recommendations of IEC 60364 are accepted as compliance with the requirements of the installation regulations.
    - Conformance with EN 60204 is the best means of ensuring compliance with the Machines Directive § 1.5.1. Annex B of EN 60204-1 describes the electrical characteristics used for the operation of the machines.
  - 1. Environment\* - Environment as classified in EN 60364 (corresponds to IEC 60364):
    - Outdoor installation\*
    - Ambient temperature range: from -20 °C to +55 °C\*\*
    - Altitude less than or equal to 2000 m (for hydronic module, see paragraph 4.7 in the IOM)
    - Presence of hard solids, class AE3\* (no significant dust present)
    - Presence of corrosive and polluting substances, class AF1 (negligible)
    - Competence of persons: BA4 (Persons wise); 30XA machines are not intended to be installed in locations open to anyone, including people with disabilities and children.
  - 2. Compatibility for low-frequency conducted disturbances according to IEC61000-2-2 and to class 2 levels per IEC61000-2-4 standard:
    - Power supply frequency variation : +2Hz
    - Phase imbalance : 2%
    - Total Voltage Harmonic Distortion (THDV) : 8 %
  - 3. The neutral (N) line must not be connected directly to the unit (if necessary use a transformer).
  - 4. Overcurrent protection of the power supply conductors is not provided with the unit.
  - 5. The factory-installed disconnect switch(es)/circuit breaker(s) is (are) of a type suitable for power interruption in accordance with EN 60947-3 (corresponds to IEC 60947-3).
  - 6. The units are designed for simplified connection on TN(s) networks (IEC 60364). For IT networks provide a local earth and consult competent local organisations to complete the electrical installation. Units delivered with speed drive (options 28) are not compatible with IT network.
    - Derived currents: If protection by monitoring of derived currents is necessary to ensure the safety of the installation, the control of the cut-out value must take the presence of leak currents into consideration that result from the use of optional frequency converters in the unit. In particular, a type of enhanced immunity protection and/or a value of at least 150 mA is recommended to control differential protection devices.
    - Capacitors that are integrated as part of the option 231 can generate electrical disturbances in the installation the unit is connected to. Presence of these capacitors must be considered during the electrical study prior to the start-up.
- NOTE: If particular aspects of an actual installation do not conform to the conditions described above, or if there are other conditions which should be considered, always contact your local Carrier representative.**
- \* The required protection level for this class is IP43BW (according to reference document IEC 60529). All 30XA units are protected to IP44CW and fulfil this protection condition.
- \*\* The maximum ambient temperature allowed for machines equipped with option 231 is +40 °C

## 4.7 - Electrical data, optional hydronic module

*The pumps that are factory-installed in these units have motors with efficiency class IE2. The additional electrical data required\* is as follows:*

### Motors of single and dual low-pressure pumps for 30XA units (options 116F and 116G)

No.**	Description***		30XA					
			252	302	352	402	452	502
1	Nominal efficiency at full load and nominal voltage	%	83.4	83.4	84.8	86.1	88.6	88.6
1	Nominal efficiency at 75% rated load and nominal voltage	%	84	84	85.3	86.3	88.5	88.5
1	Nominal efficiency at 50% rated load and nominal voltage	%	82.9	82.9	84.2	84.7	86.7	86.7
2	Efficiency level		IE2					
3	Year of manufacture		This information varies depending on the manufacturer and model at the time of incorporation. Please refer to the motor name plates.					
4	Manufacturer's name and trademark, commercial registration number and place of manufacturer							
5	Product's model number							
6	Number of motor poles		2					
7-1	Rated shaft power output at full load and nominal voltage (400 V)	kW	2.2	2.2	3	4	5.5	5.5
7-2	Maximum power input (400 V)****	kW	2.6	2.6	3.5	4.6	6.2	6.2
8	Rated input frequency	Hz	50					
9-1	Rated voltage	V	3 x 400					
9-2	Maximum current drawn at nominal voltage (400 V)†	A	4.4	4.4	5.8	7.7	10.2	10.2
10	Rated speed	r/s (rpm)	48 (2880)	48 (2880)	48 (2885)	48 (2895)	49 (2935)	49 (2935)
11	Product disassembly, recycling or disposal at end of life		Disassembly using standard tools. Disposal and recycling using an appropriate company.					
12	Operating conditions for which the motor is specifically designed							
	I - Altitudes above sea level	m	< 1000††					
	II - Ambient air temperature	°C	< 40					
	IV - Maximum air temperature	°C	Please refer to the operating conditions given in this manual or in the specific conditions in the Carrier selection programs.					
	V - Potentially explosive atmospheres		Non-ATEX environment					

### Motors of single and dual high-pressure pumps for 30XA units (options 116B and 116C)

No.**	Description***		30XA					
			252	302	352	402	452	502
1	Nominal efficiency at full load and nominal voltage	%	86.1	88.6	88.6	90.1	91.3	91.3
1	Nominal efficiency at 75% rated load and nominal voltage	%	86.3	88.5	88.5	89.7	91.4	91.4
1	Nominal efficiency at 50% rated load and nominal voltage	%	84.7	86.7	86.7	87.9	90.3	90.3
2	Efficiency level		IE2	IE2	IE2	IE3	IE3	IE3
3	Year of manufacture		This information varies depending on the manufacturer and model at the time of incorporation. Please refer to the motor name plates.					
4	Manufacturer's name and trademark, commercial registration number and place of manufacturer							
5	Product's model number							
6	Number of motor poles		2					
7-1	Rated shaft power output at full load and nominal voltage (400 V)	kW	4.0	5.5	5.5	7.5	11.0	11.0
7-2	Maximum power input (400 V)****	kW	4.6	6.2	6.2	8.3	12.0	12.0
8	Rated input frequency	Hz	50					
9-1	Rated voltage	V	3 x 400					
9-2	Maximum current drawn at nominal voltage (400 V)†	A	7.7	10.2	10.2	13.2	18.7	18.7
10	Rated speed	r/s (rpm)	48 (2898)	49 (2935)	49 (2935)	49 - 2935	49 - 2945	49 - 2945
11	Product disassembly, recycling or disposal at end of life		Disassembly using standard tools. Disposal and recycling using an appropriate company.					
12	Operating conditions for which the motor is specifically designed							
	I - Altitudes above sea level	m	< 1000††					
	II - Ambient air temperature	°C	< 40					
	IV - Maximum air temperature	°C	Please refer to the operating conditions given in this manual or in the specific conditions in the Carrier selection programs.					
	V - Potentially explosive atmospheres		Non-ATEX environment					

\* Required by regulation 640/2009 with regard to the application of directive 2005/32/EC on the eco-design requirements for electric motors

\*\* Item number imposed by regulation 640/2009, annex I2b.

\*\*\* Description given by regulation 640/2009, annex I2b.

\*\*\*\* To obtain the maximum power input for a unit with hydronic module add the maximum unit power input from the electrical data table to the pump power input.

† To obtain the maximum unit operating current draw for a unit with hydronic module add the maximum unit current draw from the electrical data table to the pump current draw.

†† Above 1000 m, a degradation of 3% for each 500 m should be taken into consideration.

## 5 - ELECTRICAL CONNECTION

Please refer to the certified dimensional drawings, supplied with the unit.

### 5.1 - Power supply

The power supply must conform to the specification on the chiller nameplate. The supply voltage must be within the range specified in the electrical data table. For connections refer to the wiring diagrams and the certified dimensional drawings.

**WARNING: Operation of the chiller with an improper supply voltage or excessive phase imbalance constitutes abuse which will invalidate the Carrier warranty. If the phase imbalance exceeds 2% for voltage, or 10% for current, contact your local electricity supply at once and ensure that the chiller is not switched on until corrective measures have been taken.**

### 5.2 - Voltage phase imbalance (%)

$$\frac{100 \times \text{max. deviation from average voltage}}{\text{Average voltage}}$$

Example:

On a 400 V - 3 ph - 50 Hz supply, the individual phase voltages were measured to be:

AB = 406 V; BC = 399; AC = 394 V

$$\begin{aligned} \text{Average voltage} &= (406 + 399 + 394)/3 = 1199/3 \\ &= 399.7 \text{ say } 400 \text{ V} \end{aligned}$$

Calculate the maximum deviation from the 400 V average:

$$(AB) = 406 - 400 = 6$$

$$(BC) = 400 - 399 = 1$$

$$(CA) = 400 - 394 = 6$$

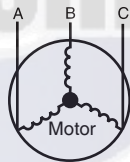

The maximum deviation from the average is 6 V. The greatest percentage deviation is:  $100 \times 6/400 = 1.5 \%$

This is less than the permissible 2% and therefore acceptable.

### 5.3 - Power connection/disconnect switch

Units	Connection points
30XA 0252-1002	1 per unit
30XA 1112, 1212, 1312, 1382, 1402 to 1702	1 for circuit 1 1 for circuit 2

## 5.4 - Recommended wire sections

Wire sizing is the responsibility of the installer, and depends on the characteristics and regulations applicable to each installation site. The following is only to be used as a guideline, and does not make in any way liable. After wire sizing has been completed, using the certified dimensional drawing, the installer must ensure easy connection and define any modifications necessary on site.

The connections provided as standard for the field-supplied power entry cables to the general disconnect/isolator switch are designed for the number and type of wires, listed in column 2 of the table on the next page.

The calculations are based on the maximum machine current (see electrical data tables).

The calculations for favourable and unfavourable cases are based on the maximum current for each unit (see electrical data tables). For the design the standardised installation methods in accordance with IEC 60364 are used: PVC (70 °C) or XLPE (90 °C) insulated cables with copper core; arrangement to comply with table 52c of the above standard. The maximum temperature is 46 °C. The given maximum length is calculated to limit the voltage drop to 5%.

**IMPORTANT: Before connection of the main power cables (L1 - L2 - L3) on the terminal block, it is imperative to check the correct order of the 3 phases before proceeding to the connection on then terminal block or the main disconnect/isolator switch.**

### 5.5 - Power cable entry

The power cables can enter the 30XA control box from below or from the unit side. For 30XA unit sizes 602 to 1702 the control box that includes the power supply cable connection terminal is located in the lower part of the unit. In this case the control box is raised by 120 mm compared to the lowest point of the chassis.

The cable entry point depends on the unit configuration:

1. Unit raised from the ground (e.g. installation on support rails): It is recommended to enter the power cables from below the control box. A removable aluminium plate below the control box allows introduction of the cables.
2. Unit placed on the ground: For power cable entry from below the control box ensure that the cable bend radius is compatible with the connection space available in the control box. If not, an aluminium plate on the control box face allows introduction of the cables.

For units with three circuits with option 81 (single power connection point) the connection must be made from below the unit.

**IMPORTANT: Check the cable bend radius for cable entry into a control box, located in the lower part of the unit.**

Refer to the certified dimensional drawing for the unit.

## 5.6 - Field control wiring

**IMPORTANT: Field connection of interface circuits may lead to safety risks: Any control box modification must maintain equipment conformity with local regulations. Precautions must be taken to prevent accidental electrical contact between circuits supplied by different sources:**

- The routing selection and/or conductor insulation characteristics must ensure dual electric insulation.
- In case of accidental disconnection, conductor fixing between different conductors and/or in the control box prevents any contact between the conductor ends and an active energised part.

Refer to the 30XA/30XAS/30XW Touch Pilot control manual and the certified wiring diagram supplied with the unit for the field control wiring of the following features:

- Remote on/off switch
- Demand limit external switch
- Remote dual set point
- Alarm, alert and operation report
- Evaporator pump control
- Heat reclaim condenser pump control (option)
- Hot water valve control (option)
- Set point reset via outside air temperature sensor reset
- Various interlocks on the Energy ManagementModule (EMM) board (option).

### Selection of minimum and maximum wire sections for connection to 30XA units

30XA	Max. connectable section*	Calculation favourable case: Suspended aerial lines (standardised routing No. 17) XLPE insulated cable			Calculation unfavourable case: Conductors in conduits or multi-conductor cables in closed conduit (standardised routing No. 41) PVC insulated cable, if possible		
	Section	Section**	Max. length for voltage drop <5%	Cable type	Section**	Max. length for voltage drop <5%	Cable type***
	mm <sup>2</sup> (per phase)	mm <sup>2</sup> (per phase)	m		mm <sup>2</sup> (per phase)	m	
252	2 x 185	1 x 95	190	XLPE Cu	2 x 95	450	PVC Cu
302	2 x 185	1 x 95	190	XLPE Cu	2 x 95	420	PVC Cu
352	2 x 185	1 x 120	197	XLPE Cu	2 x 95	390	PVC Cu
402	2 x 185	1 x 150	200	XLPE Cu	2 x 120	400	PVC Cu
452	2 x 185	1 x 185	205	XLPE Cu	2 x 150	420	PVC Cu
504	2 x 185	1 x 240	205	XLPE Cu	2 x 185	430	PVC Cu
502	2 x 185	1 x 240	205	XLPE Cu	2 x 185	430	PVC Cu
602	2 x 240	2 x 95	190	XLPE Cu	2 x 240	440	PVC Cu
702	2 x 240	2 x 120	198	XLPE Cu	2 x 185	330	XLPE Cu
752	2 x 240	2 x 120	198	XLPE Cu	2 x 240	370	XLPE Cu
802	2 x 240	2 x 150	200	XLPE Cu	2 x 240	330	XLPE Cu
854	2 x 240	2 x 150	200	XLPE Cu	2 x 240	320	XLPE Cu
852	2 x 240	2 x 150	200	XLPE Cu	2 x 240	320	XLPE Cu
904	2 x 240	2 x 185	205	XLPE Cu	Not compatible	-	-
902	2 x 240	2 x 185	205	XLPE Cu	Not compatible	-	-
1002	4 x 300	2 x 240	205	XLPE Cu	4 x 185	320	XLPE Cu
<b>Circuits A and B/C (common routing)</b>							
1112	2 x 240/3 x 240	1 x 185/2 x 120	291/240	XLPE Cu	2 x 240/3 x 240	600/530	PVC Cu/PVC Cu
1212	2 x 240/3 x 240	1 x 240/2 x 150	310/270	XLPE Cu	2 x 150/2 x 240	380/380	XLPE Cu/XLPE/Cu
1312	2 x 240/3 x 240	2 x 120/2 x 120	260/240	XLPE Cu	2 x 240/2 x 240	420/400	XLPE Cu/XLPE Cu
1382	2 x 240/3 x 240	2 x 120/2 x 150	240/270	XLPE Cu	2 x 240/2 x 240	400/380	XLPE Cu/XLPE Cu
1402	2 x 240/2 x 240	2 x 240/1 x 240	280/310	XLPE Cu	Not compatible	-	-
1502	4 x 300/2 x 240	2 x 300/1 x 240	300/310	XLPE Cu	4 x 240/2 x 150	400/380	XLPE Cu/XLPE Cu
1702	2 x 240/2 x 300	2 x 185/2 x 185	260/260	XLPE Cu	Not compatible	-	-
<b>Option 81</b>							
1402	8 x 240	-	-	-	-	-	-
1502	8 x 240	-	-	-	-	-	-
1112	5 x 240	-	-	-	-	-	-
1212	5 x 240	-	-	-	-	-	-
1312	5 x 240	-	-	-	-	-	-
1382	5 x 240	-	-	-	-	-	-

\* Connection capacities actually available for each machine, defined according to the connection terminal size, the control box access opening size and the available space inside the control box.

\*\* Selection simulation result considering the hypothesis indicated.

\*\*\* If the maximum calculated section is for an XLPE cable type or specified "not compatible", this means that it exists a risk to exceed the real connection capacity available. Special attention must be given to the selection.

**Note:** The currents considered are given for a machine equipped with a hydronic kit operating at maximum current.



## 6 - APPLICATION DATA

### 6.1 - Operating range

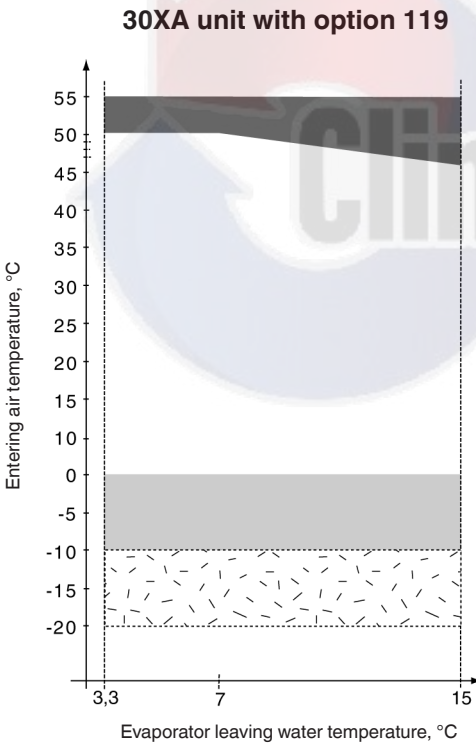
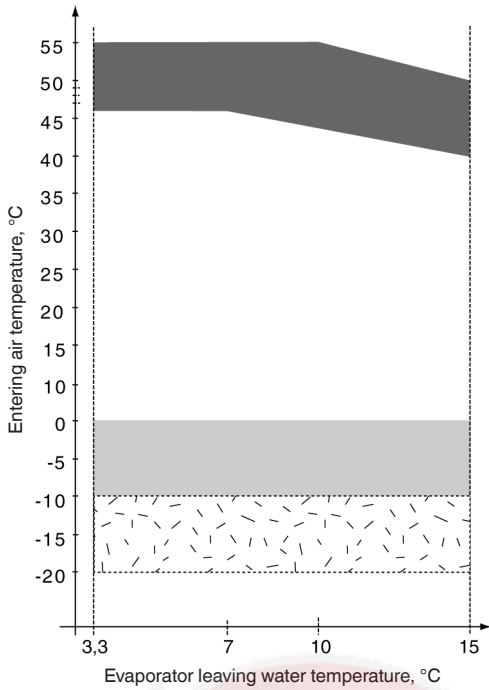
30XA standard unit and 30XA0504, 854, 904 with option 119.



**Legend:**

-  Operating range, unit equipped with option 28 (winter operation).
-  Below 0 °C air temperature the unit must either be equipped with the evaporator frost protection option (41A or 41B), or the water loop must be protected against frost by using a frost protection solution (by the installer).
-  Part load average

**ATTENTION: Option 28 (Winter operation)**

If the outside temperature is below -10 °C and the unit has been switched off for more than 4 hours, it is necessary to wait 2 hours after the unit has been switched on again to allow the frequency converter to warm up.

Evaporator water temperature			
	°C	Minimum	Maximum
Water entering temperature at start-up	-		45*
Water entering temperature during operation	6.8		21
Water leaving temperature during operation	3.3		15

**Note:** If the leaving water temperature is below 4 °C, a glycol/water solution or the frost protection option must be used.

Condenser air temperature			
	°C	Minimum	Maximum
Storage		-20	68
Operation, standard unit and 30XA504, 854, 904 with opt 119		-10	55**
With winter operation option (option 28)		-20	55**
With high energy efficiency option (option 119)***		-10	55****

**Note:** If the air temperature is below 0 °C, a glycol/water solution or the frost protection option must be used.

- \* Based on the installation type and the air temperature
- \*\* Part load, based on the water temperature
- \*\*\* Recommended for operation above 46 °C
- \*\*\*\* Part-load operation

### 6.2 - Minimum chilled water flow (units without hydronic module)

The minimum chilled water flow is shown in the table on the next page. If the system flow is less than this, the evaporator flow can be recirculated, as shown in the diagram.

**For minimum chilled water flow rate**

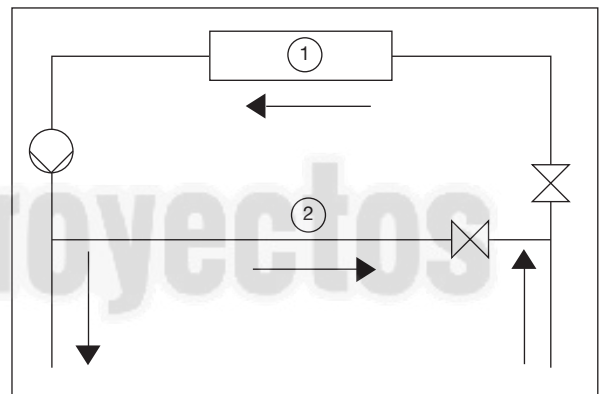

- 1 Evaporator
- 2 Recirculation

### 6.3 - Maximum chilled water flow (units without hydronic module)

The maximum chilled water flow is shown in the table on the next page. If the system flow exceeds the maximum value, it can be bypassed as shown in the diagram.

**For maximum chilled water flow rate**

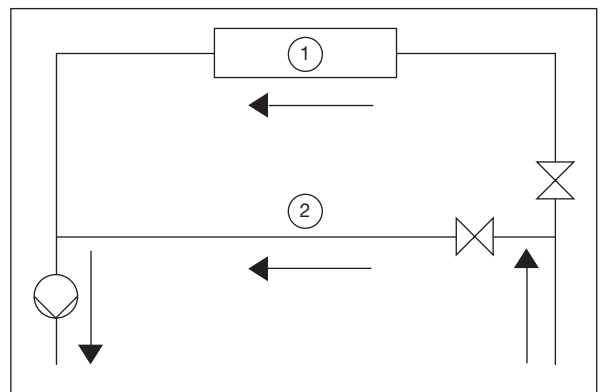

- 1 Evaporator
- 2 Bypass

## 6.4 - Variable flow evaporator

Variable evaporator flow can be used in standard 30XA chillers. The chillers maintain a constant leaving water temperature under all flow conditions. For this to happen, the minimum flow rate must be higher than the minimum flow given in the table of permissible flow rates and must not vary by more than 10% per minute.

If the flow rate changes more rapidly, the system should contain a minimum of 6.5 litres of water per kW instead of 3.25 l/kW.

## 6.5 - System minimum water volume

Whichever the system, the water loop minimum capacity is given by the formula:

$$\text{Capacity} = \text{Cap (kW)} \times \text{N litres}$$

Application	N
Normal air conditioning	3.25
Process type cooling	6.5

Where Cap is the nominal system cooling capacity (kW) at the nominal operating conditions of the installation.

This volume is necessary for stable operation and accurate temperature control.

It is often necessary to add a buffer water tank to the circuit in order to achieve the required volume. The tank must itself be internally baffled in order to ensure proper mixing of the liquid (water or brine). Refer to the examples below.

### Connection to a buffer tank

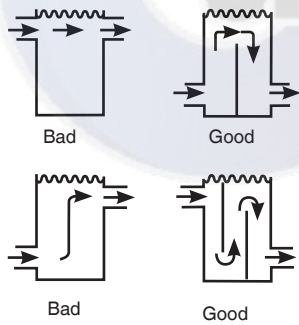

## 6.6 - Maximum system water volume

Units with hydronic module incorporate an expansion tank that limits the water volume. The table below gives the maximum loop volume for pure water or ethylene glycol with various system concentrations, as well as the static pressures. If the maximum volume is insufficient, compared to the minimum system water loop volume, an additional expansion tank must be added to the system.

30XA Static pressure	252-452			502		
	kPa bar	100 1	200 2	250 2.5	100 1	200 2
<b>Max. water loop volume</b>	<b>l</b>					
Pure water	2400	1600	1200	3960	2640	1980
Ethylene glycol 10%	1800	1200	900	2940	1960	1470
Ethylene glycol 20%	1320	880	660	2100	1400	1050
Ethylene glycol 30%	1080	720	540	1740	1160	870
Ethylene glycol 40%	900	600	450	1500	1000	750

## 6.7 - Evaporator water flow rate

30XA	Evaporator water flow rate, l/s*	
	Min. flow rate	Max. flow rate**
252	3.6	37.5
302	4.0	40.5
352	4.3	40.5
402	5.3	34.1
452	6.0	36.9
504	6.7	42
502	6.7	42.0
602	8.1	45.0
702	8.9	56.1
752	9.6	59.1
802	10.4	67.1
854	11	67.1
852	11.0	67.1
904	11.8	73.9
902	11.8	73.9
1002	13.1	83.9
1112	15.1	126.5
1212	16.4	132.1
1312	17.5	118.5
1382	18.8	131.1
1402	19.3	107.4
1502	19.9	109.4
1702	22.0	107.4

\* Standard evaporators with water as the heat transfer fluid.

\*\* The maximum water flow rate corresponds to a pressure drop of 100 kPa.

## 6.8 - Evaporator pressure drop curve

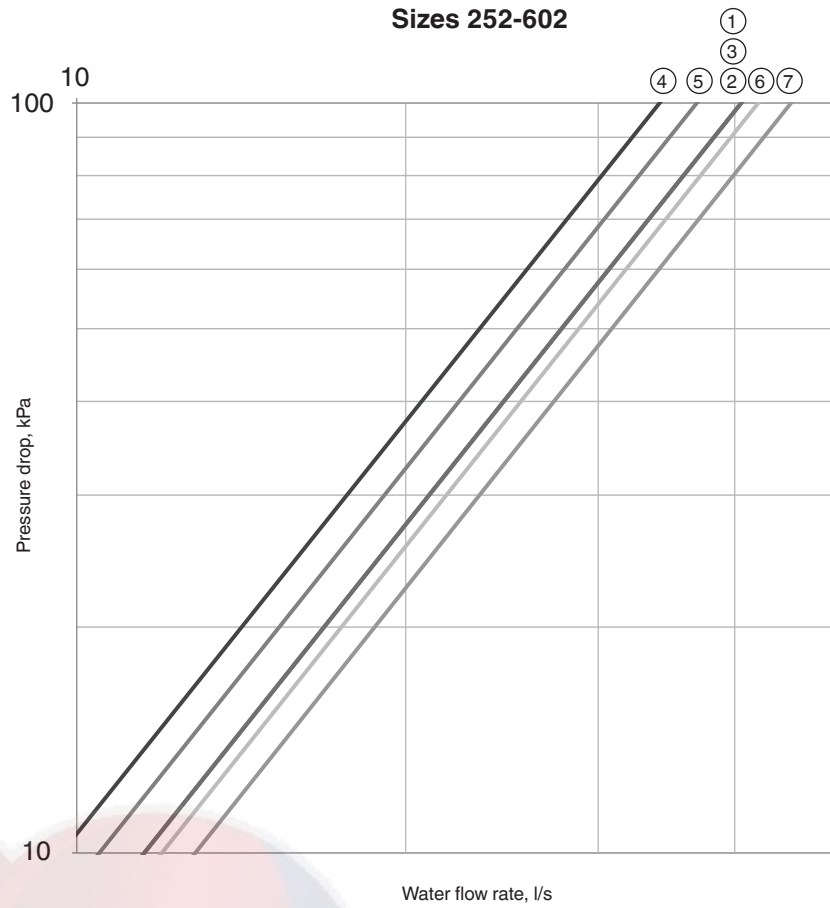

**Legend**

1	252
2	302
3	352
4	402
5	452
6	504 - 502
7	602

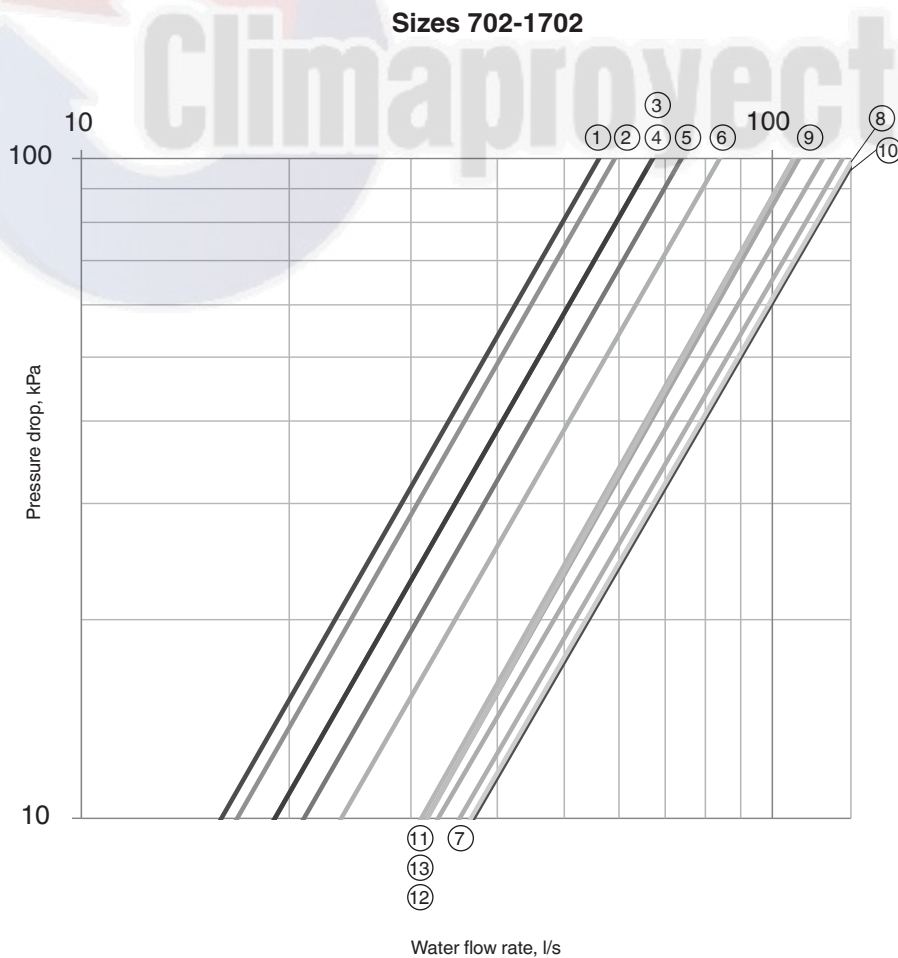

**Legend**

1	702
2	752
3	802
4	854 - 852
5	904 - 902
6	1002
7	1112
8	1212
9	1312
10	1382
11	1402
12	1502
13	1702

## 7 - WATER CONNECTIONS

**ATTENTION: Before carrying out any water connections install the water box purge plugs (one plug per water box in the lower section - supplied in the control box).**

For size and position of the heat exchanger water inlet and outlet connections refer to the certified dimensional drawings supplied with the unit.

The water pipes must not transmit any radial or axial force to the heat exchangers nor any vibration.

The water supply must be analysed and appropriate filtering, treatment, control devices, isolation and bleed valves and circuits built in, to prevent corrosion, fouling and deterioration of the pump fittings. Consult either a water treatment specialist or appropriate literature on the subject.

### 7.1 - Operating precautions

The water circuit should be designed to have the least number of elbows and horizontal pipe runs at different levels. Below the main points to be checked for the connection:

- Comply with the water inlet and outlet connections shown on the unit.
- Install manual or automatic air purge valves at all high points in the circuit(s).
- Use a pressure reducer to maintain pressure in the circuit(s) and install a relief valve as well as an expansion tank.
- Install thermometers in both the entering and leaving water connections.
- Install drain connections at all low points to allow the whole circuit to be drained.
- Install stop valves, close to the entering and leaving water connections.
- Use flexible connections to reduce the transmission of vibrations.
- Insulate all pipework, after testing for leaks, both to reduce heat gains and to prevent condensation.
- Cover the insulation with a vapour barrier.
- Where there are particles in the fluid that could foul the heat exchanger, a screen filter should be installed ahead of the pump. The mesh size of the filter must be 1.2 mm (see 'Typical water circuit diagram').
- Before the system start-up verify that the water circuits are connected to the appropriate heat exchangers (e.g. no reversal between evaporator and condenser).
- Do not introduce any significant static or dynamic pressure into the heat exchange circuit (with regard to the design operating pressures).
- Before any start-up verify that the heat exchange fluid is compatible with the materials and the water circuit coating.
- The use of different metals on hydraulic piping could generate electrolytic pairs and consequently corrosion. Verify then, the need to install sacrificial anodes.

In case additives or other fluids than those recommended by Carrier are used, ensure that the fluids are not considered as a gas, and that they belong to class 2, as defined in directive 97/23/EC.

Carrier recommendations on heat exchange fluids:

- No  $\text{NH}_4^+$  ammonium ions in the water, they are very detrimental for copper. This is one of the most important factors for the operating life of copper piping. A content of several tenths of mg/l will badly corrode the copper over time.
- Cl Chloride ions are detrimental for copper with a risk of perforations by corrosion by puncture. If possible keep below 125 mg/l.
- $\text{SO}_4^{2-}$  sulphate ions can cause perforating corrosion, if their content is above 30 mg/l.
- No fluoride ions (<0.1 mg/l)
- No  $\text{Fe}^{2+}$  and  $\text{Fe}^{3+}$  ions with non negligible levels of dissolved oxygen must be present. Dissolved iron < 5 mg/l with dissolved oxygen < 5 mg/l.
- Dissolved silicon: silicon is an acid element of water and can also lead to corrosion risks. Content < 1 mg/l.
- Water hardness: > 0.5 mmol/l. Values between 1 and 2.5 can be recommended. This will facilitate scale deposit that can limit corrosion of copper. Values that are too high can cause piping blockage over time. A total alkalimetric titre (TAC) below 100 is desirable.
- Dissolved oxygen: Any sudden change in water oxygenation conditions must be avoided. It is as detrimental to deoxygenate the water by mixing it with inert gas as it is to over-oxygenate it by mixing it with pure oxygen. The disturbance of the oxygenation conditions encourages destabilisation of copper hydroxides and enlargement of particles.
- Electric conductivity 10-600  $\mu\text{S}/\text{cm}$
- pH: Ideal case pH neutral at 20-25 °C  
7.5 < pH < 9.

If the water circuit must be emptied for longer than one month, the complete circuit must be placed under nitrogen charge to avoid any risk of corrosion by differential aeration.

**ATTENTION: Filling, completing and draining the water circuit charge must be done by qualified personnel, using the air purges and materials that are suitable for the products.**

**Charging and removing heat exchange fluids should be done with devices that must be included on the water circuit by the installer. Never use the unit heat exchangers to add heat exchange fluid.**



## 7.2 - Victaulic water connections

### Inlet/outlet diameters without hydronic module

30XA		252	302	352	402	452	504	502	602	702	752	802	854	852	904
<b>Standard</b>															
Nominal diameter	in	5	5	5	5	5	5	5	5	6	6	6	6	6	6
Actual outside diameter	mm	141.3	141.3	141.3	141.3	141.3	141.3	141.3	141.3	168.3	168.3	168.3	168.3	168.3	168.3
<b>Options 5, 6 and 100A</b>															
Nominal diameter	in	4	4	4	4	4	-	4	5	5	5	5	-	5	-
Actual outside diameter	mm	114.3	114.3	114.3	114.3	114.3	-	114.3	141.3	141.3	141.3	141.3	-	141.3	-
<b>Option 100C*</b>															
Nominal diameter	in	5	5	5	5	5	5	5	6	6	6	6	6	6	6
Actual outside diameter	mm	141.3	141.3	141.3	141.3	141.3	141.3	141.3	168.3	168.3	168.3	168.3	168.3	168.3	168.3

30XA		902	1002	1112	1212	1312	1382	1402	1502	1702
<b>Standard</b>										
Nominal diameter	in	6	8	6	6	6	6	8/6	8/6	6
Actual outside diameter	mm	168	219	168	168	168	168	219.1/168.3	219.1/168.3	168.3
<b>Options 5, 6 and 100A</b>										
Nominal diameter	in	5	6	6	6	6	6	8/5	8/5	6/6
Actual outside diameter	mm	141	168.3	168.3	168.3	168.3	168.3	219.1/141.3	219.1/141.3	168.3/168.3
<b>Option 100C*</b>										
Nominal diameter	in	6	8	-	-	-	-	-	-	-
Actual outside diameter	mm	168.3	219.1	-	-	-	-	-	-	-

\* Option 100C is not available for sizes 1112 to 1702

### Typical water circuit diagram

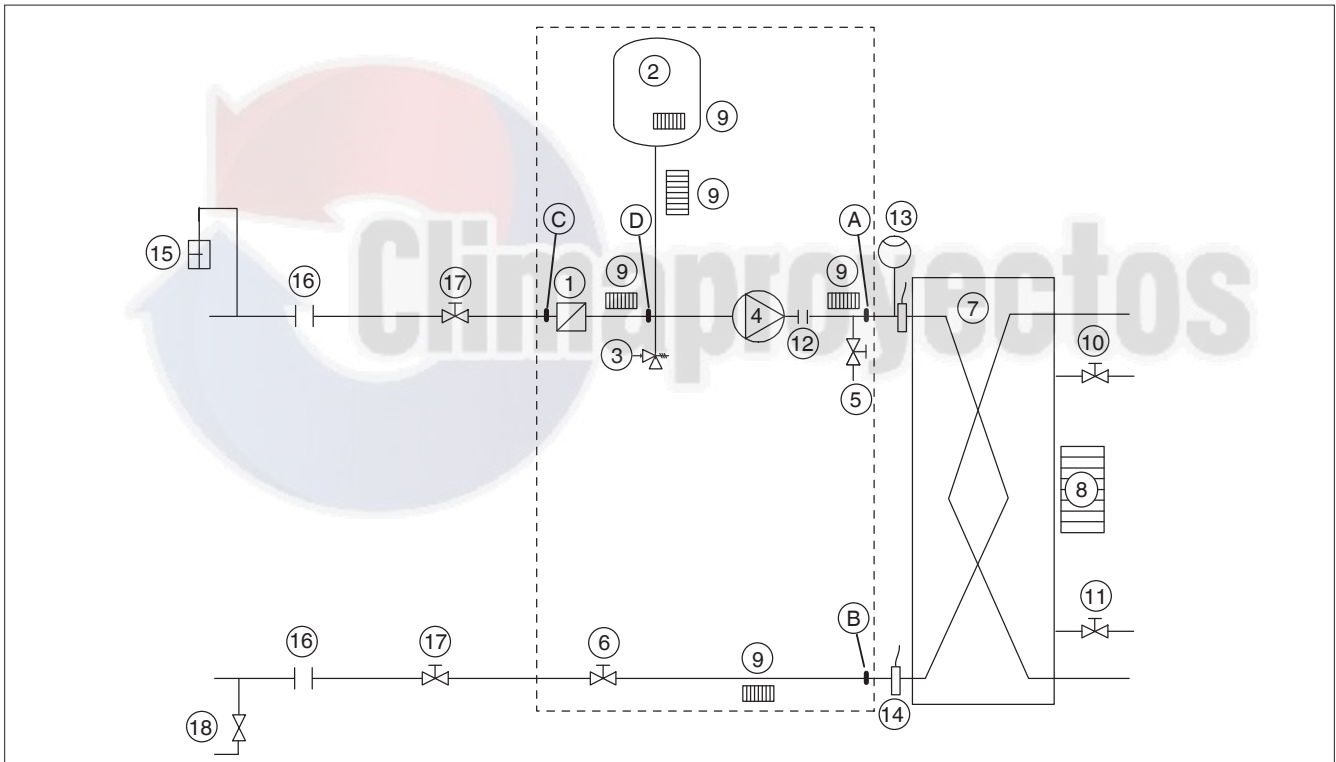

#### Legend

##### Components of the unit and hydronic module

- A Pressure sensor (A-B =  $\Delta P$  evaporator)
- B Pressure sensor
- C Pressure sensor (C-D =  $\Delta P$  water filter)
- D Pressure sensor
- 1 Victaulic screen filter
- 2 Expansion tank
- 3 Relief valve
- 4 Available pressure pump
- 5 Drain valve
- 6 Flow control valve
- 7 Evaporator
- 8 Evaporator defrost heater (option)
- 9 Hydronic module defrost heater (option)
- 10 Air vent (evaporator)
- 11 Water drain (evaporator)
- 12 Expansion compensator (flexible connections)
- 13 Flow switch
- 14 Water temperature sensor

##### Installation components

- 15 Air vent
- 16 Flexible connection
- 17 Shut-off valve
- 18 Charge valve
- Hydronic module (supplied as an option)

## 7.3 - Flow control

### Evaporator flow switch and chilled water pump interlock

**IMPORTANT:** On 30XA units, the unit water flow switch must be energised. Failure to follow this instruction will void the Carrier guarantee.

The water flow switch is installed on the evaporator water inlet and adjusted by the control, based on unit size and application. If adjustment is necessary, it must be carried out by qualified personnel trained by Carrier Service.

### 7.4 - Evaporator water box bolt tightening

The evaporator (and condenser) are of the shell and tube type with removable water boxes to facilitate cleaning. Re-tightening or tightening must be done in accordance with the illustration below.

#### Water box tightening sequence

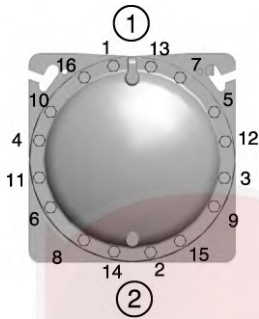

#### Legend:

- |   |                            |   |                              |
|---|----------------------------|---|------------------------------|
| 1 | Sequence 1: 1, 2, 3, 4     | 2 | Tightening torque            |
|   | Sequence 2: 5, 6, 7, 8     |   | Bolt size M16 - 171 - 210 Nm |
|   | Sequence 3: 9, 10, 11, 12  |   |                              |
|   | Sequence 4: 13, 14, 15, 16 |   |                              |

**NOTE:** Before this operation we recommend draining the circuit and disconnecting the pipes to be sure that the bolts are correctly and uniformly tightened.

### 7.5 - Frost protection

#### 7.5.1 - Standard machine

If the chiller or the water piping is in an area where the ambient temperature can fall below 0 °C it is recommended to add an antifreeze solution to protect the unit and the water piping to a temperature of 10 K below the lowest temperature likely to be reached at the installation site. Use only antifreeze solutions, approved for heat exchanger duty. If the system is not protected by an antifreeze solution and will not be used during the freezing weather conditions, draining of the cooler and outdoor piping is mandatory. Damage due to freezing is not covered by the warranty.

**IMPORTANT:** Depending on the climatic conditions in your area you must:

- Add ethylene glycol with an adequate concentration to protect the installation up to a temperature of 10 K below the lowest temperature likely to occur at the installation site.
- If the unit is not used for an extended period, it is recommended to drain it, and as a safety precaution add ethylene glycol to the heat exchanger, using the water entering purge valve connection (a purge connection is available somewhere on the heat exchanger water box in case the machine is not perfectly level).
- At the start of the next season, refill the unit with water and add an inhibitor.
- For the installation of auxiliary equipment, the installer must comply with basic regulations, especially for minimum and maximum flow rates, which must be between the values listed in the operating limit table (application data).

#### 7.5.2 - Optional evaporator frost protection (30XA)

In cases where it is not possible to apply the recommendations in paragraph 7.5.1, the units can be equipped with heaters to protect the evaporator against frost (option 41A or 41B).

### 7.6 - Operation of two units in master/slave mode (option 58)

**NOTE:** This operating mode is not available for 30XA 1702 units.

The control of a master/slave assembly is in the entering water and does not require any additional sensors (standard configuration). It can also be located in the leaving water. In this case two additional sensors must be added on the common piping.

All parameters, required for the master/slave function must be configured using the Service Configuration menu. All remote controls of the master/slave assembly (start/stop, set point, load shedding etc.) are controlled by the unit configured as master and must only be applied to the master unit.

Each unit controls its own water pump. If there is only one common pump, in cases with variable flow, isolation valves must be installed on each unit. They will be activated at the opening and closing by the control of each heat pump (in this case the valves are controlled using the dedicated water pump outputs). Refer to the 30XA/30XAS/30XW Touch Pilot control manual for a more detailed explanation.

## 30XA with configuration: Leaving water control

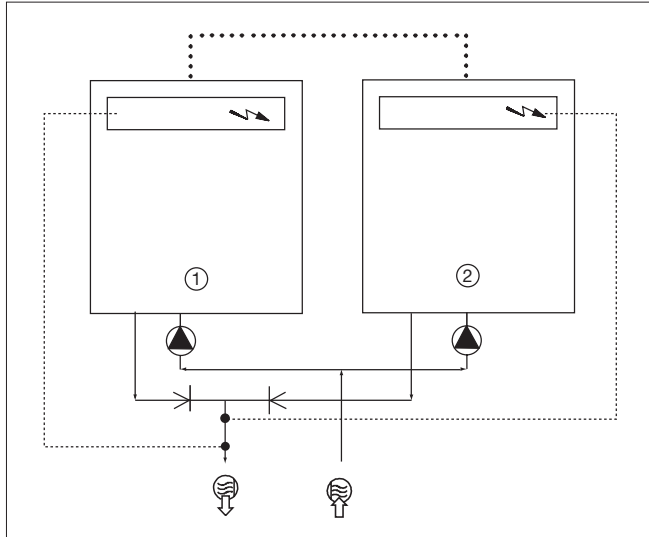

### Legend

- ① Master unit
- ② Slave unit
- ⚡ Control boxes of the master and slave units
- ↻ Water inlet
- ↻ Water outlet
- ⚙ Water pumps for each unit (included as standard for units with hydronic module)
- Additional sensors for leaving water control, to be connected to channel 1 of the slave boards of each master and slave unit
- ⋯ CCN communication bus
- Connection of two additional sensors

## 7.7 - Pump characteristics

### 7.7.1 - Available external static pressure (hydronic module option)

Data applicable for:

- Fresh water 20 °C
- In case of use of the glycol, the maximum water flow is reduced.
- When the glycol is used, it's limited to 40%.

#### Low-pressure pumps (options 116F/116G)

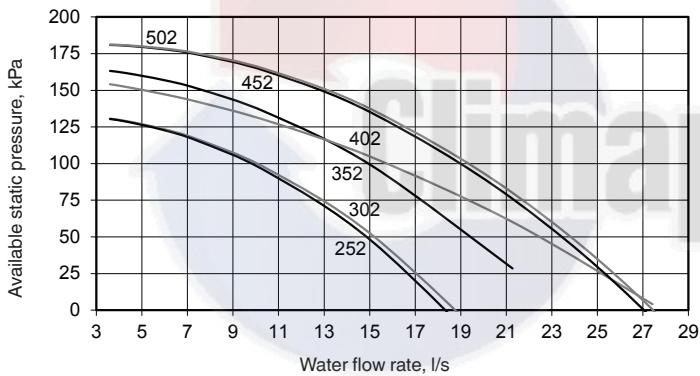

#### High-pressure pumps (options 116B/116C)

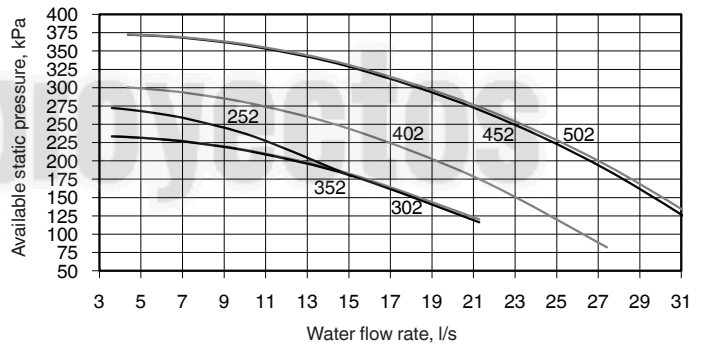

### 7.7.2 - Net positive suction head (NPSH) required, hydronic module option

Size the hydronic circuit to ensure a net positive suction head that is higher than or equal to the required NPSH + 50 kPa.

Data applicable for:

- Fresh water 20 °C
- In case of use of the glycol, the maximum water flow is reduced.
- When the glycol is used, it's limited to 40%.

#### Low-pressure pumps (options 116F/116G)

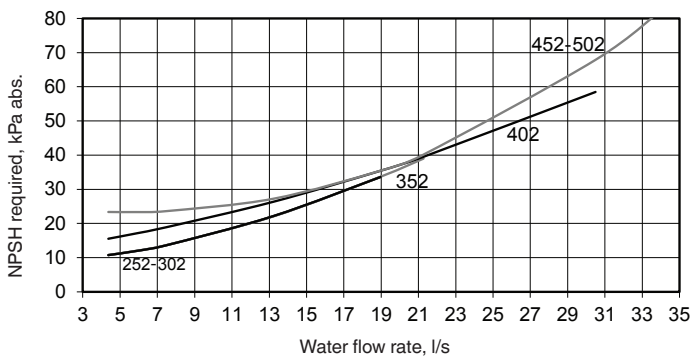

#### High-pressure pumps (options 116B/116C)

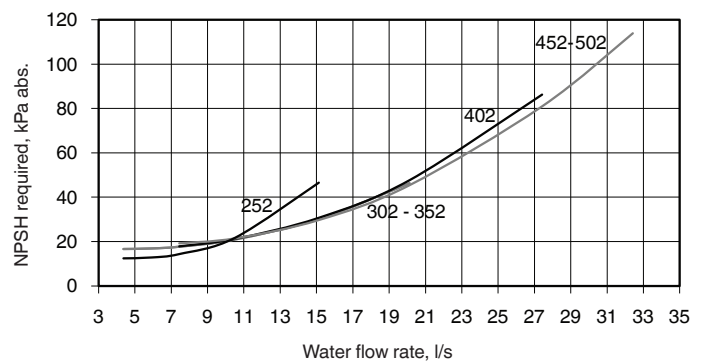

## 8 - FREE-COOLING OPTION (OPTION 118A)

### 8.1 - Physical data, 30XA units with free-cooling option (option 118A)

30XA with Option 118A	252	302	352	402	452	502	602	702	752	802	852	902	1002
<b>Operating weight with option 279 or 257</b>	kg	3740	3780	3820	4673	4743	5174	6097	6247	6547	6847	7308	8226
<b>Refrigerant charge</b>	kg												
Circuit A		37	35	35	51.5	53.5	60.5	60	60	67	71	74	78
Circuit B		38.5	37.5	37.5	36.5	37	36	61	64	60	67	65	82
<b>Refrigerant charge, option 254</b>	kg												
Circuit A		60	64	*	87	87	104	104	102	*	*	133	143
Circuit B		64	64	*	56	56	56	90	97	*	*	97	132

\* Option 118A (free cooling) is not compatible with these unit sizes.

### 8.2 - Operating limits

Cooling mode		
Evaporator		Minimum Maximum
Entering water temperature at start-up	°C	- 45
Entering water temperature during operation	°C	6.8 21
Leaving water temperature during operation		3.3 15
Condenser (air)		
Outdoor ambient operating temperature	°C	-10 55*
With winter operation option (option 28)	°C	-20 55*
Free-cooling mode		
Evaporator		Minimum Maximum
Entering water temperature at start-up	°C	- 45
Leaving water temperature during operation		3.3 26*
Condenser (air)		
Outdoor ambient operating temperature	°C	-10 20
With winter operation option (option 28)	°C	-20 20

\* Maximum configurable set-point

### 8.3 - Operation

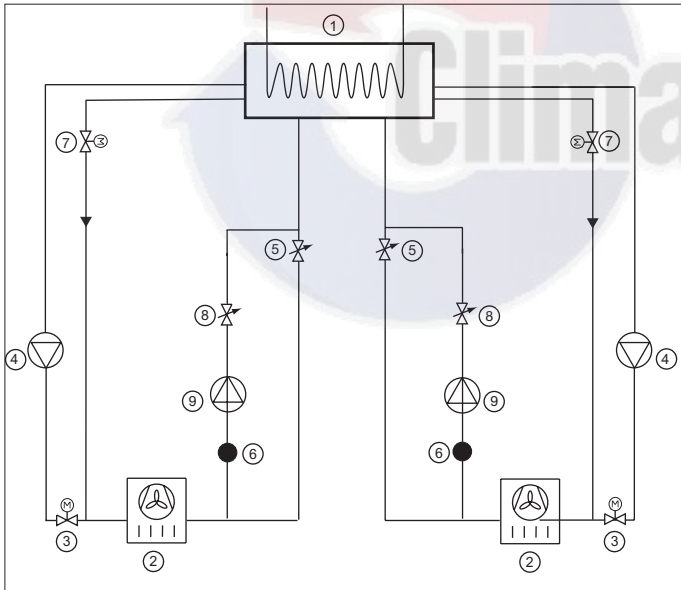

#### Legend

- 1 Evaporator
- 2 Air condenser (coils)
- 3 Motorised two-way valve, discharge side
- 4 Compressor and oil separator
- 5 Principal electronic expansion valve (EXV)
- 6 Pressure and temperature measurement to calculate the sub-cooling upstream of the pump
- 7 Motorised two-way bypass valve
- 8 Free-cooling expansion device (EXV)
- 9 Refrigerant pump

The change-over between the cooling and free-cooling modes is automatically controlled (it is possible to block the change-over to free-cooling by reconfiguring the machine - see Controls IOM). The configurable parameters permitting change-over are the outside air temperature and the leaving water temperature set-point. As soon as the temperature difference  $LWT_{stp} - OAT$  is above 8 K the current capacity in cooling mode is calculated and compared with the theoretical free-cooling capacity. This comparison authorizes/stops the change-over to free-cooling.

After change-over to free-cooling all compressors are stopped, the two (or four) two-way valves change to the free-cooling position (the compressor functions are bypassed). As soon as the valves open, the free-cooling pump is started. This change-over logic takes around 4 minutes. Taking this timing into consideration two cooling - free-cooling change-overs are authorized per hour.

If the capacity supplied in the free-cooling mode is insufficient (set-point not reached), the unit automatically changes over to cooling mode.

To optimize operation in free-cooling mode we strongly recommend to use the set-point offset function. This favours the change-over to free-cooling and increases the capacity in free-cooling mode.

## 9 - HEAT RECLAIM CONDENSER OPTION (OPTION 50)

### 9.1 - Physical data, 30XA units with heat reclaim condenser option

30XA heat reclaim mode		252	302	352	402	452	502	602	702	752	802	852	902	1002
Operating weight*	kg	3920	3960	3970	4930	5050	5550	6670	6730	7130	7350	7890	8340	8950
Condenser diameter	in	10	10	10	12	14	14	12+12	12+12	14+12	14+12	14+12	14+14	14+14
<b>Refrigerant charge</b>		Flooded multi-pipe condenser												
Circuit A	kg	37	35	35	51	52	59	58	58	65	69	72	69	91
Circuit B	kg	39	37	37	37	37	36	59	62	58	65	63	76	89
<b>Heat reclaim condenser</b>		Flooded multi-pipe condenser												
Water volume	l	38	38	38	55	68	68	55 + 55	55 + 55	68 + 55	68+55	68+55	68 + 68	68 + 68
Water connections		Victaulic												
Nominal diameter	in	3	3	3	4	4	4	4	4	4	4	4	4	4
Actual outside diameter	mm	88.9	88.9	88.9	114.3	114.3	114.3	114.3	114.3	114.3	114.3	114.3	114.3	114.3

\* Weights are for guidance only.

### 9.2 - Dimensions, clearances

#### 9.2.1 - 30XA 252-352 - heat reclaim option

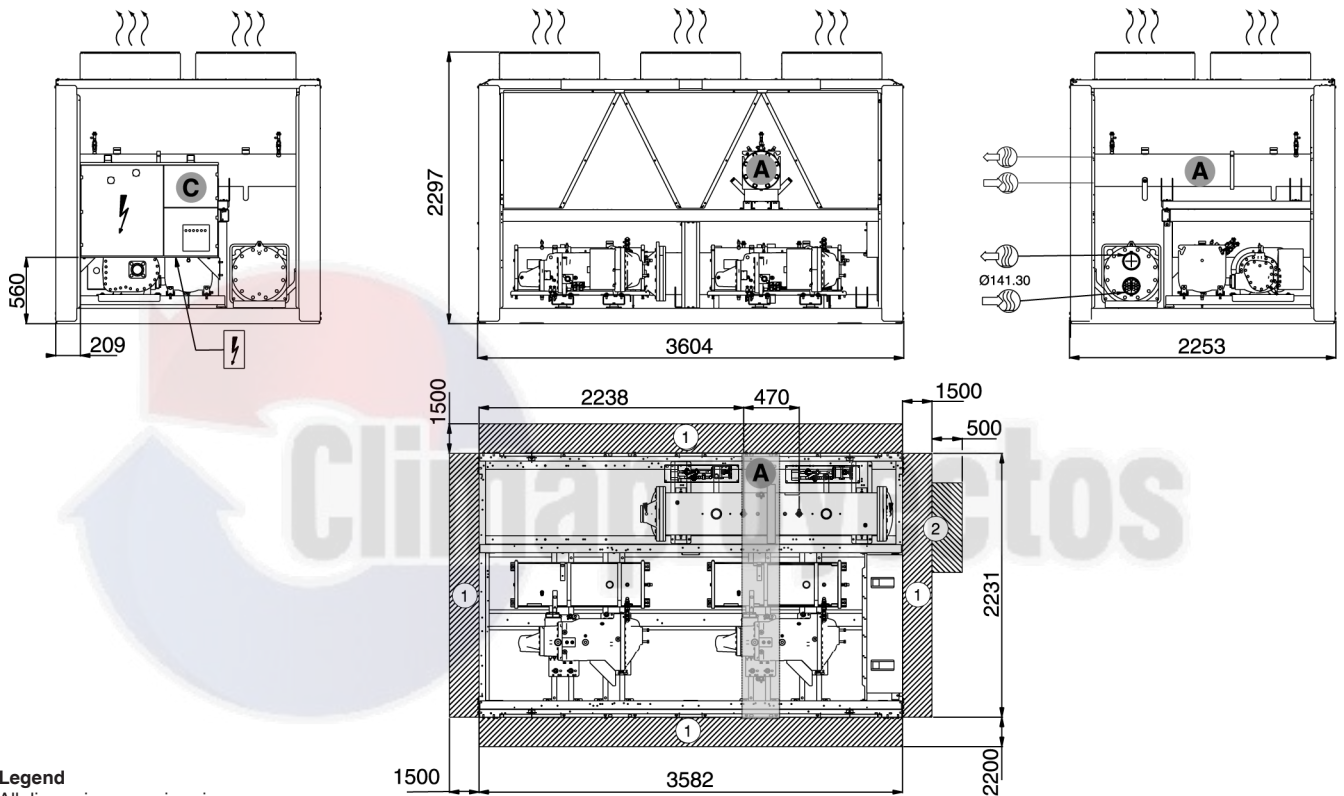

**Legend**  
All dimensions are given in mm.

- ① Required clearances for maintenance (see note)
- ② Recommended space for evaporator tube removal
- Water inlet for standard unit  
For options 5, 6, 100A, 100C, 107 refer to the certified drawing.
- Water outlet for standard unit  
For options 5, 6, 100A, 100C, 107 refer to the certified drawing.
- Air outlet – do not obstruct
- Power supply and control connection
- ⓐ Control circuit connection for option 158
- Ⓐ Heat reclaim condenser

**ATTENTION:** The condenser connection sleeves are not installed, but supplied with the unit. The sealing joints are in the control box. The temperature sensors and the condenser flow switch are wired and fixed in the machine. They must be installed as described in the chapter “Condenser water connections”.

#### NOTES:

- Drawings are not contractually binding.
- Before designing an installation, consult the certified dimensional drawings, available on request.
- For the positioning of the fixing points, weight distribution and centre of gravity coordinates please refer to the dimensional drawings.
- If the installation includes several units or if this (these) is (are) close to walls, please refer to chapters 3.11 - “Multiple chiller installation” and 3.12 - “Distance to the wall” of this document to determine the space required.

### 9.2.2 - 30XA 402-452 - heat reclaim option

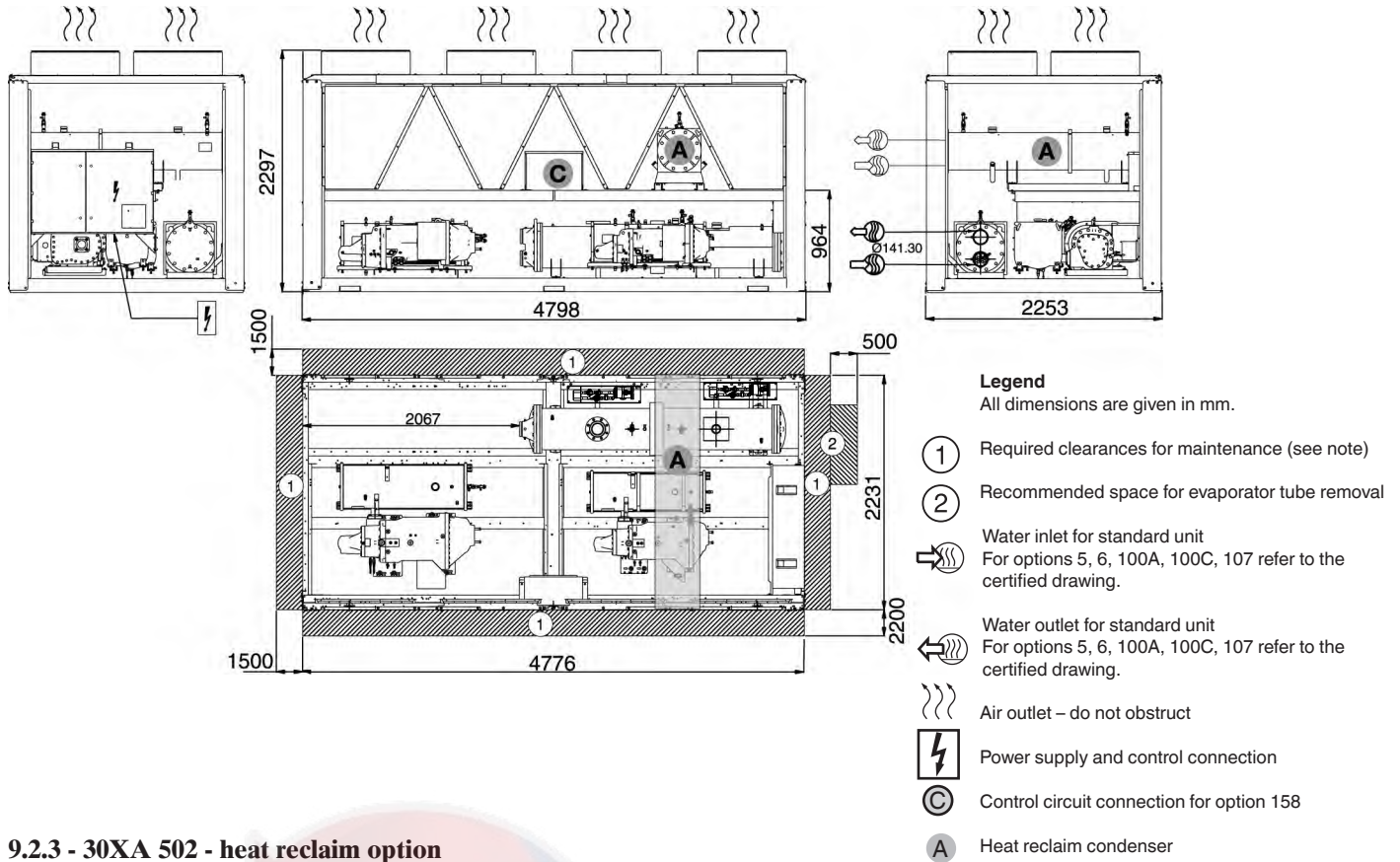

### 9.2.3 - 30XA 502 - heat reclaim option

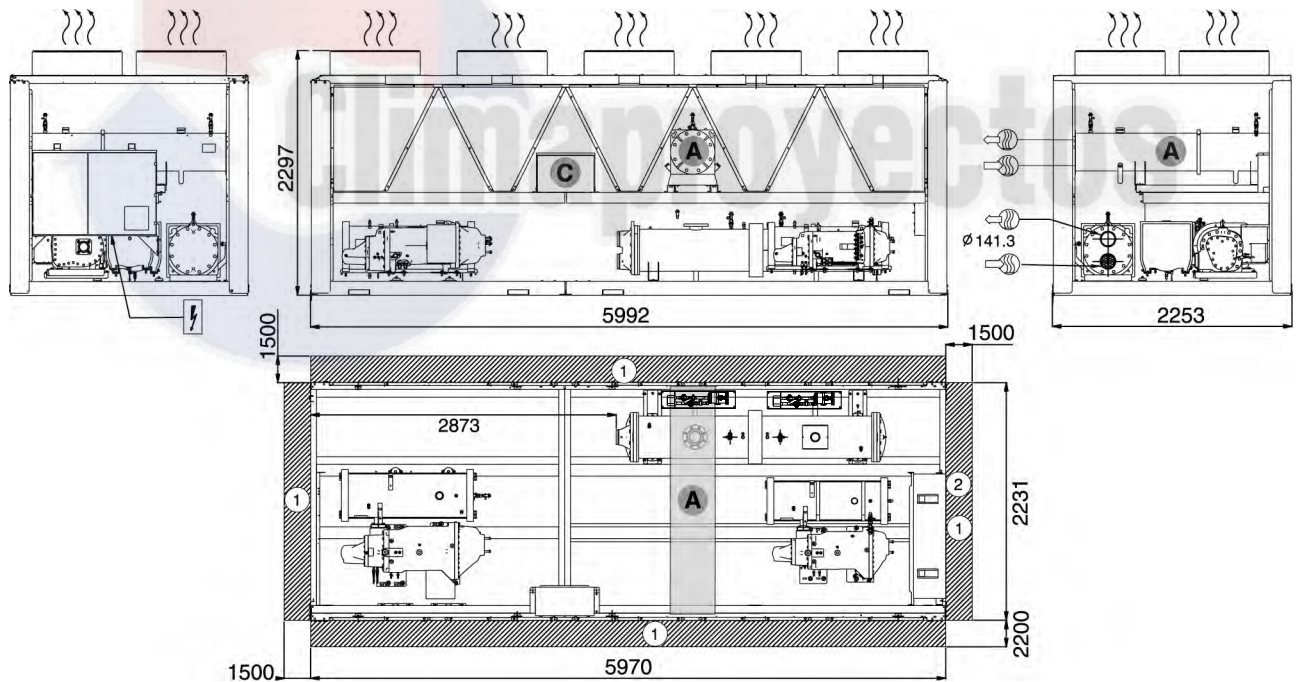

**ATTENTION:** The condenser connection sleeves are not installed, but supplied with the unit. The sealing joints are in the control box. The temperature sensors and the condenser flow switch are wired and fixed in the machine. They must be installed as described in the chapter “Condenser water connections”.

#### NOTES:

- Drawings are not contractually binding.
- Before designing an installation, consult the certified dimensional drawings, available on request.
- For the positioning of the fixing points, weight distribution and centre of gravity coordinates please refer to the dimensional drawings.
- If the installation includes several units or if this (these) is (are) close to walls, please refer to chapters 3.11 - “Multiple chiller installation” and 3.12 - “Distance to the wall” of this document to determine the space required.

### 9.2.4 - 30XA 602-802 - heat reclaim option

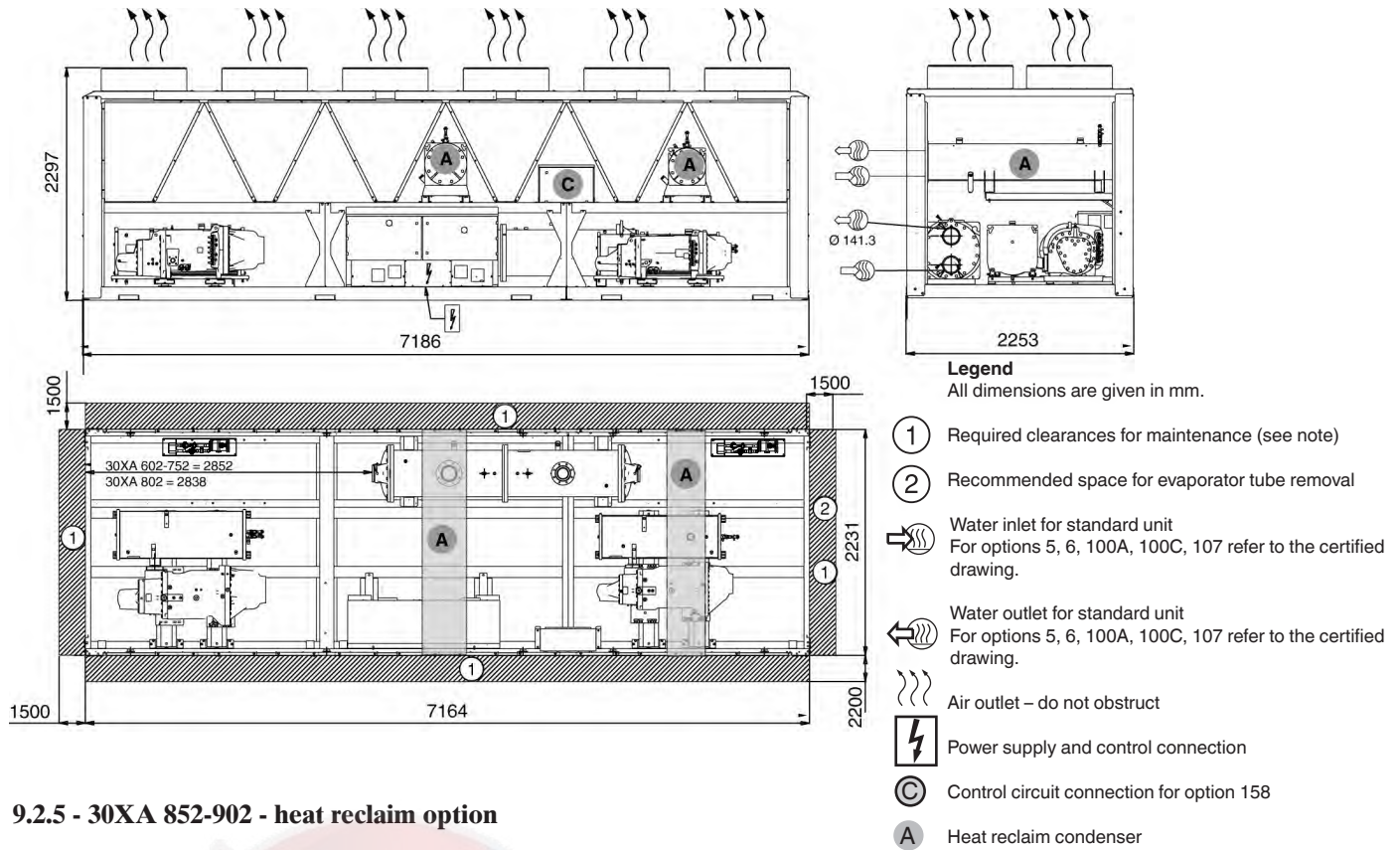

### 9.2.5 - 30XA 852-902 - heat reclaim option

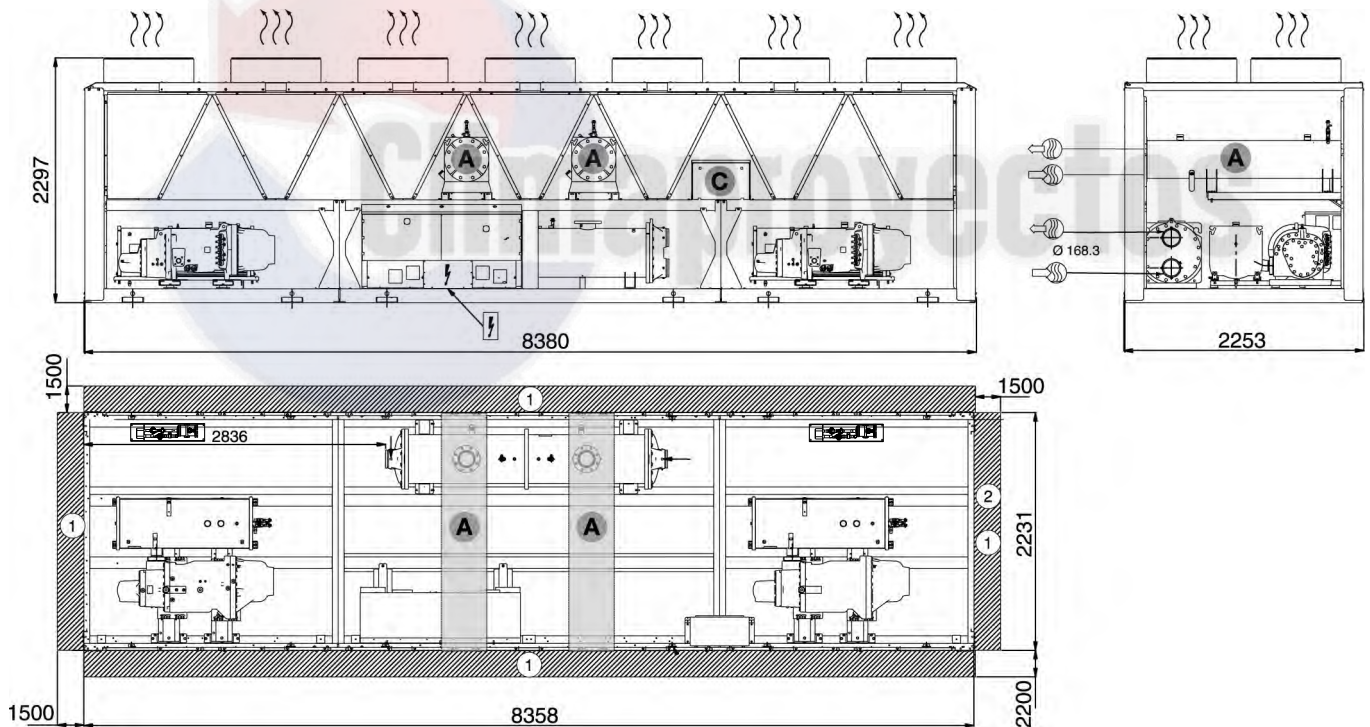

**ATTENTION:** The condenser connection sleeves are not installed, but supplied with the unit. The sealing joints are in the control box. The temperature sensors and the condenser flow switch are wired and fixed in the machine. They must be installed as described in the chapter “Condenser water connections”.

**NOTES:**



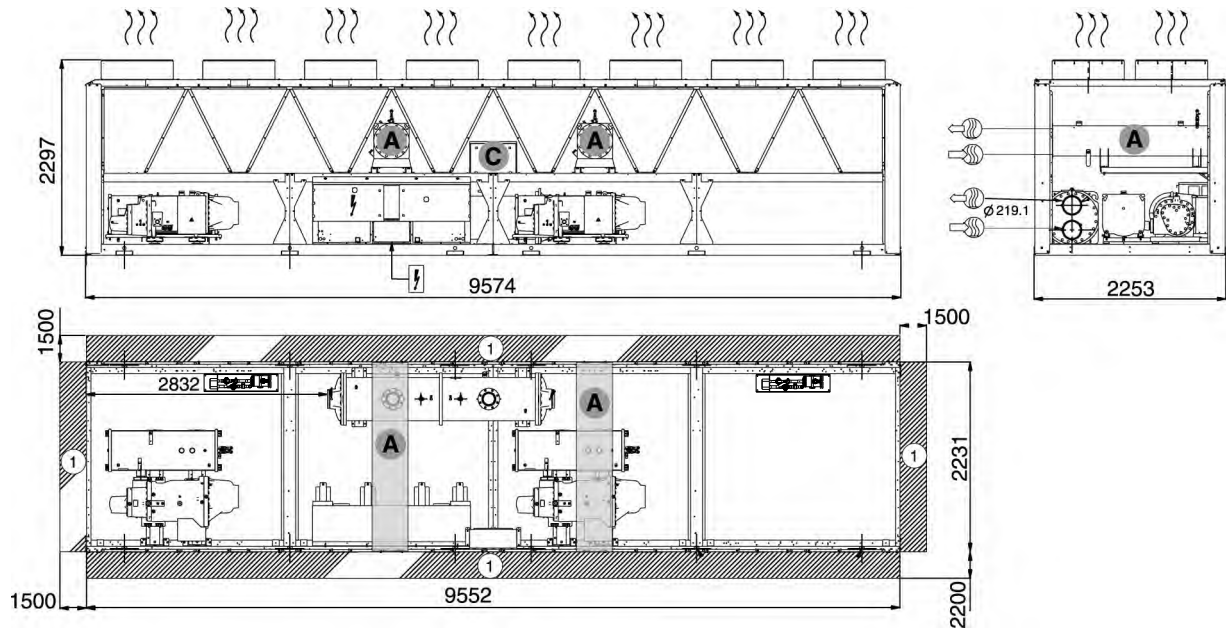

- Drawings are not contractually binding.
- Before designing an installation, consult the certified dimensional drawings, available on request.
- For the positioning of the fixing points, weight distribution and centre of gravity coordinates please refer to the dimensional drawings.
- If the installation includes several units or if this (these) is (are) close to walls, please refer to chapters 3.11 - “Multiple chiller installation” and 3.12 - “Distance to the wall” of this document to determine the space required.

## 9.2.6 - 30XA 1002 - heat reclaim option



### Legend

All dimensions are given in mm.

- ① Required clearances for maintenance (see note)
- ② Recommended space for evaporator tube removal
-  Water inlet for standard unit  
For options 5, 6, 100A, 100C, 107 refer to the certified drawing.
-  Water outlet for standard unit  
For options 5, 6, 100A, 100C, 107 refer to the certified drawing.
-  Air outlet – do not obstruct
-  Power supply and control connection
- Ⓢ Control circuit connection for option 158
- Ⓐ Heat reclaim condenser

**ATTENTION:** The condenser connection sleeves are not installed, but supplied with the unit. The sealing joints are in the control box. The temperature sensors and the condenser flow switch are wired and fixed in the machine. They must be installed as described in the chapter “Condenser water connections”.

### NOTES:

- Drawings are not contractually binding.
- Before designing an installation, consult the certified dimensional drawings, available on request.
- For the positioning of the fixing points, weight distribution and centre of gravity coordinates please refer to the dimensional drawings.
- If the installation includes several units or if this (these) is (are) close to walls, please refer to chapters 3.11 - “Multiple chiller installation” and 3.12 - “Distance to the wall” of this document to determine the space required.



### 9.3 - Condenser location

All heat reclaim condensers are located between the air-cooled condensers on the upper part of the chassis, support-ed by two cross rails. The water inlet and outlet are on the same side.

### 9.4 - Condenser water connections

#### 9.4.1 - Unit with one heat reclaim condenser (30XA 252-502)

The water flow switch must be installed at the water inlet of the installation that arrives at the heat reclaim condenser.

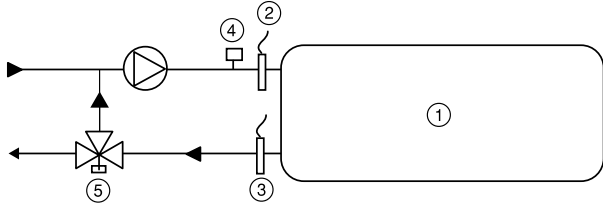

#### Legend

- 1 Heat reclaim condenser
- 2 Entering water temperature sensor (supplied)
- 3 Leaving water temperature sensor (supplied)
- 4 Condenser water flow switch (supplied)
- 5 Three-way valve (not supplied)

#### 9.4.2 - Unit with two heat reclaim condensers (30XA 602-1002)

The two condensers must be installed in parallel in the water system of the installation. The water flow switch and the entering/leaving water temperature sensors must be installed in the line that is common to both heat reclaim circuits and as close as possible to the condensers. A T-piece must be provided by the installer at the water inlet and outlet of the condensers.

For units with two condensers the maximum cable length of the temperature sensors and the flow switch (7.5 m) is designed to allow connection to the common inlet or outlet in a radius of 4.5 m after routing along the width of the unit.

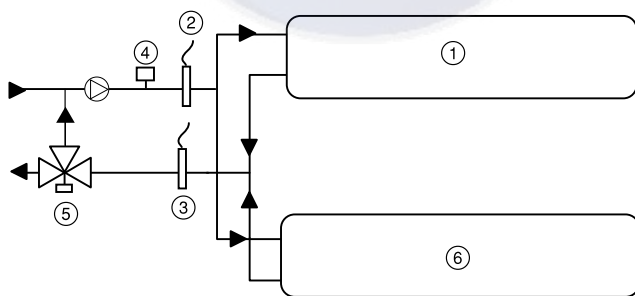

#### Legend

Please refer to the legend in chapter 9.4.1 opposite, noting that items 2, 3 and 4 - flow switch and sensors - are placed on the common sections.

#### 9.4.3 - Three-way valves

It is strongly recommended to install a three-way valve in the system (not supplied with the unit). A 0-10 V output is available on the unit electronic board to control this valve. The valve allows bypassing of the heat reclaim condenser entering/leaving circuit to ensure unit operation with heat reclaim at low entering water temperature (< 12.5 °C). It also ensures an optimal and controlled leaving water temperature.

### 9.5 - Operating limits for stable operation (no mode changeover)

#### 9.5.1 - Cooling only mode

Please refer to the earlier chapters in this manual:

6.1 - Unit operating range

6.7 - Evaporator water flow rate

#### 9.5.2 - Heat reclaim mode

Condenser water temperature			
	°C	Minimum	Maximum
Water entering temperature at start-up	12.5*		55
Water entering temperature during operation	20		55
Water leaving temperature during operation	25		60
Evaporator water temperature			
	°C	Minimum	Maximum
Water entering temperature at start-up	-		45
Water entering temperature during operation	6.8		21
Water leaving temperature during operation	3.3		15

\* The water entering temperature at start-up must not be lower than 12.5 °C. For installations with a lower temperature a three-way valve must be used.

**NOTE:** If the temperature at the evaporator is below 4 °C, a glycol/water solution or the frost protection option must be used.

In part-load operation, the limitation of the condenser leaving water temperature is due to the operating range of the screw compressor. If the condenser leaving water temperature is above the limit value given in the curves below, the unit will automatically change over to the mode without heat recovery:

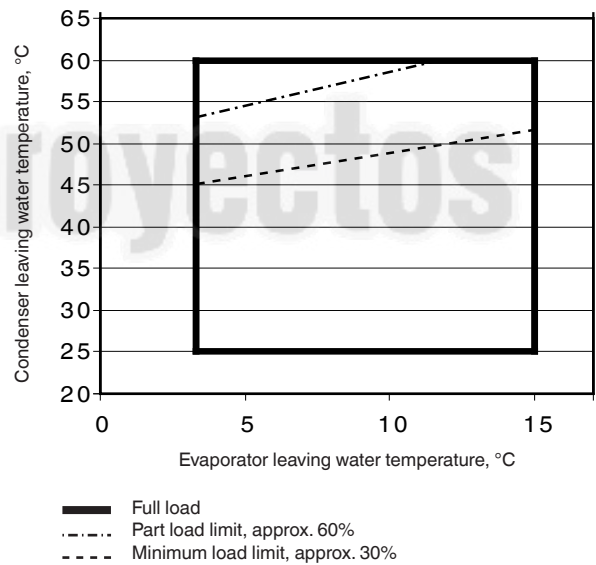

#### Part load operating limits (evaporator leaving water temperature = 7 °C)

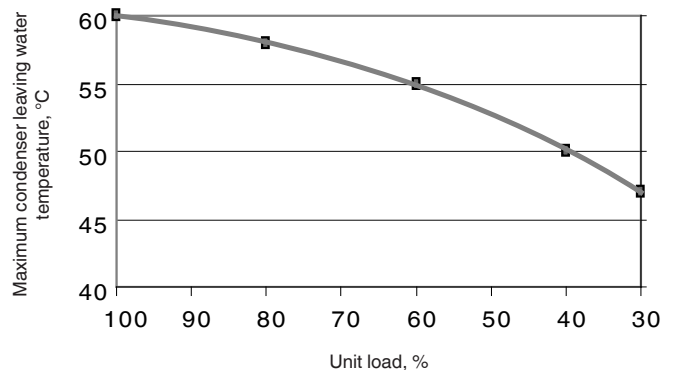

## 9.6 - Operating limits for changeover between modes

From cooling only to heat reclaim and vice versa.

Heat reclaim condenser water temperature		
	°C	
Water entering temperature	12.5	Maximum
Ambient operating temperature	-10*	45

\* -20 °C with winter operation option (option 28)

## 9.7 - Flow control

The water flow switch supplied needs to be installed at the heat reclaim condenser water inlet and protects the condenser loop against low water flow conditions. When the heat reclaim mode is required, a signal from the additional board output activates the system pump. Once the pump is started, flow detection takes place for one minute. If no flow is detected by the end of this time:

1. Changeover to the heat reclaim mode is not permitted
2. Mode is changed to cooling only mode when the water flow rate is low, accompanied by a water flow detection alarm.

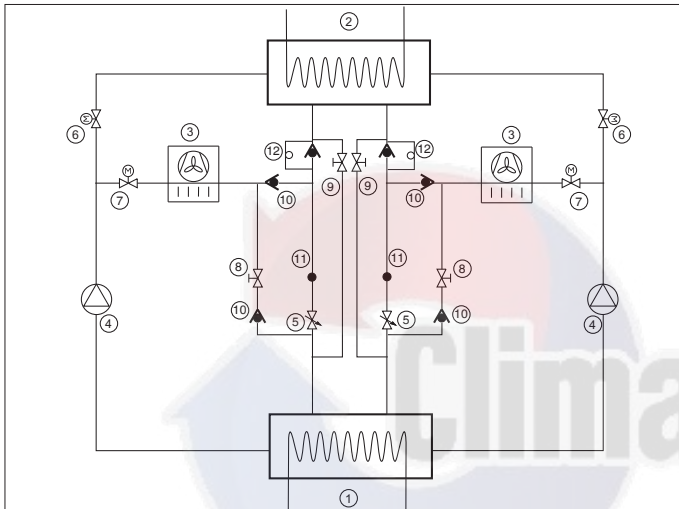

### Legend

- 1 Evaporator
- 2 Heat reclaim condenser
- 3 Air condenser (coils)
- 4 Compressor
- 5 Expansion device (EXV)
- 6 Motorised valve - heat reclaim mode
- 7 Motorised valve - cooling only mode
- 8 Solenoid valve - charge recovery in heat reclaim mode
- 9 Solenoid valve - charge recovery in cooling only mode
- 10 Check valve
- 11 Pressure and temperature measurement to calculate the liquid sub-cooling to optimise the charge recovery
- 12 Check valve with capillary

## 9.8 - Heat reclaim operation

The heat reclaim condenser option is only available on units with two circuits. It has been designed with one or two single or two-circuit shell-and-tube heat exchangers, depending on the unit size.

The two circuits are independently controlled. One circuit can be in cooling only and the other in heat reclaim mode.

Changeover from one mode to the other (changeover from heat exchange at the air condenser to heat exchange at the water condenser and vice versa) is ensured by motorised two-way valves located upstream of the air and water condensers.

**ATTENTION: Mode changes may lead to higher sound levels than the levels at stable operation.**

Depending on the mode selected (heat reclaim or cooling), the logic compares the water entering temperature required with the setpoint. Depending on this difference the unit circuits are either activated or deactivated in heat reclaim mode (one or two together), as shown in the following diagram and table.

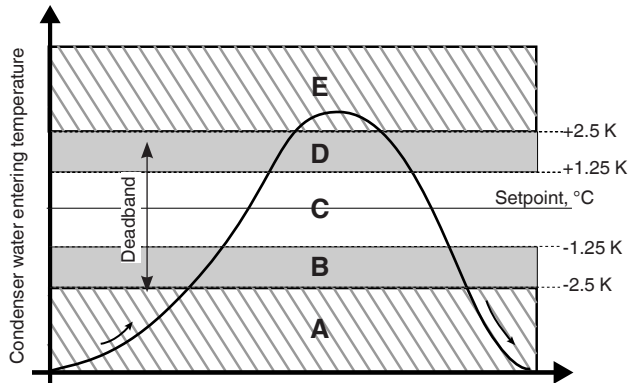

The deadband of 5 K is controlled by default.

Case	Selection of the heat reclaim mode	Number of circuits in heat reclaim mode	Action
-	NO	0	+ 2 circuits in cooling mode
A	YES	Whatever the number	+ 2 circuits in heat reclaim mode
B	YES	0	+ 1 circuit in heat reclaim mode
		1	No change
		2	No change
C	YES	Whatever the number	No change
D	YES	1	No change
		2	- 1 circuit in heat reclaim mode
E	YES	Whatever the number	- 2 circuits in heat reclaim mode

For more details on the heat reclaim operation logic please refer to the 30XA/30XAS/30XW Touch Pilot control manual, chapter 6.15 - "Optional heat reclaim module".

## 9.9 - Condenser pump selection

Heat reclaim condenser water flow rate/pressure drop

### Heat reclaim condenser pressure drop in water flow rate function

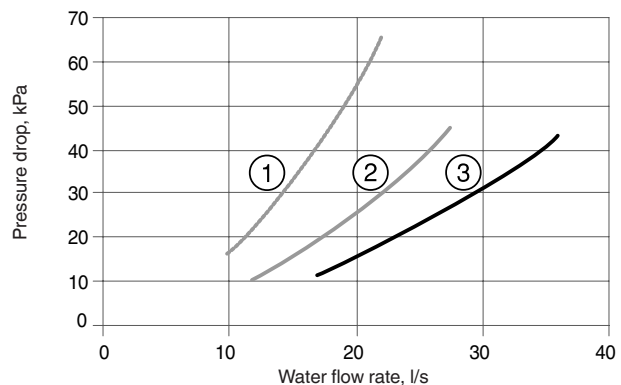

- 1 Condenser 10" (water volume = 38 litres)
- 2 Condenser 12" (water volume = 55 litres)
- 3 Condenser 14" (water volume = 68 litres)

For units with a water condenser please refer to chapter 9.1 - "Technical data, 30XA units with heat reclaim condenser option".

## 9.10 - Frost protection

The heat reclaim condenser is equipped with electric heaters to protect the condenser against frost. These are activated if the condenser entering and leaving water temperatures are below 3 °C and deactivated, if they are higher than 4.4 °C.

## 10 - FANS WITH AVAILABLE PRESSURE (OPTION 10)

If this option has been selected, the fans with available pressure are equipped with discharge connection flanges to facilitate the duct connection.

*NOTE: Each fan must be individually ducted.*

## 11 - MAJOR SYSTEM COMPONENTS AND OPERATION DATA

### 11.1 - Direct-drive twin-screw compressor with variable capacity slide valve

- 30XA units use 06T geared twin-screw compressors equipped with a variable capacity slide valve for continuous control between 30% and 100% of full load.
- Nominal capacities range from 120 to 530 kW. The seven models used in the 30XA range are economised.

#### 11.1.1 - Oil filter

The 06T screw compressor has an independent oil filter attached to the oil separator. This filter is field replaceable.

#### 11.1.2 - Refrigerant

The 30XA a water chiller operating only with refrigerant R-134a.

#### 11.1.3 - Lubricant

The 06T screw compressor is approved for use with the following lubricants:

- Castrol Icematic SW220 (Carrier specification PP47-32)
- Lubrizol Emkarate RL220H (Carrier specification PP47-13).

#### 11.1.4 - Oil supply solenoid valve

An oil supply solenoid valve is installed on the oil return line as standard to isolate the compressor from oil flow when the compressor is not operating. The oil solenoid valve is field replaceable.

#### 11.1.5 - Suction and economizer screens

To increase the reliability of the compressor, a screen has been incorporated as a standard feature into suction and economizer inlets of the compressor.

#### 11.1.6 - Capacity control system

The 06T screw compressor has an unloading system that is standard on all compressors. This unloading system consists of slide valve that permits changing the length of the screw used for the refrigerant compression. This valve is controlled by the action of a piston controlled by two solenoid valves on the oil return line.

## 11.2 - Pressure vessels

### General

Monitoring during operation, re-qualification, re-testing and re-testing dispensation:

- Follow the regulations on monitoring pressurised equipment.
- It is normally required that the user or operator sets up and maintains a monitoring and maintenance file.
- If there are no regulations or to complement them follow the control programmes of EN 378.
- If they exist follow local professional recommendations.
- Regularly inspect the condition of the coating (paint) to detect blistering resulting from corrosion. To do this, check a non-insulated section of the container or the rust formation at the insulation joints.
- Regularly check for possible presence of impurities (e.g. silicon grains) in the heat exchange fluids. These impurities maybe the cause of the wear or corrosion by puncture.
- Filter the heat exchange fluid check and carry out internal inspections as described in EN 378.
- In case of re-testing please refer to the maximum operating pressure given on the unit nameplate.
- The reports of periodical checks by the user or operator must be included in the supervision and maintenance file.

### Repair

Any repair or modification, including the replacement of moving parts:

- Must follow local regulations and be made by qualified operators and in accordance with qualified procedures, including changing the heat exchanger tubes.
- Must be made in accordance with the instructions of the original manufacturer. Repair and modification that necessitate permanent assembly (soldering, welding, expanding etc.) must be made using the correct procedures and by qualified operators.
- An indication of any modification or repair must be shown in the monitoring and maintenance file.

### Recycling

The unit is wholly or partly recyclable. After use it contains refrigerant vapours and oil residue. It is coated by paint.

### Operating life

This unit is designed for:

- Prolonged storage of 15 years under nitrogen charge with a temperature difference of 20 K per day.
- 452000 cycles (start-ups) with a maximum difference of 6 K between two neighbouring points in the vessel, based on 6 start-ups per hour over 15 years at a usage rate of 57%.

### Corrosion allowances:

Gas side: 0 mm

Heat exchange fluid side: 1 mm for tubular plates in lightly alloyed steels, 0 mm for stainless steel plates or plates with copper-nickel or stainless steel protection.

### 11.2.1 - Evaporator

30XA chillers use a flooded multi-tube evaporator. The water circulates in the tubes and the refrigerant is on the outside in the shell. One vessel is used to serve both refrigerant circuits. There is a centre tube sheet which separates the two refrigerant circuits. The tubes are 3/4" diameter copper with an enhanced surface inside and out. There is just one water circuit, and depending on the size of the chiller, there may be one, two or three water passes.

The units have three refrigerant circuits with two evaporators connected in series on the heat transfer fluid.

The evaporator has a thermal insulation of 19 mm thick polyurethane foam, an aluminium sheet (option) and is equipped with a water drain and purge.

The water connection of the heat exchanger is a Victaulic connection. As an option the evaporator is available with frost protection (evaporator frost protection option).

The products that may be added for thermal insulation of the containers during the water piping connection procedure must be chemically neutral in relation to the materials and coatings to which they are applied. This is also the case for the products originally supplied by Carrier.

### 11.2.2 - Oil separator

In these units, the oil separator is a pressure vessel that is mounted under the outside vertical condenser coils. Dis-charge gas at the compressor outlet is directed towards the bottom of the oil separator ring and most of the oil separates from the gas by strong deceleration and by gravity. The gas then flows through a wire mesh screen where the remaining oil is separated by coalescence and flows to the bottom of the ring. The gas is now free from oil and leaves the ring at the top towards the condenser.

The oil separator is equipped with a trace heater regulated by the control.

### 11.2.3 - Economiser function

The economiser function includes a liquid line valve, a filter drier, two EXVs, a plate heat exchanger as well as protection devices (fuse or valve).

At the condenser outlet a part of the liquid is expanded via the secondary EXV in one of the heat exchanger circuits and then returns as gas at the compressor economiser. This expansion permits increase of the liquid sub-cooling of the rest of the flow that penetrates the evaporator via the principal EXV. This permits increasing the cooling capacity of the system as well as its efficiency.

### 11.3 - High-pressure safety switch

30XA units are equipped with high-pressure safety switches.

In accordance with the applicable code the high-pressure switches with manual reset, called PZH (former DBK), may be backed up by high-pressure switches that require resetting with a tool. The high-pressure switches that require resetting with a tool are called PZHH (former SDBK). If a PZHH cuts out, the corresponding PZH in the same com-pressor is faulty and must be replaced. The PZHH must be reset with a blunt tool with a diameter of less than 6 mm. Insert this tool into the opening on the pressure switch and push the reset button in this location.

These pressure switches are located at the discharge of each compressor.

### 11.4 - Condensers

30XA coils are all-aluminium micro-channel condensers. Optional coils with internally grooved copper tubes with aluminium fins are also available (options 254 and 255).

### 11.5 - Fans

The fans are axial Flying Bird fans equipped with rotating shroud and made of composite recyclable material. Each motor is fixed with transverse supports. The motors are three-phase, with permanently lubricated bearings and insulation class F (level IP55).

According to the Regulation No. 327/2011 implementing Directive 2009/125/EC with regard to ecodesign requirements for fans driven by motors with an electric input power between 125 W and 500 kW.

Product		30XA	30XA
Option		Standard	Option 119
Global fan efficiency	%	35.5	39.3
Measurement category		A	A
Efficiency category		static	static
Energy efficiency target N(2015)		N(2015) 40	N(2015) 40
Efficiency level at the optimal energy efficiency point		42.4	43.9
Variable frequency drive		Optional	Optional
Year of manufacture		See label on unit	See label on unit
Fan manufacturer		Simonin	Simonin
Motor manufacturer		Leroy Somer	Leroy Somer
Fan reference		00PSG000000100A	00PSG000000100A
Motor reference		00PPG000478500A	00PPG000478400A
Nominal motor capacity	kW	0.83	1.85
Flow rate	m <sup>3</sup> /s	3.12	4.28
Pressure at optimum energy efficiency	Pa	95	170
Speed	rpm	712	954
Specific ratio		1.002	1.002
Product disassembly, recycling or disposal at end of life		See service manual	See service manual
Information about minimising environmental impact		See service manual	See service manual

According to the Regulation No. 640/2009 and amendment 4/2014 implementing Directive 2005/32/EC with regard to ecodesign requirements for electric motors.

Product	30XA	
Option	Standard	option 119
Motor type	Asynchronous	Asynchronous
Number of poles	8	6
Nominal input frequency	Hz 50	50
Nominal voltage	V 400	400
Number of phases	3	3
Motor included in the application domain of the regulation 640/2009 and amendment 4/2014	No	No
Sales leaflet for exemption	°C Article 2.1	Article 1.2.c).(ii)
Ambient air temperature for which the motor is specifically designed	70	70

### 11.6 - Electronic expansion valve (EXV)

The EXV is equipped with a stepper motor (2785 to 3690 steps, depending on the model) that is controlled via the EXV board. The EXV is also equipped with a sightglass that permits verification of the mechanism movement and the presence of the liquid gasket.

### 11.7 - Moisture indicator

Located on the EXV, permits control of the unit charge and indicates moisture in the circuit. The presence of bubbles in the sight-glass indicates an insufficient charge or non-condensables in the system. The presence of moisture changes the colour of the indicator paper in the sight-glass.

### 11.8 - Filter drier

The role of the filter drier is to keep the circuit clean and moisture-free. The moisture indicator shows, when it is necessary to change the element. A difference in temperature between the filter inlet and outlet shows that the element is dirty.

### 11.9 - Sensors

The units use thermistors to measure the temperature, and pressure transducers to control and regulate system operation. Refer to the 30XA/30XAS/30XW Touch Pilot control manual for a more detailed explanation.

### 11.10 - Service valve (option 92)

The unit can be equipped with optional service valves to facilitate maintenance and repair operations.

If option 92 is ordered, each refrigerant circuit will be supplied with shut-off valves on the compressor economiser, discharge and suction lines.

**ATTENTION: The compressor suction valve must be used without pressure difference at the terminals. If there is a pressure difference, leak-tightness at the valve may be lost and the valve can even fail altogether.**

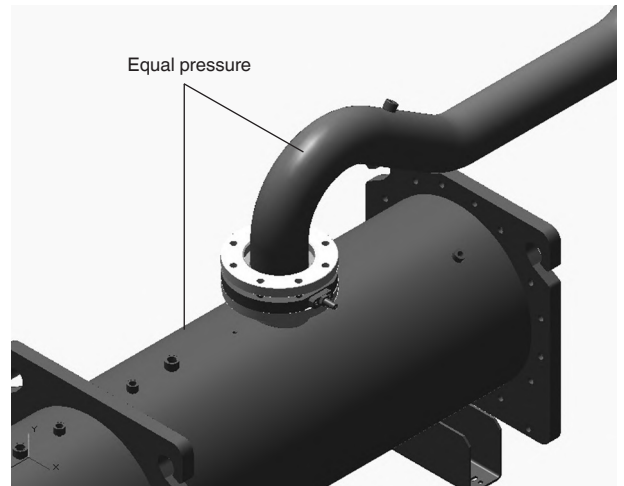

### 11.11 - Power factor correction capacitors (option 231)

They guarantee a minimum power factor performance of 0.95 when unit operates at a condition that involves a power input that exceeds the Eurovent standard condition.

A fix capacitor bank is switched at start of each compressor. It provides individual power factor correction for each machine refrigerant circuit.

Capacitors are dry type : no risque of leakage or fire.

The capacitors are selected for each compressor as per below table:

Compressor	Capacitor (kVAR)
06TSA155	15
06TSA186	20
06TTA266	35
06TTA301	35
06TTA356	35
06TUA483	45
06TUA554	45

**Caution: Operation of the unit without capacitors results in current raising**

## 30XA fan arrangement

30XA 252-352

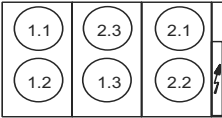

30XA 352 (options 254/255)

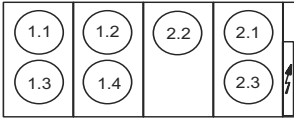

30XA 402-452-504

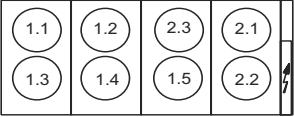

30XA 502

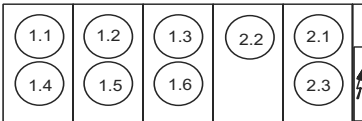

30XA 602

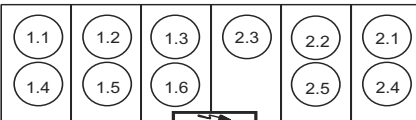

30XA 702-904

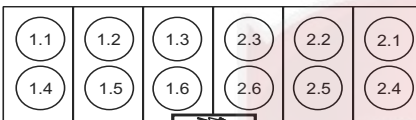

30XA 752 - 802-854

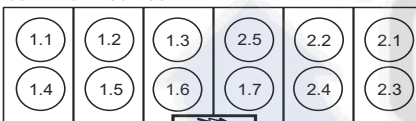

30XA 752-802 (options 254/255)

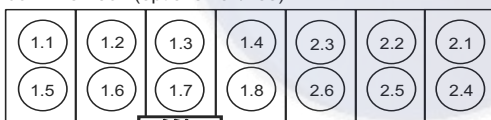

30XA 902

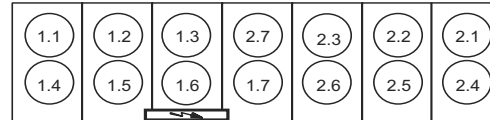

30XA 902 (options 254/255)

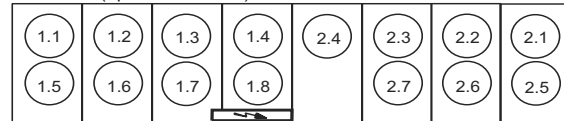

30XA 1002



30XA 1112

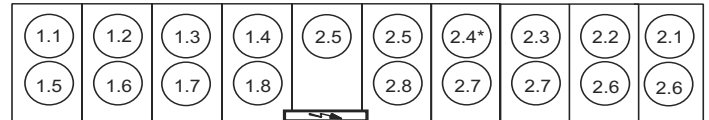

30XA 1212

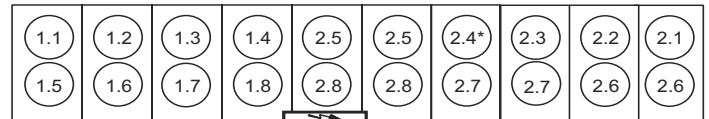

30XA 1312-1382

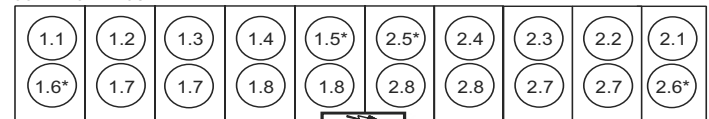

x = Circuit number  
y = Start-up order

**NOTE:** The values above do not correspond to the fan designation. The fan designation and position are given on the unit drawings and wiring diagrams supplied with the unit.

\* These fans are also used to reduce the ventilation steps during change-over of dual stages: They may stop and then restart depending on the stage ordered.

## 12 - MAIN OPTIONS

Options	No.	Description	Advantages	Use for 30XA range
Corrosion protection, traditional coils	2B	Factory application of Blygold Polual treatment on the copper/aluminium coils	Improved corrosion resistance, recommended for industrial, rural and marine environments	252-1702 (Not available for the sizes 504, 854, 904)
Corrosion protection, traditional coils	3A	Fins made of pre-treated aluminium (polyurethane and epoxy)	Improved corrosion resistance, recommended for moderate marine and urban environments	252-1702 (Not available for the sizes 504, 854, 904)
Medium-temperature brine solution	5	Implementation of new algorithms of control and evaporator redesign to allow chilled brine solution production down to -6°C when ethylene glycol is used (-3°C with propylene glycol)	Covers specific applications such as ice storage and industrial processes	252-1702 (Not available for the sizes 504, 854, 904)
Low-temperature brine solution	6	Implementation of new algorithms of control and evaporator redesign to allow chilled brine solution production down to -12°C when ethylene glycol is used (-8°C with propylene glycol)	Covers specific applications such as ice storage and industrial processes	252-1702 (Not available for the sizes 504, 854, 904)
Unit equipped for air discharge ducting	10	Fans equipped with discharge connection flanges - maximum available pressure 60 kPa	Facilitates connections to the discharge ducts	252-1702 (Not available for the sizes 504, 854, 904)
IP54 control box	20A	Increased leak tightness of control boxes	Protects the inside of the electrical box from dusts and sand. In general this option is recommended for installations in polluted environments	252-1702
Tropicalisation of the electrical box	22	Electrical box equipped with an electrical heater and a fan. Electrical connections on the compressors painted with a special varnish and covered with an anti-condensation foam.	Grant safe operation in typical "tropical" climate. This option is recommended for all applications where humidity inside the electrical box can reach 80% at 40°C and unit can remain in stand-by for a long time under this conditions.	252-1702
Grilles and enclosure panels	23	Metal grilles on the 4 unit sides, plus side enclosure panels at each end of the coil	Improves aesthetics, protection against intrusion to the unit interior, coil and piping protection against impacts.	252-1702
Enclosure panels	23A	Side enclosure panels at each end of the coil	Improves aesthetics, coil and piping protection against impacts.	252-1702
Winter operation down to -20°C	28	Fan speed control via frequency converter	Stable unit operation for air temperature down to -20°C	252-1702
Evaporator frost protection	41A	Electric resistance heater on the evaporator and discharge valve	Evaporator frost protection down to -20°C outside temperature	252-1702
Evap. and hydraulic mod. frost protection	41B	Electric resistance heater on evaporator, discharge valve and hydronic module	Evaporator and hydronic module frost protection down to -20°C outside temperature	252-1702
Total heat recovery	50	Unit equipped with additional heat exchanger in parallel with the condenser coils.	Production of free hot-water simultaneously with chilled water production	252-1702 (Not available for the sizes 504, 854, 904)
Master/slave operation	58	Unit equipped with supplementary water outlet temperature sensor kit to be field-installed allowing master/slave operation of two units connected in parallel	Optimised operation of two chillers connected in parallel with operating time equalisation	252-1702
Single power connection point	81	Unit power connection via one main supply connection	Quick and easy installation	1112-1502
Service valve set	92	Liquid line valve (evaporator inlet), compressor suction and discharge line valves and economiser line valve	Allow isolation of various refrigerant circuit components for simplified service and maintenance	252-1702
Compressor discharge valves	93A	Shut-off valve on the compressor discharge piping	Simplified maintenance	252-1702
Evaporator with one pass more	100A	Evaporator with one pass more on the water side	Optimise chiller operation when the chilled water circuit is designed with low waterflows (high delta T evaporator inlet/outlet)	252-1702
Evaporator with one pass less	100C	Evaporator with one pass on the water side. Evaporator inlet and outlet on opposite sides.	Easy to install, depending on site. Reduced pressure drops	252-1002
21 bar evaporator	104	Reinforced evaporator for extension of the maximum water-side service pressure to 21 bar (standard 10 bar)	Covers applications with a high water column evaporator side (typically high buildings)	252-1702
Reversed evaporator water connections	107	Evaporator with reversed water inlet/outlet	Easy installation on sites with specific requirements	252-1702
HP single-pump hydronic module	116B	Complete hydronic module equipped with water filter, expansion tank with safety valve, one high pressure pump, drain valve and water flow control valve. For more details, refer to the dedicated chapter	Plug & play approach	252-502 (Not available for the size 504)
HP dual-pump hydronic module	116C	Complete hydronic module equipped with water filter, expansion tank with safety valve, two high pressure pumps, drain valve and water flow control valve. For more details, refer to the dedicated chapter	Plug & play approach. Increased system reliability	252-502 (Not available for the size 504)
LP single-pump hydronic module	116F	Complete hydronic module equipped with water filter, expansion tank with safety valve, one low pressure pump, drain valve and water flow control valve. For more details, refer to the dedicated chapter	Plug & play approach	252-502 (Not available for the size 504)
LP dual-pump hydronic module	116G	Complete hydronic module equipped with water filter, expansion tank with safety valve, two low pressure pumps, drain valve and water flow control valve. For more details, refer to the dedicated chapter	Plug & play approach. Increased system reliability	252-502 (Not available for the size 504)
Dx Free Cooling system on two circuits	118A	Patented Carrier free-cooling system with cooling micro-pump on both refrigerant circuits. Operation without glycol, no extra free-cooling coil. See Dx Free-cooling option chapter	Energy savings for applications with cooling demand throughout the entire year	252-1002 (Not available for the sizes 504, 854, 904)
High energy efficiency	119	Higher air flow through the condenser coils improving heat exchange efficiency on the condenser	Energy cost reduction and extended operating envelope (full load operation at higher air temperature)	252-1702 (Mandatory for the sizes 504, 854, 904)
CCN to J-Bus gateway	148B	Two-directional communication board complying with JBus protocol	Connects the unit by communication bus to a building management system	252-1702

Options	No.	Description	Advantages	Use for 30XA range
CCN to Lon gateway	148D	Two-directional communication board complying with Lon Talk protocol	Connects the unit by communication bus to a building management system	252-1702
Bacnet over IP gateway	149	Two-directional high-speed communication using BACnet protocol over Ethernet network (IP)	Easy and high-speed connection by ethernet line to a building management system. Allows access to multiple unit parameters	252-1702
Energy Management Module	156	Control board with additional inputs/outputs. See Energy Management Module option chapter	Extended remote control capabilities (set-point reset, ice storage end, demand limits, boiler on/off command...)	252-1702
Touch Pilot control, 7" user interface	158A	Touch Pilot control supplied with a 7 inch colour touch screen user interface	Enhanced ease of use	252-1702
Leak detection	159	0-10 V signal to report any refrigerant leakage in the unit directly on the controller (the leak detector itself must be supplied by the customer)	Immediate customer notification of refrigerant losses to the atmosphere, allowing timely corrective actions	252-1702
Dual relief valves installed w/ 3-way valve	194	Three-way valve upstream of the safety valves on the evaporator and the oil separator	Valve replacement and inspection facilitated without refrigerant loss. Comforms to European standard EN378/BGVD4	252-1382
Compliance with Swiss regulations	197	Additional tests on the water heat exchangers: supply (additional of PED documents) supplementary certificates and test certifications	Conformance with Swiss regulations	252-1702
Compliance with Russian regulations	199	GOST certification	Conformance with Russian regulations	252-1702
Compliance with Australian regulations	200	Unit approved to Australian code	Conformance with Australian regulations	252-1702
Power factor correction	231	Capacitors for automatic regulation of power factor (cos phi) value to 0.95.	Reduction of the real electrical power, compliance with minimum power factor limit set by utilities	252-1002
Traditional coils (Cu/Al)	254	Coils made of copper tubes with aluminium fins	None	252-1702 (Not available for the sizes 504, 854, 904)
Traditional coils (Cu/Al) without slots	255	Coils made of copper tubes with aluminium fins without slots	None	252-1702 (Not available for the sizes 504, 854, 904)
Insulation of the evap. in/out ref.lines	256	Thermal insulation of the evaporator entering/leaving refrigerant lines with flexible, anti-UV insulant	Prevents condensation on the evaporator entering/leaving refrigerant lines	252-1702
Low noise level	257	Sound insulation of main noise sources (includes option 279)	5 to 12 dB(A) quieter than standard unit (depending model and size). Refer to the physical data table for detailed values	252-1702
Very low sound level	258	Enhanced sound insulation of main noise sources combined with fans speed management (includes option 279)	2 to 3 dB(A) quieter than unit with option 257. Refer to the physical data table for detailed values	452-1702 (Not available for the sizes 504, 854, 904)
Enviro-Shield anti-corrosion protection	262	Coating by conversion process which modifies the surface of the aluminum producing a coating that is integral to the coil. Complete immersion in a bath to ensure 100% coverage. No heat transfer variation, tested 4000 hours salt spray per ASTM B117	Improved corrosion resistance, recommended for use in moderately corrosive environments	252-1702
Super Enviro-Shield anti-corrosion protection	263	Extremely durable and flexible epoxy polymer coating applied on micro channel heat exchangers by electro coating process, final UV protective topcoat. Minimal heat transfer variation, tested 6000 hours constant neutral salt spray per ASTM B117, superior impact resistance per ASTM D2794	Improved corrosion resistance, recommended for use in extremely corrosive environments	252-1702
Welded evaporator water connection kit	266	Victaulic piping connections with welded joints	Easy installation	252-1702
Compressor enclosure	279	Compressor sound enclosure	4 to 10 dB(A) quieter than standard unit. Refer to the physical data table for detailed values	252-1702
Evaporator with aluminium jacket	281	Evaporator covered with an aluminium sheet for thermal insulation protection	Improved resistance to aggressive climate conditions	252-1702
230 V electrical plug	284	230 V AC power supply source provided with plug socket and transformer (180 VA, 0.8 Amps)	Permits connection of a laptop or an electrical device during unit commissioning or servicing	252-1702
Carrier Connect link (BSS regions only)	298	3G Router board NOTE 1: Require option 149 NOTE 2: When more than one machine is installed on site, only one of them shall be equipped with option 298 while all of them must be equipped with option 149 NOTE 3: If the Carrier® PlantCTRL™ is on site, option 298 shall be integrated in the Carrier® PlantCTRL™ while option 149 is still mandatory for each single unit.	Enabler for Carrier Connect service offer	252-1702



## 13 - STANDARD MAINTENANCE

Air conditioning equipment must be maintained by professional technicians, whilst routine checks can be carried out locally by specialised technicians. See the standard EN 378-4.

Simple preventive maintenance will allow you to get the best performance from your HVAC unit:

- Improved cooling performance
- Reduced power consumption
- Prevention of accidental component failure
- Prevention of major time-consuming and costly inter-ventions
- Protection of the environment.

There are five maintenance levels for HVAC units, as defined by the AFNOR X60-010 standard.

### 13.1 - Level 1 maintenance

See note “Any deviation or non-observation ...” in chapter 13.3 - “Level 3 (or higher) maintenance”. Simple procedure can be carried out by the user:

- Visual inspection for oil traces (sign of a refrigerant leak)
- Air heat exchanger (condenser) cleaning - see chapter 13.6.1 - “Level 1”.
- Check for removed protection devices, and badly closed doors/covers
- Check the unit alarm report when the unit does not work. Refer to the 30XA/30XAS/30XW Touch Pilot control manual for a more detailed explanation.

General visual inspection for any signs of deterioration.

### 13.2 - Level 2 maintenance

See note “Any deviation or non-observation ...” in the ext column. This level requires specific know-how in the electrical, hydronic and mechanical fields. It is possible that these skills are available locally: Existence of a maintenance service, industrial site, specialised subcontractor. In these cases, the following maintenance operations are recommended.

Carry out all level 1 operations, then:

- At least once a year tighten the power circuit electrical connections (see table 13.4).
- Check and re-tighten all control/command connections, if required (see table 13.4).
- Check the differential switches for correct operation every 6 months (free-cooling option 118A).

- Remove the dust and clean the interior of the control boxes, if required.
- Check the presence and the condition of the electrical protection devices.
- Check the correct operation of all heaters.
- Replace the fuses every 3 years or every 15000 hours (age-hardening).
- Replace the control box cooling fans used with option 22 (with designation EF22\_) every five years.
- Check the height of the anti-vibration mountings (located between the compressor rails and the unit chassis) after 5 years of operation, and then each year. When the total minimum height of the mountings is less than 25 mm replace the mountings.
- Check the water connections.
- Purge the water circuit.
- Clean the water filter.
- Fully clean the condensers with a low-pressure jet and a bio-degradable cleaner (counter-current cleaning - see chapter 13.6.2 - “Level 2”).
- Replace the stuffing box packing of the pump after 10000 hours of operation.
- Check the unit operating parameters and compare them with previous values.
- Keep and maintain a maintenance sheet, attached to each HVAC unit.
- Check the correct operation of the capacitor (power factor correction option 231).

All these operations require strict observation of adequate safety measures: Individual protection garments, compliance with all industry regulations, compliance with applicable local regulations and using common sense.

### 13.3 - Level 3 (or higher) maintenance

**NOTE: Any deviation or non-observation of these maintenance criteria will render the guarantee conditions for the HVAC unit null and void, and the manufacturer, Carrier SCS will no longer be held responsible.**

The maintenance at this level requires specific skills/ approval/tools and know-how and only the manufacturer, his representative or authorised agent are permitted to carry out these operations. These maintenance operations concern for example:

- A major component replacement (compressor, evapo-rator)
- Any intervention on the refrigerant circuit (handling refrigerant)
- Changing of parameters set at the factory (application change)
- Removal or dismantling of the HVAC unit
- Any intervention due to a missed established maintenance operation
- Any intervention covered by the warranty.

## 13.4 - Tightening torques for the main electrical connections

### 13.4.1 - Tightening torques for the main electrical connections

Component	Designation in the unit	Value (N·m)
<b>Screw on bus bar, customer connection</b>		
M8	-	18
M10	L1/L2/L3	30
<b>Soldered screw PE, customer connection (M12)</b>		
	PE	70
<b>Tunnel terminal screw, compressor contactor</b>		
Contactor 3RT103_		
Contactor 3RT104_		5
Contactor 3RT105_		11
Contactor 3RT106_	KM_	21
<b>Nut on compressor contactor deck</b>		
M8 for contactors 3RT105_		18
M10 for contactors 3RT10_7	KM_	30
<b>Tunnel terminal screw, current transformer</b>		
Size 2 (3RB2956_)		11
Size 3 (3RB2966_)	TI_	21
<b>Nut on current transformer deck</b>		
M8		18
M10	TI_	30
<b>Compressor earth terminal in the power wiring control box</b>		
Terminal M8	Gnd	30
<b>Compressor phase connection terminals</b>		
M12		25
M16	EC_	30
<b>Compressor earth connection</b>		
	Gnd on EC_	25
<b>Tunnel terminal screw, disconnects 3RV1011_</b>		
	QF_/QM_	1
<b>Tunnel terminal screw, hydronic pump contactor</b>		
Contactor 3RT101_	KM90_	1
Contactor 3RT102_		2.2

**ATTENTION:** The tightening of the connections at the compressor terminals requires special precautions. Please refer to the chapter below.

### 13.4.2 - Connection precautions for the compressor power terminals

These precautions must be applied during an intervention that requires the removal of the power conductors connected to the compressor supply terminals.

The tightening nut of terminal (6) supporting the isolator (7) must never be loosened, as it ensures terminal tightness and compressor leak tightness.

The tightening of phase lug (4) must apply the torque between counter nut (5) and tightening nut (3): During this operation a counter-torque must be applied at counter nut (5). Counter nut (5) must not be in contact with the tightening nut of terminal (6).

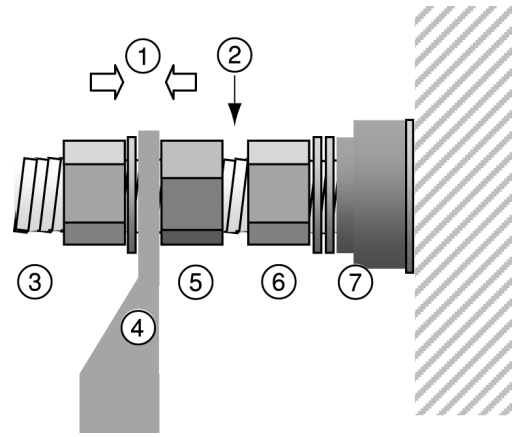

1. Torque application to tighten the lug
2. Avoid contact between the two nuts
3. Lug tightening nut
4. Flat lug
5. Counter-nut
6. Terminal tightening nut
7. Isolator

## 13.5 - Tightening torques for the main bolts and screws

Screw type	Used for	Value (N·m)
Metal screw D = 4.8	Condensing module, housing supports	4.2
Screw H M8	Condensing module, compressor fixing	18
Taptite screw M10	Condensing module, chassis - structure fixing, control box fixings, compressor fixings, oil separator fixing	30
Taptite screw M6	Piping support, cowling	7
Screw H M8	Piping clip	12
Screw H M6	Piping clip	10
Nut H M10	Compressor chassis	30
Nut H M10	Hydronic pump chassis	30
Screw H M8	Filter drier cover	35
Screw H M12	Economiser port flange	40
Screw H M16	Oil separator flanges, suction flanges	110
Screw H M16	Heat exchanger water boxes	190
Screw H M20	Suction flanges	190
Nut 5/8 ORFS	Oil line	65
Nut 3/8 ORFS	Oil line	26
Nut H M12/M16	Victaulic collars on suction piping	60/130
Self-locking Nut M16	Compressor fixing	30

**ATTENTION:** The tightening of the connections at the compressor terminals requires special precautions. Please refer to the chapter below.

## 13.6 - Condenser coil

We recommend, that coils are inspected regularly to check the degree of fouling. This depends on the environment where the unit is installed, and will be worse in urban and industrial installations and near trees that shed their leaves.

For coil cleaning, two maintenance levels are used, based on the AFNOR X60-010 standard:

### 13.6.1 - Level 1

#### 13.6.1.1 - Recommendations for maintenance and cleaning of round tube plate fin (RTPF) condenser coils

- Regular cleaning of the coil surface is essential for correct unit operation. Eliminating contamination and removal of harmful residue will increase the operating life of the coils and the unit.
- The maintenance and cleaning procedures below are part of the regular maintenance and will prolong the life of the coils.

### Removal of fibres that obstruct the surfaces

Fibres and dirt collected on the coil surface must be removed with a vacuum cleaner. If you do not have a vacuum cleaner, a soft brush with non-metallic bristles can be used instead. In all cases cleaning must be done in the direction of the fins, as the coil surface is easily damaged. The fins bend easily and damage the protective coating of the coil, if cleaning is done at right angles to the fins. Clean against the air flow direction.

**NOTE:** *Using a water jet from a spray hose on a polluted surface will result in fibres and dirt becoming trapped in the coil, making cleaning more difficult. All fibres and dirt must be removed from the surface, before using a low-speed rinsing jet.*

#### **Periodical cleaning with clean water:**

*For coils installed in a coastal or industrial environment periodical cleaning by rinsing with water is beneficial. It is however essential that rinsing is done with a low-speed water jet to avoid damaging the fins. Monthly cleaning as described below is recommended.*

#### **ATTENTION**

- *Chemical cleaning agents, water containing bleach, acidic or basic cleaning agents must never be used to clean the coil exterior or interior. These cleaning agents may be difficult to rinse off and can accelerate corrosion at the joint between tube and fins, where two different materials come into contact.*
- *High-speed water from a high-pressure cleaner, spray hose or compressed air cleaner must never be used for coil cleaning. The force of the water or air jet will bend the fins and increase the air-side pressure drop. This can result in reduced performance or nuisance shutdowns of the unit.*

#### **13.6.1.2 - Recommendations for maintenance and cleaning of MCHE (microchannel) condenser coils**

- Regular cleaning of the coil surface is essential for correct unit operation. Eliminating contamination and removal of harmful residue will increase the operating life of the coils and the unit.
- The maintenance and cleaning procedures below are part of the regular maintenance and will prolong the life of the coils.

**ATTENTION:** *Do not use chemical cleaners on MCHE condenser coils. These cleaning agents can accelerate corrosion and damage the coils.*

- Remove foreign objects and debris attached to the coil surface or wedged between the chassis and the supports.
- Provide personal protection equipment including safety glasses and/or a face mask, waterproof clothing and safety gloves. It is recommended to wear clothing that covers the whole body.
- Start the high-pressure spray gun and remove any soap or industrial cleaner from it before cleaning the condenser coils. Only drinkable cleaning water is permitted to clean the condenser coils.

- Clean the condenser face by spraying the coil evenly and in a stable manner from bottom to top, directing the water jet at right angles to the coil. Do not exceed 6200 kPa (62 bar) or an angle of 45° related to the coil. The diffuser must be at least 300 mm away from the coil surface. It is essential to control the pressure and to be careful not to damage the fins.

**ATTENTION:** *Excessive water pressure can break the weld points between the fins and the flat MCHE microchannel tubes.*

#### **13.6.2 - Level 2**

Clean the coil, using appropriate products. We recommend cleaning with clear water to remove pollutants. If the use of cleaning products is necessary, we specify:

- pH between 7 and 8
- Absence of chlorine, sulphate, copper, iron, nickel or titanium
- Chemical compatibility with aluminium and copper.

For RTPF coils this process can either be carried out using a high-pressure spray gun in the low-pressure position. With pressurised cleaning methods care should be taken not to damage the coil fins.

The spraying of the coil must be done:

- In the direction of the fins
- In the opposite direction of the air flow direction
- With a large diffuser (25-30°)
- At a minimum distance of 300 mm from the coil.

It is not necessary to rinse the coil, as the products used are pH neutral. To ensure that the coil is perfectly clean, we recommend rinsing with a low water flow rate.

For MCHE condenser coils refer to chapter 13.6.1.2 under level 1 maintenance for use of a high-pressure spray gun.

#### **IMPORTANT:**

- *Never use pressurised water without a large diffuser. Do not use high-pressure cleaners for Cu/Cu and Cu/Al coils! High pressure cleaners are only permitted for MCHE coils (maximum permitted pressure 6200 kPa (62 bar)).*
- *Concentrated and/or rotating water jets are strictly forbidden.*
- *Never use a fluid with a temperature above 45 °C to clean the air heat exchangers.*
- *Correct and frequent cleaning (approximately every three months) will prevent 2/3 of the corrosion problems.*
- *Protect the control box during cleaning operations.*

### 13.7 - Evaporator maintenance

Check that:

- The insulating foam is intact and securely in place.
- The cooler heaters are operating, secure and correctly positioned.
- The water-side connections are clean and show no sign of leakage.

### 13.8 - Compressor maintenance

#### 13.8.1 - Oil separator

Check the correct operation of the heaters and check that they are well attached to the oil separator ring.

#### 13.8.2 - Integral oil filter change

As system cleanliness is critical to reliable system operation, there is a filter in the oil line at the oil separator outlet. The oil filter is specified to provide a high level of filtration (5 µm) required for long bearing life.

The filter should be checked after the first 500 hours of operation, and every subsequent 2000 hours. The filter should be replaced at any time when the pressure differential across the filter exceeds 200 kPa (2 bar).

The pressure drop across the filter can be determined by measuring the pressure at the filter service port and the oil pressure port. The difference in these two pressures will be the pressure drop across the filter, check valve, and solenoid valve. The pressure drop across the check valve and solenoid valve is approximately 40 kPa (0.4 bar), which should be subtracted from the two oil pressure measurements to give the oil filter pressure drop.

#### 13.8.3 - Compressor rotation control

Correct compressor rotation is one of the most critical application considerations. Reverse rotation, even for a very short duration, damages the compressor.

The reverse rotation protection scheme must be able to determine the direction of rotation and stop the compressor within 300 ms. Reverse rotation is most likely to occur when-ever the wiring to the compressor terminals is disturbed.

To minimize the opportunity for reverse rotation, the following procedure must be applied. Rewire the power cables to the compressor terminal pin as originally wired.

For replacement of the compressor, a low pressure switch is included with the compressor. This low pressure switch should be temporarily installed as a hard safety on the high pressure part of the compressor. The purpose of this switch is to protect the compressor against any wiring errors at the compressor terminal pin. The electrical contact of the switch would be wired in series with the high pressure switch. The switch will remain in place until the compressor has been started and direction of rotation has been verified; at this point, the switch will be removed.

The switch that has been selected for detecting reverse rotation is Carrier part number HK01CB001. This switch opens the contacts when the pressure falls below 7 kPa. The switch is a manual reset type that can be reset after the pressure has once again risen above 70 kPa. It is critical that the switch be a manual reset type to preclude the compressor from short cycling in the reverse direction.

### 13.9 - Precaution for compressor power supply bus bar connection

This note applies to units using power supply bus bars with riveted contact block at the level of the connection cages in the control box. During re-connection it is imperative to:

- Engage each bus bar in the cage up to the stop
- Ensure visually that the bus bars have good contact at the connection areas: There must not be any free movement between the bus bar and the connection area created by the fixing rivet of the contact block.

#### Connection of the contactor or current transformer

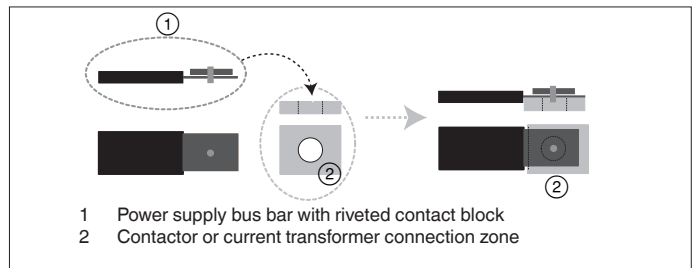

### 13.10 - Check of power factor correction capacitors

The verification consists in measuring input current of each capacitor block. Absence of current despite capacitor is energized is an indication that there is a defect.

Confirmation shall be done by removing the capacitors and checking the underside.

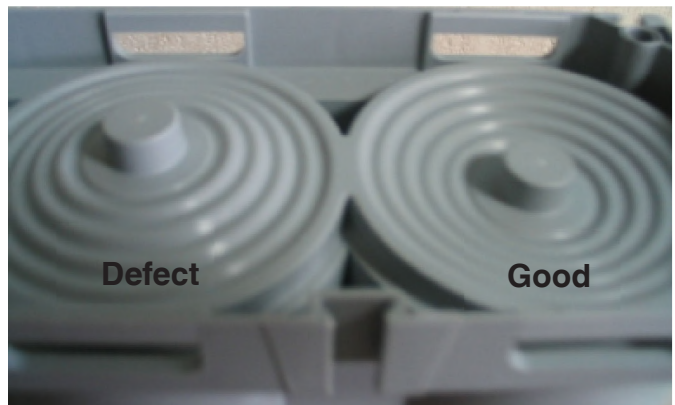

**14 - START-UP CHECKLIST FOR 30XA LIQUID CHILLERS (USE FOR JOB FILE)**

**Preliminary information**

Job name: .....  
Location: .....  
Installing contractor: .....  
Distributor: .....

**Unit**

Model: .....

**Compressors**

**Circuit A**

Model number .....  
Serial number .....  
Motor number .....

**Circuit B**

Model number .....  
Serial number .....  
Motor number .....

**Circuit C**

Model number .....  
Serial number .....  
Motor number .....

**Circuit D**

Model number .....  
Serial number .....  
Motor number .....

**Evaporator**

Model number .....  
Serial number .....

**Condenser**

Model number .....

Additional optional units and accessories .....

**Preliminary equipment check**

Is there any shipping damage? ..... If so, where? .....  
Will this damage prevent unit start-up? .....

- Unit is level in its installation
- Power supply agrees with the unit nameplate
- Electrical circuit wiring has been sized and installed properly
- Unit ground wire has been connected
- Electrical circuit protection has been sized and installed properly
- All terminals are tight
- All chilled water valves are open
- All chilled water piping is connected properly
- All air has been vented from the chilled water circuit
- Chilled water pump (CWP) is operating with the correct rotation. Check the phase sequence of the electrical connection. If the unit is equipped with a hydronic module, use the pump test function. Refer to the 30XA/30XAS/30XW Touch Pilot control manual for a more detailed explanation.
- Circulate chilled water in the water circuit for at least two hours, then remove, clean and replace the screen filter. After the pump test has been completed, switch the unit off again.
- Inlet piping to cooler includes a 20 mesh strainer with a mesh size of 1.2 mm.
- The compressor flange has been removed.

**Unit start-up**

- a. Oil heaters have been energized for at least 24 hours (30XA)
- b. Oil level is correct
- c. All discharge and liquid valves are open
- d. All suction valves are open, if equipped
- e. All oil line valves and economizer discharge bubbler valves (if equipped) are open
- f. The contactor
- g. Checks have been carried out for any possible leaks. Unit has been leak checked (including fittings)
  - g1 - on the whole unit
  - g2 - at all connectionsLocate, repair, and report any refrigerant leaks.....  
.....  
.....
- h. Check voltage imbalance: AB..... AC..... BC.....  
Average voltage = ..... V  
Maximum deviation = ..... V  
Voltage imbalance = ..... %
- i. Voltage imbalance is less than 2%

**WARNING: Operation of the chiller with an improper supply voltage or excessive phase imbalance constitutes abuse and will invalidate the Carrier warranty. If the phase imbalance exceeds 2% for voltage, or 10% for current, contact your local electricity supply at once and ensure that the chiller is not switched on until corrective measures have been taken.**

**Check cooler water loop**

- Water loop volume = ..... litres
- Calculated volume = ..... litres
- 3.25 litres/nominal kW capacity for air conditioning
- 6.5 litres/nominal kW capacity for process cooling
- Proper loop volume established
- Proper loop corrosion inhibitor included..... litres of.....
- Proper loop freeze protection included (if required) ..... litres of.....
- Piping includes electric heater tape, if exposed to the outside
- Inlet piping to cooler includes a 20 mesh strainer with a mesh size of 1.2 mm

**Check pressure drop across the cooler**

- Entering cooler = ..... kPa
- Leaving cooler = ..... kPa
- Leaving - entering = ..... kPa

**WARNING: Plot cooler pressure drop on performance data chart (in product data literature) to determine total litres per second (l/s) and find unit's minimum flow rate.**

- Total = ..... l/s
- Nominal kW = ..... l/s
- Total l/s is greater than unit's minimum flow rate
- Total l/s meets job specified requirement of..... l/s

**WARNING: Once power is supplied to the unit, check for any alarms. Refer to the 30XA/30XAS/30XW Touch Pilot control manual for the alarm menu.**

**Note all alarms:**.....  
.....

**Notes:**.....  
.....





Order No: 13452-76, 07.2015 - Supersedes order No: 13452-76, 12.2014.  
Manufacturer reserves the right to change any product specifications without notice.



[www.eurovent-certification.com](http://www.eurovent-certification.com)  
[www.certiflash.com](http://www.certiflash.com)



Quality and Environment  
Management Systems  
Approval

Manufacturer: Carrier SCS, Montluel, France.  
Printed in the European Union.