

TECHNICAL MANUAL

Chilled Water Fan Coil Units

MWM, MCK, MCM, MCC, MDB Series



MWM-LW



MCK-EW

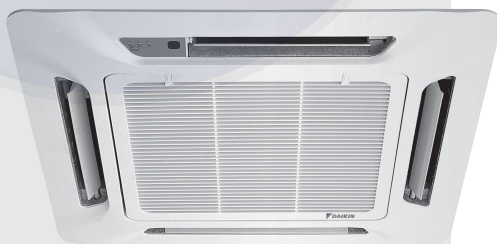

MCK-CW



MCM-DW/EW

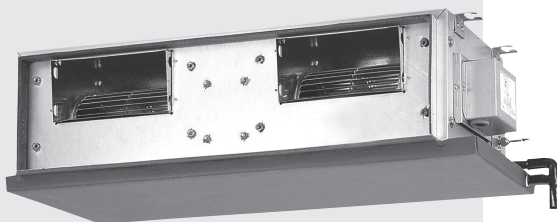

MCC-CW



MDB-BW



Table of Contents

Nomenclature	1
Application Information	9
Installation Guide.....	10
Sound Data	15
NC Curve.....	22
Selection Process	43
Engineering & Physical Data	58
Outlines & Dimensions	69
Wiring Diagrams	101
Service & Maintenance	116
Troubleshooting	117



“McQuay” is a registered trademark of McQuay International. All rights reserved.
© 2013 McQuay International. All rights reserved throughout the world.

Bulletin illustrations cover the general appearance of McQuay International products at the time of publication.
We reserve the right to change design and construction specifications at any time without notice.

Nomenclature (Wall Mounted Fan Coil Unit)

M WM 10 L W - A C E D A - R

Brand

M : McQuay

Product Type

WM : Wall Mounted

Size (Cooling/Heating)

07 : 8,300/11,000 btu/hr
10 : 9,200/12,000 btu/hr
15 : 11,300/15,000 btu/hr
20 : 15,500/20,500 btu/hr
25 : 18,000/25,000 btu/hr

Product Series

L : L series

Model

W : Chilled Water Fan Coil

RoHS Compliance

Product Specification Variation

A : First Issue

Grille

D : Grille D

Operating Mode

E : Cooling Only
H : Heatpump

Market Region

C : Export with CE Mark

Electrical Characteristics

A : 50Hz / 1Ph / 220-240V
K : 60Hz / 1Ph / 208-230V

Nomenclature (Cassette Fan Coil Unit C series)

M CK 10 C W - A X AB - R

Brand

M : McQuay

Product Type

CK : Ceiling Cassette

Size (Cooling/Heating)

10 : 8,500/12,000 btu/hr
 15 : 14,000/16,000 btu/hr
 20 : 15,500/18,000 btu/hr

Product Series

C : C series

Model

W : Chilled Water Fan Coil

RoHS Compliance

Product Specification Variation

Type of ref. connection

X : Not applicable

Electrical Characteristics

A : 50Hz / 1Ph / 220-240V

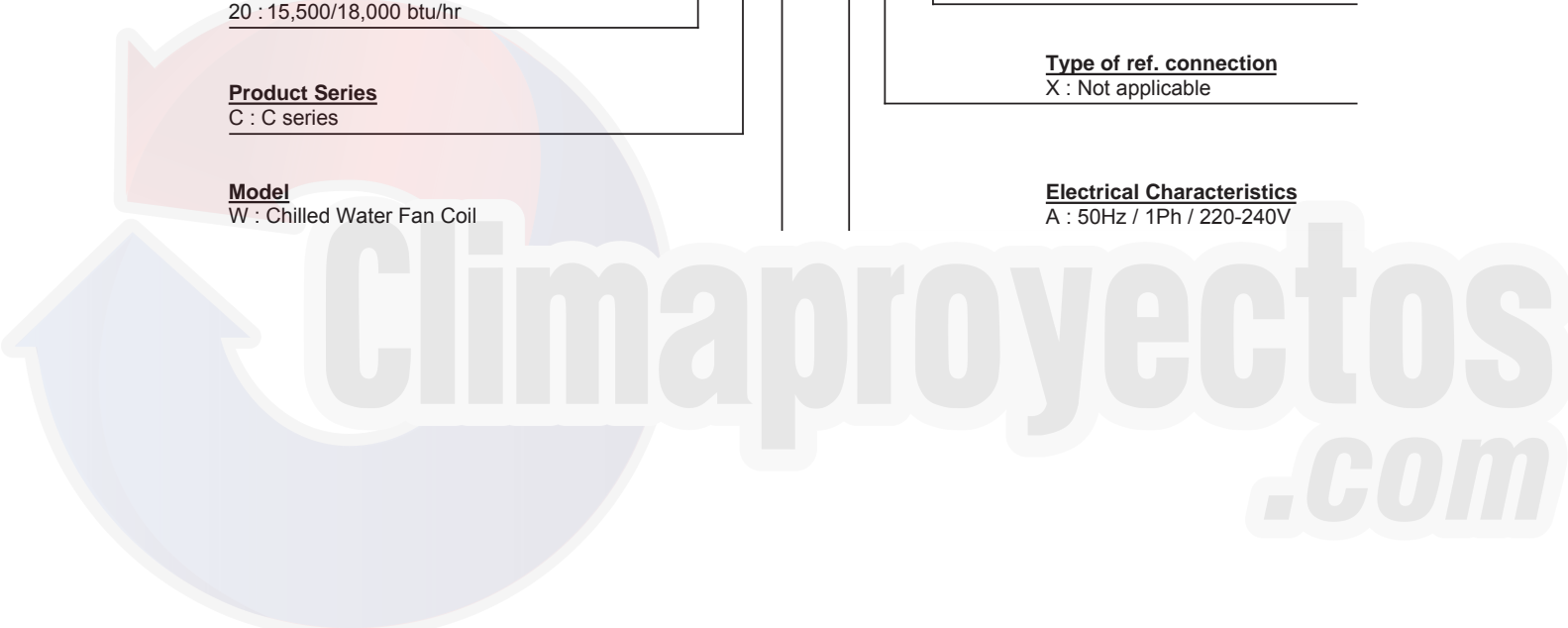

Nomenclature (Cassette Fan Coil Unit A series)

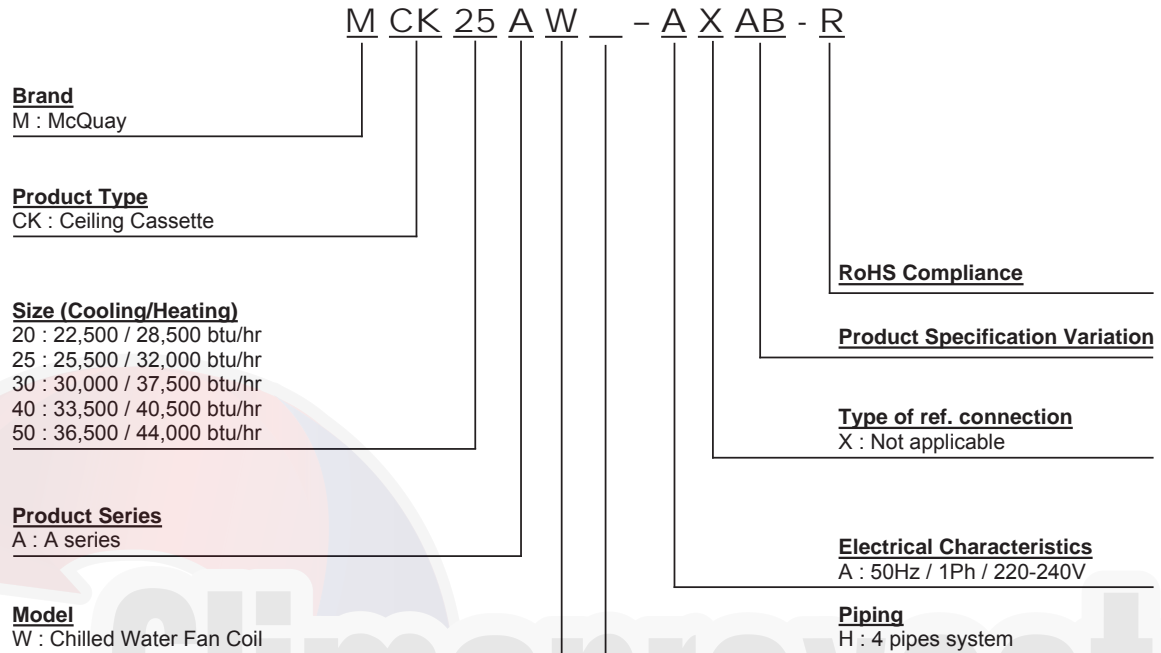

Nomenclature (Ceiling Cassette E series)

M CK 20 E W - A E C A A - R

Brand

M : McQuay

Product Type

CK : Ceiling Cassette

Size (Cooling/Heating)

20 : 20,000 / 28,000 btu/hr
 25 : 25,000 / 33,600 btu/hr
 30 : 30,000 / 38,300 btu/hr
 40 : 38,000 / 45,500 btu/hr
 50 : 43,000 / 52,000 btu/hr

Product Series

E : E series

Model

W : Chilled Water Fan Coil

RoHS Compliance

Product Specification Variation

A : First Issue

Motor

A : AC motor

Controller

C : W3 Control Module with DC swing

Market Region

E : Export w/o marking

Electrical Characteristics

A : 50Hz / 1Ph / 220-240V

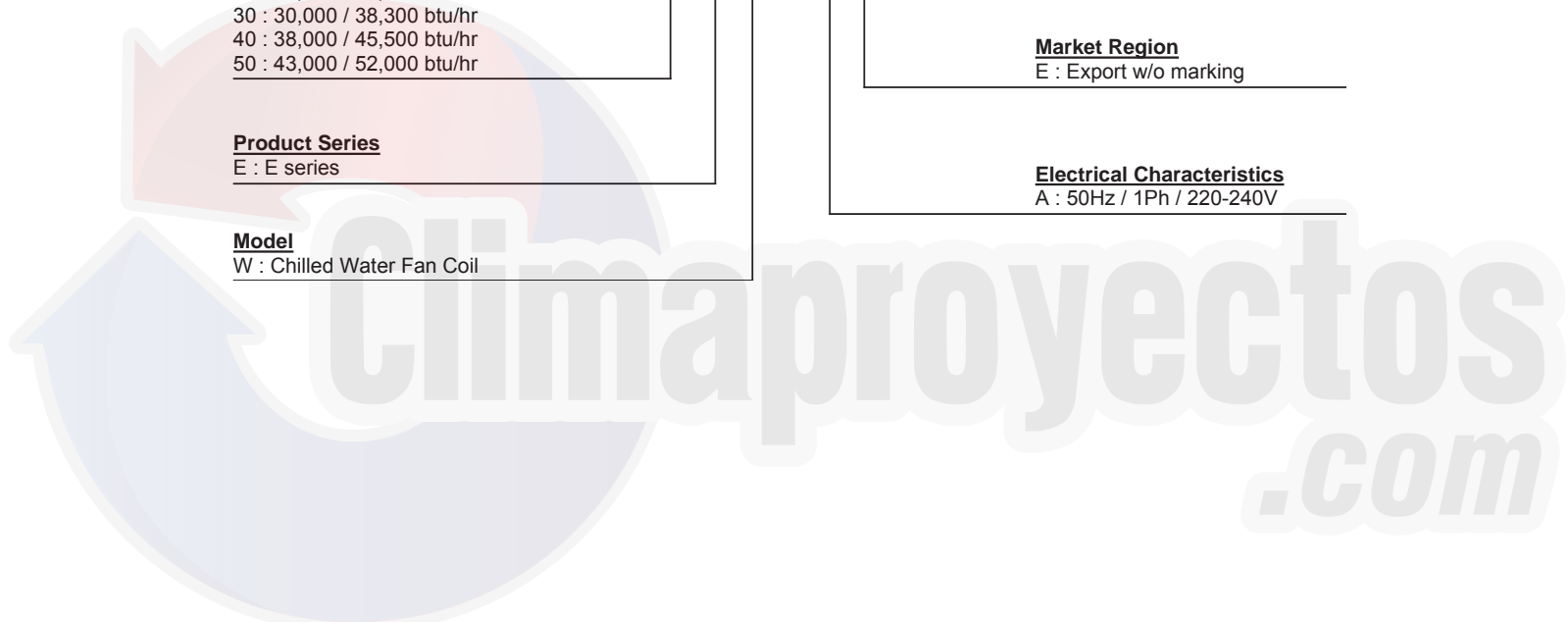

Nomenclature (Ceiling Mounted D series)

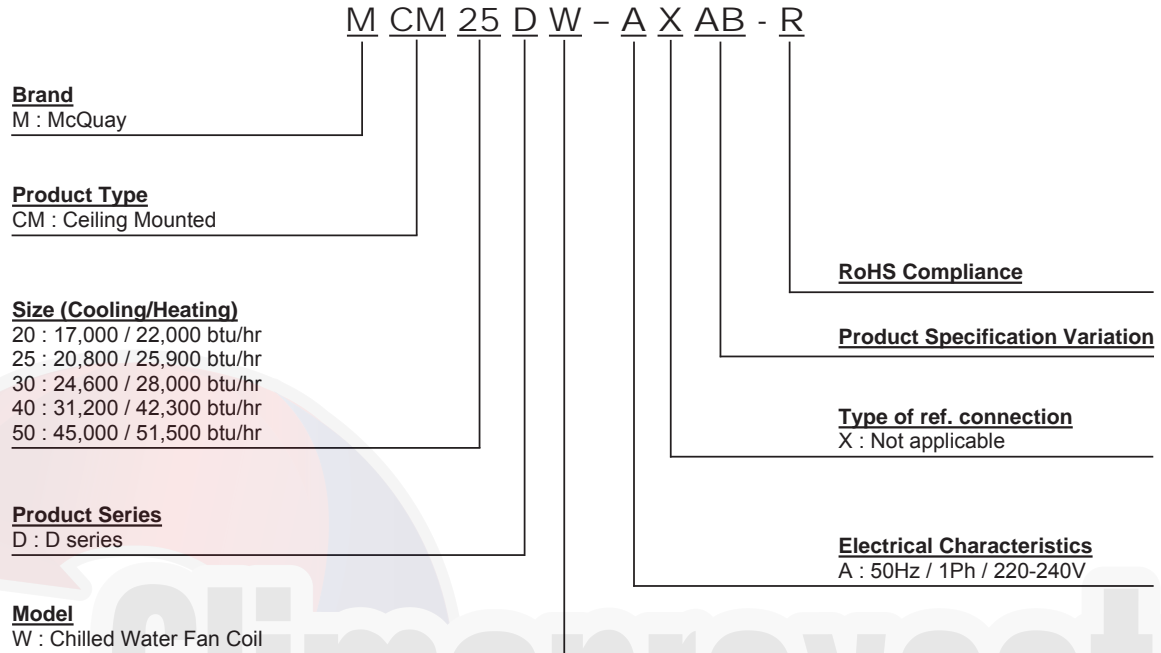

Nomenclature (Ceiling Mounted E series)

M CM 15 E W - A X AB - R

Brand

M : McQuay

Product Type

CM : Ceiling Mounted

Size (Cooling/Heating)

10 : 15,500 / 19,500 btu/hr
 15 : 20,300 / 25,000 btu/hr
 20 : 21,000 / 28,000 btu/hr

Product Series

E : E series

Model

W : Chilled Water Fan Coil

RoHS Compliance

Product Specification Variation

Type of ref. connection

X : Not applicable

Electrical Characteristics

A : 50Hz / 1Ph / 220-240V

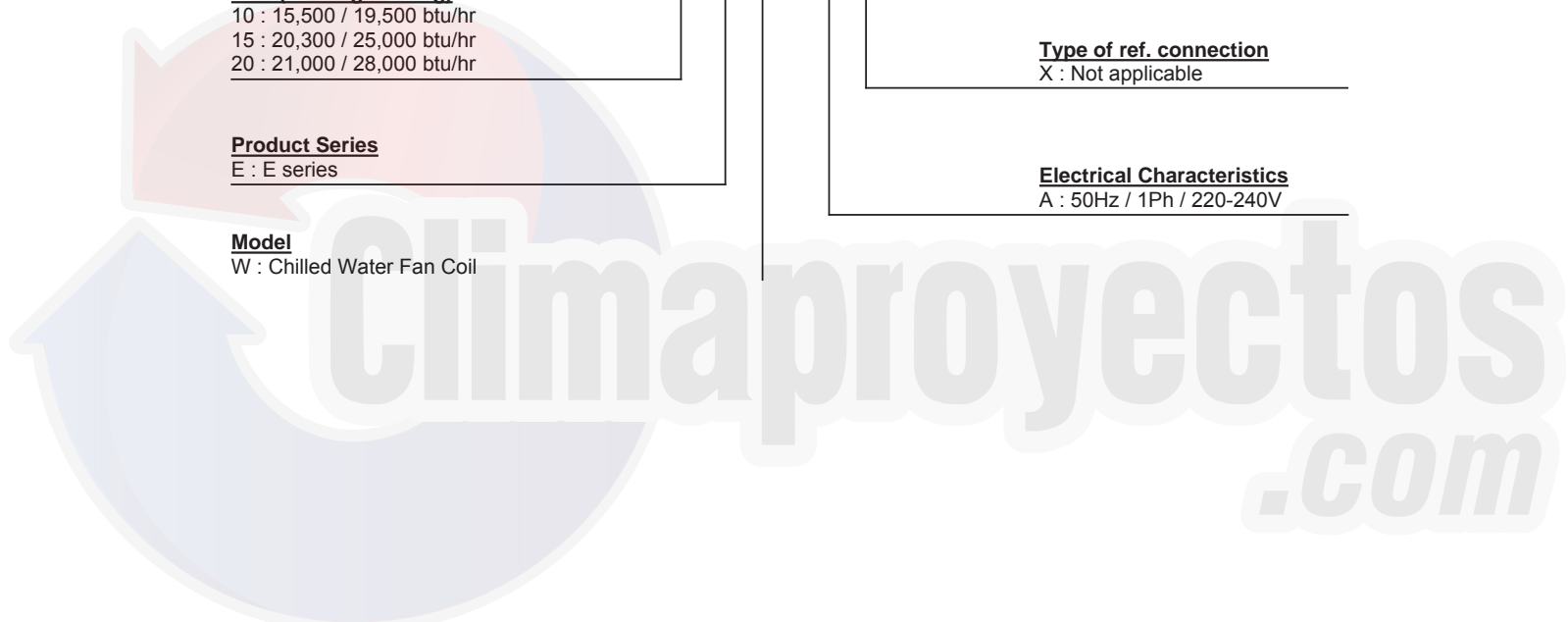

Nomenclature (Ceiling Concealed)

M CC 010 C W - A X AC - R

Brand

M : McQuay

Product Type

CC : Ceiling Concealed

Size (Cooling/Heating)

010 : 9,900/11,500 btu/hr
015 : 11,600/15,000 btu/hr
020 : 18,000/23,000 btu/hr
025 : 22,500/29,000 btu/hr
028 : 26,000/33,000 btu/hr
030 : 28,000/36,000 btu/hr
038 : 35,200/43,000 btu/hr
040 : 38,000/46,000 btu/hr
050 : 47,000/57,000 btu/hr
060 : 54,000/67,000 btu/hr

Product Series

C : C series

Model

W : Chilled Water Fan Coil

RoHs Compliance

Product Specification Variation

Type of ref. connection

X : Not applicable
F : For Flare

Electrical Characteristics

A : 50Hz / 1Ph / 220-240V

Nomenclature (Ducted Blower B series)

M DB 75 B W - A X AB - R

Brand

M : McQuay

Product Type

DB : Ducted Blower

Size (Cooling/Heating)

75 : 75,600 / 78,000 btu/hr
 100 : 95,000 / 97,500 btu/hr
 125 : 125,000 / 138,000 btu/hr
 150 : 150,000 / 170,000 btu/hr

Product Series

B : B series

Model

W : Chilled Water Fan Coil

RoHS Compliance

Product Specification Variation

Type of ref. connection

X : Not applicable

Electrical Characteristics

A : 50Hz / 1Ph / 220-240V
 F : 50Hz / 3Ph / 380-415V

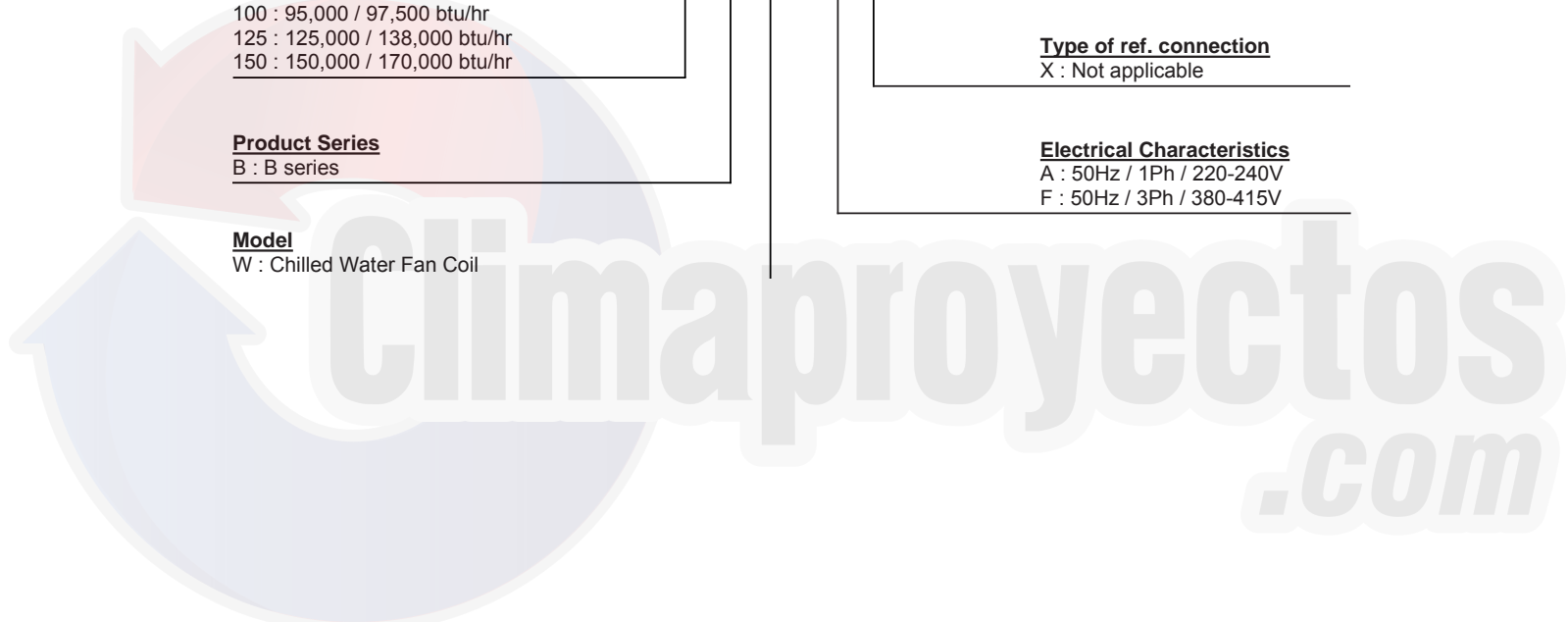

Application Information

Model: MWM Series

Operating Limits:

Thermal carrier : Water
 Water temperature : 4°C ~ 10°C (Cooling), 35°C ~ 50°C (Heating)
 Maximum water pressure : 16 bar
 Air temperature : (as below)

Cooling Mode

Temperature	Ts °C/°F	Th °C/°F
Minimum indoor temperature	19.0 / 66.2	14.0 / 57.2
Maximum indoor temperature	32.0 / 89.6	23.0 / 73.4

Heating Mode

Temperature	Ts °C/°F	Th °C/°F
Minimum indoor temperature	15.0 / 59.0	-
Maximum indoor temperature	27.0 / 80.6	-

Ts: Dry bulb temperature. Th: Wet bulb temperature.

Model: MCK Series

Operating Limits:

Thermal carrier : Water
 Water temperature : 4°C ~ 10°C (Cooling), 35°C ~ 50°C (2 Pipes), 35°C ~ 70°C (4 Pipes)
 Maximum water pressure : 16 bar
 Air temperature : (as below)

Cooling Mode

Temperature	Ts °C/°F	Th °C/°F
Minimum indoor temperature	16.0 / 60.8	11.0 / 51.8
Maximum indoor temperature	32.0 / 89.6	23.0 / 73.4

Heating Mode

Temperature	Ts °C/°F	Th °C/°F
Minimum indoor temperature	16.0 / 60.8	-
Maximum indoor temperature	30.0 / 86.0	-

Ts: Dry bulb temperature. Th: Wet bulb temperature.

Model: MCC Series

Operating Limits:

Thermal carrier : Water
 Water temperature : 5 ~ 50°C
 Maximum water pressure : 16 bar
 Air temperature : (as below)

Cooling Mode

Temperature	Ts °C/°F	Th °C/°F
Minimum indoor temperature	19.0 / 66.2	14.0 / 57.2
Maximum indoor temperature	32.0 / 89.6	23.0 / 73.4

Heating Mode

Temperature	Ts °C/°F	Th °C/°F
Minimum indoor temperature	15.0 / 59.0	-
Maximum indoor temperature	27.0 / 80.6	-

Ts: Dry bulb temperature. Th: Wet bulb temperature.

Model: MDB Series

Operating Limits:

Thermal carrier : Water
 Water temperature : 4°C ~ 10°C (Cooling), 35°C ~ 70°C (Heating)
 Maximum water pressure : 16 bar
 Air temperature : (as below)

Cooling Mode

Temperature	Ts °C/°F	Th °C/°F
Minimum indoor temperature	19.0 / 66.2	14.0 / 57.2
Maximum indoor temperature	32.0 / 89.6	23.0 / 73.4

Heating Mode

Temperature	Ts °C/°F	Th °C/°F
Minimum indoor temperature	15.0 / 59.0	-
Maximum indoor temperature	27.0 / 80.6	-

Ts: Dry bulb temperature. Th: Wet bulb temperature.

Installation Guide

System Configuration

The standard controller board (W2/W3) comes with a VALVE jumper and a HEAT jumper. The system can be configured as the jumper selection listed below:

	HEAT Jumper	VALVE Jumper
Heatpump Mode & Valve Application	√	√
Heatpump Mode & Valveless Application	√	X
Cooling Mode & Valve Application	X	√
Cooling Mode & Valveless Application	X	X

√ Jumper Remained X Jumper Removed



Caution

Disconnect the power supply to the unit before attempting to connect the wiring

Valve, Heat and Fan Priority Setting

Model: MWM-LW Series

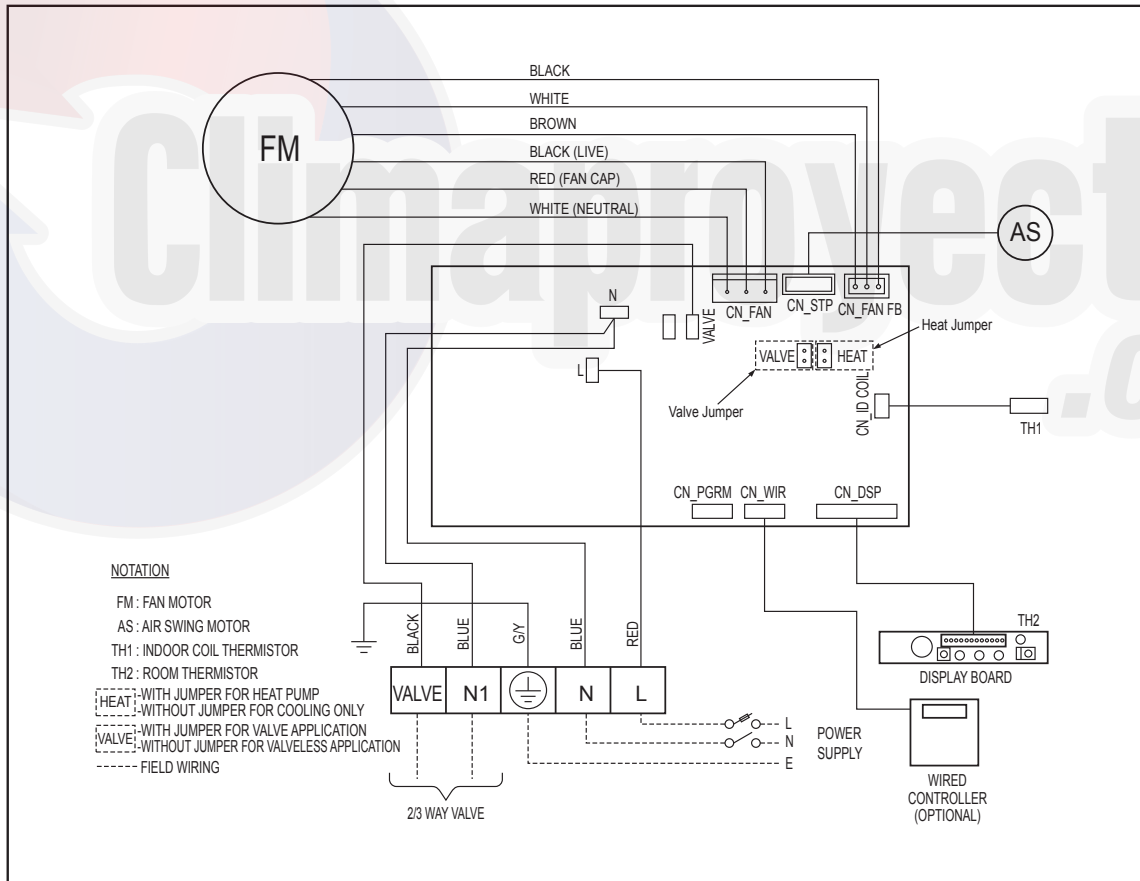

Model: MCK/MCC Series

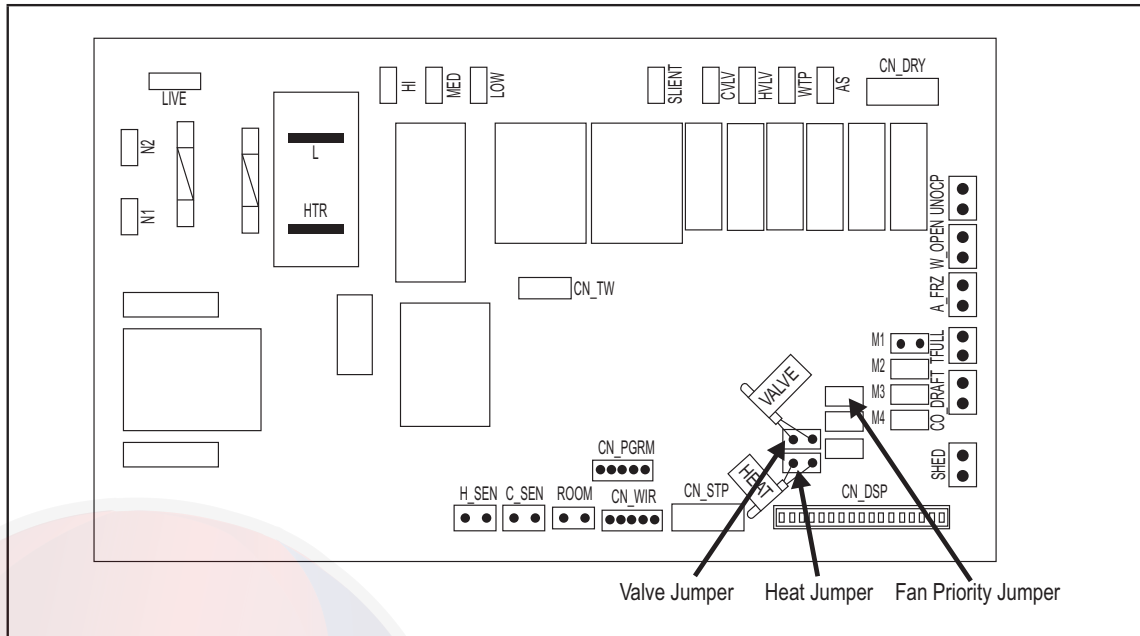

Jumper	With Jumper (Default)	Without Jumper
Fan Priority Jumper	User set speed or lower fan if auto mode is selected	Fan Stop when thermostat cat off
Heat Jumper	For Heat pump	For Cooling only
Valve Jumper	For valve control	For valveless control

MCK-AW/EW 4 pipes system controller board setting

A) Model selection

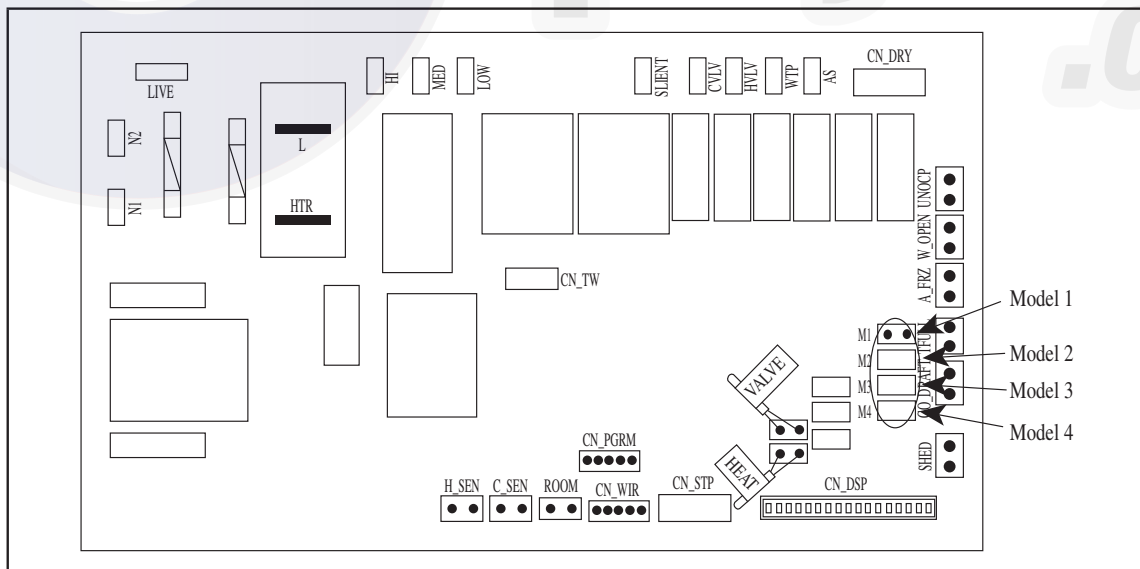

The standard controller board (W2.0/W3.0) comes with a default setting for model selection. Please select the model accordingly by using jumper.

System	Model	Function
2 Pipe System	M1 - Model 1	Cooling or Heating
	M2 - Model 2	Cooling or Heating with Auxiliary Heater
4 Pipe System	M3 - Model 3	Cooling Only with Boiler
	M4 - Model 4	Cooling or Heating with Boiler

C) Others

The controller board comes with other option.

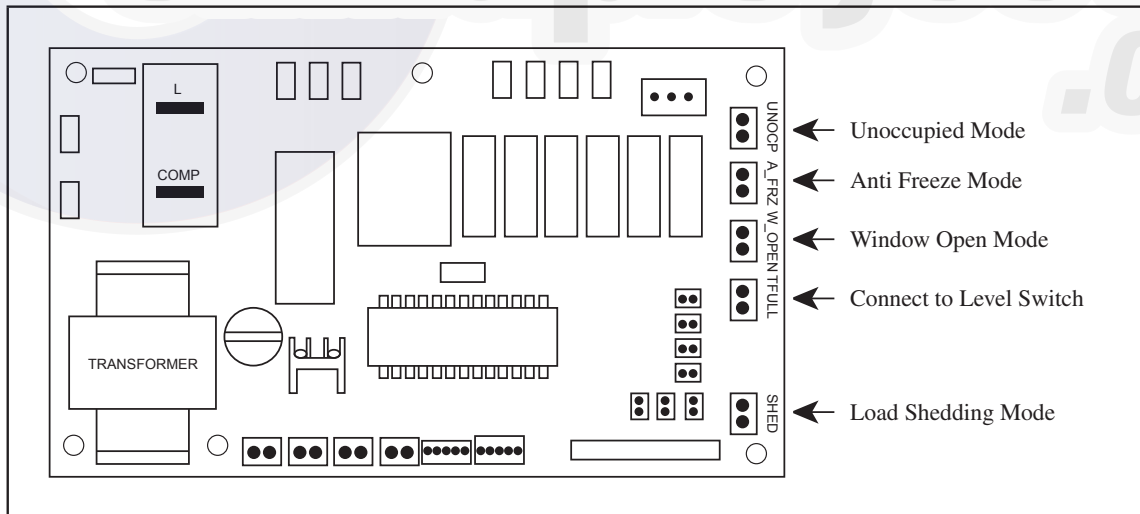

i) Unoccupied Mode

If the dry contact is closed, the Unoccupied mode is activated and vice versa. When Timer On is active, system goes back to Occupied mode.

The dry contact connection points can be connected parallel with other fan coil unit (FCU) boards. If the dry contact is closed, Unoccupied mode will be activated on all fan coil units that are connected parallel as shown in figure below.

- ii) **Anti Freeze Mode**
Anti Freeze operation has the highest priority among all unit operation. Anti Freeze operation will be activated only if dry contact is closed and vice versa.
- iii) **Window Open Mode**
The dry contact connection points can be connected in parallel with other fan coil unit (FCU) boards. If the dry contact is closed, Window open mode will be activated on all the fan coil units which are connected in parallel as shown in figure below.
- iv) **Load Shedding**
The dry contact connection points can be connected in parallel with other fan coil unit (FCU) boards. If the dry contact is closed, Load shedding mode will be activated on all the fan coil units which are connected in parallel as shown in figure below.

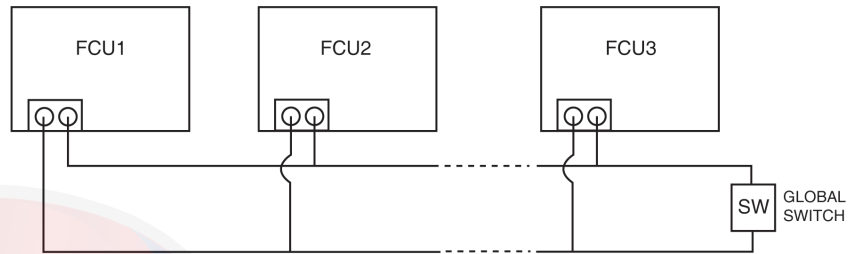

Global Unoccupied, Global Window Open and Global Load Shedding operation could also be activated via the network communication bus line by master controller with or without the above connection.

NOTE :

- i) Auto Fan Mode is only applicable in Model 3 only. (Cooling only with Boiler)
- ii) Fan mode is not available in valveless control.
- iii) Wired handset has an indoor room sensor. Avoid locating the wired handset at isolated places where room temperature reading will be inaccurate.

Cable Size

Model	Unit	MWM07/10/15/20/25LW	MWM301W	MCK020/025/030/ 040/050AW
Power supply cable size*	mm ²	1.5	2.5	1.5
Number of wire		3	3	3
Recommended fuse*	A	2	20	2

Model	Unit	MCK020/025/030/ 040/050AWH	MCM020/025/ 030/040/050DW	MCM015/020EW
Power supply cable size*	mm ²	1.5	1.5	2.5
Number of wire		3	3	3
Recommended fuse*	A	2	2	2

Model	Unit	MCM025EW	MCK10/15/20CW	MCK20/25/30/40/50EW
Power supply cable size*	mm ²	4.0	1.5	1.5
Number of wire		3	3	3
Recommended fuse*	A	2	2	2

Model	Unit	MCC10/15/20/25/28CW	MCC30/38/40CW	MCC50/60CW
Power supply cable size*	mm ²	1.5	1.5	1.5
Number of wire		3	3	3
Recommended fuse*	A	5	10	16

Model	Unit	MDB75/100BW	MDB125/150BW
Power supply cable size*	mm ²	1.5	1.5
Number of wire		3	4
Recommended fuse*	A	5	5

Important: * These values are for information only. They should be checked and selected to comply local or national codes and regulations. They are also subjected to the type of installation and size of conductors.

Sound Data

Sound Pressure Level

Model	Speed	1/1 Octave A-Weighted Sound Pressure (dBA), ref 20 μ Pa							Overall (dBA)	Noise Criteria
		125Hz	250Hz	500Hz	1kHz	2kHz	4kHz	8kHz		
MWM07LW	High	31	32	33	28	26	14	6	34	28
	Med	25	29	28	24	19	9	5	29	22
	Low	20	26	24	20	11	8	6	25	18
MWM10LW	High	30	33	33	32	28	17	8	35	31
	Med	26	29	30	27	21	11	7	30	25
	Low	19	25	25	21	14	6	6	25	19
MWM15LW	High	41	39	39	38	36	26	14	42	38
	Med	38	36	37	34	32	22	10	39	33
	Low	30	30	31	28	23	12	7	32	26
MWM20LW	High	37	38	38	39	33	22	11	42	38
	Med	33	35	35	35	29	17	8	38	34
	Low	29	33	32	31	23	12	7	34	30
MWM25LW	High	42	42	42	42	40	31	21	46	42
	Med	37	38	39	38	34	24	13	42	37
	Low	34	35	36	35	30	20	9	39	34
*MWM301W	High	42	46	45	44	41	35	28	49	43
	Med	40	45	44	43	38	33	27	47	42
	Low	37	43	43	40	35	30	26	45	39

Microphone position: 1m in front and 0.8m/*1m below the vertical centre line of the unit.

Model	Speed	1/1 Octave A-Weighted Sound Pressure (dBA), ref 20 μ Pa							Overall (dBA)	Noise Criteria
		125Hz	250Hz	500Hz	1kHz	2kHz	4kHz	8kHz		
MCK020AW/ AWH	High	46	45	40	38	32	21	14	42	37
	Med	44	43	37	33	28	18	12	39	32
	Low	43	42	35	31	26	17	11	37	31
MCK025AW/ AWH	High	48	46	43	39	33	27	19	45	38
	Med	45	43	40	35	29	21	15	42	35
	Low	43	42	38	32	27	19	14	40	33
*MCK030AW/ AWH	High	50	48	47	43	37	35	28	49	42
	Med	48	45	43	38	32	31	27	45	38
	Low	46	43	41	35	30	30	26	43	36
*MCK040AW/ AWH	High	50	49	49	46	39	38	31	51	45
	Med	48	47	47	43	36	34	25	48	42
	Low	46	45	46	41	34	30	23	46	41
*MCK050AW/ AWH	High	54	52	51	48	43	42	34	53	47
	Med	52	50	50	46	41	40	32	52	46
	Low	51	49	49	45	39	39	31	50	45

Microphone position: 1.4m/*1.5m below the face center of the air return of the unit.

Model	Speed	1/1 Octave A-Weighted Sound Pressure (dBA), ref 20 μ Pa							Overall (dBA)	Noise Criteria
		125Hz	250Hz	500Hz	1kHz	2kHz	4kHz	8kHz		
MCK010CW	High	44	45	40	36	26	19	10	42	35
	Med	40	38	34	28	19	9	7	35	29
	Low	37	32	27	20	14	7	7	29	21
MCK015CW	High	48	48	44	39	31	27	15	45	39
	Med	42	42	36	30	22	13	7	38	31
	Low	39	36	28	20	15	6	6	30	23
MCK020CW	High	52	51	46	41	34	31	19	48	41
	Med	44	43	39	33	26	18	8	40	33
	Low	41	39	35	28	22	11	7	36	30

Microphone position: 1.4m below the face center of the air return of the unit.

Model	Speed	1/1 Octave A-Weighted Sound Pressure (dBA), ref 20 μ Pa							Overall (dBA)	Noise Criteria
		125Hz	250Hz	500Hz	1kHz	2kHz	4kHz	8kHz		
MCK020EW	High	44	43	42	35	29	23	15	42	37
	Med	40	40	38	30	23	16	14	38	33
	Low	35	34	32	23	15	10	14	32	26
MCK025EW	High	48	47	45	39	34	28	17	46	40
	Med	44	42	42	34	28	21	10	42	37
	Low	39	37	36	26	19	10	6	35	31
*MCK030EW	High	49	48	46	42	37	35	22	48	41
	Med	44	44	42	36	32	27	14	43	37
	Low	41	39	37	31	26	17	8	38	32
*MCK040EW	High	51	49	49	45	37	36	24	50	45
	Med	48	46	47	40	33	31	18	47	43
	Low	44	42	43	35	28	23	10	43	38
*MCK050EW	High	53	54	50	47	39	38	28	52	46
	Med	49	48	47	43	36	35	25	49	43
	Low	46	45	44	39	32	30	22	45	39

Microphone position: 1.4m/*1.5m below the face center of the air return of the unit.

Model	Speed	1/1 Octave A-Weighted Sound Pressure (dBA), ref 20 μ Pa							Overall (dBA)	Noise Criteria
		125Hz	250Hz	500Hz	1kHz	2kHz	4kHz	8kHz		
MCM020DW	High	45	46	47	46	41	38	29	50	45
	Med	42	43	45	42	38	34	24	47	41
	Low	36	37	39	35	31	24	15	40	34
MCM025DW	High	48	51	51	50	45	41	33	54	49
	Med	47	50	50	49	44	40	32	53	48
	Low	45	47	48	47	41	36	27	50	46
*MCM030DW	High	45	48	48	47	43	33	24	51	46
	Med	44	47	47	46	42	32	23	50	45
	Low	43	45	45	44	39	29	20	48	43
*MCM040DW	High	51	53	51	50	47	37	30	54	49
	Med	48	51	50	49	46	36	28	53	48
	Low	46	50	49	48	44	35	27	52	47
*MCM050DW	High	51	53	51	50	47	37	30	54	49
	Med	48	51	50	49	46	36	28	53	48
	Low	46	50	49	48	44	35	27	52	47

Microphone position: 1m in front of the unit and 0.8m/*1m below the air discharge opening.

Sound Data

Model	Speed	1/1 Octave A-Weighted Sound Pressure (dBA), ref 20 μ Pa							Overall (dBA)	Noise Criteria
		125Hz	250Hz	500Hz	1kHz	2kHz	4kHz	8kHz		
MCM15EW	High	42	46	49	44	43	36	31	50	45
	Med	36	40	43	37	36	27	20	43	38
	Low	34	38	41	34	33	23	15	41	36
MCM20EW	High	45	47	51	48	47	40	34	53	48
	Med	43	46	49	46	44	37	31	51	45
	Low	42	46	47	44	42	35	27	49	43
MCM25EW	High	47	50	53	50	50	43	39	56	51
	Med	44	46	49	46	45	38	33	51	46
	Low	38	40	43	38	37	28	22	44	38

Microphone position: 1m in front of the unit and 1m below the air discharge opening.

Model	Speed	1/1 Octave A-Weighted Sound Pressure (dBA), ref 20 μ Pa							Overall (dBA)	Noise Criteria
		125Hz	250Hz	500Hz	1kHz	2kHz	4kHz	8kHz		
MCC010CW	High	43	35	35	30	26	18	13	36	30
	Med	43	34	34	28	25	17	12	35	29
	Low	42	31	31	27	22	14	9	33	25
MCC015CW	High	46	40	40	33	29	21	17	40	35
	Med	45	38	38	31	27	18	14	38	33
	Low	40	33	33	26	21	11	9	33	28
MCC020CW	High	47	41	43	35	31	24	19	42	38
	Med	47	41	41	34	31	23	18	41	36
	Low	47	39	39	33	29	21	16	40	34
MCC025CW	High	48	41	40	35	31	24	19	41	35
	Med	47	39	39	34	29	22	17	40	34
	Low	44	35	35	30	25	17	12	36	30
MCC028CW	High	45	42	39	35	31	26	22	41	34
	Med	42	38	37	32	28	22	17	38	32
	Low	36	33	33	27	23	16	11	34	27
MCC030CW	High	50	45	43	42	37	31	26	46	41
	Med	45	40	40	38	32	26	20	42	37
	Low	42	36	37	33	28	22	15	38	32
MCC038CW	High	54	51	48	46	41	36	31	51	45
	Med	51	48	46	45	37	32	26	48	44
	Low	47	45	44	41	34	28	22	45	40
MCC040CW	High	54	47	47	45	39	35	29	49	44
	Med	49	42	43	41	35	31	24	45	40
	Low	45	39	41	37	30	26	18	41	36
MCC050CW	High	54	49	49	48	43	37	32	52	47
	Med	53	47	46	47	40	35	29	50	46
	Low	51	45	44	44	36	32	26	47	43
MCC060CW	High	55	49	49	50	44	37	33	53	49
	Med	53	46	47	47	39	34	28	50	46
	Low	51	43	44	43	35	30	24	47	42

Microphone position: 1.5m below the centre of the unit.

(Tested with 2m length duct at the air discharge outlet and air return inlet)

Model	Speed	1/1 Octave A-Weighted Sound Pressure (dBA), ref 20 μ Pa							Overall (dBA)	Noise Criteria
		125Hz	250Hz	500Hz	1kHz	2kHz	4kHz	8kHz		
MDB075BW	High	57	50	47	44	40	35	24	50	43
	Med	57	46	44	40	35	30	17	46	41
	Low	48	42	41	35	30	24	6	42	36
MDB100BW	High	57	53	50	50	44	40	31	54	49
	Med	55	51	49	48	42	38	28	52	47
	Low	54	50	48	46	40	35	25	50	45
MBD125BW	High	57	55	56	53	51	46	38	58	53
MDB150BW	High	57	55	56	53	51	46	38	58	53

Microphone position: 1m in front of the unit and center of the unit.
1m away from every side of the unit and 1m above floor level.

Sound Power Level

Model	Speed	1/1 Octave Sound Power Level (dB, reference 1pW)							Overall A (dBA)
		125Hz	250Hz	500Hz	1kHz	2kHz	4kHz	8kHz	
MWM07LW	High	40	43	44	41	36	23	19	45
	Med	39	40	40	37	29	20	28	41
	Low	38	37	35	32	21	16	23	36
MWM10LW	High	48	45	46	44	38	28	20	48
	Med	48	41	42	40	32	18	19	44
	Low	45	37	38	35	24	14	18	39
MWM15LW	High	48	50	52	51	46	38	26	55
	Med	45	47	49	47	41	32	22	50
	Low	43	42	44	41	34	22	18	45
MWM20LW	High	50	51	53	51	42	33	20	55
	Med	47	49	50	48	38	27	17	51
	Low	45	46	47	44	33	22	17	47
MWM25LW	High	53	55	55	55	50	40	26	59
	Med	48	51	52	50	42	33	21	54
	Low	45	48	50	47	38	29	18	51
MWM301W	High	50	55	62	59	54	43	32	64
	Med	50	53	61	57	51	41	30	61
	Low	48	51	58	54	48	37	24	58

Measured In Reverberation Chamber

Sound Data

Model	Speed	1/1 Octave Sound Power Level (dB, reference 1pW)							Overall A (dBA)
		125Hz	250Hz	500Hz	1kHz	2kHz	4kHz	8kHz	
MCK020AW/ AWH	High	59	57	50	46	42	32	28	52
	Med	58	56	47	43	38	31	27	50
	Low	57	55	46	42	36	30	26	49
MCK025AW/ AWH	High	60	58	52	49	43	37	31	55
	Med	57	55	49	45	39	33	28	52
	Low	55	53	47	42	37	32	27	50
MCK030AW/ AWH	High	64	62	57	54	47	35	40	60
	Med	60	58	54	49	42	41	39	56
	Low	59	57	52	47	40	39	37	54
MCK040AW/ AWH	High	64	62	60	56	49	46	37	61
	Med	62	60	58	53	46	42	34	59
	Low	61	59	57	51	44	38	33	57
MCK050AW/ AWH	High	67	65	63	59	53	52	44	64
	Med	66	64	61	57	51	51	42	63
	Low	65	63	60	56	49	49	41	61

Measured In Reverberation Chamber

Model	Speed	1/1 Octave Sound Power Level (dB, reference 1pW)							Overall A (dBA)
		125Hz	250Hz	500Hz	1kHz	2kHz	4kHz	8kHz	
MCK010CW	High	53	56	49	43	35	28	21	52
	Med	47	49	42	35	26	20	19	45
	Low	43	44	36	27	19	14	19	39
MCK015CW	High	56	58	55	50	42	38	29	56
	Med	50	51	48	41	32	26	20	49
	Low	47	49	45	37	27	20	19	45
MCK020CW	High	56	58	55	50	42	38	29	56
	Med	50	51	48	41	32	26	20	49
	Low	47	49	45	37	27	20	19	45

Measured In Reverberation Chamber

Model	Speed	1/1 Octave Sound Power Level (dB, reference 1pW)							Overall A (dBA)
		125Hz	250Hz	500Hz	1kHz	2kHz	4kHz	8kHz	
MCK020EW	High	53	54	52	45	35	31	19	52
	Med	50	51	48	39	29	23	17	47
	Low	46	45	42	32	22	14	17	41
MCK025EW	High	58	58	55	48	39	37	25	55
	Med	53	53	51	43	33	29	18	51
	Low	49	48	45	36	28	21	17	45
*MCK030EW	High	59	61	56	51	43	44	31	58
	Med	54	55	52	46	38	36	23	53
	Low	50	50	47	40	32	26	17	47
*MCK040EW	High	60	60	58	54	45	45	33	59
	Med	57	57	56	50	41	40	26	56
	Low	53	53	51	44	35	32	19	51
*MCK050EW	High	64	66	61	55	48	48	37	62
	Med	59	60	57	52	44	44	32	58
	Low	56	56	54	48	40	38	25	55

Measured In Reverberation Chamber

Model	Speed	1/1 Octave Sound Power Level (dB, reference 1pW)							Overall A (dBA)
		125Hz	250Hz	500Hz	1kHz	2kHz	4kHz	8kHz	
MCM020DW	High	58	62	58	56	52	47	39	61
	Med	56	60	57	54	50	44	35	59
	Low	52	55	51	48	43	34	28	53
MCM025DW	High	64	68	64	63	57	54	47	67
	Med	63	67	63	62	56	53	46	66
	Low	61	64	61	60	53	49	41	63
MCM030DW	High	62	65	62	60	54	46	38	64
	Med	61	64	61	59	53	45	37	63
	Low	58	62	59	57	51	42	34	61
MCM040DW	High	67	70	64	63	59	50	44	67
	Med	64	68	63	62	58	49	42	66
	Low	62	67	62	61	56	48	41	65
MCM050DW	High	67	70	64	63	59	50	44	67
	Med	64	68	63	62	58	49	42	66
	Low	62	67	62	61	56	48	41	65

Measured In Reverberation Chamber

Model	Speed	1/1 Octave Sound Power Level (dB, reference 1pW)							Overall A (dBA)
		125Hz	250Hz	500Hz	1kHz	2kHz	4kHz	8kHz	
MCM15EW	High	26	37	45	44	44	37	30	50
	Med	20	31	40	37	37	28	19	43
	Low	18	29	37	34	34	24	14	41
MCM20EW	High	N/A	N/A	N/A	N/A	N/A	N/A	N/A	53
	Med	N/A	N/A	N/A	N/A	N/A	N/A	N/A	51
	Low	N/A	N/A	N/A	N/A	N/A	N/A	N/A	49
MCM25EW	High	31	42	50	50	51	44	38	56
	Med	28	37	46	46	46	39	32	51
	Low	22	32	40	38	38	29	20	44

Measured In Reverberation Chamber

Sound Data

Model	Speed	1/1 Octave Sound Power Level (dB, reference 1pW)							Overall A (dBA)
		125Hz	250Hz	500Hz	1kHz	2kHz	4kHz	8kHz	
MCC010CW	High	57	54	52	52	51	46	44	57
	Med	54	51	50	49	48	43	39	54
	Low	51	48	47	46	44	39	35	51
MCC015CW	High	60	58	57	56	54	48	44	61
	Med	56	55	54	53	50	44	40	58
	Low	51	50	49	48	44	37	34	52
MCC020CW	High	63	62	61	61	59	55	51	65
	Med	61	61	59	60	58	53	49	64
	Low	57	56	56	56	53	48	44	60
MCC025CW	High	63	62	61	62	59	56	53	66
	Med	61	60	59	60	57	53	50	64
	Low	58	57	56	57	54	49	47	61
MCC028CW	High	59	61	58	61	57	54	52	64
	Med	56	57	55	57	54	50	48	61
	Low	52	53	51	53	50	45	41	57
MCC030CW	High	65	66	68	69	65	63	60	73
	Med	61	62	64	65	61	58	55	69
	Low	56	58	60	61	57	53	49	64
MCC038CW	High	70	70	71	72	68	66	64	76
	Med	67	67	68	70	65	62	60	73
	Low	65	64	65	66	61	58	56	70
MCC040CW	High	65	68	70	72	68	66	64	76
	Med	65	65	67	68	64	62	59	72
	Low	59	61	63	64	60	59	54	68
MCC050CW	High	67	69	71	72	69	66	64	76
	Med	66	66	69	69	66	63	61	73
	Low	63	64	66	67	62	60	57	70
MCC060CW	High	69	70	72	74	71	69	68	78
	Med	69	68	70	71	67	65	63	75
	Low	64	65	67	67	63	61	59	71

Measured In Reverberation Chamber

Model	Speed	1/1 Octave Sound Power Level (dB, reference 1pW)							Overall A (dBA)
		125Hz	250Hz	500Hz	1kHz	2kHz	4kHz	8kHz	
MDB075BW	High	68	67	72	70	65	65	57	74
	Med	64	64	68	65	61	59	51	69
	Low	61	60	63	60	56	53	43	65
MDB100BW	High	71	71	74	74	70	70	63	78
	Med	70	69	73	72	68	68	60	76
	Low	67	67	71	69	65	64	56	73
MDB125BW	High	75	76	75	72	69	65	60	77
MDB150BW	High	75	76	75	72	69	65	60	77

Measured In Reverberation Chamber

NC Curve

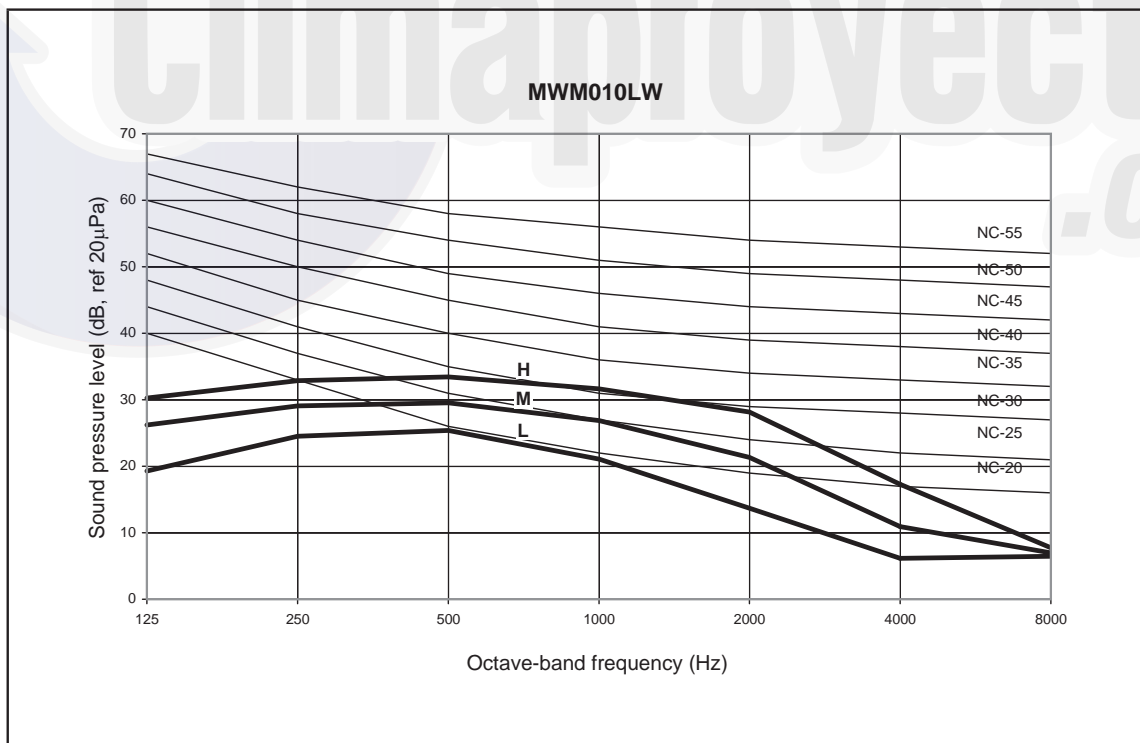
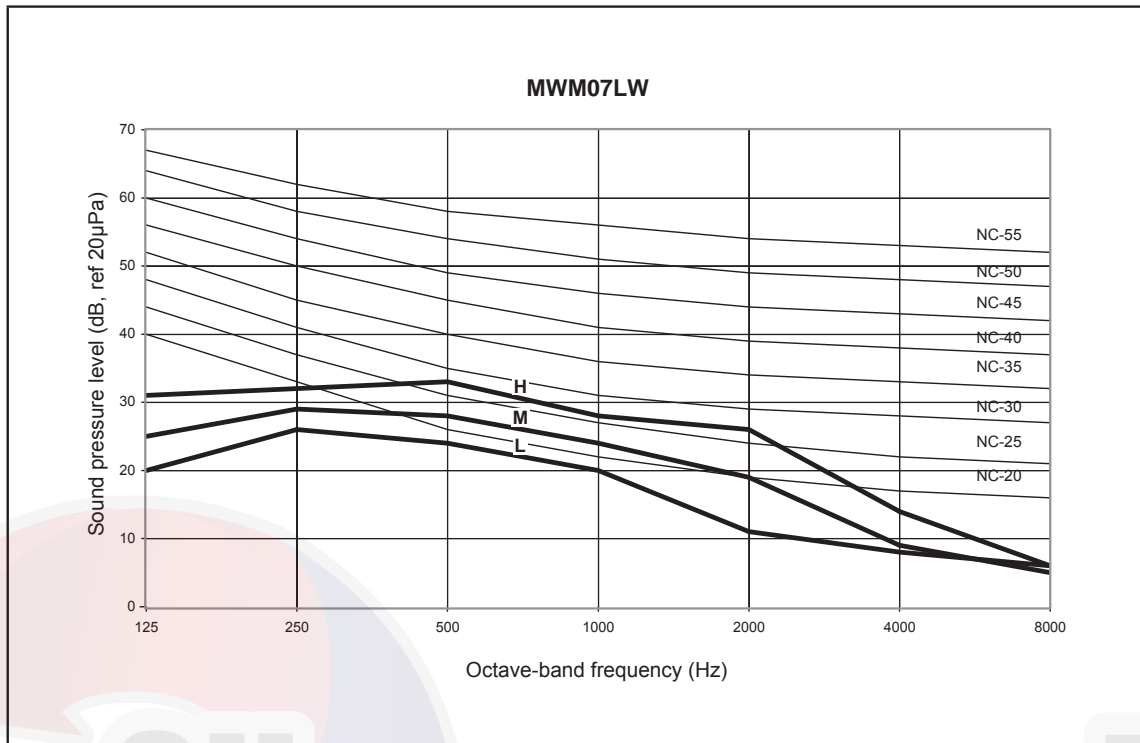

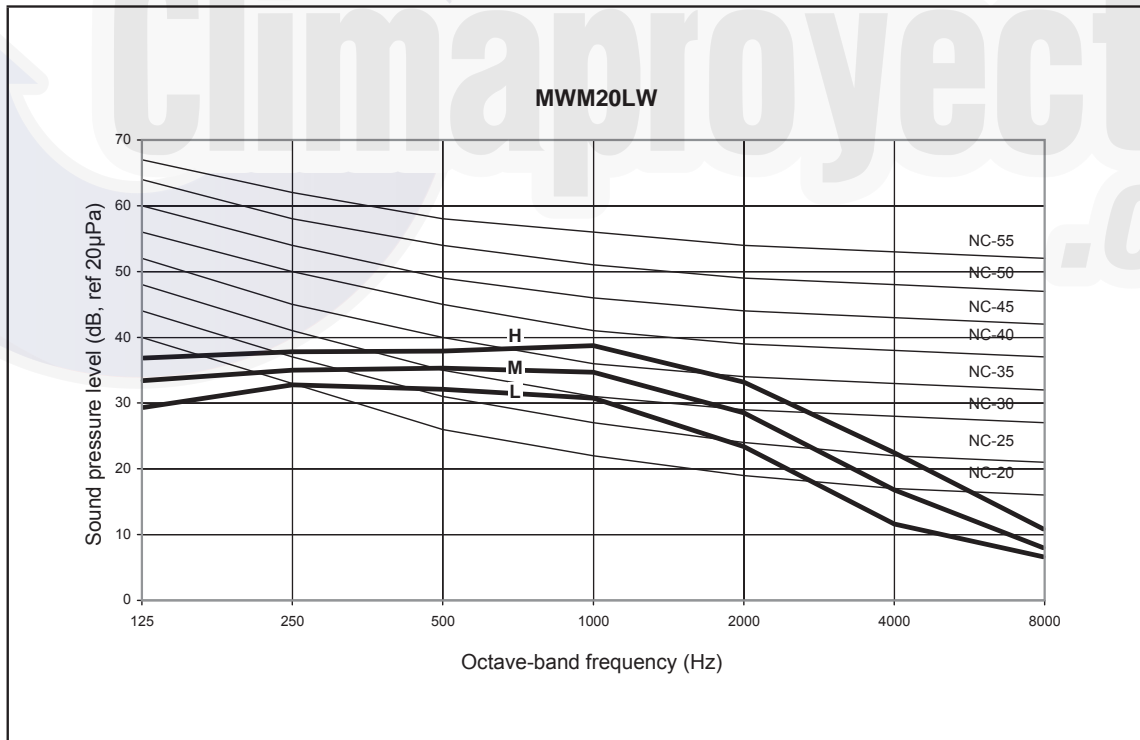
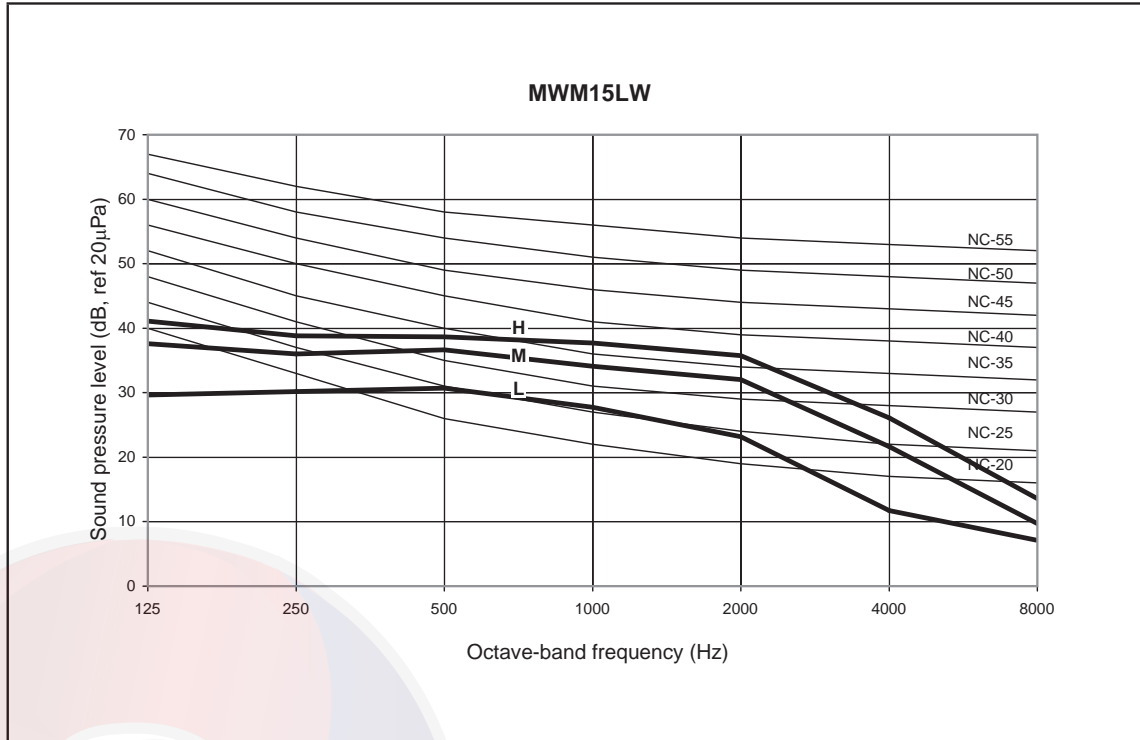

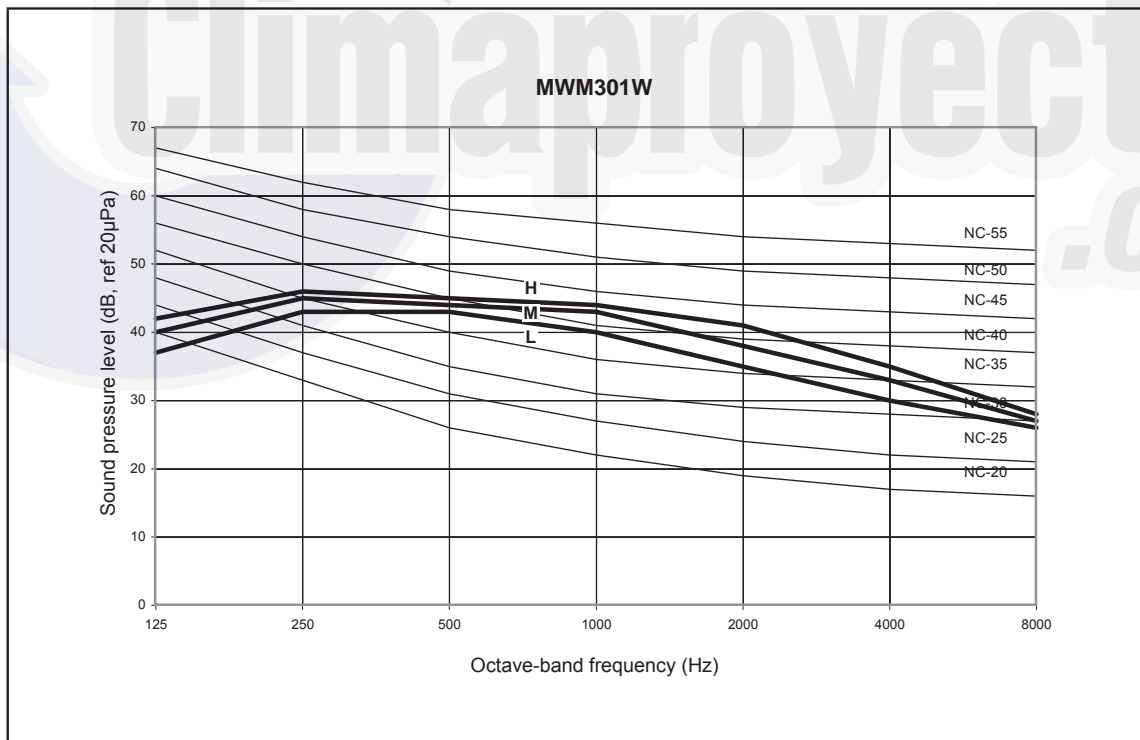
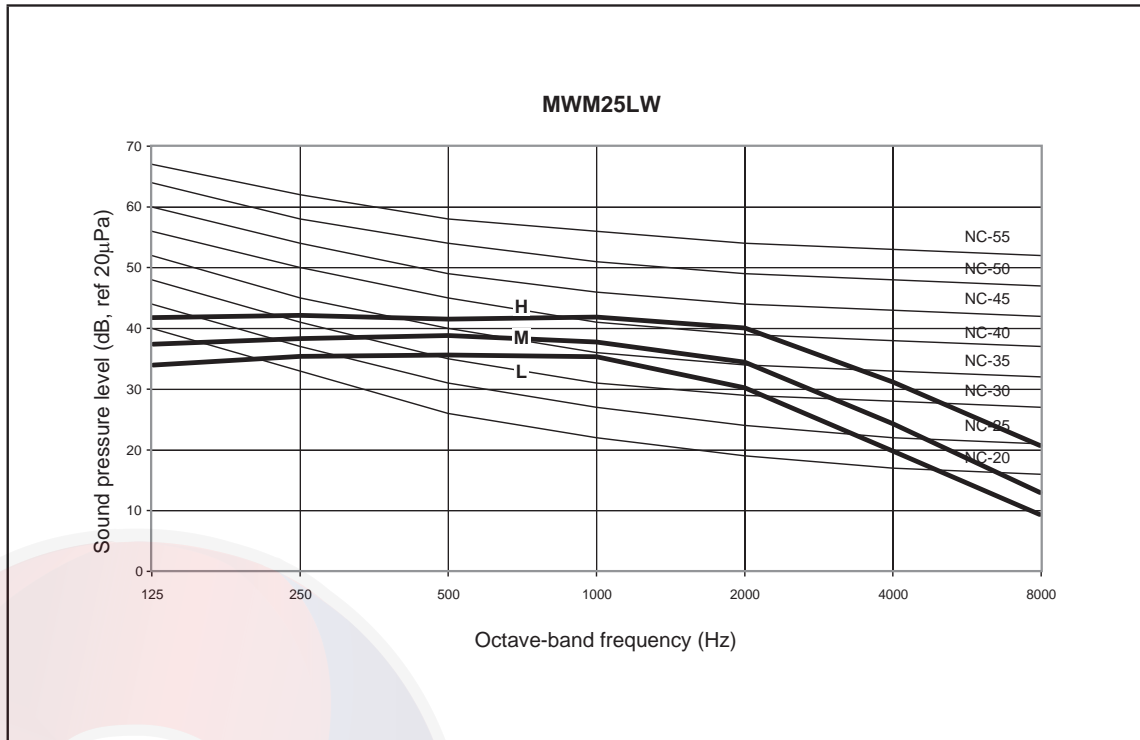

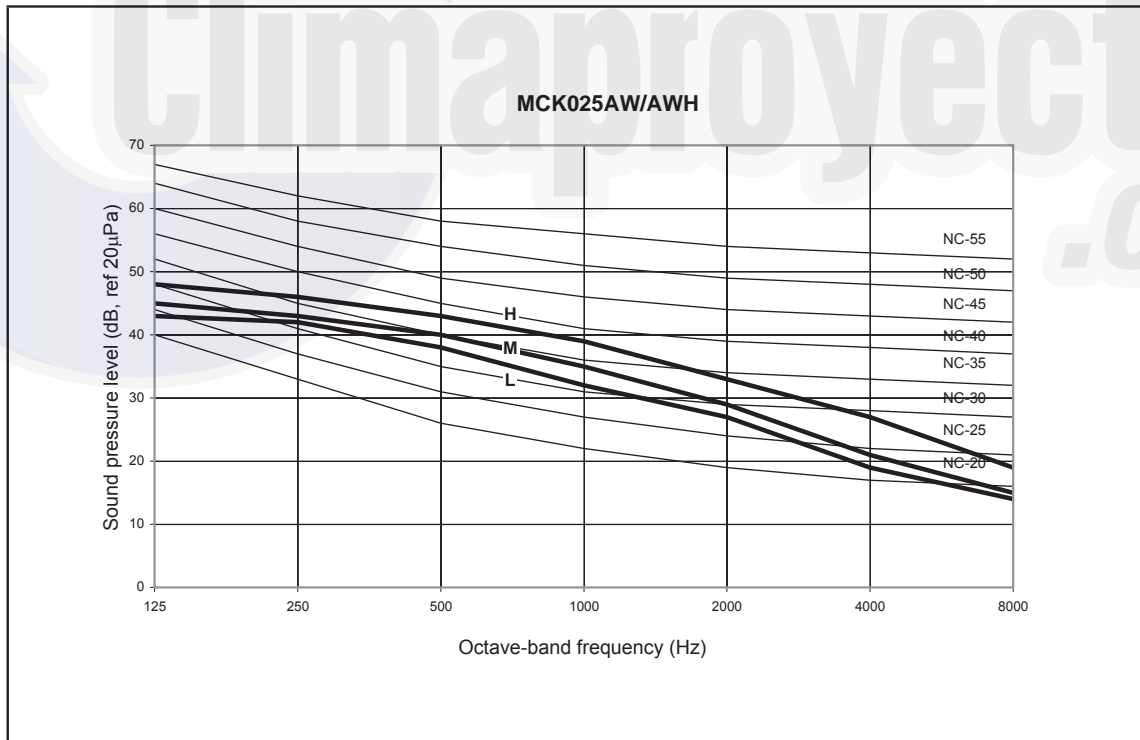
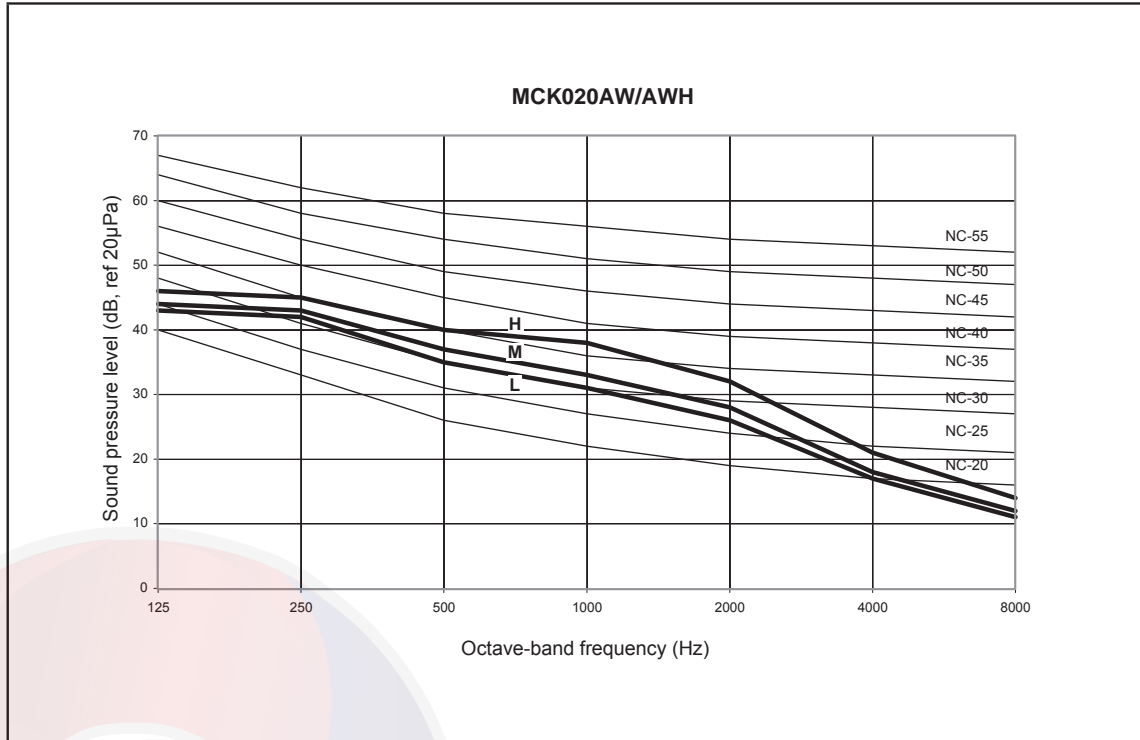

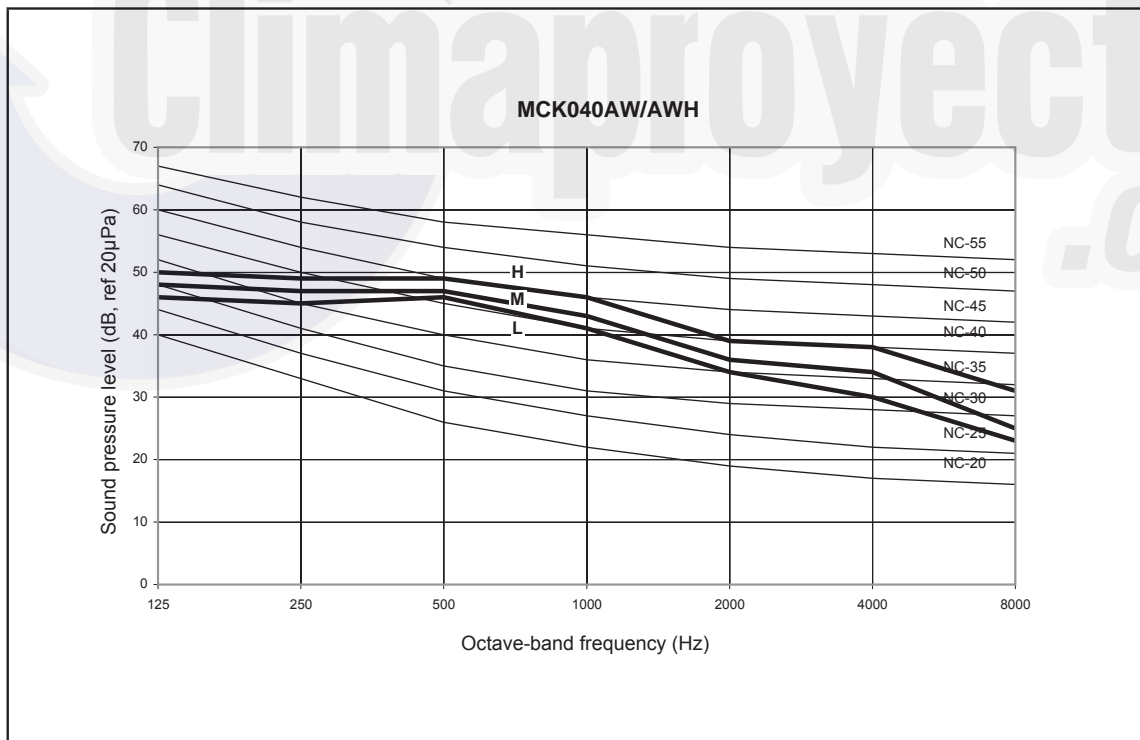
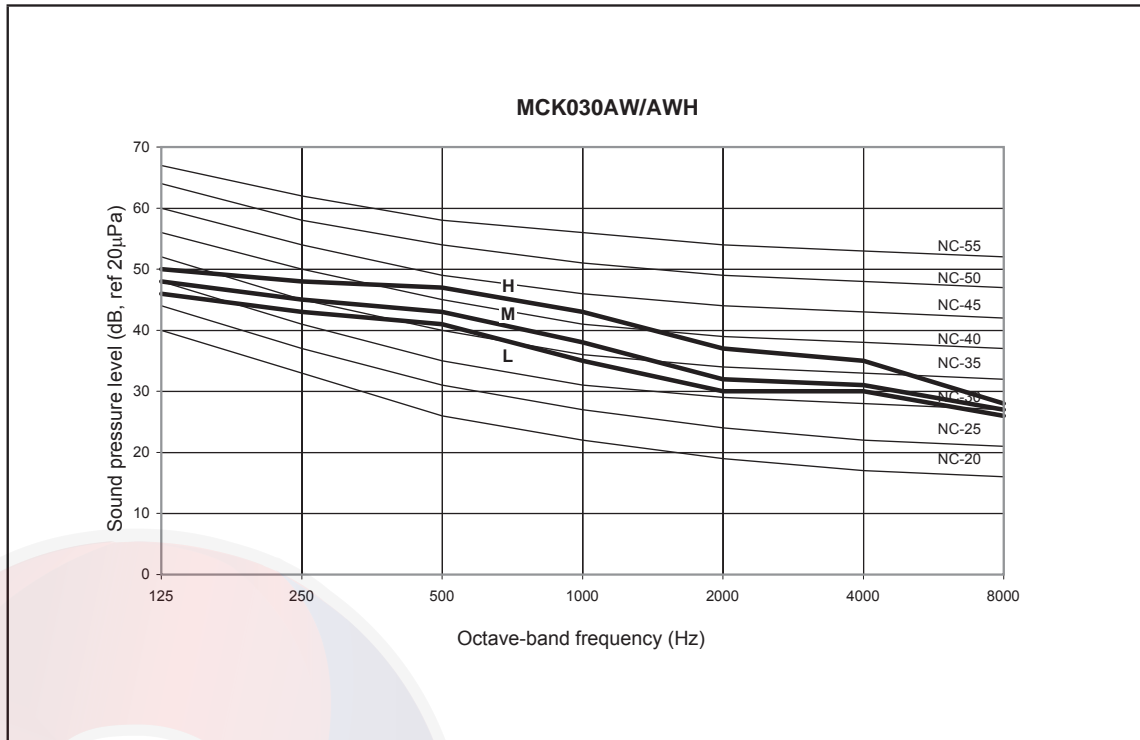

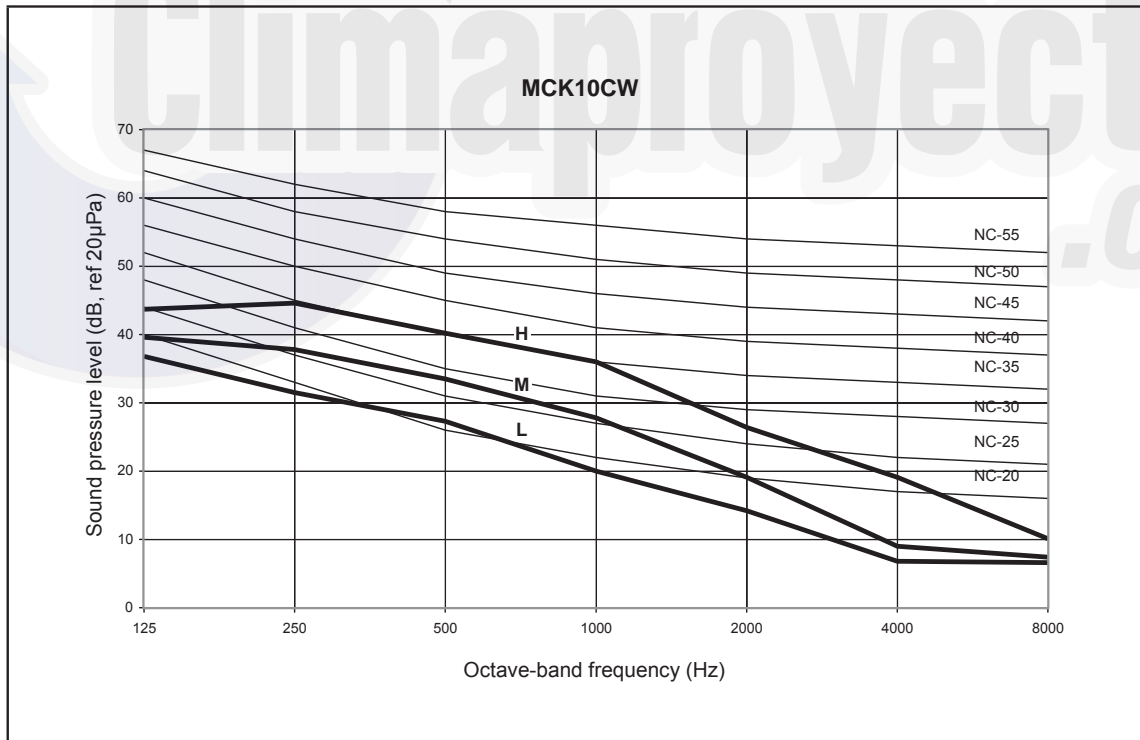
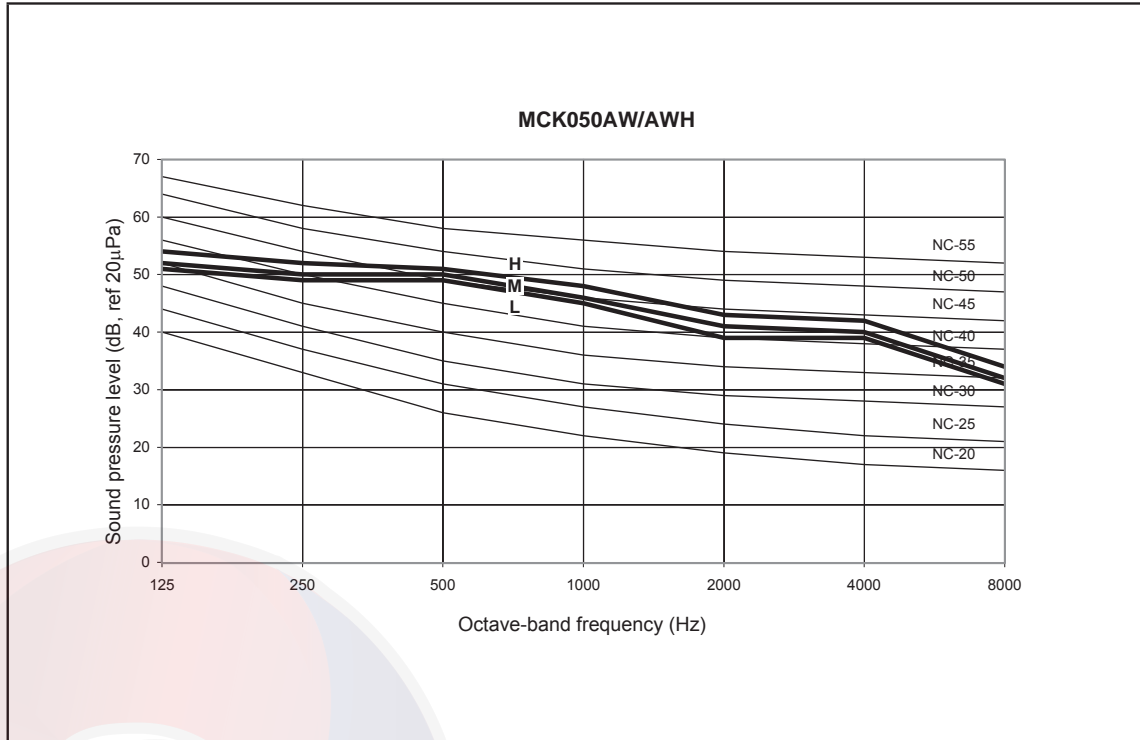

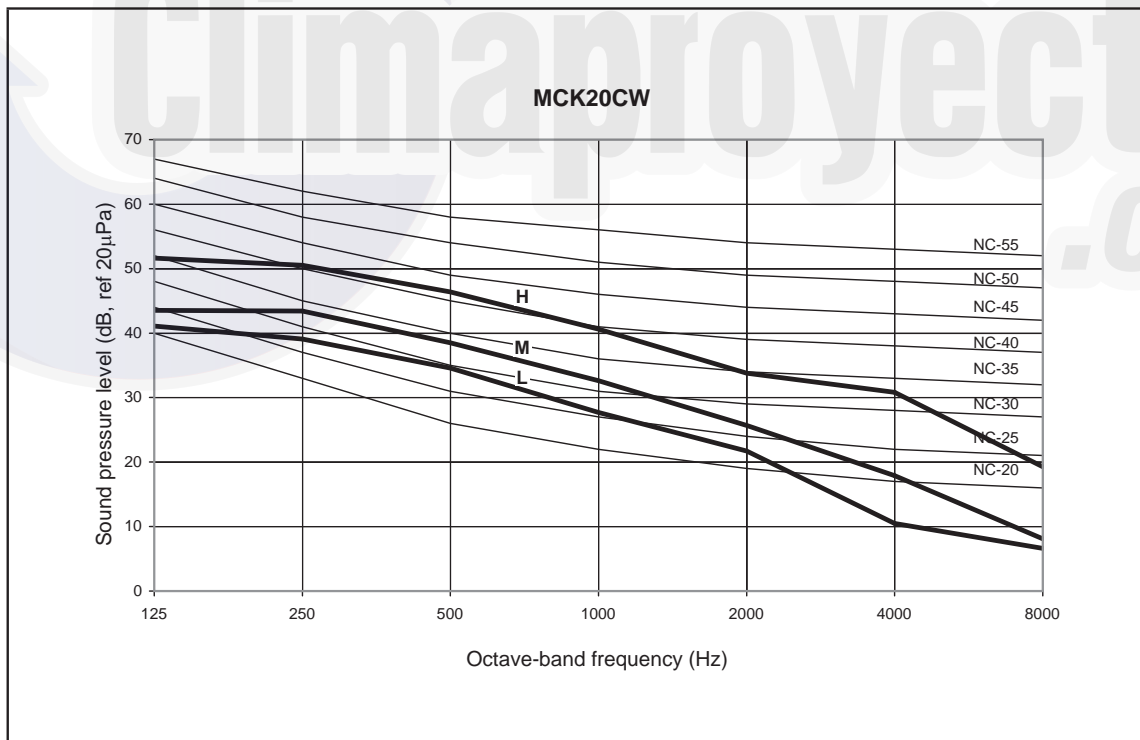
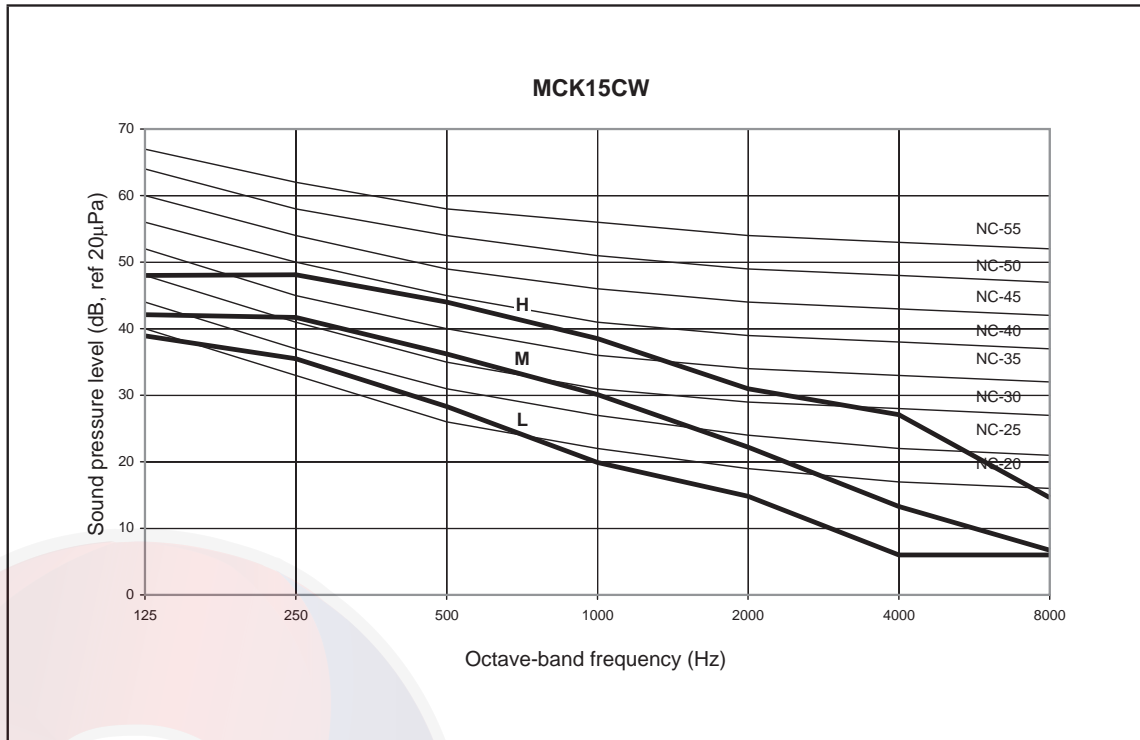

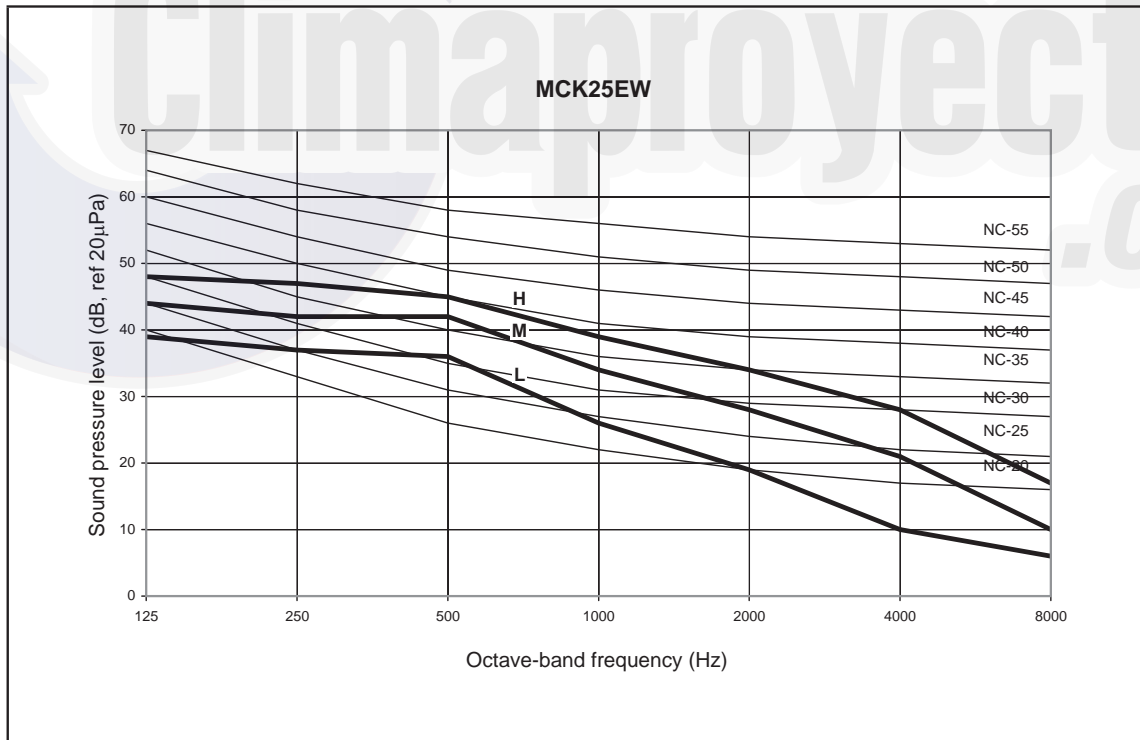
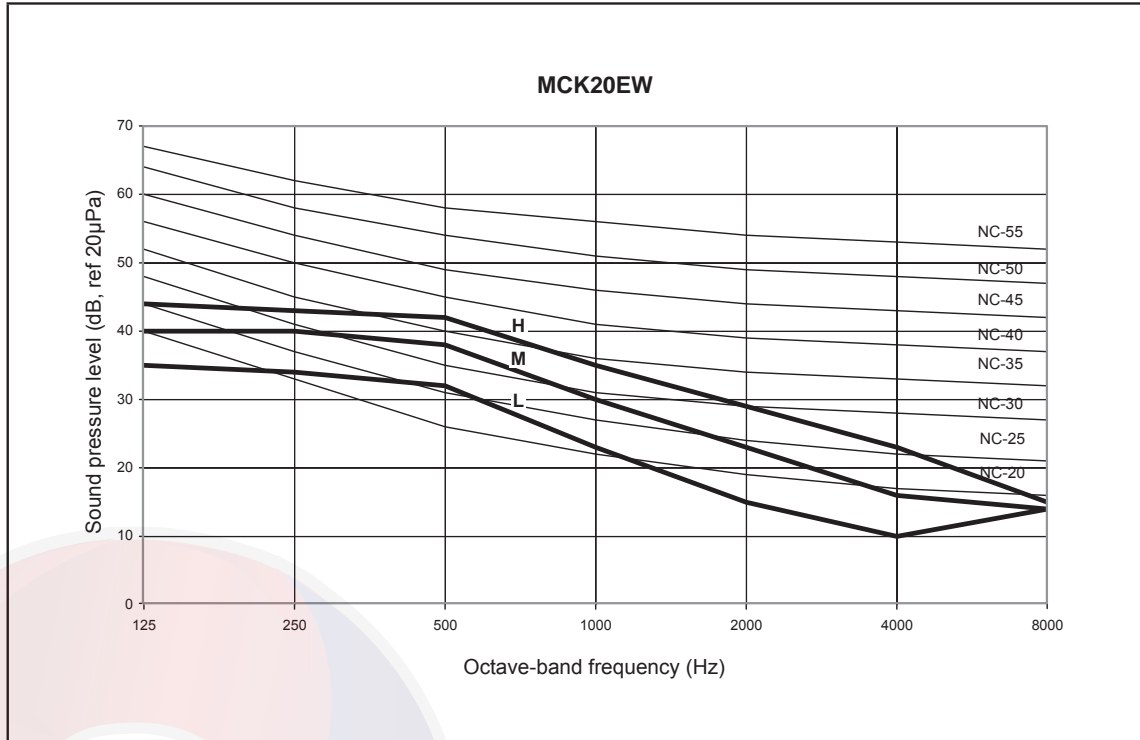

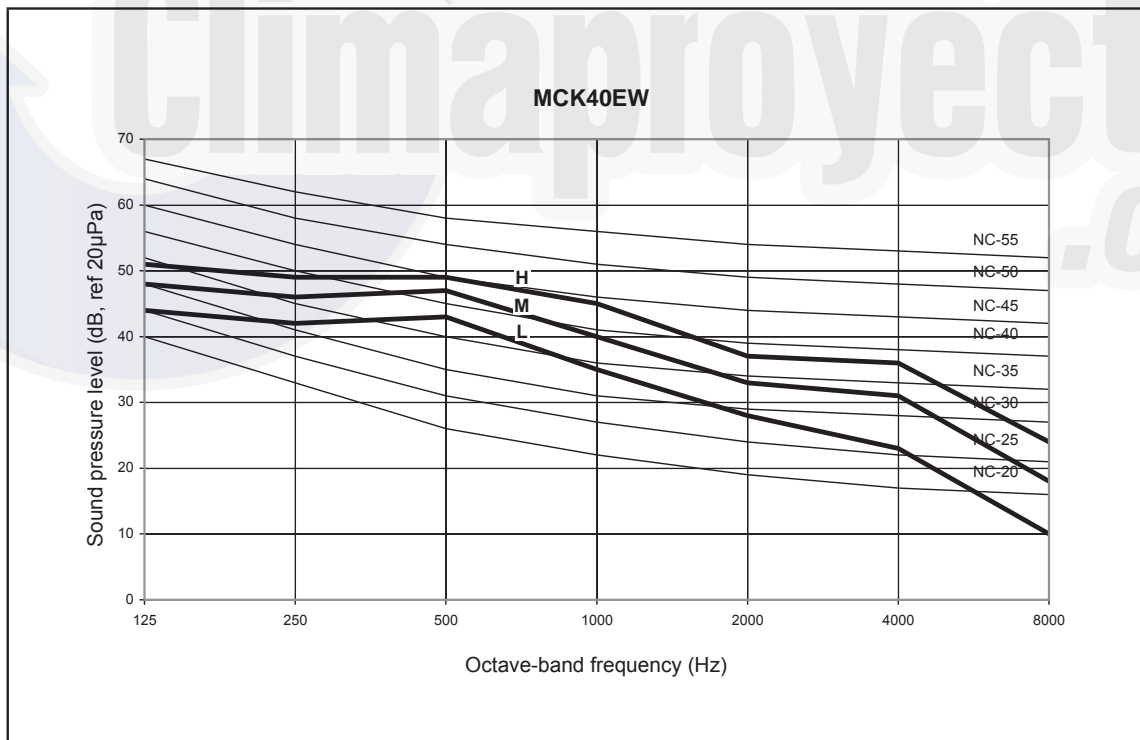
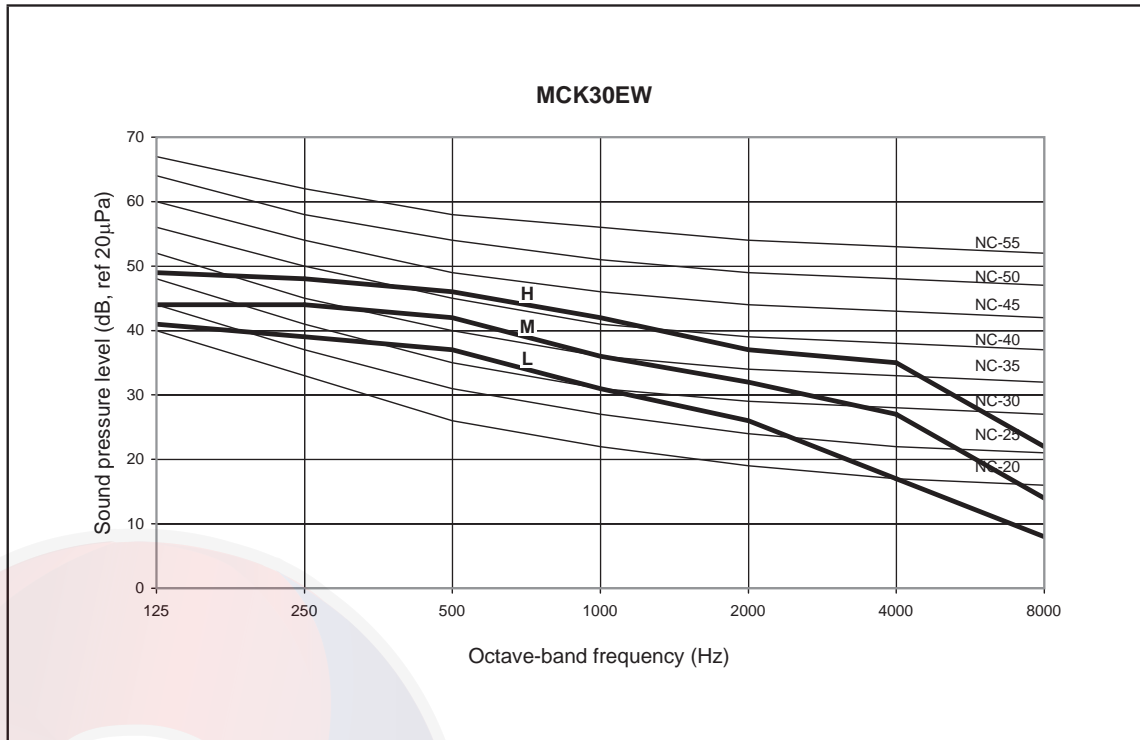

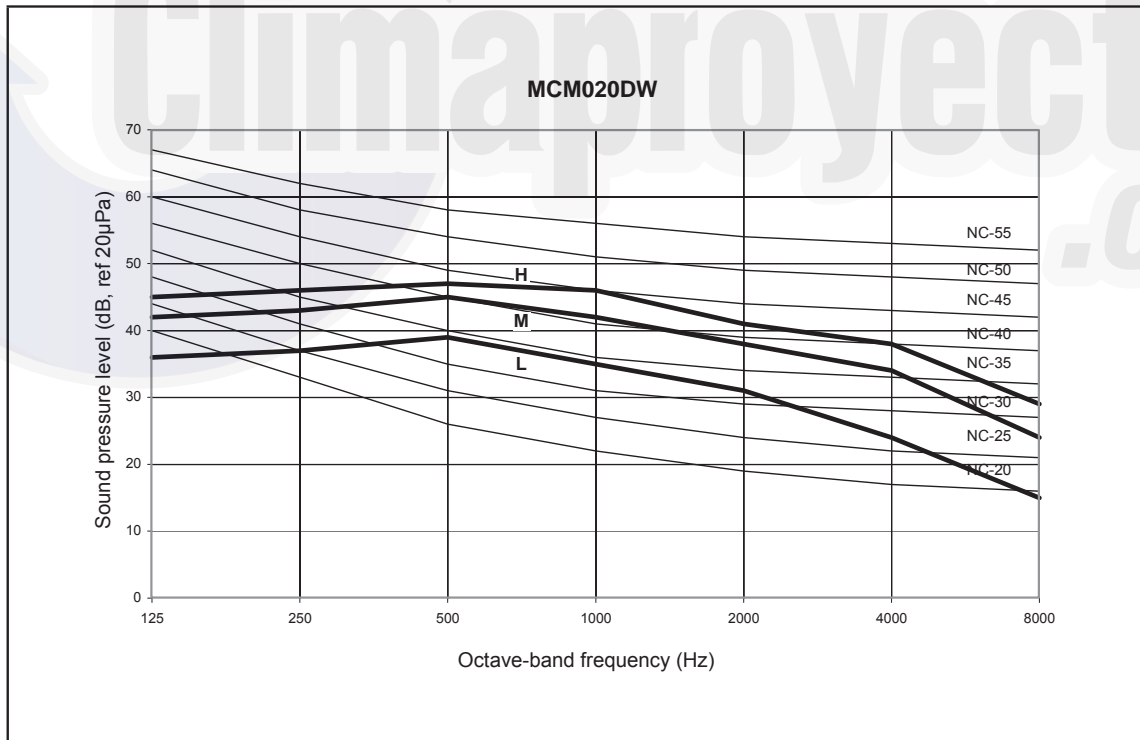
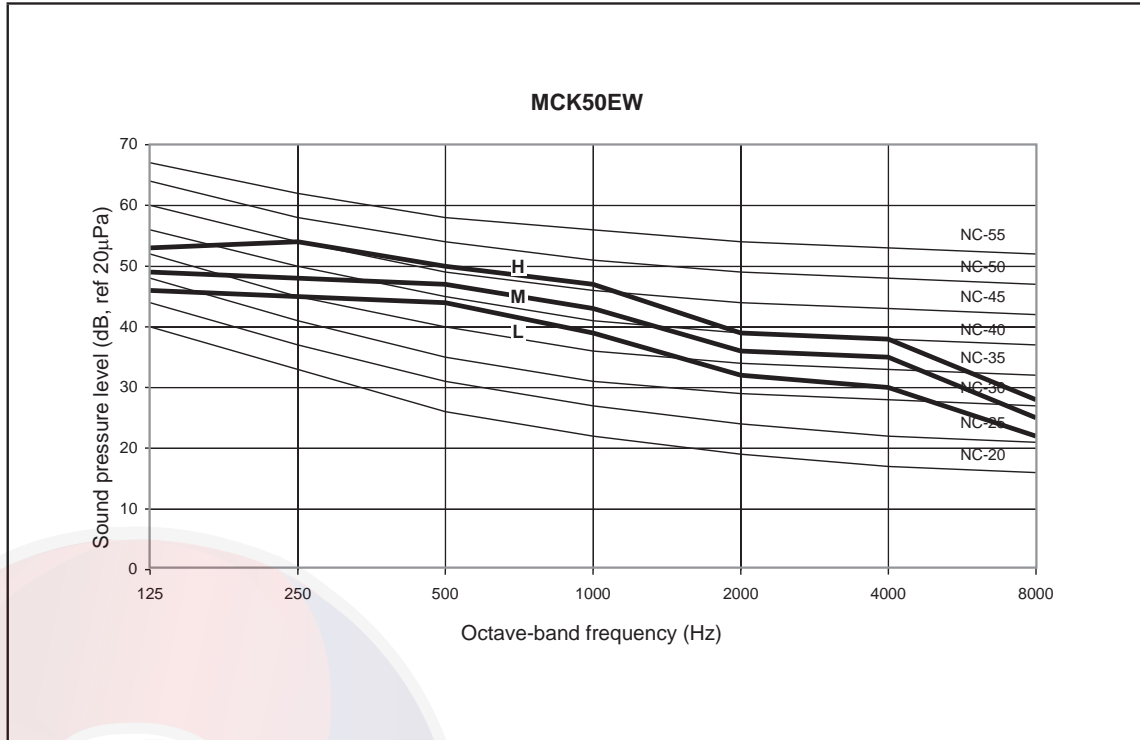

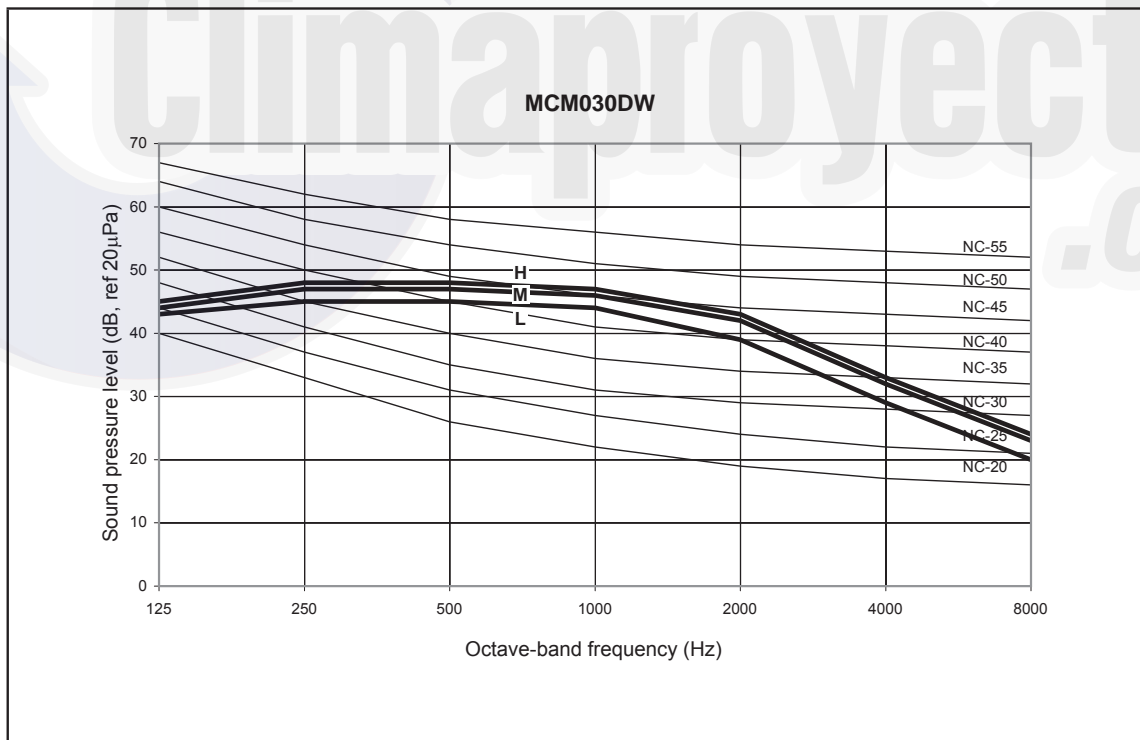
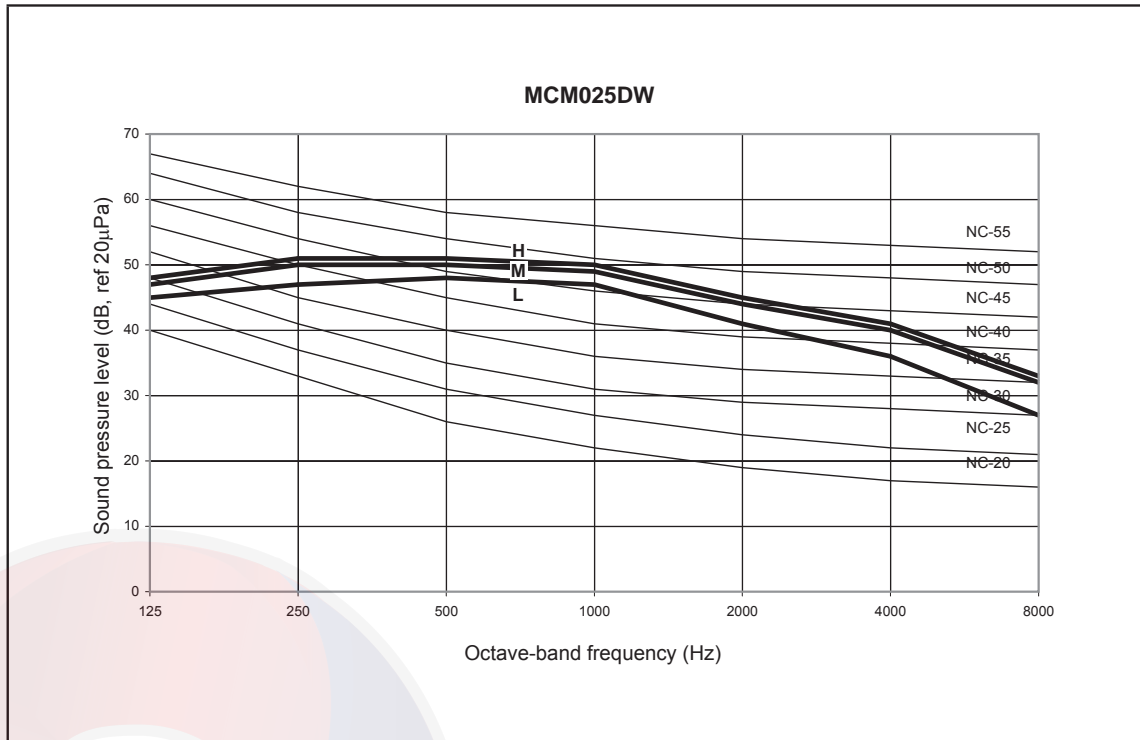

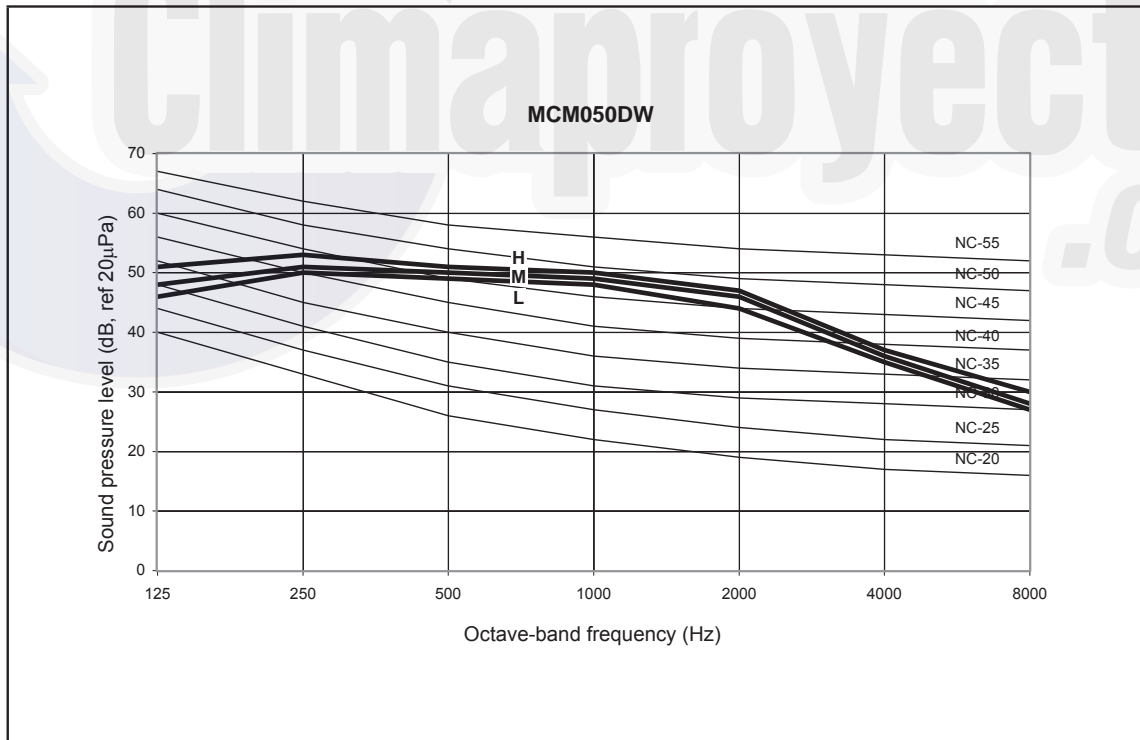
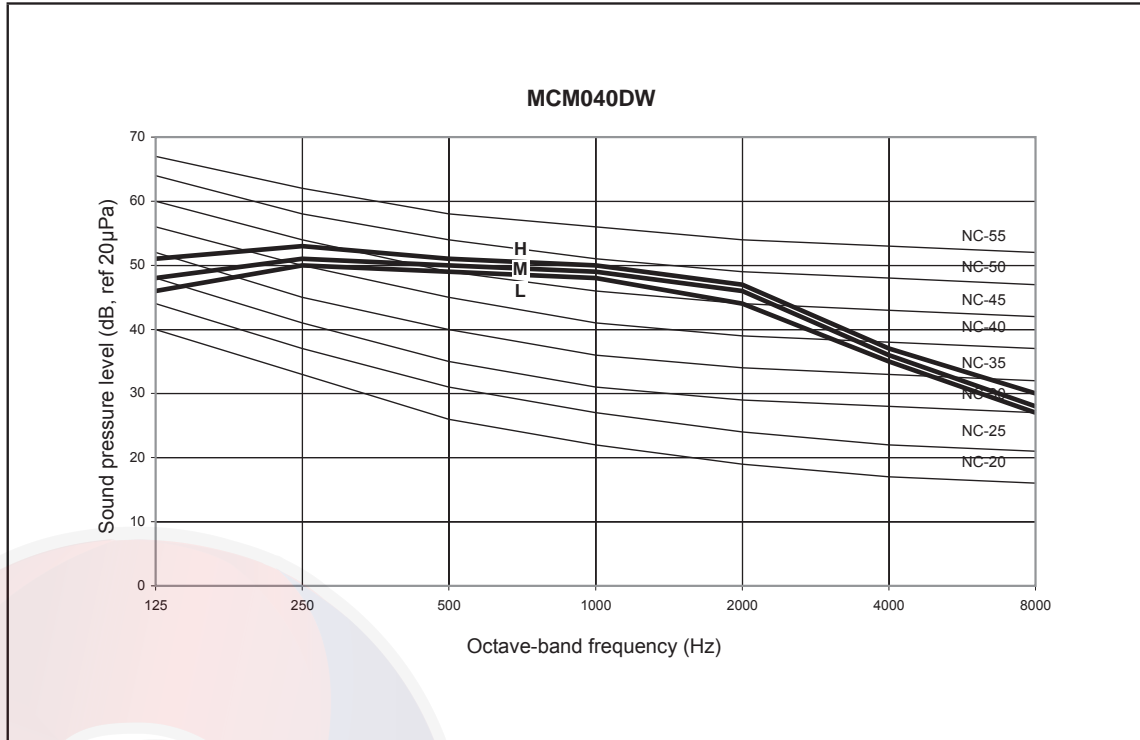

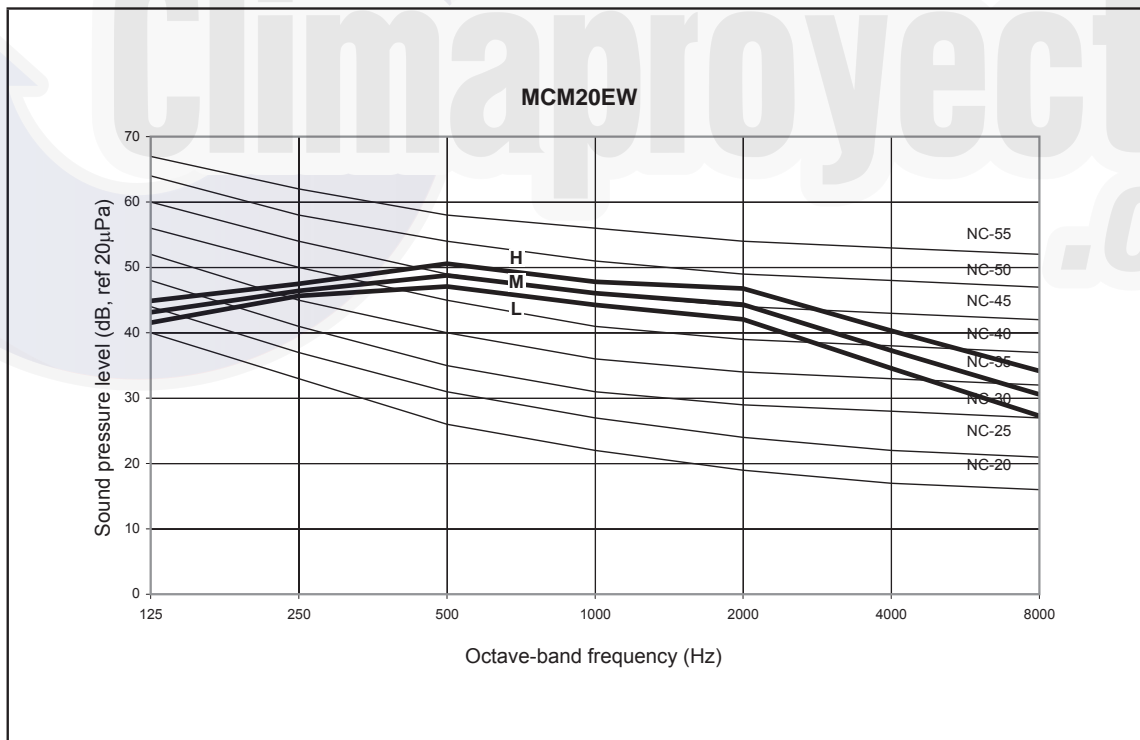
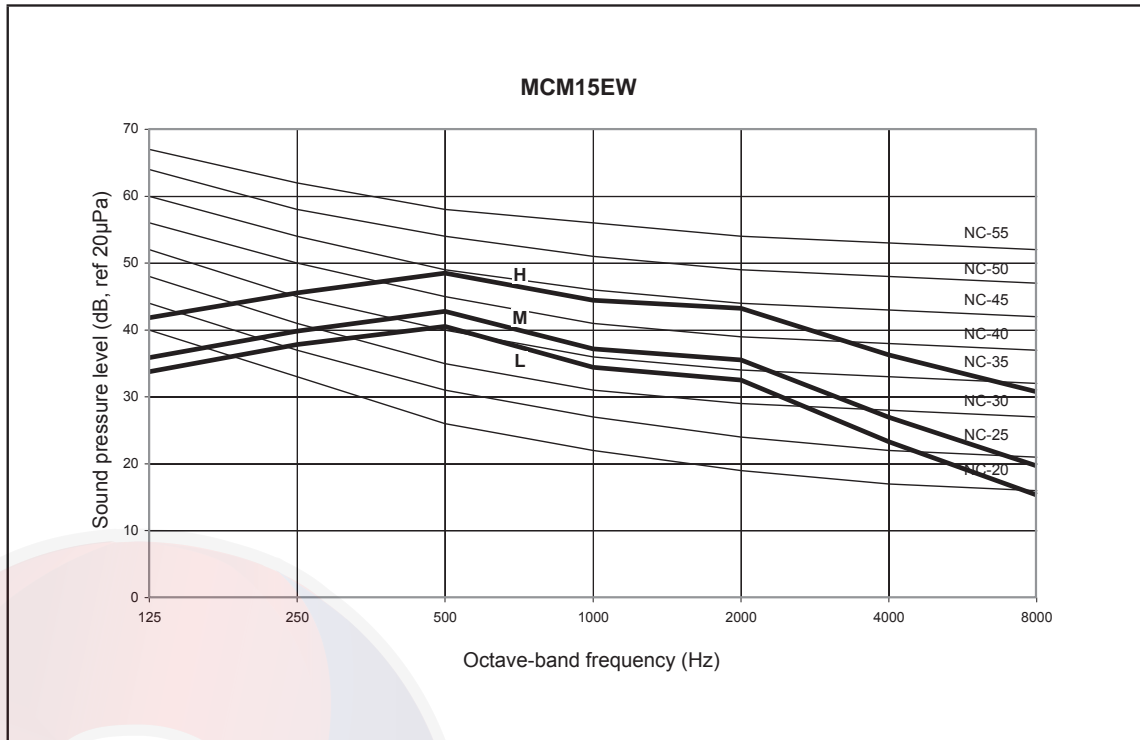

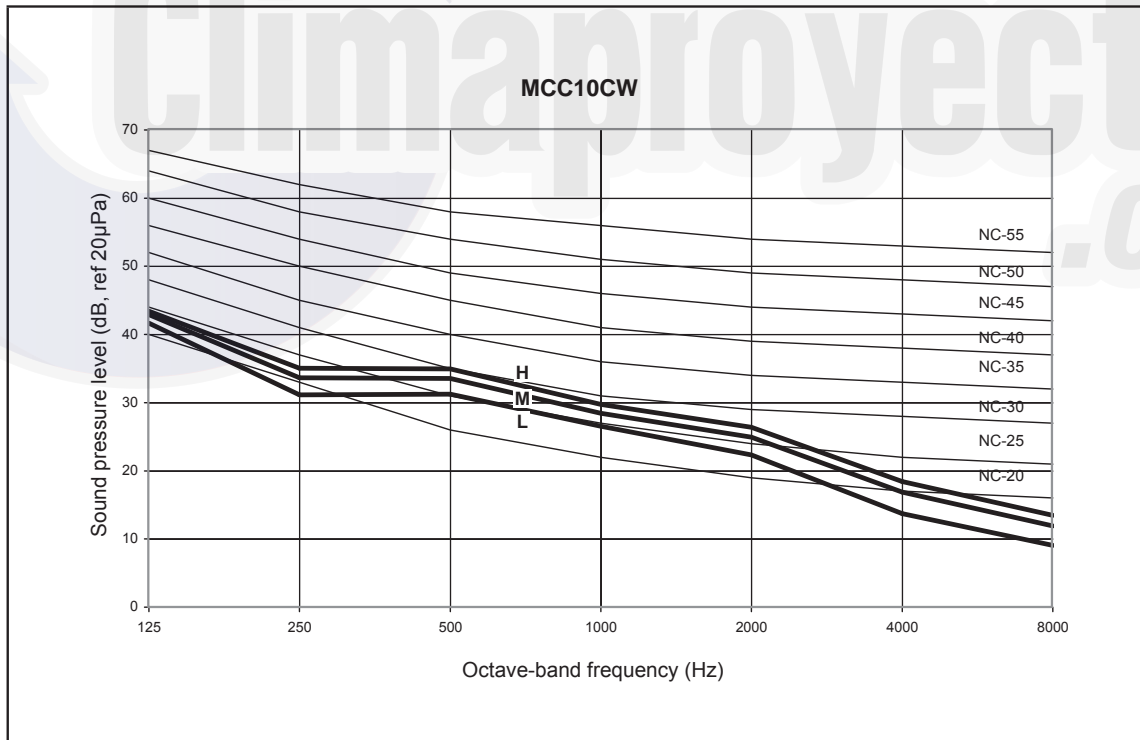
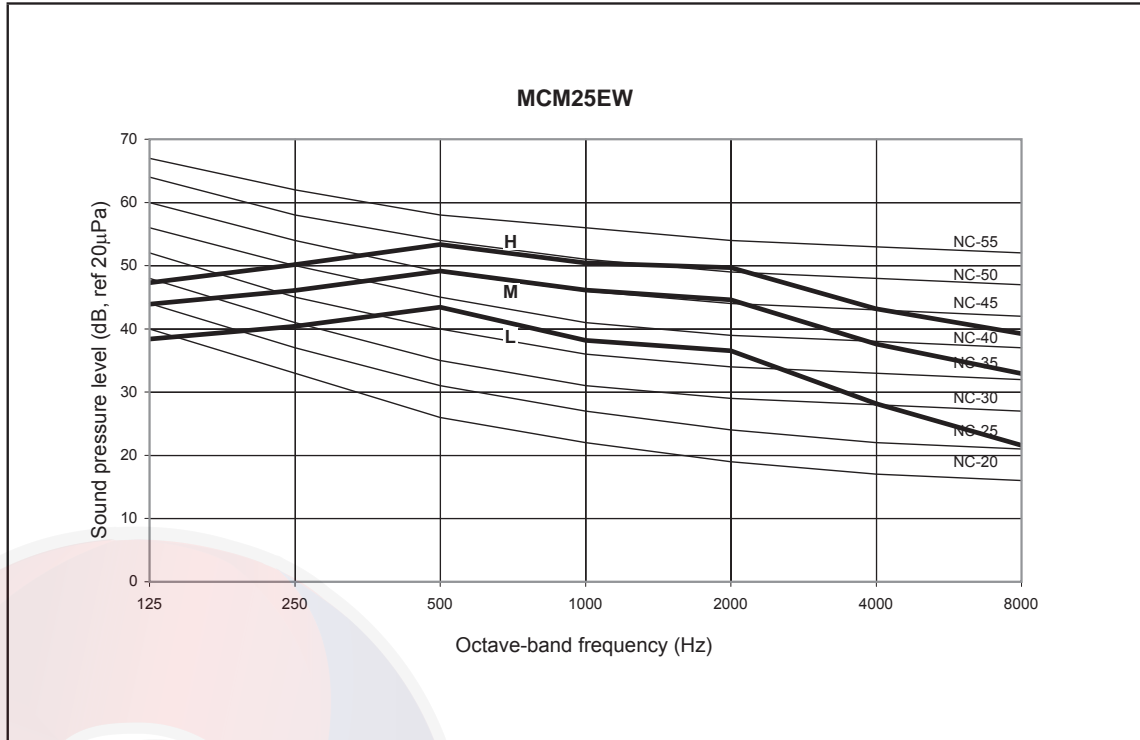

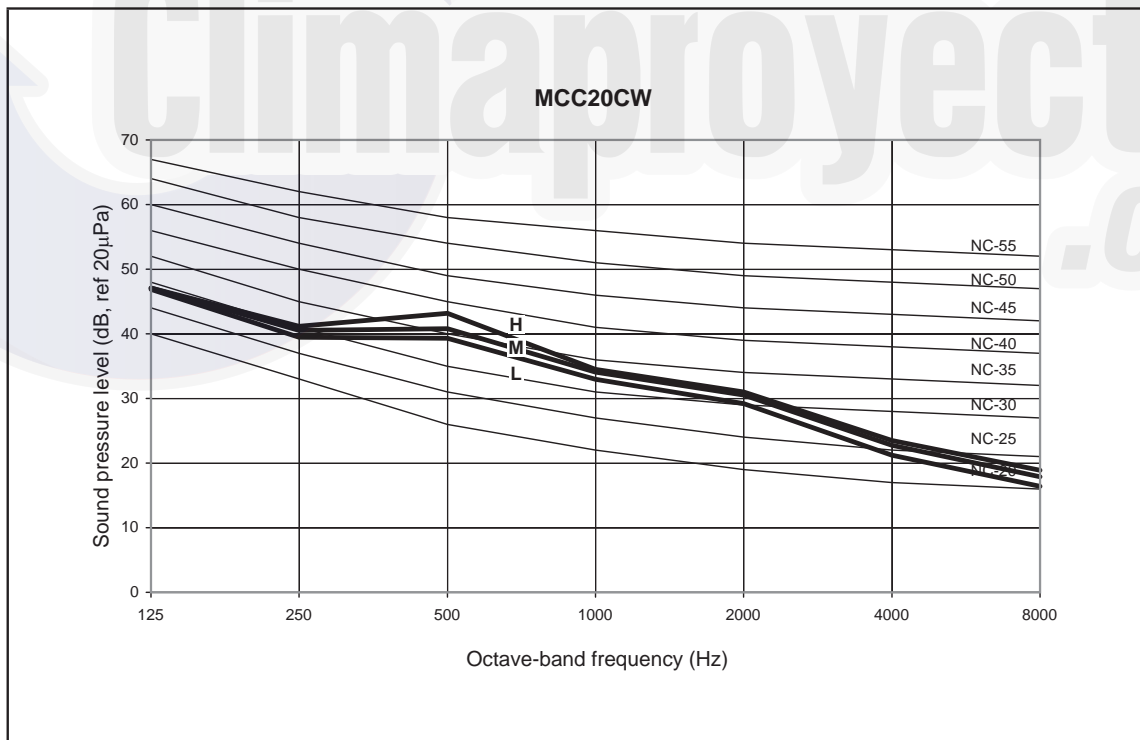
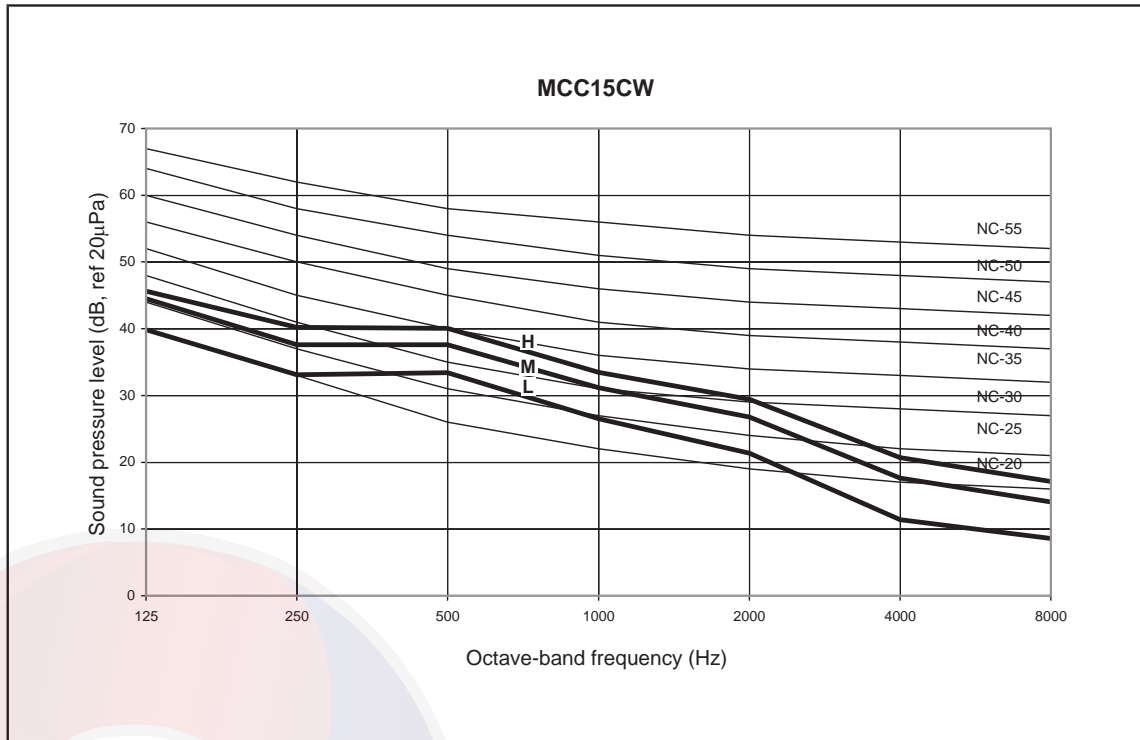

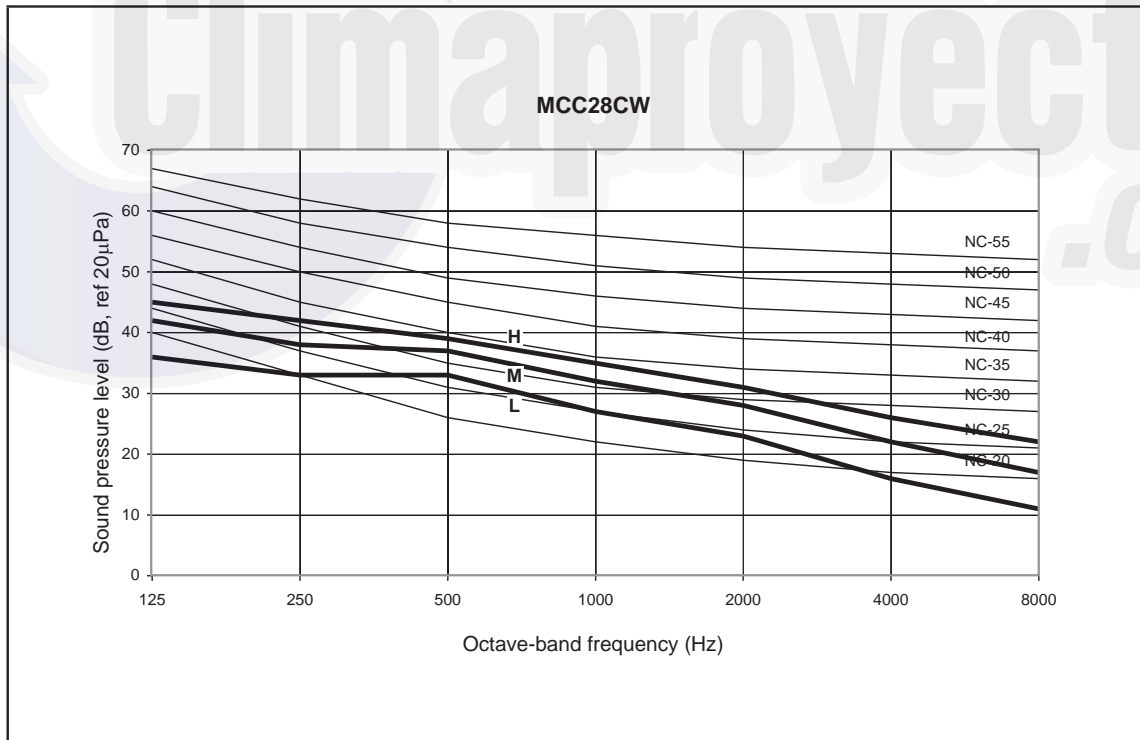
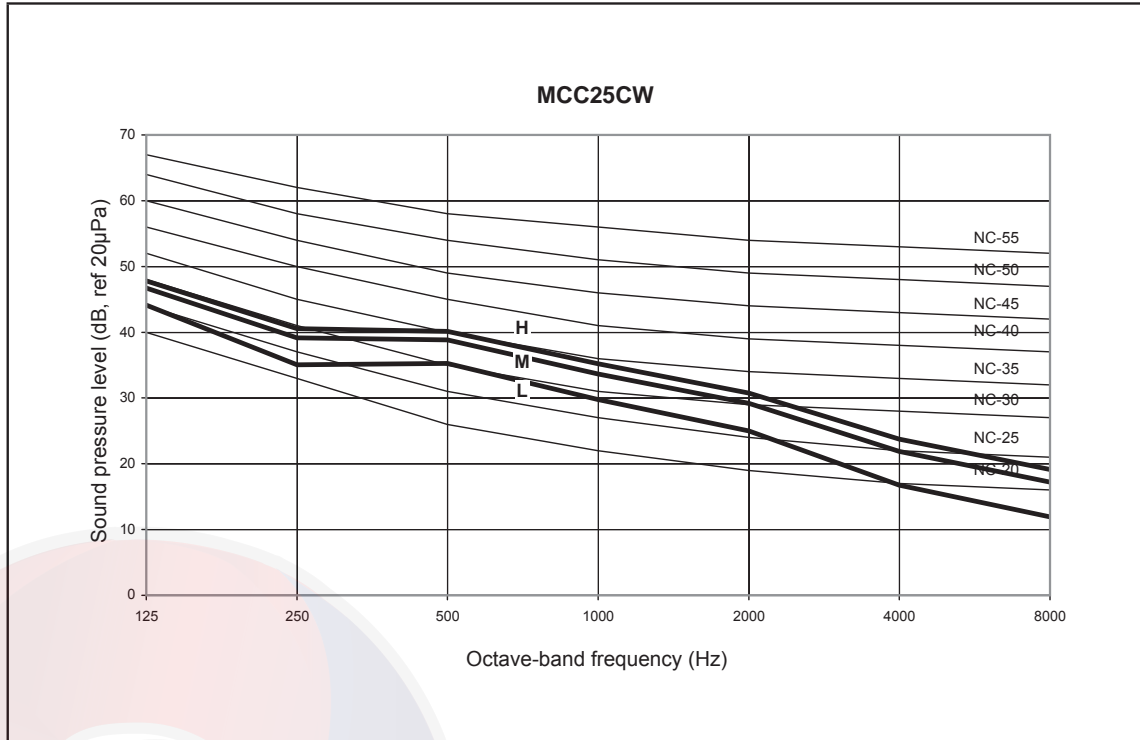

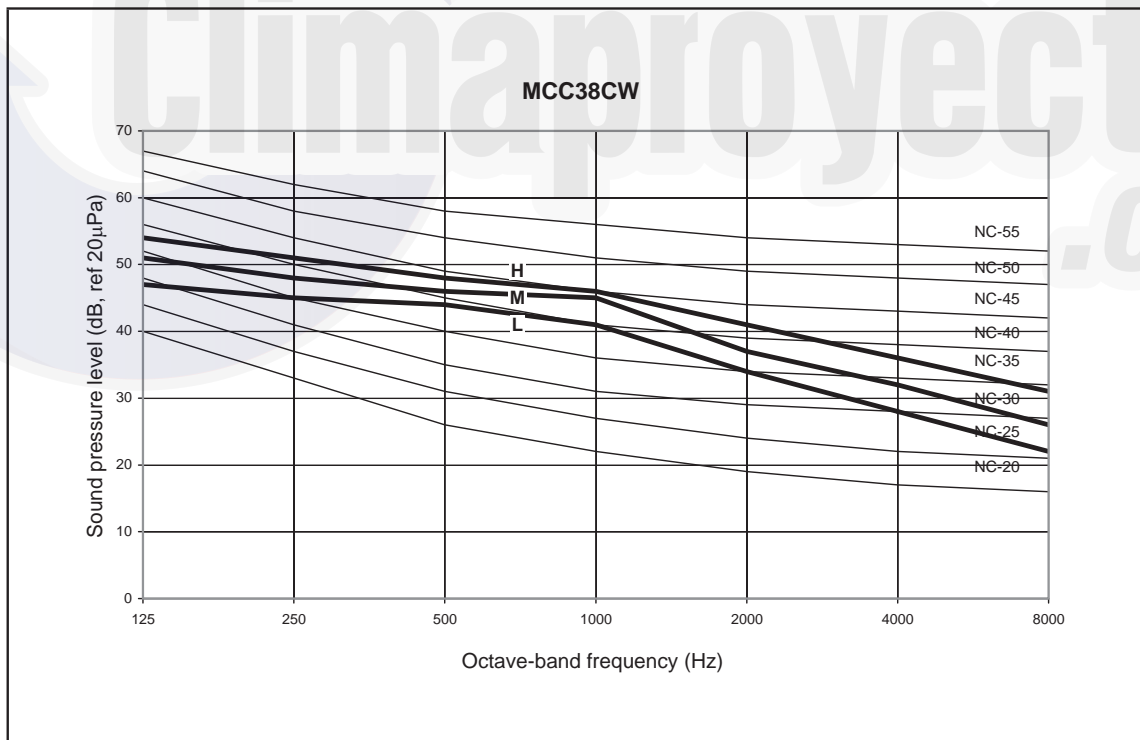
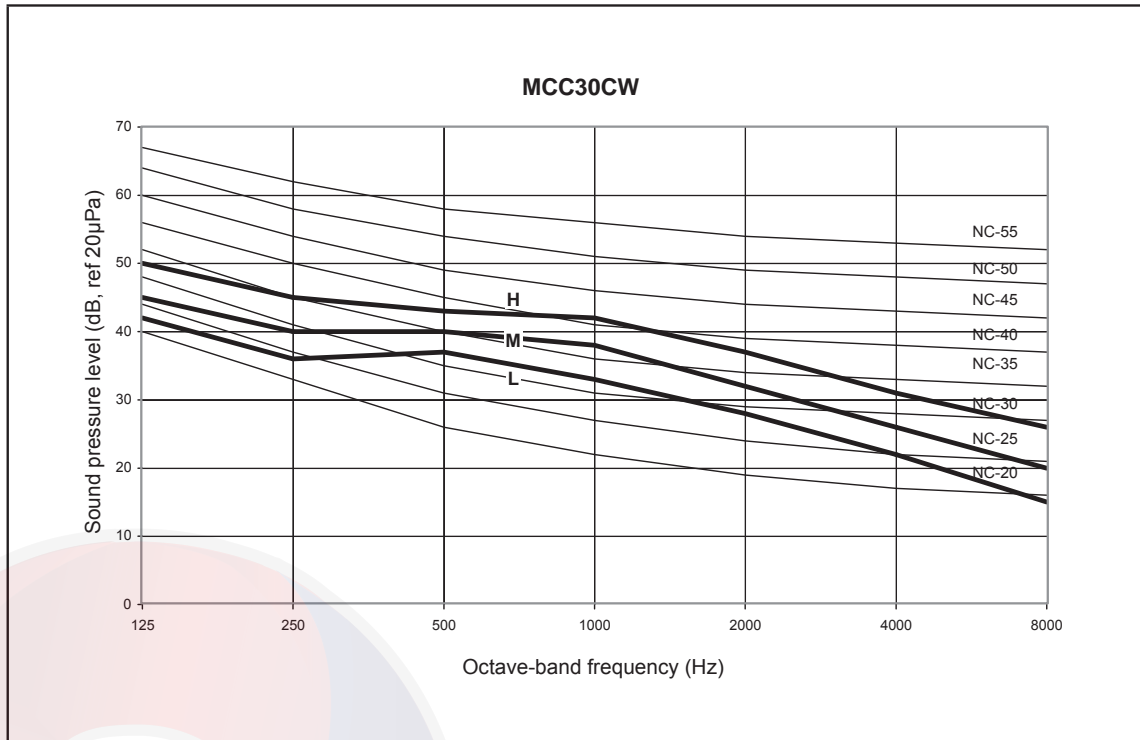

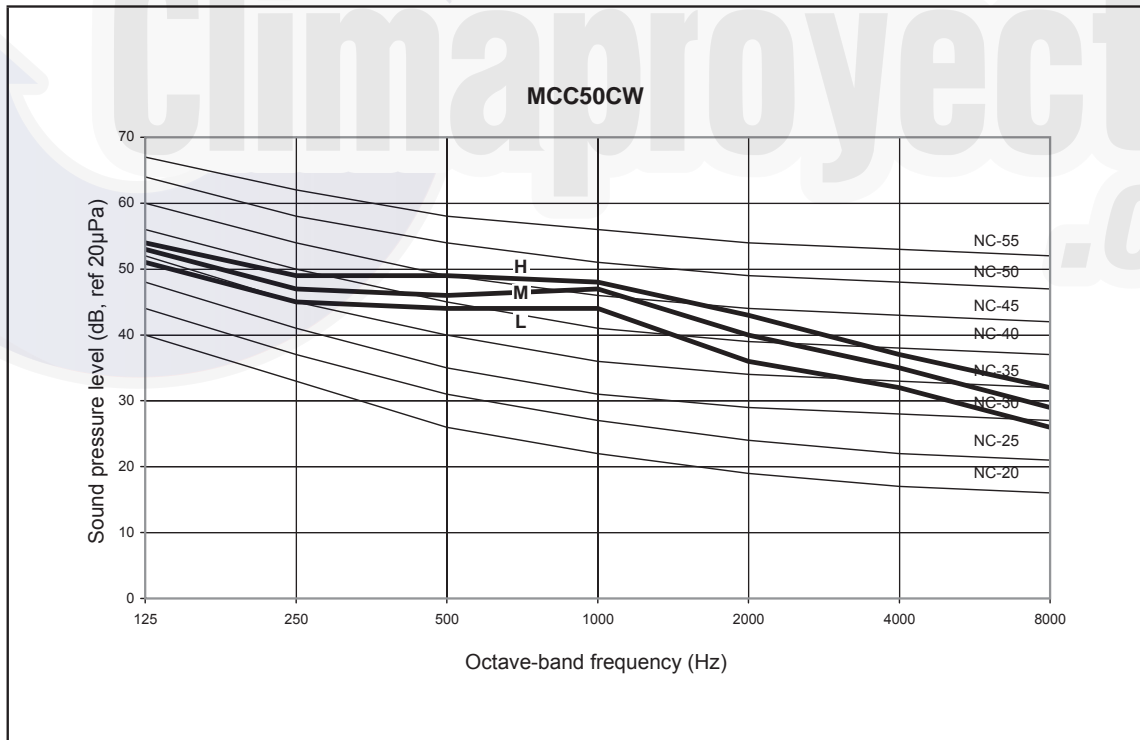
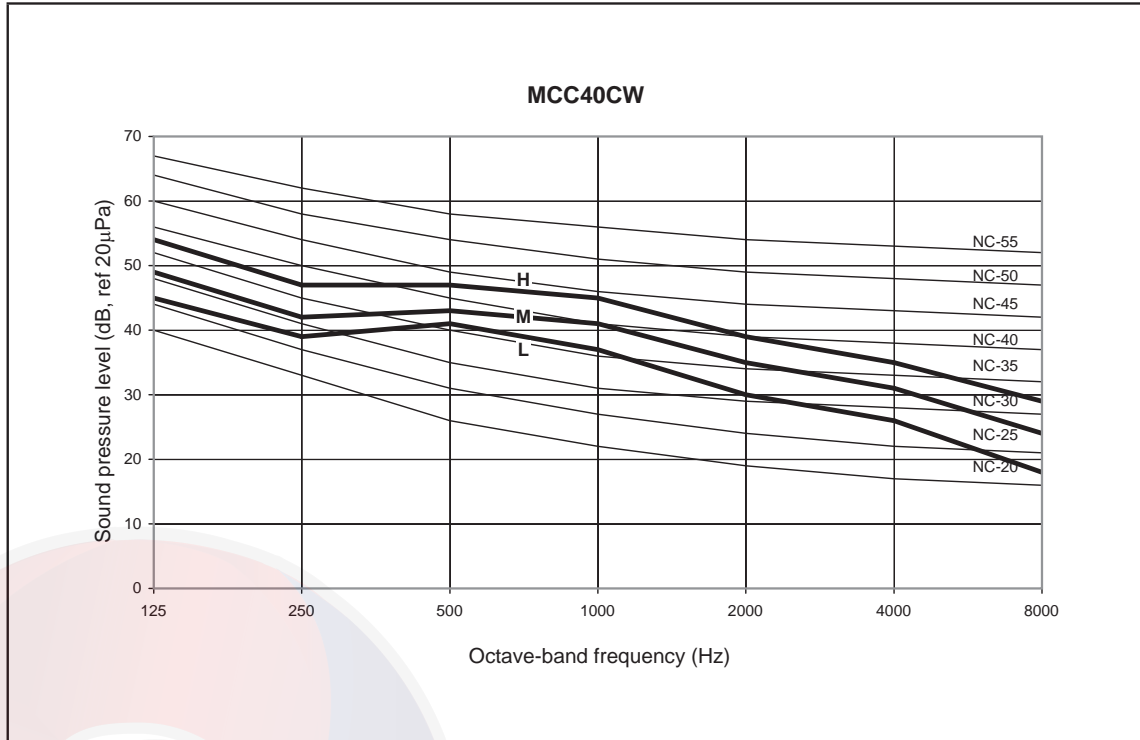

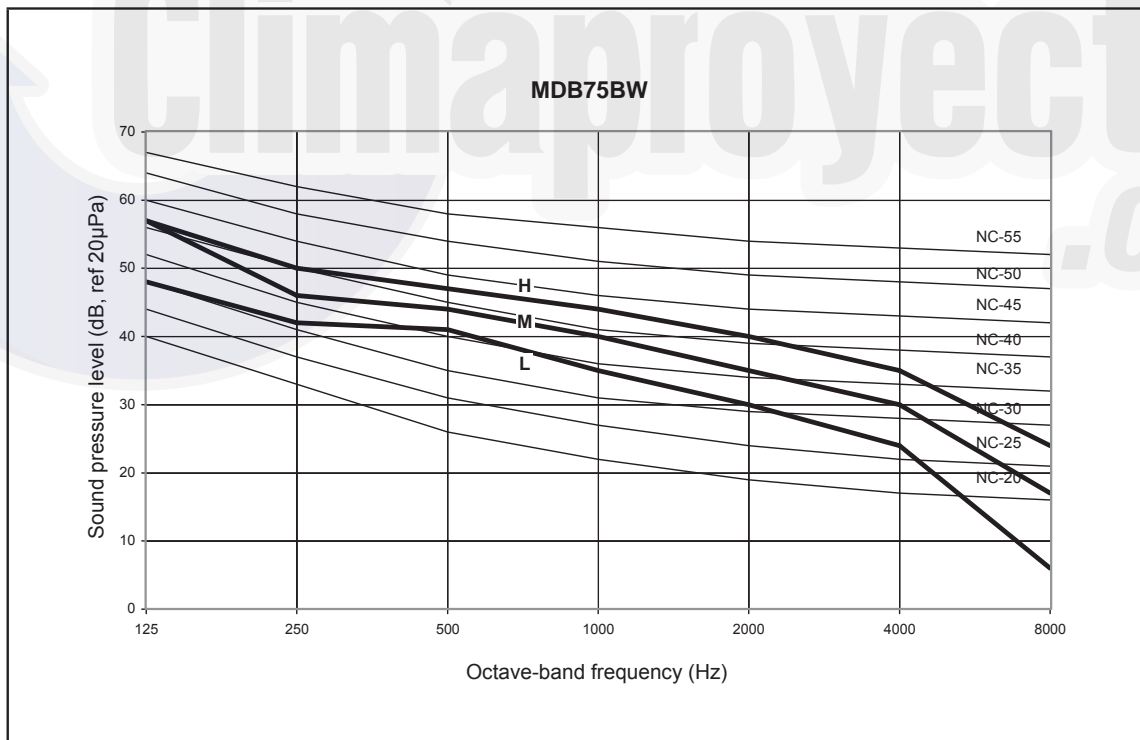
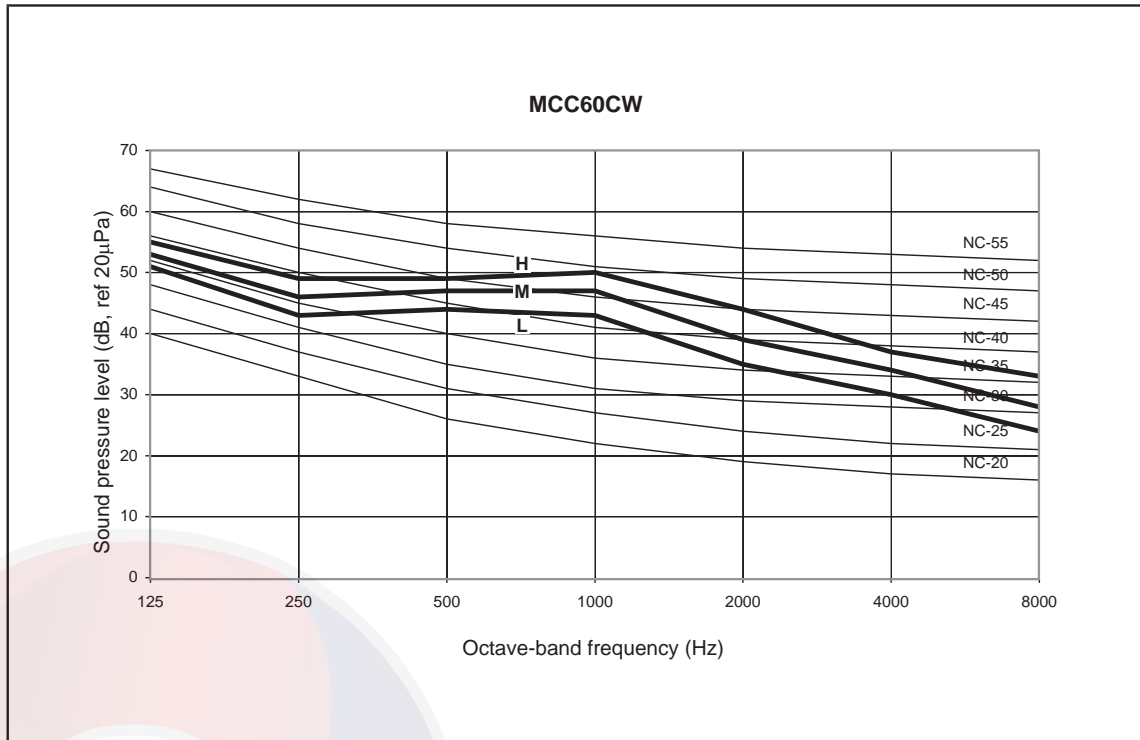

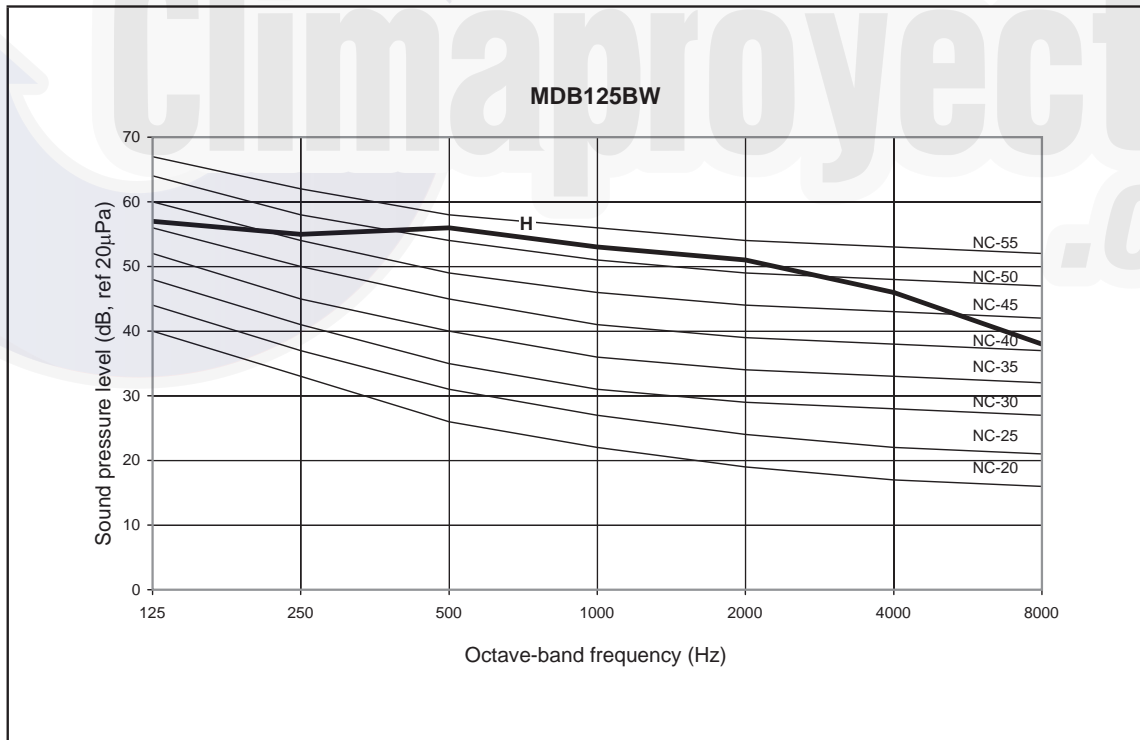
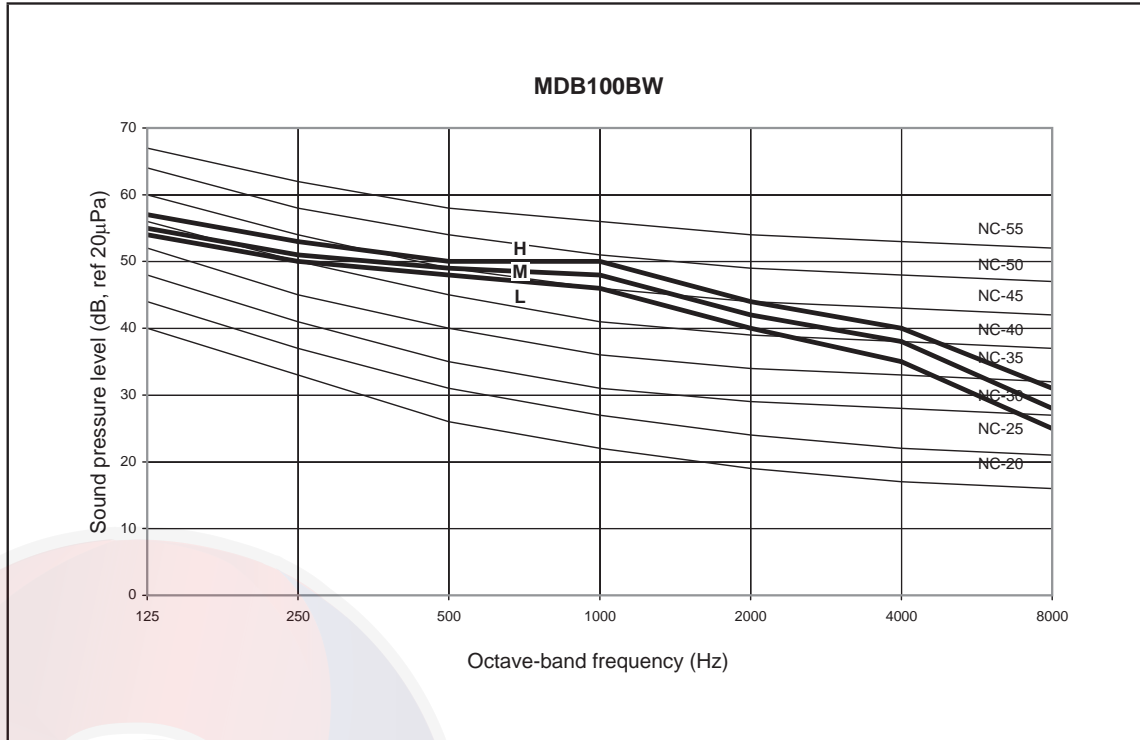

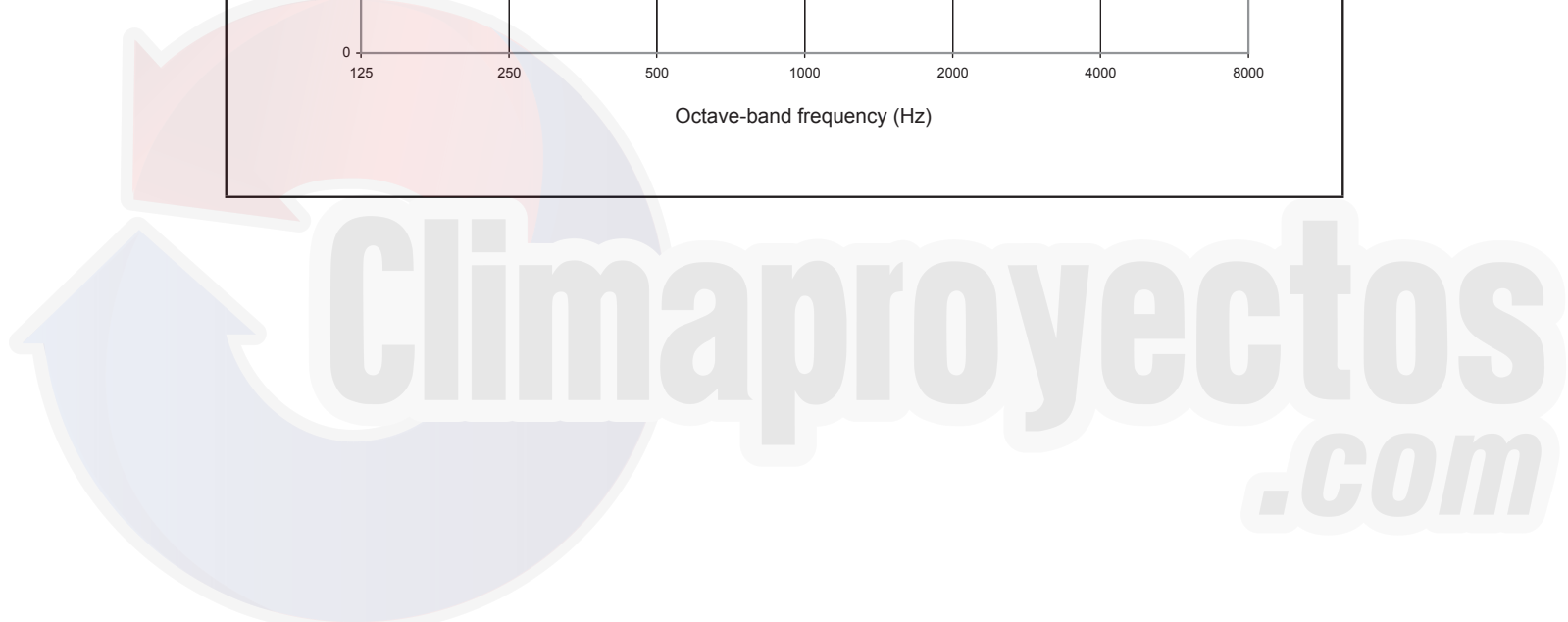
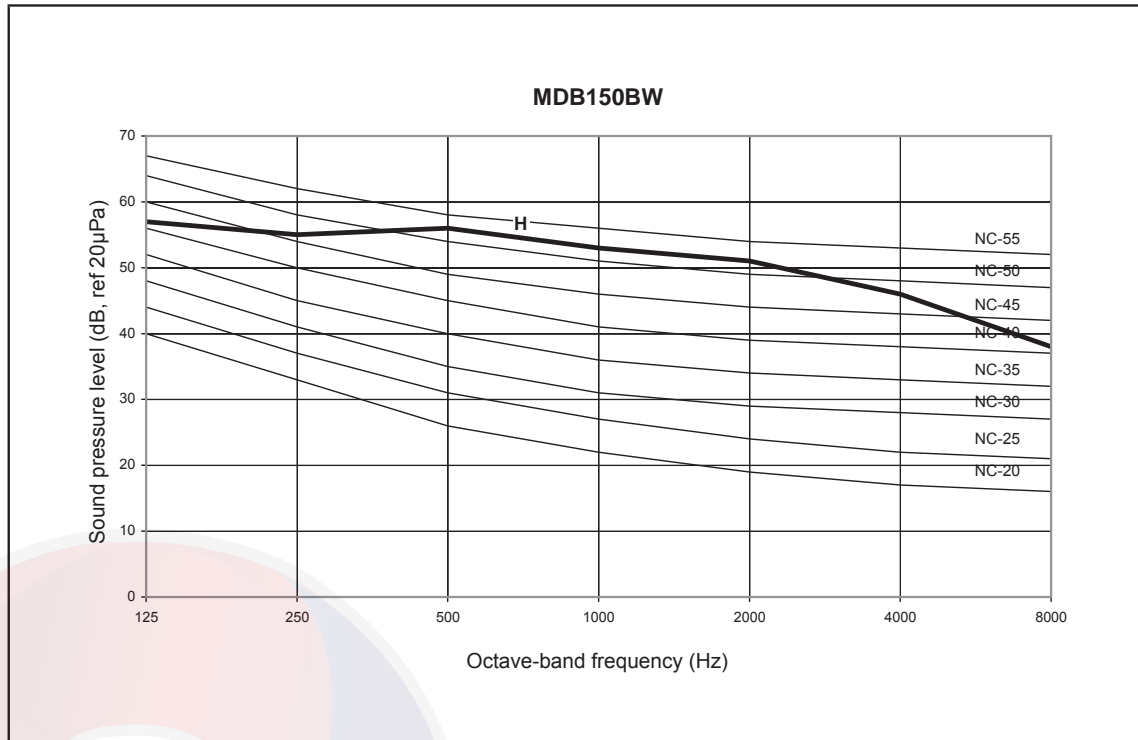

Selection Process

The following table summarizes the pulley data, motor size used for the MDB series, as manufactured:

Model	Pulley Center Distance, C		Motor, kW	Motor RPM	Motor Pulley Diameter, Dm	Blower Pulley, Db
	Horizontal	Vertical			Taper #	Taper #
	(mm)	(mm)			(mm)	(mm)
MDB125BW	340	350	1.5	1500	80	150
MDB150BW	320	N/A	2.2	1500	80	160



Fan Performance Chart

Fan Performance Curve

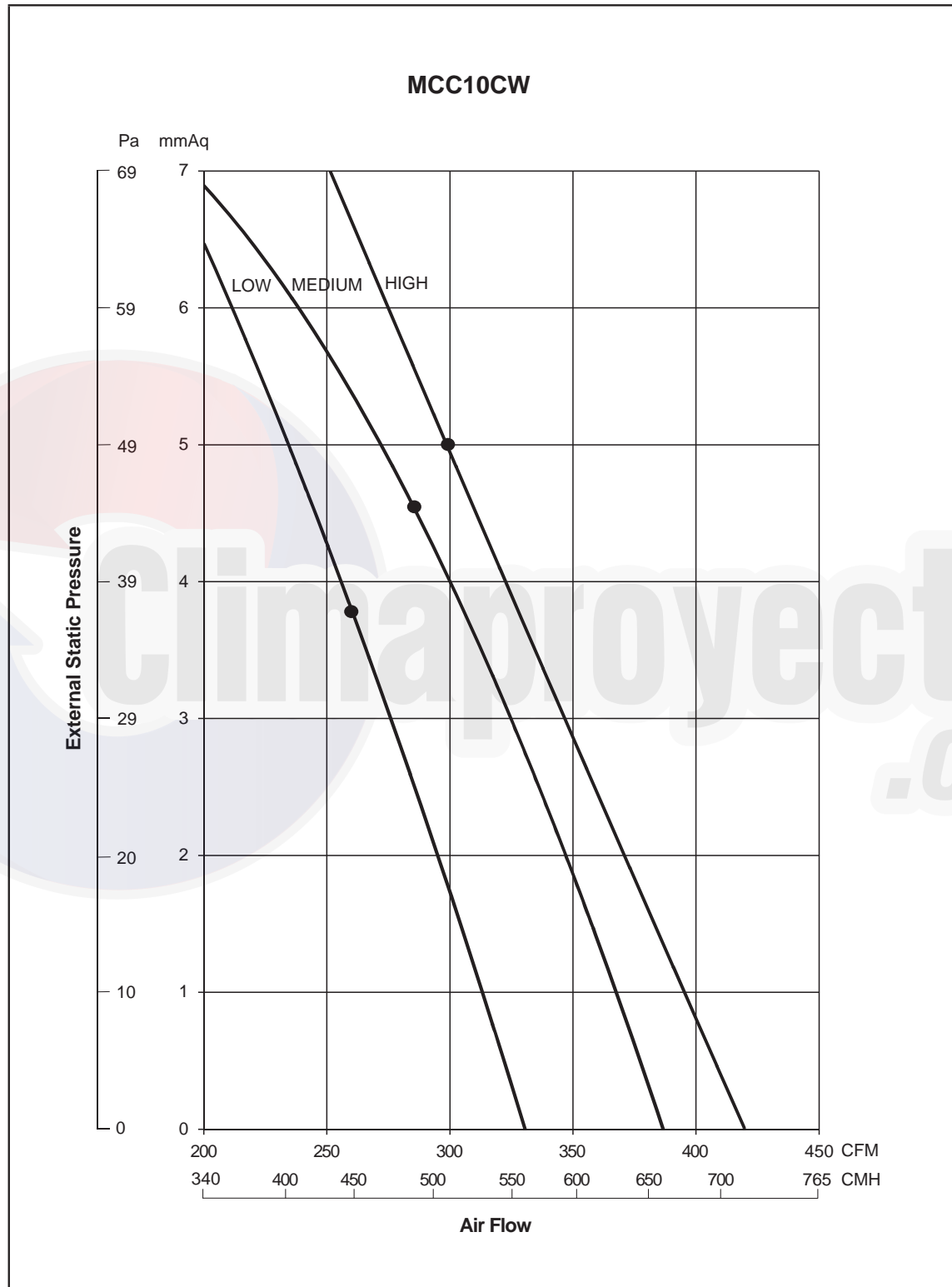

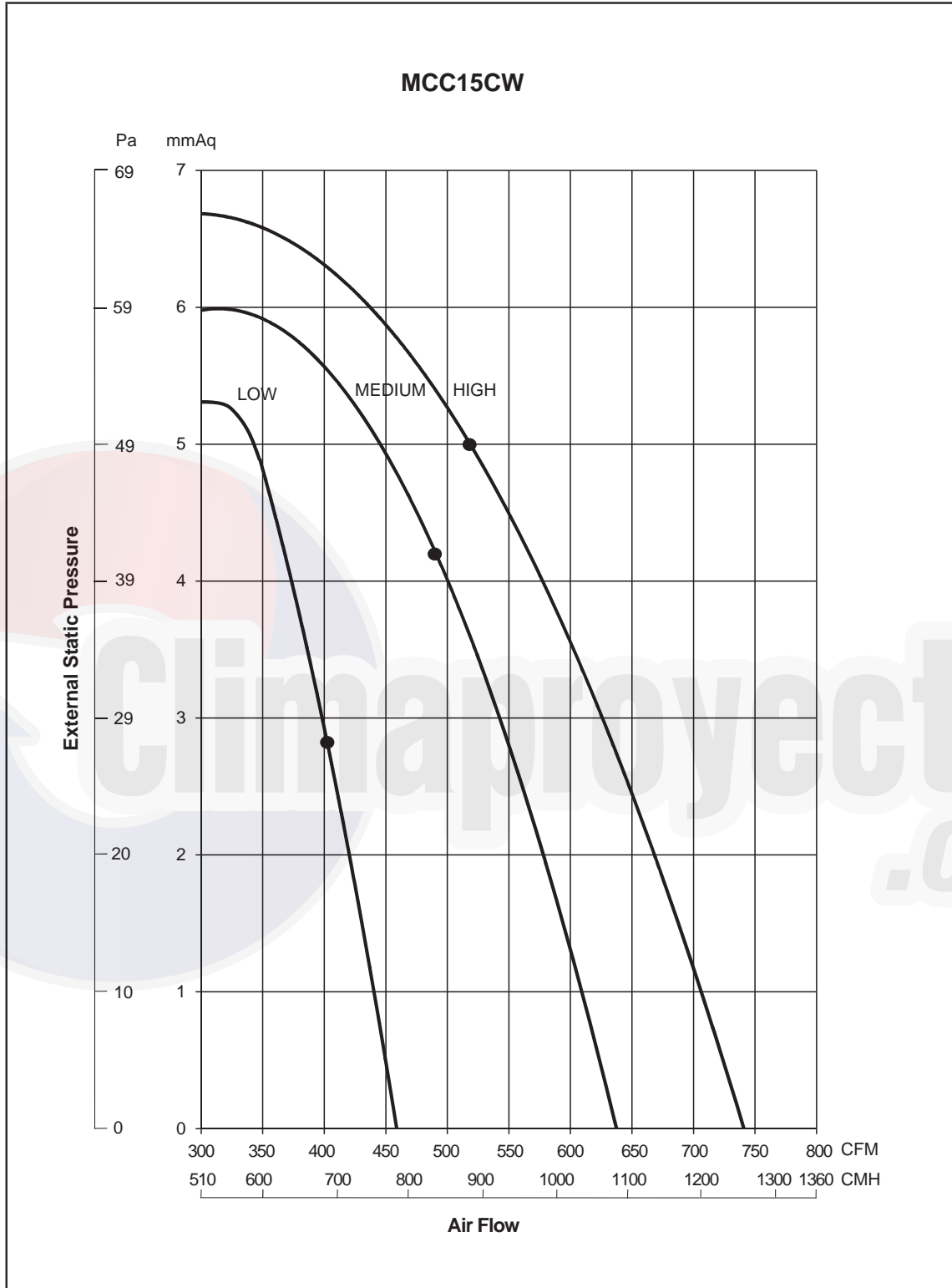

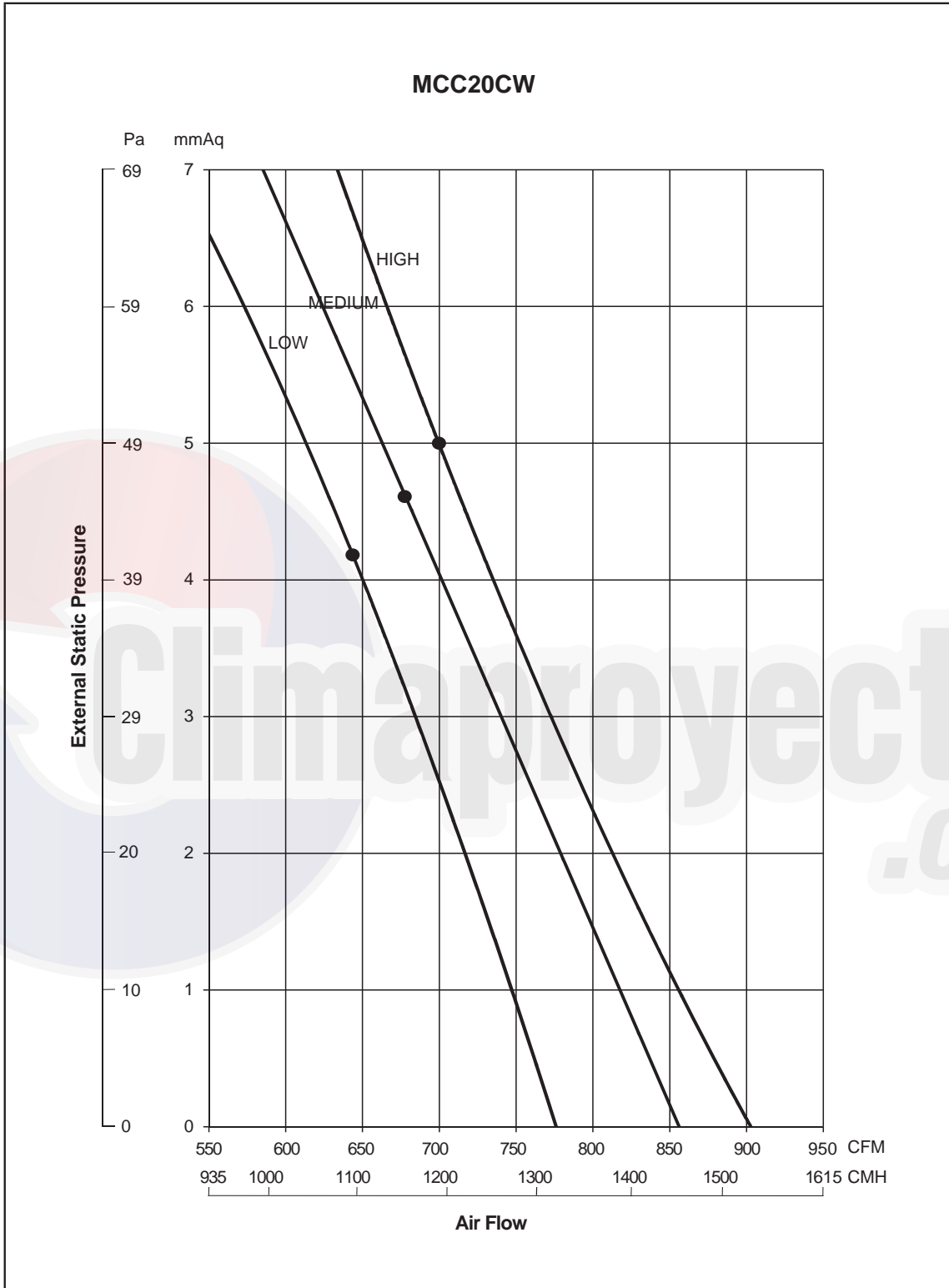

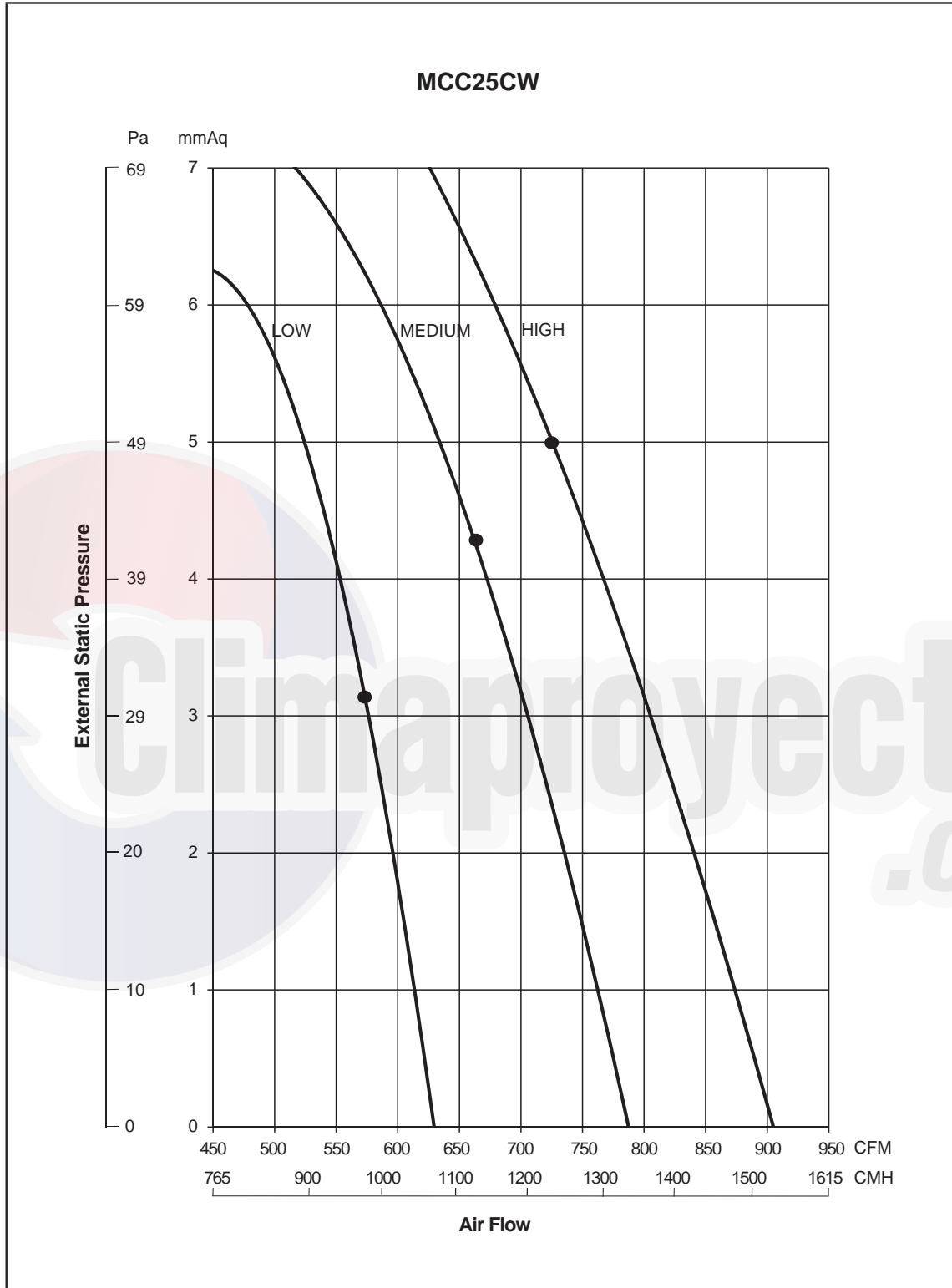

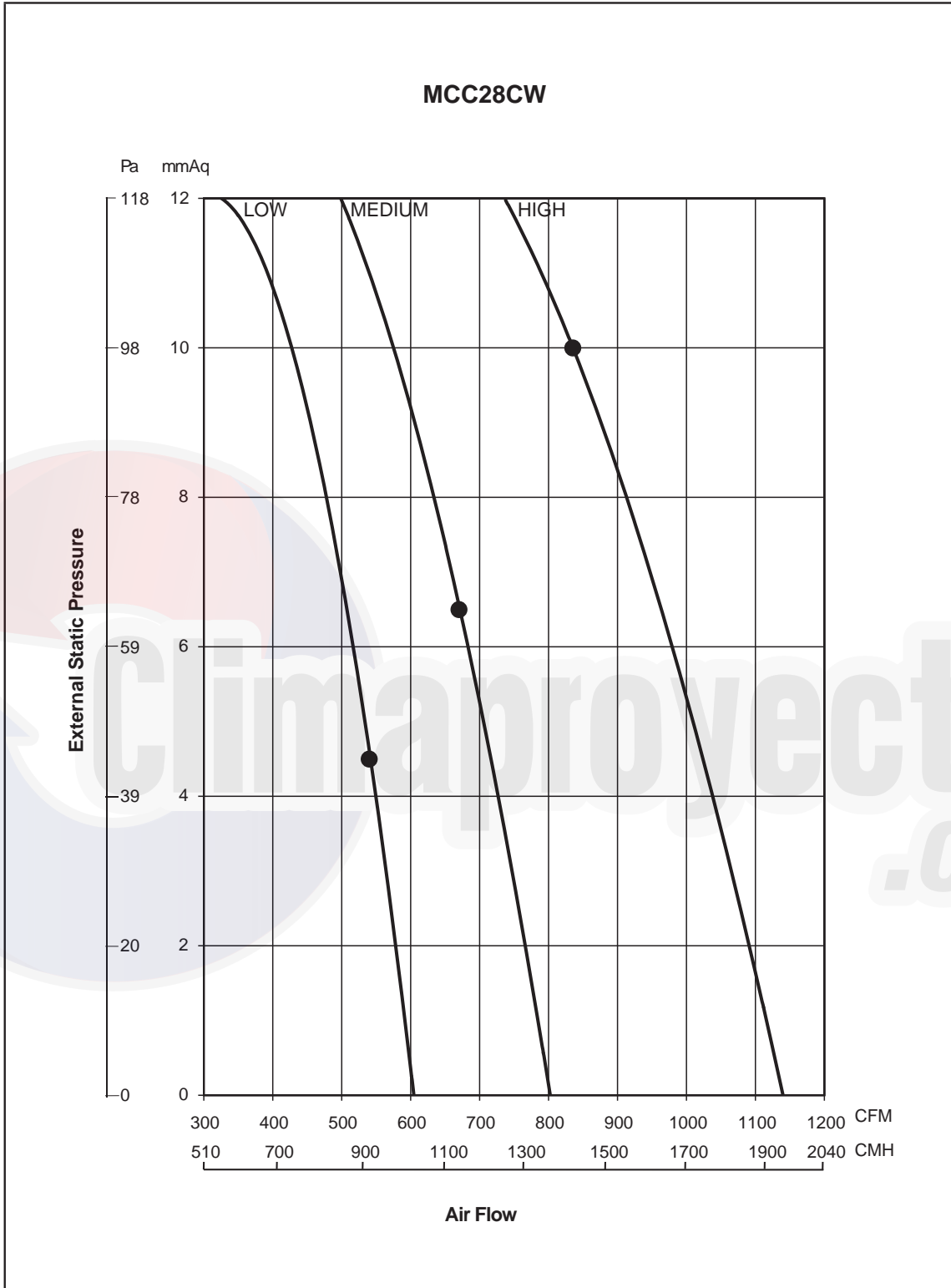

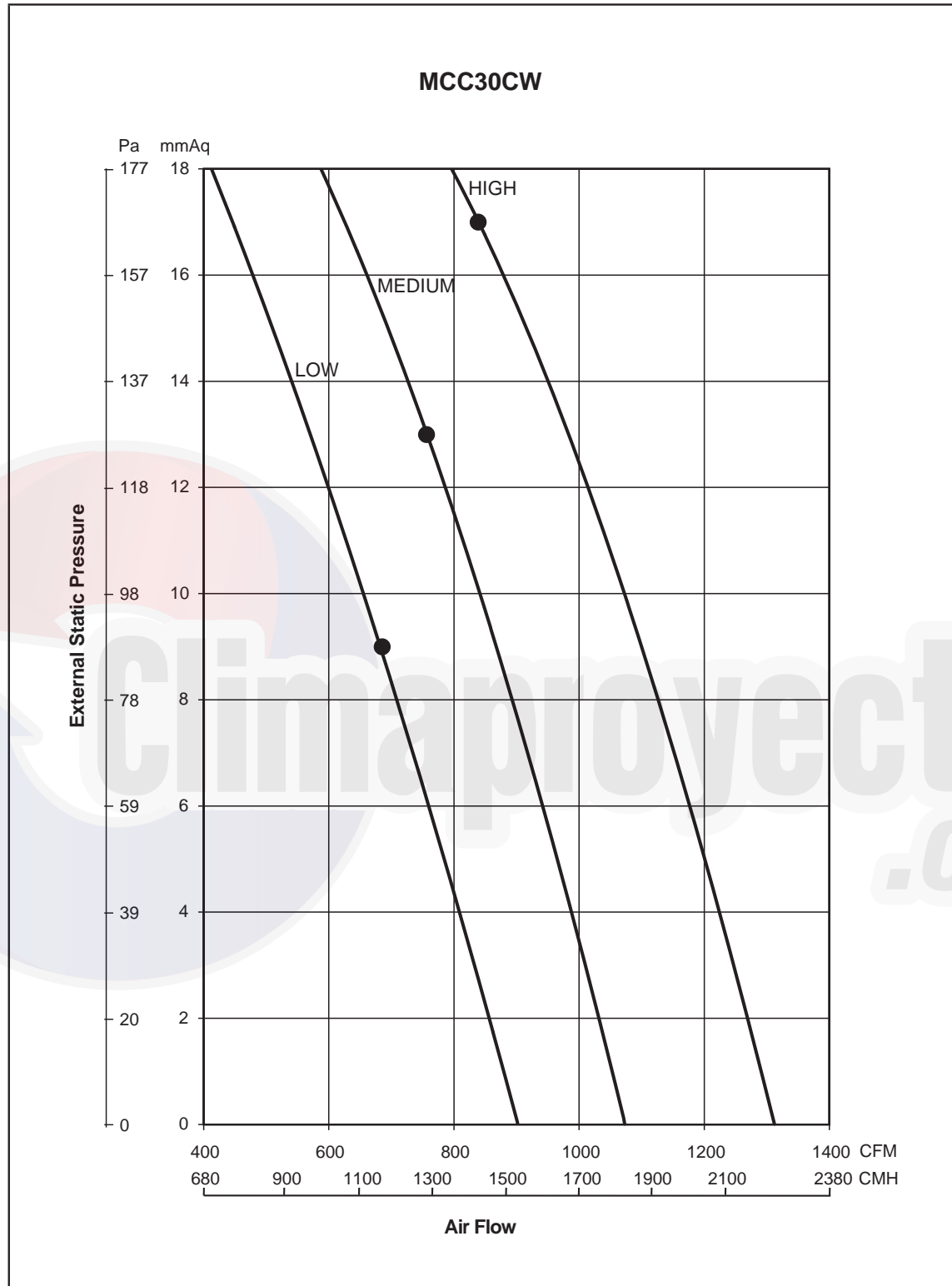

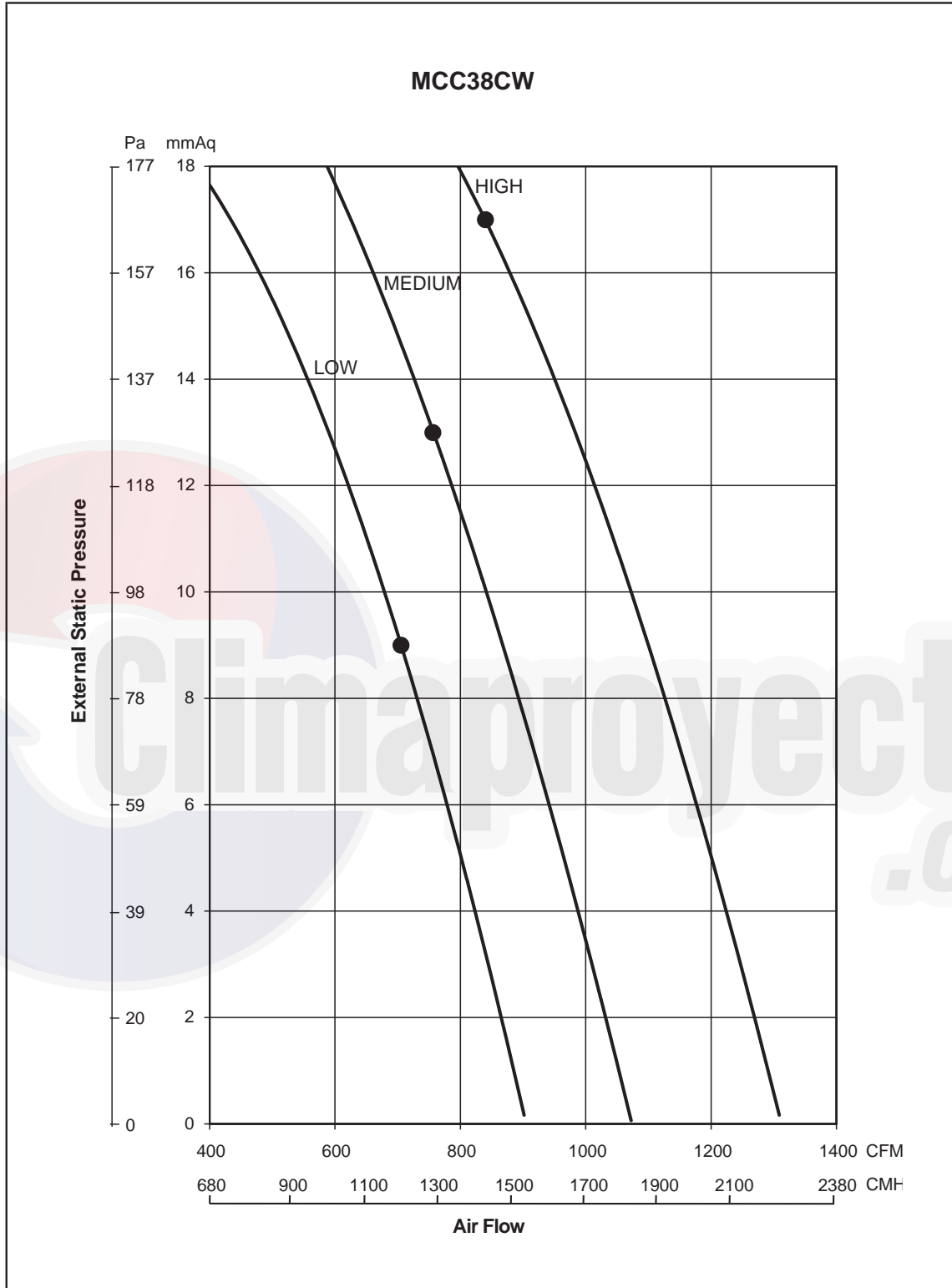

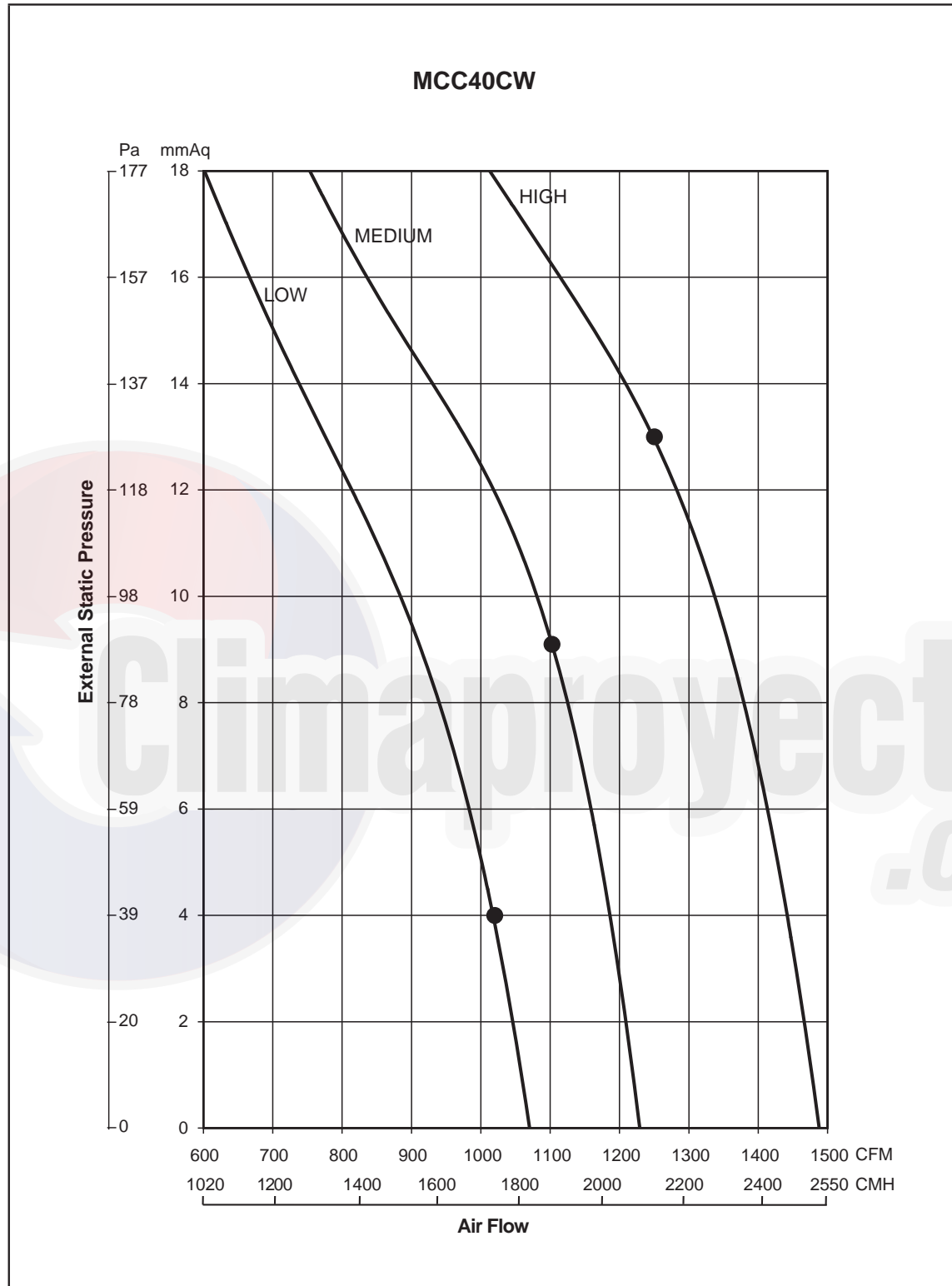

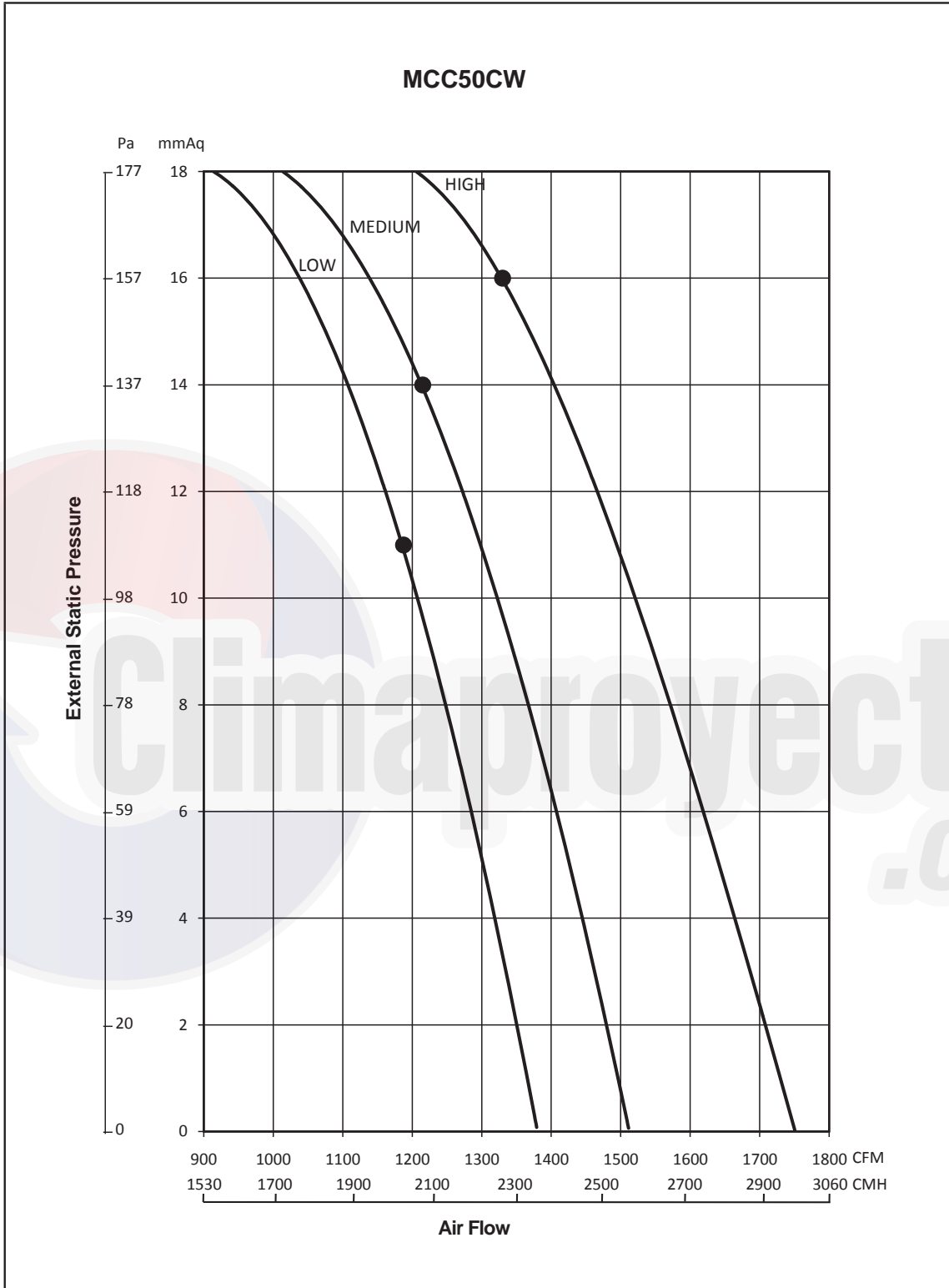

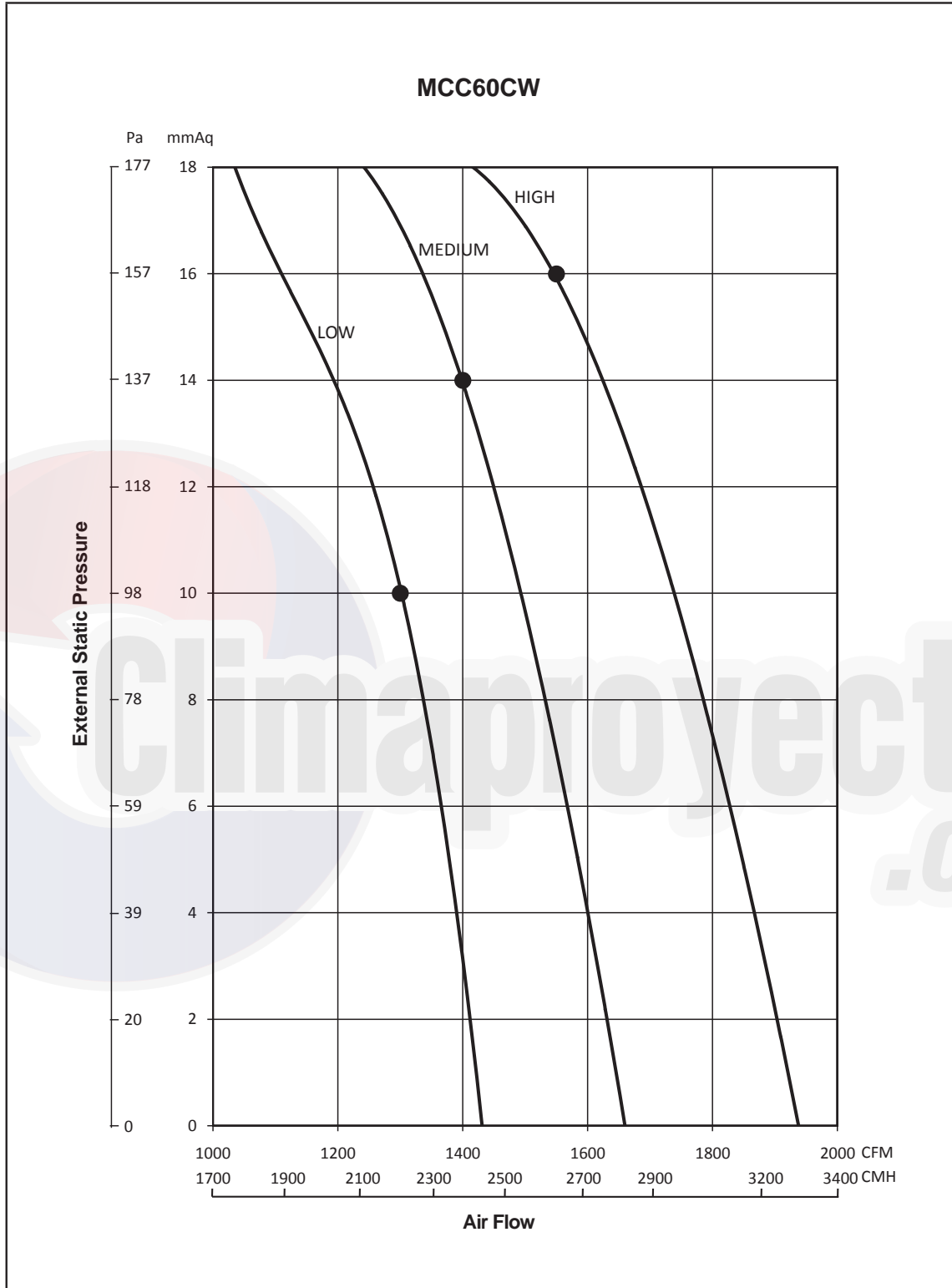

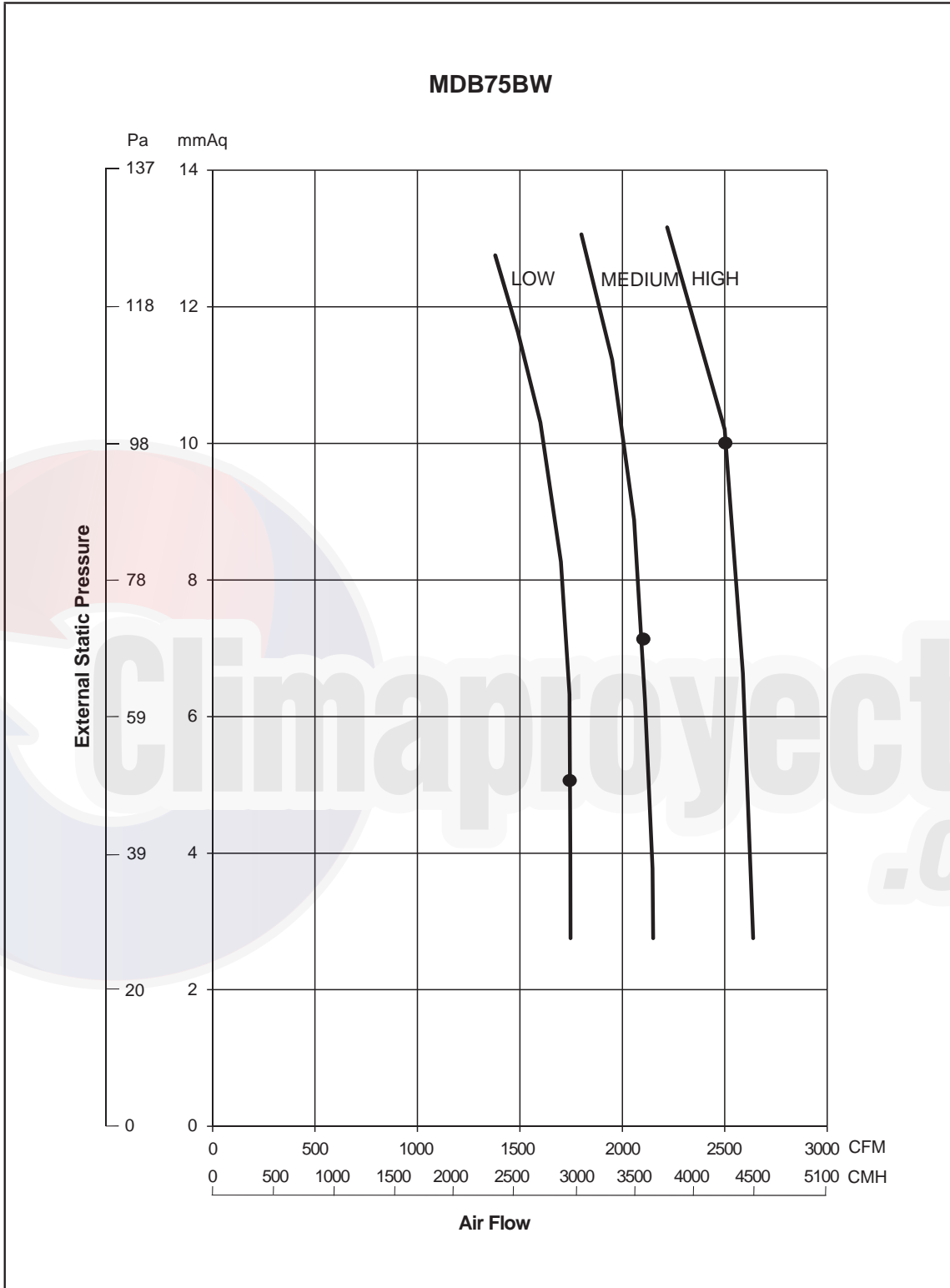

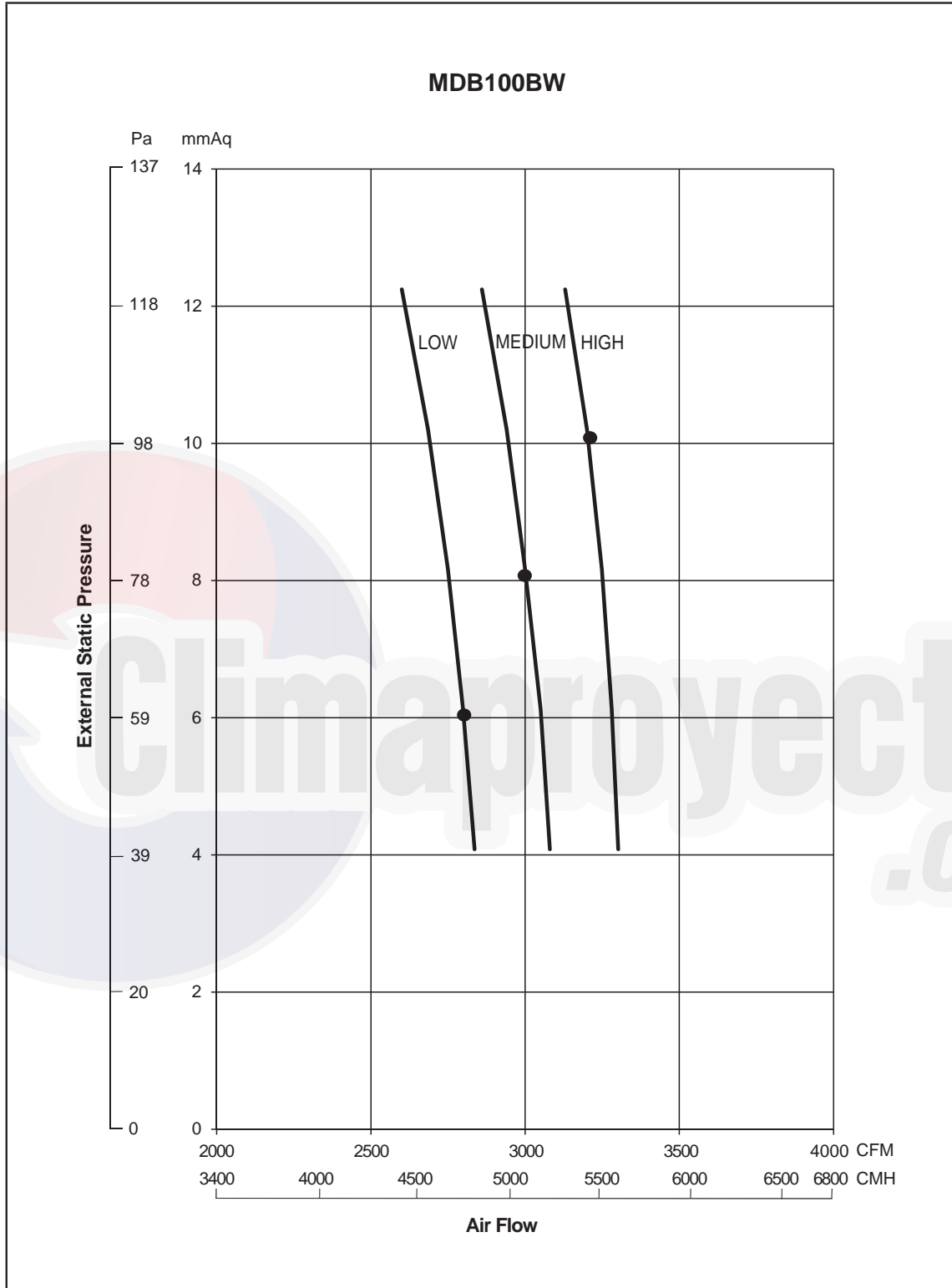

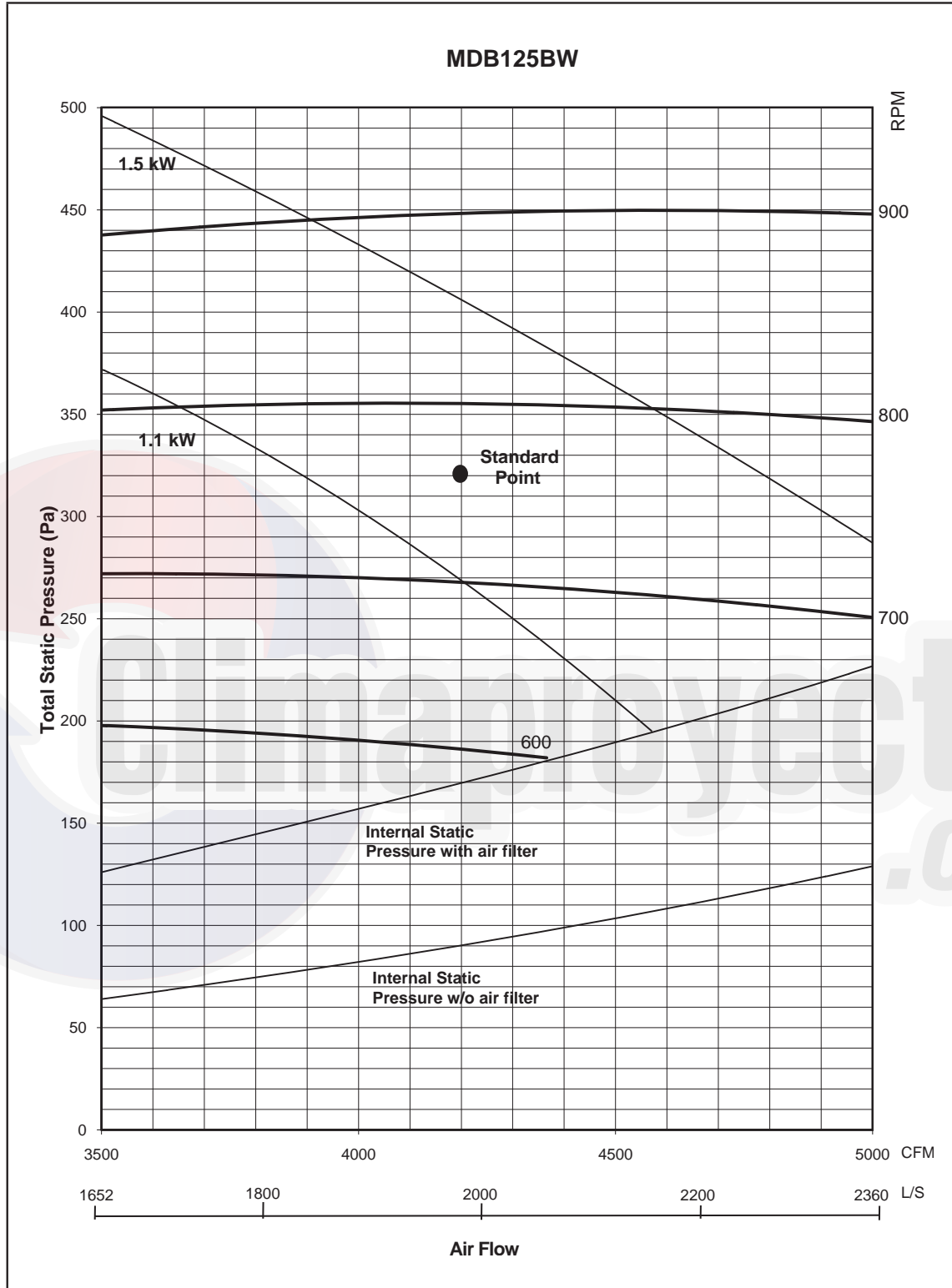

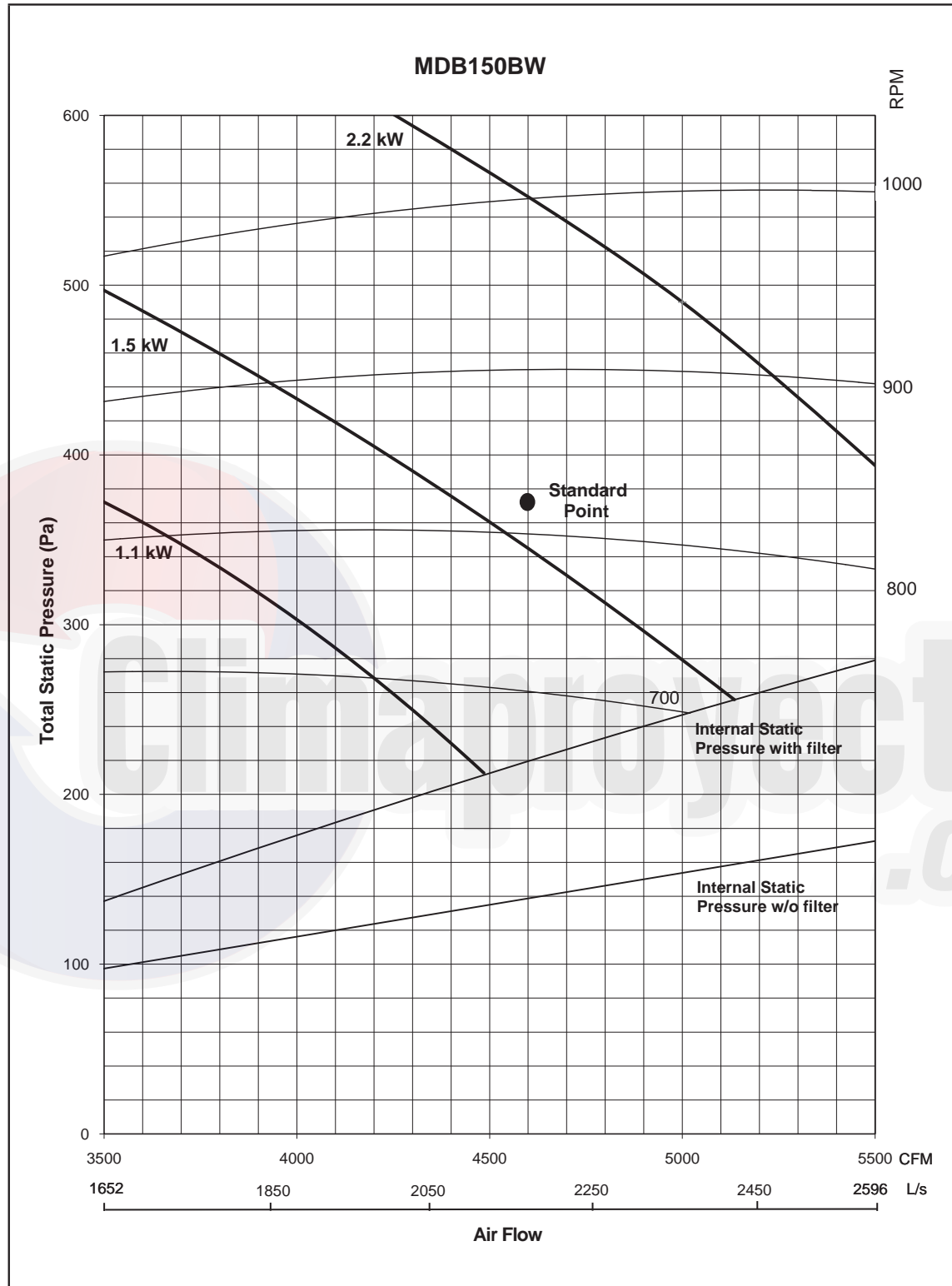

Engineering & Physical Data

Engineering Data - Chilled Water Fan Coil Unit

MODEL		MWM07LW	MWM10LW	MWM15LW	MWM20LW	MWM25LW		
NOMINAL COOLING CAPACITY	Btu/h	8300	9200	11300	15500	18000		
	W	2430	2700	3310	4540	5280		
NOMINAL SENSIBLE COOLING CAPACITY	Btu/h	6300	6900	9000	11700	14000		
	W	1850	2020	2640	3430	4100		
NOMINAL HEATING CAPACITY (ENTERING WATER TEMP. = 50°C)	Btu/h	11000	12000	15000	20500	25000		
	W	3220	3520	4400	6010	7330		
NOMINAL TOTAL INPUT POWER	W	31	32	42	53	72		
NOMINAL RUNNING CURRENT	A	0.19	0.20	0.21	0.29	0.34		
POWER SOURCE	V/Ph/Hz	220-240 / 1 / 50						
REFRIGERANT TYPE		N/A						
CONTROL OPERATION	AIR DISCHARGE OPERATION	AUTOMATIC LOUVER (UP & DOWN)						
		LCD WIRELESS MICRO-COMPUTER REMOTE CONTROL						
AIR FLOW	HIGH	CFM	260	280	370	510	620	
	MEDIUM	CFM	230	250	320	450	520	
	LOW	CFM	200	220	260	390	460	
	QUIET	CFM	180	190	240	360	440	
NOMINAL WATER FLOW RATE	USGPM	1.85	2.03	2.51	3.43	4.01		
	litres/min	7.00	7.68	9.50	13.00	15.18		
HEAD LOSS (COOLING)	kPa	34.0	24.0	31.0	30.0	36.0		
HEAD LOSS (HEATING) : 50°C	kPa	29.0	20.0	25.0	27.0	33.0		
MAX. WORKING PRESSURE	kPa	1608						
SURFACE AIR VELOCITY	m/s	0.68	0.74	0.97	0.83	1.01		
SOUND PRESSURE LEVEL (H/M/L)	dB(A)	34 / 29 / 25 / 24	35 / 30 / 25 / 24	42 / 39 / 32 / 29	42 / 38 / 34 / 32	46 / 42 / 39 / 37		
UNIT DIMENSION	H X W X D	mm			310 X 1065 X 224			
PACKING DIMENSION	H X W X D	mm			344 X 874 X 274			
UNIT WEIGHT	kg	9			14			
CONDENSATE DRAIN SIZE	mm	19.05						
PIPE CONNECTION	mm	12.70						
FAN	TYPE	CROSS FLOW FAN						
	DRIVE	DIRECT						
	FAN SPEED	HIGH	RPM	1030	1050	1310	1035	1250
		MEDIUM	RPM	890	910	1150	920	1070
		LOW	RPM	760	780	955	825	970
	FAN EFFICIENCY	HIGH	%	26.70	24.20	21.00	21.60	20.90
		MEDIUM	%	25.30	22.70	22.10	21.70	22.20
LOW	%	24.80	21.60	22.80	23.10	22.80		
FAN MOTOR	TYPE	INDUCTION						
	INDEX OF PROTECTION (IP)	IP20			IP44			
	INSULATION GRADE	E						
	RATED INPUT POWER	HIGH	W	31	32	42	53	72
		MEDIUM	W	29	31	37	47	68
		LOW	W	25	29	33	42	60
	RATED RUNNING CURRENT	HIGH	A	0.19	0.20	0.21	0.29	0.34
		MEDIUM	A	0.18	0.20	0.20	0.26	0.32
		LOW	A	0.17	0.19	0.19	0.25	0.31
	STARTING CURRENT	A	0.40	0.40	0.40	0.30	0.43	
	MOTOR OUTPUT	W	18	18	18	26	32	
	MOTOR EFFICIENCY	HIGH	%	27.40	29.00	44.00	36.50	48.00
MEDIUM		%	19.30	21.00	36.00	29.00	36.00	
LOW		%	13.00	15.00	22.50	24.00	29.00	
POLES	4							
COIL	TUBE	MATERIAL	COPPER					
		DIAMETER	mm					
	FIN	MATERIAL	ALUMINIUM					
		FACE AREA	m ²	0.18	0.18	0.18	0.29	0.29
ROW	2							
WATER VOLUME	litre	0.52	0.58	0.58	0.95	0.95		
AIR QUALITY FILTER	TYPE	WASHABLE SARANET FILTER						
	QUANTITY	pc						
CASING	COLOUR	WHITE						

MODE	COOLING	HEATING
ENTERING AIR TEMPERATURE	27°C DB / 19°C WB	20°C DB
ENTERING WATER TEMPERATURE	7°C	50°C (2 Pipes System) 70°C (4 Pipes System)
LEAVING WATER TEMPERATURE	12°C	45°C (2 Pipes System) 60°C (4 Pipes System)

ALL SPECIFICATIONS ARE SUBJECT TO CHANGE BY THE MANUFACTURER WITHOUT PRIOR NOTICE.

Engineering Data - Chilled Water Fan Coil Unit

MODEL		MWM301W		
NOMINAL COOLING CAPACITY	Btu/h	22000		
	W	6450		
NOMINAL SENSIBLE COOLING CAPACITY	Btu/h	16720		
	W	4900		
NOMINAL HEATING CAPACITY (ENTERING WATER TEMP. = 50°C)	Btu/h	23000		
	W	6740		
NOMINAL TOTAL INPUT POWER	W	74		
NOMINAL RUNNING CURRENT	A	0.32		
POWER SOURCE	V/Ph/Hz	220-240 / 1 / 50		
REFRIGERANT TYPE		N/A		
CONTROL	AIR DISCHARGE	AUTOMATIC LOUVER (UP & DOWN)		
	OPERATION	LCD WIRELESS MICRO-COMPUTER REMOTE CONTROL		
AIR FLOW	HIGH	CFM	670	
	MEDIUM	CFM	630	
	LOW	CFM	500	
	QUIET	CFM	N/A	
NOMINAL WATER FLOW RATE	USGPM	4.90		
	litres/min	18.50		
HEAD LOSS (COOLING)	kPa	52.2		
HEAD LOSS (HEATING) : 50°C	kPa	18.8		
MAX. WORKING PRESSURE	kPa	1608		
SURFACE AIR VELOCITY	m/s	1.09		
SOUND PRESSURE LEVEL (H/M/L)	dba	49 / 47 / 45		
UNIT DIMENSION	H X W X D	mm	291 X 815 X 181	
PACKING DIMENSION	H X W X D	mm	760 X 1311 X 301	
UNIT WEIGHT		kg	17.6	
CONDENSATE DRAIN SIZE		mm	19.05	
PIPE CONNECTION		mm	12.70	
INDOOR UNIT	FAN	TYPE	CROSS FLOW FAN	
		DRIVE	DIRECT	
	FAN SPEED	HIGH	RPM	1322
		MEDIUM	RPM	1240
		LOW	RPM	1112
	FAN EFFICIENCY	HIGH	%	N/A
		MEDIUM	%	N/A
LOW		%	N/A	
FAN MOTOR	TYPE	INDUCTION		
	INDEX OF PROTECTION (IP)	IPX0		
	INSULATION GRADE	B		
	RATED INPUT POWER	HIGH	W	74
		MEDIUM	W	59
		LOW	W	46
	RATED RUNNING CURRENT	HIGH	A	0.32
		MEDIUM	A	0.26
		LOW	A	0.21
	STARTING CURRENT		A	N/A
	MOTOR OUTPUT		W	40
	MOTOR EFFICIENCY	HIGH	%	N/A
MEDIUM		%	N/A	
LOW		%	N/A	
POLES			4	
COIL	TUBE	MATERIAL	COPPER	
		DIAMETER	mm	9.52
	FIN	MATERIAL	ALUMINIUM	
		FACE AREA	m ²	0.29
	ROW			2
WATER VOLUME	litre	1.425		
AIR QUALITY	FILTER	TYPE	WASHABLE SARANET FILTER	
		QUANTITY	pc	2
CASING	COLOUR	WHITE		

MODE	COOLING	HEATING
ENTERING AIR TEMPERATURE	27°C DB / 19°C WB	20°C DB
ENTERING WATER TEMPERATURE	7°C	50°C (2 Pipes System) 70°C (4 Pipes System)
LEAVING WATER TEMPERATURE	12°C	45°C (2 Pipes System) 60°C (4 Pipes System)

ALL SPECIFICATIONS ARE SUBJECTED TO CHANGE BY THE MANUFACTURER WITHOUT PRIOR NOTICE.

Engineering Data - Chilled Water Fan Coil Unit

MODEL			MCK020AW	MCK025AW	MCK030AW	MCK040AW	MCK050AW	
NOMINAL COOLING CAPACITY	Btu/h		22500	25500	30000	33500	36500	
	W		6590	7470	8790	9820	10700	
NOMINAL SENSIBLE COOLING CAPACITY	Btu/h		16700	18400	21800	24200	26250	
	W		4890	5390	6390	7090	7690	
NOMINAL HEATING CAPACITY (ENTERING WATER TEMP. = 50°C)	Btu/h		28500	32000	37500	40500	44000	
	W		8350	9380	10990	11870	12900	
NOMINAL TOTAL INPUT POWER	W		127	151	164	192	253	
NOMINAL RUNNING CURRENT	A		0.52	0.64	0.68	0.79	1.06	
POWER SOURCE	V/Ph/Hz		220-240 / 1 / 50					
REFRIGERANT TYPE			N/A					
CONTROL	AIR DISCHARGE OPERATION		4 WAY AUTOMATIC LOUVER (UP & DOWN)					
			LCD WIRELESS MICRO-COMPUTER REMOTE CONTROL					
AIR FLOW	HIGH	CFM	771	812	918	1024	1083	
	MEDIUM	CFM	665	695	777	900	989	
	LOW	CFM	630	630	712	789	906	
NOMINAL WATER FLOW RATE	USGPM		5.00	5.68	6.65	7.53	8.19	
	litres/min		18.93	21.50	25.17	28.50	31.00	
HEAD LOSS (COOLING)	kPa		24.8	30.8	41.6	52.2	69.3	
HEAD LOSS (HEATING) : 50°C	kPa		21.4	26.8	35.3	45.2	64.1	
MAX. WORKING PRESSURE	kPa		1608					
SURFACE AIR VELOCITY	m/s		0.77	0.82	0.92	1.03	1.09	
SOUND PRESSURE LEVEL (H/M/L)	dB(A)		42 / 39 / 37	45 / 42 / 40	49 / 45 / 43	51 / 48 / 46	53 / 52 / 50	
UNIT DIMENSION - () WITH PANEL	H X W X D		305 X 824 X 824 (355 X 930 X 930)					
PACKING DIMENSION - () PANEL	H X W X D		371 X 916 X 916 (121 X 1000 X 1016)					
UNIT WEIGHT (UNIT + PANEL)	kg		25 + 4	36 + 4	38 + 4	42 + 4	44 + 4	
CONDENSATE DRAIN SIZE	mm		19.05					
PIPE CONNECTION	mm		19.05					
FAN	TYPE		TURBO FAN					
	DRIVE		DIRECT					
	FAN SPEED	HIGH	RPM	440	500	570	620	655
		MEDIUM	RPM	380	440	480	550	590
		LOW	RPM	360	400	440	490	560
	FAN EFFICIENCY	HIGH	%	23.80	30.00	31.90	34.30	28.80
MEDIUM		%	27.70	29.10	32.80	34.90	30.80	
LOW		%	28.00	29.30	37.60	35.90	32.50	
FAN MOTOR	TYPE		INDUCTION					
	INDEX OF PROTECTION (IP)		IP22					
	INSULATION GRADE		B					
	RATED INPUT POWER	HIGH	W	127	151	164	192	253
		MEDIUM	W	115	122	139	155	208
		LOW	W	102	105	122	121	183
	RATED RUNNING CURRENT	HIGH	A	0.52	0.64	0.68	0.79	1.06
		MEDIUM	A	0.47	0.51	0.58	0.64	0.87
		LOW	A	0.42	0.45	0.51	0.50	0.78
	STARTING CURRENT	A	0.58	0.71	0.87	0.92	1.37	
	MOTOR OUTPUT	W	35	45	60	83	120	
MOTOR EFFICIENCY	HIGH	%	22.00	25.80	30.80	30.70	37.70	
	MEDIUM	%	19.70	21.40	24.10	27.40	31.80	
	LOW	%	18.50	19.10	21.50	23.90	29.40	
POLES		8						
COIL	TUBE	MATERIAL	COPPER					
		DIAMETER	9.53					
	FIN	MATERIAL	ALUMINIUM					
		FACE AREA	0.47					
ROW		2						
WATER VOLUME		litre						
AIR QUALITY FILTER	TYPE		WASHABLE SARANET FILTER					
	QUANTITY		1					
CASING	COLOUR		LIGHT GREY					

MODE	COOLING	HEATING
ENTERING AIR TEMPERATURE	27°C DB / 19°C WB	20°C DB
ENTERING WATER TEMPERATURE	7°C	50°C (2 Pipes System)
		70°C (4 Pipes System)
LEAVING WATER TEMPERATURE	12°C	45°C (2 Pipes System)
		60°C (4 Pipes System)

ALL SPECIFICATIONS ARE SUBJECT TO CHANGE BY THE MANUFACTURER WITHOUT PRIOR NOTICE.

Engineering Data - Chilled Water Fan Coil Unit

MODEL			MCK020AWH	MCK025AWH	MCK030AWH	MCK040AWH	MCK050AWH	
NOMINAL COOLING CAPACITY	Btu/h		13000	13500	15500	17000	17500	
	W		3810	3960	4540	4980	5130	
NOMINAL SENSIBLE COOLING CAPACITY	Btu/h		11600	12010	13850	15000	15500	
	W		3400	3520	4060	4400	4540	
NOMINAL HEATING CAPACITY (ENTERING WATER TEMP. = 50°C)	Btu/h		36000	37500	42500	45500	46500	
	W		10550	10990	12480	13340	13630	
NOMINAL TOTAL INPUT POWER	W		122	138	153	184	232	
NOMINAL RUNNING CURRENT	A		0.53	0.61	0.67	0.80	1.02	
POWER SOURCE	V/Ph/Hz		220-240 / 1 / 50					
REFRIGERANT TYPE			N/A					
CONTROL	AIR DISCHARGE OPERATION		4 WAY AUTOMATIC LOUVER (UP & DOWN) LCD WIRELESS MICRO-COMPUTER REMOTE CONTROL					
AIR FLOW	HIGH	CFM	771	812	918	1024	1083	
	MEDIUM	CFM	665	695	777	900	989	
	LOW	CFM	630	630	712	789	906	
NOMINAL WATER FLOW RATE	USGPM		2.90	3.00	3.52	3.80	3.92	
	litres/min		11.00	11.40	13.30	14.40	14.80	
HEAD LOSS (COOLING)	kPa		3.6	3.8	4.9	5.7	6.0	
HEAD LOSS (HEATING) : 50°C	kPa		4.8	5.5	7.2	8.5	8.8	
MAX. WORKING PRESSURE	kPa		1608					
SURFACE AIR VELOCITY	m/s		0.77	0.82	0.92	1.03	1.09	
SOUND PRESSURE LEVEL (H/M/L)			42 / 39 / 37	45 / 42 / 40	49 / 45 / 43	51 / 48 / 46	53 / 52 / 50	
UNIT DIMENSION - () WITH PANEL	H X W X D	mm	305 X 824 X 824 (355 X 930 X 930)					
PACKING DIMENSION - () PANEL	H X W X D	mm	371 X 916 X 916 (121 X 1000 X 1016)					
UNIT WEIGHT (UNIT + PANEL)	kg		25 + 4	36 + 4	38 + 4	42 + 4	44 + 4	
CONDENSATE DRAIN SIZE	mm		19.05					
PIPE CONNECTION	mm		19.05					
FAN	TYPE		TURBO FAN					
	DRIVE		DIRECT					
	FAN SPEED	HIGH	RPM	440	500	570	620	700
		MEDIUM	RPM	380	440	480	550	640
		LOW	RPM	360	400	440	490	600
	FAN EFFICIENCY	HIGH	%	N/A	N/A	N/A	N/A	N/A
MEDIUM		%	N/A	N/A	N/A	N/A	N/A	
LOW		%	N/A	N/A	N/A	N/A	N/A	
FAN MOTOR	TYPE		INDUCTION					
	INDEX OF PROTECTION (IP)		IP22					
	INSULATION GRADE		B					
	RATED INPUT POWER	HIGH	W	122	138	153	184	232
		MEDIUM	W	110	111	129	149	190
		LOW	W	98	96	113	116	167
	RATED RUNNING CURRENT	HIGH	A	0.53	0.61	0.67	0.80	1.02
		MEDIUM	A	0.48	0.49	0.57	0.65	0.84
		LOW	A	0.43	0.43	0.50	0.51	0.74
	STARTING CURRENT	A		0.58	0.71	0.87	0.92	1.37
MOTOR OUTPUT	W		35	45	60	83	120	
MOTOR EFFICIENCY	HIGH	%	N/A	N/A	N/A	N/A	N/A	
	MEDIUM	%	N/A	N/A	N/A	N/A	N/A	
	LOW	%	N/A	N/A	N/A	N/A	N/A	
POLES			8					
COIL	TUBE	MATERIAL	COPPER					
		DIAMETER	mm	9.53				
	FIN	MATERIAL	ALUMINIUM					
		FACE AREA	m ²	0.47				
WATER VOLUME	litre	1.34						
AIR QUALITY CASING	FILTER	TYPE	WASHABLE SARANET FILTER					
		QUANTITY	pc	1				
	COLOUR		LIGHT GREY					

MODE	COOLING	HEATING
ENTERING AIR TEMPERATURE	27°C DB / 19°C WB	20°C DB
ENTERING WATER TEMPERATURE	7°C	50°C (2 Pipes System)
		70°C (4 Pipes System)
LEAVING WATER TEMPERATURE	12°C	45°C (2 Pipes System)
		60°C (4 Pipes System)

ALL SPECIFICATIONS ARE SUBJECT TO CHANGE BY THE MANUFACTURER WITHOUT PRIOR NOTICE.

Engineering Data - Chilled Water Fan Coil Unit

MODEL			MCK010CW	MCK015CW	MCK020CW	
NOMINAL COOLING CAPACITY	Btu/h		8500	14000	15500	
	W		2490	4100	4540	
NOMINAL SENSIBLE COOLING CAPACITY	Btu/h		6500	10000	11500	
	W		1910	2930	3370	
NOMINAL HEATING CAPACITY (ENTERING WATER TEMP. = 50°C)	Btu/h		12000	16000	18000	
	W		3520	4690	5280	
NOMINAL TOTAL INPUT POWER	W		63	64	79	
NOMINAL RUNNING CURRENT	A		0.28	0.28	0.35	
POWER SOURCE	V/Ph/Hz		220-240 / 1 / 50			
REFRIGERANT TYPE			N/A			
CONTROL	AIR DISCHARGE OPERATION		4 WAY AUTOMATIC LOUVER (UP & DOWN)			
			LCD WIRELESS MICRO-COMPUTER REMOTE CONTROL			
AIR FLOW	HIGH	CFM	380	400	440	
	MEDIUM	CFM	290	310	330	
	LOW	CFM	230	220	280	
NOMINAL WATER FLOW RATE	USGPM		2.03	3.43	3.57	
	litres/min		7.68	12.98	13.51	
HEAD LOSS (COOLING)	kPa		19.3	26.9	28.8	
HEAD LOSS (HEATING) : 50°C	kPa		16.8	23.9	26.5	
MAX. WORKING PRESSURE	kPa		1608			
SURFACE AIR VELOCITY	m/s		0.75	0.76	0.83	
SOUND PRESSURE LEVEL (H/M/L)	dba		42 / 35 / 29	45 / 38 / 30	48 / 40 / 36	
UNIT DIMENSION - () WITH PANEL	H X W X D	mm	250 X 570 X 570 (295 X 640 X 640)			
PACKING DIMENSION - () PANEL	H X W X D	mm	316 X 630 X 630 (126 X 700 X 726)			
UNIT WEIGHT (UNIT + PANEL)	kg		15 + 3	17 + 3	17 + 3	
CONDENSATE DRAIN SIZE	mm		19.05			
PIPE CONNECTION	mm		19.05			
FAN	TYPE		TURBO FAN			
	DRIVE		DIRECT			
	FAN SPEED	HIGH	RPM	725	810	900
		MEDIUM	RPM	565	630	700
		LOW	RPM	460	480	610
	FAN EFFICIENCY	HIGH	%	38.30	46.90	25.90
		MEDIUM	%	35.10	45.40	32.30
LOW		%	46.70	46.10	21.50	
FAN MOTOR	TYPE		INDUCTION			
	INDEX OF PROTECTION (IP)		IP20			
	INSULATION GRADE		B			
	RATED INPUT POWER	HIGH	W	63	64	79
		MEDIUM	W	51	58	73
		LOW	W	46	52	69
	RATED RUNNING CURRENT	HIGH	A	0.28	0.28	0.35
		MEDIUM	A	0.23	0.25	0.32
		LOW	A	0.21	0.24	0.31
	STARTING CURRENT	A		0.32	0.30	0.47
	MOTOR OUTPUT	W		17	23	32
MOTOR EFFICIENCY	HIGH	%	32.20	44.50	49.20	
	MEDIUM	%	20.50	23.60	24.00	
	LOW	%	12.30	11.20	14.80	
POLES		6				
COIL	TUBE	MATERIAL	COPPER			
		DIAMETER	7.00			
	FIN	MATERIAL	ALUMINIUM			
		FACE AREA	m ²	0.24	0.25	0.25
ROW		2				
WATER VOLUME		litre	0.43	0.83	0.83	
AIR QUALITY CASING	FILTER	TYPE	WASHABLE SARANET FILTER			
		QUANTITY	1			
		COLOUR	LIGHT GREY			

MODE	COOLING	HEATING
ENTERING AIR TEMPERATURE	27°C DB / 19°C WB	20°C DB
ENTERING WATER TEMPERATURE	7°C	50°C (2 Pipes System)
		70°C (4 Pipes System)
LEAVING WATER TEMPERATURE	12°C	45°C (2 Pipes System)
		60°C (4 Pipes System)

ALL SPECIFICATIONS ARE SUBJECT TO CHANGE BY THE MANUFACTURER WITHOUT PRIOR NOTICE.

Engineering Data - Chilled Water Fan Coil Unit

MODEL			MCK020EW	MCK025EW	MCK030EW	MCK040EW	MCK050EW	
NOMINAL COOLING CAPACITY	Btu/h		21000	25000	30000	38000	43000	
	W		6150	7330	8790	11140	12600	
NOMINAL SENSIBLE COOLING CAPACITY	Btu/h		15900	19200	22300	27400	31000	
	W		4660	5630	6540	8030	9090	
NOMINAL HEATING CAPACITY (ENTERING WATER TEMP. = 50°C)	Btu/h		28000	33600	38300	45500	52000	
	W		8210	9850	11230	13340	15240	
NOMINAL TOTAL INPUT POWER	W		95	126	167	186	227	
NOMINAL RUNNING CURRENT	A		0.44	0.55	0.74	0.85	1.03	
POWER SOURCE	V/Ph/Hz		220-240 / 1 / 50					
REFRIGERANT TYPE			N/A					
CONTROL	AIR DISCHARGE OPERATION		4 WAY AUTOMATIC LOUVER (UP & DOWN)					
			LCD WIRELESS MICRO-COMPUTER REMOTE CONTROL					
AIR FLOW	HIGH	CFM	750	860	890	1000	1140	
	MEDIUM	CFM	620	700	720	840	1000	
	LOW	CFM	480	540	570	680	840	
	QUIET	CFM	320	380	420	540	700	
NOMINAL WATER FLOW RATE	USGPM		4.45	5.59	6.69	8.45	9.60	
	litres/min		16.82	21.17	25.29	31.94	36.29	
HEAD LOSS (COOLING)	kPa		20	37	22	44	53	
HEAD LOSS (HEATING) : 50°C	kPa		19	33	19	38	47	
MAX. WORKING PRESSURE	kPa		1608					
SURFACE AIR VELOCITY	m/s		0.91	1.04	1.14	1.03	1.17	
SOUND PRESSURE LEVEL (H/M/L/Q)	dBA		42 / 38 / 32 / 23	46 / 42 / 35 / 27	48 / 43 / 38 / 30	48 / 43 / 39 / 33	51 / 48 / 43 / 39	
UNIT DIMENSION - () WITH PANEL	H X W X D	mm	265 X 820 X 820 (300 X 900 X 900)			300 X 820 X 820 (335 X 900 X 900)		
PACKING DIMENSION - () PANEL	H X W X D	mm	300 X 900 X 900 (110 X 1120 X 1120)					
UNIT WEIGHT (UNIT + PANEL)	kg		26 + 4	26 + 4	28 + 4	32 + 4	32 + 4	
CONDENSATE DRAIN SIZE	mm		19.05					
PIPE CONNECTION	mm		19.05					
FAN	TYPE DRIVE		TURBO FAN DIRECT					
	FAN SPEED	HIGH	RPM	530	600	660	710	800
		MEDIUM	RPM	450	500	550	610	710
		LOW	RPM	360	400	450	510	610
	FAN EFFICIENCY	HIGH	%	N/A	N/A	N/A	N/A	N/A
		MEDIUM	%	N/A	N/A	N/A	N/A	N/A
		LOW	%	N/A	N/A	N/A	N/A	N/A
FAN MOTOR	TYPE		INDUCTION					
	INDEX OF PROTECTION (IP)		IP20					
	INSULATION GRADE		B					
	RATED INPUT POWER	HIGH	W	95	126	167	186	227
		MEDIUM	W	79	103	109	151	176
		LOW	W	67	89	86	118	144
	RATED RUNNING CURRENT	HIGH	A	0.44	0.55	0.74	0.85	1.03
		MEDIUM	A	0.40	0.45	0.49	0.71	0.82
		LOW	A	0.36	0.39	0.39	0.57	0.69
	STARTING CURRENT	A	0.44	0.71	0.89	1.02	1.28	
MOTOR OUTPUT	W	30	45	65	80	110		
MOTOR EFFICIENCY	HIGH	%	N/A	N/A	N/A	N/A	N/A	
	MEDIUM	%	N/A	N/A	N/A	N/A	N/A	
	LOW	%	N/A	N/A	N/A	N/A	N/A	
POLES		8						
COIL	TUBE MATERIAL		COPPER					
	DIAMETER		7.00					
	FIN MATERIAL	FACE AREA	m ²	0.39	0.39	0.37	0.46	0.46
		ROW		2	2	3	3	3
		WATER VOLUME	litre	1.36	1.34	1.97	2.35	2.35
AIR QUALITY	FILTER TYPE		WASHABLE SARANET FILTER					
	QUANTITY		1					
CASING	COLOUR		LIGHT GREY					

MODE	COOLING	HEATING
ENTERING AIR TEMPERATURE	27°C DB / 19°C WB	20°C DB
ENTERING WATER TEMPERATURE	7°C	50°C (2 Pipes System)
		70°C (4 Pipes System)
		45°C (2 Pipes System)
LEAVING WATER TEMPERATURE	12°C	45°C (2 Pipes System)
		60°C (4 Pipes System)

ALL SPECIFICATIONS ARE SUBJECT TO CHANGE BY THE MANUFACTURER WITHOUT PRIOR NOTICE.

Engineering Data - Chilled Water Fan Coil Unit

MODEL			MCM20DW	MCM25DW	MCM30DW	MCM40DW	MCM50DW	
NOMINAL COOLING CAPACITY	Btu/h		17700	20800	24600	31200	45000	
	W		5190	6100	7210	9140	13190	
NOMINAL SENSIBLE COOLING CAPACITY	Btu/h		13650	15000	17700	25600	31400	
	W		4000	4400	5190	7500	9200	
NOMINAL HEATING CAPACITY (ENTERING WATER TEMP. = 50°C)	Btu/h		22000	25900	28000	42300	51500	
	W		6450	7590	8210	12400	15090	
NOMINAL TOTAL INPUT POWER	W		96	130	132	240	240	
NOMINAL RUNNING CURRENT	A		0.41	0.54	0.57	0.98	1.03	
POWER SOURCE	V/Ph/Hz		220-240 / 1 / 50					
REFRIGERANT TYPE			N/A					
CONTROL	AIR DISCHARGE OPERATION		AUTOMATIC LOUVER (UP & DOWN)					
			LCD WIRELESS MICRO-COMPUTER REMOTE CONTROL					
AIR FLOW	HIGH	CFM	560	630	698	956	1060	
	MEDIUM	CFM	505	620	688	908	1023	
	LOW	CFM	400	555	650	889	956	
NOMINAL WATER FLOW RATE	USGPM		3.92	4.62	5.46	6.91	9.99	
	litres/min		14.80	17.50	20.70	26.15	37.81	
HEAD LOSS (COOLING)	kPa		45.6	55.7	49.4	24.0	37.7	
HEAD LOSS (HEATING) : 50°C	kPa		39.2	48.1	43.0	21.5	31.6	
MAX. WORKING PRESSURE	kPa		1608					
SURFACE AIR VELOCITY	m/s		1.39	1.56	1.37	1.22	1.35	
SOUND PRESSURE LEVEL (H/M/L/Q)	dB(A)		50 / 47 / 40	54 / 53 / 50	51 / 50 / 48	54 / 53 / 52	54 / 53 / 52	
UNIT DIMENSION - () WITH PANEL	H X W X D	mm	214 X 1214 X 670		249 X 1214 X 670		249 X 1714 X 670	
PACKING DIMENSION - () PANEL	H X W X D	mm	301 X 1311 X 760		354 X 1376 X 766		354 X 1876 X 766	
UNIT WEIGHT (UNIT + PANEL)	kg		43	43	45	70	70	
CONDENSATE DRAIN SIZE	mm		19.05					
PIPE CONNECTION	mm		19.05					
FAN	TYPE		BLOWER FAN					
	DRIVE		DIRECT					
	FAN SPEED	HIGH	RPM	1200	600	1400	1430	1430
		MEDIUM	RPM	1100	500	1370	1390	1390
		LOW	RPM	890	400	1260	1340	1340
	FAN EFFICIENCY	HIGH	%	N/A	N/A	N/A	N/A	N/A
MEDIUM		%	N/A	N/A	N/A	N/A	N/A	
LOW		%	N/A	N/A	N/A	N/A	N/A	
FAN MOTOR	TYPE		INDUCTION					
	INDEX OF PROTECTION (IP)		IP22					
	INSULATION GRADE		B					
	RATED INPUT POWER	HIGH	W	96	130	132	240	240
		MEDIUM	W	86	120	121	193	193
		LOW	W	76	108	108	169	169
	RATED RUNNING CURRENT	HIGH	A	0.41	0.54	0.57	0.98	1.03
		MEDIUM	A	0.37	0.44	0.51	0.8	0.83
		LOW	A	0.33	0.34	0.46	0.70	0.73
	STARTING CURRENT	A		0.44	0.71	0.89	1.02	1.28
MOTOR OUTPUT	W		40	65	65	100	120	
MOTOR EFFICIENCY	HIGH	%	N/A	N/A	N/A	N/A	N/A	
	MEDIUM	%	N/A	N/A	N/A	N/A	N/A	
	LOW	%	N/A	N/A	N/A	N/A	N/A	
POLES		4						
COIL	TUBE	MATERIAL	COPPER					
		DIAMETER	9.53					
	FIN	MATERIAL	ALUMINIUM					
		FACE AREA	m ²	0.19	0.19	0.24	0.37	0.37
ROW		3						
WATER VOLUME		litre	1.68	1.68	2.09	4.25	4.25	
AIR QUALITY CASING	FILTER	TYPE	WASHABLE SARANET FILTER					
		QUANTITY	2					
COLOUR		LIGHT GREY						

MODE	COOLING	HEATING
ENTERING AIR TEMPERATURE	27°C DB / 19°C WB	20°C DB
ENTERING WATER TEMPERATURE	7°C	50°C (2 Pipes System)
		70°C (4 Pipes System)
LEAVING WATER TEMPERATURE	12°C	45°C (2 Pipes System)
		60°C (4 Pipes System)

ALL SPECIFICATIONS ARE SUBJECT TO CHANGE BY THE MANUFACTURER WITHOUT PRIOR NOTICE.

Engineering Data - Chilled Water Fan Coil Unit

MODEL				MCM15EW	MCM20EW	MCM25EW
NOMINAL COOLING CAPACITY	Btu/h			15500	20300	21000
	W			4540	5950	6150
NOMINAL SENSIBLE COOLING CAPACITY	Btu/h			12700	15400	16150
	W			3720	4510	4730
NOMINAL HEATING CAPACITY (ENTERING WATER TEMP. = 50°C)	Btu/h			19500	25000	28000
	W			5720	7330	8210
NOMINAL TOTAL INPUT POWER	W			101	109	113
NOMINAL RUNNING CURRENT	A			0.46	0.49	0.52
POWER SOURCE	V/Ph/Hz			220-240 / 1 / 50		
REFRIGERANT TYPE				N/A		
CONTROL	AIR DISCHARGE OPERATION			AUTOMATIC LOUVER (UP & DOWN)		
				LCD WIRELESS MICRO-COMPUTER REMOTE CONTROL		
AIR FLOW	HIGH	CFM		500	580	620
	MEDIUM	CFM		450	530	570
	LOW	CFM		400	490	520
NOMINAL WATER FLOW RATE	USGPM			3.43	4.49	4.67
	litres/min			13.00	17.00	17.68
HEAD LOSS (COOLING)	kPa			27.4	48.1	57.1
HEAD LOSS (HEATING) : 50°C	kPa			24.2	42.1	50.2
MAX. WORKING PRESSURE	kPa			1608		
SURFACE AIR VELOCITY	m/s			0.87	1.01	1.08
SOUND PRESSURE LEVEL	dB(A)			50 / 43 / 41	53 / 51 / 49	56 / 51 / 44
UNIT DIMENSION	H X W X D		mm	212 X 1090 X 630		
PACKING DIMENSION	H X W X D		mm	297 X 1197 X 740		
UNIT WEIGHT	kg			27	27	27
CONDENSATE DRAIN SIZE	mm			19.05		
PIPE CONNECTION	mm			12.70		
FAN	TYPE DRIVE			BLOWER DIRECT		
	FAN SPEED	HIGH	RPM	1192	1346	1380
		MEDIUM	RPM	945	1238	1300
		LOW	RPM	871	1143	1200
	FAN EFFICIENCY	HIGH	%	N/A	N/A	N/A
		MEDIUM	%	N/A	N/A	N/A
		LOW	%	N/A	N/A	N/A
FAN MOTOR	TYPE			INDUCTION		
	INDEX OF PROTECTION (IP)			IP22		
	INSULATION GRADE			B		
	RATED INPUT POWER	HIGH	W	101	109	113
		MEDIUM	W	98	108	115
		LOW	W	94	107	113
	RATED RUNNING CURRENT	HIGH	A	0.46	0.49	0.52
		MEDIUM	A	0.43	0.47	0.51
		LOW	A	0.41	0.47	0.51
	STARTING CURRENT	A		5.20	10.30	24.00
	MOTOR OUTPUT	W		50	65	70
MOTOR EFFICIENCY	HIGH	%	N/A	N/A	N/A	
	MEDIUM	%	N/A	N/A	N/A	
	LOW	%	N/A	N/A	N/A	
POLES			4	4	4	
COIL	TUBE MATERIAL		COPPER			
	DIAMETER		mm			
	FIN MATERIAL		ALUMINIUM			
	FACE AREA		m ²			
WATER VOLUME	ROW		0.27	0.27	0.27	
	ROW		3	3	3	
AIR QUALITY FILTER	TYPE		WASHABLE SARANET FILTER			
	QUANTITY		2			
CASING	COLOUR		LIGHT GREY			

MODE	COOLING	HEATING
ENTERING AIR TEMPERATURE	27°C DB / 19°C WB	20°C DB
ENTERING WATER TEMPERATURE	7°C	50°C (2 Pipes System)
		70°C (4 Pipes System)
LEAVING WATER TEMPERATURE	12°C	45°C (2 Pipes System)
		60°C (4 Pipes System)

ALL SPECIFICATIONS ARE SUBJECT TO CHANGE BY THE MANUFACTURER WITHOUT PRIOR NOTICE.

Engineering Data - Chilled Water Fan Coil Unit

MODEL			MCC010CW	MCC015CW	MCC020CW	MCC025CW	MCC028CW	
NOMINAL COOLING CAPACITY	Btu/h		9900	11600	18000	22500	20800	
	W		2900	3400	5280	6590	6100	
NOMINAL SENSIBLE COOLING CAPACITY	Btu/h		7000	8120	12600	15750	17000	
	W		2050	2380	3690	4620	4980	
	Btu/h		11500	15000	23000	29000	29100	
NOMINAL HEATING CAPACITY (ENTERING WATER TEMP. = 50°C)	W		3370	4400	6740	8500	8530	
NOMINAL TOTAL INPUT POWER	W		89	140	168	182	277	
NOMINAL RUNNING CURRENT	A		0.40	0.65	0.77	0.86	1.28	
POWER SOURCE	V/Ph/Hz		220-240 / 1 / 50					
REFRIGERANT TYPE	N/A							
CONTROL	AIR DISCHARGE OPERATION		DUCTED					
			WIRED MICRO-COMPUTER REMOTE CONTROL					
AIR FLOW	HIGH	CFM	300	510	700	730	835	
	MEDIUM	CFM	285	490	675	660	670	
	LOW	CFM	260	400	640	580	550	
EXTERNAL STATIC PRESSURE	Pa		49 / 44 / 36	49 / 42 / 28	49 / 45 / 41	49 / 43 / 30	98 / 64 / 44	
NOMINAL WATER FLOW RATE	USGPM		2.20	2.60	4.05	5.06	4.67	
	litres/min		8.33	9.84	15.33	19.15	17.68	
HEAD LOSS (COOLING)	kPa		10.5	24.0	20.1	32.4	14.0	
HEAD LOSS (HEATING) : 50°C	kPa		8.8	20.3	17.0	27.6	12.0	
MAX. WORKING PRESSURE	kPa		1608					
SURFACE AIR VELOCITY	m/s		1.29	1.72	1.83	1.72	1.64	
SOUND PRESSURE LEVEL (H/M/L)	dBA		36 / 35 / 33	40 / 38 / 33	42 / 41 / 40	41 / 40 / 36	41 / 38 / 34	
UNIT DIMENSION	H X W X D	mm	266 X 702 X 351	267 X 842 X 351	267 X 1002 X 351	267 X 1137 X 351	296 X 920 X 521	
PACKING DIMENSION	H X W X D	mm	376 X 951 X 541	376 X 1091 X 541	376 X 1251 X 541	376 X 1386 X 541	343 X 1138 X 690	
UNIT WEIGHT	kg		18	22	24	26	35	
CONDENSATE DRAIN SIZE	mm		19.05					
PIPE CONNECTION	mm		19.05					
FAN	TYPE		BLOWER					
	DRIVE		DIRECT					
	FAN SPEED	HIGH	RPM	1221	1211	1410	1355	1266
		MEDIUM	RPM	1172	1047	1328	1215	1196
		LOW	RPM	1123	835	1133	937	1150
	FAN EFFICIENCY	HIGH	%	38.70	42.90	39.70	36.20	45.00
		MEDIUM	%	40.70	51.90	47.50	38.10	44.50
		LOW	%	43.00	50.30	48.90	39.10	45.90
FAN MOTOR	TYPE		INDUCTION					
	INDEX OF PROTECTION (IP)		IP20					
	INSULATION GRADE		B					
	RATED INPUT POWER	HIGH	W	89	140	168	182	277
		MEDIUM	W	86	128	165	175	180
		LOW	W	78	127	163	163	158
	RATED RUNNING CURRENT	HIGH	A	0.40	0.65	0.77	0.86	1.28
		MEDIUM	A	0.39	0.59	0.73	0.77	0.81
		LOW	A	0.35	0.59	0.71	0.71	0.72
	STARTING CURRENT	A		0.73	1.66	1.22	1.86	1.61
	MOTOR OUTPUT	W		38	72	80	100	320
	MOTOR EFFICIENCY	HIGH	%	47.90	49.70	56.40	57.50	57.90
MEDIUM		%	42.40	39.60	50.90	48.40	47.10	
LOW		%	33.60	24.80	44.10	30.40	30.90	
COIL	POLES		4					
	TUBE	MATERIAL	COPPER					
		DIAMETER	mm	9.52				
	FIN	MATERIAL	ALUMINIUM					
		FACE AREA	m ²	0.11	0.14	0.18	0.20	0.24
		ROW		3				
WATER VOLUME	litre		0.94	1.15	1.43	1.63	1.98	
AIR QUALITY FILTER	TYPE		N/A					
	QUANTITY		N/A					
CASING	COLOUR		LIGHT GREY					

MODE	COOLING	HEATING
ENTERING AIR TEMPERATURE	27°C DB / 19°C WB	20°C DB
ENTERING WATER TEMPERATURE	7°C	50°C (2 Pipes System)
		70°C (4 Pipes System)
		45°C (2 Pipes System)
LEAVING WATER TEMPERATURE	12°C	60°C (4 Pipes System)

ALL SPECIFICATIONS ARE SUBJECTED TO CHANGE BY THE MANUFACTURER WITHOUT PRIOR NOTICE.

Engineering Data - Chilled Water Fan Coil Unit

MODEL			MCC030CW	MCC038CW	MCC040CW	MCC050CW	MCC060CW	
NOMINAL COOLING CAPACITY	Btu/h		24800	38000	37000	44700	51800	
	W		7270	11140	10840	13100	15180	
NOMINAL SENSIBLE COOLING CAPACITY	Btu/h		19700	29800	29300	35100	40900	
	W		5770	8730	8590	10290	11990	
NOMINAL HEATING CAPACITY (ENTERING WATER TEMP. = 50°C)	Btu/h		32800	49200	48000	54900	65300	
	W		9610	14420	14070	16090	19140	
NOMINAL TOTAL INPUT POWER	W		345	504	442	427	530	
NOMINAL RUNNING CURRENT	A		1.50	2.28	1.93	1.86	2.31	
POWER SOURCE	V/Ph/Hz		220-240 / 1 / 50					
REFRIGERANT TYPE			N/A					
CONTROL	AIR DISCHARGE OPERATION		DUCTED					
			WIRED MICRO-COMPUTER REMOTE CONTROL					
AIR FLOW	HIGH	CFM	830	1250	1240	1340	1550	
	MEDIUM	CFM	760	1130	1100	1220	1400	
	LOW	CFM	710	1040	1020	1190	1300	
EXTERNAL STATIC PRESSURE	Pa		167 / 128 / 88	118 / 108 / 88	128 / 88 / 39	157 / 137 / 108	157 / 137 / 98	
NOMINAL WATER FLOW RATE	USGPM		5.55	8.59	8.28	10.04	11.62	
	litres/min		21.01	32.51	31.34	38.00	43.98	
HEAD LOSS (COOLING)	kPa		14.0	39.0	23.0	38.0	51.0	
HEAD LOSS (HEATING) : 50°C	kPa		11.0	37.0	19.0	33.0	48.0	
MAX. WORKING PRESSURE	kPa		1608					
SURFACE AIR VELOCITY	m/s		1.40	1.74	1.83	1.54	1.52	
SOUND PRESSURE LEVEL (H/M/L)	dB(A)		46 / 42 / 38	51 / 48 / 45	49 / 45 / 41	52 / 50 / 47	53 / 50 / 47	
UNIT DIMENSION	H X W X D	mm	384 X 917 X 462	316 X 1225 X 559	384 X 1003 X 462	384 X 1287 X 462	384 X 1487 X 462	
PACKING DIMENSION	H X W X D	mm	415 X 1126 X 631	355 X 1461 X 727	415 X 1245 X 631	415 X 1497 X 631	415 X 1701 X 631	
UNIT WEIGHT		kg	42	47	44	50	56	
CONDENSATE DRAIN SIZE		mm	19.05					
PIPE CONNECTION		mm	19.05					
FAN	TYPE	DRIVE	BLOWER					
			DIRECT					
	FAN SPEED	HIGH	RPM	1180	1406	1279	1279	1351
		MEDIUM	RPM	1053	1331	1181	1204	1280
		LOW	RPM	937	1232	1052	1097	1208
	FAN EFFICIENCY	HIGH	%	37.20	46.00	42.20	43.70	41.70
		MEDIUM	%	39.50	49.10	42.90	47.30	43.30
LOW	%	41.60	44.50	44.30	48.70	43.40		
FAN MOTOR	TYPE		INDUCTION					
		INDEX OF PROTECTION (IP)	IP20	IP21	IP22	IP20	IP20	
	INSULATION GRADE		B					
	RATED INPUT POWER	HIGH	W	345	504	442	427	530
		MEDIUM	W	304	380	384	388	457
		LOW	W	270	338	342	373	405
	RATED RUNNING CURRENT	HIGH	A	1.50	2.28	1.93	1.86	2.31
		MEDIUM	A	1.34	1.65	1.69	1.69	2.02
		LOW	A	1.21	1.48	1.54	1.63	1.85
	STARTING CURRENT	A	2.43	2.77	3.18	3.50	4.90	
	MOTOR OUTPUT	W	310	470	355	373	500	
MOTOR EFFICIENCY	HIGH	%	60.80	63.10	63.80	63.00	68.00	
	MEDIUM	%	47.40	60.80	47.50	58.60	59.60	
	LOW	%	34.80	53.00	32.30	49.40	46.10	
POLES		4						
COIL	TUBE	MATERIAL	COPPER					
		DIAMETER	9.52					
	FIN	MATERIAL	ALUMINIUM					
		FACE AREA	m ²	0.28	0.34	0.32	0.41	0.48
		ROW		3	3	3	3	3
WATER VOLUME	litre	2.21	2.66	2.60	3.33	3.80		
AIR QUALITY FILTER	TYPE	N/A						
	QUANTITY	pc	N/A					
CASING	COLOUR	LIGHT GREY						

MODE	COOLING	HEATING
ENTERING AIR TEMPERATURE	27°C DB / 19°C WB	20°C DB
ENTERING WATER TEMPERATURE	7°C	50°C (2 Pipes System)
		70°C (4 Pipes System)
		45°C (2 Pipes System)
LEAVING WATER TEMPERATURE	12°C	60°C (4 Pipes System)

ALL SPECIFICATIONS ARE SUBJECT TO CHANGE BY THE MANUFACTURER WITHOUT PRIOR NOTICE.

Engineering Data - Chilled Water Fan Coil Unit

MODEL		MDB75BW		MDB100BW		MDB125BW		MDB150BW					
NOMINAL COOLING CAPACITY	Btu/h	75600		95000		125000		150000					
	W	22160		27840		36640		43960					
NOMINAL SENSIBLE COOLING CAPACITY	Btu/h	53700		69400		90000		106500					
	W	15740		20340		26380		31210					
NOMINAL HEATING CAPACITY (ENTERING WATER TEMP. = 50°C)	Btu/h	78000		97500		138000		170000					
	W	22860		28580		40450		49820					
NOMINAL TOTAL INPUT POWER	W	760		1800		1620		1910					
NOMINAL RUNNING CURRENT	A	3.49		7.84		3.33		4.03					
POWER SOURCE	V/Ph/Hz	220-240 / 1 / 50				N/A		380-415 / 3 / 50					
REFRIGERANT TYPE		N/A											
CONTROL	AIR DISCHARGE OPERATION		DUCTED										
			WITHOUT CONTROLLER										
AIR FLOW	HIGH	CFM	2500		3200		4200		4600				
	MEDIUM	CFM	2100		3000		N/A		N/A				
	LOW	CFM	1750		2800		N/A		N/A				
EXTERNAL STATIC PRESSURE		Pa	100 / 72 / 50		100 / 80 / 60		230		230				
NOMINAL WATER FLOW RATE		USGPM	16.90		21.10		27.70		33.30				
		litres/min	64.00		80.00		105.00		126.00				
HEAD LOSS (COOLING)		kPa	34.5		42.0		48.8		53.3				
HEAD LOSS (HEATING) : 50°C		kPa	32.9		27.4		31.5		63.2				
MAX. WORKING PRESSURE		kPa	1608										
SURFACE AIR VELOCITY		m/s	2.19		2.80		1.96		2.15				
SOUND PRESSURE LEVEL		dB(A)	50/46/42		54/52/50		58		58				
UNIT DIMENSION		H X W X D	mm				885 X 1640 X 1040						
PACKING DIMENSION		H X W X D	mm				762 X 1605 X 880						
UNIT WEIGHT		kg	92		102		176		189				
CONDENSATE DRAIN SIZE		mm	19.05										
PIPE CONNECTION		mm	28.58										
INDOOR UNIT	FAN	TYPE DRIVE		DIRECT		BLOWER		BELT					
		FAN SPEED	HIGH	RPM	835		950		707				
			MEDIUM	RPM	720		885		N/A				
			LOW	RPM	615		805		N/A				
		FAN EFFICIENCY	HIGH	%	43.30		31.60		N/A				
			MEDIUM	%	43.20		35.00		N/A				
			LOW	%	45.40		38.20		N/A				
		TYPE		INDUCTION									
		INDEX OF PROTECTION (IP)		IP22									
		INSULATION GRADE		B									
FAN MOTOR	RATED INPUT POWER	HIGH	W	760		1800		1620		1910			
		MEDIUM	W	611		1620		N/A		N/A			
		LOW	W	478		1320		N/A		N/A			
	RATED RUNNING CURRENT	HIGH	A	3.49		7.84		3.33		4.03			
		MEDIUM	A	2.86		7.06		N/A		N/A			
		LOW	A	2.32		5.82		N/A		N/A			
	STARTING CURRENT		A	5.20		10.30		24.00		29.00			
	MOTOR OUTPUT		W	375		500		1500		2200			
	MOTOR EFFICIENCY	HIGH	%	58.30		41.00		N/A		N/A			
		MEDIUM	%	42.50		36.60		N/A		N/A			
LOW		%	31.30		31.30		N/A		N/A				
POLES			6		4		4		4				
COIL	TUBE	MATERIAL		COPPER									
		DIAMETER		mm									
	FIN	MATERIAL		ALUMINIUM									
		FACE AREA		m ²		0.54		0.54		1.01		1.01	
		ROW				3		4		3		4	
WATER VOLUME		litre		4.53		6.27		8.14		11.63			
AIR QUALITY	FILTER	TYPE		N/A									
		QUANTITY		pc									
CASING		COLOUR		LIGHT GREY									

MODE	COOLING	HEATING
ENTERING AIR TEMPERATURE	27°C DB / 19°C WB	20°C DB
ENTERING WATER TEMPERATURE	7°C	50°C (2 Pipes System) 70°C (4 Pipes System)
LEAVING WATER TEMPERATURE	12°C	45°C (2 Pipes System) 60°C (4 Pipes System)

ALL SPECIFICATIONS ARE SUBJECT TO CHANGE BY THE MANUFACTURER WITHOUT PRIOR NOTICE.

Outlines & Dimensions

Indoor Unit

Model: MWM07/10/15LW

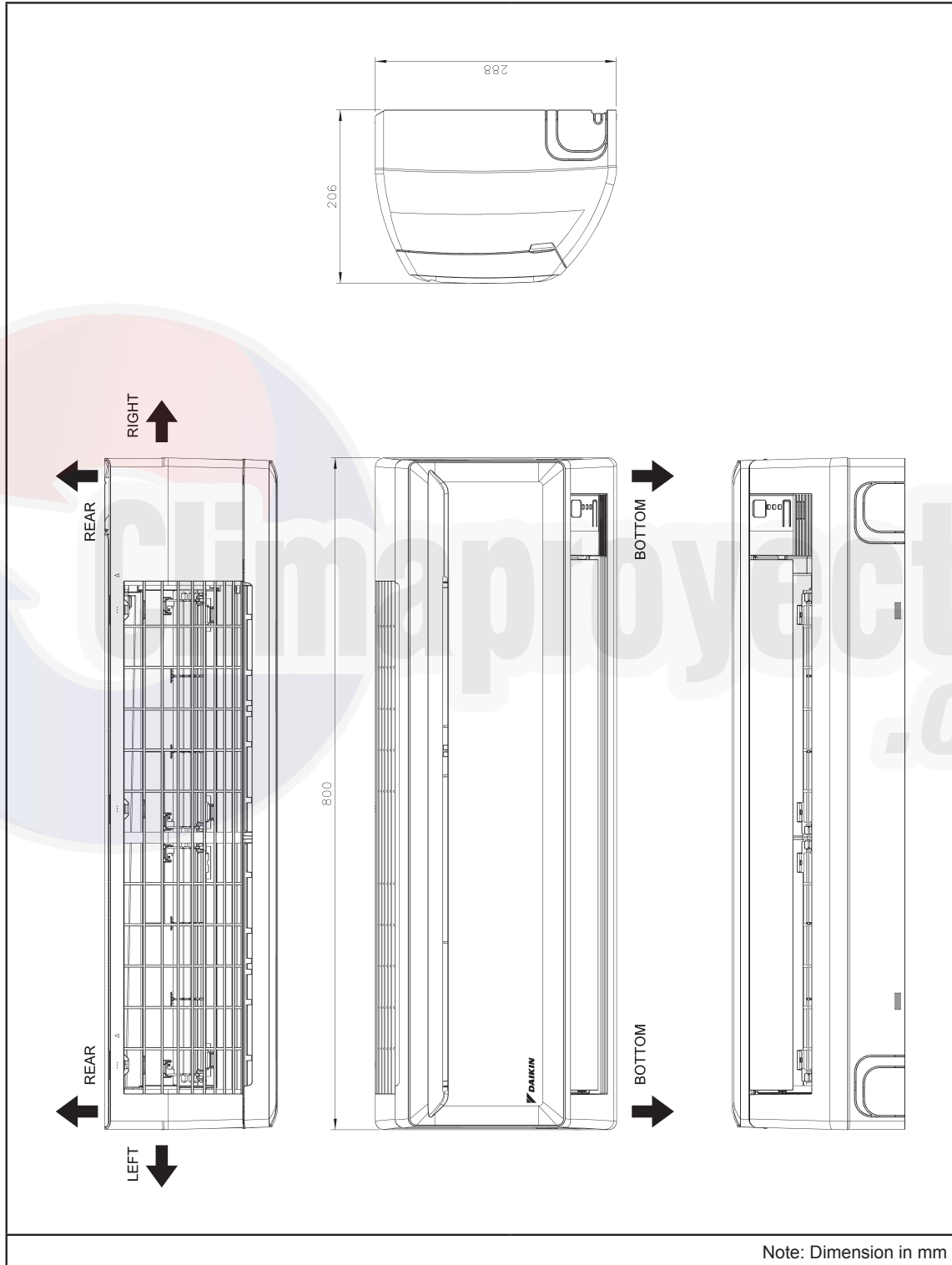

Model: MWM20/25LW

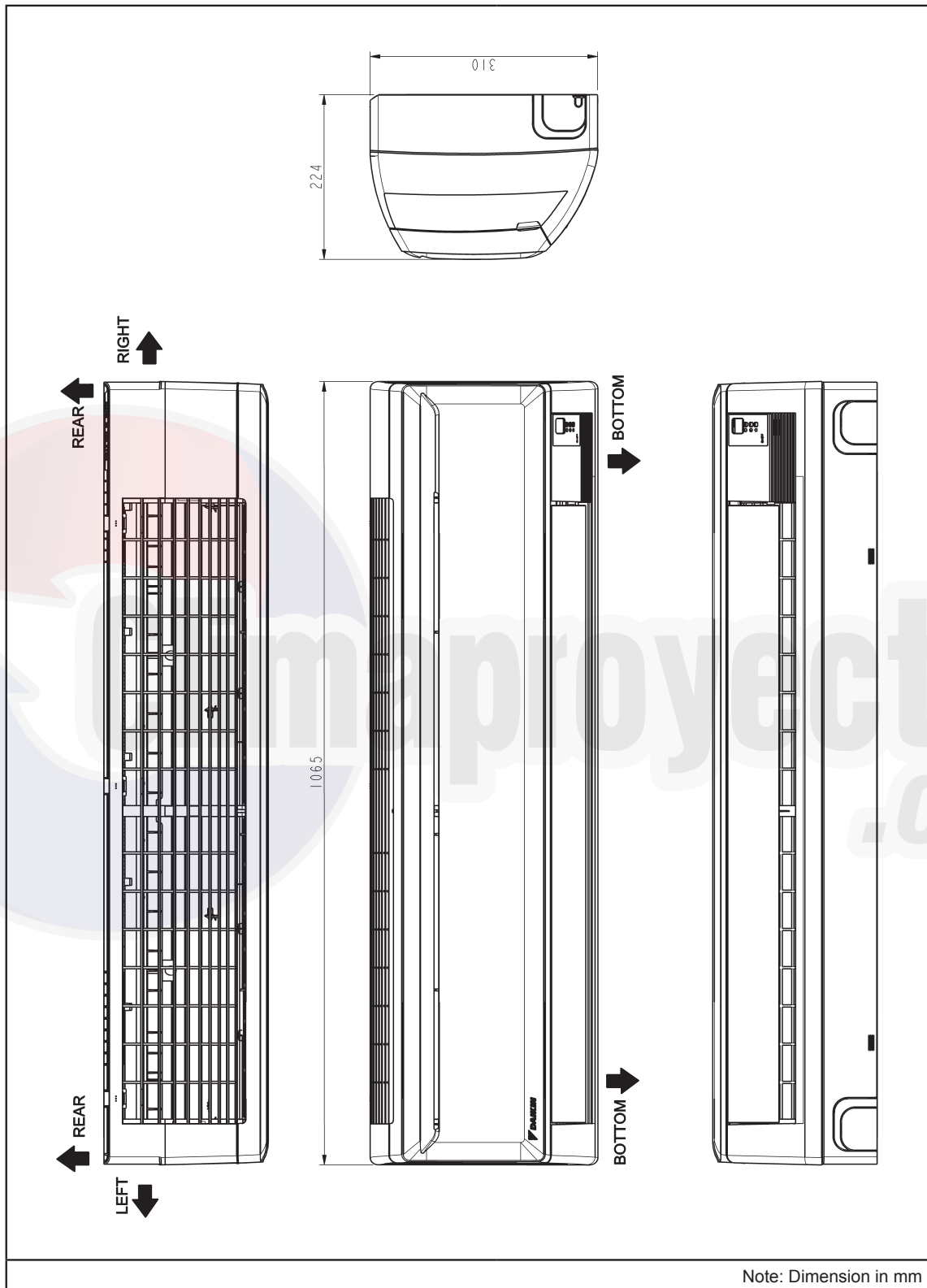

Model: MWM301W

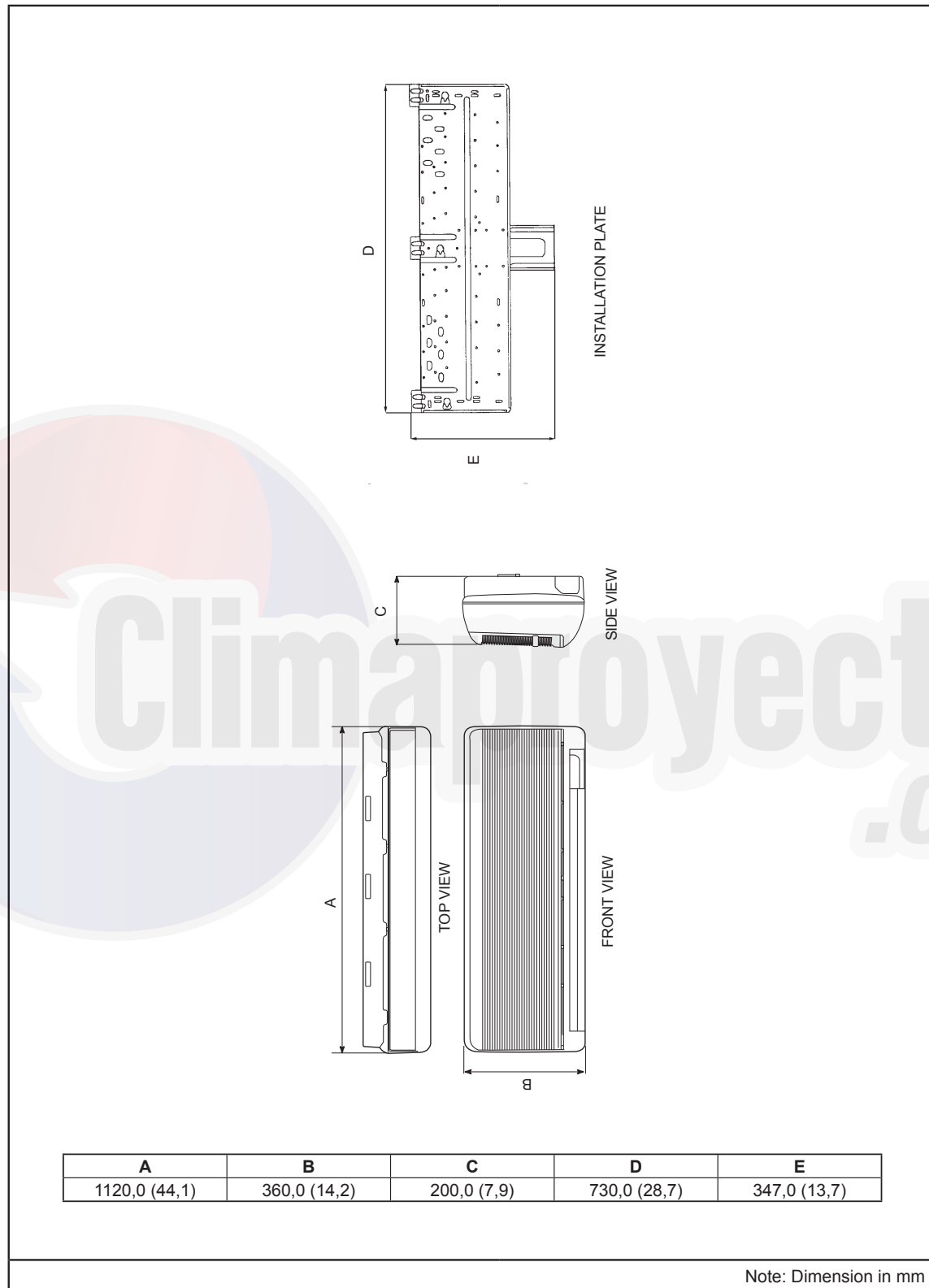

Model: MCK20/25/30/40/50AW

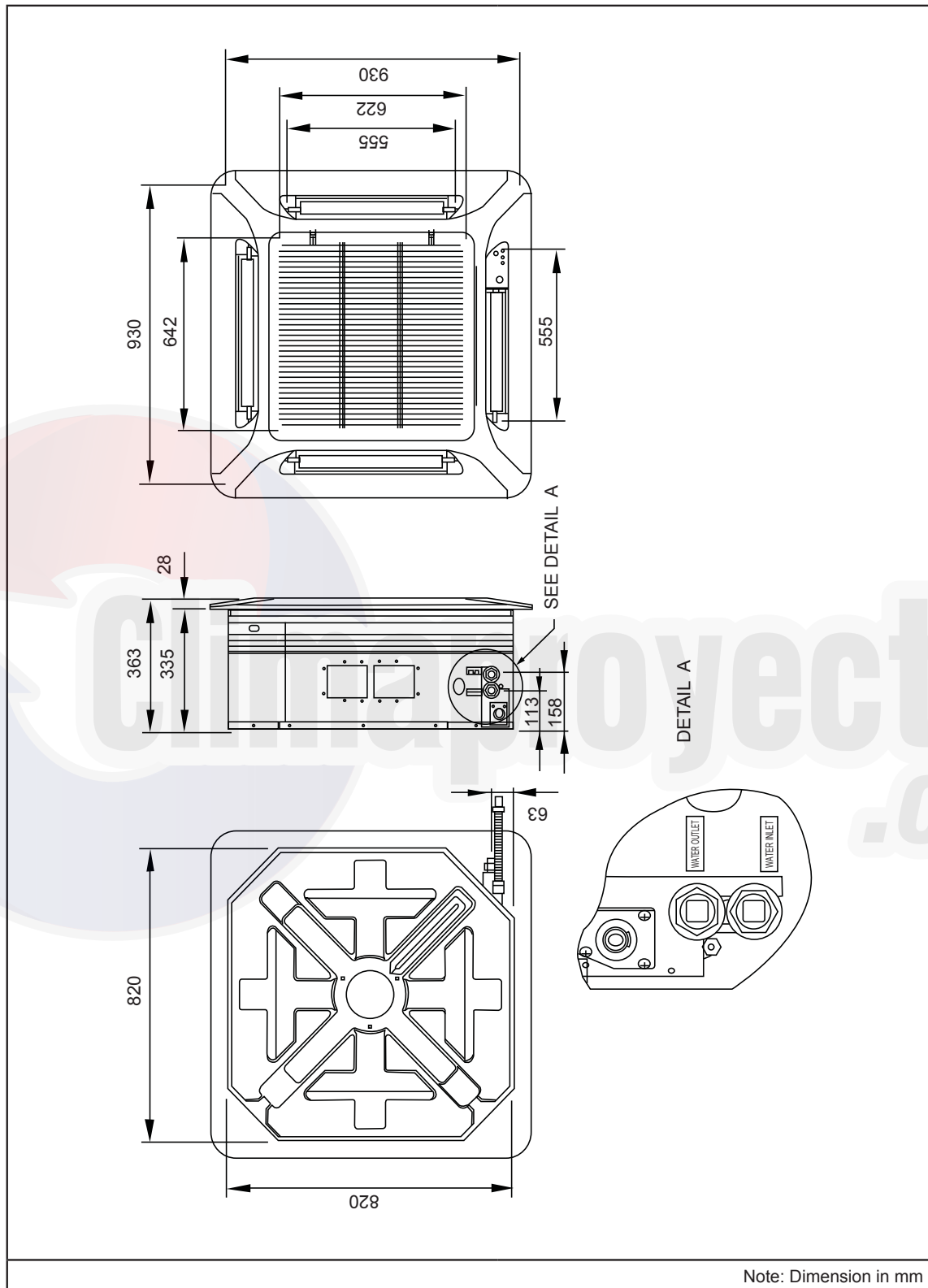

Model: MCK20/25/30/40/50AWH

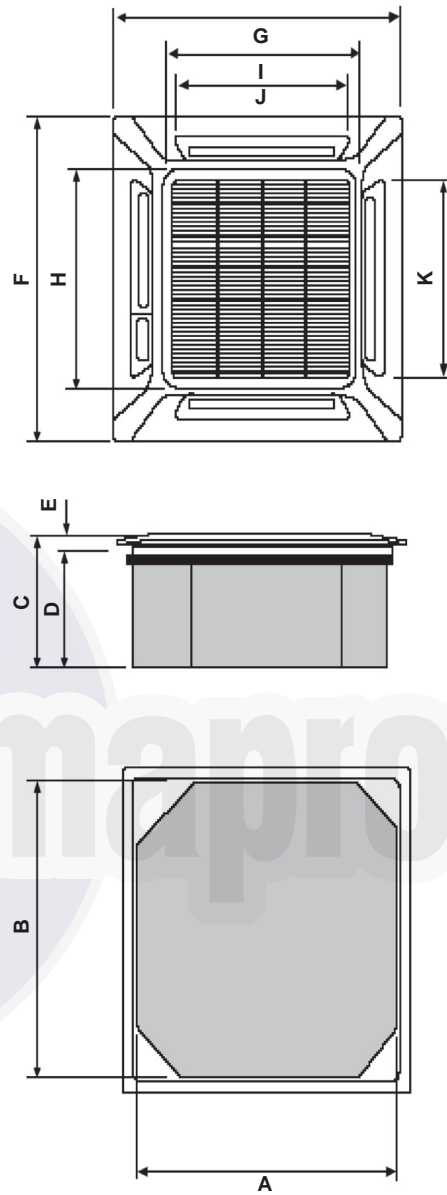

Model	A	B	C	D	E	F	G	H	I	J	K
MCK20AWH	820	820	363	335	28	930	930	642	622	555	555
MCK25AWH	820	820	363	335	28	930	930	642	622	555	555
MCK30AWH	820	820	363	335	28	930	930	642	622	555	555
MCK40AWH	820	820	363	335	28	930	930	642	622	555	555
MCK50AWH	820	820	363	335	28	930	930	642	622	555	555

Note: Dimension in mm

Model: MCK010/015/020CW

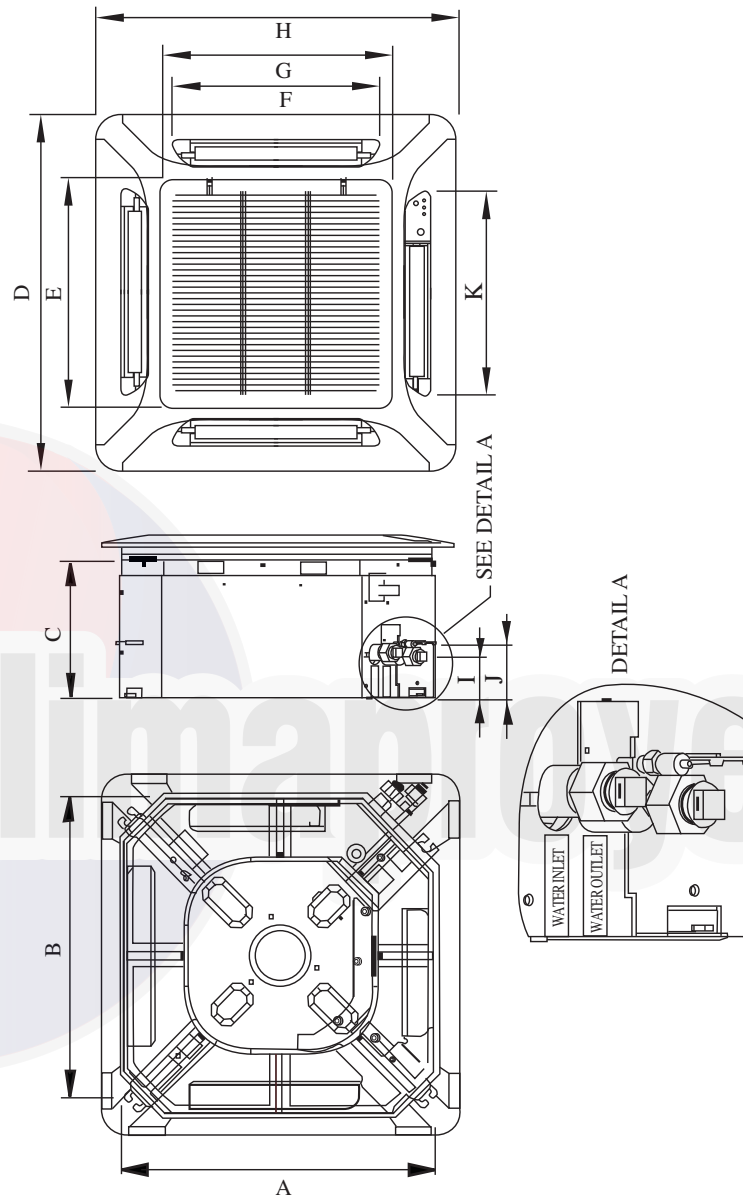

Dimension	A	B	C	D	E	F	G	H	I	J	K
Model											
MCK010CW/ MCK015CW/ MCK020CW	570	570	250	640	408	364	408	640	75	98	364

Note: Dimension in mm

Model: MCK020/025/030/040/050EW

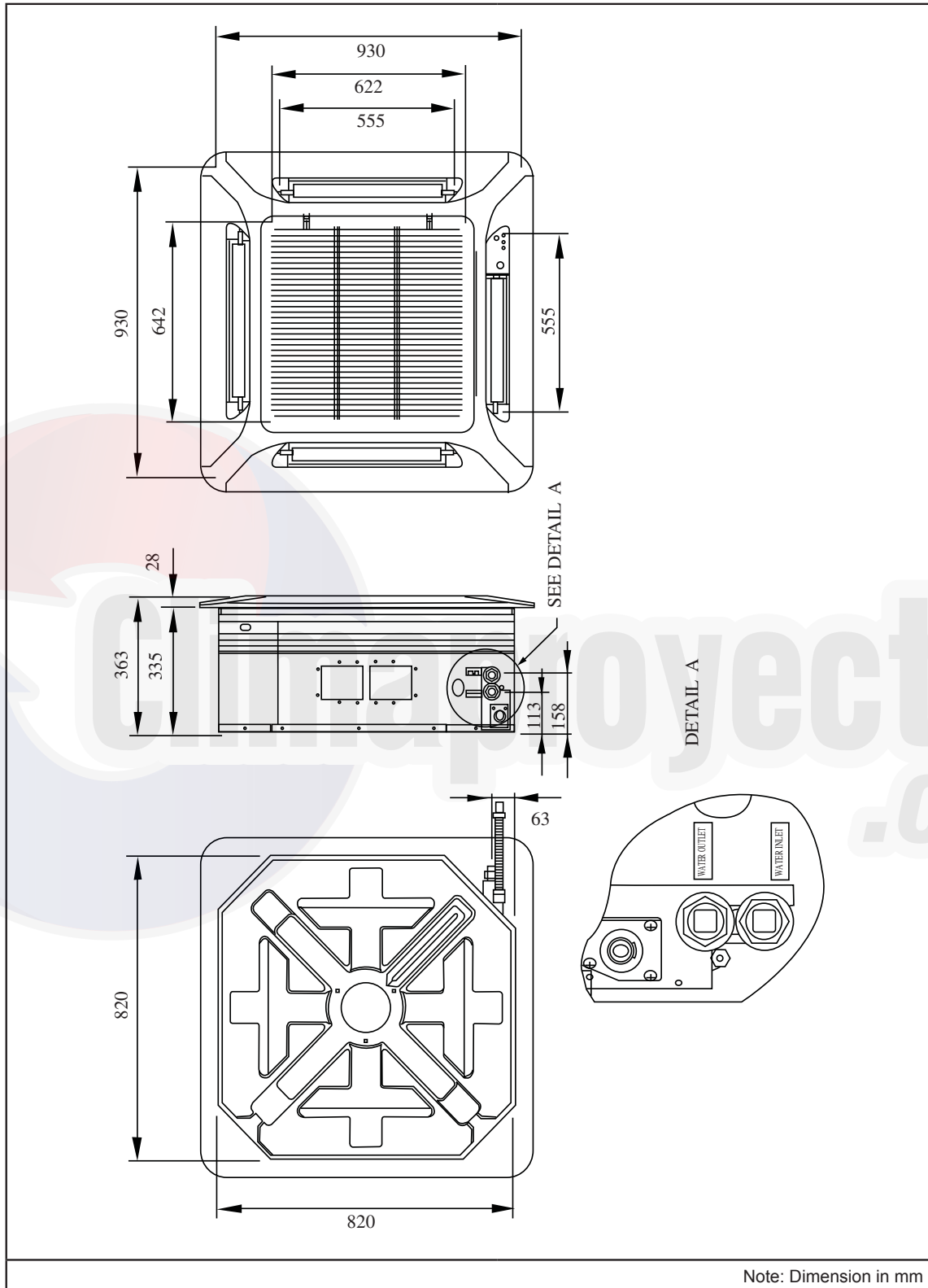

Model: MCM20/25/30/40/50DW

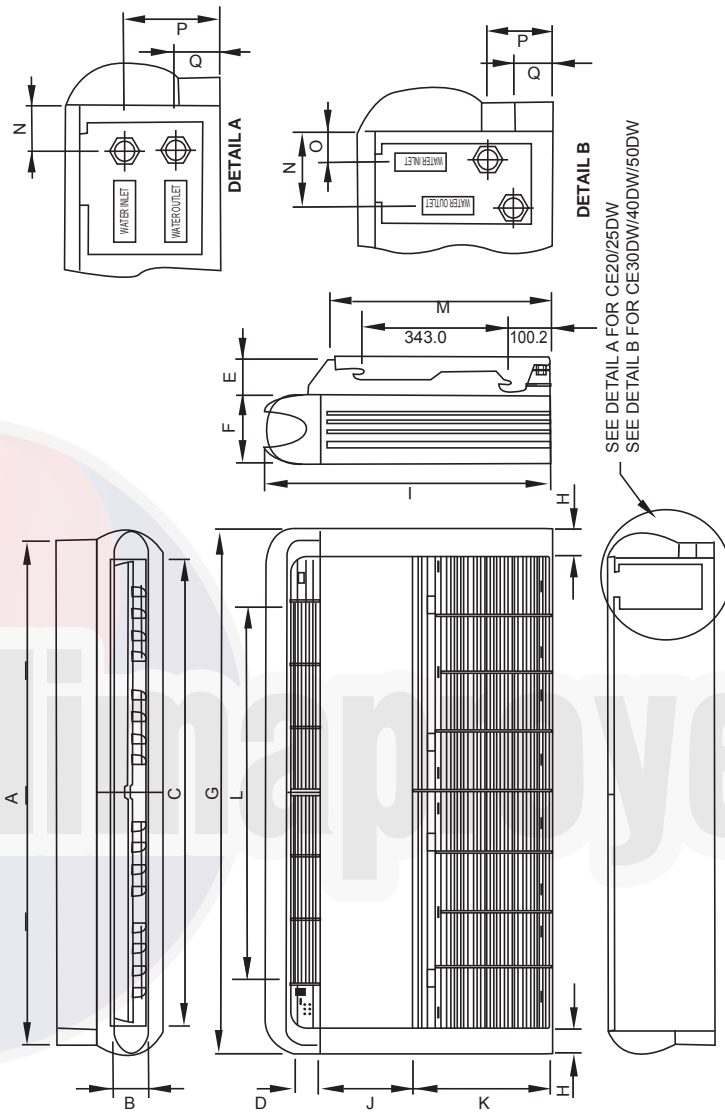

Model	A	B	C	D	E	F	G	H	I	J	K	L	M	N	O	P	Q
MCM20DW	1174	75	1082	68	58	156	1214	57	670	216	319	879	517	65	-	120	40
MCM25DW	1174	75	1082	68	58	156	1214	57	670	216	319	879	517	65	-	120	40
MCM30DW	1174	75	1082	68	93	156	1214	57	670	216	319	879	517	100	47	100	53
MCM40DW	1674	75	1582	68	93	156	1214	57	670	216	319	1379	517	95	40	100	45
MCM50DW	1674	75	1582	68	93	156	1214	57	670	216	319	1379	517	95	40	100	45

Note: Dimension in mm

Model: MCM15/20/25EW

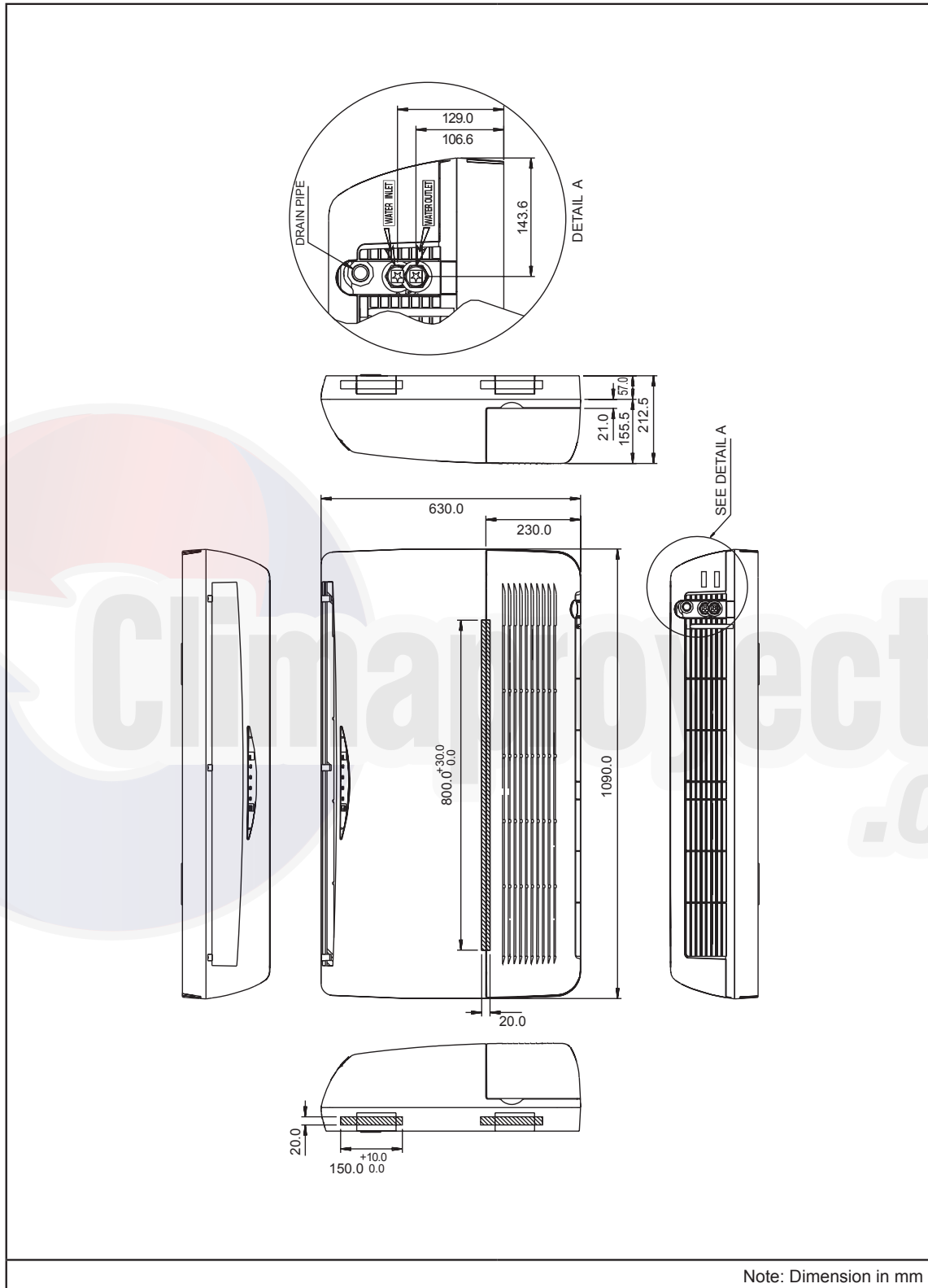

Model: MCC010CW (Left Piping)

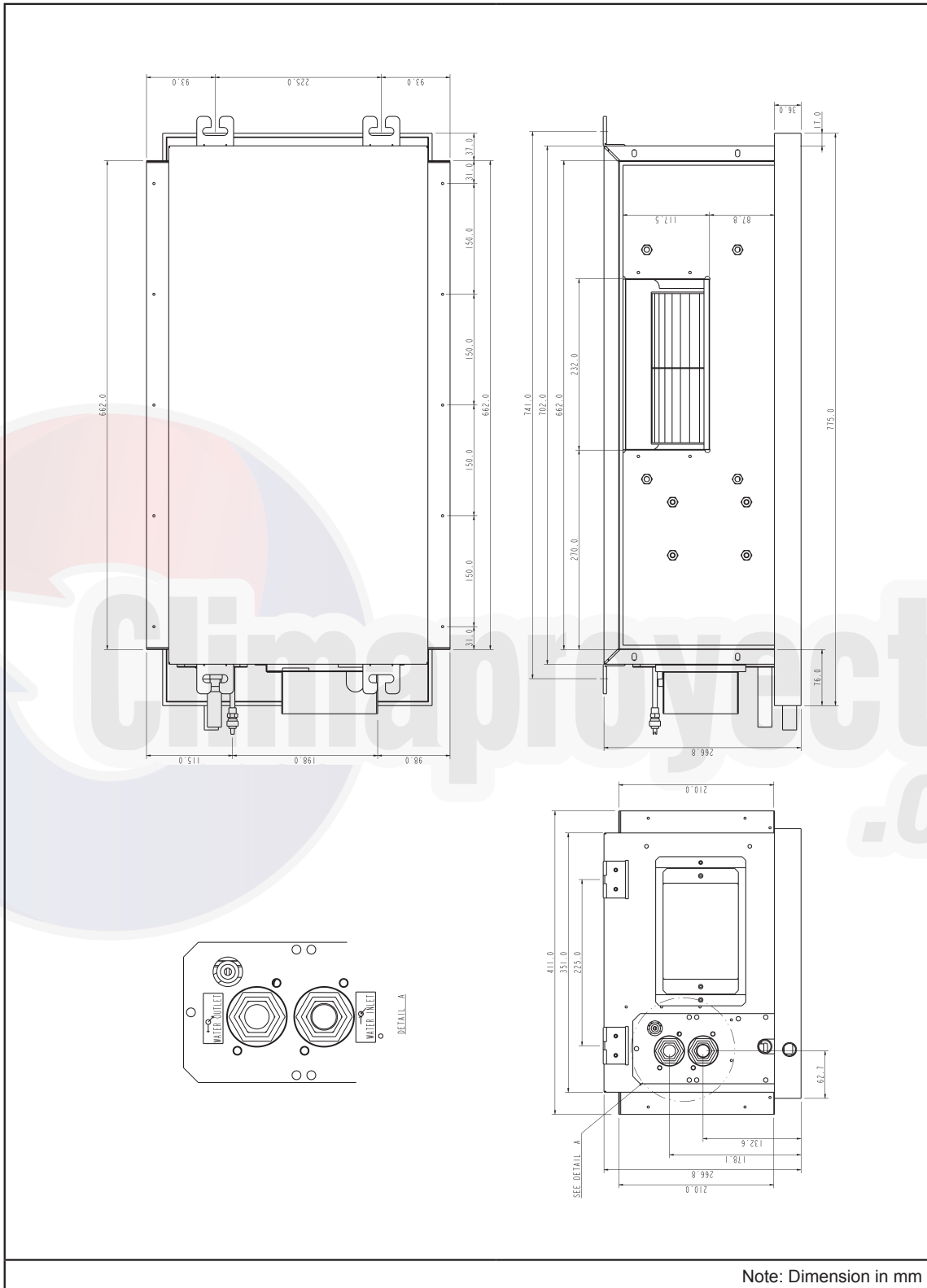

Model: MCC010CW (Right Piping)

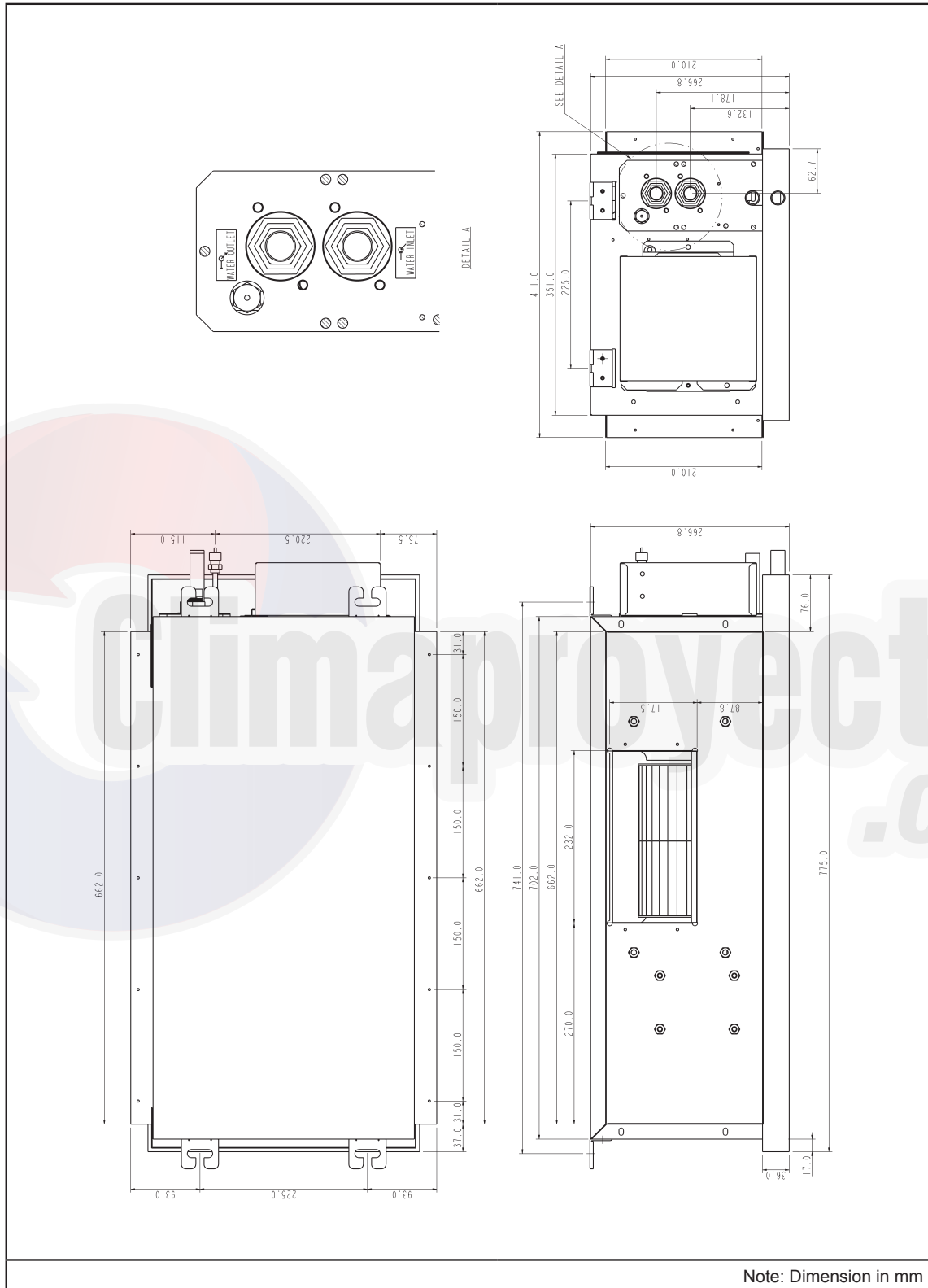

Model: MCC015CW (Left Piping)

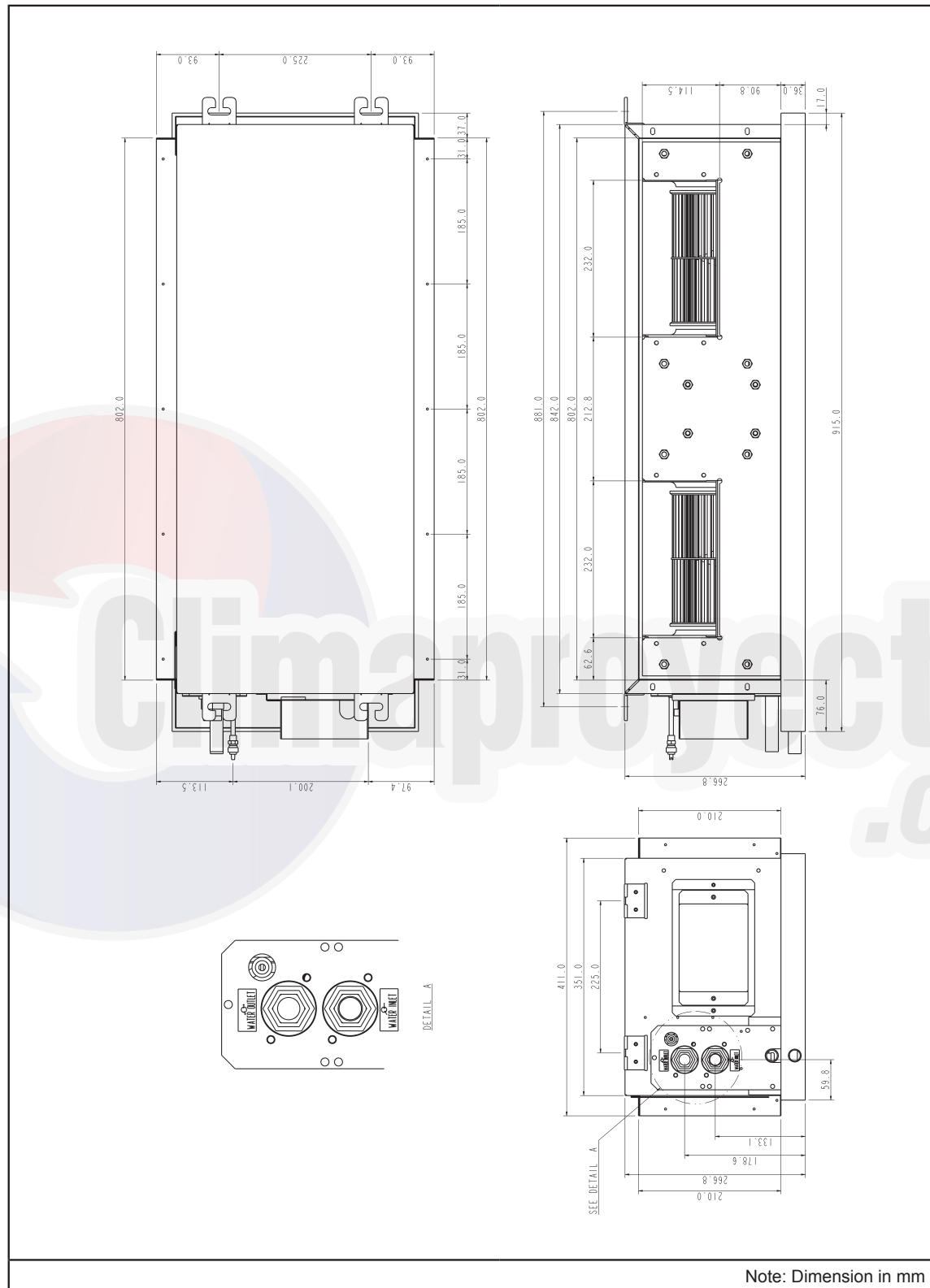

Model: MCC015CW (Right Piping)

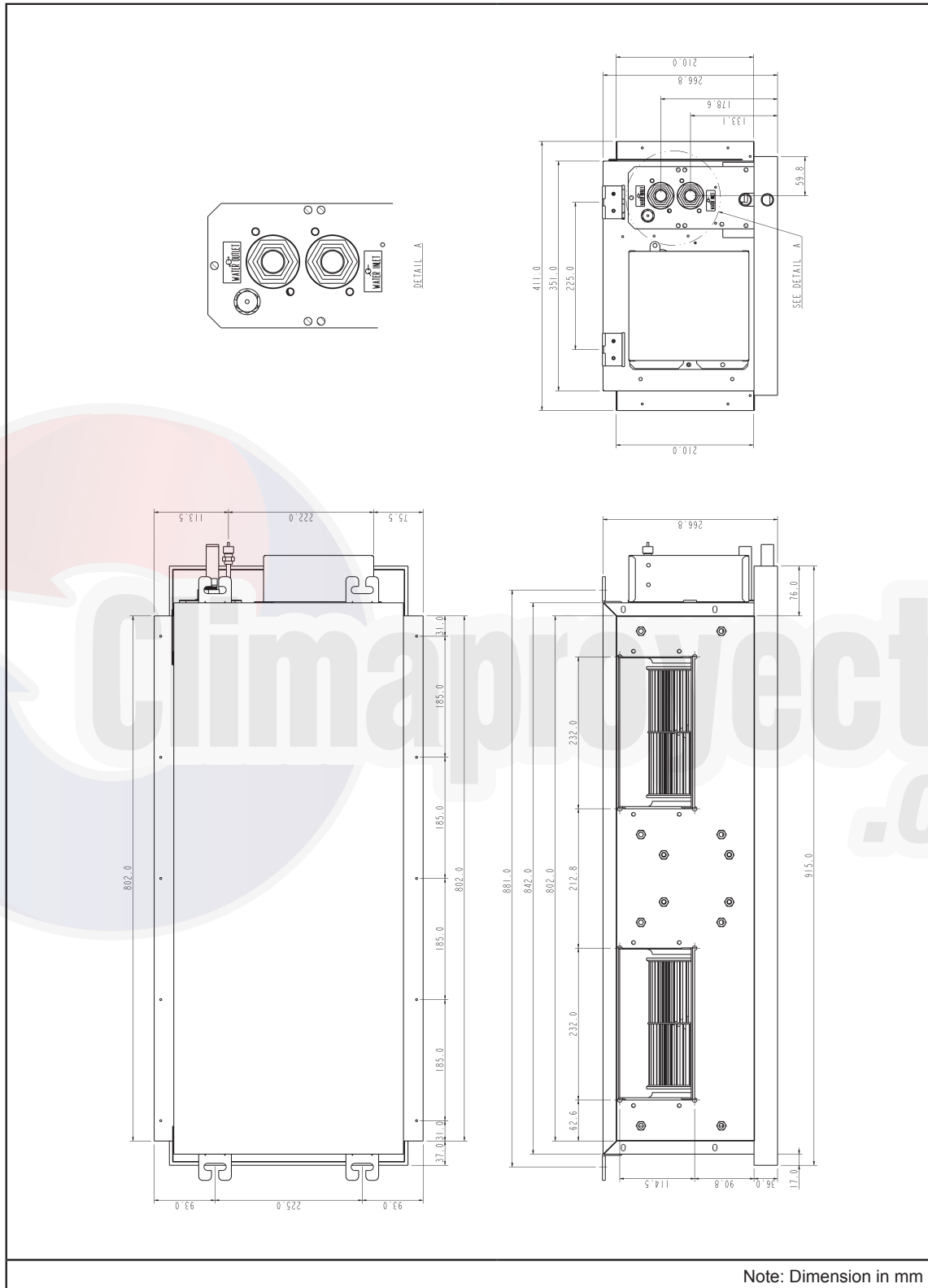

Model: MCC020CW (Left Piping)

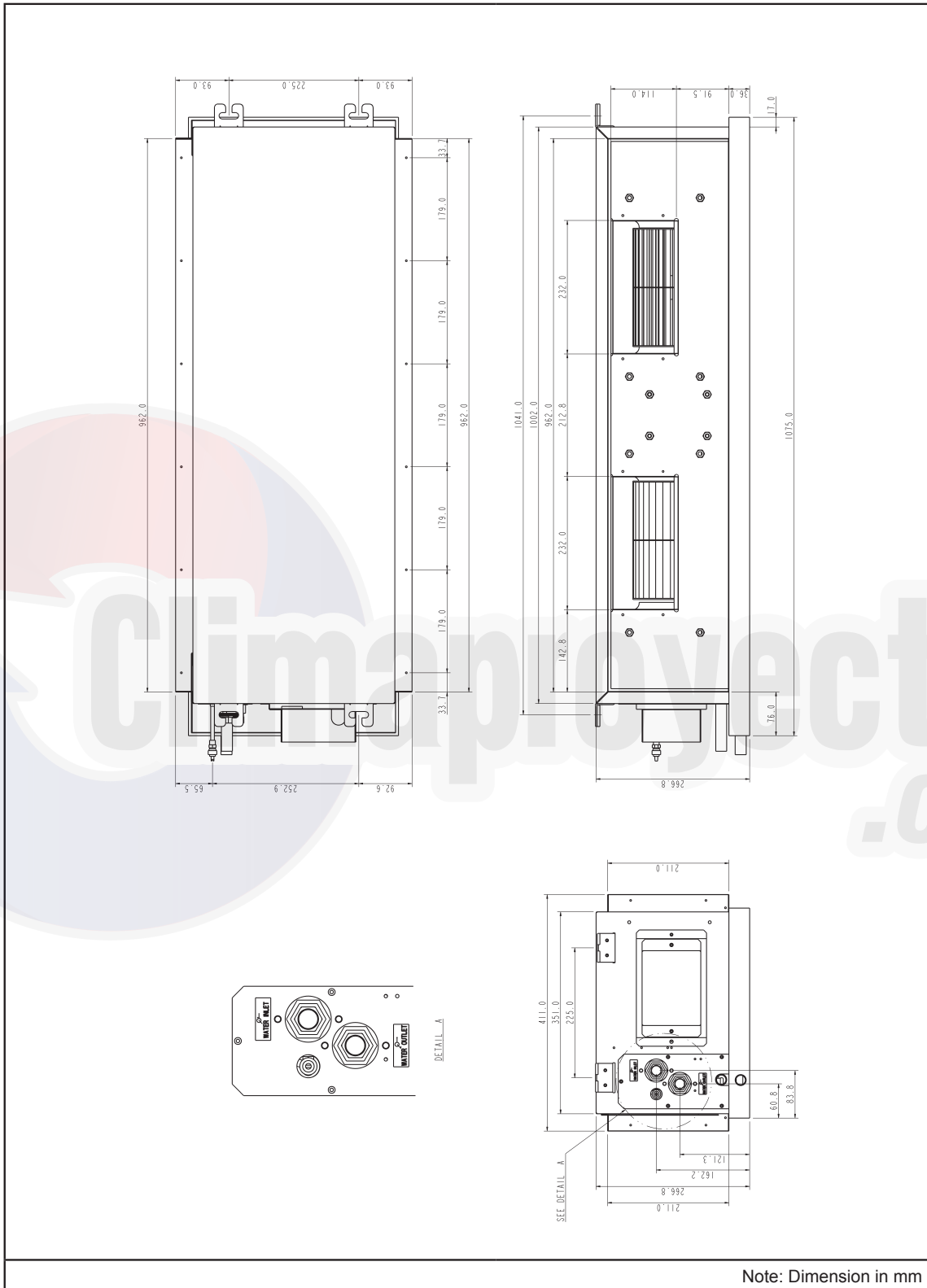

Model: MCC020CW (Right Piping)

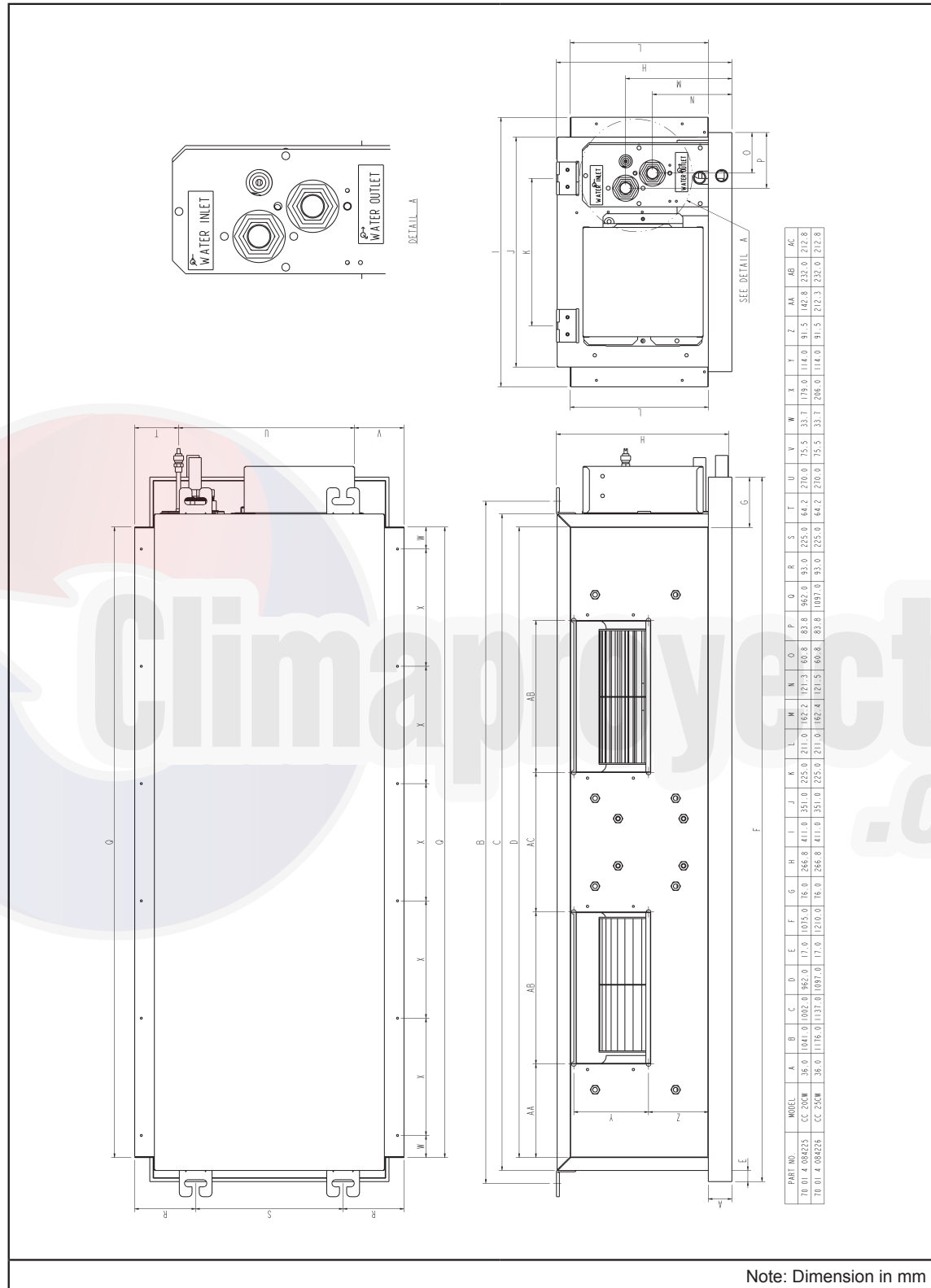

Note: Dimension in mm

Model: MCC025CW (Left Piping)

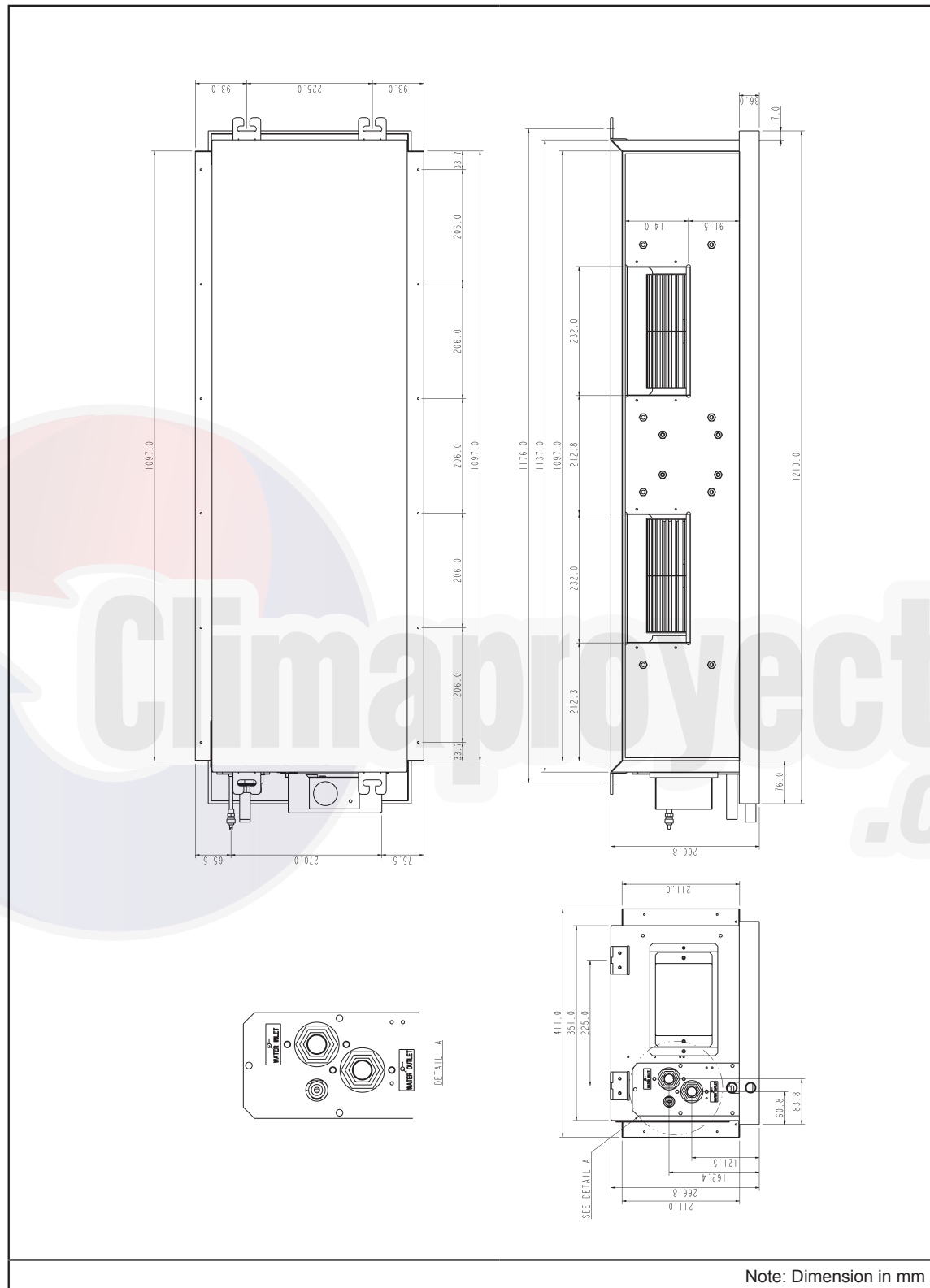

Model: MCC025CW (Right Piping)

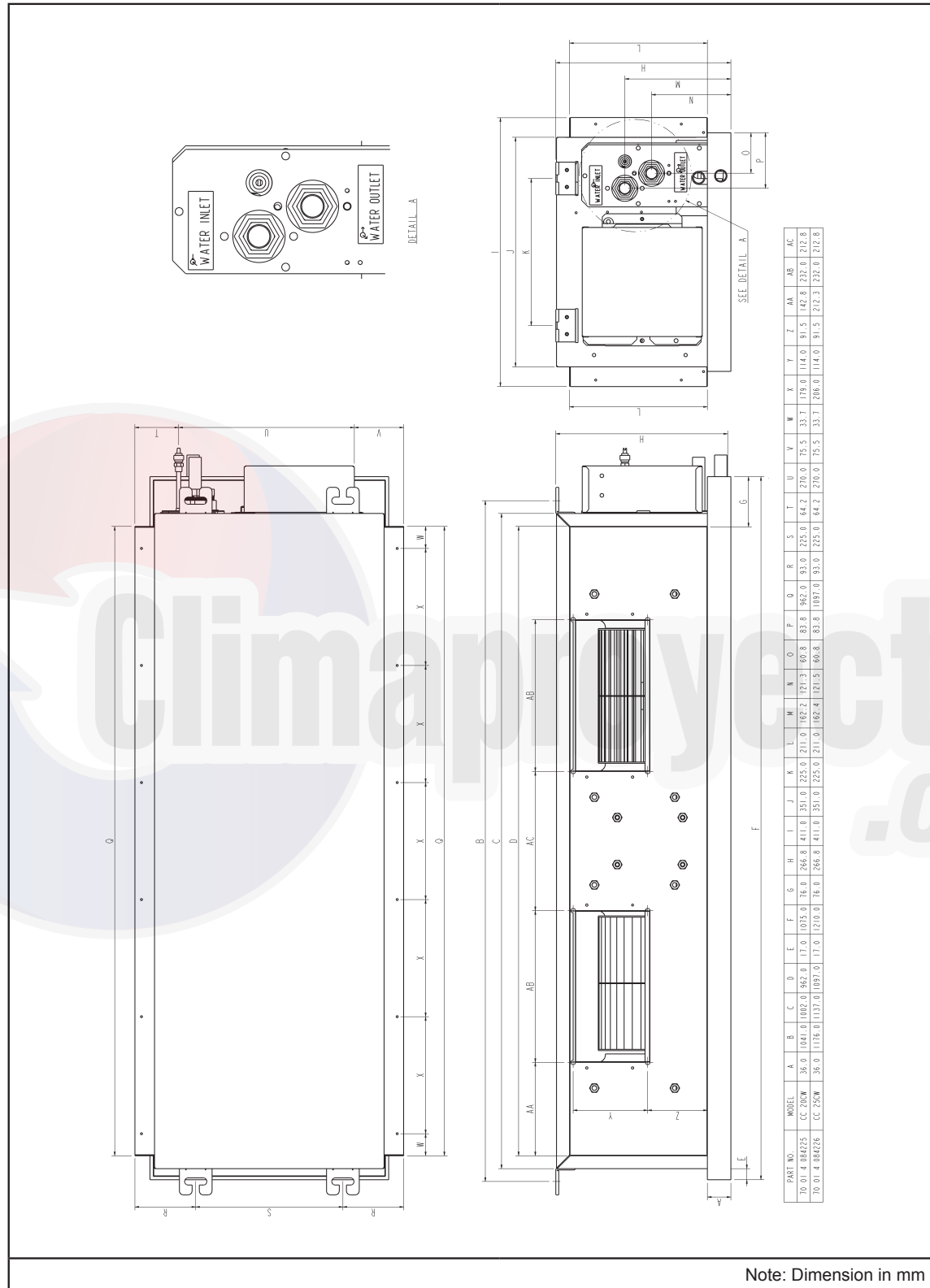

Model: MCC028CW (Left Piping)

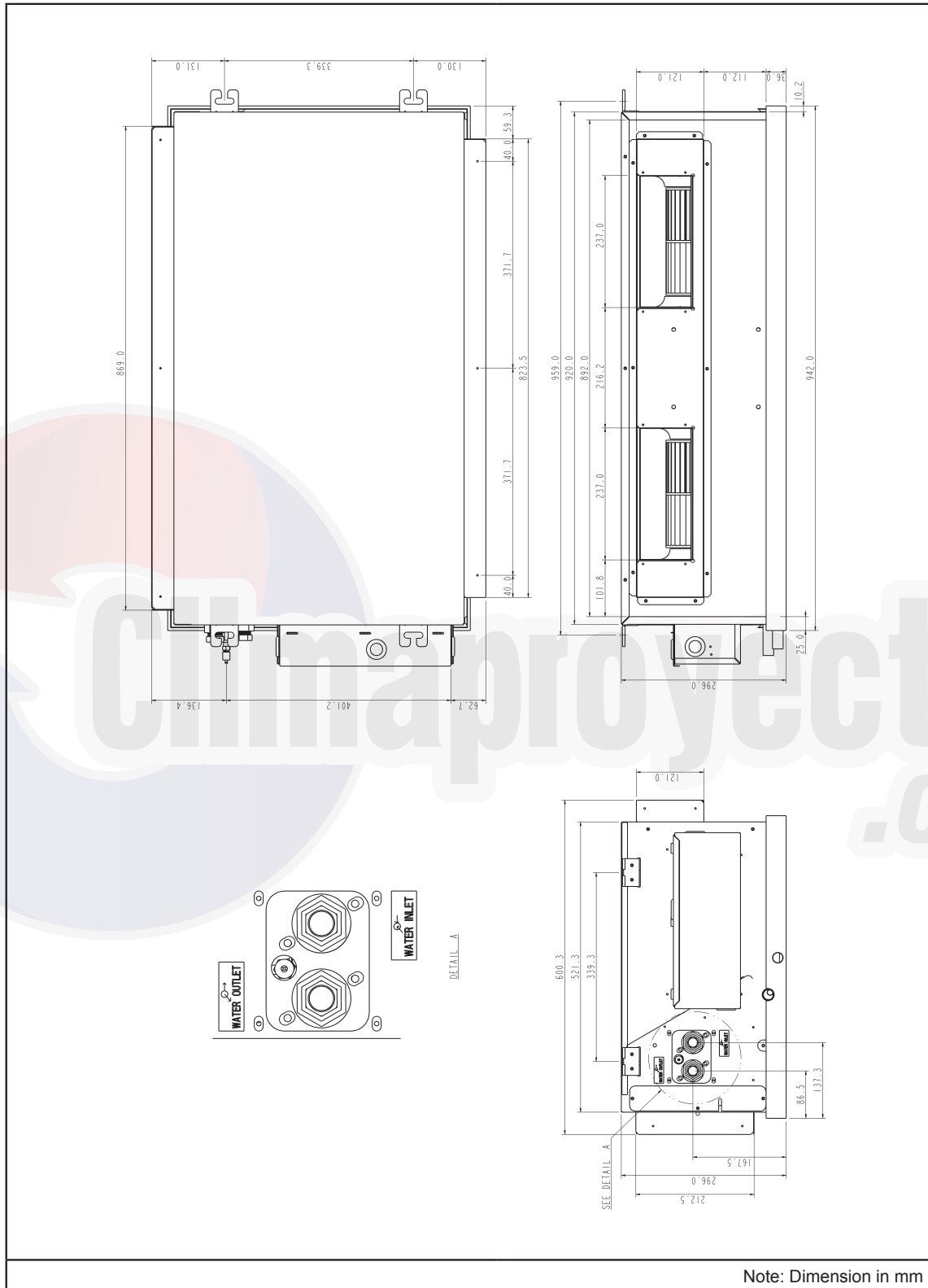

Model: MCC028CW (Right Piping)

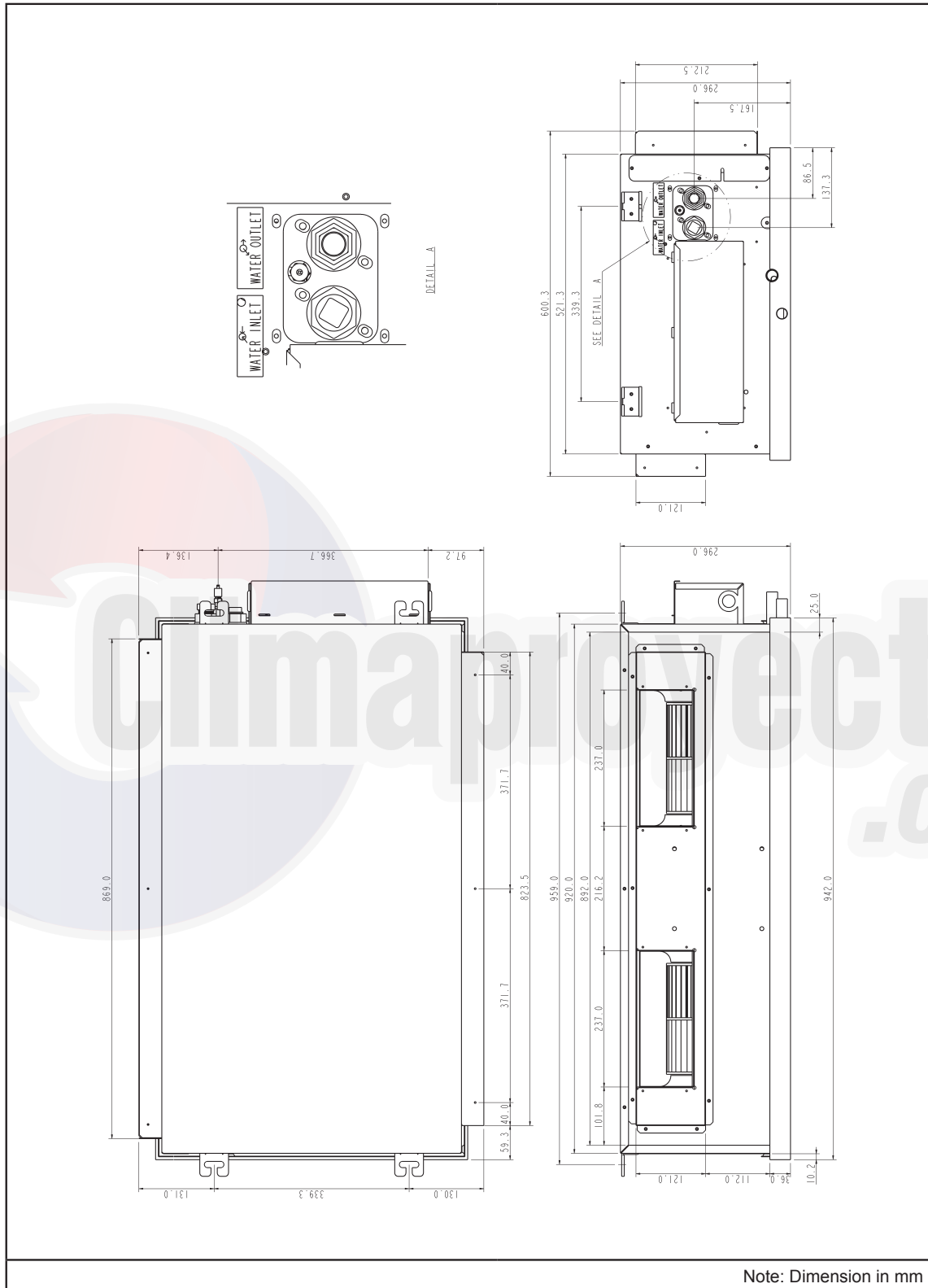

Model: MCC030CW (Left Piping)

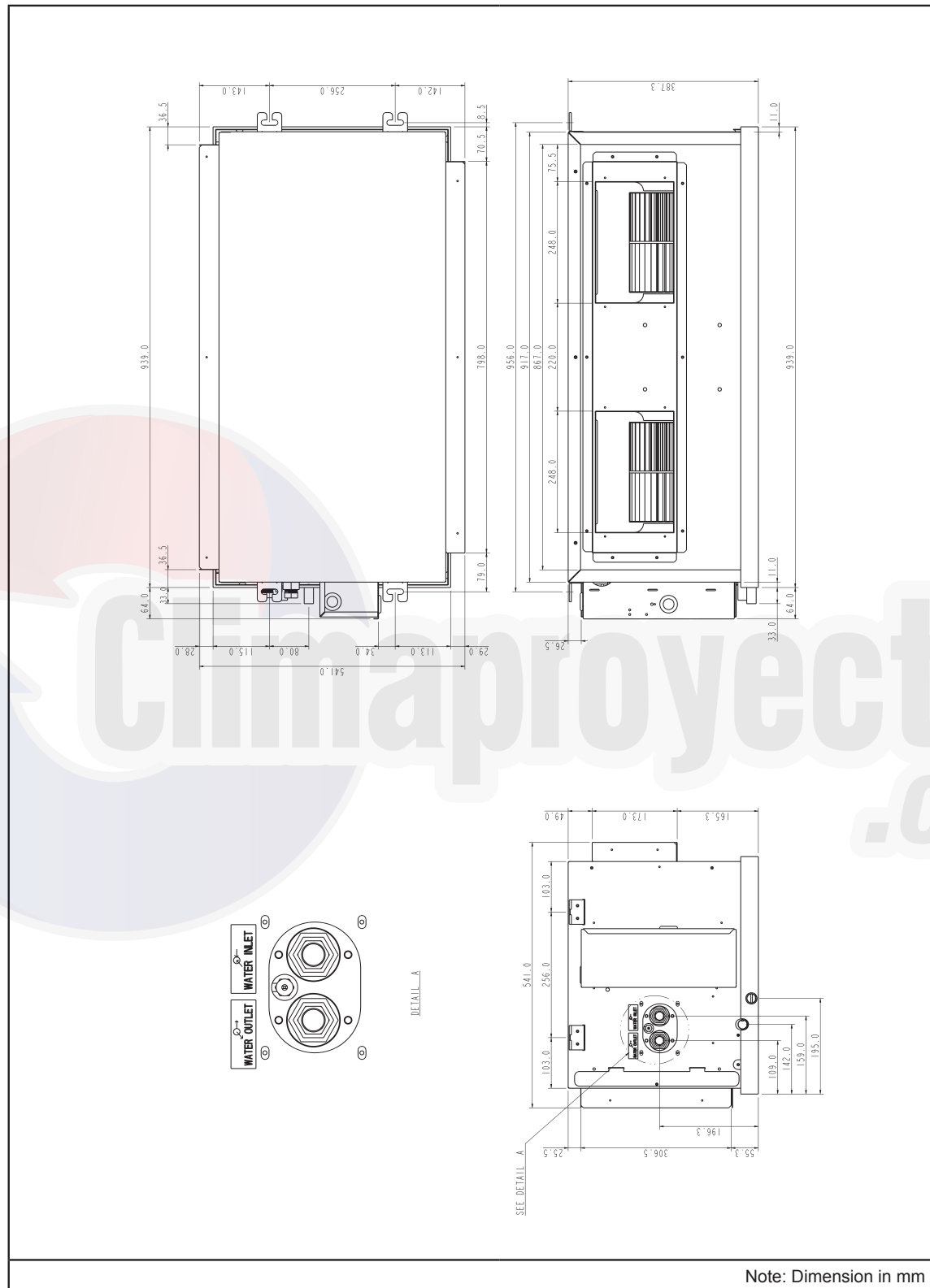

Model: MCC030CW (Right Piping)

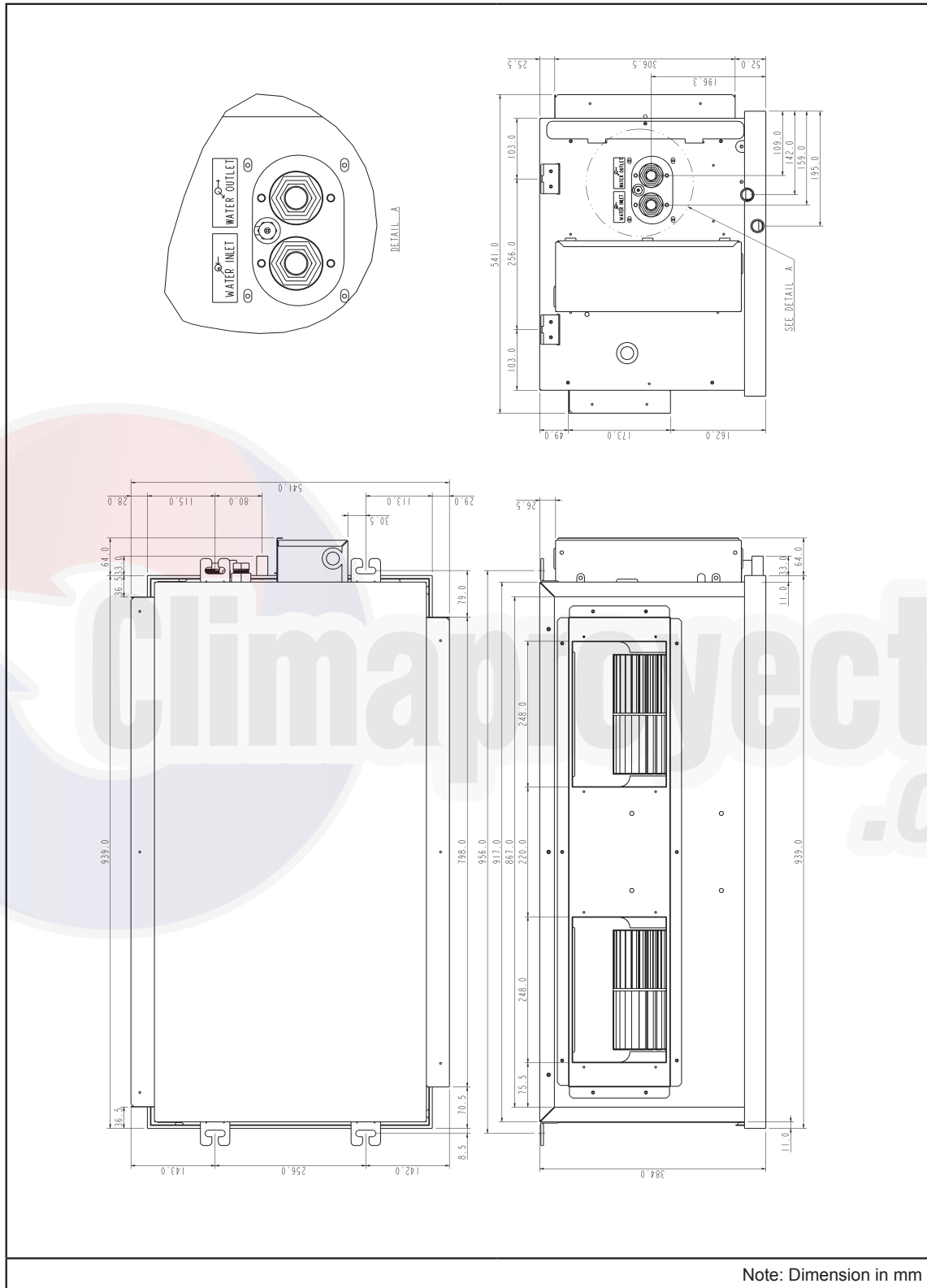

Model: MCC038CW (Left Piping)

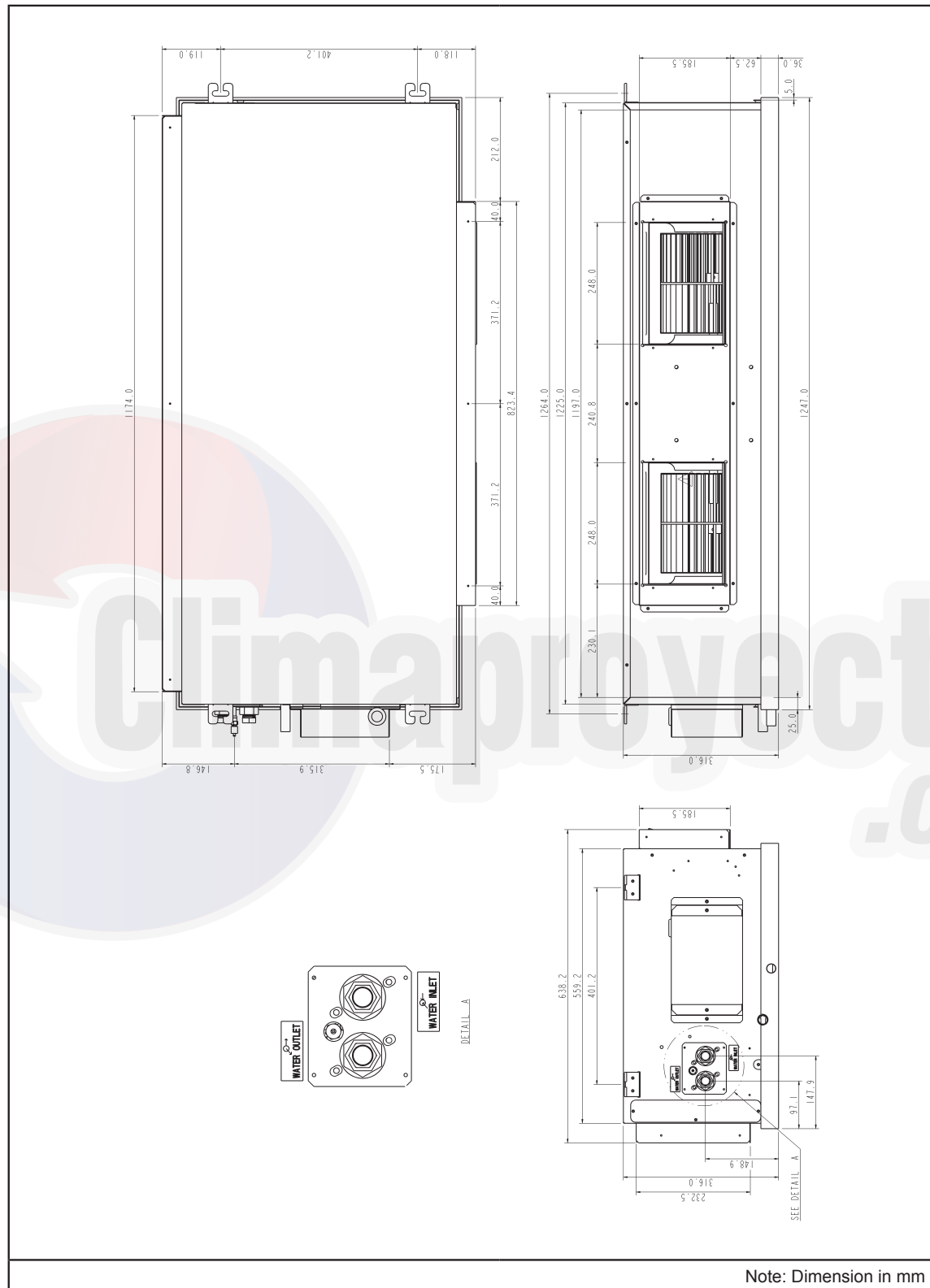

Note: Dimension in mm

Model: MCC038CW (Right Piping)

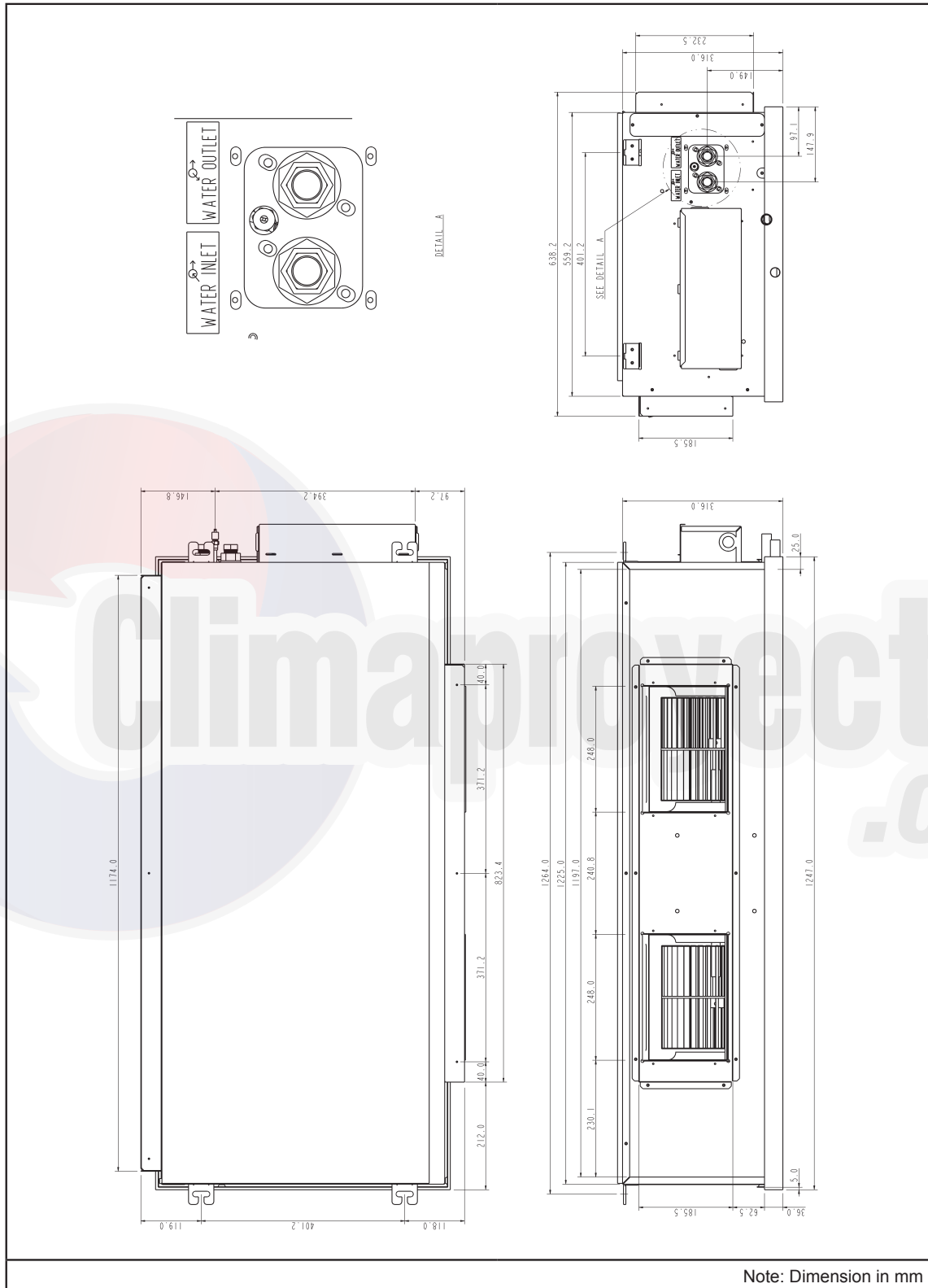

Model: MCC040CW (Left Piping)

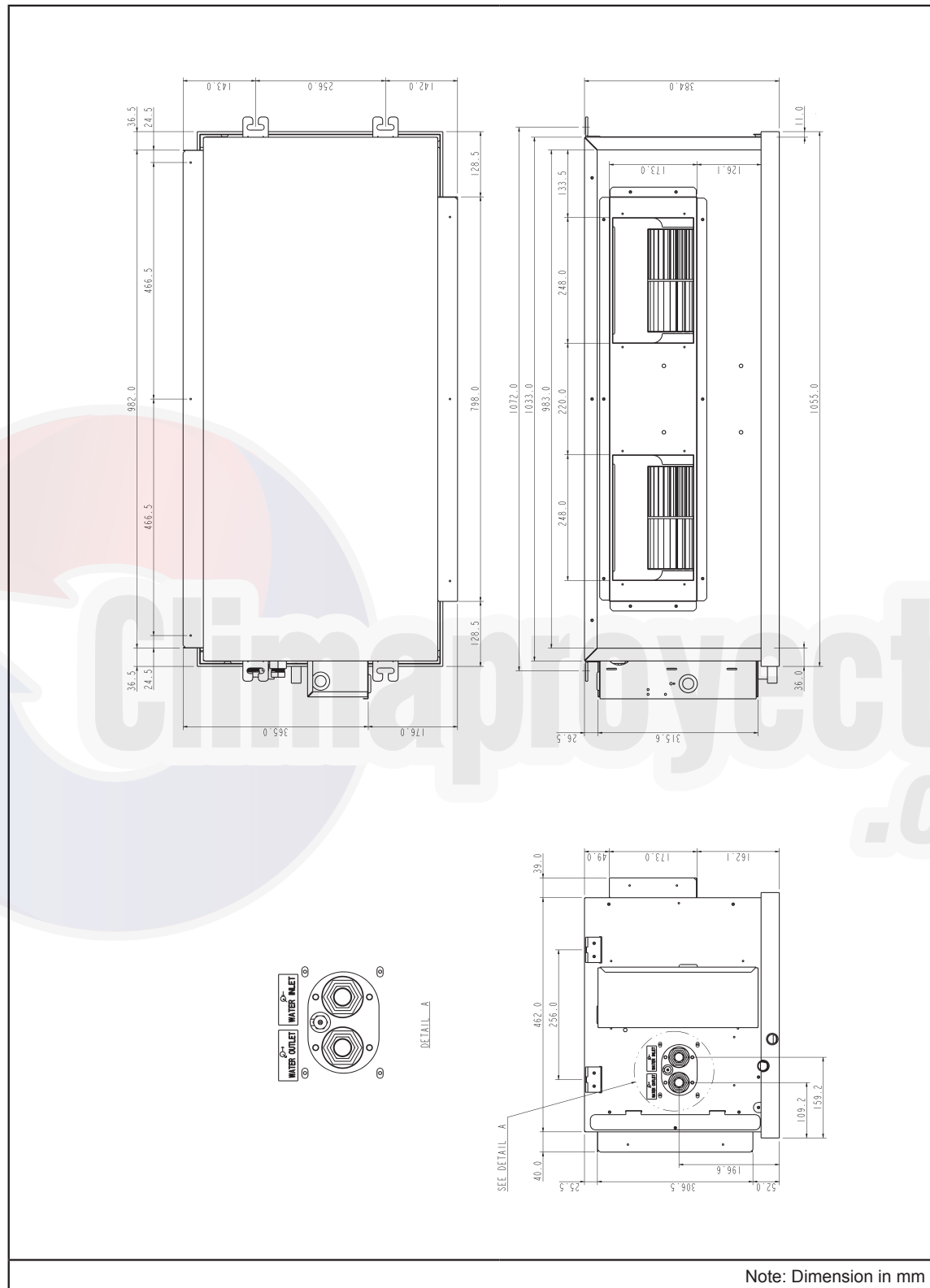

Model: MCC040CW (Right Piping)

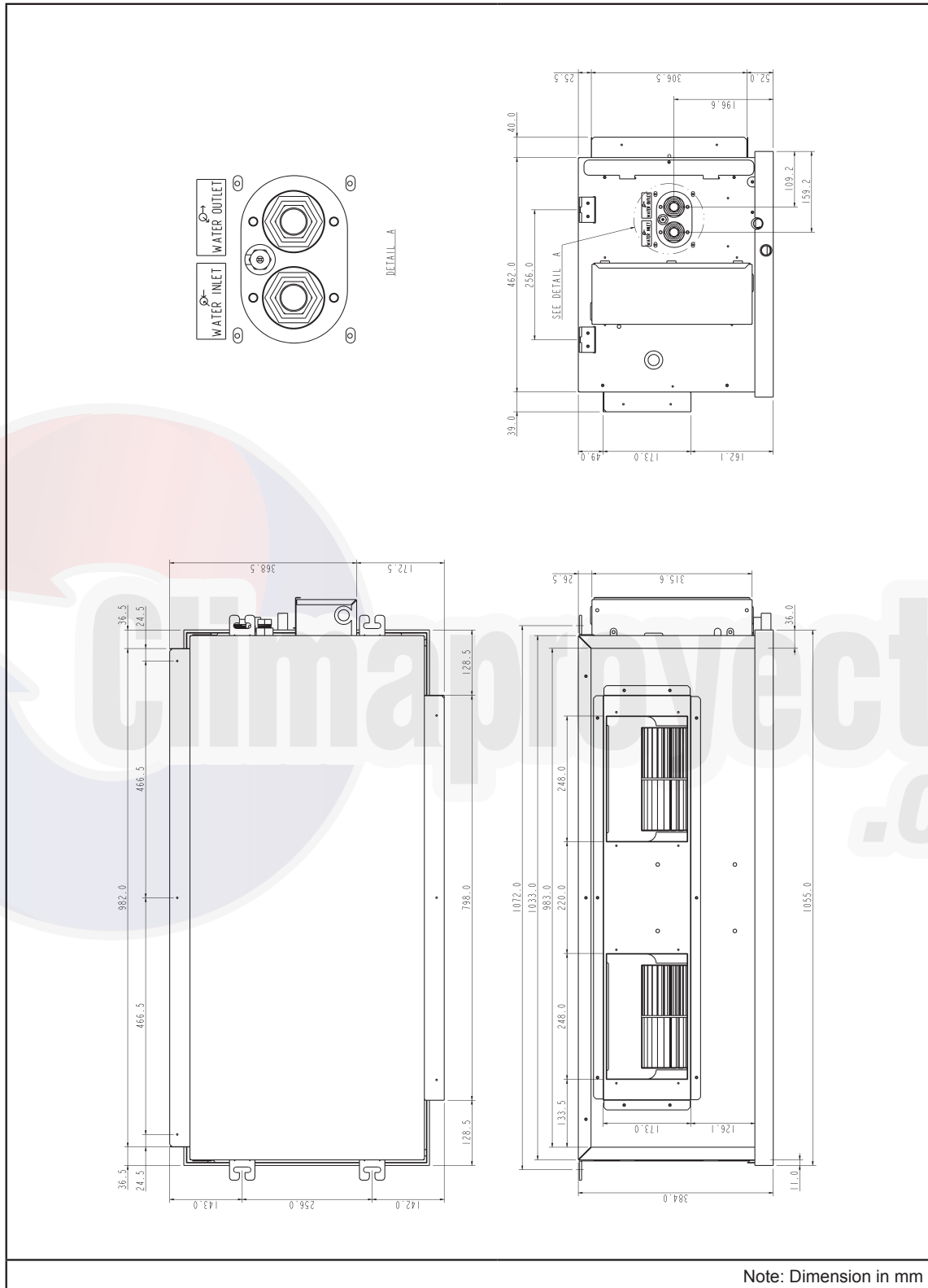

Model: MCC050CW (Left Piping)

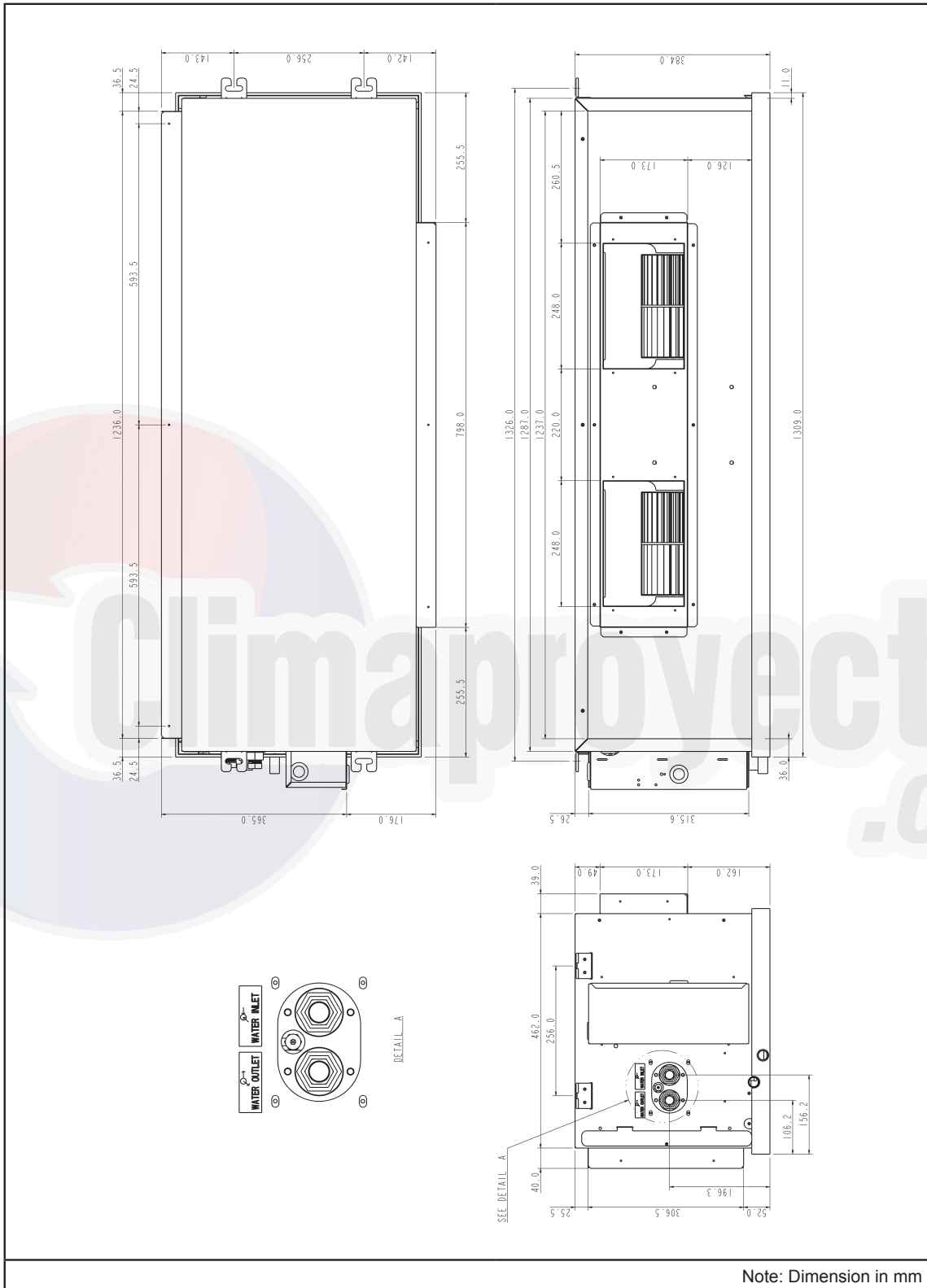

Model: MCC050CW (Right Piping)

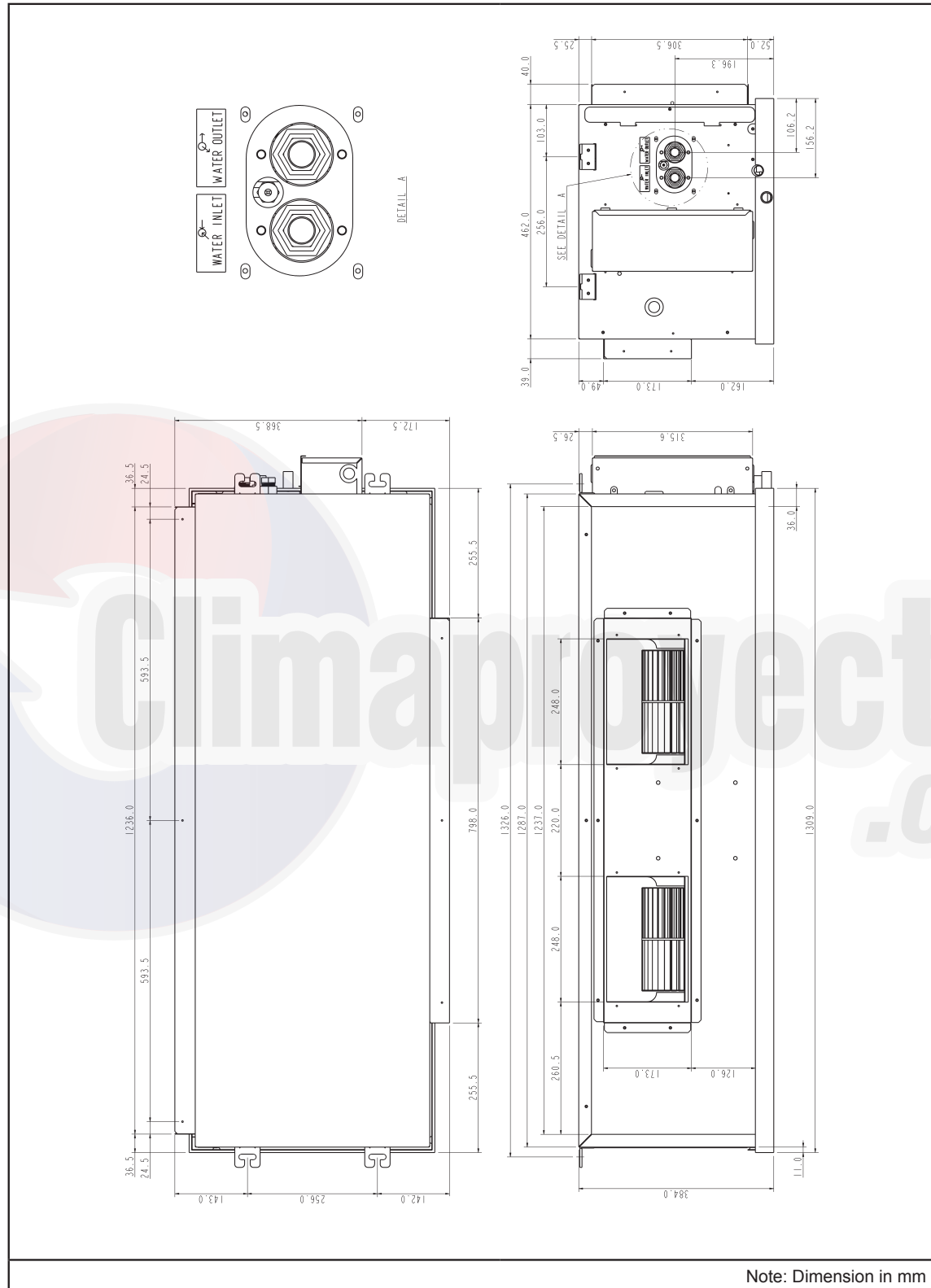

Model: MCC060CW (Left Piping)

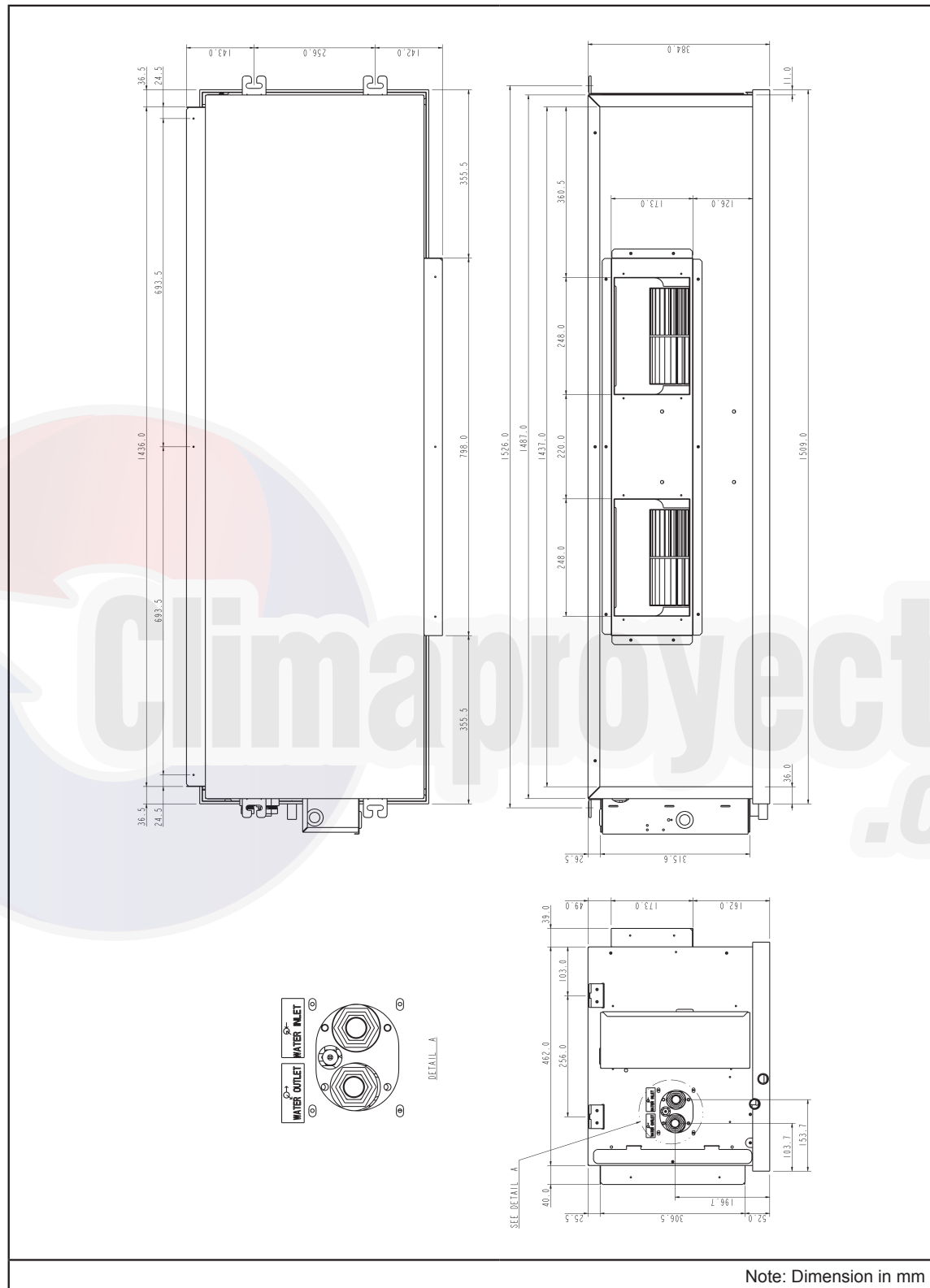

Model: MCC060CW (Right Piping)

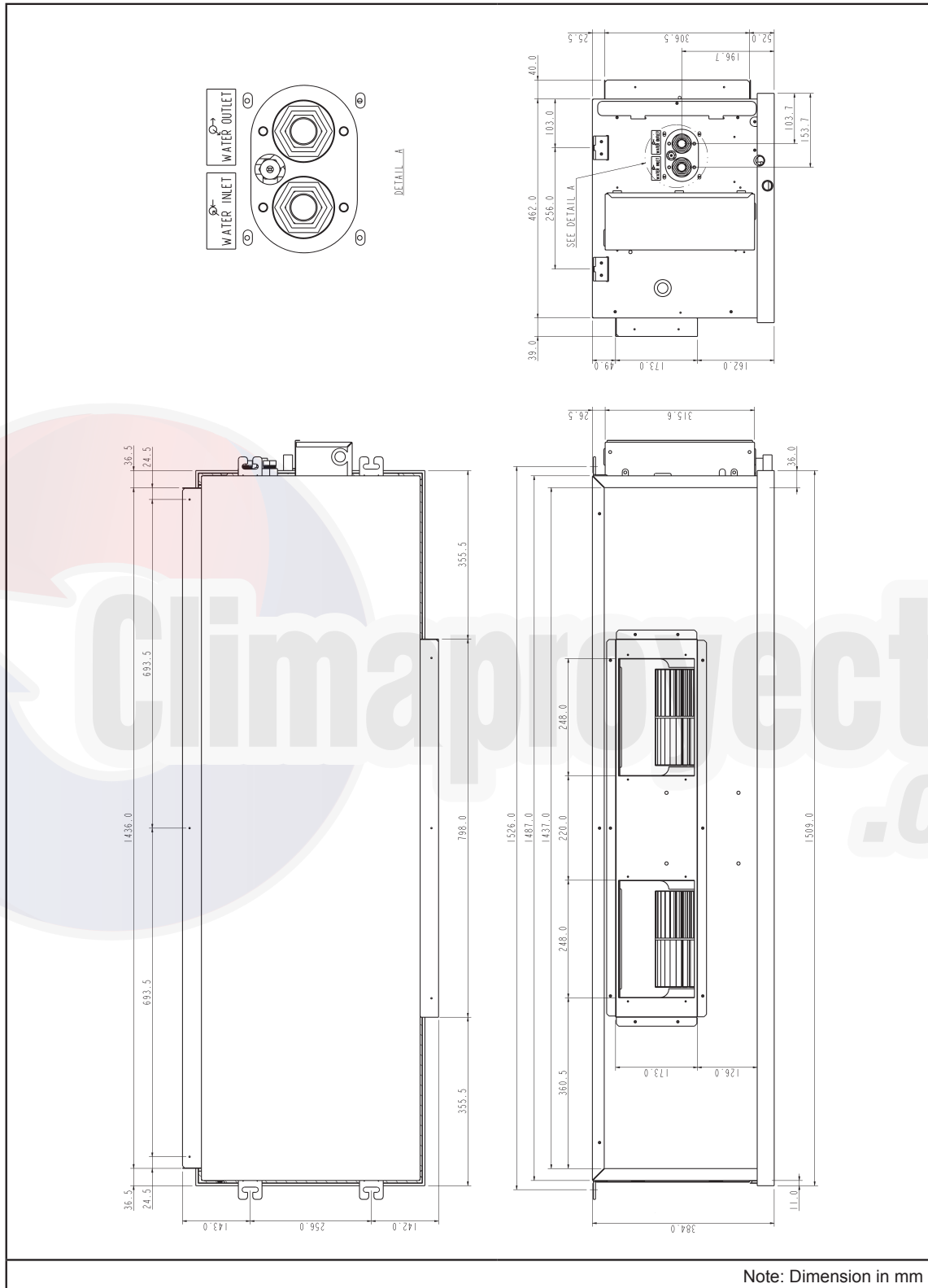

Model: MDB75/100BW

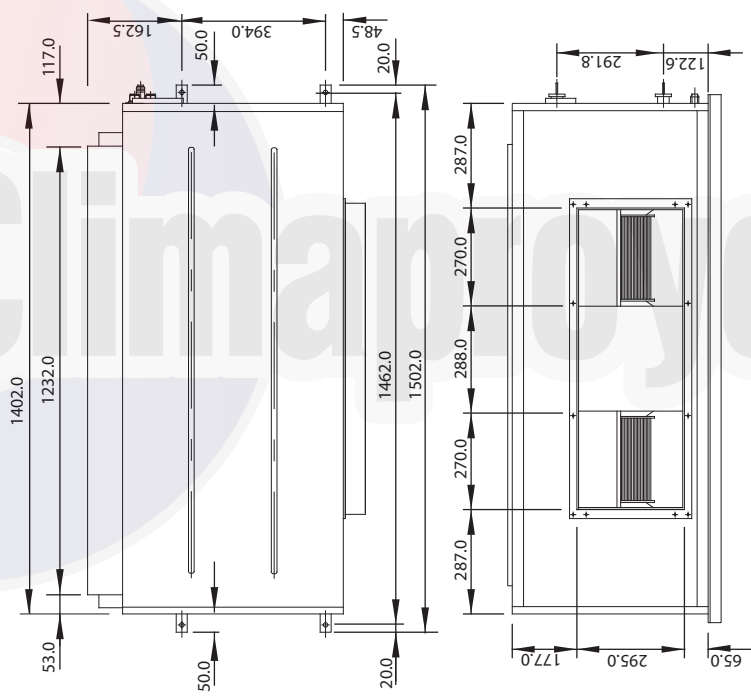
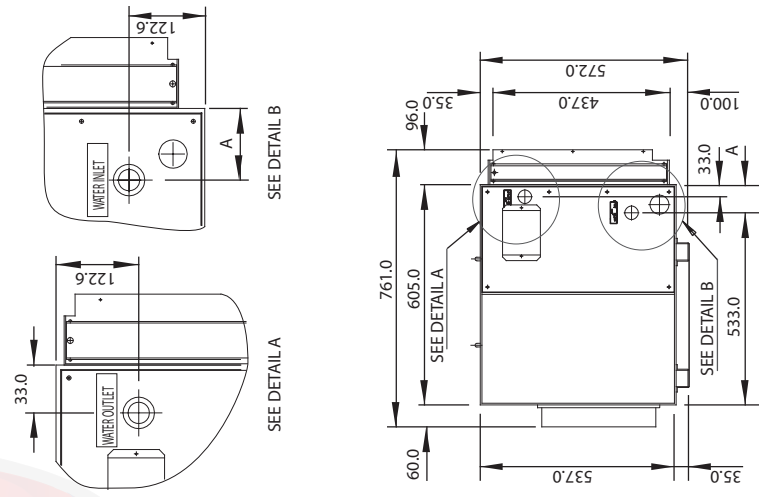

MODEL	A
MDB75BW	72.0
MDB100BW	94.0

Note: Dimension in mm

Model: MDB125/150BW (Horizontal Air Discharge)

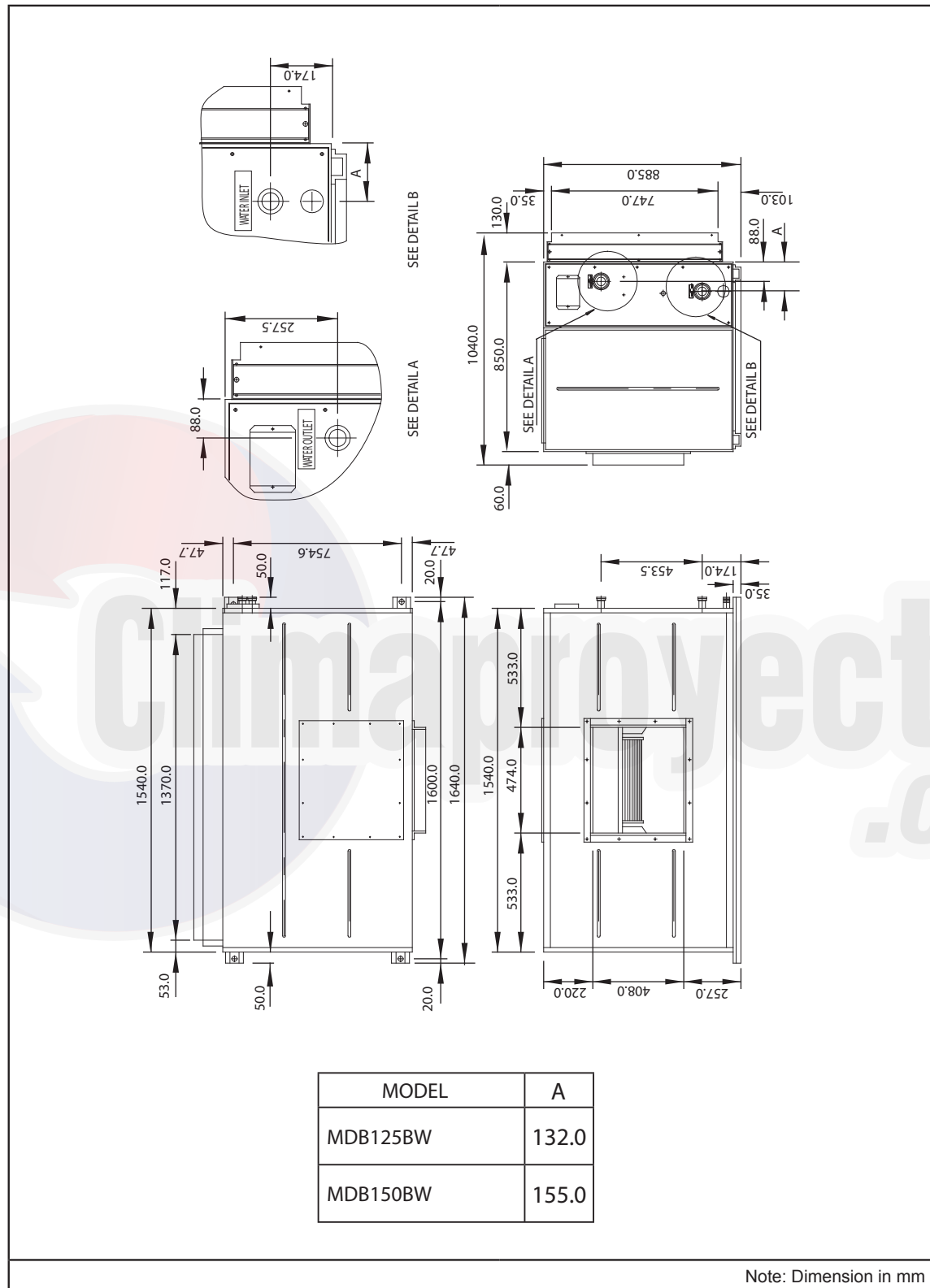

Model: MDB125/150BW (Vertical Air Discharge)

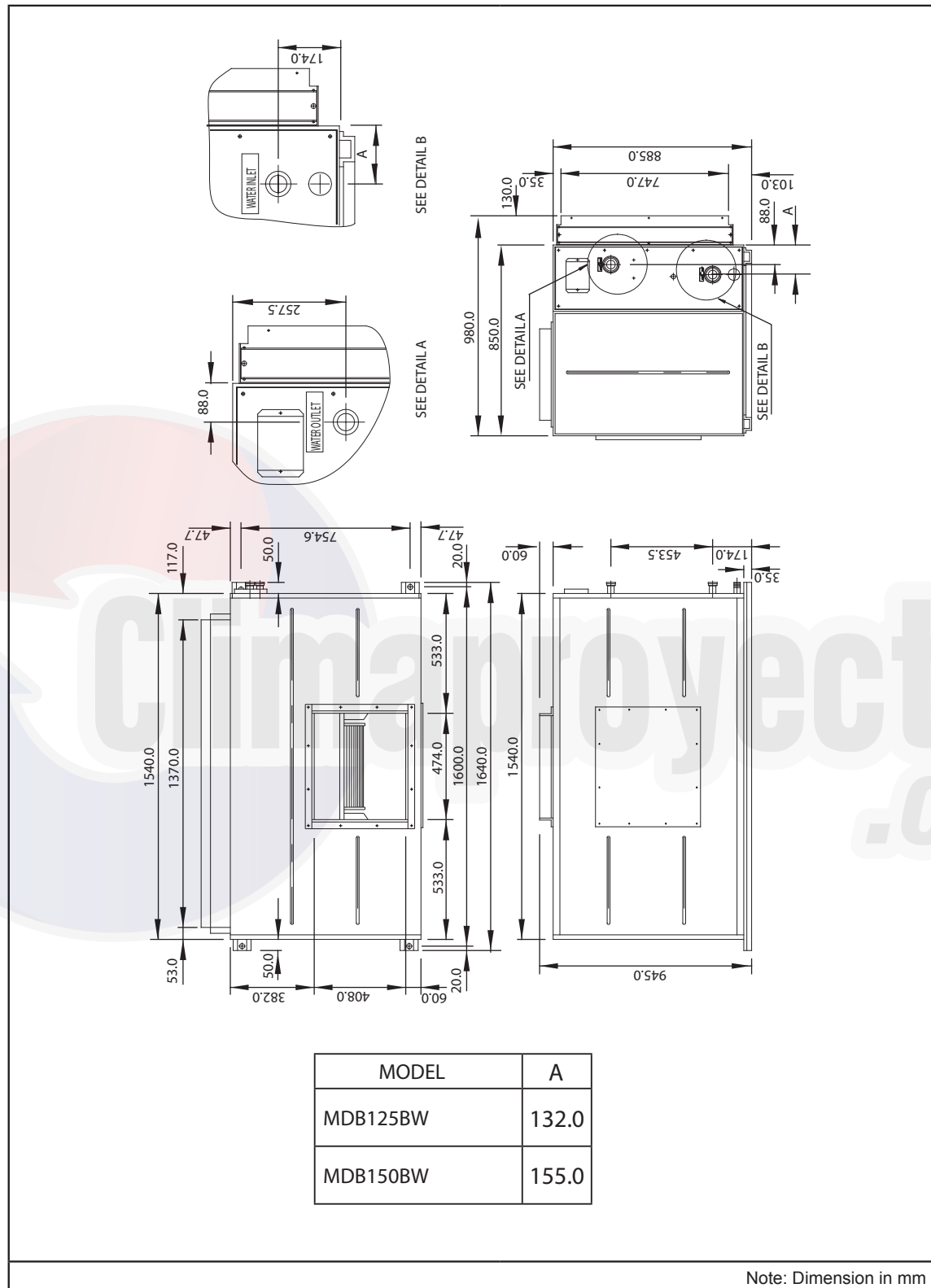

Wiring Diagrams

Model: MWM07/10/15/20/25LW

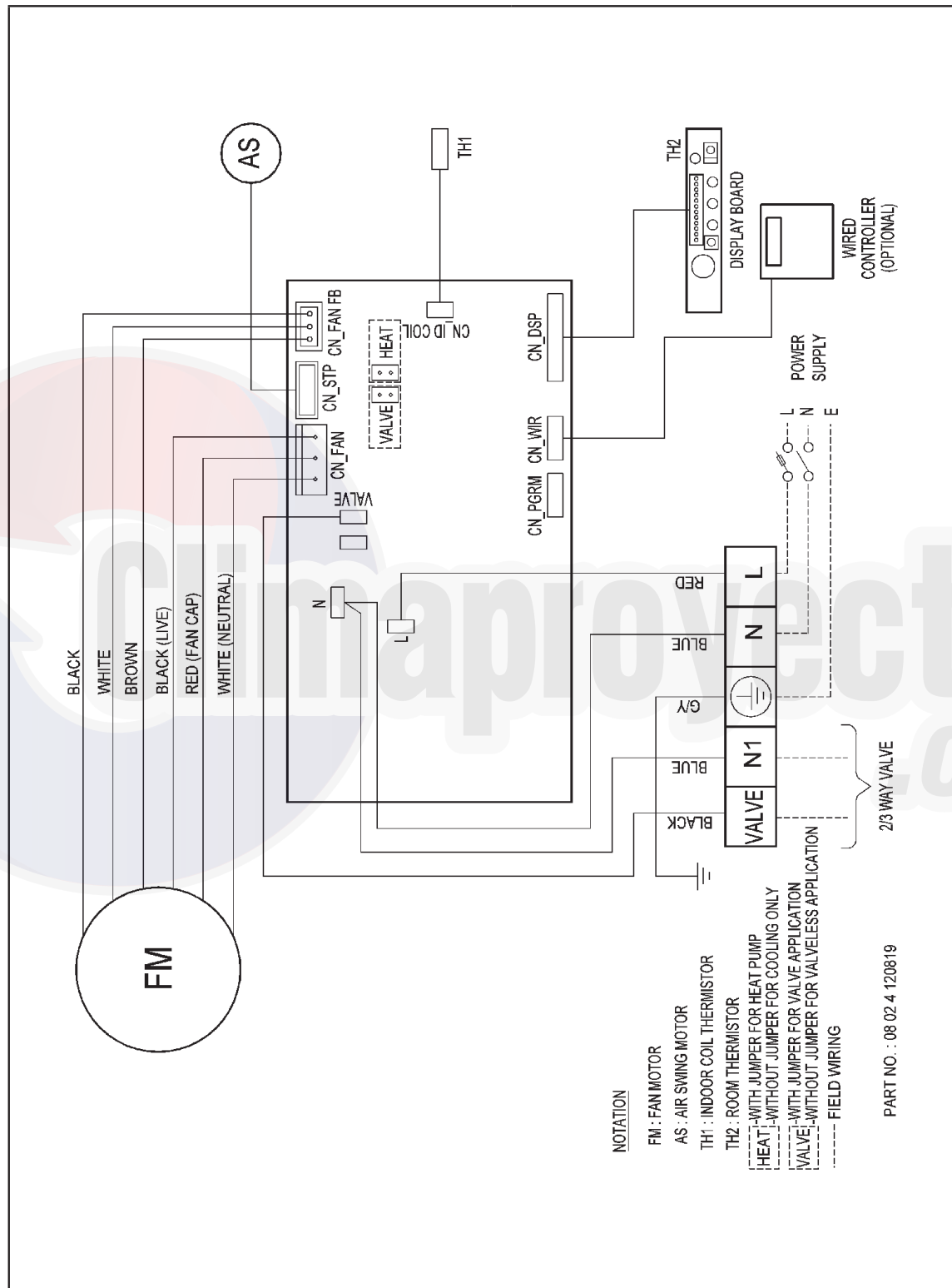

Model: MWM301W

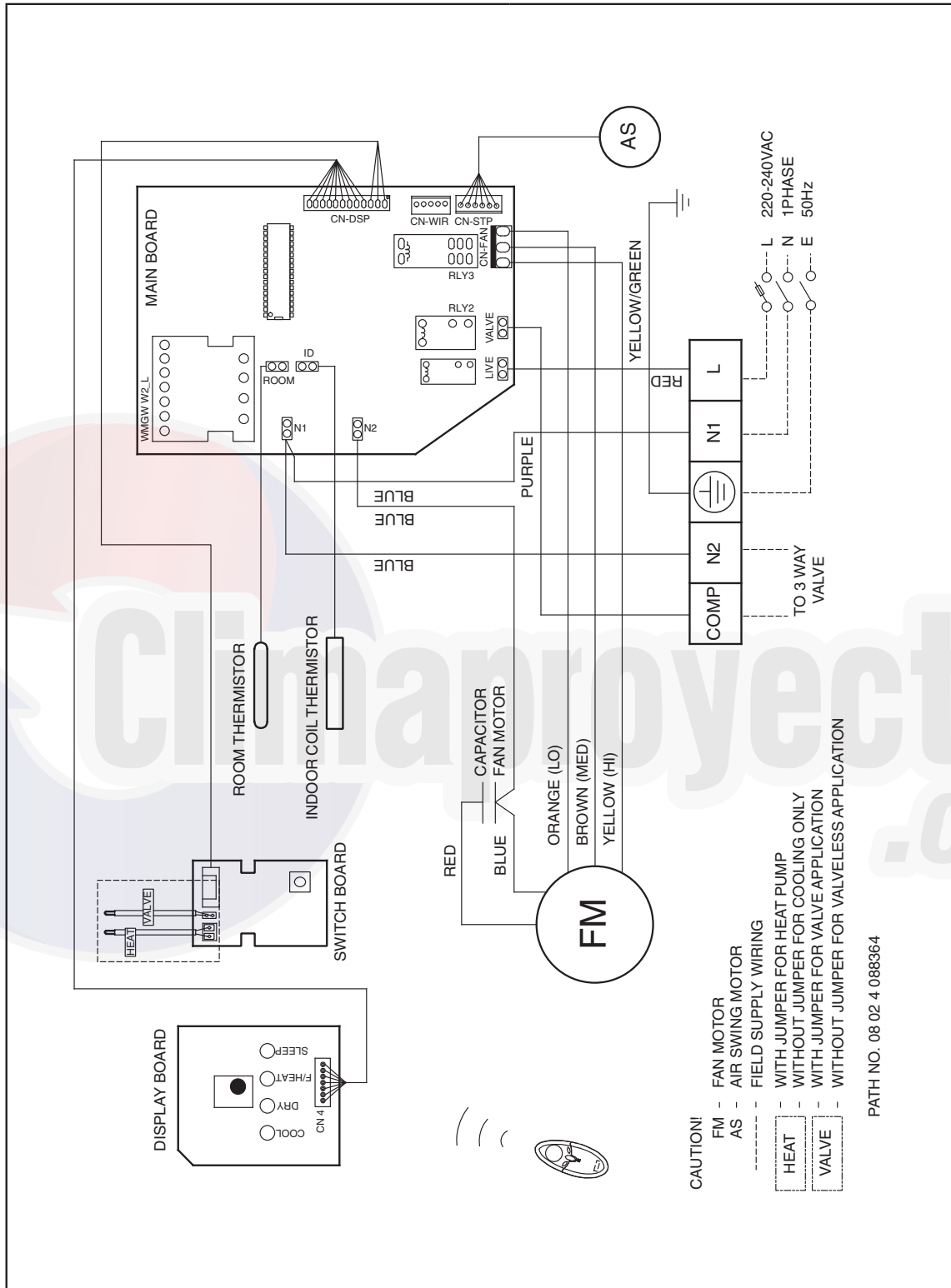

Model: MCK20/25/30/40/50AW

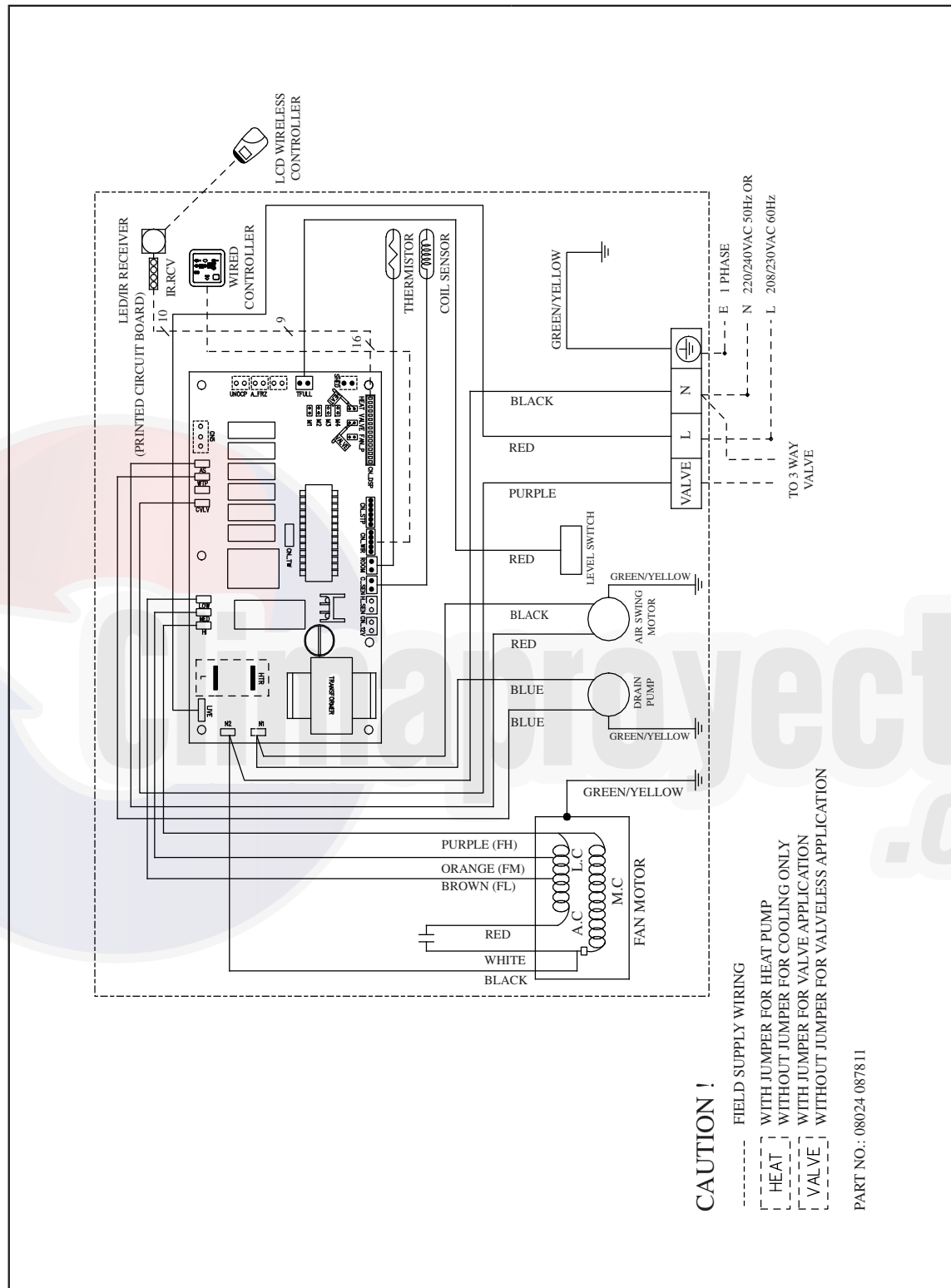

Model: MCK20/25/30/40/50AWH

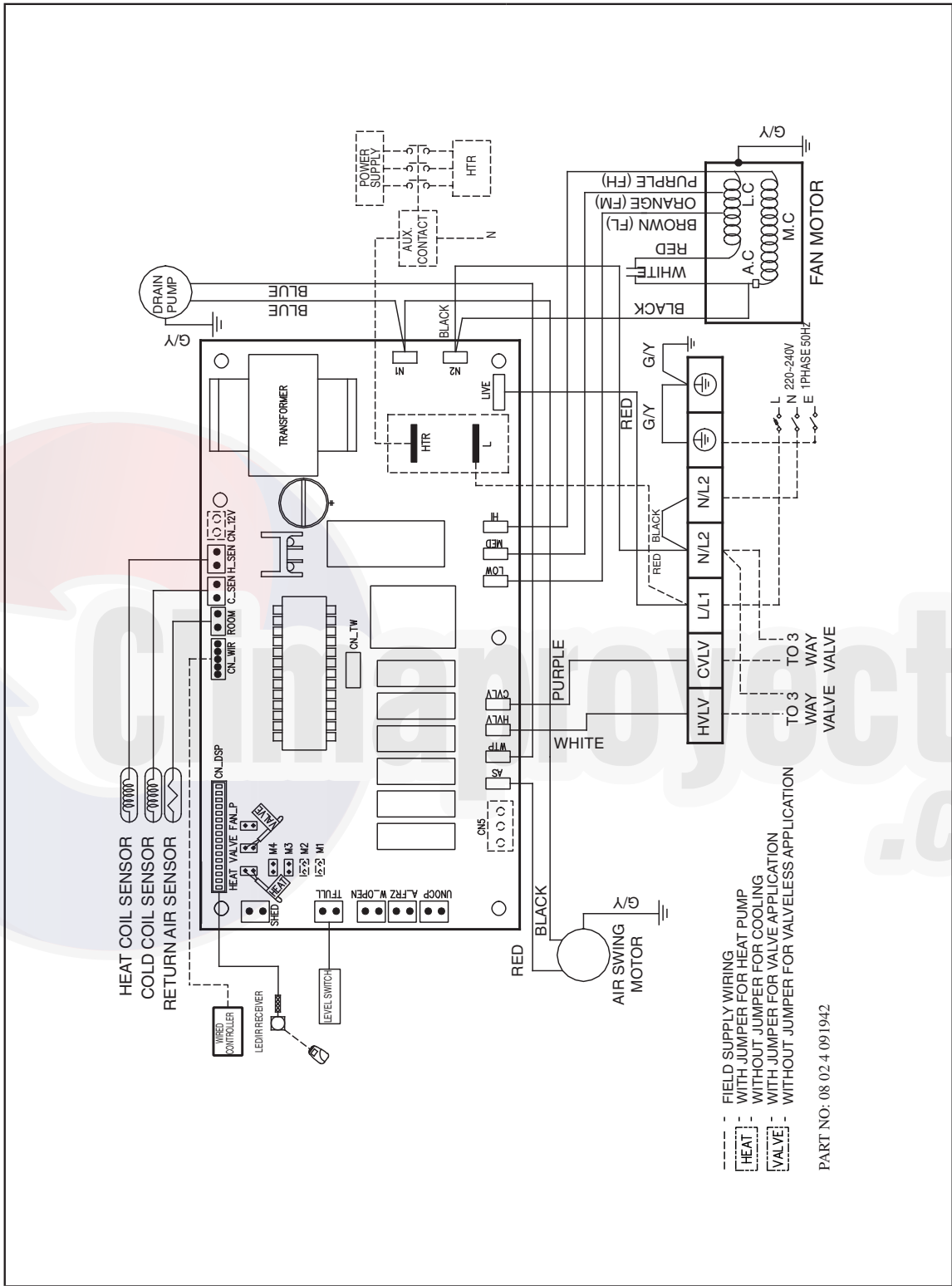

Model: MCK010/015/020CW

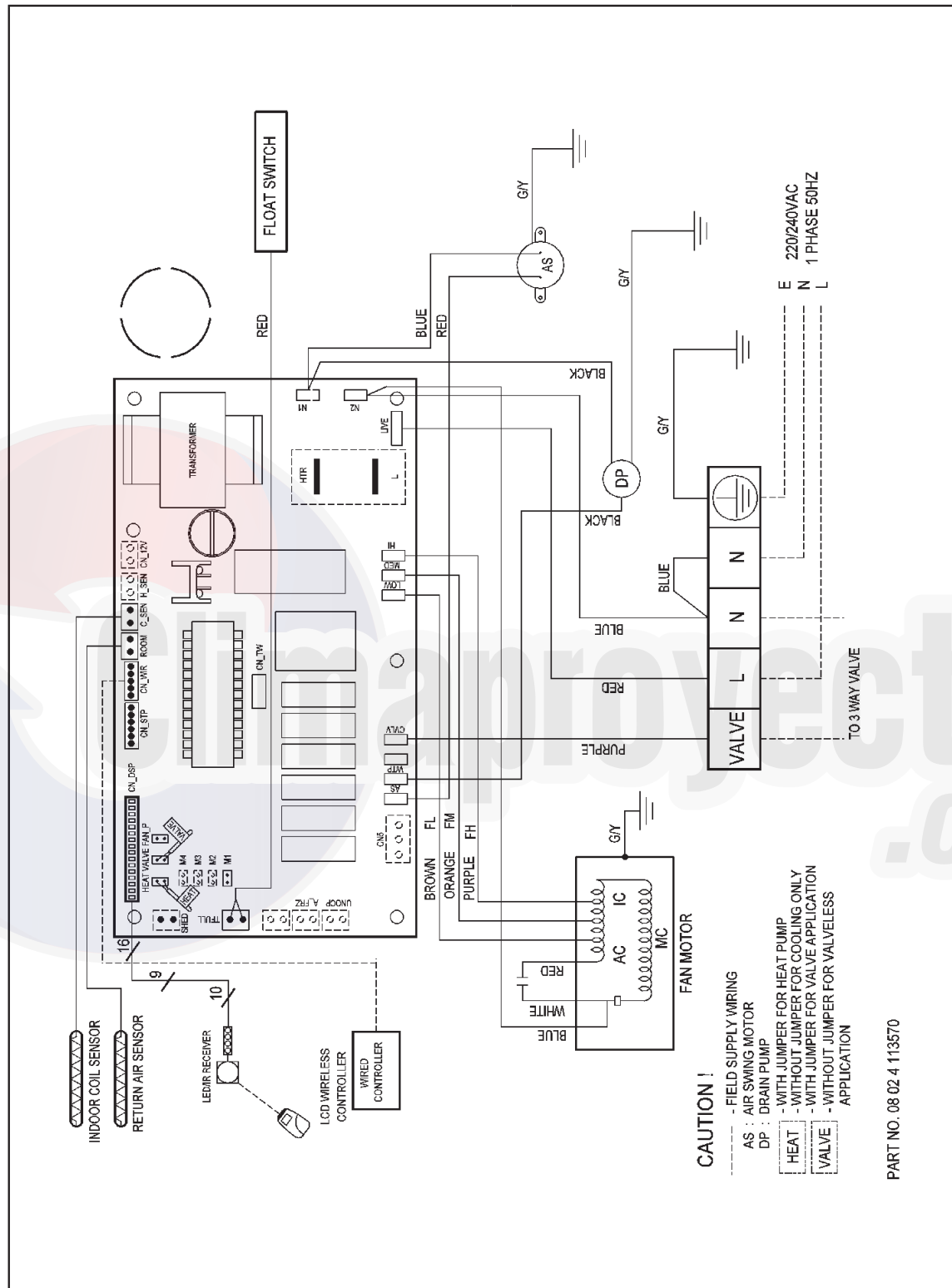

Model: MCK020/025/030/040/050EW

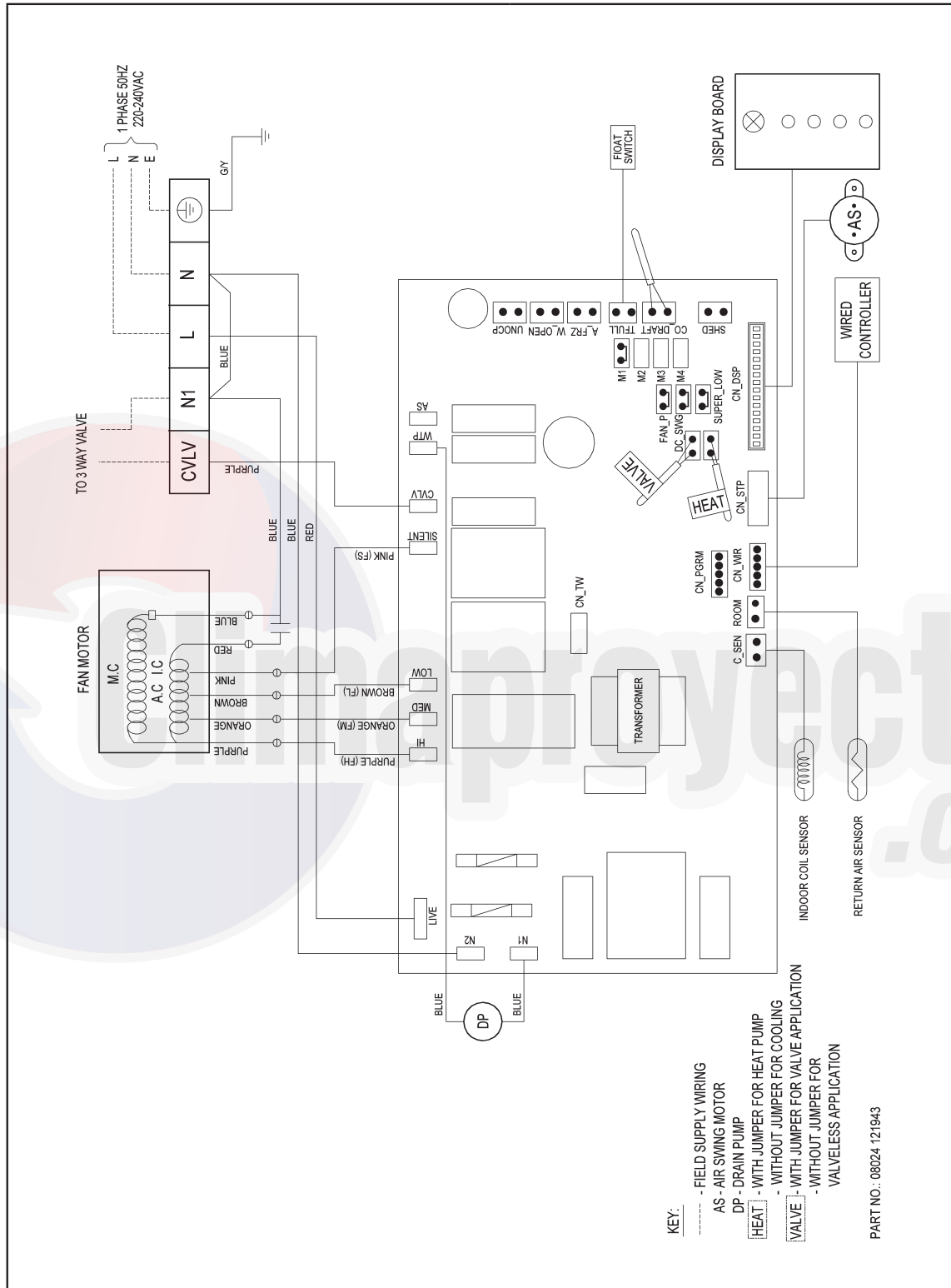

Model: MCM20/25/30/40/50DW

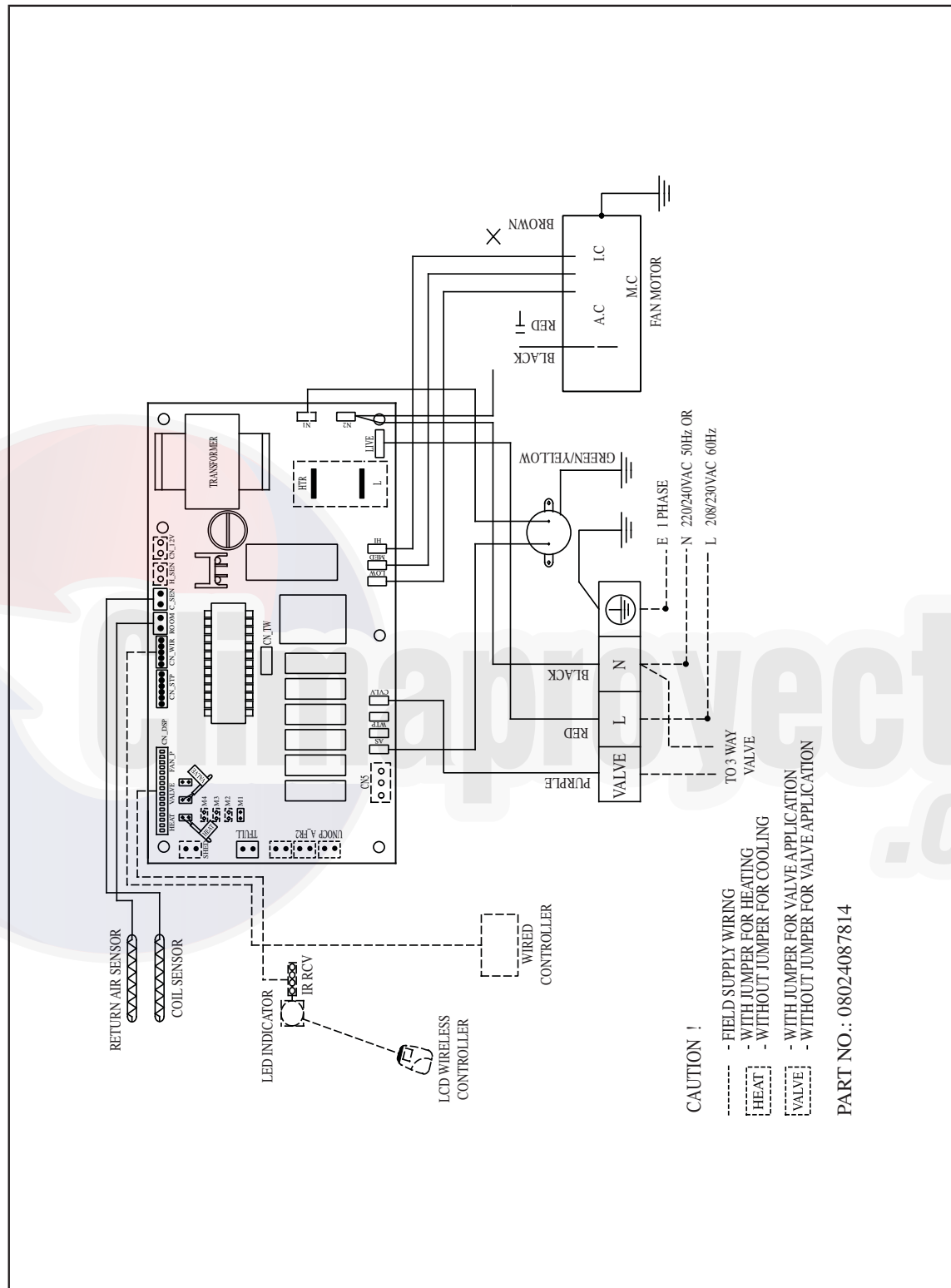

CAUTION !

- FIELD SUPPLY WIRING
- WITH JUMPER FOR HEATING
- WITHOUT JUMPER FOR COOLING
- WITH JUMPER FOR VALVE APPLICATION
- WITHOUT JUMPER FOR VALVE APPLICATION

PART NO. : 08024087814

Model: MCM15/20/25EW

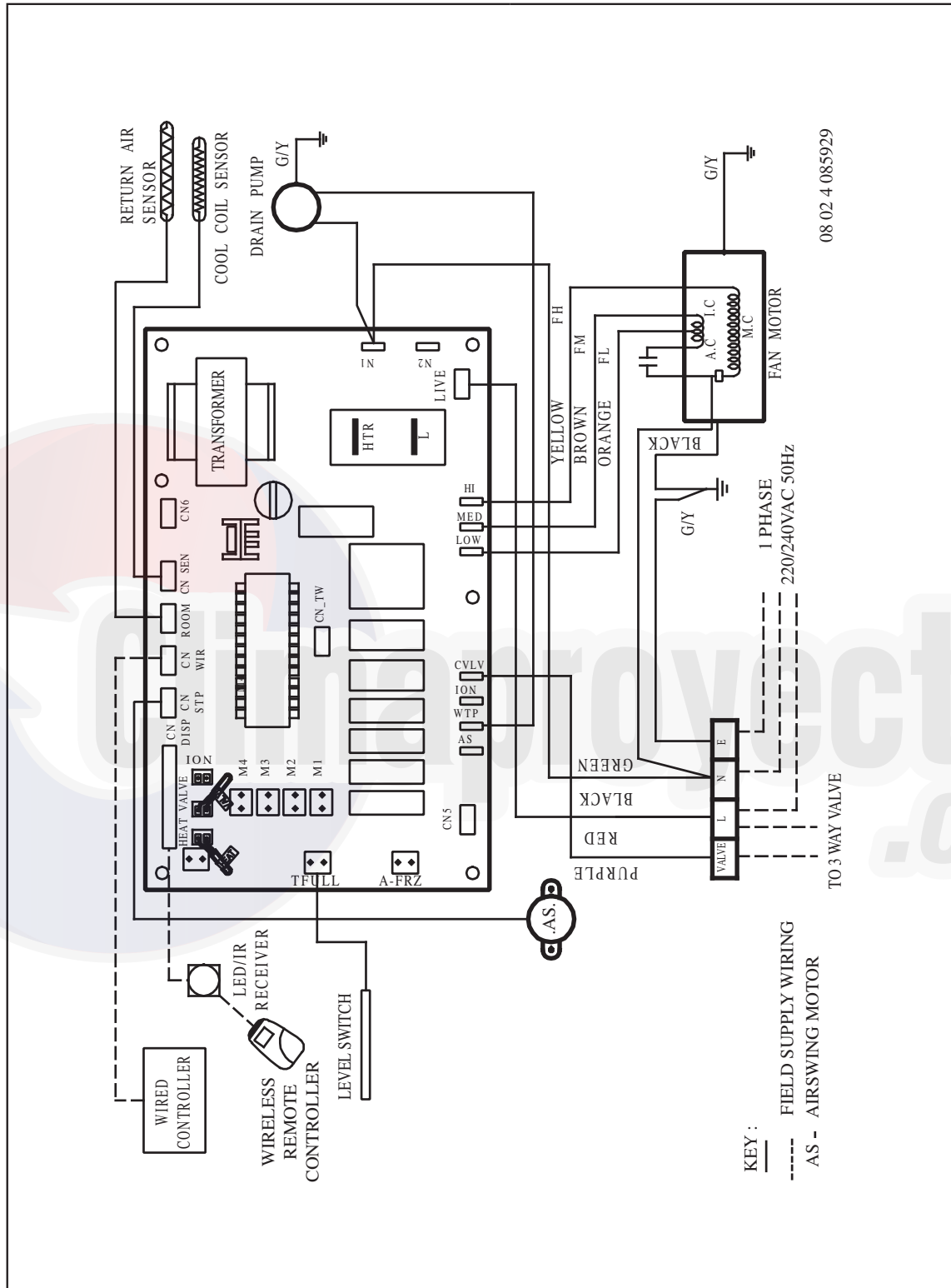

Model: MCC010/015/020/025CW (With Controller)

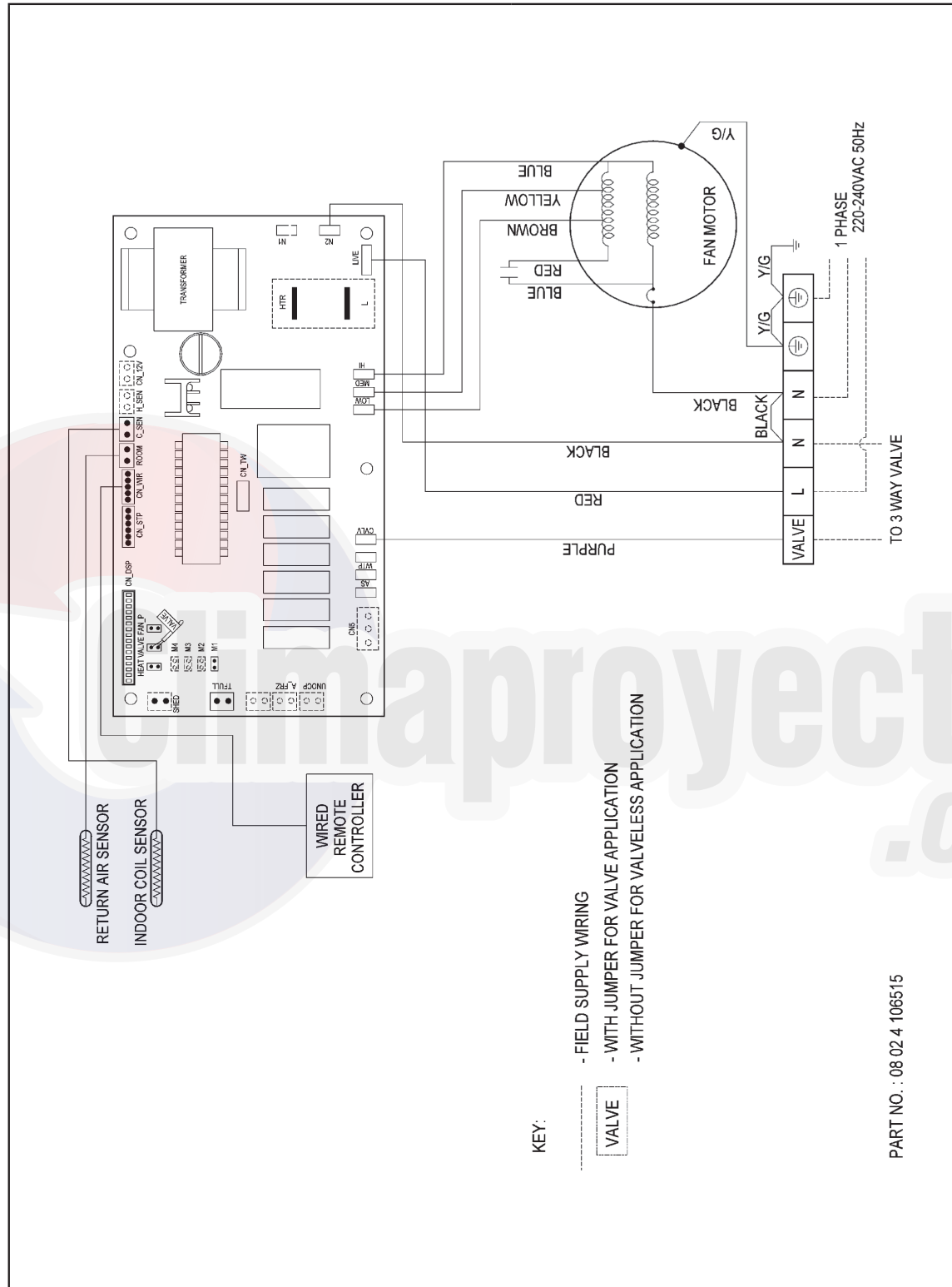

Model: MCC028/030/038/040/050/060CW (With Controller)

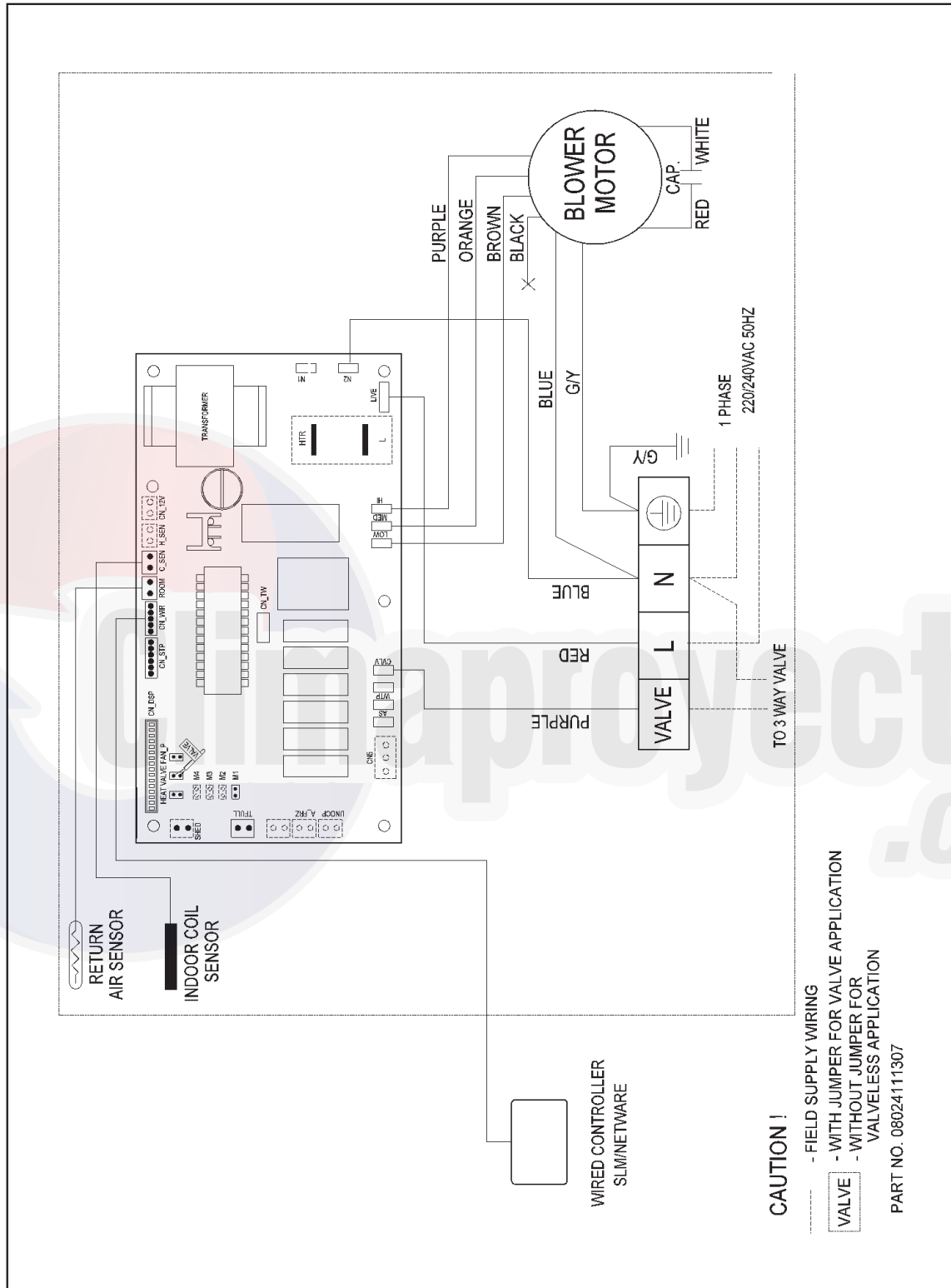

Model: MCC010/015/020/025CW (Without Controller)

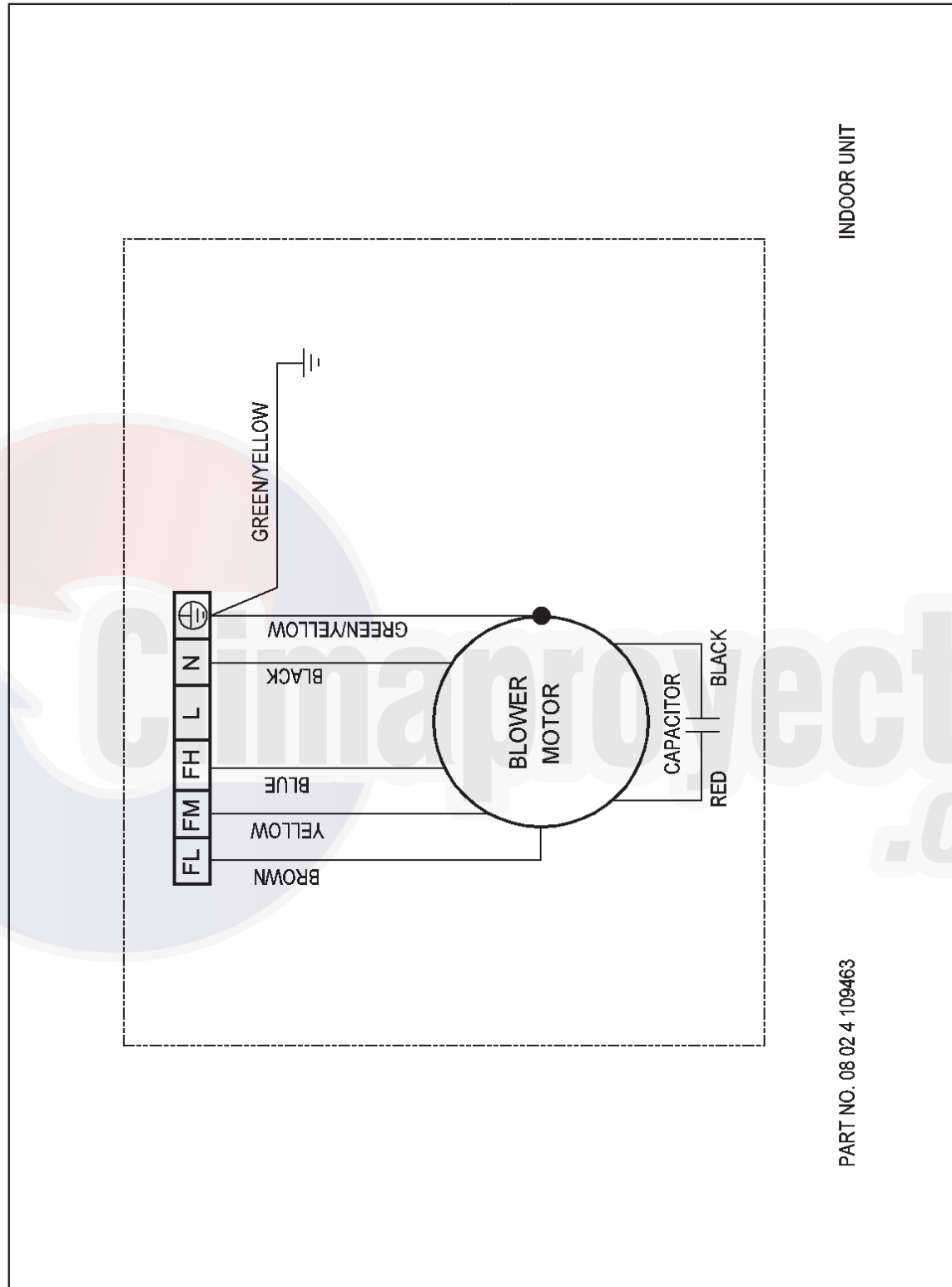

Model: MCC028/030/038/040/050/060CW (Without Controller)

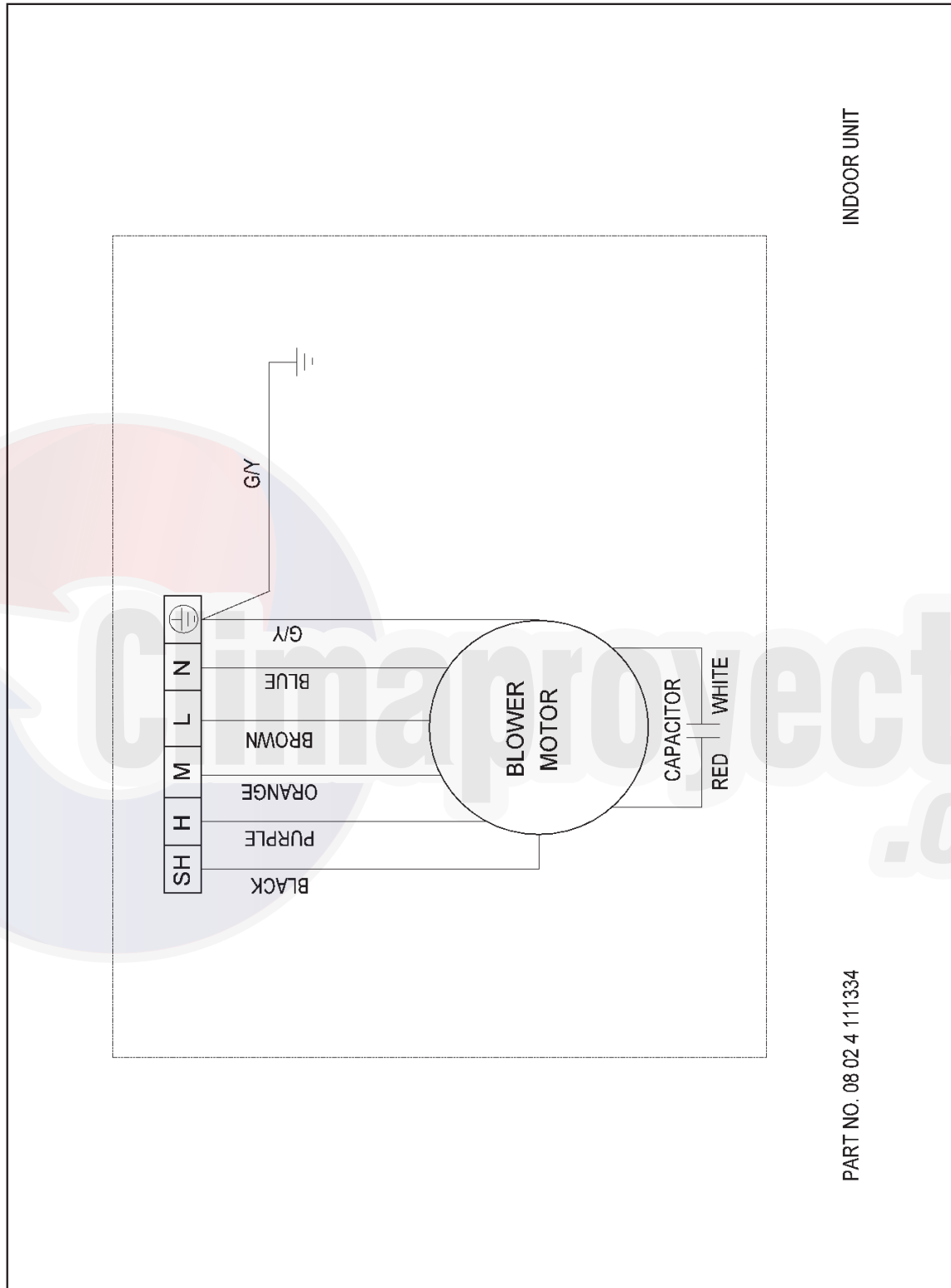

Model: MDB75BW

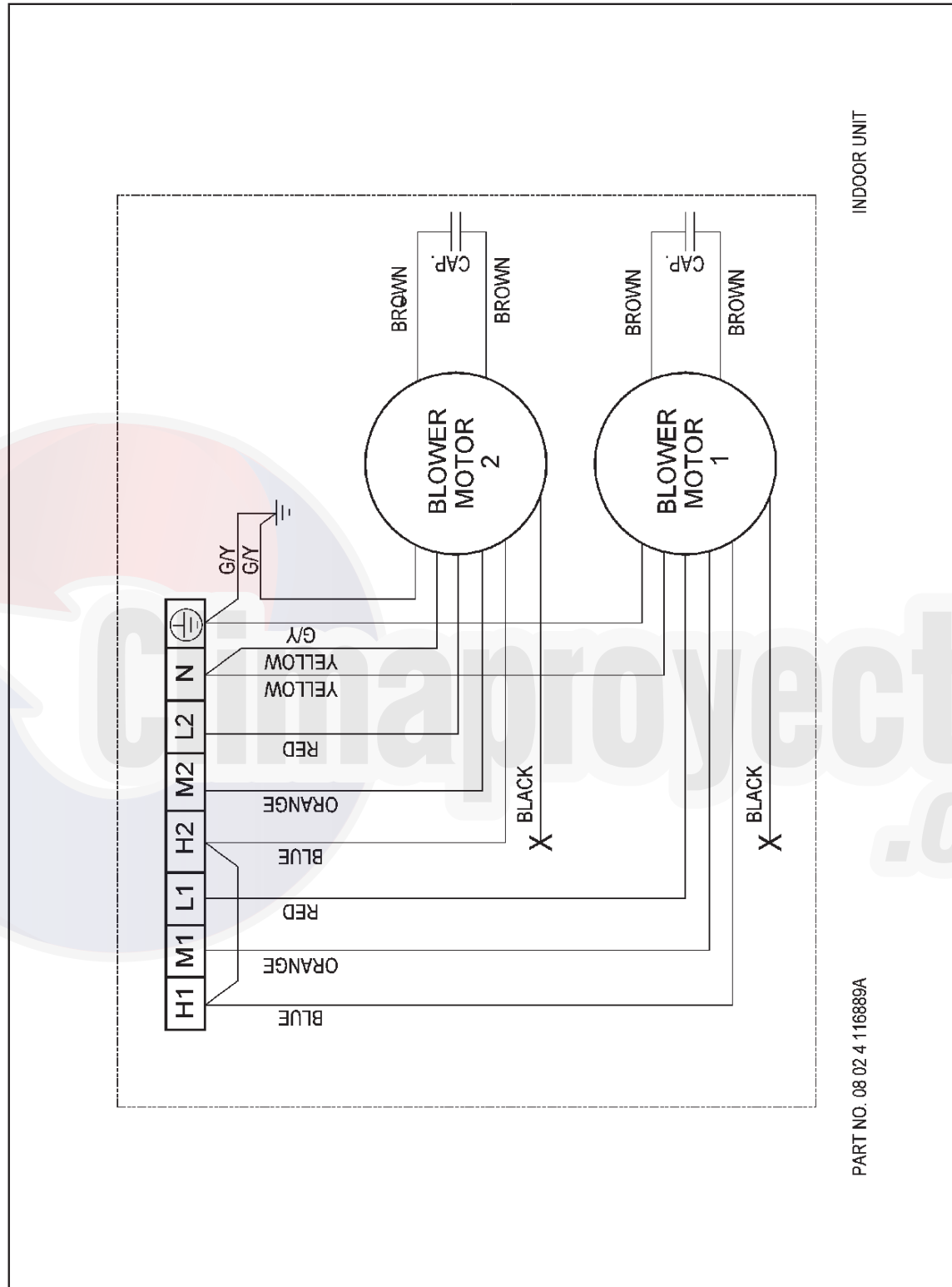

Model: MDB100BW

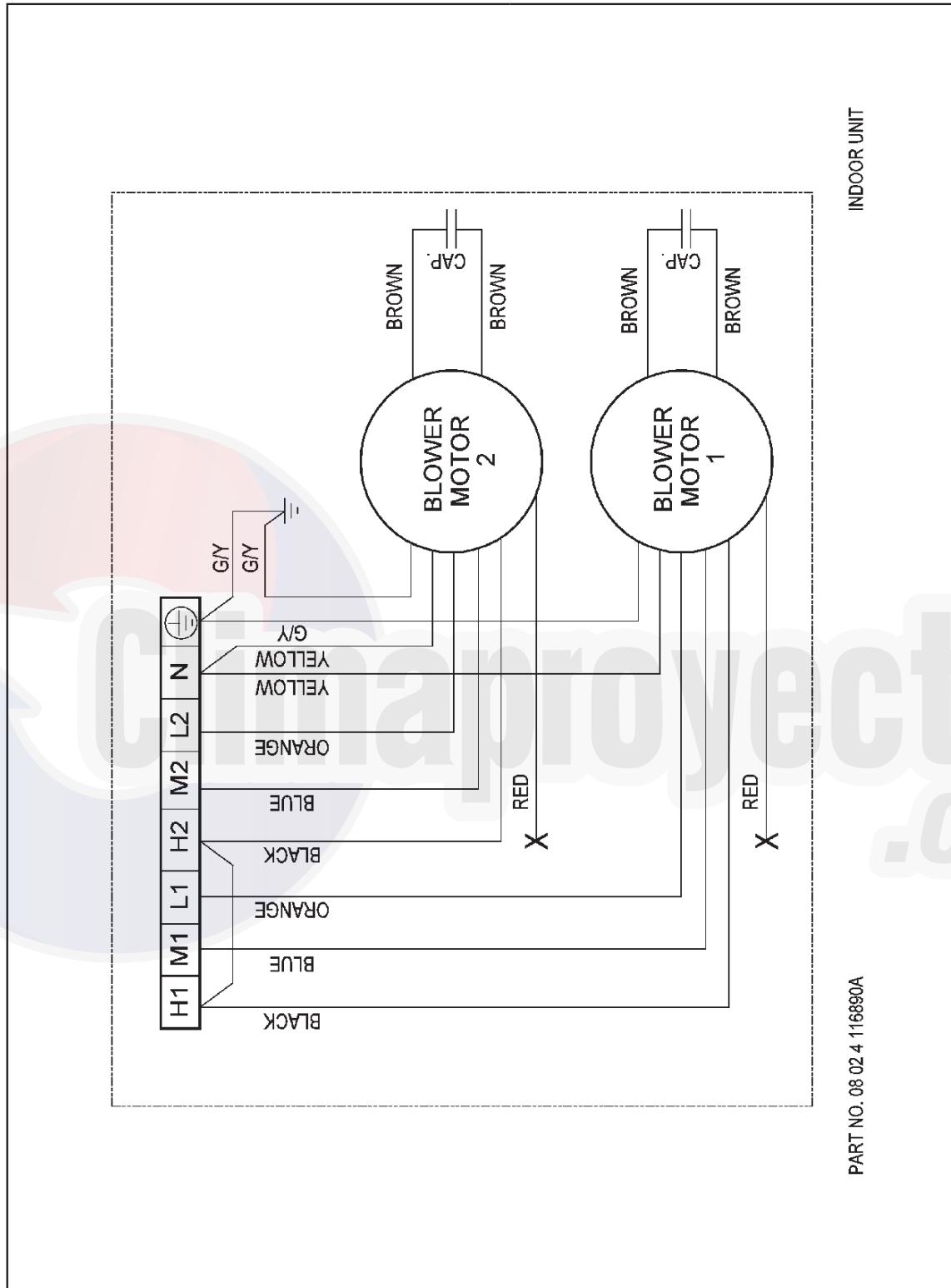

Model: MDB125/150BW

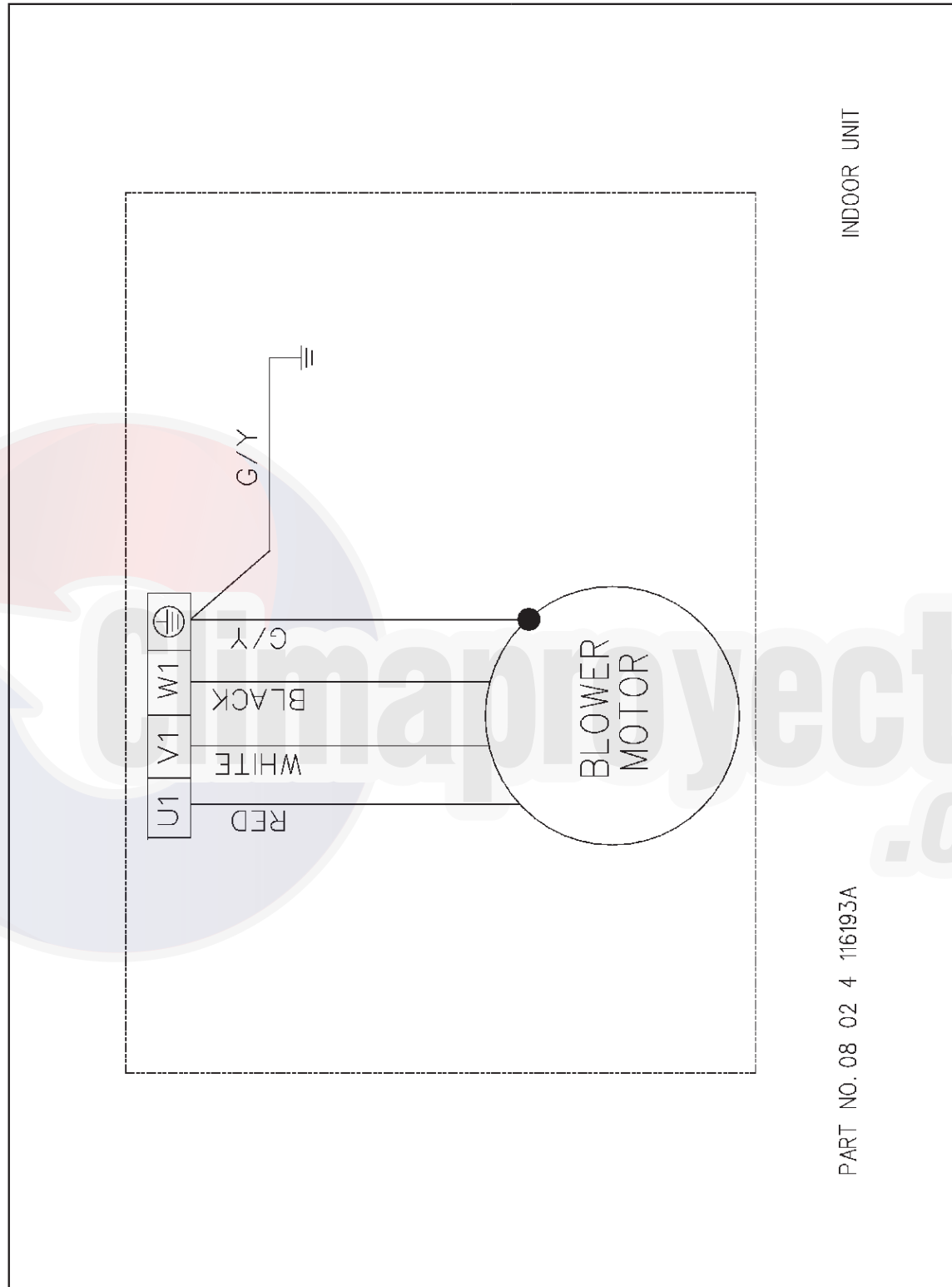

Service & Maintenance



Caution

Moving machinery and electrical power hazards. May cause severe personal injury or death. Disconnect from main power supply before servicing equipment.

The unit is designed to give long life operation with minimum maintenance required. However, it should be regularly checked and the following items should be given due attention.

Components	Maintenance Procedures	Recommended Schedule
Air Filter (Indoor Unit)	<ol style="list-style-type: none"> 1. Remove any dust adhering to the filter by using a vacuum cleaner or wash in lukewarm water (below 40°C) with a neutral cleaning detergent. 2. Rinse the filter well and dry before placing it back onto the unit. 3. Note: Never use gasoline, volatile substances or chemicals to clean the filter. 	<p>At least once every 4 weeks.</p> <p>More frequently if necessary.</p>
Indoor Unit	<ol style="list-style-type: none"> 1. Clean any dirt or dust on the grille or panel by wiping it with a soft cloth soaked in lukewarm water (below 40°C) and a neutral detergent solution. 2. Note: Never use gasoline, volatile substances or chemicals to clean the indoor unit. 	<p>At least once every 4 weeks.</p> <p>More frequently if necessary.</p>
Condense Drain Pan & Pipe	<ol style="list-style-type: none"> 1. Check the cleanliness and clean it if necessary. 	Every 3 months.
Indoor Fan	Check if there is any abnormal noise.	When necessary.
Indoor Coil	<ol style="list-style-type: none"> 1. Check and remove the dirt between the fins. 2. Check and remove any obstacles which hinder air flowing into and out of the indoor unit. 	Every month.
Power Supply	<ol style="list-style-type: none"> 1. Check the voltage and current of the indoor unit. 2. Check the electrical wiring for any faulty contacts caused by loose connections, foreign matters, etc. Tighten the wires onto the terminal block if necessary. 	Every 2 months.
Fan Motor Oil	All motors are pre-lubricated and sealed at factory.	No maintenance required.























Caution

Do not charge **OXYGEN, ACETYLENE OR OTHER FLAMMABLE** and poisonous gases into the unit when performing a leakage test or an air tight test. These gases could cause severe explosion and damage if expose to high temperature and pressure.

Troubleshooting

Model	Board
MWM07/10/15/20/25LW	50WJWXX
MWM301W	W2
MCK020/025/030/040/050EW	W3
MCK010/015/020CW	W2
MCC10/15/20/25/28/30/38/40/50/60CW	W2
MCM20/25/30/40/50DW	W2
MCM15/20/25EW	W2
MDB75/100/125/150BW	N/A

Self Diagnostic Table - 50WJWXX Board

	 COOL/HEAT (GREEN/RED)		Normal Operation/Fault Indication	Action	Error Code
	 Green		Cool mode	-	-
	 Red		Heat mode	-	-
			Timer on	-	-
			Sleep mode on	-	-
			Fan mode on	-	-
			Dry mode on	-	-
	 1 time		Room air sensor contact Loose/Short	Call your dealer	Blink E1
	 2 times		Indoor coil sensor open/short	Call your dealer	Blink E2
		 3 times	Pipe water temperature poor	-	Blink E4
		 1 time	Pipe water temperature bad	-	Blink E5
		 6 times	Hardware error (tact switch pin short)	Call your dealer	Blink E8
	 4 times		No feedback from indoor fan	Call your dealer	Blink E9

 ON

 ON or OFF

 Blinking

Self Diagnostic Table – W2 Board

Fault Indication	COOL LED	Error Code	Action
Room sensor error (short/open)	Blink 1 time	E1	Check room sensor connection/change room air sensor
Pipe water sensor error (short/open)	Blink 2 times	E2	Check pipe water sensor connection/change pipe water sensor
Water pump error	Blink 6 times	E6	Clear the clogging at drain pipe. If pump is not working, change the pump
Pipe water temperature fault	Blink 5 times	E5	Check chiller condition (not working or just started)
Window open activated*	Blink 3 times	-	-
Antifreeze mode activated*	Blink 7 times	-	-
Load shedding activated*	Blink 8 times	-	-

*Applicable for 4 pipes applications only.

Self Diagnostic Table – W3 Board

	Event	Power LED	Timer LED	Error Code
1.	Room Sensor Open or Short	Blink 1 time	-	Blink E1
2.	Pipe Water sensor Open or Short	Blink 2 times	-	Blink E2
3.	Pipe Water Temperature poor	Blink 3 times	-	Blink E4
4.	Pipe Water Temperature bad/fault	-	Blink 1 time	Blink E5
5.	Water Pump Fault	-	Blink 2 times	Blink E6
6.	Hardware Error (tact switch pin Short/M3 or M4 Mode with valveless section)	-	Blink 6 times	Blink E8
7.	Window Open activated*	Blink 6 times	-	-
8.	Antifreeze mode activated*	Blink 7 times	-	-
9.	Load Shedding activated*	Blink 8 times	-	-

*Only applicable for 4-pipes system.



McQuay[®]
Air Conditioning

While utmost care is taken in ensuring that all details in the publication are correct at time of going to press, we are constantly striving for improvement and therefore reserve the rights to alter model specifications and equipment without prior notice. Details of specifications and equipment are also subject to change to suit local conditions and requirements and not all models are available in every market.