



SUBMITTAL DATA – VRF Outdoor Unit

MVC-560WV2WN1

VRF COOL ONLY

Job: _____

Engineer: _____

Location: _____

Architect: _____

Schedule No.: _____

Date: _____

System Designation: _____

For: Reference Approval Review Construction

FEATURES

- All DC Inverter Technology
- Floating Evaporating Temperature
- Multi Silent Mode
- Back Up Operation
- Selectable High ESP (Optional)
- Wide Application Range
- Capacity Output Limitation
- Multi Priority Mode
- Auto Dust Cleaning (Optional)
- Anti-corrosion Protection (Optional)
- Auto Addressing
- Intelligent Duty Cycle Operation
- Real-time Refrigerant Amount Monitoring
- Auto Refrigerant Charging (Optional)

SPECIFICATIONS

PERFORMANCE

Cooling Capacity ¹	Btu/h	191,300
EER	Btu/W*h	11.6
Power Input	kW	16.5
Heating Capacity ¹	Btu/h	/
COP	Btu/W*h	/
Power Input	kW	/

ELECTRICAL DATA

Power Supply	V/Ph/Hz	220V,3Ph,50/60Hz
Minimum Circuit Ampacity	A	86.0
Total Over-current Amps.	A	98.5
Max. Fuse Amps.	A	100.0
Compressor RLA	A	37.9+37.7
No. of Compressors	/	2
Outdoor Fan Power Input	W	560+560
Outdoor Fan FLA	A	8.5

GENERAL DATA

Connection Ratio	%	50% to 130%
Max. # of Indoor Units	/	33
Sound Pressure Level	dB(A)	63
Outdoor Fan Air Volume	m ³ /h(CFM)	12,200(7,181)
Refrigerant type	/	R410A
Factory refrigerant charge	kg(lbs.)	13(28.7)

DIMENSIONS

Unit Dimensions mm(in.)	Height	1615(63-9/16)
	Width	1250(49-3/16)
	Depth	765(30-1/8)
Liquid Pipe Connection	mm(in.)	Φ15.9 (Φ5/8)
Gas Pipe Connection	mm(in.)	Φ31.8 (Φ1-1/4)
Net Weight	kg(lbs.)	296 (653)
Shipping Weight	kg(lbs.)	313 (690)



OPTIONAL ACCESSORIES

1. Cooling and Heating Capacity data is rated at the following conditions:

Cooling: 80.6°FDB / 66.2°F WB Indoor, 95°FDB Outdoor;

Heating: 68°FDB Indoor, 44.6°FDB / 42.8°F WB Outdoor;

NOTE – Due to Midea' ongoing commitment to quality, Specifications, Ratings and Dimensions subject to change without notice and without incurring liability. Improper installation, adjustment, alteration, service or maintenance can cause property damage or personal injury. Installation and service must be performed by a qualified installer and servicing agency.

DIMENSION mm(in.)

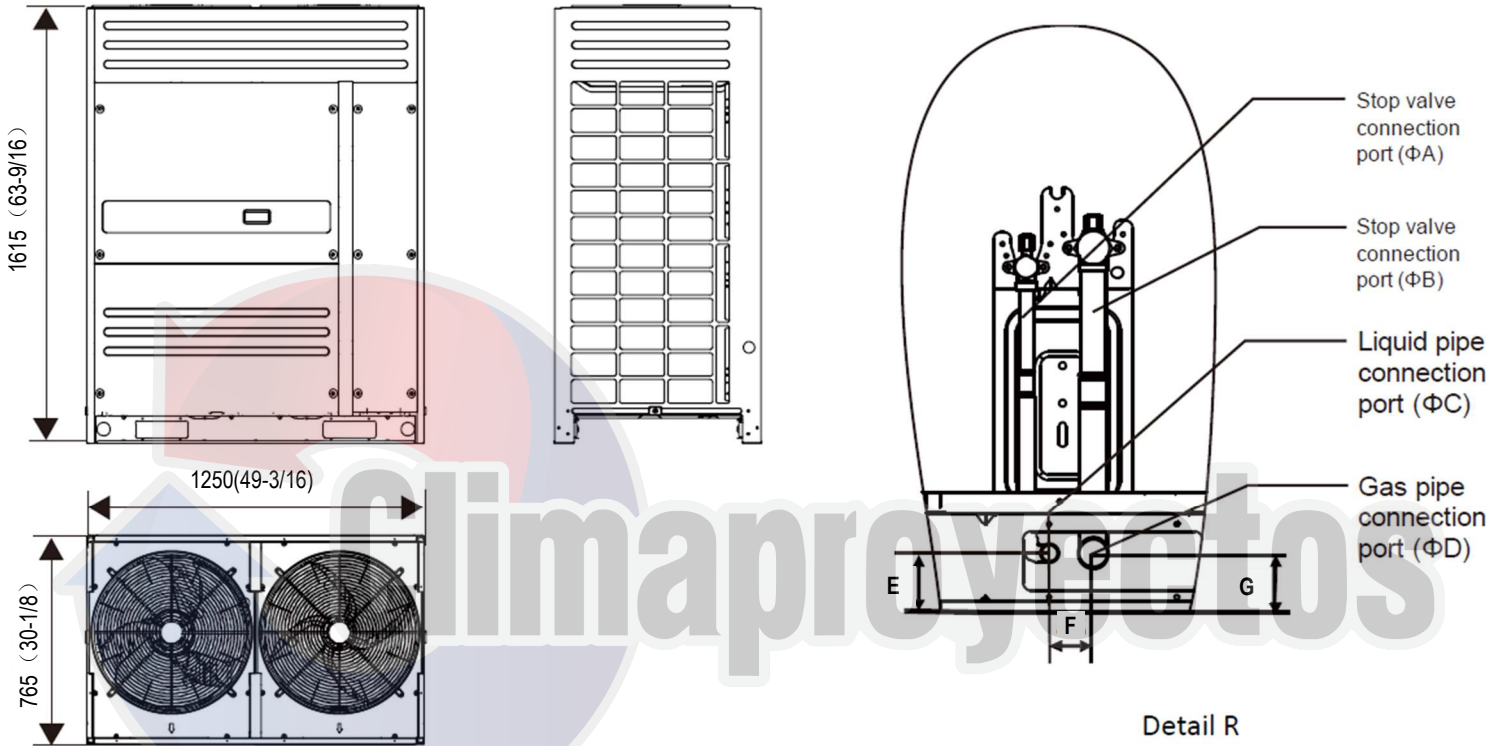

A	B	C	D	E	F	G
Φ15.9(5/8")	Φ28.6(1-1/8")	Φ15.9(5/8")	Φ31.8(1-1/4")	60(2-3/8")	45(1-3/4")	60(2-3/8")