

Supercedes:  
TS-MWM-LW\_(i)

## Model Name

**Models :**

	<b>Indoor</b>	<b>Nomenclature</b>	
<b>Cooling Only</b>	MWM07LW	ACEDA	
	MWM10LW		KCEDA
	MWM15LW		
	MWM20LW		
	MWM25LW		
<b>Heatpump</b>	MWM07LW	ACHDA	
	MWM10LW		
	MWM15LW		
	MWM20LW		
	MWM25LW		



<b>Content</b>	<b>Page</b>
<b>Nomenclature</b> -----	<b>1</b>
- Product Line-up	
<b>Application Information</b> -----	<b>3</b>
- Operating Range	
<b>Sound Data</b> -----	<b>4</b>
- Sound Pressure Level	
<b>Engineering &amp; Physical Data</b> -----	<b>5</b>
<b>Performance Data</b> -----	<b>7</b>
- Unit Selection Procedure	
- Cooling Performance Chart	
- Heating Performance Chart	
- Water Flow Rate vs Pressure Drop Chart	
<b>Outline and Dimension</b> -----	<b>19</b>
<b>Wiring Diagrams</b> -----	<b>20</b>
<b>Error Code</b> -----	<b>21</b>

<b>Note:</b>	Installation and maintenance are to be performed only by qualified personnel who are familiar with local codes and regulation, and experienced with this type of equipment
<b>Caution :</b>	Sharp edges and coil surfaces are a potential injury hazard. Avoid contact with them

<b>Warning :</b>	Moving machinery and electrical power hazard may cause severe personnel injury or death. Disconnect and lock off power before servicing equipment
------------------	---

# Nomenclature

**M WM 10 L W - A C E D A**

**Brand**

M: McQuay

**Product Type**

WM: Wall Mounted

**Size (Cooling/Heating)**

07: 8,300/11,000 btu/hr  
 10: 9,200/12,000 btu/hr  
 15: 11,300/15,000 btu/hr  
 20: 15,500/20,500 btu/hr  
 25: 18,000/25,000 btu/hr

**Product Series**

L: L Series

**Model**

W: Chilled Water Fan Coil

**Product Specification**

**Variation**

A: First Issue

**Grille**

D: Grille D

**Operating Mode**

E: Cooling Only  
 H: Heatpump

**Market Region**

C: Export with CE Mark

**Electrical Characteristics**

A : 50Hz / 1Ph / 220-240V  
 K : 60Hz / 1Ph / 208-230V

**Product Line Up**

**MWM-LW Series**

MWM-LW		Nomenclature	Classification								
			PCB	Handset		Control	Fan Speed	Air Purification	Connection		Marking
				50WJWxx_S0	EC GS01				HP GS01	Valve Or Valveless Application	
Cooling Only	07	ACEDA	X	X		X	X	X	X	X	X
	10	ACEDA	X	X		X	X	X	X	X	X
		KCEDA									
	15	ACEDA	X	X		X	X	X	X	X	X
		KCEDA									
	20	ACEDA	X	X		X	X	X	X	X	X
KCEDA											
25	ACEDA	X	X		X	X	X	X	X	X	
	KCEDA										
Heatpump	07	ACHDA	X		X	X	X	X	X	X	X
	10	ACHDA	X		X	X	X	X	X	X	X
	15	ACHDA	X		X	X	X	X	X	X	X
	20	ACHDA	X		X	X	X	X	X	X	X
	25	ACHDA	X		X	X	X	X	X	X	X

Note: PCB naming is following model name.

xx = 07 or 10 or 15 or 20 or 25.

# Application Information

## Operating Range:

Ensure the operating temperature is in allowable range.

Thermal Carrier: Water

Water Temperature: 4-10°C Cooling; 35-50°C Heating

Maximum Water Pressure: 16 bar

Air temperature: (as below)

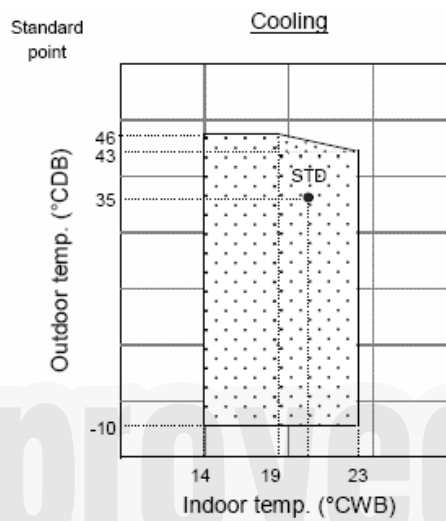
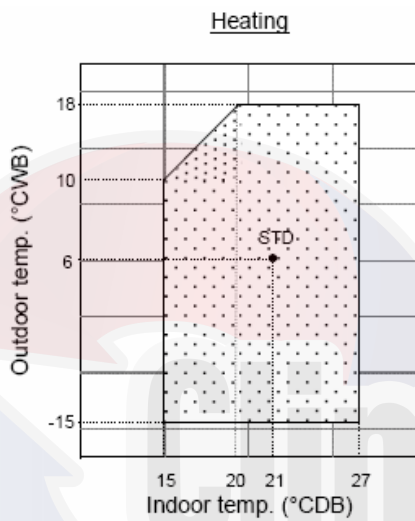

**Caution :**  
 The use of your air conditioner outside the range of working temperature and humidity can result in serious failure.

### Heating Mode

Temperature	Ts °C/°F	Th °C/°F
Minimum indoor temperature	15.0 / 59.0	-
Maximum indoor temperature	27.0 / 80.6	-

### Cooling Mode

Temperature	Ts °C/°F	Th °C/°F
Minimum indoor temperature	19.0 / 66.2	14.0 / 57.2
Maximum indoor temperature	32.0 / 89.6	23.0 / 73.4

**Note:**

Ts: Dry bulb temperature

Th: Wet bulb temperature

# Sound Data

## Sound Pressure Level

Model	Speed	1/1 Octave Sound Pressure Level (dB, ref 20µPa)							Overall (dBA)	Noise Criteria
		125Hz	250Hz	500Hz	1kHz	2kHz	4kHz	8kHz		
MWM07LW	High	31	32	33	28	28	14	6	34	28
	Med	25	29	28	24	19	9	5	29	22
	Low	20	28	24	20	11	8	6	25	18
MWM10LW	High	30	33	33	32	28	17	8	35	31
	Med	26	29	30	27	21	11	7	30	25
	Low	19	25	25	21	14	6	6	25	19
MWM15LW	High	41	39	39	38	36	26	14	42	38
	Med	38	36	37	34	32	22	10	39	33
	Low	30	30	31	28	23	12	7	32	26
MWM20LW	High	37	38	38	39	33	22	11	42	38
	Med	33	35	35	35	29	17	8	38	34
	Low	29	33	32	31	23	12	7	34	30
MWM25LW	High	42	42	42	42	40	31	21	43	42
	Med	37	38	39	38	34	24	13	42	37
	Low	34	35	36	35	30	20	9	39	34

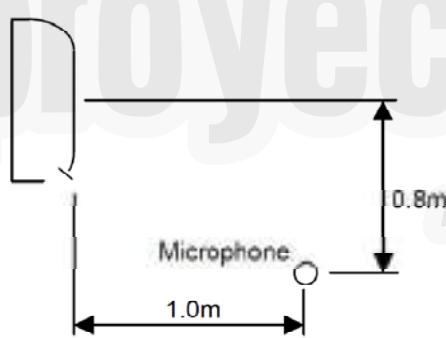
Model	Measuring Location
MWM07/10/15/20/25 LW	 <p>Testing Standard: JIS C 9612</p>

# Engineering and Physical Data

## Engineering Data – MWM-JW (50Hz Model)

MODEL	INDOOR UNIT		MWM07LW	MWM10LW	MWM15LW	MWM20LW	MMW25LW	
NOMINAL COOLING CAPACITY	Btu/h		8300	9200	11300	15500	18000	
	W		2430	2700	3310	4540	5280	
NOMINAL SENSIBLE COOLING CAPACITY	Btu/h		6300	6900	9000	11700	14000	
	W		1850	2020	2640	3430	4100	
NOMINAL HEATING CAPACITY (ENTERING WATER TEMP. = 50°C)	Btu/h		11000	12000	15000	20500	25000	
	W		3220	3520	4400	6010	7330	
NOMINAL TOTAL INPUT POWER (COOLING)	W		31	32	42	53	72	
NOMINAL TOTAL INPUT POWER (HEATING)	W		30	31	39	57	67	
NOMINAL RUNNING CURRENT (COOLING)	A		0.19	0.20	0.21	0.29	0.34	
NOMINAL RUNNING CURRENT (HEATING)	A		0.20	0.20	0.21	0.30	0.35	
POWER SOURCE	V/Ph/Hz		220-240/1/50					
CONTROL	AIR DISCHARGE OPERATION		AUTOMATIC LOUVER (UP & DOWN)					
			WIRELESS LCD REMOTE CONTROL					
AIR FLOW	HIGH		l/s / CFM	123 / 260	132 / 280	175 / 370	241 / 510	293 / 620
	MEDIUM		l/s / CFM	109 / 230	118 / 250	151 / 320	213 / 450	245 / 520
	LOW		l/s / CFM	95 / 200	104 / 220	123 / 260	184 / 390	217 / 460
	QUIET		l/s / CFM	85 / 180	90 / 190	114 / 240	170 / 360	208 / 440
EXTERNAL STATIC PRESSURE		Pa (in. wg.)	NA					
SOUND PRESSURE LEVEL (H/M/L/Q)		dBA	34 / 29 / 25 / 24	35 / 30 / 25 / 24	42 / 39 / 32 / 29	42 / 38 / 34 / 32	46 / 42 / 39 / 37	
NOMINAL WATER FLOW RATE		USGPM	1.85	2.03	2.51	3.43	4.01	
		liters / min	7.00	7.70	9.50	13.00	15.20	
HEAD LOSS (COOLING)		kPa / psi	34 / 4.93	24 / 3.48	31 / 4.50	30 / 4.35	36 / 5.22	
HEAD LOSS (HEATING) : 50°C		kPa / psi	29 / 4.21	20 / 2.90	25 / 3.63	27 / 3.92	33 / 4.79	
Max Working Pressure		kPa / psi	1600 / 232					
UNIT DIMENSION	HEIGHT X WIDTH X DEPTH	mm	288 x 800 x 206			310 x 1065 x 224		
PACKING DIMENSION	HEIGHT X WIDTH X DEPTH	mm	344 x 874 x 274			386 x 1136 x 314		
UNIT WEIGHT		kg / lb	9 / 20			14 / 31		
CONDENSATE DRAIN SIZE		mm	19.0					
CONNECTION			1/2" BSP FEMALE ADAPTOR					
FAN	TYPE		CROSS FLOW					
	DRIVE		DIRECT					
FAN MOTOR	TYPE		1 PHASE SCR					
	INDEX OF PROTECTION (IP)		20					
	INSULATION GRADE		E					
	RATED INPUT POWER (COOLING)		W	31	32	42	53	72
	RATED INPUT POWER (HEATING)		W	30	31	39	57	67
	RATED RUNNING CURRENT (COOLING)		A	0.19	0.20	0.21	0.29	0.34
	RATED RUNNING CURRENT (HEATING)		A	0.20	0.20	0.21	0.30	0.35
	MOTOR OUTPUT		W	18		26	30	
COIL	POLES		4					
	TUBE	MATERIAL	COPPER					
		DIAMETER	mm	7.0				
	FIN	MATERIAL	ALUMINIUM					
		FACE AREA	m <sup>2</sup>	0.18		0.29		
ROW			2					
AIR QUALITY	FILTER	TYPE	WASHABLE SARANET FILTER					
		QUANTITY	pc	2				
CASING		COLOUR	WHITE					

1) ALL SPECIFICATIONS ARE SUBJECTED TO CHANGE BY THE MANUFACTURER WITHOUT PRIOR NOTICE.

2) NOMINAL COOLING AND HEATING CAPACITY ARE BASED ON THE CONDITIONS BELOW :

- a) COOLING - ENTERING AIR TEMP. : 27°C (80.6°F) DB / 19°C (66.2°F) WB, ENTERING WATER TEMP. : 7°C (44.6°F), LEAVING WATER TEMP. : 12°C (53.6°F)
- b) HEATING - ENTERING AIR TEMP.: 20°C (68°F) DB, ENTERING WATER TEMP. : 50°C (122°F), WATER FLOW RATE BASED ON COOLING CYCLE.

## Engineering Data – MWM-LW (60Hz Model)

MODEL		INDOOR UNIT		MWM10LW	MWM15LW	MWM20LW	MMW25LW		
NOMINAL COOLING CAPACITY				Btu/h	9200	11300	15500	18000	
				W	2700	3310	4540	5280	
NOMINAL SENSIBLE COOLING CAPACITY				Btu/h	6900	9000	11700	14000	
				W	2020	2640	3430	4100	
NOMINAL TOTAL INPUT POWER				W	31	42	57	70	
NOMINAL RUNNING CURRENT				A	0.18	0.20	0.30	0.33	
POWER SOURCE				V/Ph/Hz	208-230/1/60				
INDOOR UNIT	CONTROL		AIR DISCHARGE OPERATION		AUTOMATIC LOUVER (UP & DOWN)				
	AIR FLOW		HIGH		I/s / CFM	132 / 280	175 / 370	241 / 510	293 / 620
			MEDIUM		I/s / CFM	118 / 250	151 / 320	213 / 450	245 / 520
			LOW		I/s / CFM	104 / 220	123 / 260	184 / 390	217 / 460
			QUIET		I/s / CFM	90 / 190	114 / 240	170 / 360	208 / 440
	EXTERNAL STATIC PRESSURE				Pa (in.wg.)	NA			
	SOUND PRESSURE LEVEL (H/M/L/Q)				dBA	35 / 30 / 25 / 24	42 / 39 / 32 / 29	42 / 38 / 34 / 32	46 / 42 / 39 / 37
	NOMINAL WATER FLOW RATE				USGPM	2.03	2.51	3.43	4.01
					liters / min	7.70	9.50	13.00	15.20
	HEAD LOSS				kPa / psi	24 / 3.48	31 / 4.50	30 / 4.35	36 / 5.22
	Max Working Pressure				kPa / psi	1600 / 232			
	UNIT DIMENSION		HEIGHT X WIDTH X DEPTH		mm	288 x 800 x 206		310 x 1065 x 224	
	PACKING DIMENSION		HEIGHT X WIDTH X DEPTH		mm	344 x 874 x 274		386 x 1136 x 314	
	UNIT WEIGHT				kg / lb	9 / 20		14 / 31	
	CONDENSATE DRAIN SIZE				mm	19.0			
	CONNECTION					1/2" BSP FEMALE ADAPTOR			
	FAN		TYPE		CROSS FLOW				
			DRIVE		DIRECT				
	FAN MOTOR		TYPE		1 PHASE SCR				
			INDEX OF PROTECTION (IP)		44				
INSULATION GRADE			E						
RATED INPUT POWER			W	31	42	57	70		
RATED RUNNING CURRENT			A	0.18	0.20	0.30	0.33		
		MOTOR OUTPUT		W	18	18	30	30	
		POLES		4					
COIL		TUBE		MATERIAL		COPPER			
				DIAMETER		7.0			
		FIN		MATERIAL		ALUMINIUM			
		FACE AREA		m <sup>2</sup>	0.18		0.29		
		ROW		2					
AIR QUALITY		FILTER		TYPE		WASHABLE SARANET FILTER			
				QUANTITY		2			
CASING				COLOUR	WHITE				

1) ALL SPECIFICATIONS ARE SUBJECTED TO CHANGE BY THE MANUFACTURER WITHOUT PRIOR NOTICE.

2) NOMINAL COOLING CAPACITY ARE BASED ON THE CONDITIONS BELOW :

ENTERING AIR TEMP. : 27°C (80.6°F) DB / 19°C (66.2°F) WB, ENTERING WATER TEMP. : 7°C (44.6°F), LEAVING WATER TEMP. : 12°C (53.6°F)



# Performance Data

## Unit Selection Procedure

Select a wall mounted type fan coil unit at the following design specification:

Room Design Condition	: 26.7°C DB / 19°C WB
Room Cooling Load	: 2.5 kW sensible capacity / 3 kW total capacity
Room Heating Load	: 4 kW
Entering Water Temperature	: 7°C cooling / 70°C heating
Water Temperature Rise	: 5°C
Air Volume	: 350 CFM
Altitude	: 600 m

### Step 1

Based on the design conditions, tentatively select **MWM15LW**.

Refer **Cooling Capacity Performance Chart**, at 26.7°C DB / 19°C WB air temperature, 7°C entering water temperature and with 5°C water temperature rise, the **Total Capacity** is 3.2 kW and **Sensible Capacity** is 2.6 kW.

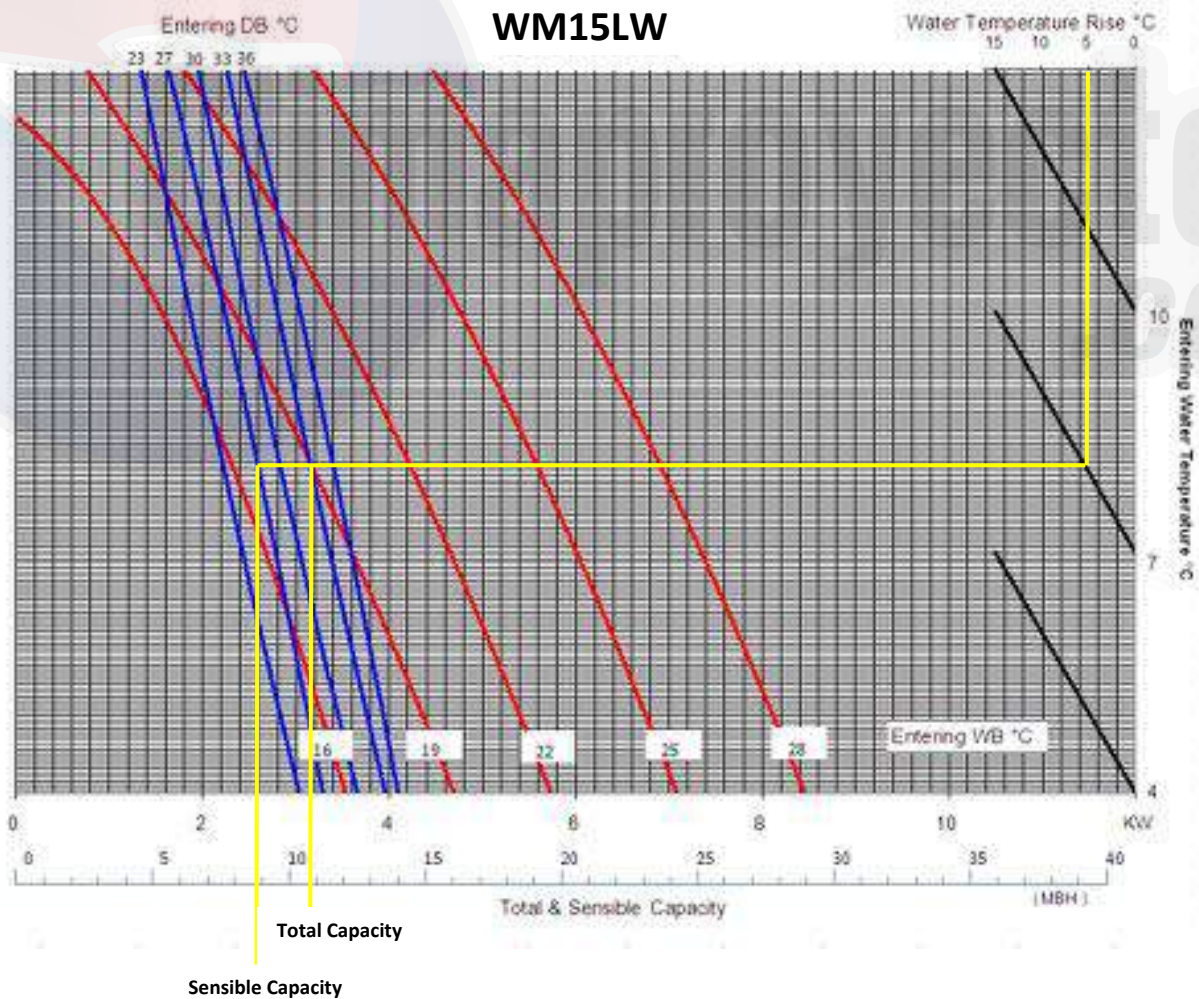

**Step 2**

Refer on below **Air Flow Correction Factor Table**.

Model	Speed	CFM	Total Capacity Ratio	Sensible Cooling Capacity Ratio
MWM07LW	High	260	1.00	1.00
	Medium	230	0.94	0.89
	Low	200	0.87	0.81
MWM10LW	High	280	1.00	1.00
	Medium	250	0.91	0.90
	Low	220	0.83	0.80
MWM15LW	High	370	1.00	1.00
	Medium	320	0.93	0.90
	Low	260	0.84	0.78
MWM20LW	High	510	1.00	1.00
	Medium	450	0.94	0.91
	Low	390	0.84	0.82
MWM25LW	High	620	1.00	1.00
	Medium	520	0.89	0.88
	Low	460	0.83	0.80

At high speed (approximate 350cfm), the **Air Flow Correction Factor** is 1.00.

**Step 3**

Refer on below **Altitude Correction Factor Table**.

Elevation, m	Total Capacity	Sensible Capacity
0	1.00	1.00
300	0.99	0.96
600	0.98	0.93
900	0.97	0.90
1200	0.96	0.86
1500	0.94	0.83
1800.	0.93	0.80

At 600m above sea level, the **Altitude Correction Factor** is 0.98 total and 0.93 sensible.

**Step 4**

Multiply the cooling capacities obtained from **Step 1** by correction factors from **Step 2 & 3**.

Actual total cooling capacity = 3.2 x 1.0 x 0.98 kW  
= 3.14 kW

Actual sensible cooling capacity = 2.6 x 1.0 x 0.93 kW  
= 2.42 kW

**Step 5**

Water flow rate can be determined by:

$$\text{Litres/Min} = \frac{\text{Total Cooling Capacity, W}}{70 \times \text{Water Temperature Rise } ^\circ\text{C}}$$

$$\text{USGPM} = \frac{\text{Total Cooling Capacity, Btu/H}}{500 \times \text{Water Temperature Rise } ^\circ\text{F}}$$

Hence, **Water Flow Rate** is 8.97 liters/min

**Step 6**

Refer on **Heating Capacity Performance Chart**.

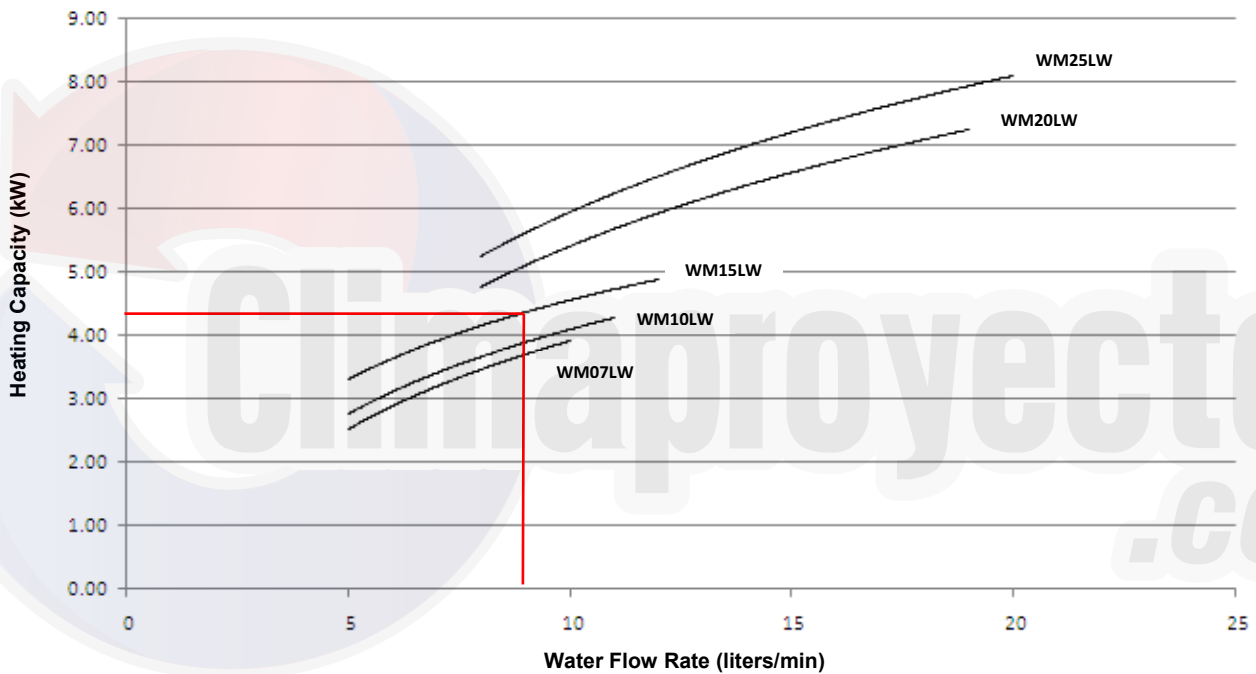

At water flow rate, 8.97liters/min, **Heating Capacity** is 4.3 kW

**Step 7**

Refer on below **Heating Capacity Correction Factor Table**.

EAT °C	ENT TEMP, °C												
	37.8	43.3	45	48.8	50	54.4	60	65.5	70	71.1	76.7	82.2	87.7
4.4	1.338	1.376	1.388	1.414	1.422	1.452	1.491	1.529	1.559	1.569	1.605	1.643	1.683
7.2	1.257	1.297	1.310	1.338	1.347	1.379	1.421	1.462	1.497	1.507	1.547	1.586	1.630
10	1.176	1.221	1.235	1.265	1.275	1.311	1.356	1.401	1.433	1.444	1.488	1.531	1.577
12.7	1.093	1.140	1.155	1.187	1.198	1.235	1.284	1.331	1.370	1.381	1.426	1.476	1.523
15.5	1.010	1.061	1.077	1.113	1.124	1.165	1.217	1.268	1.306	1.318	1.368	1.420	1.471
18.3	0.958	0.999	1.013	1.044	1.054	1.095	1.149	1.199	1.242	1.255	1.308	1.363	1.419
20	0.877	0.933	0.950	0.989	1.000	1.046	1.103	1.159	1.2035	1.216	1.274	1.330	1.386
21.1	0.824	0.890	0.910	0.953	0.965	1.014	1.074	1.134	1.179	1.192	1.251	1.308	1.364
23.9	0.758	0.819	0.838	0.880	0.894	0.943	1.005	1.066	1.115	1.129	1.191	1.252	1.312
26.7	0.677	0.741	0.761	0.806	0.820	0.871	0.937	1.001	1.052	1.067	1.133	1.197	1.259

At 70°C water entering temperature and 26.7°C entering air temperature, the correction factor is 1.052.

Hence, **Actual Heating Capacity** = 4.3 x 0.98 x 1.052

$$= 4.43 \text{ kW}$$

**Step 8**

Refer on below **Water Flow Rate vs Pressure Drop Table**.

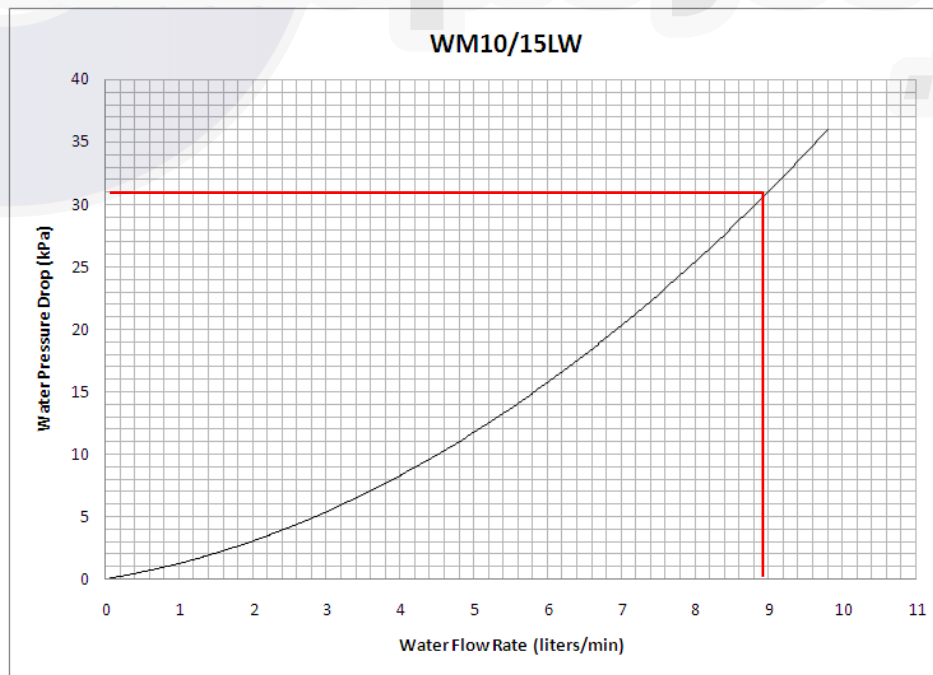

At flow rate of 8.97 litres/min, the **Pressure Drop** is 31 kPa

Cooling Performance Chart

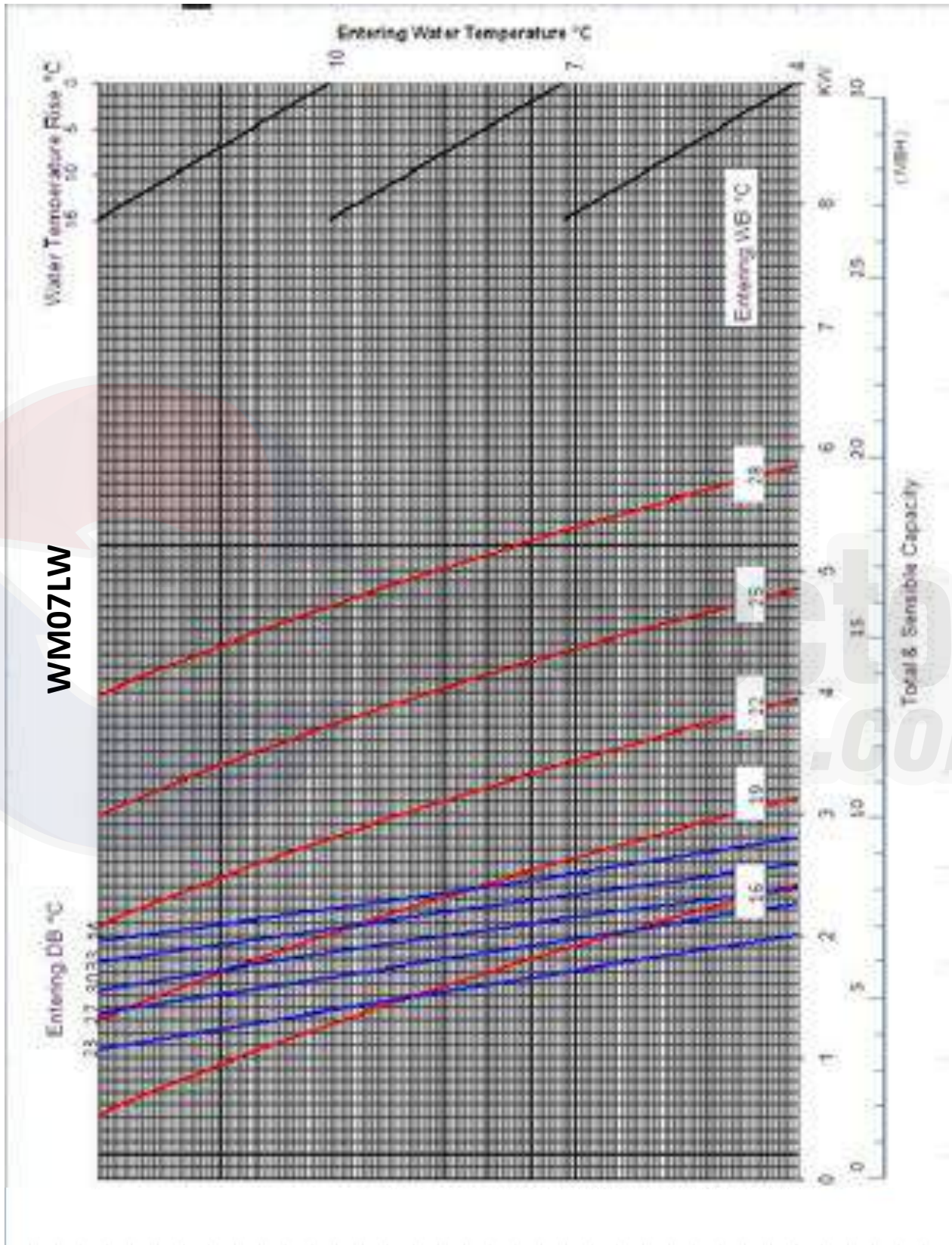

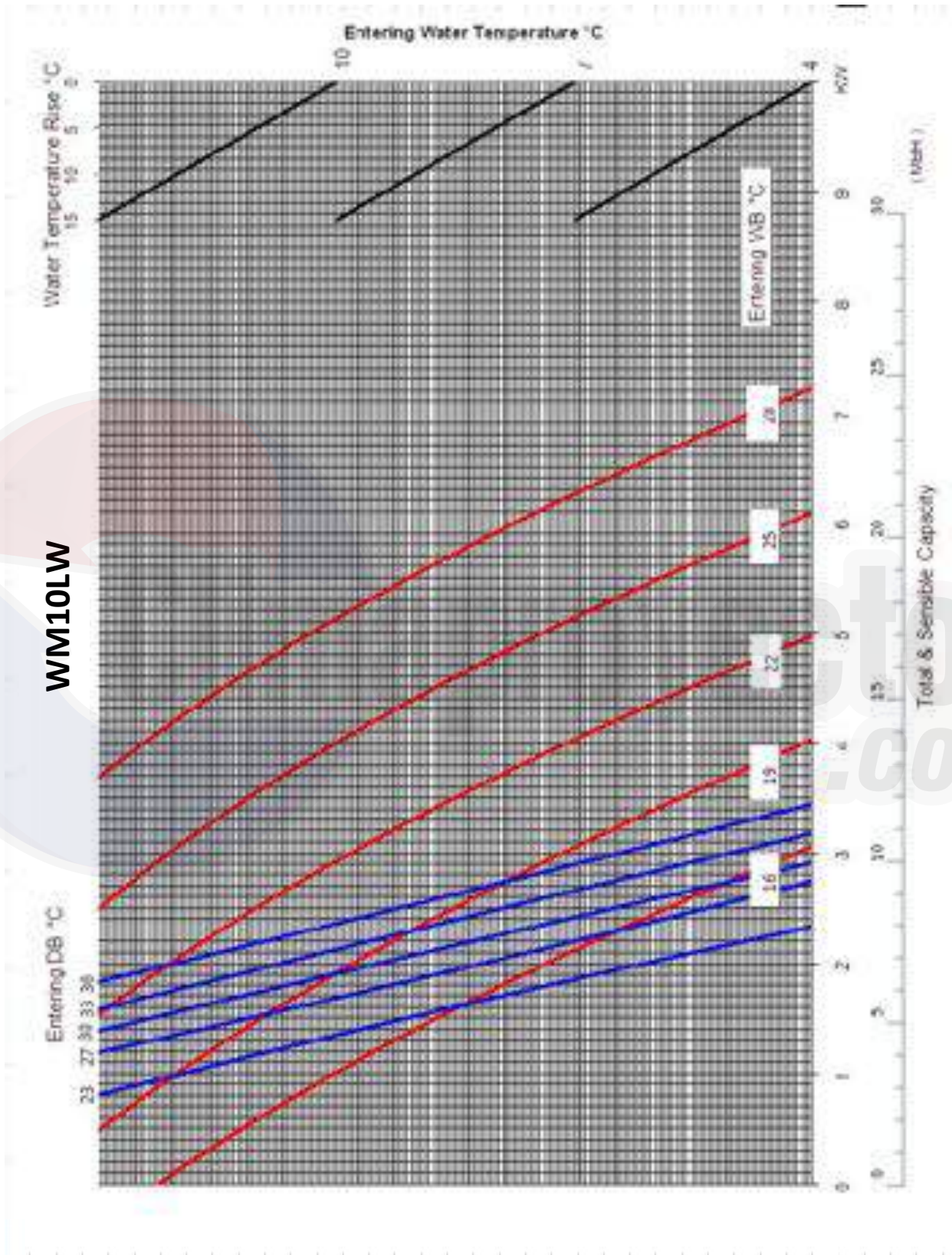

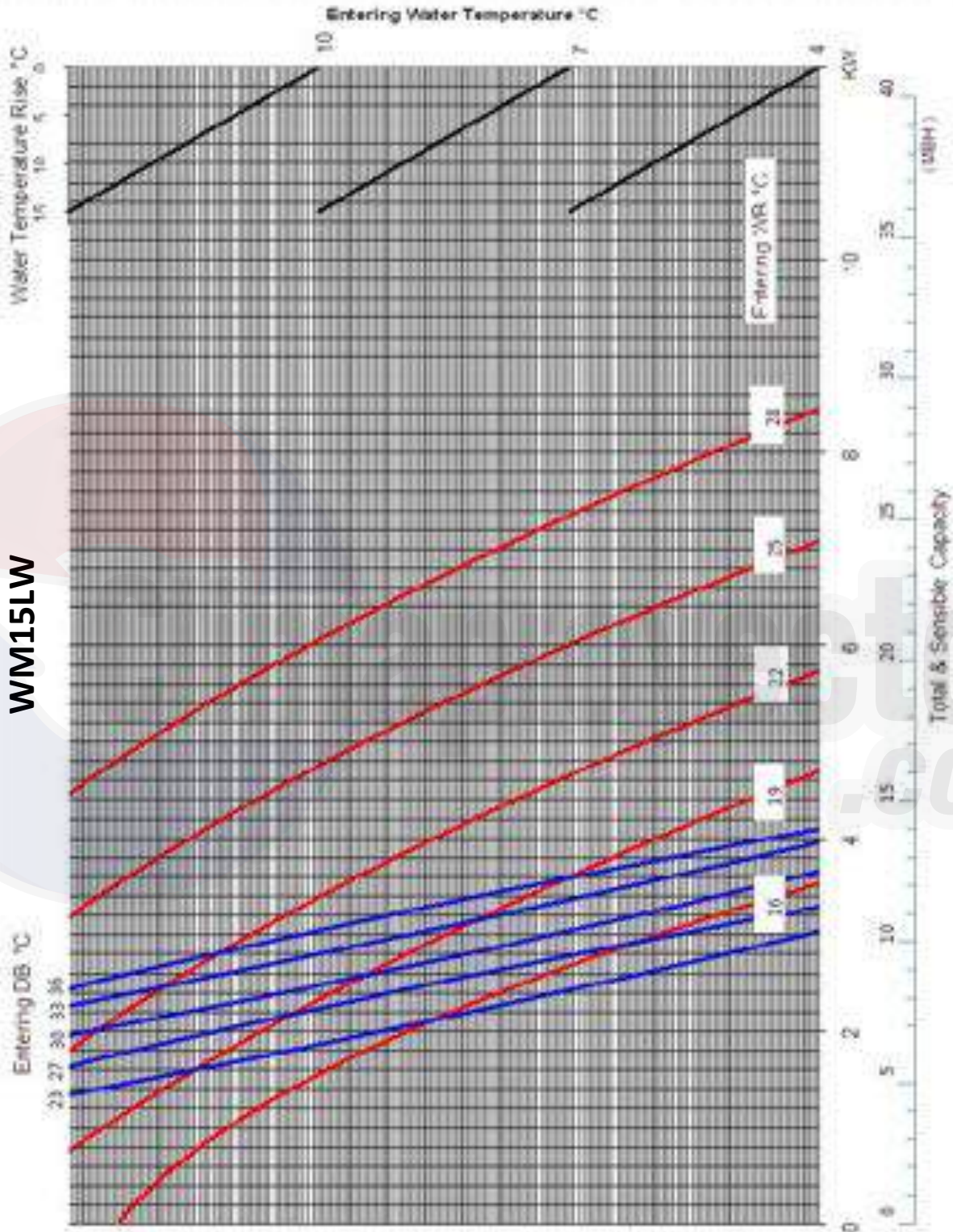

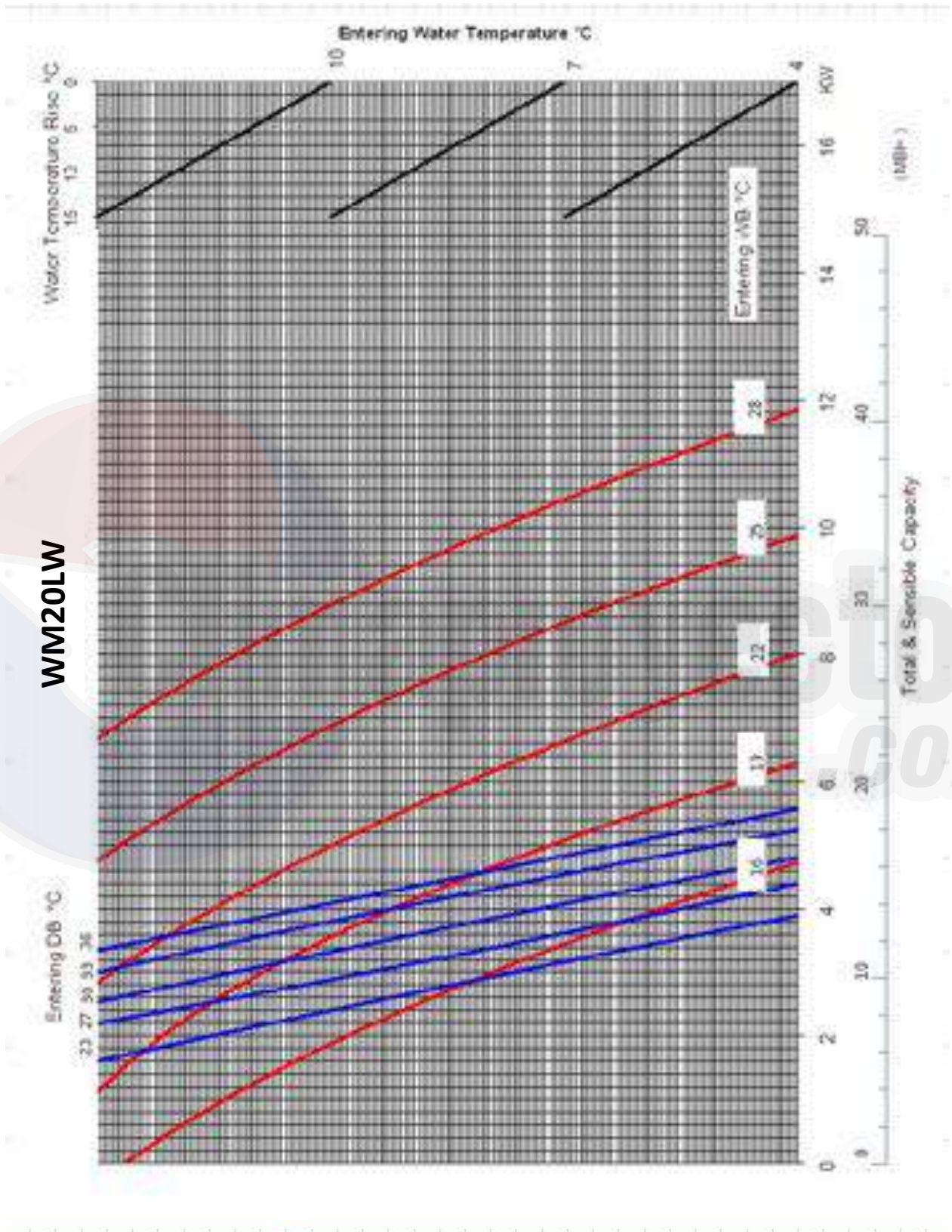



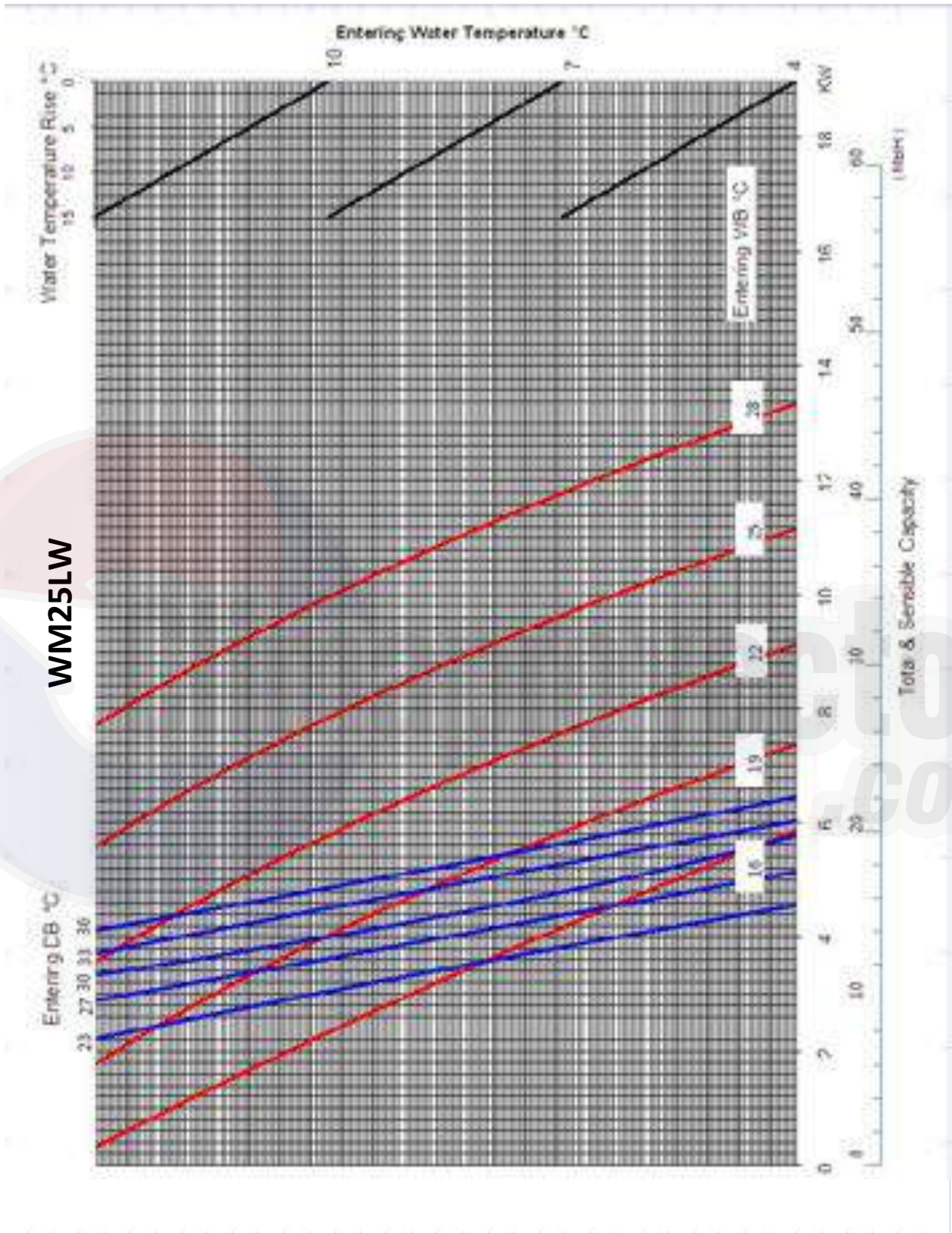

### Heating Performance Chart

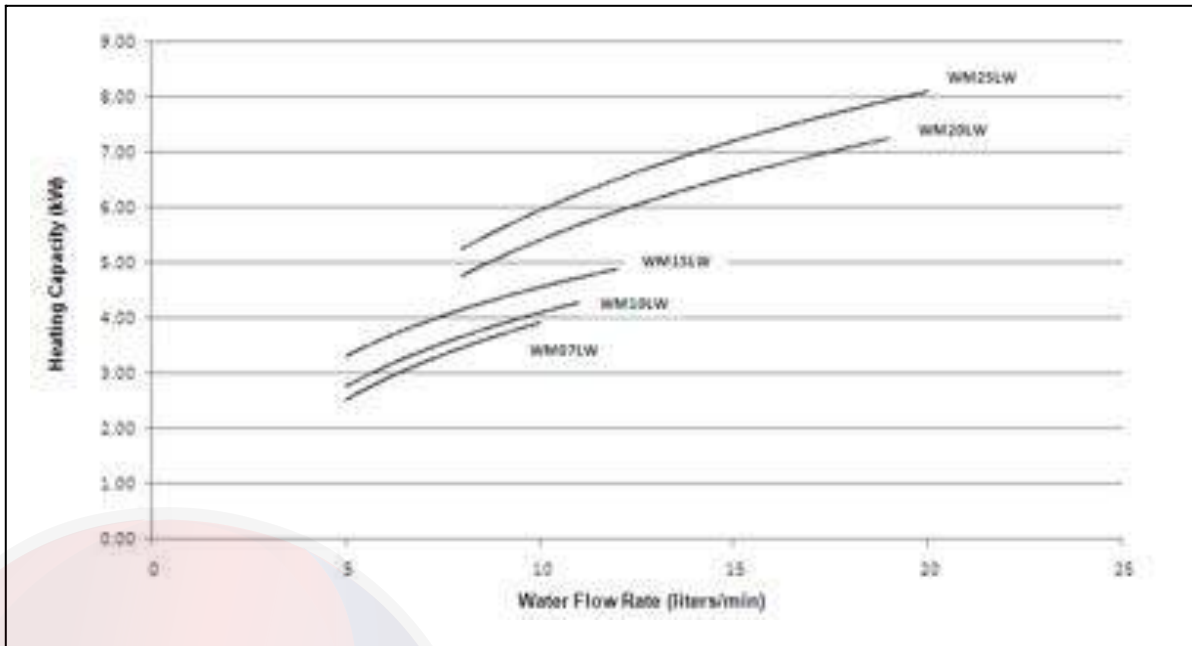

Climaproyectos.com

Water Flow Rate vs Pressure Drop Chart

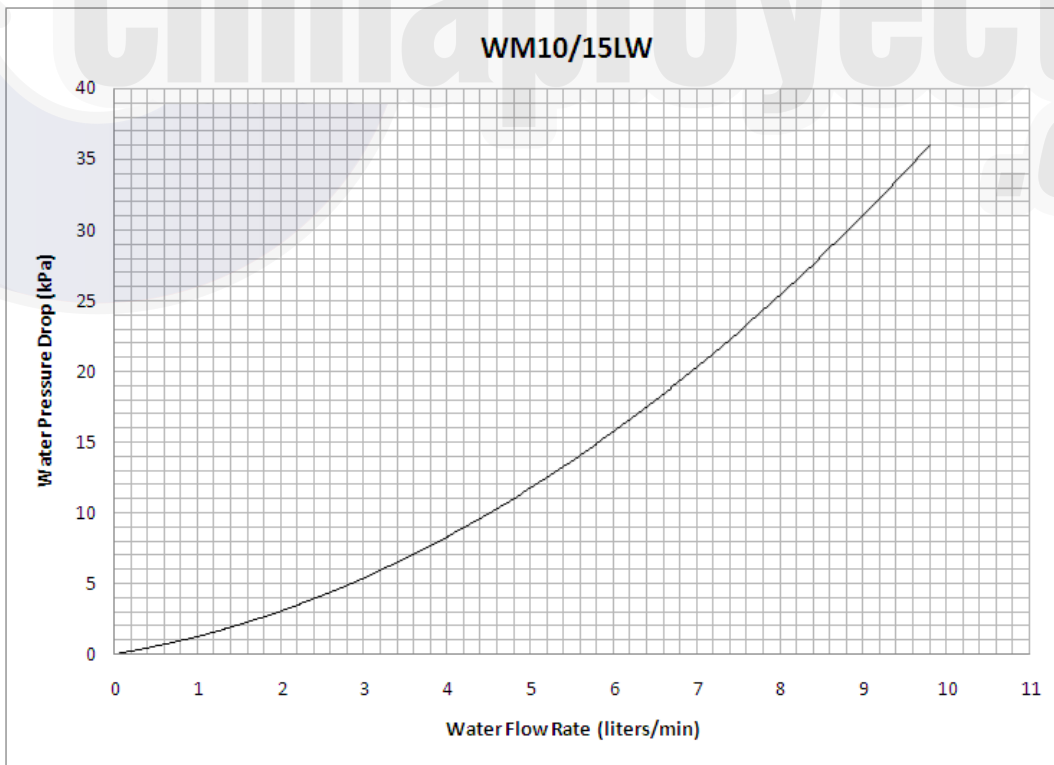
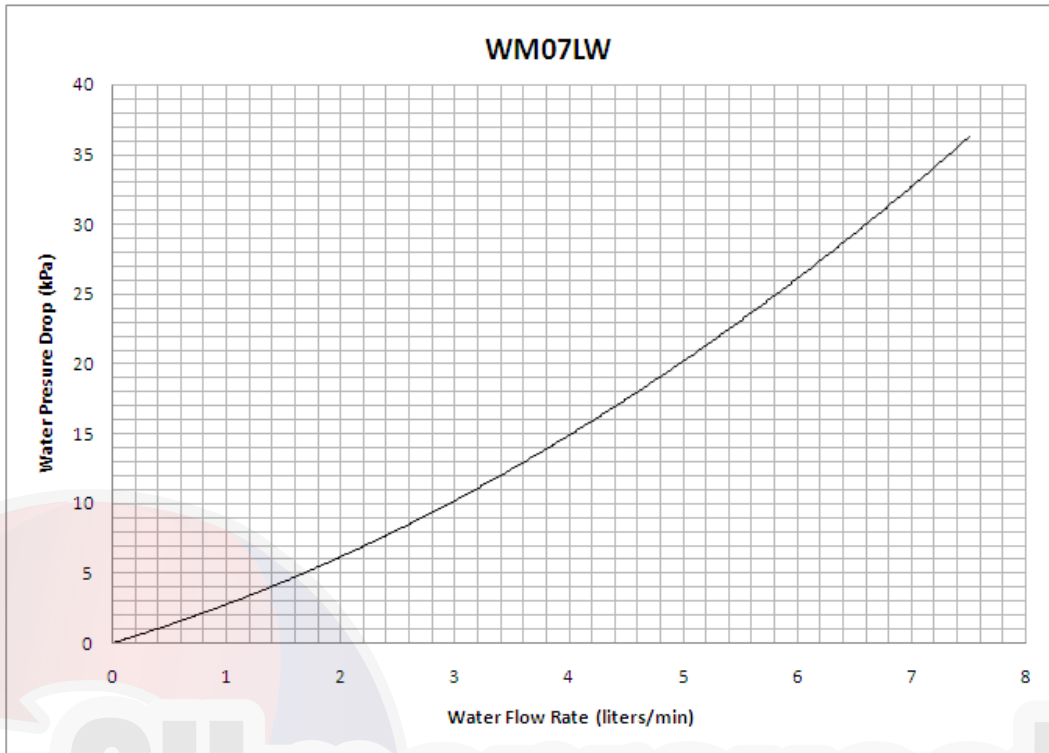

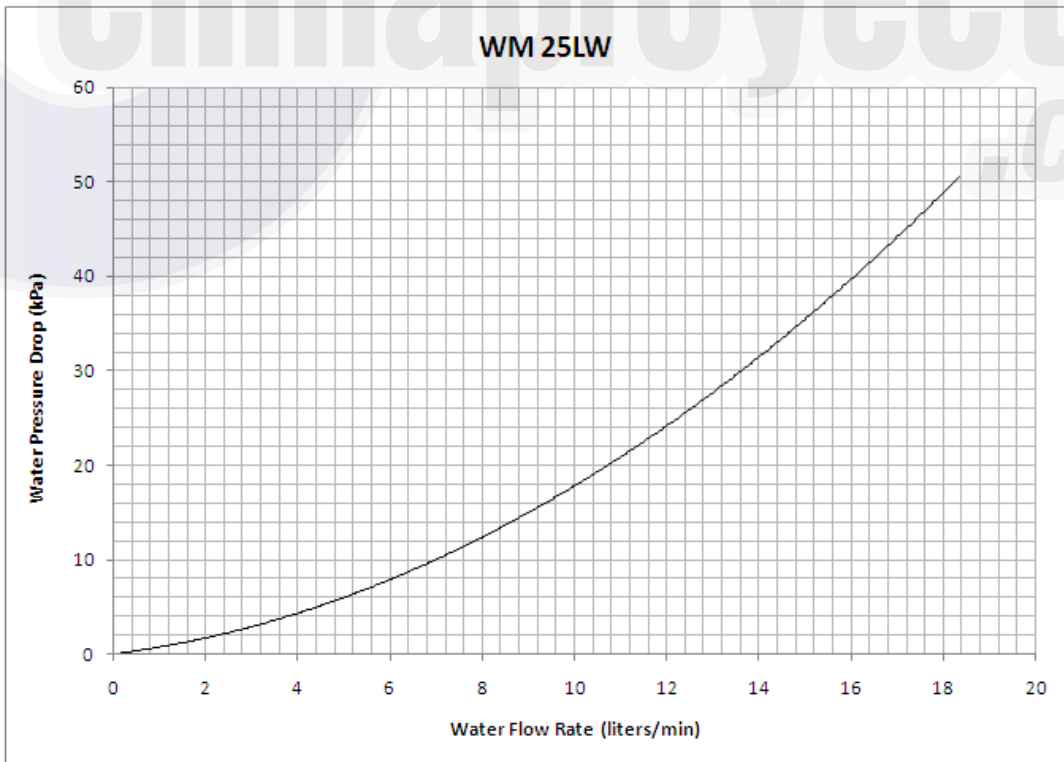
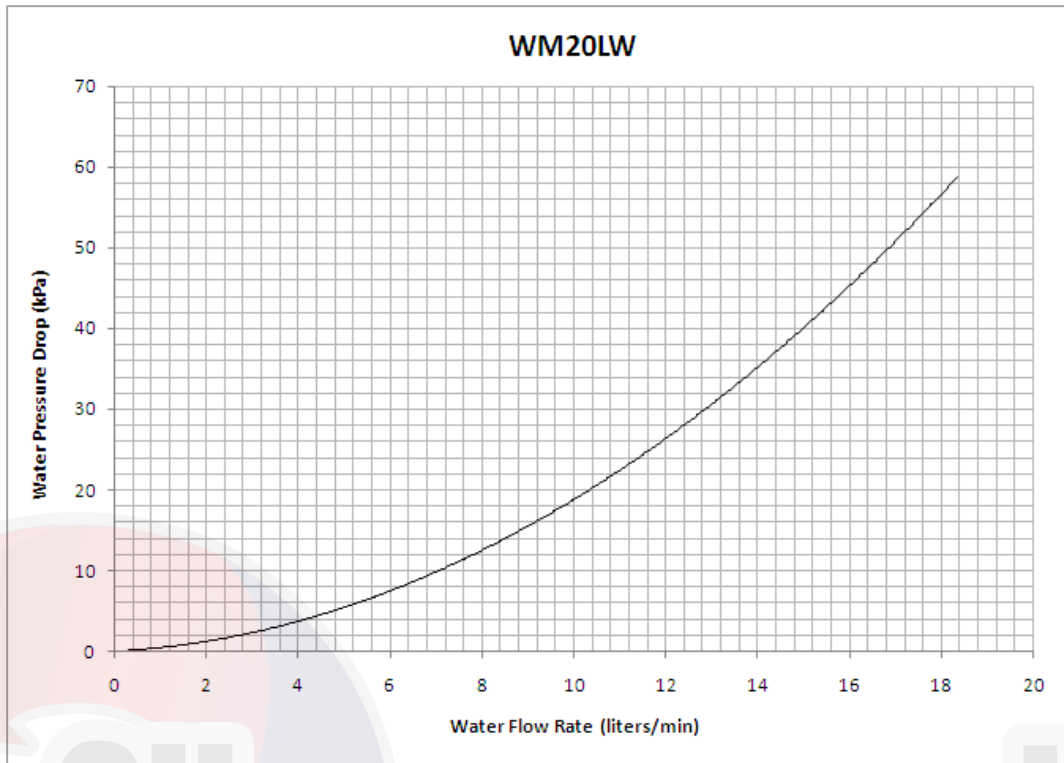

# Outline and Dimension

MWM-LW

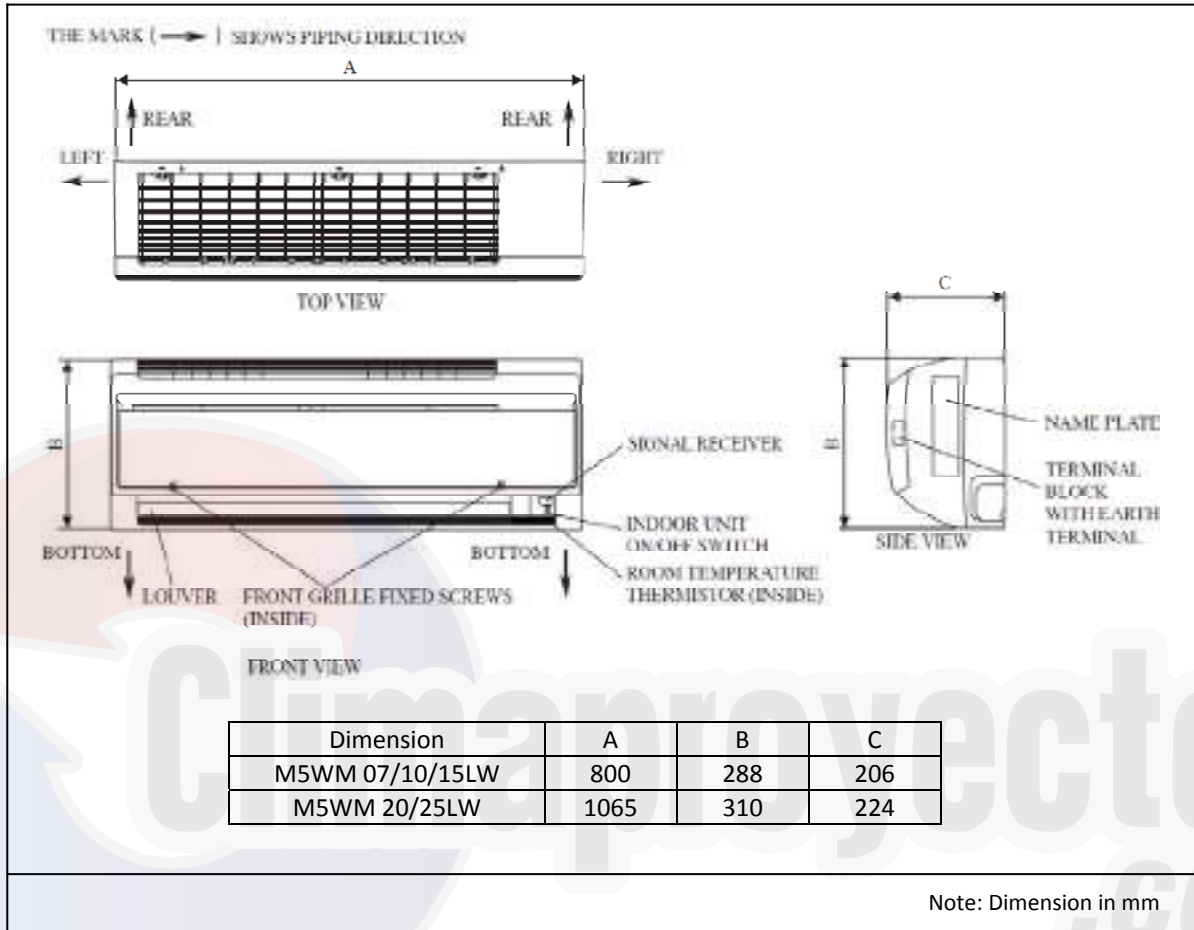

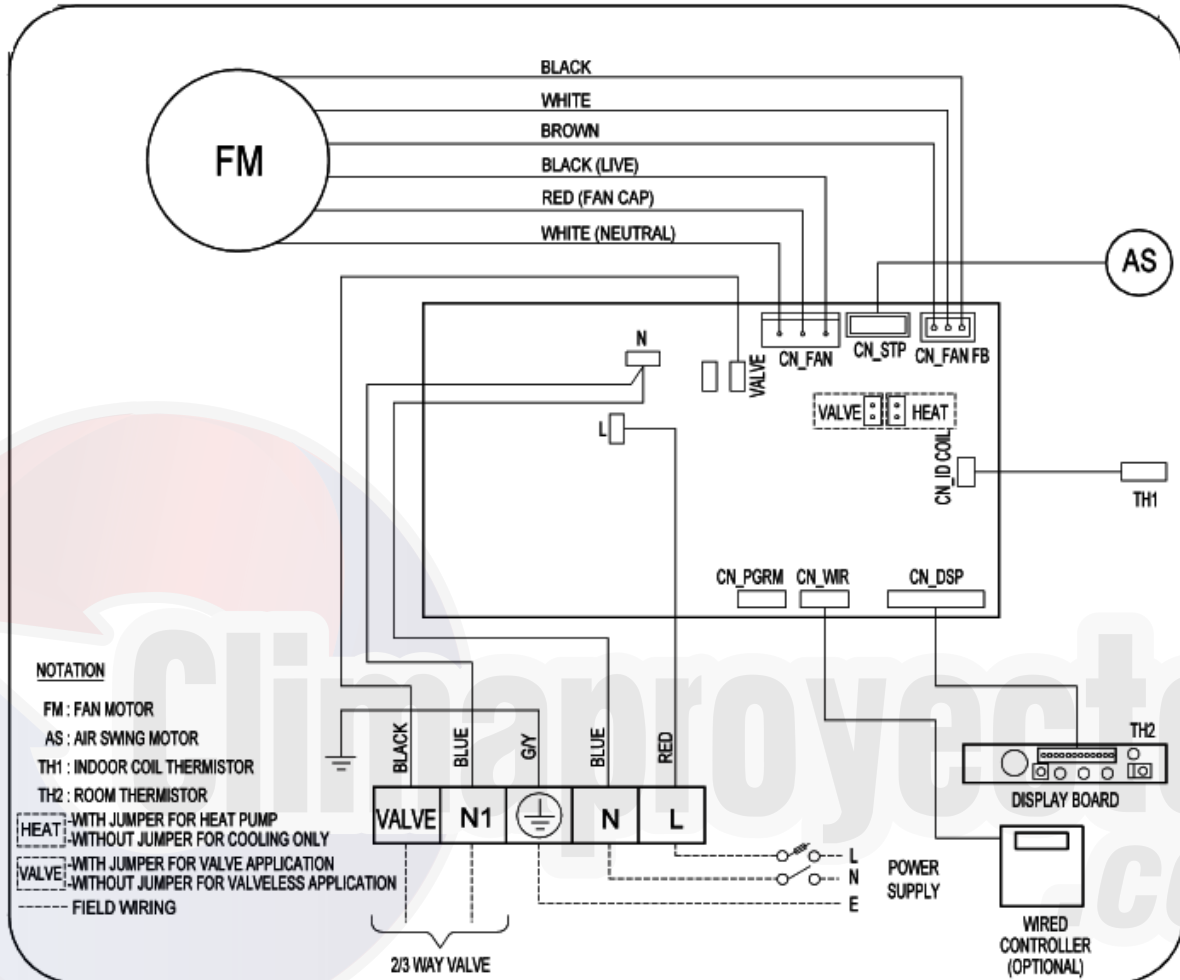

# Wiring Diagram

Model: MWM07/ 10/ 15/ 20/ 25LW



## LED Indicator Lights

### Normal Operation and Fault Conditions

 SLEEP (RED)	 COOL/HEAT (GREEN/RED)	 TIMER (Yellow)	Error Code	Normal Operation/ Faulty Indication
○/●	○ Green		-	Cool mode
○/●	○ Red		-	Heat mode
○/●	○ Green		-	Auto mode in cooling operation
○/●	○ Red		-	Auto mode in heating operation
	○	○	-	Timer ON
○	○		-	Sleep mode ON
	○		-	Fan mode ON
	○		-	Dry mode ON
	● 1 Time		E1	Room air sensor loose / short
● Continuously	● 2 Times		E2	Indoor water coil sensor loose / short
		● 3 Times	E4	Pipe water temperature poor (For valveless cooling cycle only)
		● 1 Time	E5	Pipe water temperature fault
		● 6 Times	E8	Hardware error (tact switch short)
● Continuously	● 4 Times		E9	No feedback from indoor fan motor



Product manufactured in an ISO certified facility.  
This document contains the most current information as of this orienting.  
For the most up to date product information, please go to [www.mcquayup.com](http://www.mcquayup.com)