

UAL-A Series Air Cooled Modular Chiller

Model: UAL160A5/UAL210A5

Refrigerant: R410A

Cooling Capacity: 56/72kW



Contents

Model Series 2

Nomenclature..... 2

Features..... 2

Specifications 4

Dimensions 7

Performance Data..... 8

Water Pressure Drop Curve..... 11

Sound Data..... 12

Wiring Diagrams 13

Installation..... 21

Water System Installation..... 24

Commissioning and Operation 30

Maintenance..... 31

Control System Instruction 34

Wired Controller Instruction..... 37

Error Code..... 41

Note: Installation and maintenance are to be performed only by qualified personnel who are familiar with local codes and regulations, and experienced with this type of equipment.

Caution: Sharp edges and coil surfaces are a potential injury hazard. Avoid contact with them.

Warning: Moving machinery and electrical power hazard may cause severe personal injury or death. Disconnect and lock off power before servicing equipment.

Model Series

Model	Cooling Capacity	Max Combination Qty
UAL160A5	56 kW	10
UAL210A5	72 kW	10

Nomenclature

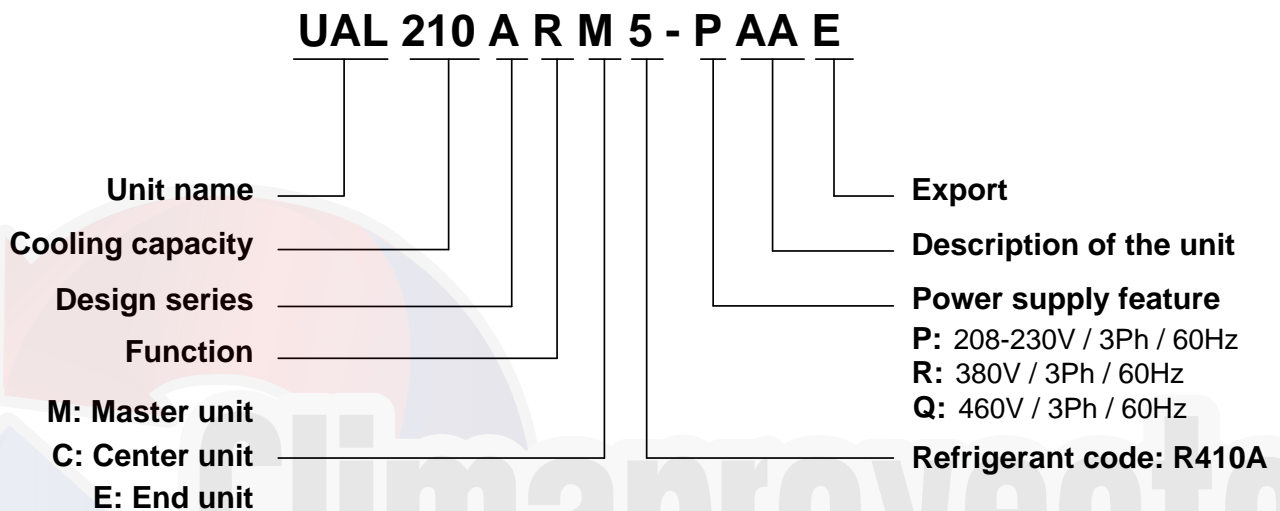

Features

Environment-friendly Refrigerant

Daikin is committed to protecting the global ecosystem and has developed air-cooled chiller with R410A, a new type of environment-friendly refrigerant. Without chlorine, the environment-friendly R410A causes no harm to the ozoneosphere (ODP=0).

Easy Installation

UAL R410A series is designed to best facilitate user installation. The refrigerant system is made hermetic in the factory. Customer do not need to connect any copper pipe or refill refrigerant or invest more money for complex water systems.

Outstanding Performance

UAL R410A series features leading-edge scroll technology and name-brand accessories which are strictly tested for high compatibility and reliability. Equipped with efficient scroll compressors and precise electronic expansion valves, these units feature high EER, especially at partial load.

Flexible module combination

1~10 sets with different capacity can be combined at will to satisfy the load selection requirements of various applications. The modular design of the unit allows the owner not to have to invest in the equipment at one time, the owner can increase the investment at any time with the development. The number of modular and the corresponding equipment greatly save the initial investment.

Compact Size

Moreover, UAL R410A series features compact size. UAL R410A can be lifted without large lifting tools and located on the roof, balcony or any possible outdoor space.

Reliable Operation

UAL R410A series adopts modular design and one by one start, reducing the impact upon the grid when starting. All units have undergone strict and long-term test, ensuring reliable operation even under extreme cold conditions. Units themselves, moreover, have multiple protections. Then security of units is maximally guaranteed.

Low Sound Level

Thanks to the newly designed spiral blades, the outdoor units feature smooth air flow significantly reducing the turbulence and lowering the air flow sound level. Unique compressor sound-insulation design and fully hermetic volute compressor minimizes the operation noise.

Intelligent Control System

UAL R410A features user-friendly intelligent control system. Micro chip and large-scaled LCD display are employed to make the control swift and easy.

- Group control (Optional): One single controller can control a group made up by one master unit and maximum 9 slave units.
- BMS (Optional): UAL R410A provides interfaces for BMS. One serial port can support maximum 32 gateway and one gateway can support one master unit and maximum 8 center units and one end unit.

Basic operating mode

- Cooling

Parameter setting

- Real time setting
- Weekly timing on/off (one on/off per day)
- Cooling water inlet temperature

Parameter display

- Running status display
- Setted inlet water temperature
- Actual inlet water temperature
- Timing point

Fault alarm and protection

- More than 13 protection and fault alarm functions
- Indoor controller lock

Memory function

- Backup battery for realtime clock
- Customized parameters preservation after power failure

Other functions

- Error log inquiry
- Average compressor worn time
- Remote on/off
- Water system two-way valve control

NOTE:

- THE LENGTH OF COMMUNICATION WIRE BETWEEN THE MASTER UNIT AND THE WIRED CONTROLLER IS 40M. THE LENGTH OF COMMUNICATION WIRE ATTACHED TO THE SLAVE UNIT IS 5M.
- THE MAIN BOARD OF THE UNIT PROVIDES AN INTERFACE FOR REMOTE CONTROL. BUT REMOTE CONTROLLERS ARE NOT PROVIDED AND SHOULD BE INSTALLED ON SITE.

Specifications

General Data

Model			UAL160A5	UAL210A5
Nominal cooling capacity	208V~230V/3Ph/60Hz	kW/ Btu/h	59/ 201365	72/ 245734
	460V/3Ph/60Hz		59/ 201365	72/ 245734
	380V/3Ph/60Hz		56/ 191127	72/ 245734
Rate cooling input power	208V~230V/3Ph/60Hz	kW	20.2	25
	460V/3Ph/60Hz		20.2	25
	380V/3Ph/60Hz		19.4	25
EER	208V~230V/3Ph/60Hz	Btu/h/W	12.2	9.83
	460V/3Ph/60Hz		12.2	9.83
	380V/3Ph/60Hz		9.8	9.83
Rated running current	208V~230V/3Ph/60Hz	A	64.1	81.5
	460V/3Ph/60Hz		32.7	40
	380V/3Ph/60Hz		39	50
Power supply			208V~230V/380V/460V/3Ph/60Hz	
Refrigerant	Type		R410A	
	Charge	kg	6.5 ×2	8.5 ×2
Water flow	208V~230V/3Ph/60Hz	m ³ /h	9.13	11.1
	460V/3Ph/60Hz		9.13	11.1
	380V/3Ph/60Hz		8.67	11.1
WPD (Water Pressure Drop)	208V~230V/3Ph/60Hz	kPa	142	73
	460V/3Ph/60Hz		142	73
	380V/3Ph/60Hz		128	73
Unit dimensions (L x W x H)	208V~230V/3Ph/60Hz	mm/in.	1820×1059×1853/72×42×73	2056×1140×2193/80.9×44.9×86.3
	460V/3Ph/60Hz		1820×1059×1853/72×42×73	2056×1140×2193/80.9×44.9×86.3
	380V/3Ph/60Hz		1820×1059×2012/72×42×79	2056×1140×2193/80.9×44.9×86.3
Packing dimensions (L x W x H)	208V~230V/3Ph/60Hz	mm/in.	1820×1059×1853/72×42×73	2056×1140×2193/80.9×44.9×86.3
	460V/3Ph/60Hz		1820×1059×1853/72×42×73	2056×1140×2193/80.9×44.9×86.3
	380V/3Ph/60Hz		1820×1059×2012/72×42×79	2056×1140×2193/80.9×44.9×86.3
Net weight	208V~230V/3Ph/60Hz	kg/lb	615/1355	730/1609
	460V/3Ph/60Hz		615/1355	730/1609
	380V/3Ph/60Hz		640/1410	730/1609
Operating weight	208V~230V/3Ph/60Hz	kg/lb	630/1388	745/1642
	460V/3Ph/60Hz		630/1388	745/1642
	380V/3Ph/60Hz		655/1443	745/1642
Gross weight	208V~230V/3Ph/60Hz	kg/lb	616/1357	731/1611
	460V/3Ph/60Hz		616/1357	731/1611
	380V/3Ph/60Hz		641/1412	731/1611

NOTES:

ALL SPECIFICATIONS ARE SUBJECTED TO CHANGE BY THE MANUFACTURER WITHOUT PRIOR NOTICE.

NOMINAL COOLING CAPACITY IS BASED ON LEAVING WATER TEMPERATURE 6.7°C, AMBIENT TEMPERATURE 35°C AND 0.043 L/S PER KW WATER FLOW.

Components Data

MODEL			UAL160A5	UAL210A5	
Evaporator	Type		Brazed Plate Heat Exchanger	Brazed Plate Heat Exchanger	
	Plate material		Stainless steel	Stainless steel	
	Nominal water flow	208V~230V/3Ph/60Hz	m ³ /h	9.13	11.1
		460V/3Ph/60Hz		9.13	11.1
		380V/3Ph/60Hz		8.67	11.1
	Water volume	L	4	4	
	Piping connecting	Inch	3	5	
Unit water pressure drop	kPa/ psi	29/4.21	46/6.67		
Condenser coil tube	Material		Copper	Copper	
	Type		Inner groove	Inner groove	
	Outer diameter	mm	7.94	9.52	
Fin	Material		Aluminum	Aluminum	
	Type		White	White	
	Rows		3	3	
	Fin per inch		16	16	
Face area	m ² /ft ²	3.5/37.7	2.77/29.8		
Condenser fan	Type/ Drive		Axial big vane and low noise blower	Axial big vane and low noise blower	
	Qty		2	2	
	Blade material		Galvanized steel	Galvanized steel	
	Motor poles		6	8	
	Air volume	m ³ /ft ³	24000/13900	26000/15058	
Compressor	Type		Scroll compressor	Scroll compressor	
	Qty		2	2	
Refrigerant	Type		R410A	R410A	
	Charge	kg	6.5 ×2	8.5 ×2	
Flow control			EXV	EXV	
Numbers of circuits			2	2	
Oil	Model		POE	POE	
	Charge		3.3 ×2	3.3 ×2	
Casing	Colour		RAL 7032 Pebble Grey	RAL 7032 Pebble Grey	
	Material		Electro-galvanized Mild Steel	Electro-galvanized Mild Steel	
Protection devices			H/L pressure switch /Thermal and current overload prtector	H/L pressure switch /Thermal and current overload prtector	

NOTE: ALL SPECIFICATIONS ARE SUBJECTED TO CHANGE BY THE MANUFACTURER WITHOUT PRIOR NOTICE.

Electrical Data

Model				UAL160A5	UAL210A5
Fan motor	Rated running current	208V~230V/3Ph/60Hz	A	4.5×2	6.5×2
		460V/3Ph/60Hz		2.2×2	2.6×2
		380V/3Ph/60Hz		4×2	4×2
	Motor output		W	1000×2	1000×2
	Poles			6	8
Fan speed		208V~230V/3Ph/60Hz	RPM	910	910
		460V/3Ph/60Hz		910	840
		380V/3Ph/60Hz		690	690
Compressor	Rated running current	208V~230V/3Ph/60Hz	A	32.9	45.7
		460V/3Ph/60Hz		17.9	19.2
		380V/3Ph/60Hz		21.4	26.4
	Locked rotor AMP (LRA)	208V~230V/3Ph/60Hz	A	267	304
		460V/3Ph/60Hz		142	147
		380V/3Ph/60Hz		160	168
IP/ Insulation grade				IPX4/E	IPX4/E
Unit operating current		208V~230V/3Ph/60Hz	A	64.1	81.5
		460V/3Ph/60Hz		32.7	40
		380V/3Ph/60Hz		39	50
Unit max running current		208V~230V/3Ph/60Hz	A	79.1	103
		460V/3Ph/60Hz		38.6	50
		380V/3Ph/60Hz		49.1	65

NOTES:

1. ALL SPECIFICATIONS ARE SUBJECTED TO CHANGE BY THE MANUFACTURER WITHOUT PRIOR NOTICE.
2. MAX RUNNING CURRENT IS TESTED UNDER BELOW CONDITION: COOLING OUTDOOR DRY-BULB TEMPERATURE 43°C, HEATING DRY-BULB TEMPERATURE 21°C, WET-BULB TEMPERATURE 15.5°C.
3. THE RATED RUNNING CURRENT ARE TESTED AT THE HIGH SPEED AND LOW SPEED.

Safety Devices

Model				UAL160A5	UAL210A5
Safety device	High pressure switch	Type		PSW,H20PS B	PSW,H20PS B
		Open	MPa	4.15 ± 0.1	4.15 ± 0.1
		Close	MPa	3.11 ± 0.1	3.11 ± 0.1
	Low pressure switch	Type		N/A	N/A
		Open	MPa	N/A	N/A
		Close	MPa	N/A	N/A
	Phase sequencer			YES	YES
	Discharge temperature setting		°C/°F	130/266	130/266

NOTE:

1. ALL SPECIFICATIONS ARE SUBJECTED TO CHANGE BY THE MANUFACTURER WITHOUT PRIOR NOTICE.

Dimensions

Unit: mm

Model: UAL160A5-P/Q

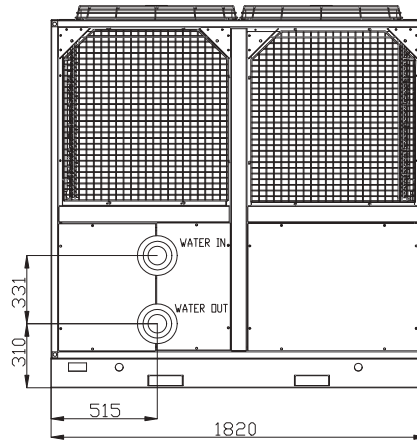
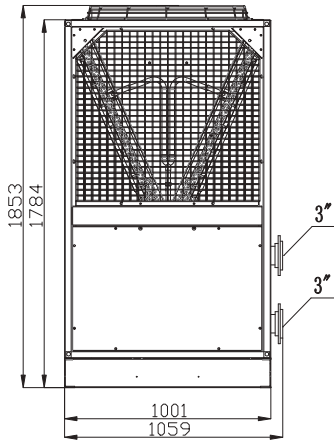

Model: UAL160A5-R

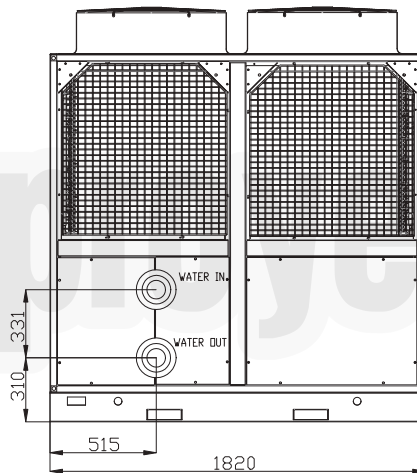
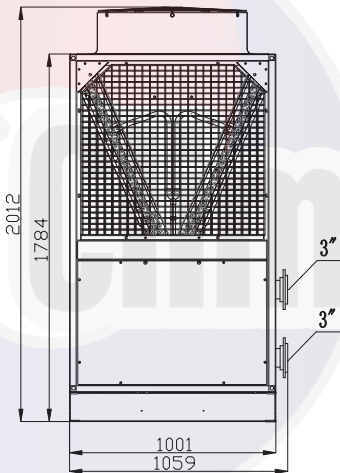

Model: UAL210A5-P/Q/R

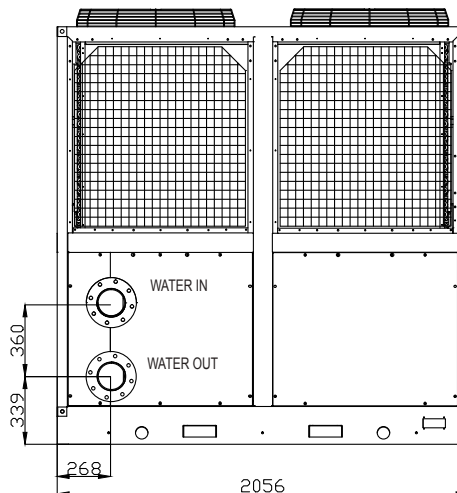
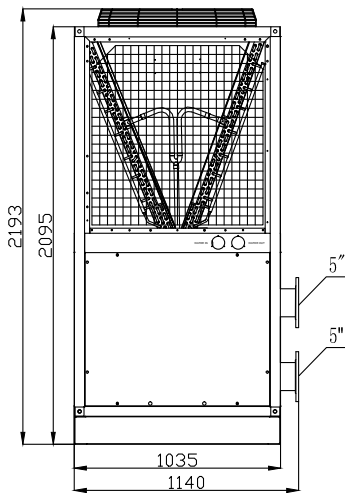

Performance Data

Operating Range

UAL160A5/210A5

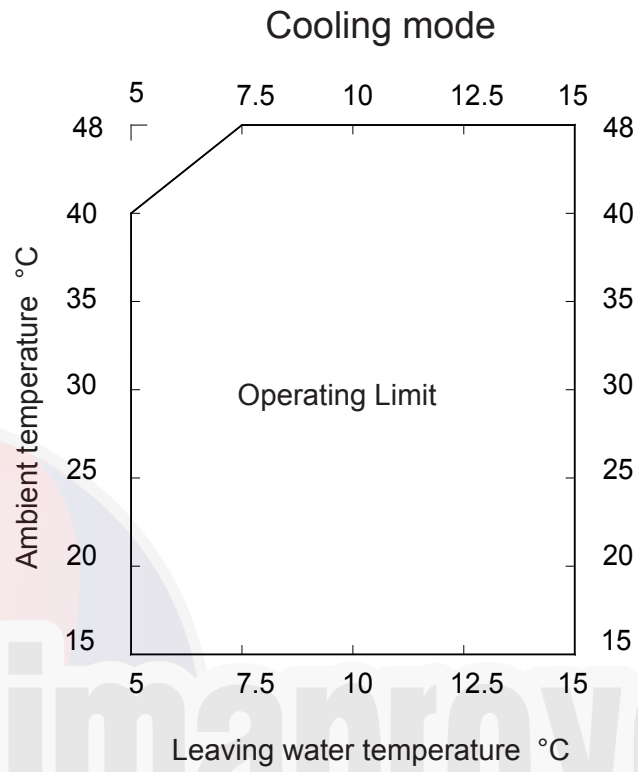

Cooling capacity performance curve

Cooling capacity (UAL160A5)

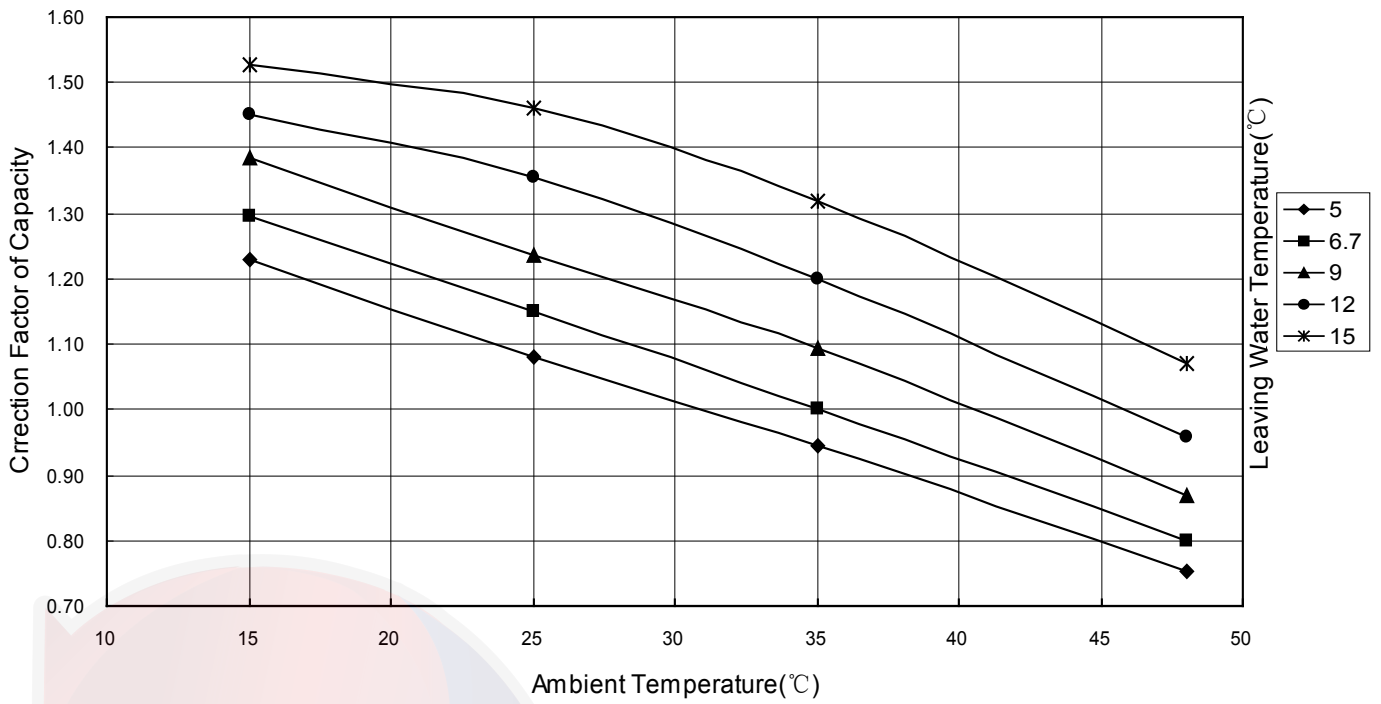

Cooling power input (UAL160A5)

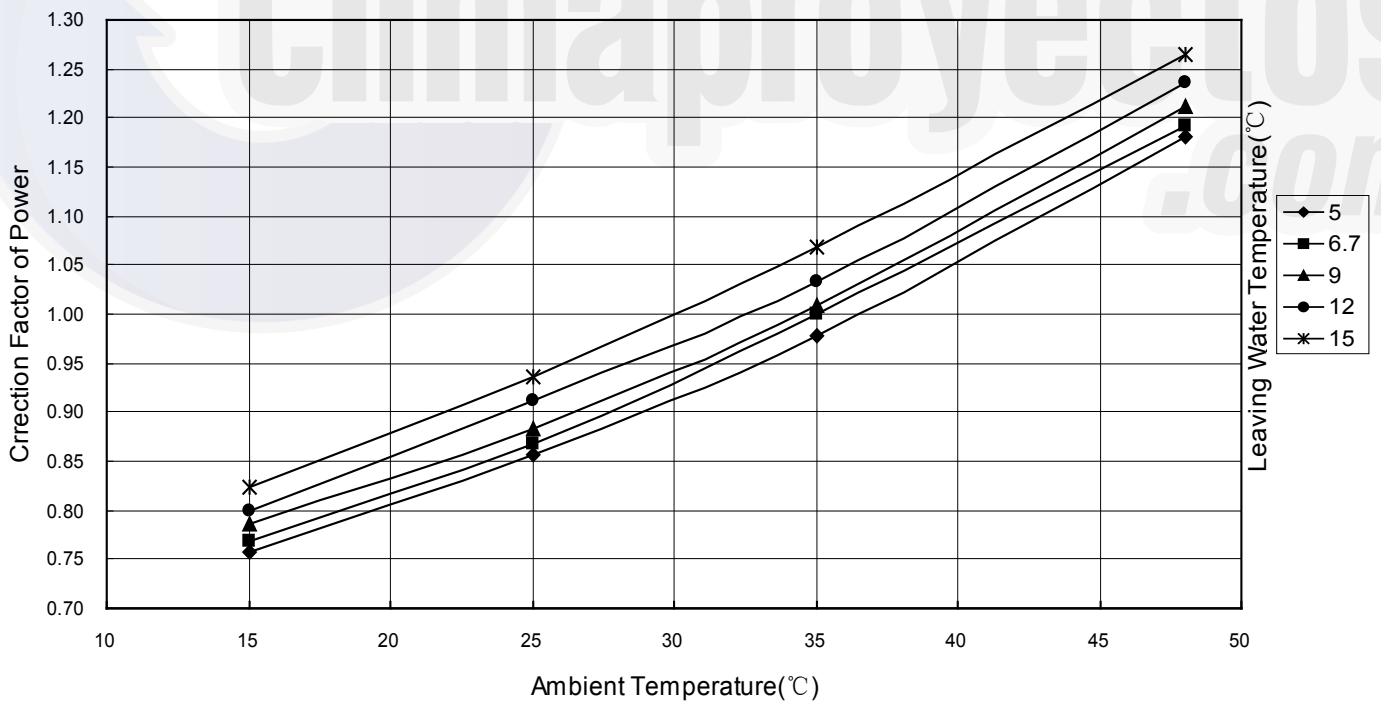

Cooling capacity (UAL210A5)

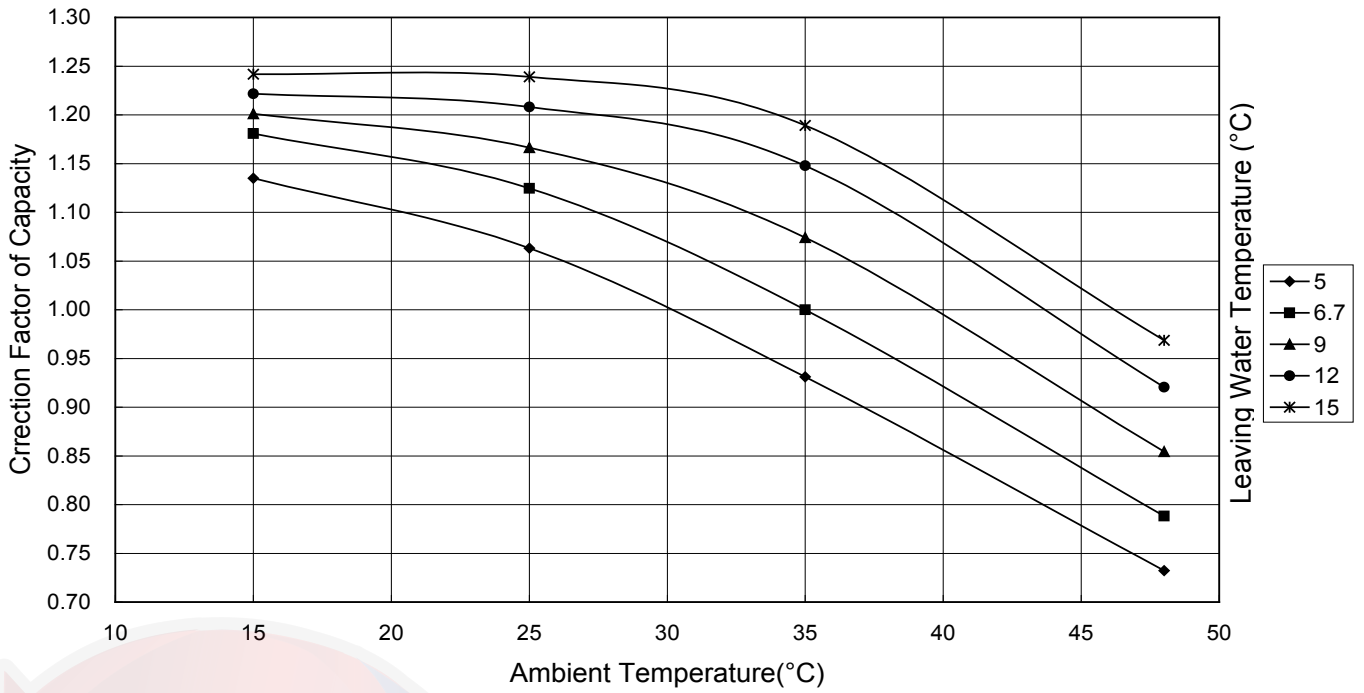

Cooling power input (UAL210A5)

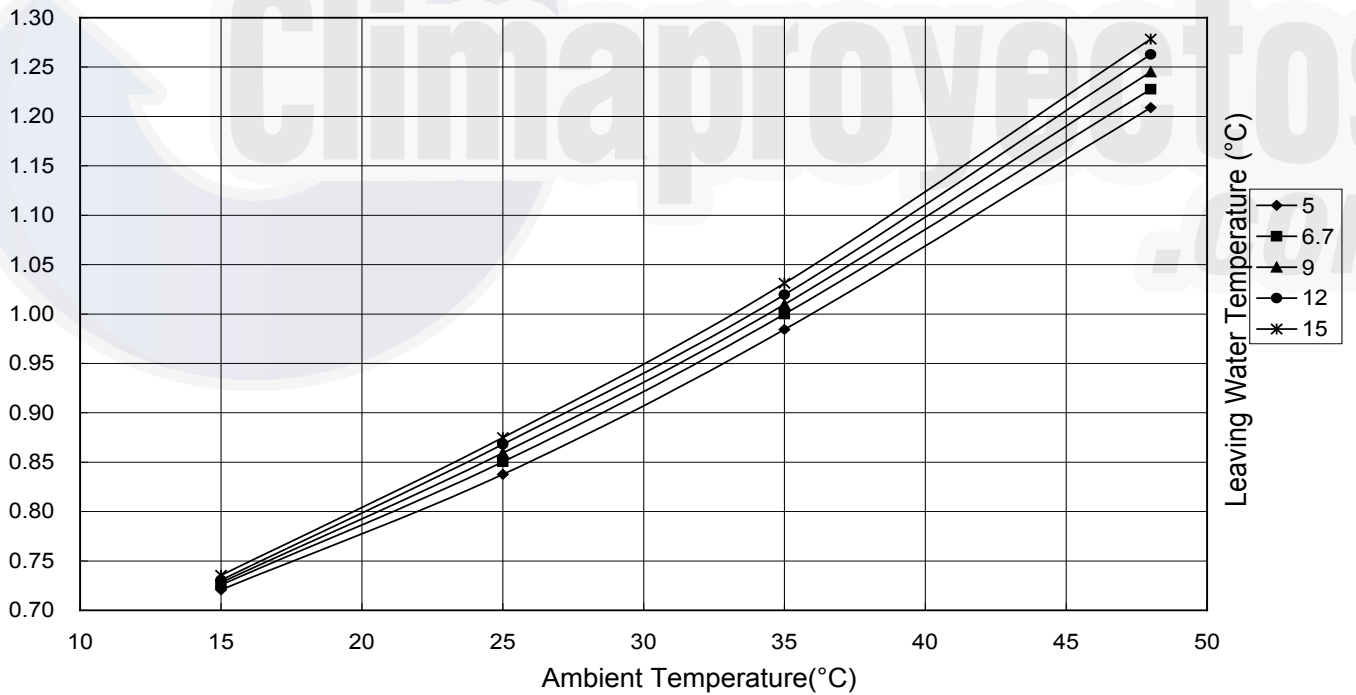

Water Pressure Drop Curve

UAL160A5

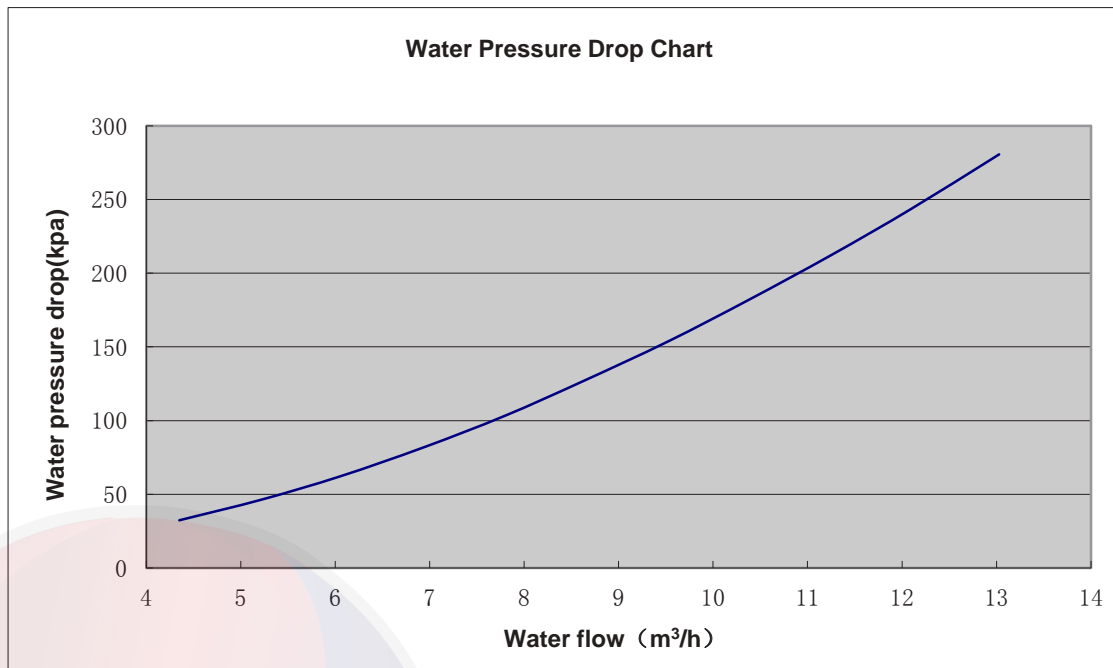

UAL210A5

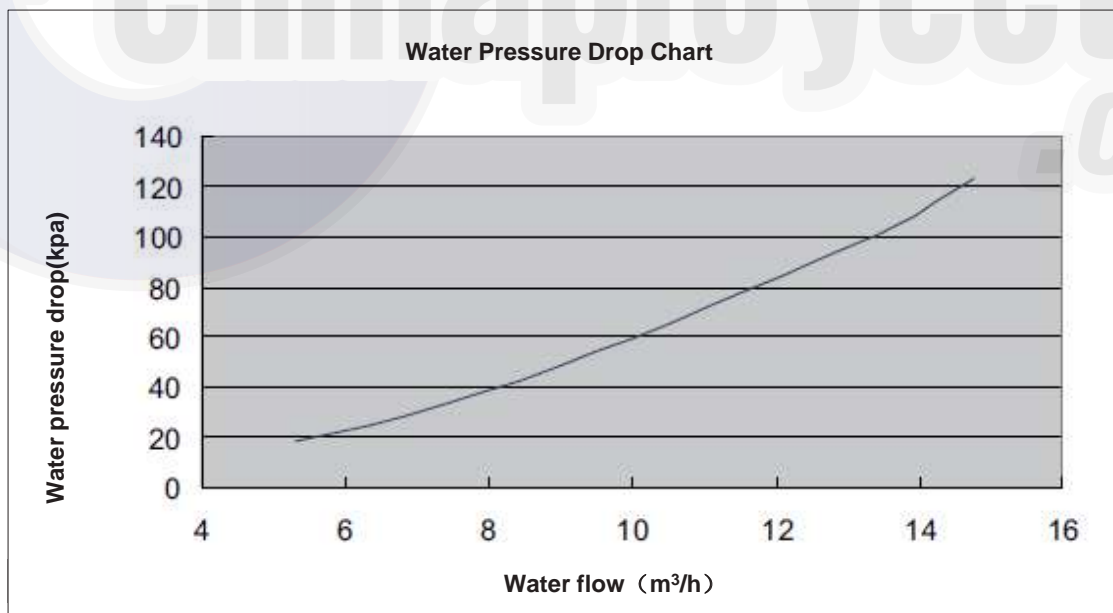

NOTES:

- 1) WATER PRESSURE DROP OF THE UNIT IS TESTED BY THE PLATE HEAT EXCHANGER AND THE SUPPLIED Y-TYPE FILTER.
- 2) WATER RESISTANCE OF PLATE HEAT EXCHANGER AND Y-TYPE FILTER IS TESTED UNDER CONDITION OF CLEAN WATER; IT MAY BE INCONSISTENT WITH THAT SHOWN IN THE DIAGRAM DUE TO THE WATER QUALITY ON SITE.

Sound Data

Acoustic Noise

Model		Octave Band Level (dB,ref20μPa)								dB(A)
		63Hz	125Hz	250Hz	500Hz	1kHz	2kHz	4kHz	8kHz	Overall
UAL160A5	208V~230V/3Ph/60Hz	47.5	46.3	55.8	56.5	58.4	49.3	42.9	34.6	76.4
	460V/3Ph/60Hz	52.1	47.4	55.6	60.7	62.8	55.6	49.4	41.3	76.4
	380V/3Ph/60Hz	41.6	47.7	54.4	56.0	59.6	53.9	46.6	38.1	66.8
UAL210A5	208V~230V/3Ph/60Hz	43.26	55.21	63.27	63.24	65.18	61.53	54.61	47.55	69.9
	460V/3Ph/60Hz	35.28	51.38	60.79	64.28	64.33	61.98	56.9	49.26	69.9
	380V/3Ph/60Hz	51.2	55.2	61.6	63.4	64.7	61.2	57	50.5	69.5

TEST CONDITION: OCTAVE BAND LEVEL NOISE IS TESTED BASE ON 15DB(A) BACKGROUND NOISE SEMI-ANECHOIC ROOM.



Wiring Diagrams

208-230V/3Ph/60Hz

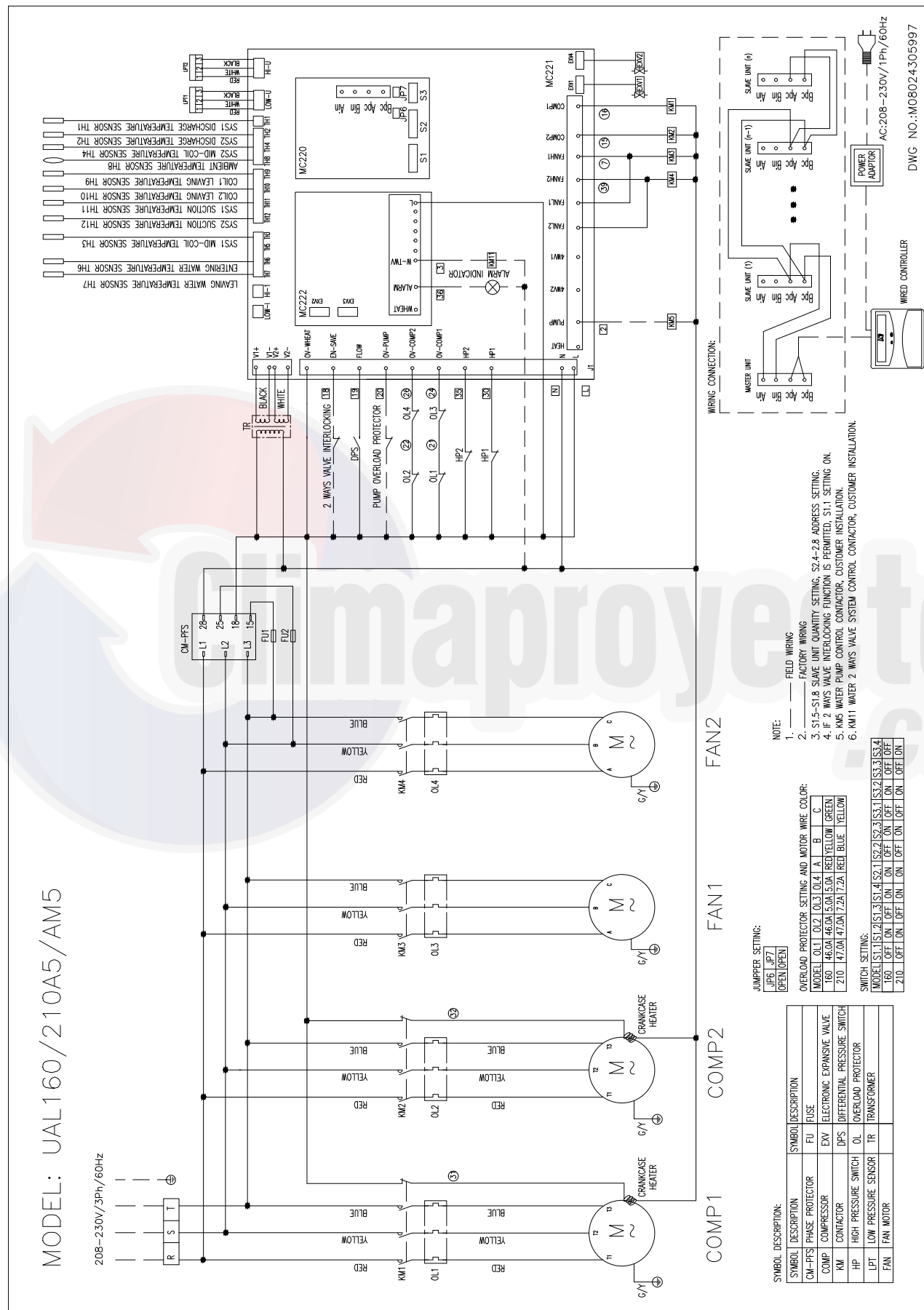

MODEL: UAL160AC5/AE5

208-230V/3Ph/60Hz

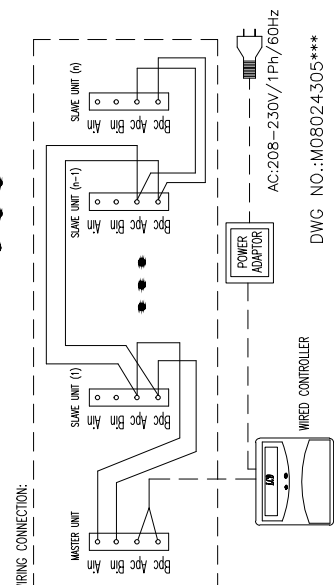
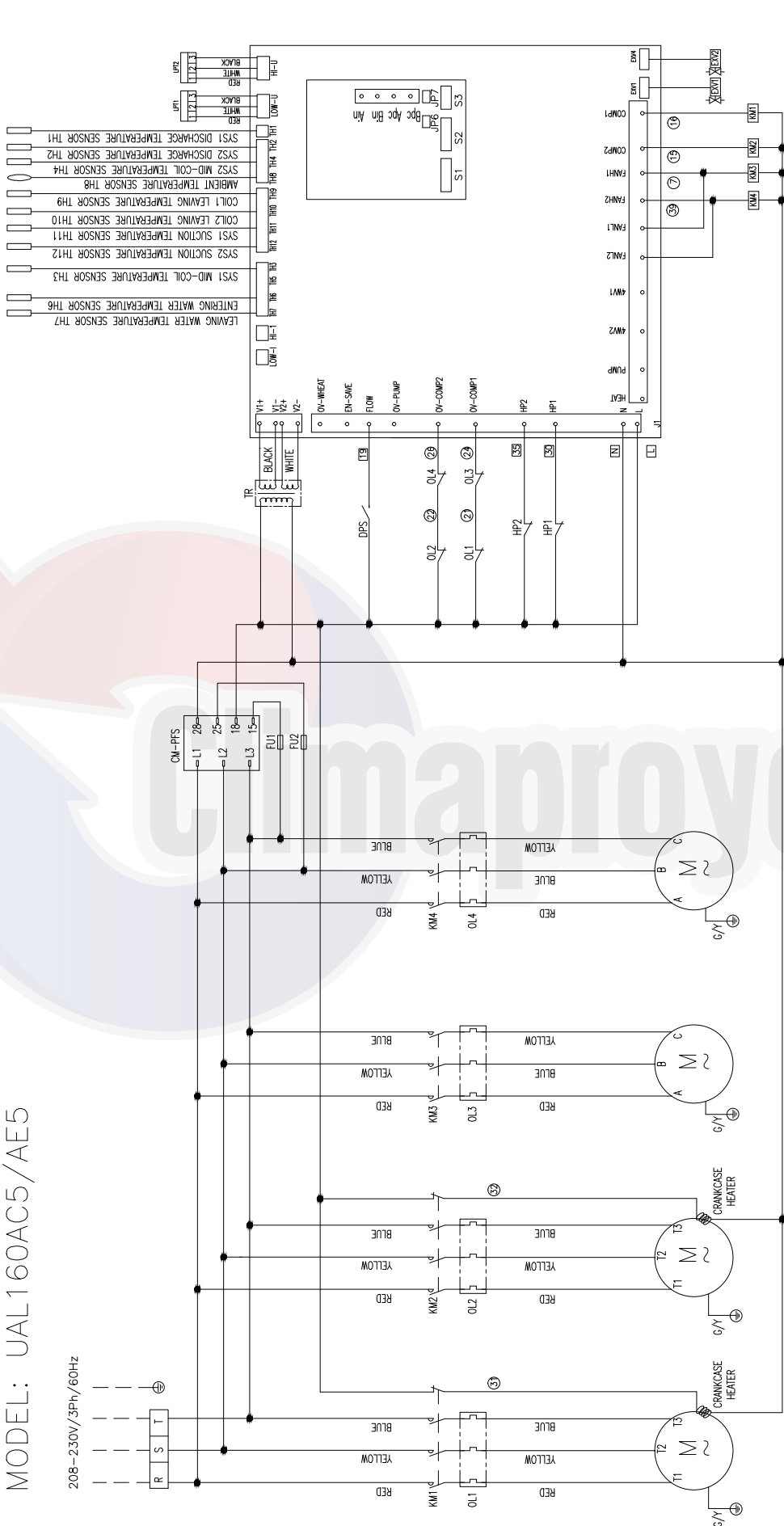

NOTE:

1. --- FIELD WIRING
2. --- FACTORY WIRING
3. S1.5-S1.8 SLAVE UNIT QUANTITY SETTING, S2.4-2.8 ADDRESS SETTING.
4. JP6,JP7 IS SET TO OPEN. IF THE LAST SLAVE UNIT, CLOSED JP6.

JUMPER SETTING:

JP6 (LP7)	OPEN/OFF
-----------	----------

OVERLOAD PROTECTOR SETTING:

OL1	OL2	OL3	OL4
46.0A	46.0A	5.0A	5.0A

SWITCH SETTING:

S1.1	S1.2	S1.3	S1.4	S2.1	S2.2	S2.3	S3.1	S3.2	S3.3	S3.4
OFF	ON	OFF	ON	OFF	ON	OFF	ON	OFF	ON	OFF

SYMBOL DESCRIPTION:

SYMBOL	DESCRIPTION	SYMBOL	DESCRIPTION
CM-PFS	PHASE PROTECTOR	FU	FUSE
COMP	COMPRESSOR	EXV	ELECTRONIC EXPANSIVE VALVE
KM	CONTACTOR	DPS	DIFFERENTIAL PRESSURE SWITCH
HP	HIGH PRESSURE SWITCH	OL	OVERLOAD PROTECTOR
LPT	LOW PRESSURE SENSOR	TR	TRANSFORMER
FAN	FAN MOTOR		

DWG NO.:M08024305***

MODEL: UAL210AC5/AE5

208-230V/3Ph/60Hz

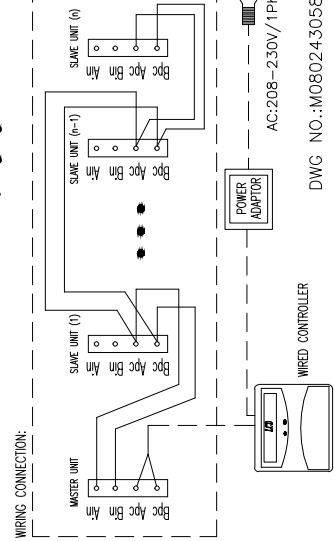
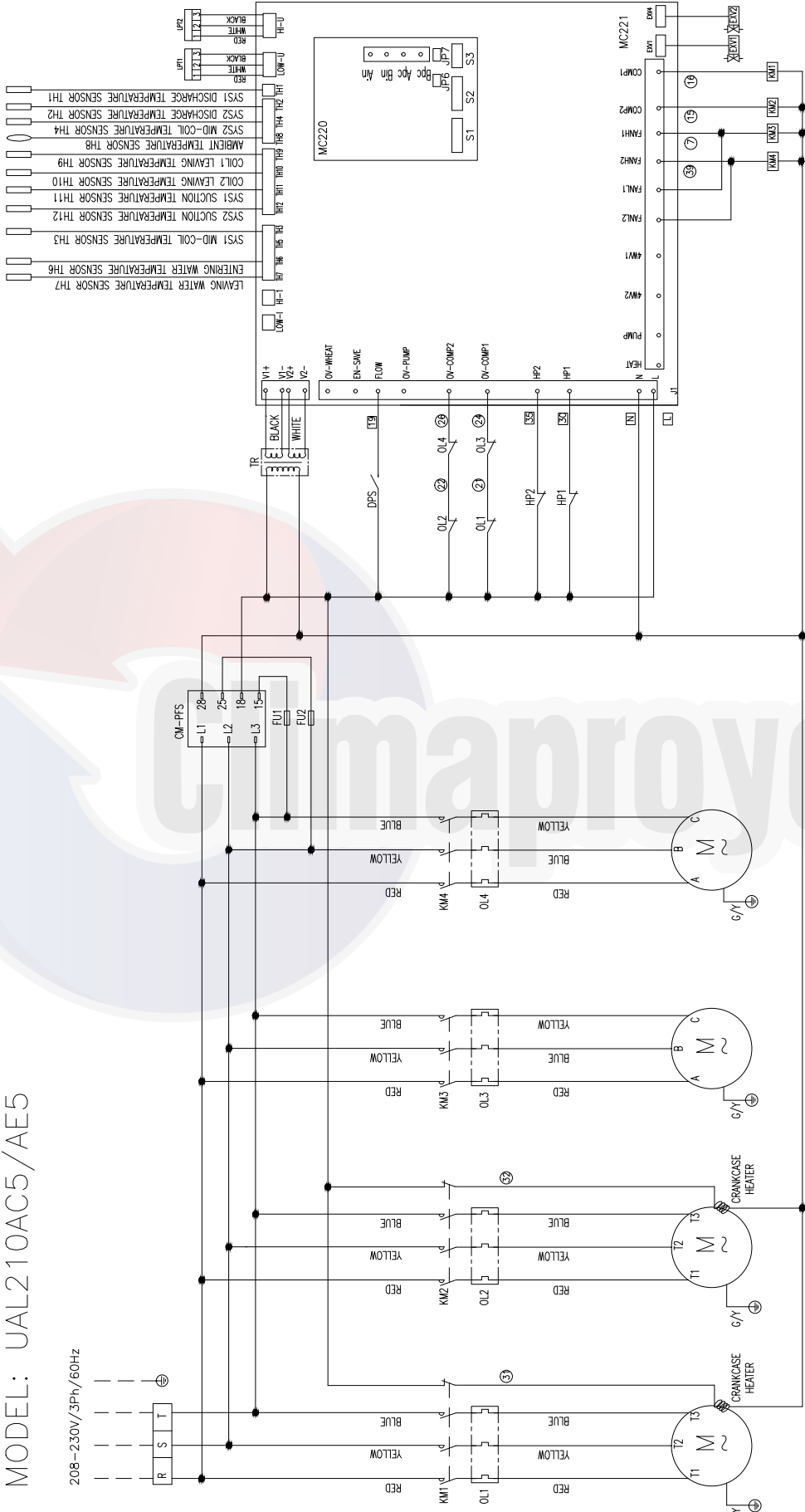

WIRING CONNECTION:

NOTE:

1. --- FIELD WIRING
2. --- FACTORY WIRING
3. S1.5-S1.8 SLAVE UNIT QUANTITY SETTING, S2.4-2.8 ADDRESS SETTING.
4. JP6,JP7 IS SET TO OPEN IF THE LAST SLAVE UNIT, CLOSED JP6.

JUMPER SETTING:

JP6	JP7
OPEN	OPEN

OVERLOAD PROTECTOR SETTING:

OL1	OL2	OL3	OL4
47.0A	47.0A	7.2A	7.2A

SWITCH SETTING:

S1.1	S1.2	S1.3	S1.4	S2.1	S2.2	S2.3	S2.4	S3.1	S3.2	S3.3	S3.4
OFF	ON	ON	ON	OFF	OFF	ON	OFF	ON	OFF	ON	OFF

SYMBOL DESCRIPTION:

SYMBOL	DESCRIPTION	SYMBOL	DESCRIPTION
CM-PFS	PHASE PROTECTOR	FU	FUSE
COMP	COMPRESSOR	EV	ELECTRONIC EXPANSIVE VALVE
KM	CONTACTOR	DPS	DIFFERENTIAL PRESSURE SWITCH
HP	HIGH PRESSURE SWITCH	OL	OVERLOAD PROTECTOR
LPT	LOW PRESSURE SENSOR	TR	TRANSFORMER
FAN	FAN MOTOR		

DWG NO.: M08024305873

MODEL: UAL160/210A5/AM5

460V/3Ph/60Hz

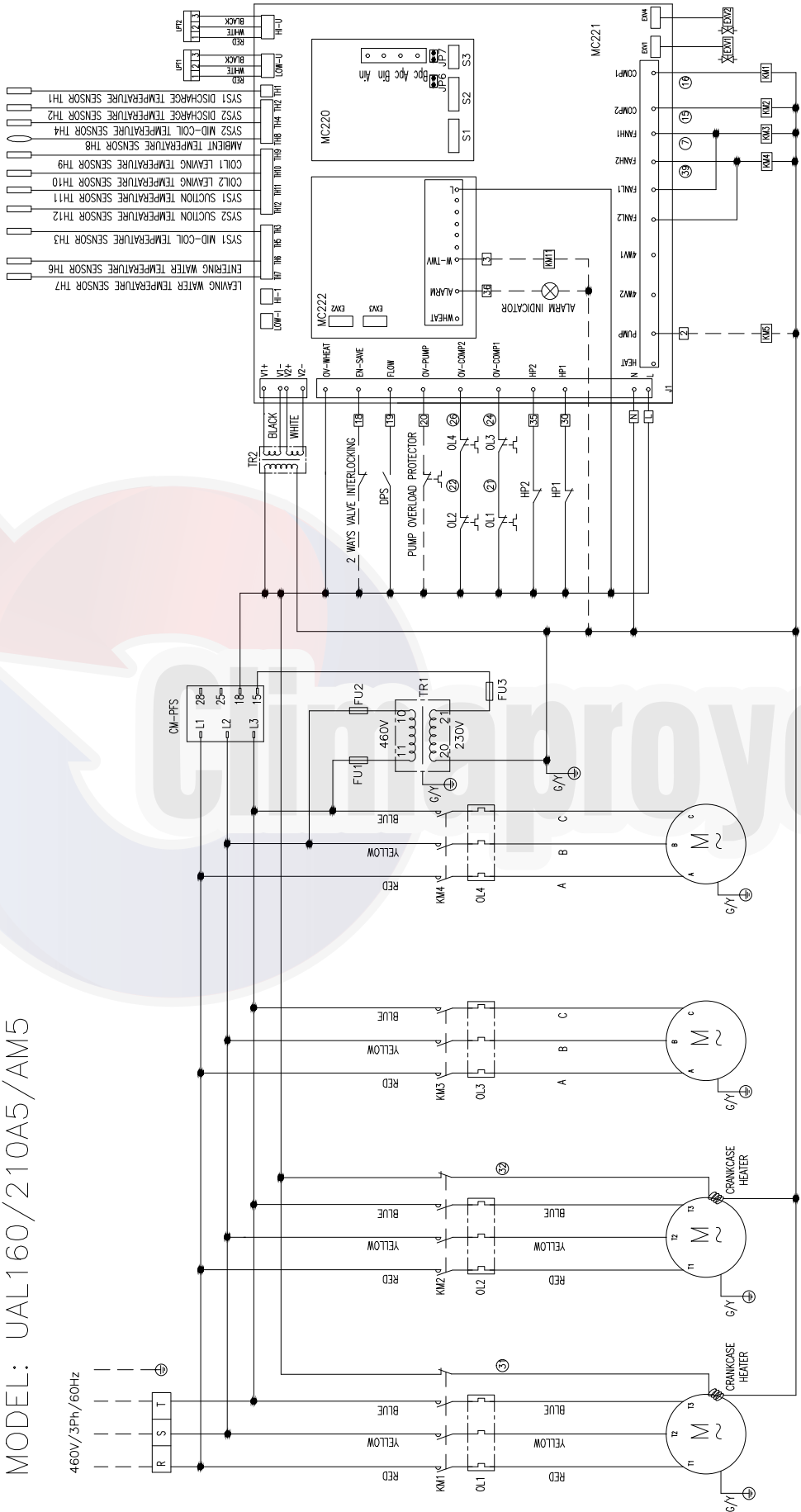
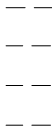

- LEAVING WATER TEMPERATURE SENSOR TH7
- ENTERING WATER TEMPERATURE SENSOR TH6
- SYS1 MID-COIL TEMPERATURE SENSOR TH3
- SYS2 SUCTION TEMPERATURE SENSOR TH12
- SYS2 SUCTION TEMPERATURE SENSOR TH11
- COL1 LEAVING TEMPERATURE SENSOR TH10
- COL2 LEAVING TEMPERATURE SENSOR TH9
- AMBIENT TEMPERATURE SENSOR TH8
- SYS2 DISCHARGE TEMPERATURE SENSOR TH4
- SYS2 DISCHARGE TEMPERATURE SENSOR TH2
- SYS1 DISCHARGE TEMPERATURE SENSOR TH1

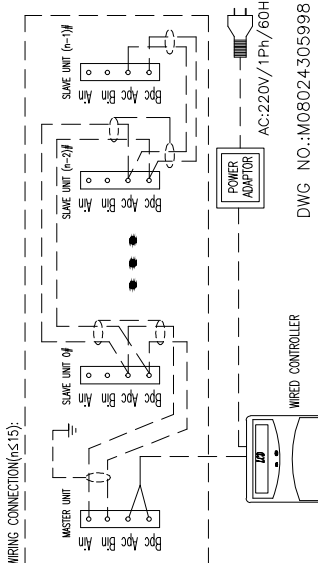

WIRING CONNECTION (x15):

NOTE:

- FIELD WIRING
- FACTORY WIRING
- S1.5-S1.8 SLAVE UNIT QUANTITY SETTING, S2.4-2.8 ADDRESS SETTING.
- IF 2 WAYS VALVE INTERLOCKING FUNCTION IS PERMITTED, S1.1 SETTING ON.
- M5 WATER PUMP CONTROL CONTACTOR, CUSTOMER INSTALLATION.
- AM11 WATER 2 WAYS VALVE SYSTEM CONTROL CONTACTOR, CUSTOMER INSTALLATION.

JUMPER SETTING:

JPC	AP7
OPEN	OPEN

OVERLOAD PROTECTOR SETTING AND MOTOR WIRE COLOR:

MODEL	OL1	OL2	OL3	OL4	A	B	C
160	25A	25A	25A	2.5A	RED	YELLOW	GREEN
210	27A	27A	2.5A	2.5A	RED	WHITE	BLUE

SWITCH SETTING:

MODEL	S1.1	S1.2	S1.3	S1.4	S2.1	S2.2	S2.3	S3.1	S3.2	S3.3	S3.4
160	OFF	ON	OFF	ON	ON	OFF	ON	OFF	ON	OFF	ON
210	OFF	ON	OFF	ON	ON	OFF	ON	OFF	ON	OFF	ON

SYMBOL DESCRIPTION:

SYMBOL	DESCRIPTION	SYMBOL	DESCRIPTION
CM-PFS	PHASE PROTECTOR	FU	FUSE
COMP	COMPRESSOR	EXV	ELECTRONIC EXPANSIVE VALVE
KM	CONTACTOR	DPS	DIFFERENTIAL PRESSURE SWITCH
HP	HIGH PRESSURE SWITCH	OL	OVERLOAD PROTECTOR
LPT	LOW PRESSURE SENSOR	TR	TRANSFORMER
FAN	FAN MOTOR		

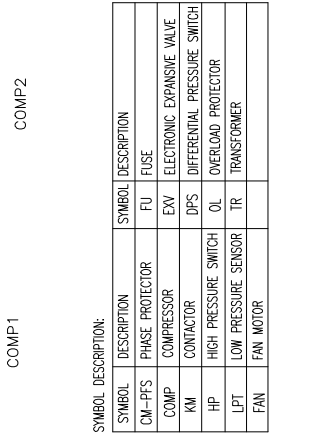

DWG NO.:M08024-305998

WIRING CONTROLLER

POWER AMPLIFIER

AC-220V/1Ph/60Hz

MODEL: UAL160/210AC5/AE5

460V/3Ph/60Hz

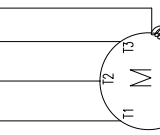
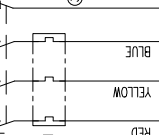
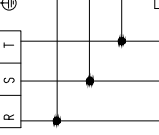
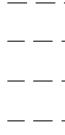

WIRING CONNECTION (x515):

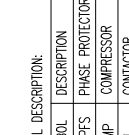

POWER ADAPTOR

AC:220V/1Ph/60Hz

WIRING CONTROLLER

DWG NO.:MG8024305874

SYMBOL	DESCRIPTION	SYMBOL	DESCRIPTION
CM-PFS	PHASE PROTECTOR	FU	FUSE
COMP	COMPRESSOR	EXV	ELECTRONIC EXPANSIVE VALVE
KM	CONTACTOR	DPS	DIFFERENTIAL PRESSURE SWITCH
HP	HIGH PRESSURE SWITCH	OL	OVERLOAD PROTECTOR
LPT	LOW PRESSURE SENSOR	TR	TRANSFORMER
FAN	FAN MOTOR		

JUMPER SETTING:

JPB	JP7	OPEN	OPEN
MODEL 01.1	01.2	01.3	01.4
A	B	C	
1.60	2.5A	2.5A	2.5A
RED	YELLOW	GREEN	BLUE
2.10	2.7A	2.7A	2.5A
RED	WHITE	BLUE	

SWITCH SETTING:

MODEL(S)	1	1S1	2	1S1.1	2S2	1S2.1	2S2.1	1S3.1	1S3.2	1S3.3	1S3.4
1.60	OFF	ON	OFF	ON	OFF	ON	OFF	ON	OFF	ON	OFF
2.10	LOFF	LOFF	LOFF	LOFF	LOFF	LOFF	LOFF	LOFF	LOFF	LOFF	LOFF

NOTE:

1. --- FIELD WIRING
2. --- FACTORY WIRING
3. S1.5-S1.8 SLAVE UNIT QUANTITY SETTING, S2.4-S2.8 ADDRESS SETTING.
4. JPB,JP7 IS SET TO OPEN IF THE LAST SLAVE UNIT, CLOSED JP6.

MODEL: UAL160/210A5/AM5

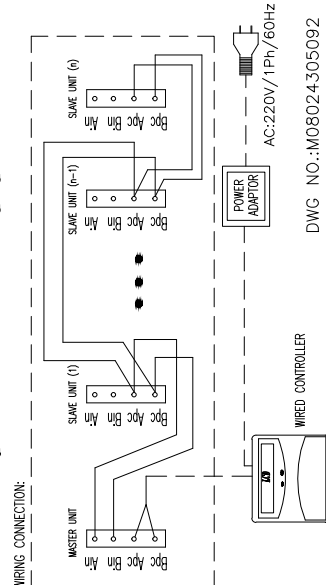
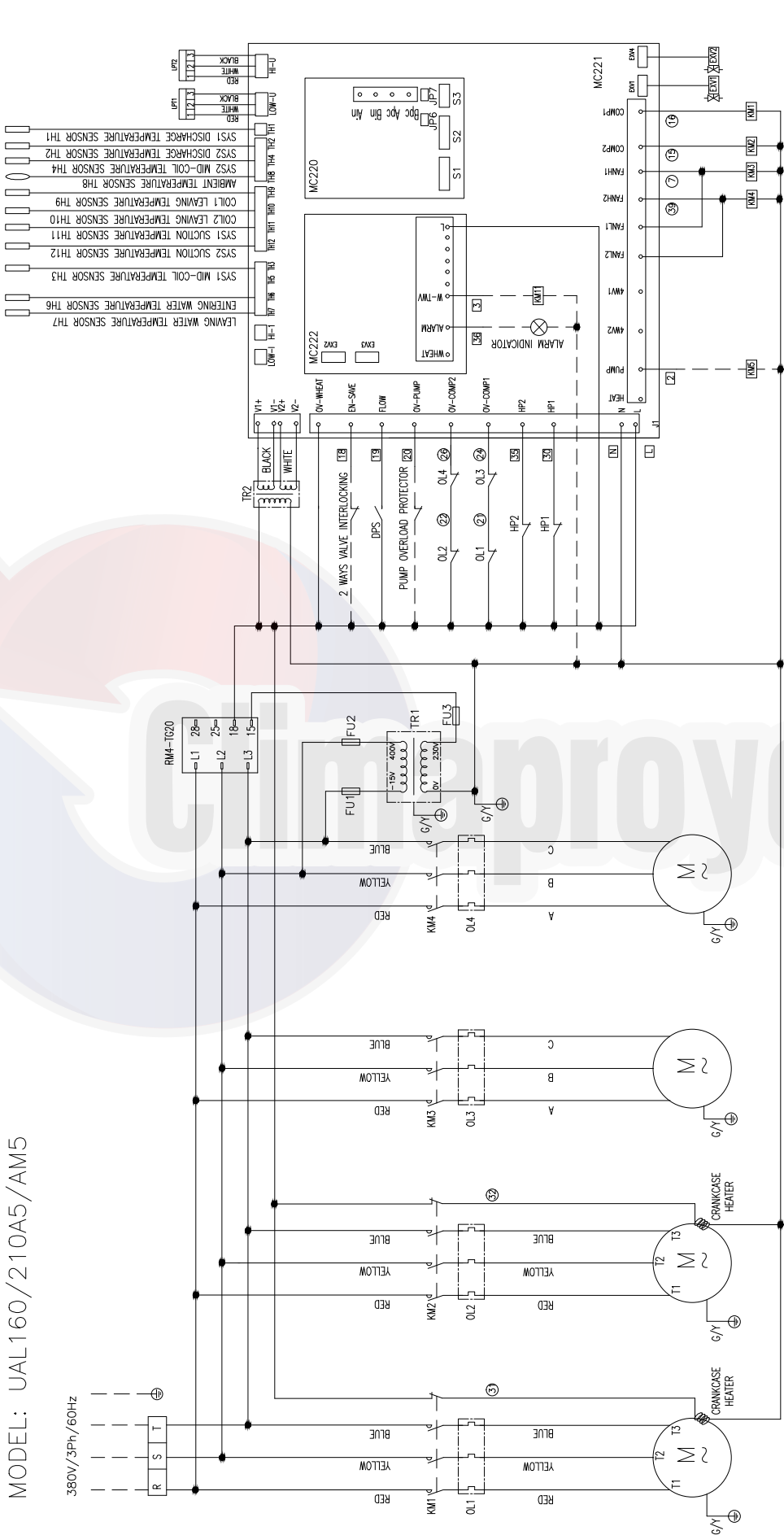

WIRING CONNECTION:

- NOTE:
1. --- FIELD WIRING
 2. --- FACTORY WIRING
 3. S1.5-S1.8 SLAVE UNIT QUANTITY SETTING; S2.4-S2.8 ADDRESS SETTING.
 4. IF 2 WAYS VALVE INTERLOCKING FUNCTION IS PERMITTED, S1.1 SETTING ON.
 5. KM5 WATER PUMP CONTROL CONTACTOR, CUSTOMER INSTALLATION.
 6. KM11 WATER 2 WAYS VALVE SYSTEM CONTROL CONTACTOR, CUSTOMER INSTALLATION.

JUMPER SETTING:

J1P6	J1P7
OPEN	OPEN
MODEL	MODEL
160	160
210	210

OVERLOAD PROTECTOR SETTING AND MOTOR WIRE COLOR:

MODEL	OL1	OL2	OL3	OL4	A	B	C
160	32.0A	32.0A	2.4A	2.4A	RED	YELLOW	BLUE
210	137.0A	137.0A	4.6A	4.6A	RED	BLUE	YELLOW

SWITCH SETTING:

MODEL	S1.1	S1.2	S1.3	S1.4	S2.1	S2.2	S2.3	S2.4	S3.1	S3.2	S3.3	S3.4
160	OFF	OFF	ON	OFF	ON	OFF	ON	OFF	ON	OFF	ON	OFF
210	OFF	ON	OFF	ON	ON	OFF	ON	OFF	ON	OFF	ON	OFF

SYMBOL DESCRIPTION:

SYMBOL	DESCRIPTION	SYMBOL	DESCRIPTION
RMA-TC20	PHASE PROTECTOR	FU	FUSE
COMP	COMPRESSOR	EXV	ELECTRONIC EXPANSIVE VALVE
KM	CONTACTOR	DPS	DIFFERENTIAL PRESSURE SWITCH
HP	HIGH PRESSURE SWITCH	OL	OVERLOAD PROTECTOR
LPT	LOW PRESSURE SENSOR	TR	TRANSFORMER
FAN	FAN MOTOR		

DWG NO.:M08024305092

MODEL: UAL160AC5/AE5

380V/3Ph/60Hz

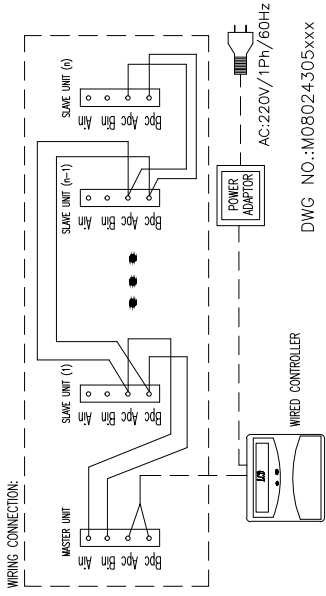
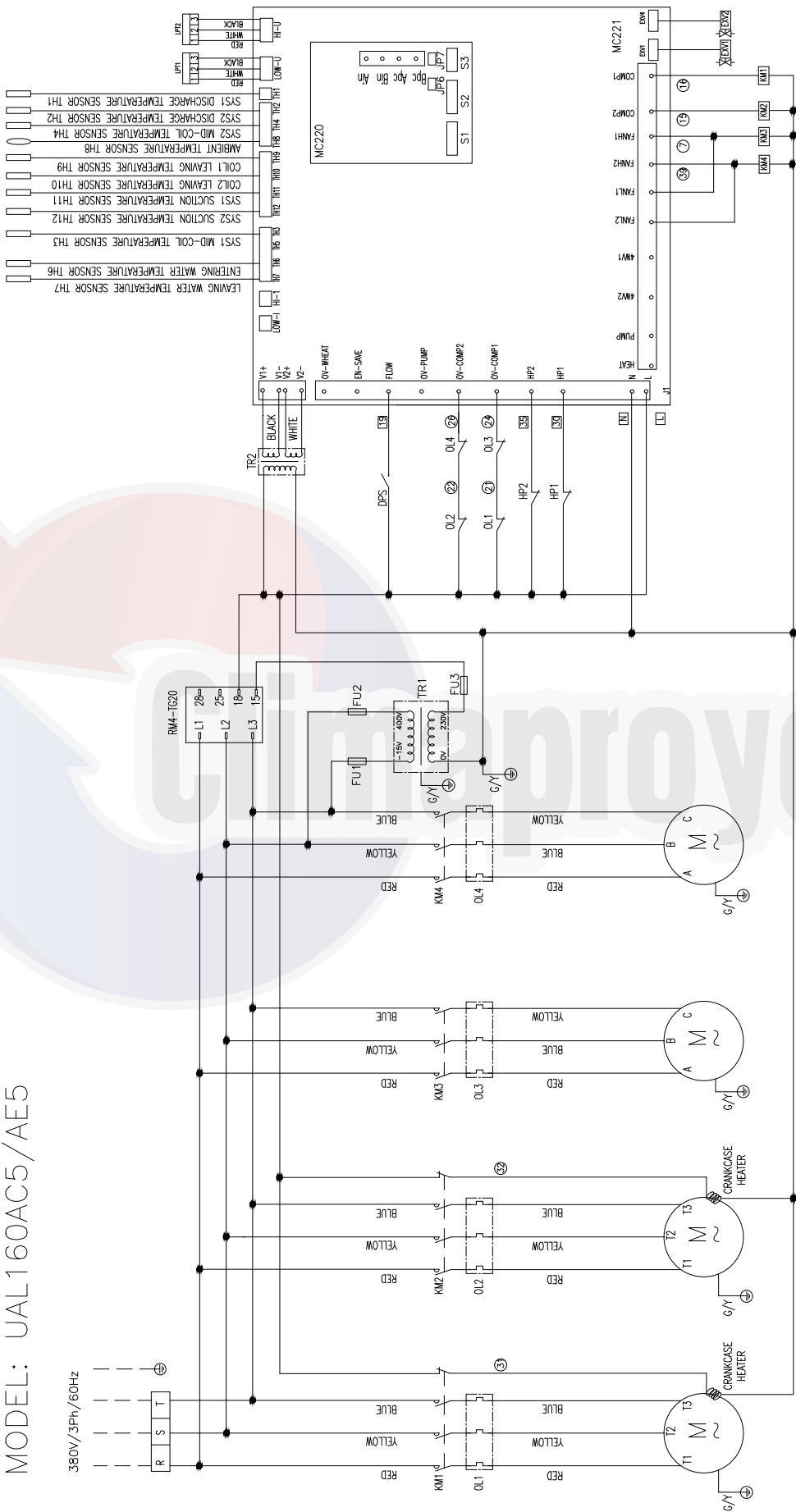

WIRING CONNECTION:

MASTER UNIT

SLAVE UNIT (0)

SLAVE UNIT (n-1)

POWER ADAPTOR

AC:220V/1Ph/60Hz

WIRED CONTROLLER

FAN2

FAN1

COMP2

COMP1

SYMBOL DESCRIPTION:

SYMBOL	DESCRIPTION	SYMBOL	DESCRIPTION
RMA-TC20	PHASE PROTECTOR	FU	FUSE
COMP	COMPRESSOR	EXV	ELECTRONIC EXPANSIVE VALVE
KM	CONTACTOR	DPS	DIFFERENTIAL PRESSURE SWITCH
HP	HIGH PRESSURE SWITCH	OL	OVERLOAD PROTECTOR
LPT	LOW PRESSURE SENSOR	TR	TRANSFORMER
FAN	FAN MOTOR		

JUMPER SETTING:

JP6	JP7
OPEN	OPEN

OVERLOAD PROTECTOR SETTING:

OL1	OL2	OL3	OL4
SZ.0A	SZ.0N	Z.4A	Z.4A

SWITCH SETTING:

S1	S2	S3	S4
OFF	ON	ON	OFF

NOTE:

- FIELD WIRING
- FACTORY WIRING
- S1, S2, S3, S4: SLAVE UNIT QUANTITY SETTING. S2, 4-2.8 ADDRESS SETTING.
- JP6, JP7 IS SET TO OPEN. IF THE LAST SLAVE UNIT, CLOSED JP6.

DWG NO.:M08024305xxx

MODEL: UAL210AC5/AE5

380V/3Ph/60Hz

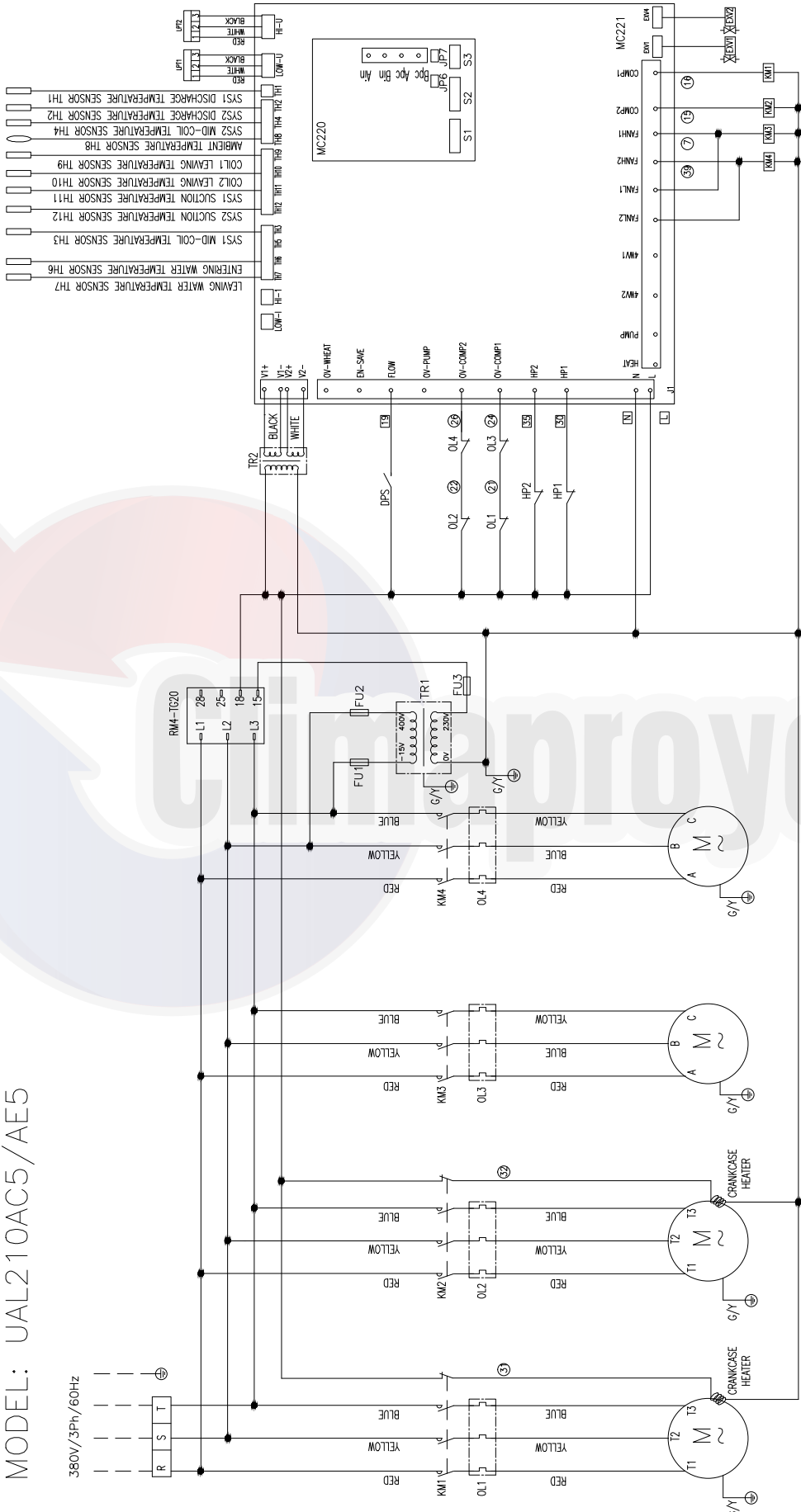
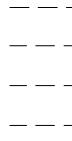

COMP1 COMP2 FAN1 FAN2

SYMBOL DESCRIPTION:

SYMBOL	DESCRIPTION	SYMBOL	DESCRIPTION
RM4-TG20	PHASE PROTECTOR	FU	FUSE
COMP	COMPRESSOR	EXV	ELECTRONIC EXPANSIVE VALVE
KM	CONTACTOR	DPS	DIFFERENTIAL PRESSURE SWITCH
HP	HIGH PRESSURE SWITCH	OL	OVERLOAD PROTECTOR
LPT	LOW PRESSURE SENSOR	TR	TRANSFORMER
FAN	FAN MOTOR		

JUMPER SETTING:

J1P6	J1P7	OPEN	CLOSE
OL1	OL2	OL3	OL4
S1	S2	S3	S4
S11	S12	S13	S14
S21	S22	S23	S24
S31	S32	S33	S34

SWITCH SETTING:

ON	OFF	ON	OFF	ON	OFF	ON	OFF	ON	OFF
S1	S2	S3	S4	S11	S12	S13	S14	S21	S22
S21	S22	S23	S24	S31	S32	S33	S34		

WIRING CONNECTION:

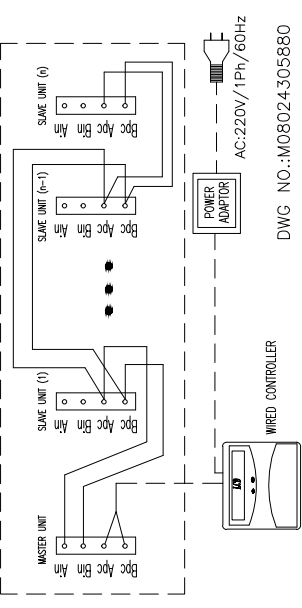

- NOTE:
1. --- FIELD WIRING
 2. --- FACTORY WIRING
 3. S1.5-S1.8 SLAVE UNIT QUANTITY SETTING, S2.4-S2.8 ADDRESS SETTING.
 4. J1P6/J1P7 IS SET TO OPEN IF THE LAST SLAVE UNIT, CLOSED J1P6.

DWG NO.:M08024305880

Installation

Working Condition

Item	Contents
Power supply voltage	Rated voltage $\pm 10\%$
Power supply frequency	Rated frequency $\pm 1\%$
Variations between phases	Rated voltage $\pm 2\%$
Air quality	Must not contain solute that can corrode copper, aluminum or iron.
Flow rate of chilled water	0.5 - 2.0m/s
Pressure of chilled water	$< 0.7\text{Mpa}$
Quality of chilled water	Must not contain solute that can corrode copper, iron, or welding material. For details on the water quality requirements, see: Water Quality Requirements (page 24).
Installation site	Take anti-snow and ventilation measures as required.
Ambient temp.	Refer to the figure above.
Relative humidity	$< 90\%$

NOTES:

1. THE UNIT IS STRICTLY TESTED BEFORE DELIVERY AND CAN WORK SAFELY IN THE RATED WORKING CONDITIONS.
2. FOR THE PERFORMANCE OF THE UNIT IN DIFFERENT WORKING CONDITIONS, PLEASE REFER TO PERFORMENC CURVE.
3. THIS IS THE NORMAL OPERATING TEMPERATURE RANGE FOR THE UNIT. BEYOND THIS TEMPERATURE RANGE, THE UNIT CAN ONLY OPERATE FOR A SHORT MOMENT BEFORE A FAILURE ALARM IS TRIGGERED.

Installation Dimensions and Environment Limits

Machine Installation Space

Units must be installed by DAIKIN service staff or by specially trained personnel.

Units must installed by following relevant national and local electric, building and environment protection standards as well as the installation manual.

Assembling Unit Modules

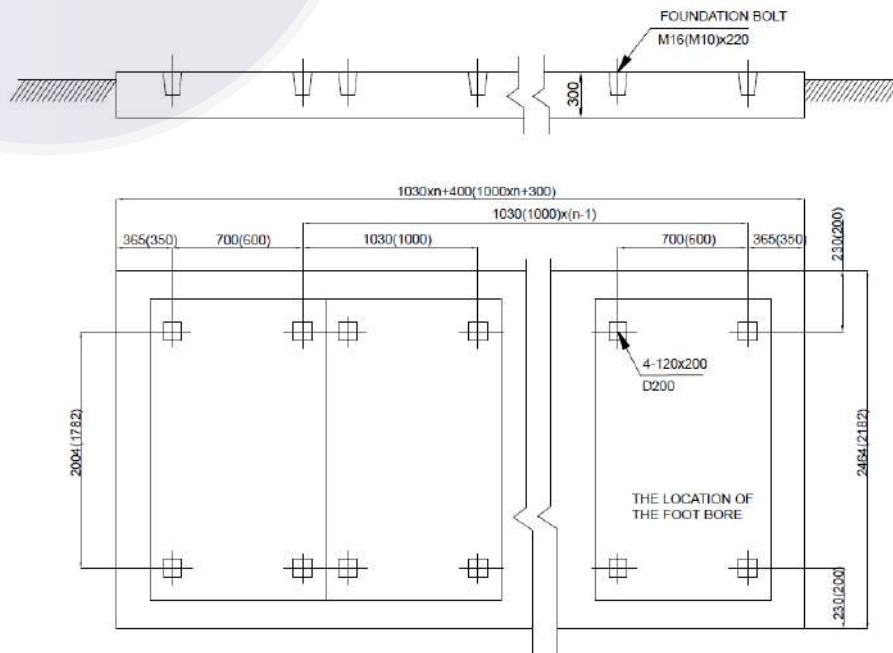

Unit: mm

NOTES:

1. FOUNDATION IS CONCRETE CONSTRUCTION OR CHANNEL STRUCTURE, FOUNDATION MUST BE SMOOTH.

2. 20MM THICKNESS RUBBER SHOCK PAD IS NEEDED BETWEEN THE FOUNDATION AND THE FRAME.
3. 4M 16 BOLT FIX ONE UNIT.
4. "N" IS THE TOTAL MODULAR UNIT.
5. THE NUMBERS IN BRACKETS ARE FOR UAL160A5.

Space Allocated for A Single Chilled Water Unit

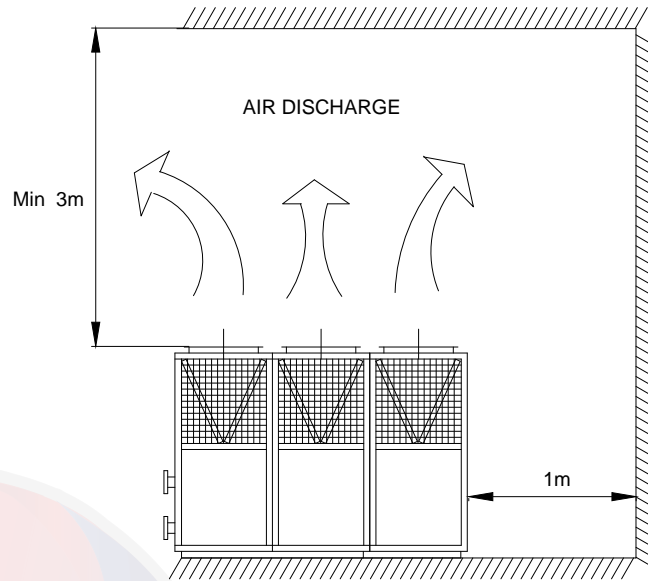

Space Allotted for An Array of Chilled Water Units

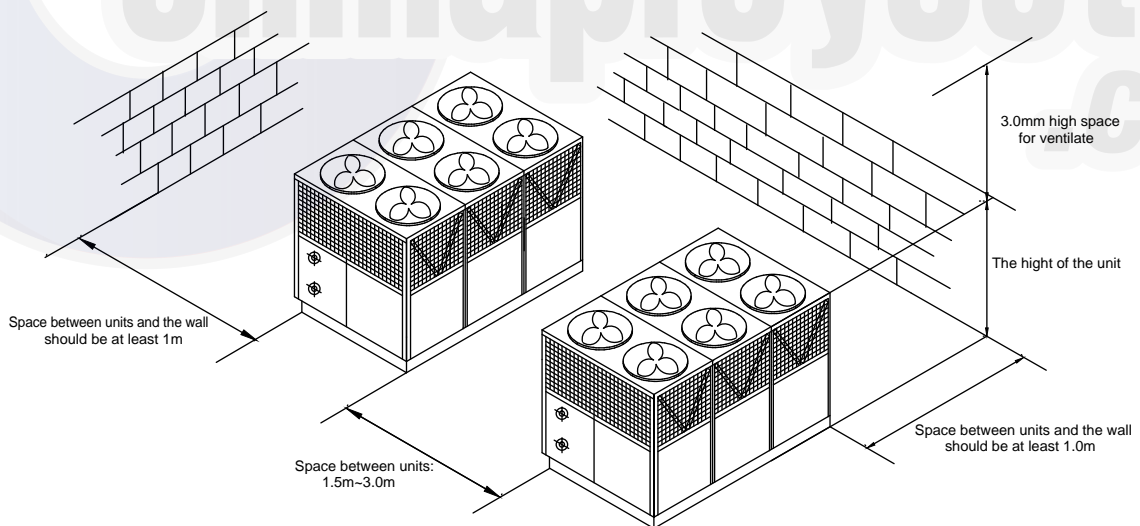

Installing Chiller

- The user manual, warranty card, accessories, and packing list are placed in the electrical box of the unit.
- Reserve sufficient maintenance space if possible.
- If the unit is installed in a place where it snows in winter, proper measures must be taken to protect the unit against snow and ensure that the unit works properly.
- The groundwork should be made of concrete or supporting structures. While designing the groundwork, you must fully consider the strength of the floor, water discharge (the unit discharges water while working), pipeline and wiring. If the floor is not strong enough, the unit might fall off and breakdown, even incur bodily injuries.
- Screw down the chilled water unit using anchor bolts so that it will not fall off in case of strong wind or earthquakes. To avoid damages caused by strong wind or earthquakes, The unit must be securely installed at a proper place to avoid direct hit of strong winds.
- Depending on mounting conditions, operation vibration might pass through the groundwork and generate noises in the floor and walls. Therefore, proper vibration dampening mechanisms (such as bumper cushion, bumper frame etc.) should be in place.
- Corners and edges should be properly installed. Otherwise, the unit might get unbalanced and cause the grounding pins to bend. The unit might fall off and cause bodily injuries if it is not properly installed.

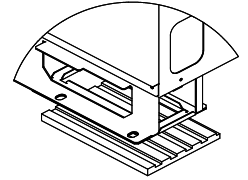

Hoisting Chillers

Please hoist the unit according to the following illustrations. Tie the cables to the four corners of the unit while moving it. If you tie the cables to only three corners of the unit, the unit might get unbalanced and fall off.

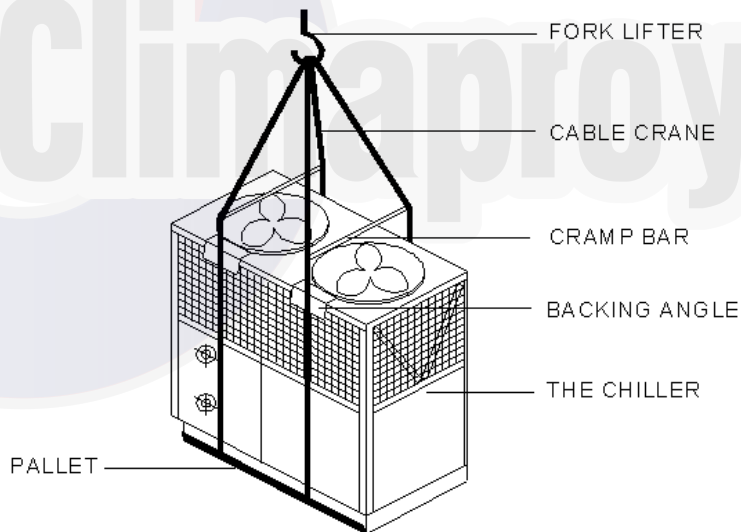

NOTES:

- *CHILLED WATER UNITS MUST BE MOVED WITH GREAT CARE.*
- *ACCESSORY STRIPS CANNOT BE USED TO HOIST OR MOVE THE UNIT AS THEY MIGHT BREAK AND CAUSE UNEXPECTED ACCIDENTS.*
- *DO NOT TOUCH THE HEAT SINKS OF THE HEAT EXCHANGER BARE-HANDEDLY AS THEY MIGHT CUT YOUR FINGERS.*
- *DISPOSE ALL PLASTIC BAGS PROPERLY AND KEEP THEM AWAY FROM CHILDREN.*

Water System Installation

Water quality requirements

Water in the water system must be softened to prevent scale in the heat exchanger and affecting the heat exchanger performance. Water not softened can also cause scale in the water pipes and cause the water resistance to increase. This affects the water flow and the performance of the water pump. Softened water must meet the following requirements.

Item		Benchmark value	Tendencies		
			Corrosion	Scaling	
Benchmark items	pH (25°C)		7.0 - 9.0	○	○
	Conductivity (25°C)	μS/cm	< 800	○	○
	Cl ⁻	mg (Cl ⁻)/L	< 200	○	
	SO ₄ ²⁻	mg (SO ₄ ²⁻)/L	< 200	○	
	Acid consumption (pH = 4.8)	mg (CaCO ₃)/L	< 100		○
	Total hardness			mg (CaCO ₃)/L	< 200
Reference items	Fe	mg (Fe)/L	< 1.0	○	○
	S ²⁻	mg (S ²⁻)/L	0	○	
	NH ₄ ⁺	mg (NH ₄ ⁺)/L	< 1.0	○	
	SiO ₂	mg (SiO ₂)/L	< 50		○

NOTE: ○ REPRESENTS FACTORS THAT MAY CAUSE CORROSION OR SCALING.

Water System Installation Schematic Diagram

Connecting Water Pipes

No water pump is provided as an accessory. A proper water pump must be installed to overcome resistance of the water pipes.

- Water pressure gauges and thermometers must be installed at the water inlets and outlets to facilitate the reading of unit operation status.
- The heat exchanger at the water side is made of stainless steel. Water scale may accumulate depending on the water quality and must be cleared using chemicals from time to time. Therefore, a chemical cleaning pipe connector needs to be installed at the water pipes (see the following figure).

The water flow must be in the rated range. If the water flow is too small, scale may accumulate and degrade the performance of the unit, cause the antifreeze device to activate, or cause rust points and refrigerant leakage. If the water flow is too large, the unit may be corroded due to water impact.

- A adiabatic water tank with a proper volume is suggested to installed . If the capacity is too small, the unit might frequently restart, which causes wear and tear on the compressor.
- An expansion water tank must be installed at the return water side of the water system to adapt to water pressure variations in the water supply system caused by ambient temperature changes.

An auto relief valve must be installed at the highest point in the water system. A suitable water discharge valve must be installed at the lowest point in the water system.

- The water pipes must be adiabatic to avoid heat loss and condensate water.
- Please follow the "Illustration for water system installation" and drawings from the design institute while installing the water system.
- Install the Y-shaped water filter inside the water inlet pipe and rinse the filter screen after commissioning.
- Before injecting water, make sure that no sand, rubble, rust, soldering tin residue or other impurities exist in the pipe, as these things might damage the heat exchanger.
- While rinsing the water system, please bypass the unit and the terminal heat exchanger using by-pass valves.

Illustration for water system installation

System 1:

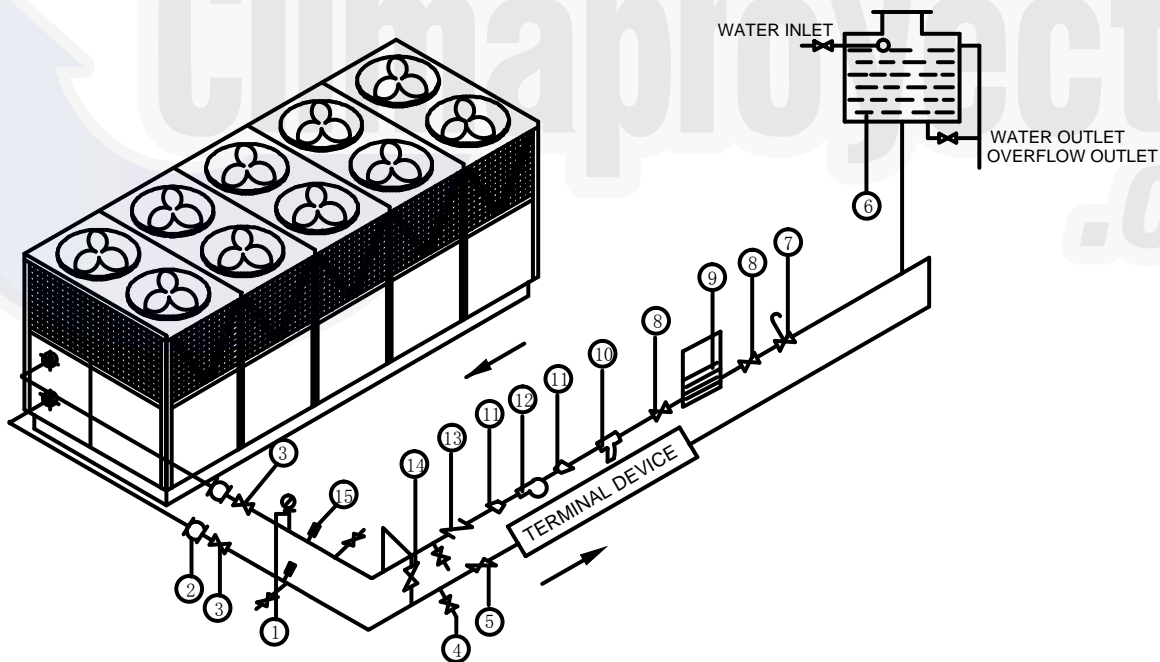

System 2:

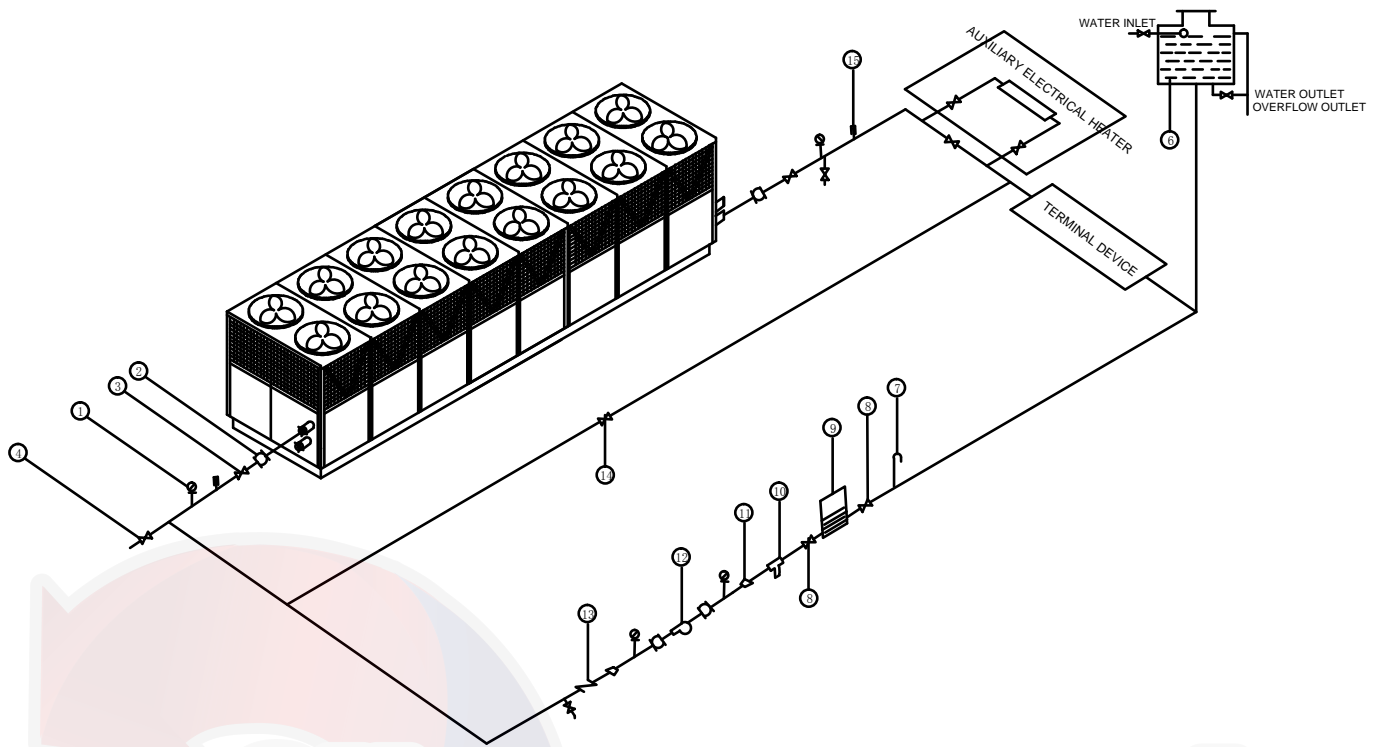

1	Pressure Gauge (0-1MPa)	7	Auto air vent valve	13	Check Valve
2	Flexible Joint	9	Water Tank	14	Bypass Valve
3,5,8	Gate Valve	10	Y-strainer	15	Thermometer (0-100°C)
4	Drain Valve	11	Reducer		
6	Expansion Tank	12	Pump		

NOTE: BOTH SYSTEM 1 AND SYSTEM 2 CAN BE USED ON LESS THAN 6 UNITS CONNECTION (INC. 6 UNITS). ONLY SYSTEM 2 CAN BE USED ON MORE THAN 6 UNITS CONNECTION. THIS IS HELPFUL FOR BALANCE OF THE HYDRAULIC SYSTEM.

Prior to starting up the unit, flushing of the water system is required:

1. Shut off the inlet and outlet valves and turn on the bypass valve.
2. Run the pump to circulate the water in the system for a while.
3. Open up the strainer to inspect the filter.
4. Clean the filter if necessary to ensure no debris trap in the piping system.
5. Shut off the bypass valve and turn on the inlet and outlet valves.
6. System is ready for operation.

CAUTION:

If the chiller is operated under very oily, salty or acidic atmosphere or water, these substances may lead to capacity drop or failure of the unit.

More than 6 (including 6) combined modularity must apply reverse return system.

Make sure the pump is controlled by PCB controller, otherwise the heat exchanger may be frozen broken.

Be sure to use clean water when filling in the water circuit to avoid heavy corrosion and choking of the system.

Hydraulic Calculation and Pipe System

Pipe design for the air-conditioning system

- The pipes of an air conditioning system must have sufficient transportation capacities. For example, the water system must ensure that the water flowing through the air conditioning unit or fan coil reaches the rated flow rate to ensure that the unit works properly.
- Deploy pipes properly. Use pipes with reverse return if possible. Although the initial investment is increased a little, the water flow in the system is more stable. If pipes have no reverse return design, pressure between branch pipes must be balanced in the design process.
- When determining the diameters of pipes, ensure that the transportation capacity is sufficient, the resistance and noise is minimal, and that the unit works economically. A larger pipe diameter requires more investment, but the flow resistance is smaller, the circulation pump consumes less energy, and the operation cost is smaller. Therefore, a balance needs to be achieved between the operation cost and investment by designing the pipe diameter properly. Avoid a large water flow with small temperature variation to ensure that the pipe system is economical.
- In the design process, calculate water resistance accurately to ensure that water pressures between circuits are well balanced and that the air conditioning system works with the best water and thermal conditions.
- The pipe system of an air conditioning system must meet the adjustment requirements for partial workload.
- The pipe system of an air conditioning system should use energy saving technologies whenever possible.
- Pipes and accessories of the pipe system must meet the related requirements.
- The design of the pipe system must facilitate maintenance, operation, and adjustment.

* Determining the diameter of pipes in the air conditioning system

The pipe diameter is determined based on the following:

$$d = \sqrt{\frac{4m_w}{3.14 v}}$$

In the formula: m_w -----water flow m^3/s
 v -----water speed m/s

The water speed should be determined by the recommendations in the first table and design the water pipe diameters accordingly, or you can determine the water pipe diameter based on water flow in the second table.

Table 1: Recommended water speed (m/s)

Diameter (mm)	12	20	25	32	40	50	65	80
Closed water system	0.4 - 0.5	0.5 - 0.6	0.6 - 0.7	0.7 - 0.9	0.8 - 1.0	0.9 - 1.2	1.1 - 1.4	1.2 - 1.6
Open water system	0.3 - 0.4	0.4 - 0.5	0.5 - 0.6	0.6 - 0.8	0.7 - 0.9	0.9 - 1.0	0.9 - 1.2	1.1 - 1.4
Diameter (mm)	100	125	150	200	250	300	350	400
Closed water system	1.3 - 1.8	1.5 - 2.0	1.6 - 2.2	1.8 - 2.5	1.8 - 2.6	1.9 - 2.9	1.6 - 2.5	1.8 - 2.6
Open water system	1.2 - 1.6	1.4 - 1.8	1.5 - 2.0	1.6 - 2.3	1.7 - 2.4	1.7 - 2.4	1.6 - 2.1	1.8 - 2.3

Table 2: Pipe diameter and resistance loss in unit length

Diameter of the steel tube (mm)	Closed water system		Open water system	
	Water flow (m^3/h)	kPa/100m	Water flow (m^3/h)	kPa/100m
15	0 - 0.5	0 - 60	--	--
20	0.5 - 1.0	10 - 60	--	--
25	1.0 - 2.0	10 - 60	0 - 1.3	0 - 43
32	2.0 - 4.0	10 - 60	1.3 - 2.0	11 - 40
40	4.0 - 6.0	10 - 60	2.0 - 4.0	10 - 40
50	6.0 - 11.0	10 - 60	4.0 - 8.0	--
65	11.0 - 18.0	10 - 60	8.0 - 14.0	--

Diameter of the steel tube (mm)	Closed water system		Open water system	
	Water flow (m³/h)	kPa/100m	Water flow (m³/h)	kPa/100m
80	18 - 32	10 - 60	14 - 22	--
100	32 - 65	10 - 60	22 - 45	--
125	65 - 115	10 - 60	45 - 82	10 - 40

NOTE: PARAMETERS IN THE PRECEDING TABLE MAY VARY BASED ON THE DESIGN MANUAL. FOR DETAILS, SEE THE "HVAC DESIGN MANUAL".

Water Storage Tank Volume Calculating

Vmin is referred to the below table:

Model	Setting EWT(°C)	Vmin(L)
UAL160A5	14	195
	13	231
	12	282
	11	362
	10	507
	9	846
UAL210A5	14	238
	13	281
	12	344
	11	442
	10	619
	9	1032

NOTES:

1. THE TOTAL WATER VOLUME OF THE ENTIRE HYDRAULIC SYSTEM INCLUDES THE WATER IN MAIN PIPE, WATER TANK AND TERMINAL EQUIPMENTS, IN WHICH THE 2-WAY VALVE IS OPEN.
2. IF THE WATER VOLUME (V) WHILE THE UNIT IS RUNNING IS LESS THAN VMIN, IT'S RECOMMENDED TO INSTALL A WATER TANK OF (VMIN-V)L, OR IT WILL CAUSE THE UNIT FREQUENT ON/OFF.
3. THE VMIN IN THE TABLE IS CALCULATED BASED ON NOMINAL COOLING WATER FLOW AND 5°C ANTI-FREEZE. IF THE WATER FLOW AND ANTI-FREEZE TEMPERATURE CHANGE, RELATED VMIN WILL CHANGE.
4. THE TABLE IS APPLIED FOR THE WATER VOLUME SELECTION OF NORMAL CHILLER, NOT FOR THE CHILLER UNDER LOW LEAVING WATER TEMPERATURE WITH GLYCOL.

Calculating Volume of Expansion Water Tank

An expansion water tank with a proper volume must be installed to adapt to water volume changes as the temperature changes and avoid freezing burst and pressure instability at the water pump inlet.

The expansion water tank can also be used to supplement water and discharge air.

Calculating volume of expansion water tank.

$$V_p = \alpha \cdot \Delta t \cdot V_s$$

Vp----effective volume of the expansion water tank (volume of water between the signal pipe and the overflow pipe). m³

α----volume expansion coefficient of water (α =0.0006/°C)

Δt----max. water temperature variation °C

Vs----water volume in the system (total water volume in the system and pipes) m³

Model Selection Principles for the Water Circulation Pump

Water flow in the water circulation pump ≥ rated water flow × 1.1

Closed water circulation system: Water circulation pump lift \geq (Pipe resistance of the water system + Partial resistance of the water system + Water pressure drop of the unit) \times 1.1

Open water circulation system: Water circulation pump lift \geq (Static resistance of the water system + Pipe resistance of the water system + Partial resistance of the water system + Water pressure drop of the unit) \times 1.1

In the case that multiple units share the same pump, the pump lift is calculated according to the circuit that has the maximum resistance (usually the unit that is farthest away from the pump).

NOTE: THE WATER FLOW OF THE UNIT SHOULD CALCULATE ACCORDING THE WATER FLOW RANGE.

Water flow range

Model		UAL160A5	UAL210A5	
Flow range	Max. value (m ³ /h)	208V~230V/3Ph/60Hz	11.87	14.43
		460V/3Ph/60Hz	11.87	14.43
		380V/3Ph/60Hz	11.27	14.43
	Rated value (m ³ /h)	208V~230V/3Ph/60Hz	9.13	11.1
		460V/3Ph/60Hz	9.13	11.1
		380V/3Ph/60Hz	8.67	11.1
	Min. value (m ³ /h)	208V~230V/3Ph/60Hz	6.39	7.77
		460V/3Ph/60Hz	6.39	7.77
		380V/3Ph/60Hz	6.07	7.77



Commissioning and Operation

Items to be Confirmed Before Turning on Unit



Note: Before the pilot run, check that the following conditions are met and read the "Safety Precautions" again.

- Ensure that the water pump and the unit are connected.
Use the PCB controller to Control the on and off the water pump using the water pump output on the PCB controller; otherwise the BPHE may burst due to freezing.
The water pump connection point must have no voltage. If a voltage circuit is connected, basic components may be damaged.
- Power on the unit to preheat the crankcase for at least 12 hours before starting up the unit for the first time or after a long-term stoppage. This ensures that the compressor works properly.
- Before turning on the unit, check that the water pump is filled with water.
Before turning on the water pump, open the water supply valve, fill the pump with water, and discharge free air in the system
- Wiring of the unit: Check that the diameter of the wires meets requirements; the wires are correctly connected; the grounding line is securely connected;
- Before turning on the unit, clean the water system and ensure that pipes are clean without contaminants.
- Make sure that the working conditions do not exceed the rated working range.

Items to be Checked during the Pilot Run

Check the following items after the unit has worked properly for a period of time:

S/N	Item	Checking Method	Reference Standard
1	Power supply voltage	Voltage	Rated voltage±10%
2	Working current of a single compressor	Current	13 - 23A
3	Working current of a single fan	Current	2 - 5A
4	Inlet water temperature in cooling operation	Temperature	15- 20°C
5	Outlet water temperature in cooling operation	Temperature	6 -15°C
6	Inlet/outlet water temperature difference	Temperature	2 - 7°C
7	Discharge air temperature of the compressor	Temperature	65 -115°C
8	Low pressure in cooling mode	Pressure	6.5 - 10.0bar
9	High pressure in cooling mode	Pressure	22 - 41.5bar
10	Vibration and operation noise	Listen or touch	No abnormal vibration or noise

NOTE: THE REFERENCE STANDARDS ARE USED TO CHECK WHETHER A UNIT WORKS PROPERLY ONSITE. REFERENCE STANDARDS ARE DETERMINED BASED ON THE MAXIMUM AND MINIMUM WORKING CONDITIONS. IF REFERENCE STANDARDS ARE EXCEEDS AFTER THE UNIT HAS PROPERLY WORKED FOR A PERIOD OF TIME, CONTACT THE LOCAL DEALER OR DAIKIN FOR HELP.

Maintenance

Repair



Note: Before checking and maintaining the unit, confirm the safety precautions again.



Note: Before delivery, strict factory test is conducted to ensure the unit works at optimal performance. The unit must be maintained from time to time.

- The unit can only be repaired and serviced by specially-trained technicians. After a unit is serviced, safety controls must be checked and analyzed before the unit is turned on.

Items to be Checked Periodically

- Clean the fin heat exchanger periodically.
To optimize heat exchange efficiency of the condenser, check that the external part of the condenser is clean without leaves, cotton fibers, insects or other impurities which might clog up fins of the condenser. Use water or water vapor while cleaning to clean it.
- Check the status of the chilled water from time to time.
Discharge water by loosening the air or water discharge plug.
If the water quality degrades, replace water in the system timely.
Contaminated water can degrade the cooling capacity and corrode the heat exchanger and water pipes.
- Check whether free air exists in the water pipe system.
Free air may get into the system even during the air discharging process. Discharge air from time to time.
- Clean the Y-shaped water filter in the water system periodically.
- Replenishing refrigerant and lubricant.
Each unit is filled with enough refrigerant and lubricant before delivery.
If the system operates smoothly, customers neither need nor are allowed to replenish or change the refrigerant or lubricant.
If replenishment is necessary due to leakage, please refill the quantity specified in the nameplate of the unit.

Maintenance

The unit must be checked on a routine basis to ensure performance. Routine check is the best way to reduce downtime and waste. The following needs to be checked on a routine basis:

Items	Monthly	Quarterly	Once half a year	Once a year	If necessary
1. Compressor					
Performance appraisal; whether there is abnormal sound	•				
Whether wires are securely connected	•				
Whether the working current is abnormal (fluctuation: 10%)		▲			
Discharge air temperature of the compressor		▲			
Check the oil level					▲
Check the color of the lubricant					▲
2. Controller					
Check parameter settings			▲		
Check protective device			▲		
Delay protector			▲		
Phase order protector			▲		
High/low pressure switch					▲
Differential water pressure switch/water flow switch					▲
Overload protector			▲		
Protector against extreme temperature of discharged air			▲		
3. Plate heat exchanger					
Check the water quality	•				
Clean the plate heat exchanger					▲
Seasonal protection measures (anti-freeze in winter)					▲
4. Fin heat exchanger					
Clean the fin heat exchanger		▲			
5. Others					
Whether the Y-shaped filter needs to be cleaned or replaced	•				
Whether bolts have loosened		•			

NOTE: THE PRECEDING MAINTENANCE PLAN IS FOR REFERENCE ONLY. THE MAINTENANCE PLAN MAY VARY BASED ON REGION.

• INDICATES ITEMS TO BE CHECKED BY CUSTOMERS; ▲ INDICATES ITEMS TO BE CHECKED BY SERVICE PERSONNEL.

Water Processing Method

To ensure effective operation and durability, cleaning, washing and chemical processing are very important for water systems. Different types of water circuits need to be cleaned in different ways.

■ Close Re-Circulation System

Water systems of this type generally require no adjustment to subdue scale, and require no chemical to suppress mud and alga. This type of water system is recommended. Closed recycle systems may need anti-corrosion measures, including the following (for reference only):

NaNO₂, borate and inhibitors for organic materials

- a. NaNO₂, borate and silicate
- b. High density chromate solution and pH control
- c. pH and sulfite control
- d. Polyphosphate salt and silicate
- e. Alkali, phosphate and sulfite control

Because it is hard to control water quality, for closed recycle systems, we recommend that the total density of copper pipe inhibitors such as NaNO₂, borax, silicate and benzothiazole should be no less than 1400 ppm. The inhibitor NaNO₂ is soluble in glycol, and can be used in northern areas or in the subsystem of solar power systems.

■ Open Re-circulation System

This type of water system is generally not recommended. They are exposed to the atmosphere, and are susceptible to scale, corrosion, mud and alga. Therefore, they might degrade the performance and reduce the service life of the unit.

■ Once-through System

Generally, once-through systems are only used for cooling only air conditioners. Water systems of this type use water from taps, lakes, rivers, and wells. Although the once-through system exchanges heat with the closed water circuit, it is not considered as an integral part of the water source heat pump system. Once-through systems may be troubled by either scale or corrosion. This type of water system requires large amount of adjustment water. Therefore, you need to consider the scale coefficient, the equipment used for cleaning work, and necessary anti-corrosion materials.



Caution

Water from lakes and rivers may cause problems such as mud and alga!

Comparison among closed recycle systems, open recycle systems and once-through systems

	Once-through System	Open Recycle System	Closed Recycle System
Scale control	<ol style="list-style-type: none"> 1. Surface activator such as polyphosphate salt 2. Increased acidity 3. pH adjustment 4. Other considerations include: surface temperature, water temperature and system cleaning 	<ol style="list-style-type: none"> 1. Discharge 2. Surface activator such as polyphosphate salt 3. Increased acidity 4. pH adjustment 5. Softening (other considerations include: surface temperature, water temperature and system cleaning). 	No control is necessary
Corrosion control	<ol style="list-style-type: none"> 1. Low density corrosion inhibitor 2. Anti-CaCO₂ plate 3. pH control 4. Proper material 	<ol style="list-style-type: none"> 1. High density (200 - 500 ppm) corrosion inhibitor 2. Low density (20 - 30 ppm) corrosion inhibitor 3. pH control 4. Proper material 	<ol style="list-style-type: none"> 1. High density corrosion inhibitor 2. Proper material
Mud and alga control	<ol style="list-style-type: none"> 1. Chloridized hydroxybenzene 2. Other chemicals 3. Chlorine formed by hypochlorite and liquid chlorine 	<ol style="list-style-type: none"> 1. Chloridized hydroxybenzene 2. Other chemicals 3. Chlorine formed by hypochlorite and liquid chlorine 	No control is necessary

Control System Instruction

Power Cable Connection Diagram

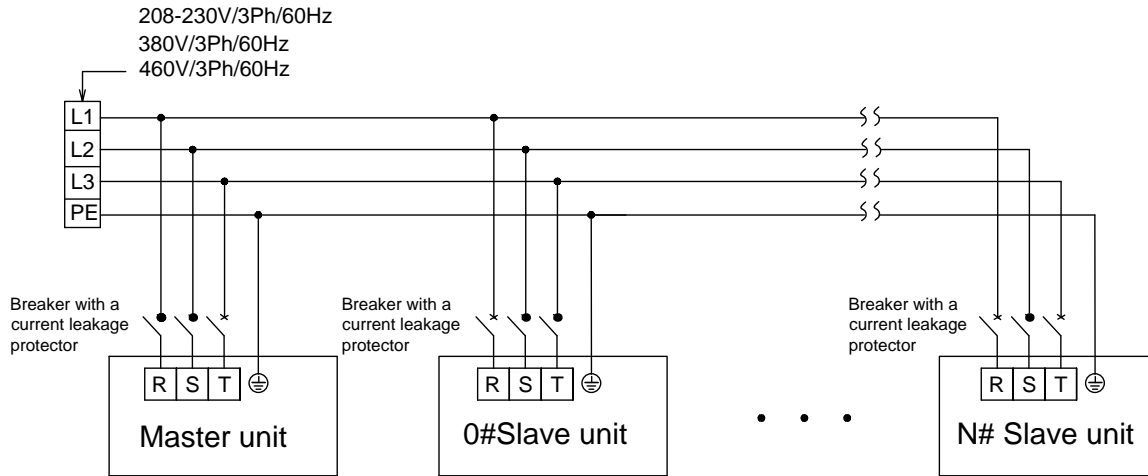

- The dimension of power cable connection refer to electrical parameters.
- All wires must be securely connected.
- Wires must not contact the refrigerating pipes or moving parts of the compressor and the fan.
- $N \leq 9$

PCB instruction

Connection illustration for the pump and the auxiliary heat exchanger

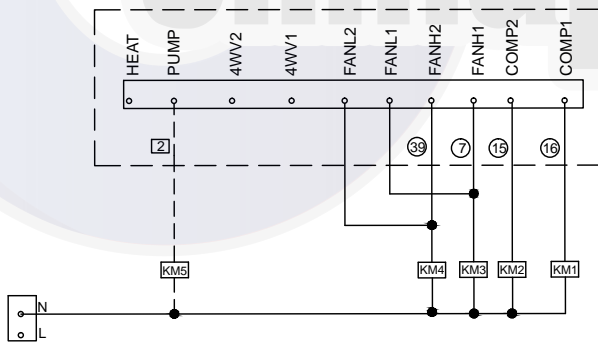

Pump connection illustration

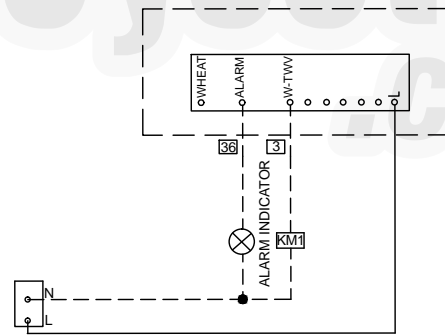

Auxiliary heat exchanger connection illustration

NOTE: -----PARTS WITHIN THE DASHED BOX ARE TO BE CONNECTED ONSITE. THE OUTPUT VOLTAGE OF THE MODULE INTERFACE IS 220-240 V.

—PARTS WITHIN THE REAL-LINE BOX ARE CONNECTED BEFORE DELIVERY.

A COOLING ONLY UNIT HAS NO 4WV1 AND 4WV2 OUTPUT. A SLAVE UNIT HAS NO EXTENSION BOARD UAL-E.

HEAT—BPHE ELECTRIC HEATER ; PUMP—WATER PUMP ; 4WV—4-WAY VALVE ; FANL—FAN AT LOW SPEED; FANH—FAN AT HIGH SPEED; COMP—COMPRESSOR; WHEAT—AUXILIARY ELECTRIC HEATER OF THE WATER SYSTEM ; W-TWV—2-WAY VALVE INTERLOCK OF THE WATER SYSTEM

■ **Setting up address using DIP switch**

The controller can be used to set the unit's capacity, address and slave unit number. The capacity DIP has been set at delivery time and cannot be changed. The address DIP and slave number DIP need to be set as needed after the unit is installed. Customers need to take down the address number and location of the unit and keep the record in good condition for maintenance reference.



■ A slave unit number must be set for the master unit (not for slave units) (bits 5~8 of S1):

Slave unit number	5	6	7	8	Slave unit number	5	6	7	8
0	0	0	0	0	8	1	0	0	0
1	0	0	0	1	9	1	0	0	1
2	0	0	1	0	10	1	0	1	0
3	0	0	1	1	11	1	0	1	1
4	0	1	0	0	12	1	1	0	0
5	0	1	0	1	13	1	1	0	1
6	0	1	1	0	14	1	1	1	0
7	0	1	1	1	15	1	1	1	1

■ DIP address setting (4~8 bits of S2): When the unit is accessed to the BMS system, the address of the master unit must be set as below:

Address number	4	5	6	7	8	Address number	4	5	6	7	8
0	0	0	0	0	0	8	0	1	0	0	0
1	0	0	0	0	1	9	0	1	0	0	1
2	0	0	0	1	0	10	0	1	0	1	0
3	0	0	0	1	1	11	0	1	0	1	1
4	0	0	1	0	0	12	0	1	1	0	0
5	0	0	1	0	1	13	0	1	1	0	1
6	0	0	1	1	0	14	0	1	1	1	0
7	0	0	1	1	1	15	0	1	1	1	1

The address number of the master unit must be set to 0#, and that of the slave units should follow this. Address numbers must be unique in the same system.

■ **Communication between master and slave unit**

- A) The unit can only be powered on and commissioned after the address numbers are configured.
- B) Control (Communication) Wire Connection

A) conductor (WTC pair with cross section area of at least 0.5mm² or 20AWG); B) insulator; C) Screen layer (twisted WTC with a screening factor no less than 95%) ; D) Outer jacket (PVC);

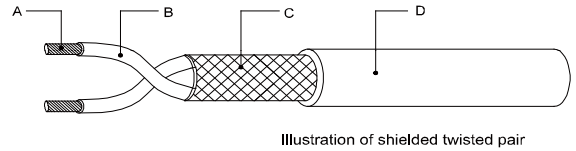
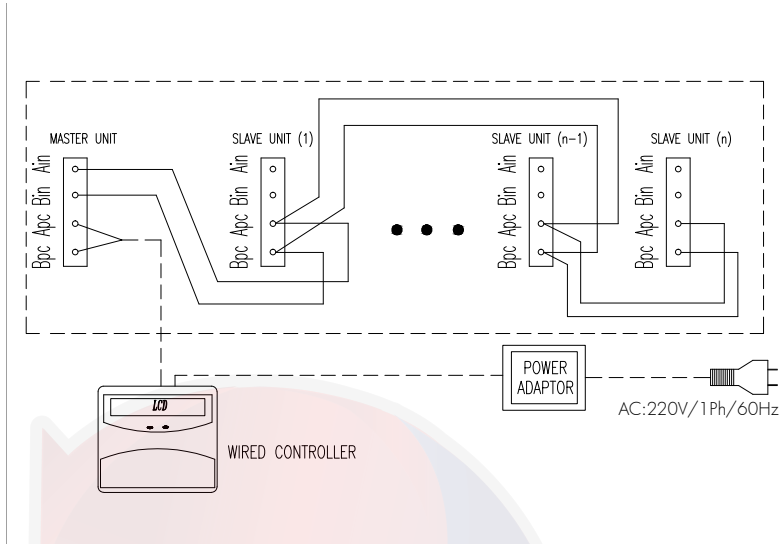

NOTE:
 BETTER CHOOSE NETWORK CABLES WITH A TENSER SHIELDING LAYER AND SMALLER TWISTING DISTANCE.
 PLEASE REFER TO THE UL2547 OR UL2791 WIRE SPECIFICATION.
 THE CONTROL WIRE MUST NOT BE LONGER THAN 1000 METERS.
 THE CONTROL WIRE MUST BE AT LEAST 20CM AWAY FROM MAJOR CURRENT WIRE.



Wired Controller Instruction

Dimensions

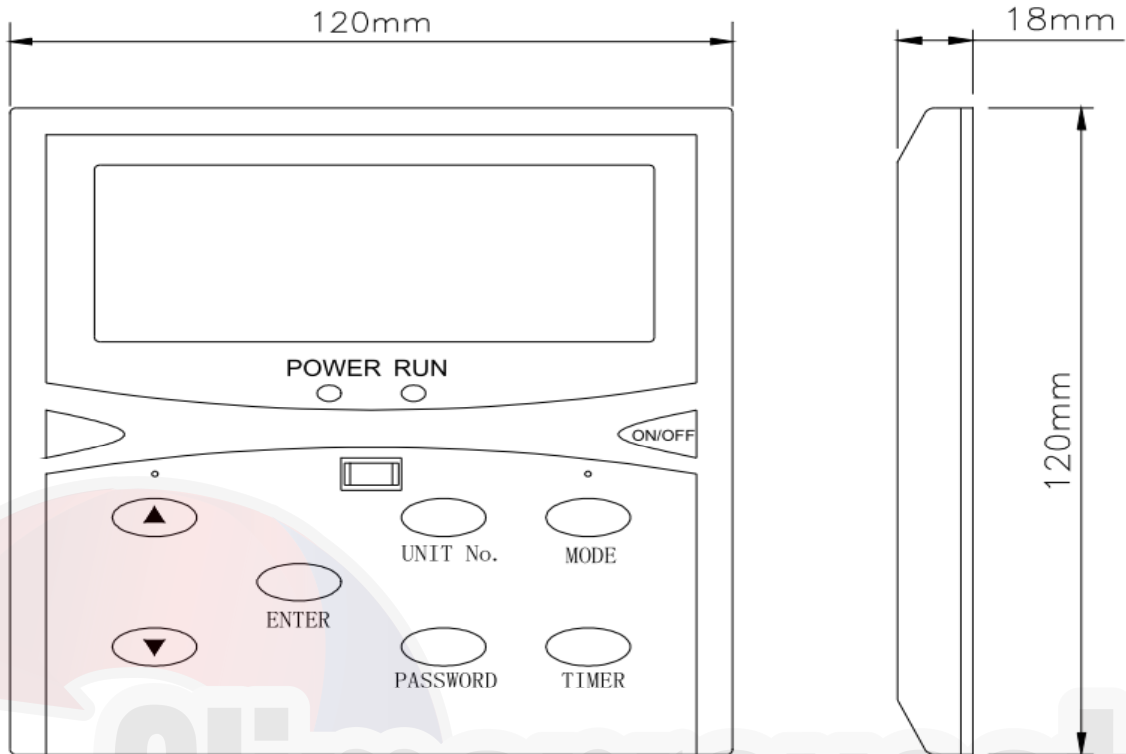

Controller Installation

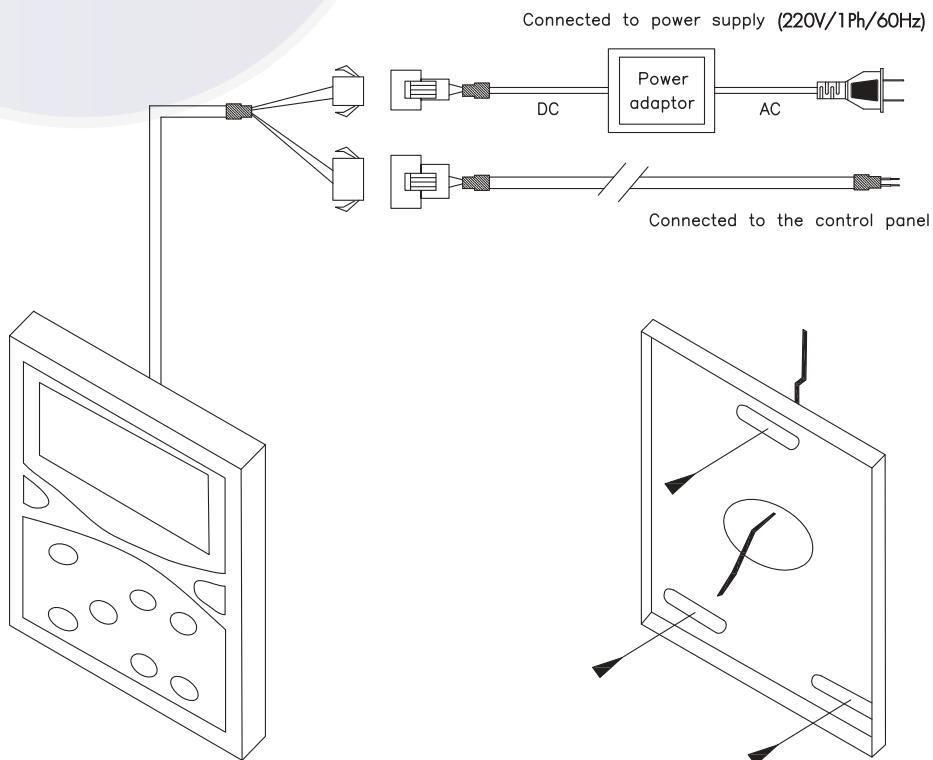

Functions

MC305 is a wall-mounted LCD controller which directly controls air conditioners through keys on its panel.

Features

Two operation modes: heating/cooling (note: operation modes can only be switched when the unit is off)

Temperature setting range for inlet water: cooling 9°C - 25°C; heating 25°C - 50°C; Temperature setting range for inlet water: cooling 9°C - 25°C (-10°C - 10°C for units with low water temperature); heating 25°C - 50°C.

- Temperature setting range for anti-freeze: 2°C - 5°C.
- A LED is used to indicate the status of the unit (ON/OFF).
- Timed ON/OFF: a timing schedule can be set for a maximum of 7 days with up to 4 timed actions each day.
- Real-time clock.
- Error code display speeds up diagnosis.
- Blue back light will shine 8 second if any key is pressed, it makes sure that we can browse or modify parameters even in dark.

Use Specification

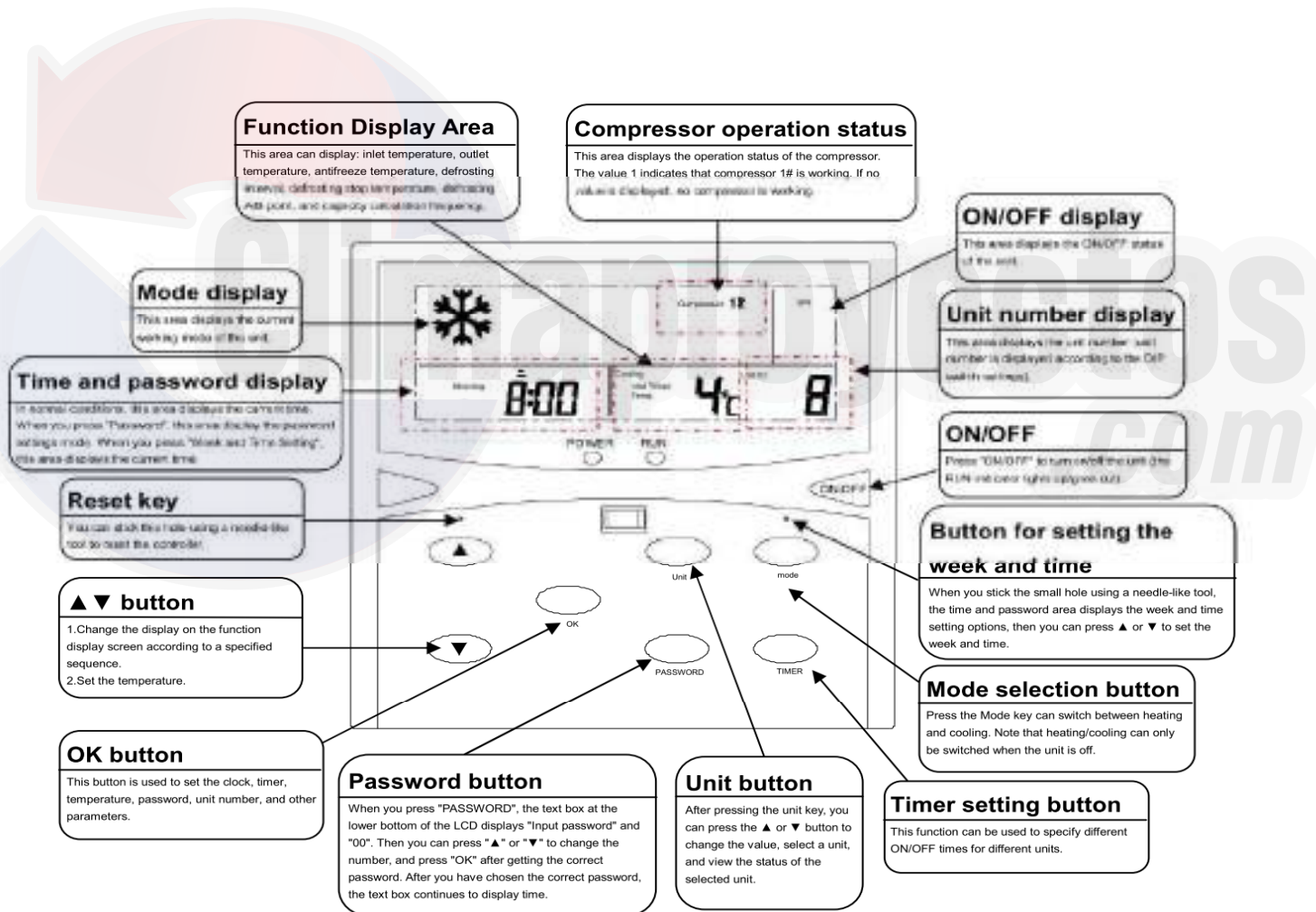

The control system has the following functions:

S/N	Function	S/N	Function
1	Controlling the 2-way valve of the water system (relevant accessories need to be purchase separately);	11	Timing
2	Anti-freeze protection for plate heat exchanger	12	Protection for Compressors in Operation
3	Alternative defrosting	13	Averaging Workload among Compressors
4	Manual defrosting	14	Failure alarm, viewing and output
5	2-way Valve Interlock Control	15	Memorizing parameters in the case of a power failure
6	Week Setting	16	Setting and resetting the operating parameters of the unit
7	Status display	17	Electric heater
8	Auto-startup at power on	18	Setting the clock of the system
9	Setting the serial number of a unit	19	Displaying the indoor and inlet water temperatures
10	Memorizing the clock settings in the case of a power failure		

Settings

1) Parameter Viewing

The controller can be used to view the operation status and parameters of any unit connected to it. Parameters can be view include operation status of the compressor, inlet/outlet water temperature, timer setting, cooling antifreeze temperature setting, antifreeze temperature setting in winter, defrosting temperature, and so on. After pressing the "UNIT" key, you can increase/decrease the blinking unit No. and view the parameters of the current unit by pressing "▲" or "▼". To view more working parameters of a unit, you can press "OK" and "▲" or "▼" after reaching the unit No.

2) Setting Parameters (parameters can be set only when the unit is turned off)

- ① When you press "PASSWORD", the text box at the lower bottom of the LCD displays "Input password" and "00". Then you can press "▲" or "▼" to change the number, and press "OK" after getting the correct password (the default password set in factory is "55"). After you have chosen the correct password, the parameters to be set blinks, and you can perform the following settings:
- ② Change operation parameters: after choosing the correct password, you can change operation parameters by following steps ② → ③ → ④ .
Change password: after choosing the correct password, you can change the password by pressing "PASSWORD" again. In this case, the text box displays "00" and you can change the number by pressing "▲" or "▼". After reaching the number you want to set as the password, you can complete password setting and exit the parameter setting mode by pressing "OK".
After pressing the "UNIT" key, you can increase/decrease the blinking unit No. by pressing "▲" or "▼", and set operation parameters (including inlet water temperature for cooling/heating mode) for the desired unit by pressing "OK" after reaching the unit No. You can choose and set parameters by pressing "▲" or "▼" and then press "OK" to save the setting.
Repeat step ② to set other parameters (note: the controller quits the parameter setting mode if no key is pressed within 60 seconds).

3) Real Time Setting

To set week and time, stick the small hole above the "MODE" key using a needle-like tool (the LCD displays "Weekday Setting"); press "▲" or "▼" to choose the weekday; stick the small hole again to save weekday setting (the LCD displays "Time Setting" and the time starts to blink); press "▲" to change the hour and "▼" to change the minute; and stick the small hole again to save time setting.

4) Timer Setting

- ① After pressing "TIMING", the LCD displays "Week Setting" and "Timer Setting" at the same time. Then you can press "▲" or "▼" to choose the weekday and press "OK" to save the weekday setting. The LCD now displays "Timer Setting", and you can continue to set the times of timing.
- ② Press "▲" or "▼" to set the number of timed actions for the day (you can set 4, as indicated above Unit No.) Select a timed action and press OK to select the action (timed ON/OFF).
- ③ Press "▲" or "▼" to select "Timed On" or "Timed Off" and press "OK". Now the LCD displays "Timer Setting" and "Time Setting" and the time displayed starts to blink.
- ④ You can press "▲" to change the hour and "▼" to change the minute" and press "OK" to save the time setting. Now the LCD displays "Timer Setting" and returns to step ③ . You can continue to set other timed actions for a whole week and then quit this setting mode.
- ⑤ To cancel a timed action, set the time for this action to 00:00. To cancel all timed actions, press "MODE" + "UNIT" until you hear a long beeping sound.

NOTE: TIMED ON/OFF ACTIONS ARE TRIGGERED WHEN THE TIME OF THE WIRE CONTROLLER REACHES THE SET TIME. THEREFORE, IF THE TIME OF THE WIRE CONTROLLER IS INACCURATE, THE ACTUAL ON/OFF TIME COULD ALSO BE INACCURATE. IN THE TIMING PROCESS, IF YOU DO NOT PRESS ANY KEY IN FIVE SECONDS AFTER PRESSING THE UNIT, MODE, OR PASSWORD BUTTON, THE TIMING PROCESS IS TERMINATED AND THE RESULT IS NOT SAVED. THE DEFAULT TIME SETTING IS 00:00.

5) Manual Defrost

When the unit works in heating mode, press "▲" or "▼" until "Manual Defrosting" appears, and then press "OK" to enter Manual Defrosting mode.

6) Reset

The controller can be reset by sticking the small hole above the "▲" key using a needle-like tool.

**Climaproyectos**
.com

Error Code

S/N	Code	Symptoms	S/N	Code	Symptoms
1	0	0#-slave communication failure	26	43	TH4 temperature sensor malfunction
2	01~14	1# ~14# slave communication failure	27	44	Header pipe water outlet temperature sensor failure
3	16	Overload of compressor/fan in #1	28	45	TH6 temperature sensor malfunction
4	17	Overload of compressor/fan in #2	29	46	TH7 temperature sensor malfunction
5	18	Pump overload	30	47	TH8 temperature sensor malfunction
6	19	Water flow is too small	31	48	TH9 temperature sensor malfunction
7	20	High pressure of #1	32	49	TH10 temperature sensor malfunction
8	21	Low pressure of #1	33	50	TH11 temperature sensor malfunction
9	24	High pressure of #2	34	51	TH12 temperature sensor malfunction
10	25	Temperature of inlet/outlet water is too low	35	52	Low pressure sensor malfunction of #2
11	26	Overload of electric heater in water system	36	53	Low pressure sensor malfunction of #1
12	27	Ambient temperature is too high/low	37	54	Memory failure
13	29	Superheat of #1 is too low	38	60	No system can be started
14	31	and master machine communication failure	39	63	Fan overload failure of System 1
15	32	suction temperature #1 is too high	40	64	Fan overload failure of System 2
16	33	discharge temperature #1 is too high	41	65	Too large water inlet and outlet water temperature difference failure
17	34	suction temperature #2 is too high	42	66	Reverse connection of water inlet and outlet water temperature sensors
18	35	discharge temperature #2 is too high	43	67	Failure of water inlet temperature sensor of the master machine
19	36	Low pressure of #2	44	68	Overload failure of Compressor 2 of System 1
20	37	Superheat of #2 is too low	45	69	Overload failure of Compressor 2 of System 2
21	38	Refrigerant leakage in #1	46	70	Abnormal exhaust temperature of System 1
22	39	Refrigerant leakage in #2	47	71	Abnormal exhaust temperature of System 2
23	40	TH1 temperature sensor malfunction	48	78	Communication failure of all the slave machines
24	41	TH2 temperature sensor malfunction	49	F6	Communication failure between wired controller and master unit
25	42	TH3 temperature sensor malfunction	50	ERRO	Dialing setting error

Error Code and Running Status

■ Characters displayed by the LED indicator are explained in the following table.

Character	Content	Character	Content	Character	Content	Character	Content	Character	Content	Character	Content
0	0/O	2	2	4	4	6	6	8	8	A	A
1	1	3	3	5	5	7	7	9	9	B	B

Character	Content	Character	Content	Character	Content	Character	Content	Character	Content	Character	Content
C	C	E	E	H	H	N	N	R	R	U	U
D	D	F	F	L	L	P	P	T	T	Y	Y

- Codes representing normal operation statuses are explained in the following table.

Code	Status	Code	Status	Code	Status
<i>NULL</i>	NULL: standby	<i>CSP</i>	CSP: shutdown during cooling	<i>HEAT</i>	HEAT: heating
<i>REST</i>	REST: reset	<i>DEF</i>	DEF: defrosting	<i>HSP</i>	HSP: shutdown during heating
<i>COOL</i>	COOL: cooling	<i>ToFS</i>	ToFS: system with changing water flow rate	<i>ToUS</i>	ToUS: system with constant water flow rate



Causes of failures and trouble shooting

S/N	Error Code	Symptom	Possible Cause	Solution
1	Wired controller F6 alarm	Communication failure between wired controller and master unit	1. A/B communication lines of the wired controller and master unit are incorrectly connected.	Check and troubleshoot the communication lines.
			2. The communication line has broken off.	
			3. Communication wires between the wired controller and the master unit cross over strong-current cables.	Rewire the unit, use shielded communication lines or keep the communication lines away from strong current cables.
			4. Control panel of the master unit is not powered on.	Check and troubleshoot the control panel
			5. The communication line between the master unit and the wired controller is too long.	1. Use shield lines 2. Short the JP7 jumper on the control panel
			6. Can communicate with the monitoring software while the wired controller sends out the alarm F6.	Remove resistance R44 on the wire controller or replace the wire controller.
			7. Failure of communication ports on the control panel of the master unit.	Replace
			8. Failure of communication ports on the wired controller.	Replace
			9. Incorrect address setting for the master unit.	Check and troubleshoot the communication lines.
2	The LED indicator of the unit displays ERXX and the wired controller displays XX (XX represents 00 ~ 14)	Communication failure of Slave unit No. XX	1. Communication line of Slave Unit No. XX has broken off	Check communication cables and solve the problem.
			2. The control panel of Slave Unit No. XX is not powered on.	Check and troubleshoot the control panel
			3. Incorrect DIP address setting for the slave unit	Reset the addresses of all slave units and check that there is no duplicate address
			4. The number of slave unit is set incorrectly for the master unit.	Reset the number of slave units and check that the number match with all the addresses
			5. The PC communication port of the slave unit has broken down	1. Exchange positions of the two 485 on Slave Unit No. XX 2. Replace the control panel
			6. The communication line of Slave Unit No. XX is incorrectly connected.	Connect the communication line of Slave Unit No. XX to Apc/Bpc port
3	The LED indicator of the unit displays ER78	Communication failure for all slave units	1. The Bin/Ain communication line of the master unit has broken off	Reconnect the communication line to the Bin/Ain port and screw down the wire terminal
			2. One of the A/B communication lines is connected incorrectly	Check the communication line
			3. The Bin/Ain port of the master unit has broken down	Replace the control panel of the master unit

4	The LED indicator of the unit displays ER16 and the wired controller displays 16	Compressor overload in #1	Over current in the compressor has triggered the overload protector.	<ol style="list-style-type: none"> 1. Check whether the electric current parameter of the overload protector is configured correctly by referring to the electric circuit. 2. Check whether the resistor of the malfunctioned compressor meets specification requirements.
		Fan overload in #1	Over current in the fan has triggered the overload protector.	<ol style="list-style-type: none"> 1. Check whether the electric current parameter of the overload protector is configured correctly by referring to the electric circuit. 2. Check whether the resistor of the malfunctioned fan meets specification requirements.
5	The LED indicator of the unit displays ER17 and the wired controller displays 17	Compressor overload in #2	Over current in the compressor has triggered the overload protector.	<ol style="list-style-type: none"> 1. Check whether the electric current parameter of the overload protector is configured correctly by referring to the electric circuit. 2. Check whether the resistor of the malfunctioned compressor meets specification requirements.
		Fan overload in #2	Over current in the fan has triggered the overload protector.	<ol style="list-style-type: none"> 1. Check whether the electric current parameter of the overload protector is configured correctly by referring to the electric circuit. 2. Check whether the resistor of the malfunctioned fan meets specification requirements.
6	The LED indicator of the unit displays ER18 and the wired controller displays 18	Pump overload	Over current in the pump has triggered the overload protector.	<ol style="list-style-type: none"> 1. Check whether the electric current parameter of the overload protector is configured correctly for the pump by referring to the electric circuit. 2. Check whether the resistor of the malfunctioned pump meets specification requirements.
7	The LED indicator of the unit displays ER19 and the wired controller displays 19	Alarm from the differential water pressure switch	The pump model is too small	Replace the pump
			The water filter is clogged up	Clean the water filter
			Air in the water system is not completely discharged	Turn on the pump to further discharge residual air
			The differential water pressure switch is clogged up	Repair or replace the differential water pressure switch
			The differential water pressure switch has broken down	Replace the differential water pressure switch
			Pressure drop in the water system is too sharp and unbalanced	Optimize the water system
			Other parts in the water system are clogged up	Check and repair

8	The LED indicator of the unit displays ER20 and the wired controller displays 20	High pressure of #1	The motor has broken down (cooling)	Check and troubleshoot
			Circulatory air is shorted (cooling)	
			The heat exchanger needs cleaning (cooling)	
			The fluorine-side filter is clogged up	Check and replace.
			The water temperature is too high (heating)	Tune down the water temperature
			The water flow is too small (heating)	Check and troubleshoot
			The water filter is clogged up (heating)	Clean the water filter.
			The ambient temperature is too high (cooling)	OFF
			Too much refrigerant	Release a proper amount of refrigerant
			Failure of high-voltage modular output port	Replace the module.
			The switch has broken down	Replace the pressure switch.
9	The LED indicator of the unit displays ER21 and the wired controller displays 21	Low pressure of #1	Malfunction of heat exchanger during heating	Check and troubleshoot the outdoor unit
			Malfunction of motor during heating	Check and troubleshoot the outdoor motor
			Insufficient refrigerant or leakage	Check and replenish refrigerant
			Failure of low-voltage modular input port	Replace the module
			The low pressure sensor has broken down	Replace the pressure sensor
10	The LED indicator of the unit displays ER24 and the wired controller displays 24	High pressure of #2	The motor has broken down (cooling)	Check and troubleshoot
			Circulatory air is shorted (cooling)	
			The heat exchanger needs cleaning (cooling)	
			The fluorine-side filter is clogged up	Check and replace.
			The water temperature is too high (heating)	Tune down the water temperature
			The water flow is too small (heating)	Check and troubleshoot
			The water filter is clogged up (heating)	Clean the water filter.
			The ambient temperature is too high (cooling)	OFF
			Too much refrigerant	Release a proper amount of refrigerant
			Failure of high-voltage modular output port	Replace the module.
			The switch has broken down	Replace the pressure switch.
11	The LED indicator of the unit displays ER25 and the wired controller displays 25	Temperature of inlet/outlet water is too low	The temperature of return water is set too low	Change the temperature setting for return water
			The water flow is too small, resulting in a large pressure drop	Check the water system (see item 7 in the table)
12	The LED indicator of the unit displays ER26 and the wired controller displays 26	Overload of electric heater in water system	Check whether the water system is equipped with an electric heater	The heating wire of the electric heater in the water system is shorted
			The heating wire of the electric heater in the water system is shorted	Replace the electric heater of the water system

13	The LED indicator of the unit displays ER27 and the wired controller displays 27	Ambient temperature is too high/low	The ambient temperature sensor has broken down	Replace the ambient temperature sensor
			The ambient temperature is too high/low	OFF
14	The LED indicator of the unit displays ER29 and the wired controller displays 29	Superheat of #1 is too low	The low pressure sensor or temperature sensor has broken down	Replace
			The electronic expansion valve fails to provide proper control	Upgrade the modular program
15	The LED indicator of the unit displays ER31	Communication failure between the master unit and slave units	Communication line of the slave unit has broken off	Check and troubleshoot the communication lines.
			Incorrect DIP address setting for the slave unit	Reset the addresses of all slave units and check that there is no duplicate address
			The number of slave unit is set incorrectly for the master unit	Reset the number of slave units and check that the number match with all the addresses
			The PC communication port of the slave unit has broken down	1. Exchange positions of the two 485 on the slave unit 2. Replace the control panel of the unit"
			The PC communication port of the slave unit has broken down	Connect the communication line of the slave unit to the Apc/Bpc port
16	The LED indicator of the unit displays ER32 and the wired controller displays 32	Temperature of return air in #1 is too high (40°C)	The slider of the 4-way valve is jammed in the middle	Restart the unit and slap slightly on both sides of the 4-way valve. If the problem persists, replace the 4-way valve.
			The winding of the 4-way valve operates abnormally	Replace the winding
			The temperature of discharge air is too high and has triggered the racing protector of the compressor	(see Item 17 in the table)
17	The LED indicator of the unit displays ER33 and the wired controller displays 33	Temperature of discharge air in #1 is too high	The fan motor has broken down (cooling)	Check and troubleshoot the unit
			Circulatory air is shorted (cooling)	
			The heat exchanger needs cleaning (cooling)	
			The electronic expansion valve is not opened as expected (heating)	Check and troubleshoot the electronic expansion valve
			The water temperature is too high	Change the setting for return water temperature (to be performed by service personnel)
			Insufficient refrigerant or leakage	Replenish a proper amount of refrigerant
			Incomplete defrosting	Change the defrosting parameter (to be performed by service personnel)
18	The LED indicator of the unit displays ER34 and the wired controller displays 34	Temperature of return air in #2 is too high (40°C)	The slider of the 4-way valve is jammed in the middle	Restart the unit and slap slightly on both sides of the 4-way valve. If the problem persists, replace the 4-way valve.
			The winding of the 4-way valve operates abnormally	Replace the winding
			The temperature of discharge air is too high and has triggered the racing protector of the compressor	(see Item 19 in the table)

19	The LED indicator of the unit displays ER35 and the wired controller displays 35	Temperature of discharge air in #2 is too high	The fan motor has broken down (cooling)	Check and troubleshoot the unit
			Circulatory air is shorted (cooling)	
			The heat exchanger needs cleaning (cooling)	
			The electronic expansion valve is not opened as expected (heating)	Check and troubleshoot the electronic expansion valve
			The water temperature is too high	Change the setting for return water temperature (to be performed by service personnel)
			Insufficient refrigerant or leakage	Replenish a proper amount of refrigerant
			Incomplete defrosting	Change the defrosting parameter (to be performed by service personnel)
20	The LED indicator of the unit displays ER36 and the wired controller displays 36	Low pressure of #2	Malfunction of heat exchanger during heating	Check and troubleshoot the outdoor unit
			Malfunction of motor during heating	Check and troubleshoot the outdoor motor
			Insufficient refrigerant or leakage	Check and replenish refrigerant
			Failure of low-voltage modular input port	Replace the module
			The low pressure sensor has broken down	Replace the pressure sensor
21	The LED indicator of the unit displays ER37 and the wired controller displays 37	Superheat of #2 is too low	The low pressure sensor or temperature sensor has broken down	Replace
			The electronic expansion valve fails to provide proper control	Upgrade the modular program
22	The LED indicator of the unit displays ER38 and the wired controller displays 38	Refrigerant leakage in #1	Low pressure sensor failure	Replace the low pressure sensor
			Insufficient refrigerant	Add refrigerant
23	The LED indicator of the unit displays ER39 and the wired controller displays 39	Refrigerant leakage in #2	Low pressure sensor failure	Replace the low pressure sensor
			Insufficient refrigerant	Add refrigerant
24	The LED indicator of the unit displays ER40 and the wired controller displays 40	TH1 temperature sensor failure	TH1 temperature sensor is not properly plugged or has broken off	Check the control module and replug the temperature sensor
			TH1 temperature sensor is shorted/open	Test whether the resistance of TH1 sensor meets specification requirements/replace if not
			There is something wrong with the test circuit of the temperature sensor in the control module	Replace the control module
25	The LED indicator of the unit displays ER41 and the wired controller displays 41	TH2 temperature sensor failure	TH2 temperature sensor is not properly plugged or has broken off	Check the control module and replug the temperature sensor
			TH2 temperature sensor is shorted/open	Test whether the resistance of TH2 sensor meets specification requirements/replace if not
			There is something wrong with the test circuit of the temperature sensor in the control module	Replace the control module
26	The LED indicator of the unit displays ER42 and the wired controller displays 42	TH3 temperature sensor failure	TH3 temperature sensor is not properly plugged or has broken off	Check the control module and replug the temperature sensor
			TH3 temperature sensor is shorted/open	Test whether the resistance of TH3 sensor meets specification requirements/replace if not

26	The LED indicator of the unit displays ER42	TH3 temperature sensor failure	There is something wrong with the test circuit of the temperature sensor in the control module	Replace the control module
27	The LED indicator of the unit displays ER43	TH3 temperature sensor failure	TH4 temperature sensor is not properly plugged or has broken off	Check the control module and replug the temperature sensor
			TH4 temperature sensor is shorted/open	Test whether the resistance of TH4 sensor meets specification requirements/replace if not
			There is something wrong with the test circuit of the temperature sensor in the control module	Replace the control module
28	The LED indicator of the unit displays ER44	TH5 temperature sensor failure	TH5 temperature sensor is not properly plugged or has broken off	Check the control module and replug the temperature sensor
			TH5 temperature sensor is shorted/open	Test whether the resistance of TH5 sensor meets specification requirements/replace if not
			There is something wrong with the test circuit of the temperature sensor in the control module	Replace the control module
29	The LED indicator of the unit displays ER45	TH6 temperature sensor failure	TH6 temperature sensor is not properly plugged or has broken off	Check the control module and replug the temperature sensor
			TH6 temperature sensor is shorted/open	Test whether the resistance of TH6 sensor meets specification requirements/replace if not
			There is something wrong with the test circuit of the temperature sensor in the control module	Replace the control module
30	The LED indicator of the unit displays ER46	TH7 temperature sensor failure	TH7 temperature sensor is not properly plugged or has broken off	Check the control module and replug the temperature sensor
			TH7 temperature sensor is shorted/open	Test whether the resistance of TH7 sensor meets specification requirements/replace if not
			There is something wrong with the test circuit of the temperature sensor in the control module	Replace the control module
31	The LED indicator of the unit displays ER47	TH8 temperature sensor failure	TH8 temperature sensor is not properly plugged or has broken off	Check the control module and replug the temperature sensor
			TH8 temperature sensor is shorted/open	Test whether the resistance of TH8 sensor meets specification requirements/replace if not
			There is something wrong with the test circuit of the temperature sensor in the control module	Replace the control module
32	The LED indicator of the unit displays ER48	TH9 temperature sensor failure	TH9 temperature sensor is not properly plugged or has broken off	Check the control module and replug the temperature sensor
			TH9 temperature sensor is shorted/open	Test whether the resistance of TH9 sensor meets specification requirements/replace if not
			There is something wrong with the test circuit of the temperature sensor in the control module	Replace the control module
33	The LED indicator of the unit displays ER49	TH10 temperature sensor failure	TH10 temperature sensor is not properly plugged or has broken off	Check the control module and replug the temperature sensor
			TH10 temperature sensor is shorted/open	Test whether the resistance of TH10 sensor meets specification requirements/replace if not
			There is something wrong with the test circuit of the temperature sensor in the control module	Replace the control module

34	TH11 temperature sensor failure	TH11 temperature sensor is not properly plugged or has broken off	Check the control module and replug the temperature sensor	Check the control module and properly insert the temperature.
			TH11 temperature sensor is shorted/open	Test whether the resistance of TH11 sensor meets specification requirements/replace if not
			There is something wrong with the test circuit of the temperature sensor in the control module	Replace the control module
35	TH12 temperature sensor failure	TH12 temperature sensor is not properly plugged or has broken off	Check the control module and replug the temperature sensor	Check the control module and properly insert the temperature.
			TH12 temperature sensor is shorted/open	Test whether the resistance of TH12 sensor meets specification requirements/replace if not
			There is something wrong with the test circuit of the temperature sensor in the control module	Replace the control module
36	The LED indicator of the unit displays ER52	Low pressure sensor failure of #2	Three lines of the low pressure sensor is incorrectly connected	Reconnect the connecting lines of the low pressure sensor
			The low pressure sensor is shorted/open	Repair or replace the lines of the low pressure sensor
			The Low pressure sensor has broken down	Replace the low pressure sensor
			There is something wrong with the test circuit of the low pressure sensor in the control module	Replace the control module
37	The LED indicator of the unit displays ER53	Low pressure sensor failure of #1	Three lines of the low pressure sensor is incorrectly connected	Reconnect the connecting lines of the low pressure sensor
			The low pressure sensor is shorted/open	Repair or replace the lines of the low pressure sensor
			The Low pressure sensor has broken down	Replace the low pressure sensor
			There is something wrong with the test circuit of the low pressure sensor in the control module	Replace the control module
38	The digital pipe of the unit displays ER54	Memory failure	Memory damage	Replace the control module
39	The digital pipe of the unit displays ER60	No system can be started	SYS1 and SYS2 cannot be automatically recovered	Check the failures of SYS1 SYS2 and recover
40	The digital pipe of the unit displays ER63	Fan overload failure of System 1	The running current of the fan is too large. Action of overload protector	<ol style="list-style-type: none"> 1. According to the circuit diagram, check whether the setting value of current of the corresponding overload protector is correct; 2. Check whether the resistance of the corresponding fan is abnormal.
41	The digital pipe of the unit displays ER64	Fan overload failure of System 2	The running current of the fan is too large. Action of overload protector	<ol style="list-style-type: none"> 1. According to the circuit diagram, check whether the setting value of current of the corresponding overload protector is correct; 2. Check whether the resistance of the corresponding fan is abnormal.
42	The digital pipe of the unit displays ER65	The water inlet and water outlet temperature difference is too large	The water flow is too small	Check whether the water flow of water system is normal
			TH6 and TH7 falls off	Check whether TH6 and TH7 are inserted reversely/fall off
			Detection circuit problem of control module temperature sensor	Replace the control module

43	The digital pipe of the unit displays ER66	Reverse connection of water inlet and outlet water temperature sensors	TH6 and TH7 are inserted reversely or fall off	Check whether TH6 and TH7 are inserted reversely/fall off
			Detection circuit problem of control module temperature sensor	Replace the control module
44	The digital pipe of the unit displays ER67	Failure of water inlet temperature sensor of the master machine	TH6 Temperature Sensor falls off or is not inserted well	Check the control module and insert the temperature sensor
			If TH6 Temperature Sensor has short circuit/open circuit	determine whether the resistance on both ends of the TH9
			Detection circuit problem of control module temperature sensor	Sensor is normal with the multimeter/Replace
45	The digital pipe of the unit displays ER68	Overload failure of Compressor 2 of System 1	The running current of the compressor is too large. Action of overload protector	<ol style="list-style-type: none"> 1. According to the circuit diagram, check whether the setting value of current of the corresponding overload protector is correct 2. Check whether the resistance of the corresponding compressor is abnormal.
46	The digital pipe of the unit displays ER69	Overload failure of Compressor 2 of System 2	The running current of the compressor is too large. Action of overload protector	<ol style="list-style-type: none"> 1. According to the circuit diagram, check whether the setting value of current of the corresponding overload protector is correct 2. Check whether the resistance of the corresponding compressor is abnormal.
47	The digital pipe of the unit displays ER70	Abnormal exhaust temperature of System 1	The exhaust temperature of compressor is too high	To Shut down or manually reset to remove alarm
48	The digital pipe of the unit displays ER71	Abnormal exhaust temperature of System 2	The exhaust temperature of compressor is too high	To Shut down or manually reset to remove alarm
49	The digital pipe of the unit displays ERRO	Dialing setting error	Dialing setting error on the module	According to the circuit diagram, complete the dialing setting again

Warning

- Daikin Industries, Ltd.'s products are manufactured for export to numerous countries throughout the world. Daikin Industries, Ltd. does not have control over which products are exported to and used in a particular country. Prior to purchase, please therefore confirm with your local authorized importer, distributor and/or retailer whether this product conforms to the applicable standards, and is suitable or use, in the region where the product will be used. This statement does not purport to exclude, restrict or modify the application of any local legislation.
- Ask a qualified installer or contractor to install this product. Do not try to install the product yourself. Improper installation can result in water or refrigerant leakage, electrical shock, fire or explosion.
- Use only those parts and accessories supplied or specified by Daikin. Ask a qualified installer or contractor to install those parts and accessories. Use of unauthorized parts and accessories or improper installation of parts and accessories can result in water or refrigerant leakage, electrical shock, fire or explosion.
- Read the User's Manual carefully before using this product. The User's Manual provides important safety instructions and warnings. Be sure to follow these instructions and warnings.

If you have any enquiries, please contact your local importer, distributor and/or retailer.

Climaproyectos
.com



The air conditioners manufactured by Daikin Industries have received **ISO 9001 series** certification for quality assurance.

Certificate Number. 9601019



The airconditioning factories of Daikin Industries have received environmental management system standard **ISO 14001** certification.

Certificate Number. EMS80362

Cautions on product corrosion

1. The units should not be installed in areas where corrosive gases, such as acid gas or alkaline gas, are produced.
2. If the unit is to be installed close to the sea shore, direct exposure to the sea breeze should be avoided. If you need to install the unit close to the sea shore, contact your local distributor.

Dealer

DAIKIN INDUSTRIES, LTD.

Head Office:
Umeda Center Bldg., 2-4-12, Nakazaki-Nishi,
Kita-ku, Osaka, 530-8323 Japan
http://www.daikin.com/global_ac/

© All rights reserved

Literature No.: ED-UAL-A5-1603
Supersedes: ED-UALA5-1502