

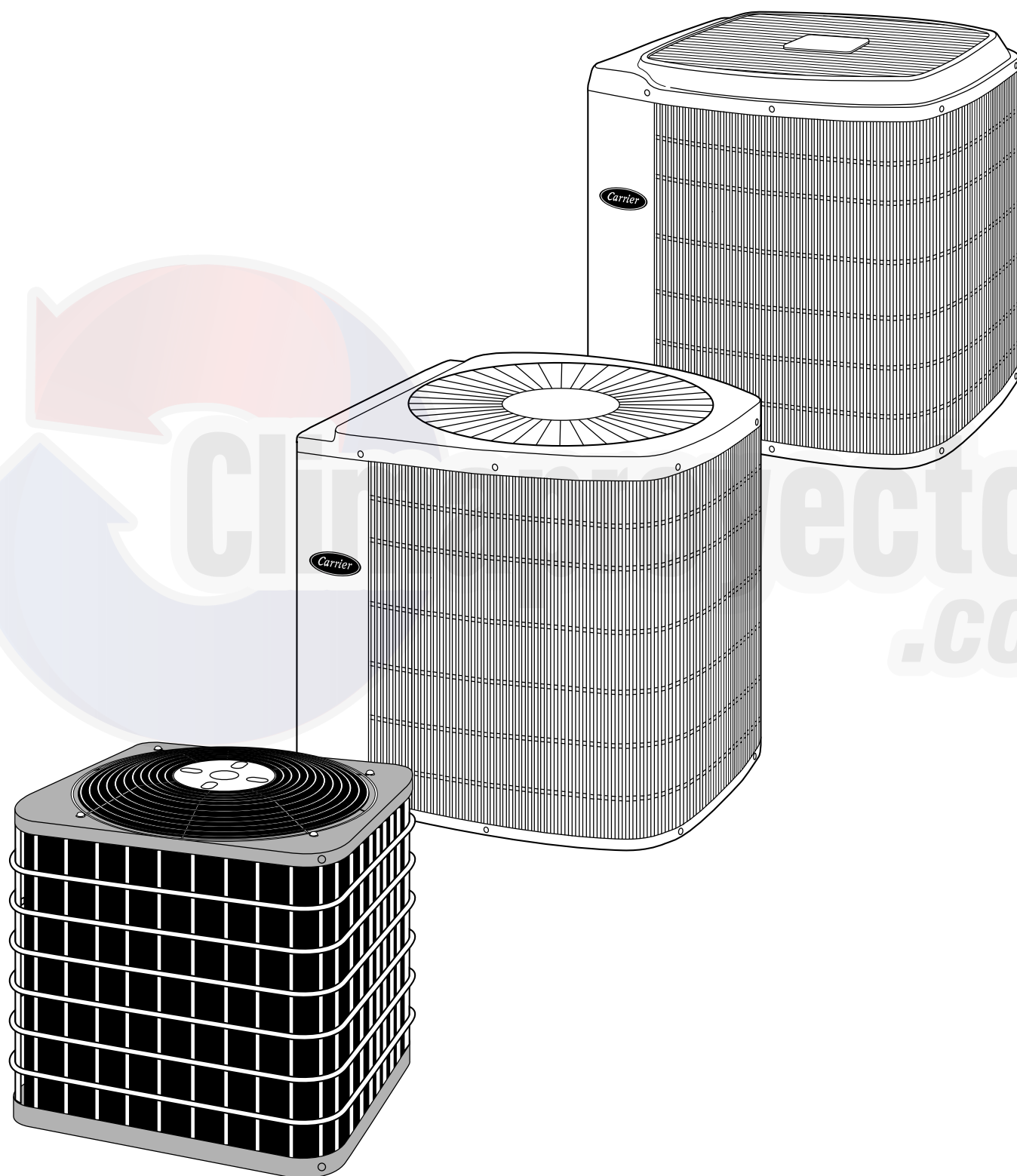

HEATING & COOLING

CENTRAL AIR CONDITIONER

A GUIDE TO OPERATING AND MAINTAINING YOUR RESIDENTIAL AIR CONDITIONING UNIT.



NOTE TO INSTALLER: THIS MANUAL SHOULD BE LEFT WITH THE EQUIPMENT USER.

WELCOME TO EFFICIENT HOME COOLING COMFORT

Congratulations on your excellent choice and sound investment in home cooling comfort!

Your new air conditioning unit represents both the latest in engineering development and the culmination of many years of experience from one of the most reputable manufacturers of comfort systems.

Your new unit is among the most energy-efficient and reliable air conditioning products available today. To assure its dependability, spend just a few minutes with this booklet now. Learn about the operation of your air conditioner, and the small amount of maintenance it takes to keep it operating at its peak efficiency.

With minimal care, your new air conditioner will provide you and your family with cool comfort—both now and for years to come.

SAFETY CONSIDERATION

Recognize safety information. This is the safety-alert symbol . When you see this symbol on the unit or in instructions and manuals, be alert to the potential for personal injury.

Understand the signal word DANGER, WARNING, or CAUTION. These words are used with the safety-alert symbol. DANGER identifies the most serious hazards which **will** result in severe personal injury or death. WARNING signifies hazards that **could** result in personal injury or death. CAUTION is used to identify unsafe practices which **would** result in minor personal injury or product and property damage.

WARNING

Improper installation, adjustment, alteration, service, maintenance, or use can cause explosion, fire, electrical shock, or other conditions which may cause personal injury or property damage. Consult a qualified installer, service agency, or your distributor or branch for information or assistance. The qualified installer or agency must use factory-authorized kits or accessories when modifying this product.

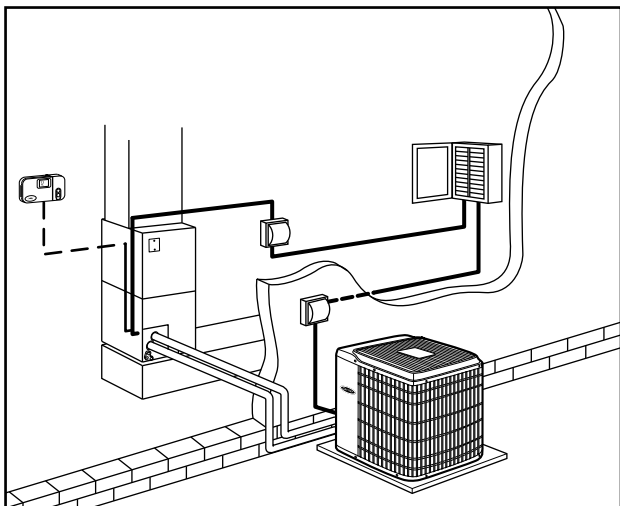

Fig.1—Typical Split-System Installation

WARNING

To prevent personal injury, death, or property damage, read and follow all instructions and warnings, including labels shipped with or attached to the unit before operating your new air conditioner.

YOUR COMFORT SYSTEM

Identifying Your System

Take the time to familiarize yourself with the type of system you have. This knowledge will be of use in understanding the basic operation of your new air conditioner.

The split-system type has an indoor and an outdoor unit, each of which contains a coil. These units are interconnected by refrigerant tubes. (See Fig. 1.)

Each unit has a rating plate affixed to it which provides necessary information for specific identification of a unit. You should familiarize yourself with the product, model, and serial numbers listed on each rating plate. Record them for future reference on the last page of this booklet.

IMPORTANT FACTS

To better protect your investment and to eliminate unnecessary service calls, familiarize yourself with the following facts:

- Your air conditioning system should never be operated without a clean air filter properly installed. Plan to inspect the filter periodically. A clogged air filter will increase operating costs and shorten the life of the unit.
- Supply-air and return-air registers should not be blocked. Drapes, furniture, and toys are some of the items commonly found obstructing grilles. Restricted airflow lessens the unit's efficiency and life span.
- The outdoor unit must have unrestricted airflow. Do not cover the unit, lean anything against it, or stand on it. Do not allow grass clippings, leaves, or other debris to accumulate around or on top of the unit. Maintain a 12-in. minimum clearance between the outdoor unit and tall grass, vines, shrubs, etc.
- Your multipurpose indoor thermostat is the control center for your air conditioning system. You should familiarize yourself with its proper operation. Attempting to control the system by other means—for instance, switching the electrical supply power ON and OFF—may cause damage to the unit.
- Thermostat “jiggling” causes rapid-cycling, which is potentially damaging to the compressor. Do not move the temperature selector on the thermostat for any reason for at least 5 minutes after the compressor has shut off.
- You may find that you can maintain greater personal comfort by running the fan continuously. Air pockets can form due to the structure of the house, placement of registers, etc. These air pockets may be too cool or warm for your liking. Continuous fan operation minimizes any temperature differences. Also, systems equipped with electronic or mechanical air cleaners and/or humidifiers offer the added benefits of having the air continuously cleaned year-round, and humidified during the winter season.
- A system equipped with a heat or energy recovery ventilator offers the advantage of exhausting stale air from the home and allowing fresh air in from the outdoors while minimizing heat loss.

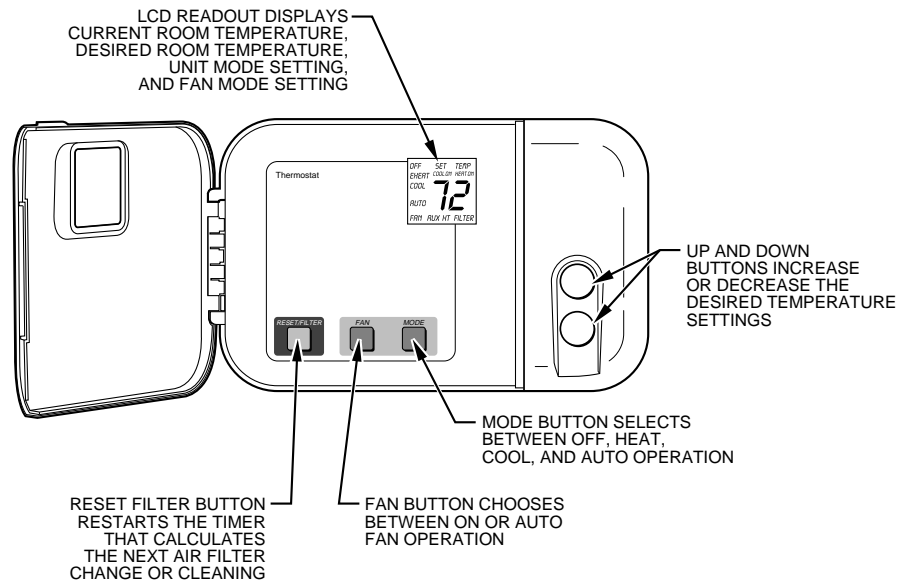

Fig. 2—Carrier Non-Programmable Thermostat

- Your system may also be equipped with a zoning system which allows individual control over the temperatures of separate areas of your home.
- Your air conditioner removes humidity from your home during the cooling season. After a few minutes of operation, you should be able to see water trickle from the condensate drain of the cooling coil. Check this occasionally to be sure the drain system is not clogged. Of course, don't expect to see much drainage if you live in a very dry environment.
- Do not operate your unit when outdoor temperatures are below 55°F.

OPERATING YOUR AIR CONDITIONER

The operation of your air conditioning system is controlled by the indoor thermostat. You simply adjust the thermostat and it maintains the indoor temperature at the level you select. Most

thermostats have three controls: a temperature control selector, a FAN control, and a SYSTEM or MODE control.

The temperature control selector can be a dial, lever, or set of buttons that allows you to establish the degree of temperature you wish to maintain for your personal comfort. Some thermostats possess two temperature control selectors: one for setting the temperature desired for cooling operation, and one for setting the temperature desired for heating operation.

The FAN control offers two options for controlling the indoor blower: AUTO and ON. When set to AUTO, the blower runs only while the thermostat operates the cooling or heating equipment. When set to ON, the blower runs continuously—regardless of whether the cooling or heating equipment is operating.

Typically, the SYSTEM or MODE control on your thermostat offers the following selections: COOL, OFF, and HEAT. Your thermostat may also have a fourth selection, AUTO. Neither the cooling nor heating equipment will operate when the SYSTEM

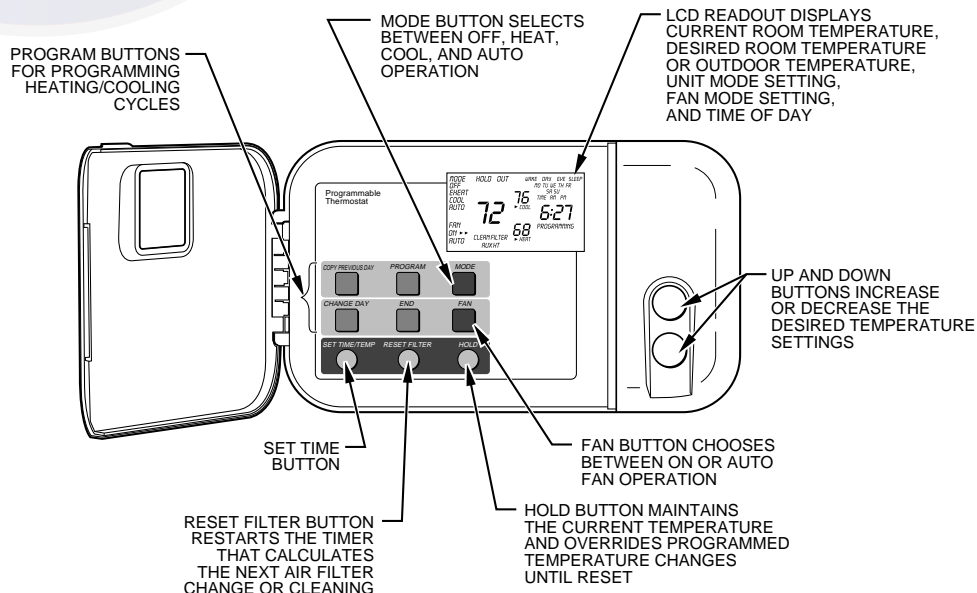

Fig. 3—Carrier Programmable Thermostat

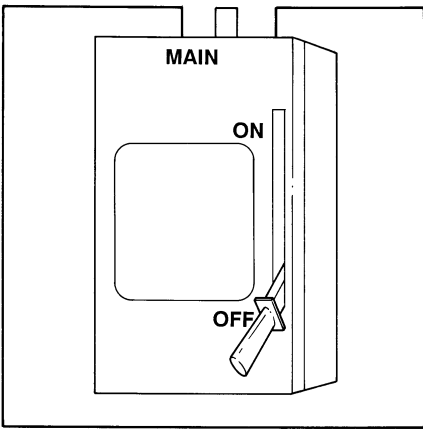

Fig. 4—Main Electrical Disconnect

or MODE control is set to OFF. With the SYSTEM or MODE control set to COOL, your air conditioner will operate when the indoor temperature rises above the level that you wish to maintain. With the SYSTEM or MODE control set to HEAT, the heating unit of your home comfort system will operate automatically when indoor temperature falls below the level that you have selected.

The AUTO selection found on some thermostats provides for automatic changeover between cooling and heating equipment operation. With the SYSTEM or MODE control set to AUTO, your air conditioner will operate when the indoor temperature rises above the thermostat cooling temperature setting, or the heating section will operate when the indoor temperature drops below the thermostat setting for the heating cycle.

Your thermostat may be PROGRAMMABLE or NON-PROGRAMMABLE. A NON-PROGRAMMABLE thermostat does not allow the temperature settings to be varied throughout the day or week without physically changing the settings. A PROGRAMMABLE thermostat allows various daily temperature changes to be preset. During the winter, for example, you may wish to set back the temperature of your home at night, then have the temperature return to normal prior to waking up. The home's temperature can then be lowered again during the day when no one is at home, but again be at peak comfort level when your family returns home. During the summer, the opposite changes might be programmed. When properly used, the programming can result in energy savings on your home's heating and cooling.

COOLING MODE

When operating in cooling mode, your air conditioner runs until the indoor temperature is lowered to the level you have selected. On extremely hot days, your conditioner will run for longer periods at a time and have shorter off periods than on moderate days.

The following are typical conditions that add extra heat and/or humidity to your home and force your cooling unit to work longer to keep your home comfortable:

- Entrance doors are frequently opened and closed.
- Laundry appliances are being operated.
- A shower is running.
- More than the usual number of people are present in the home.
- More than the normal number of electric lights are in use.
- Drapes are open on the sunny side of the home.

HEATING MODE

With the SYSTEM or MODE control of your indoor thermostat set to HEAT, the heating unit of your home comfort system operates until room temperature is raised to the level you have selected. Of course, the heating unit will have to operate for longer periods to maintain a comfortable environment on cooler days and nights than on moderate ones.

Refer to your heating unit User's Manual for specific information on heating operation.

PERFORMING ROUTINE MAINTENANCE

With the proper maintenance and care, your air conditioning unit will operate economically and dependably. Maintenance can be accomplished easily by referring to the following directions. However, before performing maintenance, consider these important safety precautions:

⚠ WARNING

To prevent personal injury or death disconnect all electrical power to the indoor air handler or furnace before removing access panels or performing any maintenance. Disconnect power to both the indoor and outdoor units. NOTE: There may be more than 1 electrical disconnect switch.

⚠ CAUTION

Although special care has been taken to minimize sharp edges in the construction of your unit, be extremely careful when handling parts or reaching into the unit.

CHECK THE AIR FILTER

A dirty air filter will cause excessive strain on the compressor and blower motor. This can cause the components to overheat and automatically shut down. In the worst case, these components will fail and need to be replaced. To avoid inefficient or

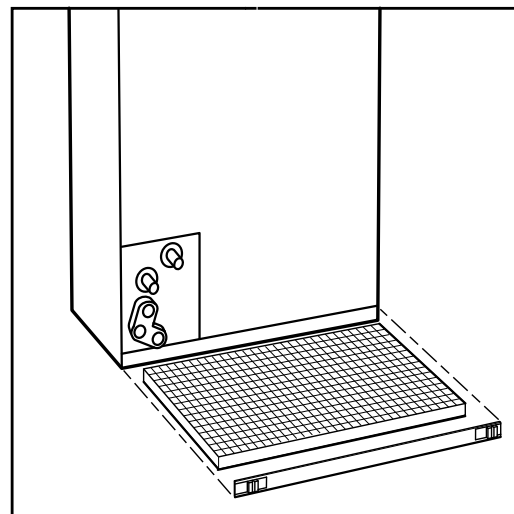

Fig. 5—Removing Filter from Fan Coil Unit

failed operation of your unit, **CHECK THE FILTER(S) EVERY 3 TO 4 WEEKS.** Replace filter(s) when necessary, or clean the filter(s) if you have the reusable type.

Disposable filters should be replaced by similar, new filters of the same dimensions.

Reusable, permanent filters should be washed in a solution of cold water and mild detergent, then rinsed and thoroughly dried. **THE FILTER MUST BE COMPLETELY DRY BEFORE BEING REINSTALLED.** To avoid prolonged shutdown of your unit while a filter is drying, you should have an extra filter on hand. This allows you to rotate between the two with minimal downtime for your comfort system. Extra filters may be purchased from your dealer.

There are no filters in the outdoor unit of a split-system. If your indoor unit is a gas or oil furnace, refer to your furnace User's Manual for filter location and procedures for replacement or cleaning.

If your system includes an indoor fan coil unit, the filter may be located in the unit where it connects with the return-air duct or plenum. (See Fig. 5.) Remove the filter cover plate by sliding latches toward center of plate. Lift filter to clear lower flange. Filter is spring-loaded and will pop out. Reinstall filter, being certain to secure filter behind lower flange. When reinstalling cover plate, secure plate behind upper flange then slide tabs outward.

The indoor fan coil unit may be located in the attic. In this instance the filter could be located behind the return air grille. Access the filter by removing two screws from return air grille.

If your system includes an electronic air cleaner, refer to air cleaner user's manual for proper filter cleaning or replacement.

INDOOR COIL

If the split-system coil has only been operated with a clean filter in place, it should require minimal cleaning.

If coil cleaning is required, call your dealer for service. It may be necessary to clean the coil with a detergent solution and rinse it with water. This could require the removal of the coil. You should not attempt this yourself.

OUTDOOR COIL

If grass clippings, leaves, shrubbery, and debris are kept away from the outdoor unit, minimal care should be sufficient to keep the system functioning properly. For proper drainage, debris must be removed periodically from the base pan. However, if the outdoor coil becomes dirty, use a vacuum cleaner with soft brush attachment to clean the exterior surface. Vacuum coil surface using an up and down motion. Be careful not to bend or damage coil fins.

If dirt is deep in the coil, contact your dealer for service. The outdoor fan motor may have to be disconnected and the top panel removed to gain access to the coil for thorough cleaning. Do not attempt this yourself.

OUTDOOR COIL—SEA COAST

If your unit is located near the ocean, special maintenance is required. Ocean mist/breeze carries salt, which is corrosive to most metals. Although your new unit is made out of galvanized metal and is protected by top-grade paint, you should take the precaution of additional maintenance which consists of periodically washing the unit. By washing all exposed surfaces and coil

approximately every 3 months, you will be adding additional life to your unit. Consult your installing contractor for proper intervals/procedures for your geographic area or service contact.

UNIT SUPPORT

Your split-system outdoor unit should be maintained in a level position. If its support should shift or settle so that the unit is no longer level, you should correct the condition. Relevel it promptly to assure that water drains out of the unit. If you notice that water or ice collects beneath the unit, arrange for it to be drained away from the unit.

BEFORE YOU REQUEST A SERVICE CALL

CHECK FOR THESE EASILY SOLVED PROBLEMS:

- Check the indoor and outdoor disconnect switches. Verify that circuit breakers are ON or that fuses have not blown.
- Check for sufficient airflow. Check the air filter(s) for any accumulations of dirt. Check for blocked return-air or supply-air registers. Be sure registers are open and unobstructed.
- Check the settings on your indoor thermostat. If you desire cooling, make sure that the temperature control selector is set below room temperature and the SYSTEM or MODE control is set to COOL or AUTO. If you require warmth, make sure that the temperature control selector is set above room temperature and the SYSTEM or MODE control is set to HEAT or AUTO. The FAN control should be set to ON for continuous blower operation or AUTO if you wish blower to function only while the heating or cooling equipment is operating.

If your comfort system still fails to operate, turn your system off and contact your servicing dealer for troubleshooting and repairs. Specify your apparent problem, and state the model and serial numbers of your equipment. (You should have them recorded on the last page of this booklet.) With this information, your dealer may be able to offer helpful suggestions over the phone or save valuable time through knowledgeable preparation for the service call.

REGULAR DEALER MAINTENANCE

In addition to the routine maintenance that you perform, your home comfort system should be inspected regularly by a properly trained service technician. The inspection (preferably each year, but at least every other year) should include the following:

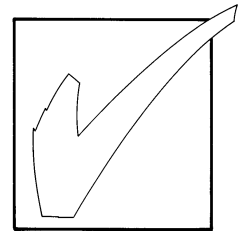

- Routine inspection of air filter(s). Replacement or cleaning as required.
- Inspection and cleaning of the blower wheel, housing, and motor.
- Inspection and, if required, cleaning of indoor and outdoor coils.
- Inspection of the indoor coil drain pan, plus the primary and secondary drain lines. If supplied, the auxiliary drain pan and line should be inspected at this time. Service should include cleaning if required.

- A check of all electrical wiring and connections.
- A check for secure physical connections of individual components within units.
- Operational check of the air conditioning system to determine actual working condition. Necessary repair and/or adjustment should be performed at this time.

Your servicing dealer may offer an economical service contract that covers seasonal inspections. Ask for further details.

FOR THE RECORD

Record the model, product, and serial numbers of your new equipment in the spaces provided on the last page. This information, along with the other ready-reference facts requested, will be necessary should you ever require information or service.





INSTALLATION DATA

Date Installed _____
Dealer Name _____
Address _____
City _____
State _____ Zip _____
Telephone _____

MODULAR INDOOR UNIT, if Applicable:

Blower—Product No. _____
Model No. _____
Serial No. _____

Coil—Product No. _____
Model No. _____
Serial No. _____

SPLIT-SYSTEM

OUTDOOR UNIT:

Product No. _____
Model No. _____
Serial No. _____

Heater—Product No. _____
Model No. _____
Serial No. _____

ACCESSORIES

INDOOR UNIT OR COIL:

Product No. _____
Model No. _____
Serial No. _____

Product No. _____
Product No. _____
Product No. _____
Product No. _____
Product No. _____



HEATING & COOLING

TO OBTAIN INFORMATION ON PARTS: Consult your installing dealer or classified section of your local telephone directory under the "Heating Equipment" or "Air Conditioning Contractors & Systems" heading for dealer listing by brand name. Have available the Model No., Series Letter, & Serial No. of your equipment to ensure correct replacement part.

Carrier Corporation • Indianapolis, IN 46231

Manufacturer reserves the right to discontinue, or change at any time, specifications or designs without notice and without incurring obligations.