

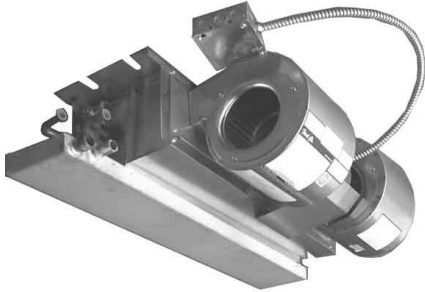

PRODUCT SPECIFICATIONS
 *HBC(X) *PHBC(X) *RHBC(X) *CHBC(X)
 Chilled Water/Hot Water 2-pipe/4-Pipe



Ceiling Concealed

HBC SERIES-PSC MOTOR
HBCX SERIES-ECM MOTOR

Horizontal

300-1200 CFM

- Ceiling Concealed
- Ceiling Recessed
- Ceiling Exposed

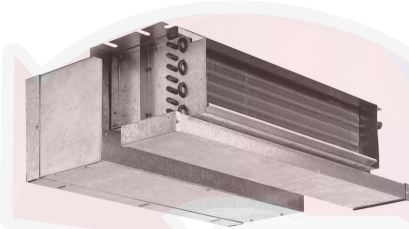

Ceiling Concealed with Plenum

- **HIGH EFFICIENCY**
- **HIGH PERFORMANCE**

ECM Motor Options

The ECM motor option includes 24V controls, a constant torque, permanent magnet, brushless DC motor, with 4 discrete speed taps that allow for high static applications and precise air balancing



Ceiling Recessed

MERV 8

LOUVERED ACCESS PANELS

Page 29

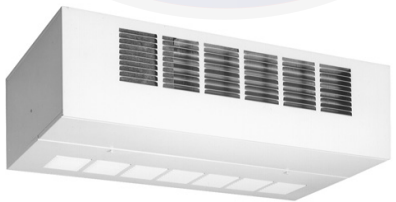

Ceiling Exposed



First Company
 P.O. Box 270969
 Dallas, TX 75227
 Ph. (214)-388-5751
 www.firstco.com

Table of Contents	2
Nomenclature	2
Features	3
Physical Data	4-7
Cooling Performance	8-10
Heating Performance	11
Correction Factors	12
Blower Performance PSC Motor	13-22
Blower Performance ECM Motor	23-26
Guide Specifications	27-28
Access/Filter Panels	29
Accessories	30-31

Blower Performance Tables (PSC Motor)

120/1/60		
HBC		13
PHBC (With Plenum)		14
RHBC (Recessed with Panel)		15

277/1/60

HBC		16
PHBC (With Plenum)		17
RHBC (Recessed with Panel)		18

220/1/50

HBC		19
PHBC (With Plenum)		20
RHBC (Recessed with Panel)		21
CHBC (Cabinet Exposed)	All Voltages	22

Blower Performance Tables (ECM Motor)

(120/1/60)

HBCX	3-Row	23
PHBCX	3-Row (With Plenum)	24
RHBCX	3-Row (Recessed with Panel)	25
CHBCX	3-Row (Cabinet Exposed)	26
HBCX	4-Row	23
PHBCX	4-Row (With Plenum)	24
RHBCX	4-Row (Recessed with Panel)	25
CHBCX	4-Row (Cabinet Exposed)	26
HBCX	32-Row	25
CHBCX	32-Row (Cabinet Exposed)	26
HBCX -277	4-Row	27

MODEL NOMENCLATURE

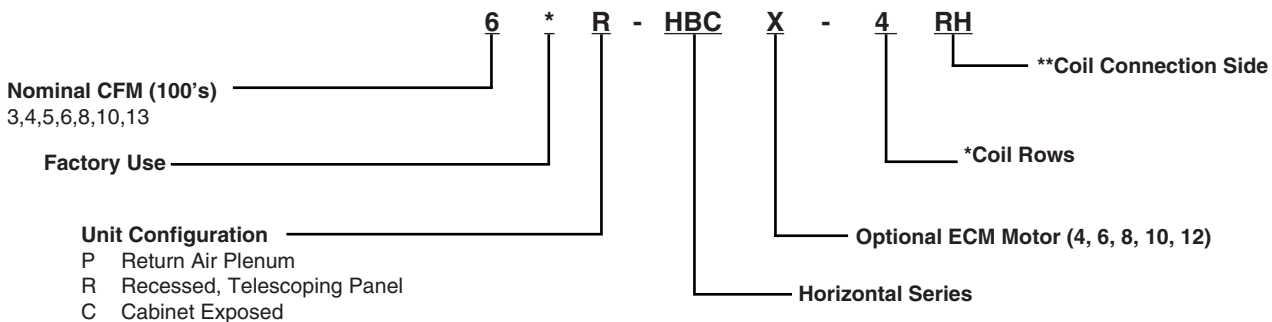

**Coil Connection Side

RH Right Hand (default)
LH Left Hand
Hand connection is determined by
looking with airflow

*Coil Configurations

Rows	Description
3	2-Pipe 3 Row
4	2-Pipe 4 Row
31	4-Pipe 3 Row Cooling, 1-Row Hot Water
32	4-Pipe 3 Row Cooling, 2-Row Hot Water
41	4-Pipe 4 Row Cooling, 1-Row Hot Water

Available Voltage (PSC Motors)

120V/1/60
208-230V/1/60
220V/1/50
277V/1/60

Available Voltage (ECM Motors)

120V/1/60



NEW! ECM Motor Option

This new ECM motor option includes 24V controls, a constant torque, permanent magnet, brushless DC motor, with 4 discrete speed taps that allow for precise air balancing.

Standard Features

Basic Unit - All fan coils are manufactured with heavy gauge galvanized steel to resist corrosion. All models are approved for installation with "0" clearance to combustible material.

Insulation - Plenums and cabinets are insulated with Tuf-Skin dual density fiber glass blanket insulation with an anti-microbial agent.

Ceiling Panels - Hinged access/return panels are manufactured with heavy gauge galvanized steel with captive mounting screws and an attractive white baked powder finish.

Condensate Pans - Positive sloped drain pans are galvanized steel, coated on the inside surface with a U.L. Listed closed cell, fire retardant, foam insulation. Pan includes both primary and secondary drain connections.

Return Air Plenums - Return air plenums are manufactured from galvanized steel insulated with Tuf-Skin dual density fiber glass blanket insulation and a 1" TA fiber glass filter.

Coils - Constructed with seamless copper tubes and headers. The tubes are mechanically expanded into corrugated aluminum fin material for a permanent primary to secondary surface bond. Coils are tested under water at 350 PSI for operation at 300 PSI. Coils include manual air vents.

Fan Wheels-Housing - are double width, double inlet (DWDI) forward curved, centrifugal type. Wheels are statically and dynamically balanced for smooth, quiet operation. The housing is constructed from heavy gauge galvanized steel with die-formed inlet cones.

Motors - Standard motors are PSC, permanently lubricated type with internal thermal overload protection.

Options

Factory mounted options include ECM motors 120V only, stainless steel drain pans, foil faced cabinet insulation, Multi-24 3-speed 24V control, valve packages, thermostats, aqua stats, service switches. 120V, 208V/240V, 277V, 60hz and (220/50hz, PSC MOTORS ONLY)



*HBC(X) Series - Ceiling Concealed

The * HBC series is designed for fully concealed applications. This 10" high space saving unit provides easy access for service and maintenance.

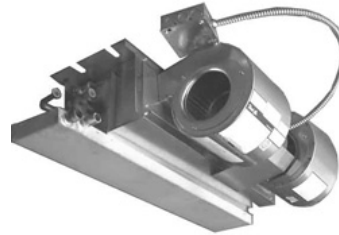

*PHBC(X) Series - Ceiling Concealed with Plenum

The * HBC series is designed for fully concealed applications. This 10" high space saving unit provides easy access for service and maintenance.

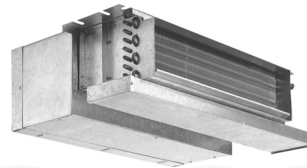

***RHBC(X) Series - Ceiling Recessed** includes adjustable hinged access/return panel with 1" TA fiber glass filter. The cabinet allows for a field mounted rear return duct connection by using a solid access panel.

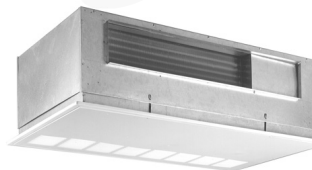

***CHBC(X) Series - Ceiling Recessed** cabinet with an attractive baked powder finish. Cabinet includes stamped discharge opening and hinged bottom panel with 1" TA fiber glass filter.

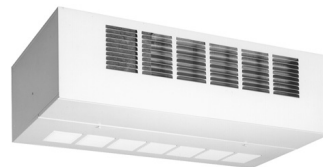

*Factory use
(X) Denotes with ECM motor

Product Specifications

Horizontal Fan Coils
2-Pipe/4-Pipe Hydronic

*HBC PHYSICAL DATA

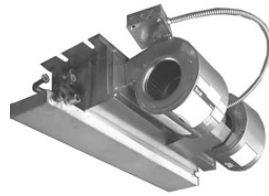
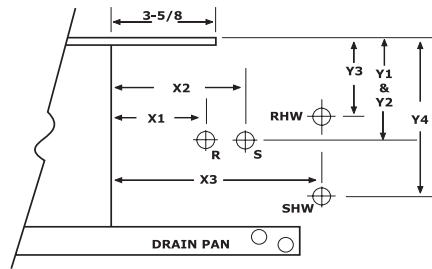

LEFT HAND MODEL SHOWN

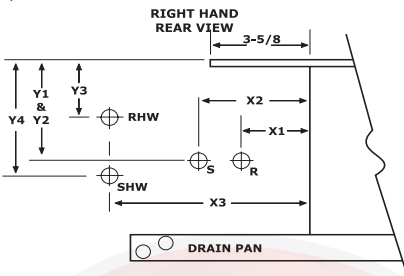

RIGHT HAND REAR VIEW

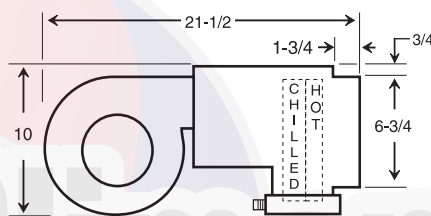

4 - PIPE UNIT SHOWN

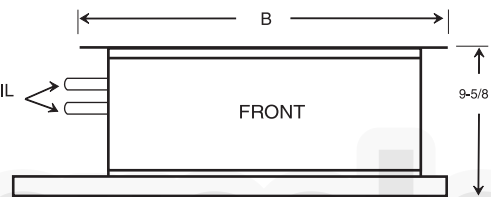
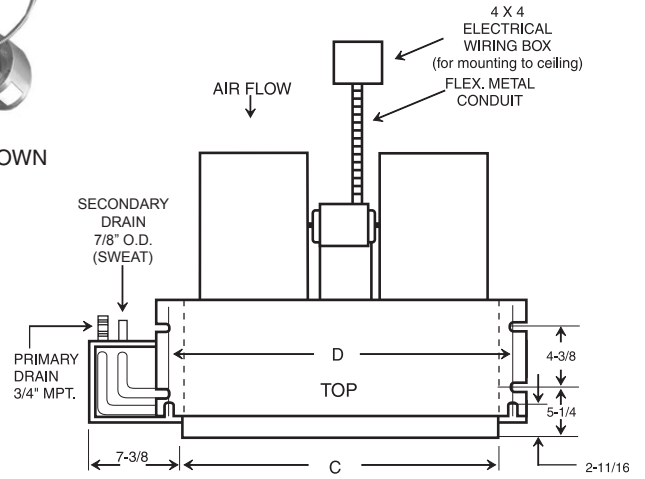

NOTE: RIGHT HAND MODEL SHOWN - LEFT HAND MODEL HAS DRAIN AND PIPING CONNECTIONS ON OPPOSITE SIDE OF FAN COIL.

GENERAL DIMENSIONS				
MODEL	A	B	C	D
3*HBC	30-1/8	27-1/4	20-1/8	25-1/4
4*HBC(X)	36-1/8	33-1/4	26-1/8	31-1/4
5*HBC	40-1/8	37-1/4	30-1/8	35-1/4
6*HBC(X)	40-1/8	37-1/4	30-1/8	35-1/4
8*HBC(X)	46-1/8	43-1/4	36-1/8	41-1/4
10*HBC(X)	52-1/8	49-1/4	42-1/8	47-1/4
12*HBC(X)	59-1/8	56-1/4	49-1/8	54-1/4
13*HBC	59-1/8	56-1/4	49-1/8	54-1/4

(X)- Available with ECM motor

NOTES:

- 1) ALL DIMENSIONS IN INCHES.
- 2) COIL CONNECTION TOLERANCE $\pm 1/4"$.
- 3) RIGHT HAND UNIT SHOWN, LEFT HAND MIRROR IMAGE.
(HAND IS DETERMINED BY FACING THE BLOWER END)

OPTIONAL FIELD MOUNTED RETURN AIR PLENUM KITS			
PART NO	FOR MODEL NO.	DIMENSIONS (H X W X D)	SHIP WT.
916-1-STK	3*HBC	10 X 24 X 12-1/2	18
916-2-STK	4*HBC(X)	10 X 30 X 12-1/2	22
916-3-STK	5*HBC	10 X 34 X 12-1/2	22
916-3-STK	6*HBC(X)	10 X 34 X 12-1/2	22
916-4-STK	8*HBC(X)	10 X 40 X 12-1/2	24
916-5-STK	10*HBC(X)	10 X 46 X 12-1/2	27
916-6-STK	13*HBC	10 X 53 X 12-1/2	30

HBC HEADER LOCATIONS							
RIGHT HAND	X1	Y1	X2	Y2	X3	Y3	Y4
3 ROW	3	4-1/4	5	4	---	---	---
3/1 Split	3	4-1/4	5	4	8	3-1/2	5-1/2
3/2 Split	3	4-1/4	5	4	8	3-1/2	5-1/2
4 ROW	3	4-1/4	5	4	---	---	---
4/1 Split	3	4-1/4	5	4	8	4	6

HBC HEADER LOCATIONS							
LEFT HAND	X1	Y1	X2	Y2	X3	Y3	Y4
3 ROW	3	3-3/4	5	4	---	---	---
3/1 Split	3	3-3/4	5	4	8	2-1/2	4-1/2
3/2 Split	3	3-3/4	5	4	8	2-1/2	4-1/2
4 ROW	3	3-3/4	5	4	---	---	---
4/1 Split	3	3-3/4	5	4	8	2	4

Product Specifications

Horizontal Fan Coils
2-Pipe/4-Pipe Hydronic

*HBC PHYSICAL DATA

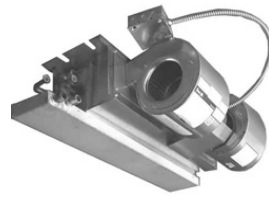
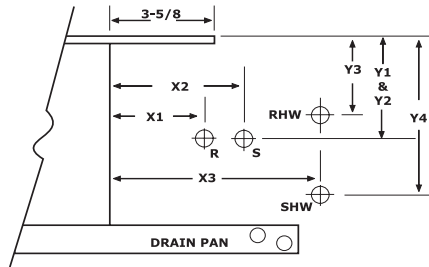

LEFT HAND MODEL SHOWN

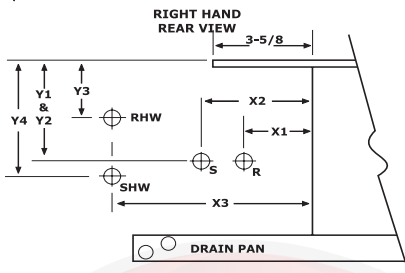

RIGHT HAND REAR VIEW

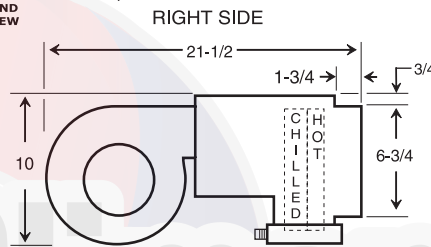

RIGHT SIDE

4 - PIPE UNIT SHOWN

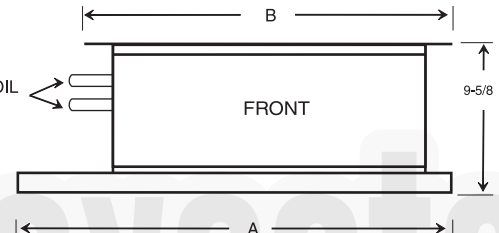
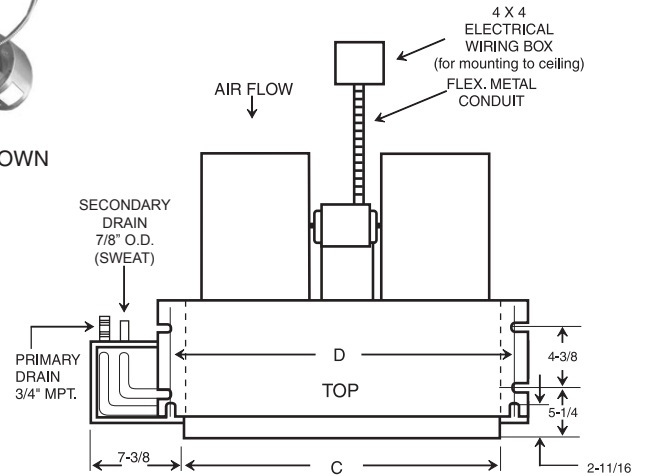

NOTE: RIGHT HAND MODEL SHOWN - LEFT HAND MODEL HAS DRAIN AND PIPING CONNECTIONS ON OPPOSITE SIDE OF FAN COIL.

GENERAL DIMENSIONS

MODEL	A	B	C	D
3*HBC	30-1/8	27-1/4	20-1/8	25-1/4
4*HBC(X)	36-1/8	33-1/4	26-1/8	31-1/4
5*HBC	40-1/8	37-1/4	30-1/8	35-1/4
6*HBC(X)	40-1/8	37-1/4	30-1/8	35-1/4
8*HBC(X)	46-1/8	43-1/4	36-1/8	41-1/4
10*HBC(X)	52-1/8	49-1/4	42-1/8	47-1/4
12*HBC(X)	59-1/8	56-1/4	49-1/8	54-1/4
13*HBC	59-1/8	56-1/4	49-1/8	54-1/4

(X)- Available with ECM motor

NOTES:

- 1) ALL DIMENSIONS IN INCHES.
- 2) COIL CONNECTION TOLERANCE $\pm 1/4"$.
- 3) RIGHT HAND UNIT SHOWN, LEFT HAND MIRROR IMAGE.
(HAND IS DETERMINED BY FACING THE BLOWER END)

OPTIONAL FIELD MOUNTED RETURN AIR PLENUM KITS

PART NO	FOR MODEL NO.	DIMENSIONS (H X W X D)	SHIP WT.
916-1-STK	3*HBC	10 X 24 X 12-1/2	18
916-2-STK	4*HBC(X)	10 X 30 X 12-1/2	22
916-3-STK	5*HBC	10 X 34 X 12-1/2	22
916-3-STK	6*HBC(X)	10 X 34 X 12-1/2	22
916-4-STK	8*HBC(X)	10 X 40 X 12-1/2	24
916-5-STK	10*HBC(X)	10 X 46 X 12-1/2	27
916-6-STK	13*HBC	10 X 53 X 12-1/2	30

HBC HEADER LOCATIONS

RIGHT HAND	X1	Y1	X2	Y2	X3	Y3	Y4
3 ROW	3	4-1/4	5	4	---	---	---
3/1 Split	3	4-1/4	5	4	8	3-1/2	5-1/2
3/2 Split	3	4-1/4	5	4	8	3-1/2	5-1/2
4 ROW	3	4-1/4	5	4	---	---	---
4/1 Split	3	4-1/4	5	4	8	4	6

HBC HEADER LOCATIONS

LEFT HAND	X1	Y1	X2	Y2	X3	Y3	Y4
3 ROW	3	3-3/4	5	4	---	---	---
3/1 Split	3	3-3/4	5	4	8	2-1/2	4-1/2
3/2 Split	3	3-3/4	5	4	8	2-1/2	4-1/2
4 ROW	3	3-3/4	5	4	---	---	---
4/1 Split	3	3-3/4	5	4	8	2	4

Product Specifications

Horizontal Fan Coils
2-Pipe/4-Pipe Hydronic

*PHBC PHYSICAL DATA

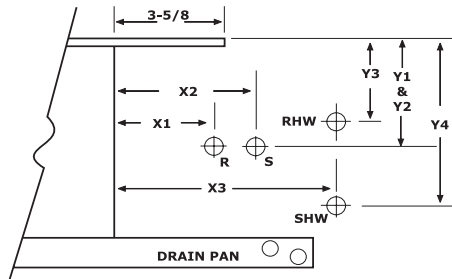

RIGHT HAND
REAR VIEW

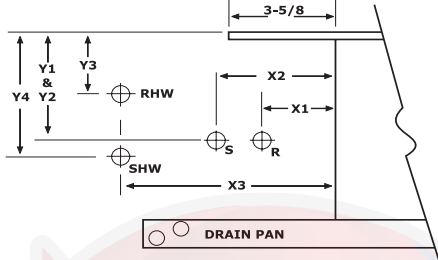

LEFT HAND
REAR VIEW

DUCT FLANGE
(REMOVE FOR BOTTOM RETURN)

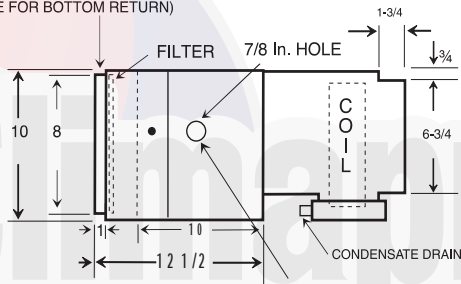

RIGHT SIDE

ELECTRICAL KNOCKOUTS
LOCATED EACH END AND
ONE ON CENTER OF UNIT

NOTES:

1. Return plenums are insulated.
2. All plenums include throw-away filter.
3. Standard plenums are end return and can be field converted to bottom return.
4. Filter has separate access panel.

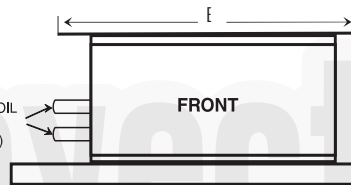
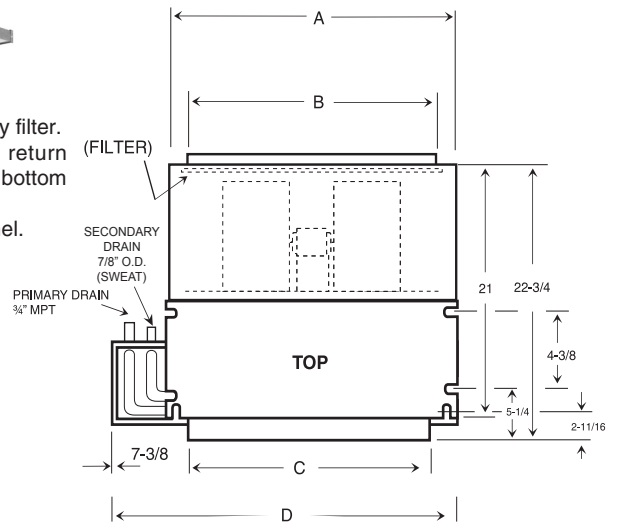
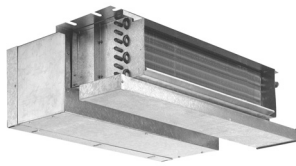

NOTE: RIGHT HAND MODEL SHOWN - LEFT HAND MODEL HAS DRAIN AND PIPING CONNECTIONS ON OPPOSITE SIDE OF FAN COIL.

GENERAL DIMENSIONS							
MODEL	A	B	C	D	E	FILTER SIZE (INCL.)	CONNECTIONS PRIMARY O.D.
3*PHBC	24	22	20-1/8	30-1/8	27-1/4	10 X 24	5/8"
4*PHBC(X)	30	28	26-1/8	36-1/8	33-1/4	10 X 30	
5*PHBC	34	32	30-1/8	40-1/8	37-1/4	10 X 34	
6*PHBC(X)	34	32	30-1/8	40-1/8	37-1/4	10 X 34	
8*PHBC(X)	40	38	36-1/8	46-1/8	43-1/4	10 X 40	
10*PHBC(X)	46	44	42-1/8	52-1/8	49-1/4	10 X 46	
12*PHBX(X)	53	51	49-1/8	59-1/8	56-1/4	10 x 53	
13*PHBC	53	51	49-1/8	59-1/8	56-1/4	10 X 53	

(X)- Available with ECM motor

NOTES:

- 1) ALL DIMENSIONS IN INCHES.
- 2) COIL CONNECTION TOLERANCE $\pm 1/4"$.
- 3) RIGHT HAND UNIT SHOWN, LEFT HAND MIRROR IMAGE.
(HAND IS DETERMINED BY FACING THE BLOWER END)

PHBC HEADER LOCATIONS							
RIGHT HAND	X1	Y1	X2	Y2	X3	Y3	Y4
3 ROW	3	4-1/4	5	4	---	---	---
3/1 Split	3	4-1/4	5	4	8	3-1/2	5-1/2
3/2 Split	3	4-1/4	5	4	8	3-1/2	5-1/2
4 ROW	3	4-1/4	5	4	---	---	---
4/1 Split	3	4-1/4	5	4	8	4	6

PHBC HEADER LOCATIONS							
LEFT HAND	X1	Y1	X2	Y2	X3	Y3	Y4
3 ROW	3	3-3/4	5	4	---	---	---
3/1 Split	3	3-3/4	5	4	8	2-1/2	4-1/2
3/2 Split	3	3-3/4	5	4	8	2-1/2	4-1/2
4 ROW	3	3-3/4	5	4	---	---	---
4/1 Split	3	3-3/4	5	4	8	2	4

Product Specifications

Horizontal Fan Coils
2-Pipe/4-Pipe Hydronic

*RHBC PHYSICAL DATA

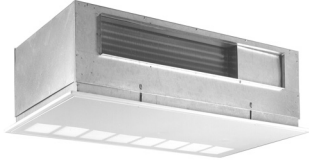

NOTES:

1. Telescoping panel allows the cabinet to be installed to within 2 inches of the ceiling line. The adjustable panel frame ensures a flush installation.
2. Louvered access panel (bottom return) is standard. Specify solid panel if ducted rear return air is required.

NOTES:

- 1) ALL DIMENSIONS IN INCHES.
- 2) COIL CONNECTION TOLERANCE $\pm 1/4"$.
- 3) RIGHT HAND UNIT SHOWN, LEFT HAND MIRROR IMAGE. (HAND IS DETERMINED BY FACING THE BLOWER END)

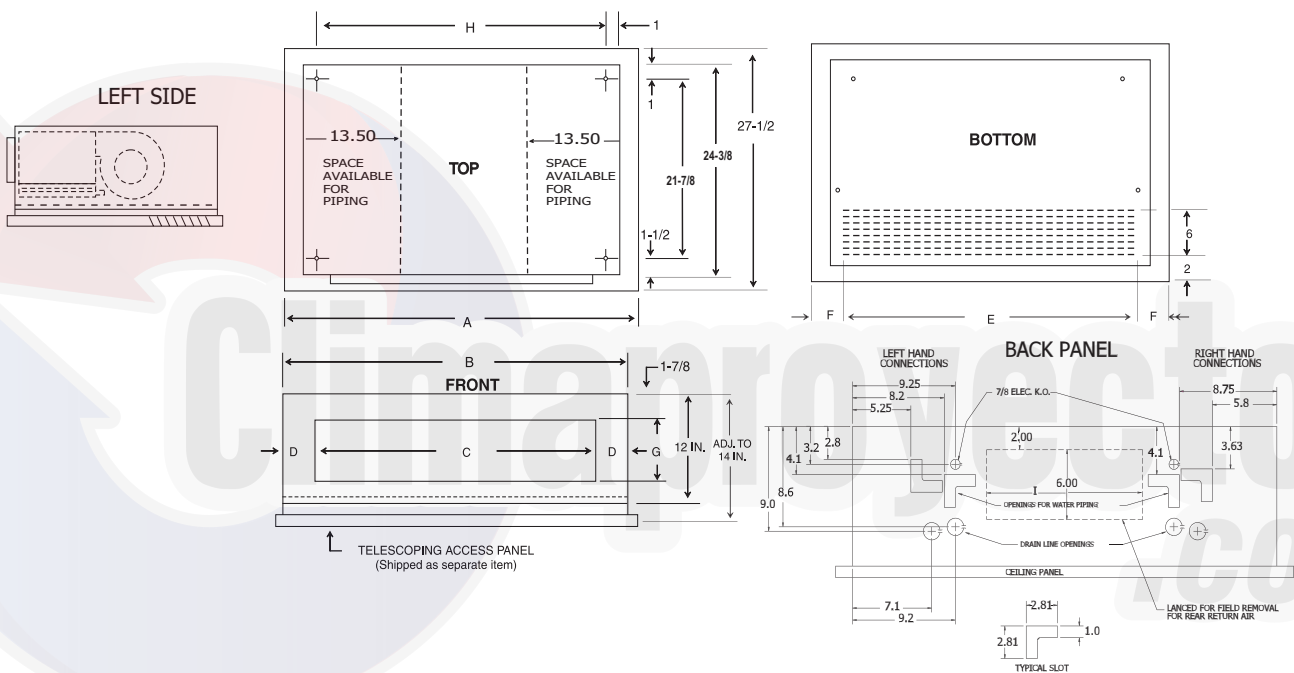

GENERAL DIMENSIONS

MODEL	A	B	C	D	E	F	G	H	I	TELESCOPING LOUVERED ACCESS PANEL	TELESCOPING SOLID ACCESS PANEL	FILTER SIZE (INCL)
3*RHBC	41	38-1/8	29	4-1/2	36-5/8	2-3/16	5-1/2	36	14	968-1	968-1S	10 X 37
4*RHBC(X)	47	44-1/8	35	4-1/2	42	2-1/2	5-1/2	42	20	968-2	968-2S	10 X 43
5*RHBC	51	48-1/8	39	4-1/2	47-1/4	1-7/8	5-1/2	46	24	968-3	968-3S	10 X 47.5
6*RHBC(X)	51	48-1/8	39	4-1/2	47-1/4	1-7/8	5-1/2	46	24	968-3	968-3S	10 X 47.5
8*RHBC(X)	57	54-1/8	45	4-1/2	52-1/2	2-1/4	5-1/2	52	30	968-4	968-4S	10 X 53
10*RHBC(X)	63	60-1/8	51	4-1/2	57-7/8	2-9/16	5-1/2	58	36	968-5	968-5S	10 X 59
12*RHBC(X)	70	67-1/8	58	4-1/2	63-1/8	3-7/16	5-1/2	65	42	968-6	968-6s	10 x 65
13*RHBC	70	67-1/8	58	4-1/2	63-1/8	3-7/16	5-1/2	65	42	968-6	968-6S	10 X 65

(X)- Available with ECM motor

Product Specifications

Horizontal Fan Coils
2-Pipe/4-Pipe Hydronic

***CHBC
PHYSICAL DATA**

NOTES:

- 1) ALL DIMENSIONS IN INCHES.
- 2) COIL CONNECTION TOLERANCE $\pm 1/4"$.
- 3) RIGHT HAND UNIT SHOWN, LEFT HAND MIRROR IMAGE.
(HAND IS DETERMINED BY FACING THE BLOWER END)

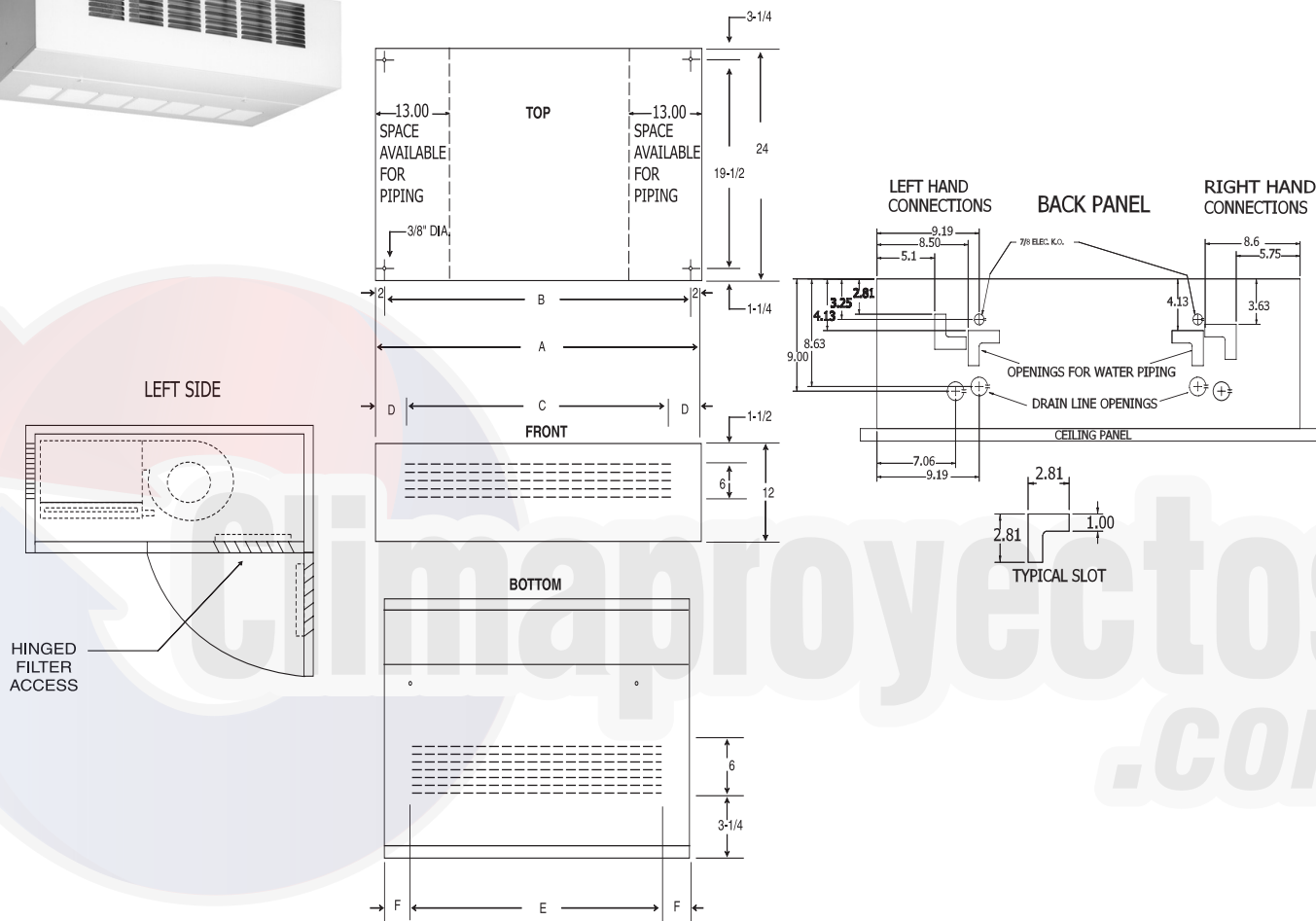
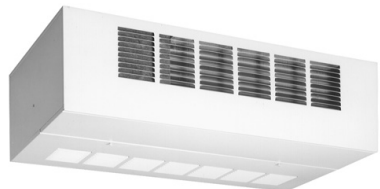

GENERAL DIMENSIONS								
MODEL	A	B	C	D	E	F	FILTER SIZE (INCL)	CONNECTIONS PRIMARY O.D.
3*CHBC	38	34	26	6	31-1/2	3-1/2	10 X 37	5/8"
4*CHBC(X)	44	40	31-1/2	6	37	3-1/2	10 X 43	
5*CHBC	48	44	37	5-1/2	42-1/2	3	10 X 46	
6*CHBC(X)	48	44	37	5-1/2	42-1/2	3	10 X 46	
8*CHBC(X)	54	50	42-1/2	6	48	3	10 X 53	
10*CHBC(X)	60	56	48	6	53	3-1/2	10 X 59	
12*CHBC(X)	67	63	53	7	58-1/2	4	10 X 65	
13*CHBC	67	63	53	7	58-1/2	4	10 X 65	

NOTES:

1. Side panels are removable for easier valve access.

(X)- Available with ECM motor

Product Specifications

Horizontal Fan Coils
2-Pipe/4-Pipe Hydronic

COOLING CAPACITIES

***HBC-3 (3-Row Coil)** All capacities are based on nominal CFM.

COOLING CAPACITY (1000 BTUH)																		
MODEL	NOMINAL CFM	45°F ENTERING WATER									42°F ENTERING WATER							
		GPM	P.D. (FT. WTR.)	80°F D.B. (67°F W.B.)			75°F D.B. (63°F W.B.)			GPM	P.D. (FT. WTR.)	80°F D.B. (67°F W.B.)			75°F D.B. (63°F W.B.)			
				TH	SH	TR	TH	SH	TR			TH	SH	TR	TH	SH	TR	
PSC MOTOR	3*HBC-3	300	3.0	12.6	10.8	7.4	7.2	8.3	6.5	5.5	3.0	12.6	11.8	7.8	7.9	9.0	6.8	6.0
			2.5	9.0	10.4	7.3	8.3	8.0	6.3	6.4	2.5	9.0	11.4	7.6	9.1	8.7	6.6	6.9
			2.0	6.0	9.9	7.1	9.9	7.5	6.2	7.5	2.0	6.0	10.8	7.4	10.8	8.2	6.4	8.2
			1.5	3.6	9.0	6.7	12.1	6.9	5.9	9.2	1.5	3.6	9.9	7.1	13.1	7.5	6.2	10.0
	4*HBC-3	400	3.0	14.7	13.8	9.6	9.2	10.6	8.4	7.0	3.0	14.7	15.1	10.2	10.1	11.5	8.8	7.7
			2.5	10.7	13.2	9.4	10.5	10.0	8.2	8.0	2.5	10.7	14.3	9.8	11.5	11.0	8.6	8.8
			2.0	7.2	12.3	9.1	12.3	9.4	8.0	9.4	2.0	7.2	13.4	9.5	13.4	10.2	8.3	10.2
			1.5	4.4	10.5	8.5	14.4	8.3	7.5	11.0	1.5	4.4	11.8	8.9	15.7	9.0	7.8	12.0
	5*HBC-3	500	6.0	13.8	17.9	12.2	6.0	13.7	10.7	4.6	6.0	13.8	19.6	12.9	6.5	14.9	11.1	5.0
			5.0	9.8	17.3	12.0	6.9	13.2	10.5	5.3	5.0	9.8	18.9	12.6	7.5	14.4	10.9	5.8
			4.0	6.5	16.5	11.7	8.2	12.6	10.2	6.3	4.0	6.5	17.9	12.3	9.0	13.7	10.7	6.9
			3.0	3.8	15.0	11.3	10.0	11.5	9.8	7.7	3.0	3.8	16.4	11.7	10.9	12.5	10.2	8.3
6*HBC-3	600	6.0	13.8	20.6	14.1	6.9	15.7	12.3	5.2	6.0	13.8	22.4	14.8	7.5	17.1	12.9	5.7	
		5.0	9.8	19.8	13.8	7.9	15.1	12.1	6.0	5.0	9.8	21.6	14.5	8.6	16.5	12.6	6.6	
		4.0	6.5	18.7	13.4	9.4	14.3	11.8	7.2	4.0	6.5	20.4	14.1	10.2	15.6	12.3	7.8	
		3.0	3.8	17.0	12.8	11.3	13.0	11.2	8.6	3.0	3.8	18.5	13.4	12.3	14.1	11.7	9.4	
8*HBC-3	800	6.5	13.7	24.7	17.6	7.6	18.9	15.5	5.8	6.5	13.7	27.0	18.5	8.3	20.6	16.1	6.3	
		5.5	10.0	23.7	17.3	8.6	18.1	15.1	6.6	5.5	10.0	25.8	18.1	9.4	19.7	15.8	7.2	
		4.5	6.9	22.3	16.8	9.9	17.0	14.7	7.6	4.5	6.9	24.3	17.5	10.8	18.6	15.3	8.3	
		3.5	4.3	20.1	16.0	11.5	15.4	14.1	8.8	3.5	4.3	21.9	16.6	12.5	16.7	14.6	9.6	
10*HBC-3	1000	8.0	17.9	30.3	21.7	7.6	23.2	19.0	5.8	8.0	17.9	33.0	22.7	8.3	25.2	19.8	6.3	
		7.0	13.7	29.2	21.3	8.4	22.3	18.7	6.4	7.0	13.7	31.9	22.3	9.1	24.3	19.4	7.0	
		6.0	10.1	27.9	20.8	9.3	21.3	18.3	7.1	6.0	10.1	30.4	21.7	10.1	23.2	19.0	7.7	
		5.0	7.0	26.2	20.1	10.5	20.0	17.8	8.0	5.0	7.0	28.5	21.0	11.4	21.8	18.5	8.7	
13*HBC-3	1300	8.0	18.2	36.0	25.4	8.8	26.7	22.3	6.7	8.0	18.2	38.2	26.6	9.5	29.1	23.2	7.3	
		7.0	14.1	33.6	24.9	9.6	25.7	21.9	7.3	7.0	14.1	36.7	26.0	10.5	28.0	22.8	8.0	
		6.0	10.5	31.9	24.3	10.6	24.4	21.4	8.1	6.0	10.5	34.8	25.3	11.6	26.6	22.3	8.9	
		5.0	7.4	29.7	23.5	11.9	22.7	20.8	9.1	5.0	7.4	32.4	24.4	12.9	24.7	21.5	9.9	

***HBC-4 (4-Row Coil)** All capacities are based on nominal CFM.

COOLING CAPACITY (1000 BTUH)																		
MODEL	NOMINAL CFM	45°F ENTERING WATER									42°F ENTERING WATER							
		GPM	P.D. (FT. WTR.)	80°F D.B. (67°F W.B.)			75°F D.B. (63°F W.B.)			GPM	P.D. (FT. WTR.)	80°F D.B. (67°F W.B.)			75°F D.B. (63°F W.B.)			
				TH	SH	TR	TH	SH	TR			TH	SH	TR	TH	SH	TR	
PSC MOTOR	3*HBC-4	300	2.5	11.4	11.5	7.8	9.2	8.8	6.8	7.0	2.5	11.4	12.5	8.2	10.0	9.6	7.1	7.7
			2.0	7.6	10.9	7.6	10.9	8.3	6.6	8.3	2.0	7.6	11.9	8.0	11.9	9.1	6.9	9.1
			1.5	4.5	10.0	7.2	13.3	7.6	6.3	10.1	1.5	4.5	10.9	7.6	14.5	8.3	6.6	11.1
			1.0	2.2	8.3	6.6	16.5	6.3	5.8	12.6	1.0	2.2	9.0	6.9	18.0	6.9	6.1	13.7
	4*HBC-4	400	2.5	13.2	14.5	10.1	11.6	11.1	8.8	8.9	2.5	13.2	15.8	10.6	12.7	12.1	9.2	9.7
			2.0	8.9	13.5	9.7	13.5	10.3	8.5	10.3	2.0	8.9	14.7	10.2	14.7	11.3	8.9	11.3
			1.5	5.3	11.9	9.1	15.9	9.1	8.0	12.2	1.5	5.3	13.0	9.6	17.4	9.9	8.4	13.3
			1.2	3.6	10.5	8.6	17.5	8.0	7.6	17.1	1.2	3.6	11.5	9.0	19.1	8.8	7.9	14.6
	5*HBC-4	500	3.5	6.5	17.5	12.4	10.0	13.4	10.8	7.7	3.5	6.5	19.1	13.3	10.9	14.6	11.3	8.3
			3.0	4.9	16.6	12.0	11.1	12.7	10.5	8.5	3.0	4.9	18.1	12.6	12.1	13.8	11.0	9.2
			2.5	3.5	15.4	11.6	12.3	11.8	10.2	9.4	2.5	3.5	16.8	12.1	13.5	12.9	10.6	10.3
			2.0	2.3	13.9	11.0	13.9	10.6	9.7	10.6	2.0	2.3	15.2	11.5	15.2	11.6	10.1	11.6
6*HBC-4	600	5.0	12.6	21.9	15.1	8.8	16.8	13.1	6.7	5.0	12.6	23.9	15.8	9.6	18.3	13.7	7.3	
		4.0	8.3	20.8	14.6	10.4	15.9	12.7	7.9	4.0	8.3	22.6	15.3	11.3	17.3	13.3	8.6	
		3.0	4.9	18.8	13.9	12.5	14.4	12.2	9.6	3.0	4.9	20.5	14.5	13.7	15.7	12.7	10.4	
		2.0	2.3	15.6	12.7	15.6	11.9	11.2	11.9	2.0	2.3	17.0	13.2	17.0	13.0	11.6	13.0	
8*HBC-4	800	6.0	14.7	27.0	19.1	9.0	20.6	16.7	6.9	6.0	14.7	29.4	20.0	9.8	22.5	17.4	7.5	
		5.0	10.7	25.7	18.6	10.3	19.6	16.3	7.8	5.0	10.7	28.0	19.5	11.2	21.4	17.0	8.6	
		4.0	7.2	23.7	17.8	11.9	18.1	15.7	7.2	4.0	7.2	25.9	18.6	12.9	19.7	16.3	9.9	
		3.0	4.4	20.8	16.8	13.9	15.9	14.8	10.6	3.0	4.4	22.7	17.5	15.1	17.3	15.4	11.5	
10*HBC-4	1000	7.0	14.1	32.6	23.3	9.3	24.9	20.4	7.1	7.0	14.1	35.5	24.4	10.2	27.1	21.3	7.8	
		6.0	10.5	31.1	22.8	10.4	23.8	19.9	7.9	6.0	10.5	33.9	23.8	11.3	25.9	20.8	8.6	
		5.0	7.4	29.2	22.0	11.7	22.3	19.4	8.9	5.0	7.4	31.8	23.0	12.7	24.3	20.1	9.7	
		4.0	4.9	26.4	21.0	13.2	20.2	18.6	10.1	4.0	4.9	28.8	21.9	14.4	22.0	19.3	11.0	
13*HBC-4	1300	7.0	16.1	37.5	27.3	10.7	28.7	23.9	8.2	7.0	16.1	40.9	28.6	11.7	31.2	24.9	8.9	
		6.0	12.0	35.7	26.6	11.9	27.2	23.4	9.1	6.0	12.0	38.9	27.8	13.0	29.7	24.3	9.9	
		5.0	8.5	33.1	25.7	13.3	25.3	22.6	10.1	5.0	8.5	36.1	26.8	14.4	27.6	23.5	11.0	
		4.0	5.6	29.7	24.4	14.8	24.6	24.6	12.3	4.0	5.6	32.3	25.4	16.2	24.7	22.4	12.4	

Product Specifications

Horizontal Fan Coils
2-Pipe/4-Pipe Hydronic

COOLING CAPACITIES

***HBC-31 (3-Row Coil)** All capacities are based on nominal CFM.

COOLING CAPACITY (1000 BTUH)																		
MODEL	NOMINAL CFM	45°F ENTERING WATER									42°F ENTERING WATER							
		GPM	P.D. (FT. WTR.)	80°F D.B. (67°F W.B.)			75°F D.B. (63°F W.B.)			GPM	P.D. (FT. WTR.)	80°F D.B. (67°F W.B.)			75°F D.B. (63°F W.B.)			
				TH	SH	TR	TH	SH	TR			TH	SH	TR	TH	SH	TR	
PSC MOTOR	3*HBC-31	300	3.0	12.6	10.4	7.1	6.9	7.9	6.2	5.1	3.0	12.6	11.3	7.5	7.5	8.6	6.5	5.8
			2.5	9.0	10.0	7.0	8.0	7.6	6.1	6.1	2.5	9.0	10.9	7.3	8.7	8.3	6.3	6.6
			2.0	6.0	9.4	6.8	9.4	7.2	5.9	7.2	2.0	6.0	10.7	7.1	10.3	7.9	6.2	7.9
			1.5	3.6	8.6	6.5	11.5	6.6	5.7	8.8	1.5	3.6	9.4	6.7	12.6	1.2	5.9	9.6
	4*HBC-31	400	3.0	14.7	13.2	9.2	8.8	10.1	8.0	6.7	3.0	14.7	14.4	9.7	9.6	11.0	8.4	7.3
			2.5	10.7	12.6	9.0	10.0	9.6	7.9	7.7	2.5	10.7	13.7	9.4	11.0	10.5	8.2	8.4
			2.0	7.2	11.7	8.7	11.7	8.9	7.6	8.9	2.0	7.2	12.8	9.1	12.8	9.7	7.9	9.7
			1.5	4.4	10.3	8.2	13.8	7.9	7.2	10.5	1.5	4.4	11.3	8.5	15.0	8.6	7.5	11.5
	5*HBC-31	500	6.0	13.8	17.1	11.7	5.7	13.0	10.2	4.3	6.0	13.8	18.6	12.3	6.2	14.2	10.6	4.7
			5.0	9.8	16.5	11.5	6.6	12.6	10.0	5.0	5.0	9.8	18.0	12.0	7.2	13.7	10.4	5.5
			4.0	6.5	15.7	11.2	7.8	12.0	9.8	6.0	4.0	6.5	17.1	11.7	8.5	13.1	10.2	6.5
			3.0	3.8	14.3	10.7	9.5	10.9	9.4	7.3	3.0	3.8	15.6	11.1	10.4	11.9	9.7	.0
6*HBC-31	600	6.0	13.8	19.5	13.4	6.5	14.9	11.7	5.0	6.0	13.8	21.3	14.1	7.1	16.2	12.3	5.4	
		5.0	9.8	18.8	13.2	7.5	14.3	11.5	5.7	5.0	9.8	20.5	13.8	8.2	15.6	12.0	6.2	
		4.0	6.5	17.8	12.8	8.9	13.6	11.2	6.8	4.0	6.5	19.4	13.4	9.7	14.8	11.7	7.4	
		3.0	3.8	16.1	12.2	10.7	12.3	10.7	8.2	3.0	3.8	17.5	12.7	11.7	13.4	11.2	8.9	
8*HBC-31	800	6.5	13.7	23.4	16.8	7.2	17.9	14.7	5.5	6.5	13.7	25.5	17.6	7.9	19.5	15.3	6.0	
		5.5	10.0	22.4	16.4	8.2	17.1	14.4	6.2	5.5	10.0	24.5	17.2	8.9	18.7	15.0	6.8	
		4.5	6.9	21.1	15.9	9.4	16.1	14.0	7.2	4.5	6.9	23.0	16.6	10.2	17.6	14.6	7.8	
		3.5	4.3	29.1	15.2	10.9	14.6	13.4	8.3	3.5	4.3	20.8	15.8	11.9	15.9	13.9	9.1	
10*HBC-31	1000	8.0	17.9	28.7	20.6	7.2	21.9	18.1	5.5	8.0	17.9	31.3	21.6	7.8	23.9	18.8	6.0	
		7.0	13.7	27.7	20.2	7.9	21.1	17.8	6.0	7.0	13.7	30.2	21.1	8.6	23.0	15.8	6.6	
		6.0	10.1	26.4	19.8	8.8	20.2	17.4	6.7	6.0	10.1	28.8	20.6	9.6	22.0	18.1	7.3	
		5.0	7.0	24.8	19.2	9.9	18.9	16.9	7.6	5.0	7.0	27.0	20.0	10.8	20.6	17.6	8.2	
13*HBC-31	1300	8.0	18.2	33.1	24.4	8.3	25.3	21.2	6.3	8.0	18.2	36.1	25.3	9.0	27.6	22.1	6.9	
		7.0	14.1	31.8	23.7	9.1	24.3	20.9	6.9	7.0	14.1	34.7	24.7	9.9	26.5	21.7	7.6	
		6.0	10.5	30.2	23.1	10.1	23.1	20.4	7.7	6.0	10.5	33.0	24.1	11.0	25.2	21.2	8.4	
		5.0	7.4	28.1	22.3	11.2	21.5	19.8	8.6	5.0	7.4	30.6	23.2	12.3	23.4	20.5	9.4	

***HBC-32 (3-Row Coil)** All capacities are based on nominal CFM.

COOLING CAPACITY (1000 BTUH)																		
MODEL	NOMINAL CFM	45°F ENTERING WATER									42°F ENTERING WATER							
		GPM	P.D. (FT. WTR.)	80°F D.B. (67°F W.B.)			75°F D.B. (63°F W.B.)			GPM	P.D. (FT. WTR.)	80°F D.B. (67°F W.B.)			75°F D.B. (63°F W.B.)			
				TH	SH	TR	TH	SH	TR			TH	SH	TR	TH	SH	TR	
PSC MOTOR	3*HBC-32	300	3.0	12.6	9.6	6.5	6.4	7.3	5.7	4.9	3.0	12.6	10.5	6.9	7.0	8.0	6.0	5.3
			2.5	9.0	9.3	6.4	7.4	7.1	5.6	5.7	2.5	9.0	10.1	6.7	8.1	7.7	5.8	6.2
			2.0	6.0	8.8	6.2	8.8	6.7	5.4	6.7	2.0	6.0	9.6	6.5	9.6	7.3	5.7	7.3
			1.5	3.6	8.0	5.9	10.7	6.1	5.2	8.2	1.5	3.6	8.7	6.2	11.7	6.7	5.4	8.9
	4*HBC-32	400	3.0	14.7	12.2	8.5	8.2	9.4	7.4	6.2	3.0	14.7	13.4	8.9	8.9	10.2	7.7	6.8
			2.5	10.7	11.7	8.2	9.3	8.9	7.2	7.1	2.5	10.7	12.7	8.6	10.2	9.7	7.5	7.8
			2.0	7.2	10.9	8.0	10.9	8.3	7.0	8.3	2.0	7.2	11.9	8.3	11.9	9.1	7.3	9.1
			1.5	4.4	9.6	7.5	12.8	7.3	6.6	9.8	1.5	4.4	10.5	7.8	14.0	8.0	6.9	10.7
	5*HBC-32	500	6.0	13.8	15.9	10.7	5.3	12.1	9.4	4.0	6.0	13.8	17.3	11.3	5.8	13.2	9.8	4.4
			5.0	9.8	15.3	10.5	6.1	11.7	9.2	4.7	5.0	9.8	16.7	11.0	6.7	12.8	9.6	5.1
			4.0	6.5	14.6	10.2	7.3	11.1	9.0	5.6	4.0	6.5	15.9	10.7	7.9	12.1	9.4	6.1
			3.0	3.8	13.3	9.8	8.9	10.2	8.6	6.8	3.0	3.8	14.5	10.2	9.7	11.1	8.9	7.4
6*HBC-32	600	6.0	13.8	18.2	12.3	6.1	13.9	10.7	5.1	6.0	13.8	19.8	12.9	6.6	15.2	11.2	5.1	
		5.0	9.8	17.5	12.0	7.0	13.4	10.5	5.8	5.0	9.8	19.1	12.6	7.6	14.6	11.0	5.8	
		4.0	6.5	16.6	11.7	8.3	12.6	10.3	6.7	4.0	6.5	18.1	12.2	9.0	13.8	10.7	6.9	
		3.0	3.8	15.0	11.1	10.0	11.5	9.8	7.8	3.0	3.8	16.4	11.6	10.9	12.5	10.2	8.3	
8*HBC-32	800	6.5	13.7	21.9	15.3	7.2	16.7	13.4	5.1	6.5	13.7	23.8	16.0	7.3	18.2	14.0	5.6	
		5.5	10.0	20.9	14.9	7.6	16.0	13.1	5.8	5.5	10.0	22.8	15.6	8.3	17.4	13.7	6.3	
		4.5	6.9	19.7	14.5	8.8	15.1	12.8	6.7	4.5	6.9	21.5	15.1	9.6	16.4	13.3	7.3	
		3.5	4.3	17.8	13.8	10.2	13.6	12.2	7.8	3.5	4.3	19.4	14.4	11.1	14.8	12.7	8.5	
10*HBC-32	1000	8.0	17.9	26.8	18.7	6.7	20.5	16.4	5.1	8.0	17.9	29.2	19.6	7.3	22.3	17.1	5.6	
		7.0	13.7	25.8	18.3	7.4	19.7	16.1	5.8	7.0	13.7	28.2	19.2	8.0	21.5	16.8	6.1	
		6.0	10.1	24.7	17.9	8.2	18.8	15.8	6.7	6.0	10.1	26.9	18.7	9.0	20.5	16.4	6.8	
		5.0	7.0	23.1	17.4	9.2	17.6	15.3	7.1	5.0	7.0	25.2	18.1	10.1	19.2	15.9	7.7	
13*HBC-32	1300	8.0	18.2	30.9	21.9	7.7	23.6	19.2	5.9	8.0	18.2	33.7	22.9	8.4	25.8	20.0	6.4	
		7.0	14.1	29.7	21.4	8.5	22.7	18.9	6.5	7.0	14.1	32.4	22.4	9.3	24.7	19.7	7.1	
		6.0	10.5	28.2	20.9	9.4	21.6	18.5	7.2	6.0	10.5	30.8	21.8	10.3	23.5	19.2	7.8	
		5.0	7.4	26.2	20.2	10.5	20.0	17.9	8.0	5.0	7.4	28.6	21.0	11.4	21.8	18.6	8.7	

Product Specifications

Horizontal Fan Coils
2-Pipe/4-Pipe Hydronic

COOLING CAPACITIES

***HBC-41 (4-Row Coil)** All capacities are based on nominal CFM.

COOLING CAPACITY (1000 BTUH)																		
MODEL	NOMINAL CFM	45°F ENTERING WATER									42°F ENTERING WATER							
		GPM	P.D. (FT. WTR.)	80°F D.B. (67°F W.B.)			75°F D.B. (63°F W.B.)			GPM	P.D. (FT. WTR.)	80°F D.B. (67°F W.B.)			75°F D.B. (63°F W.B.)			
				TH	SH	TR	TH	SH	TR			TH	SH	TR	TH	SH	TR	
PSC MOTOR	3*HBC-41	300	3.0	15.9	11.2	7.5	7.5	8.6	6.5	5.7	3.0	15.9	12.3	7.9	8.2	9.4	6.8	6.2
			2.5	11.4	10.8	7.4	8.7	8.3	6.4	6.6	2.5	11.4	11.8	7.7	9.4	9.0	6.7	7.2
			2.0	7.6	10.2	7.1	10.2	7.8	6.2	7.8	2.0	7.6	11.2	7.5	11.2	8.5	6.5	8.5
			1.5	4.5	9.4	6.8	12.5	7.2	6.0	9.5	1.5	4.5	10.2	7.1	13.6	7.8	6.2	10.4
	4*HBC-41	400	3.0	18.2	14.3	9.8	9.6	10.9	8.5	7.3	3.0	18.2	15.6	10.3	10.4	11.9	8.9	8.0
			2.5	13.2	13.6	9.5	10.9	10.4	8.3	8.3	2.5	13.2	14.9	10.0	11.9	11.4	8.7	9.1
			2.0	8.9	12.7	9.2	12.7	9.7	8.0	9.7	2.0	8.9	13.9	9.6	13.9	10.6	8.4	10.6
			1.5	5.3	11.2	8.6	15.0	8.6	7.6	11.4	1.5	5.3	12.2	9.0	16.3	9.4	7.9	12.5
	5*HBC-41	500	6.0	17.6	18.9	12.6	6.3	14.5	10.9	4.8	6.0	17.6	20.6	13.3	6.9	15.8	11.5	5.3
			5.0	12.6	18.3	12.3	7.3	14.0	10.7	5.6	5.0	12.6	19.9	13.0	8.0	15.2	11.2	6.1
			4.0	8.3	17.4	12.0	8.7	13.3	10.5	6.6	4.0	8.3	19.0	12.6	9.5	14.5	10.9	7.2
			3.0	4.9	15.9	11.4	10.6	12.1	10.0	8.1	3.0	4.9	17.3	12.0	11.5	13.2	10.4	8.8
6*HBC-41	600	6.0	17.6	21.5	14.4	7.2	16.4	12.6	5.5	6.0	17.6	23.5	15.2	7.8	17.9	13.1	6.0	
		5.0	12.6	20.7	14.1	8.3	15.8	12.3	6.3	5.0	12.6	22.6	14.8	9.0	17.2	12.9	6.9	
		4.0	8.3	19.6	13.7	9.8	15.0	12.0	7.5	4.0	8.3	21.3	14.4	10.7	16.3	12.5	8.2	
		3.0	4.9	17.7	13.0	11.8	13.6	11.4	9.0	3.0	4.9	19.3	13.6	12.9	14.8	11.9	9.8	
8*HBC-41	800	6.5	16.9	26.0	18.1	8.0	19.6	15.8	6.1	6.5	16.9	28.3	19.0	8.7	21.6	16.5	6.7	
		5.5	12.6	24.9	17.7	9.1	19.0	15.5	6.9	5.5	12.6	27.1	18.5	9.9	20.7	16.1	7.5	
		4.5	8.9	23.4	17.1	10.4	17.9	15.0	8.0	4.5	8.9	25.6	17.9	11.4	19.5	16.7	8.7	
		3.5	5.7	21.1	16.3	12.1	16.1	14.4	9.2	3.5	5.7	23.0	17.0	13.2	17.6	14.9	10.1	
10HBC-41	1000	8.0	18.2	31.9	22.3	8.0	24.4	19.5	6.1	8.0	18.2	34.8	23.3	8.7	26.6	20.3	6.6	
		7.0	14.1	30.8	21.8	8.8	23.5	19.1	6.7	7.0	14.1	33.6	22.9	9.6	25.7	19.9	7.3	
		6.0	10.5	29.4	21.3	9.8	22.5	18.7	7.5	6.0	10.5	32.1	22.3	10.7	24.5	19.5	8.2	
		5.0	7.4	27.6	20.6	11.0	21.1	18.2	8.4	5.0	7.4	20.0	21.6	12.0	22.9	18.9	9.2	
13*HBC-41	1300	8.0	20.8	37.0	26.1	9.2	28.2	22.9	7.1	8.0	20.8	40.3	27.4	10.1	30.8	23.9	7.7	
		7.0	16.1	35.5	25.6	10.1	27.1	22.4	7.7	7.0	16.1	38.7	26.8	11.1	29.6	23.4	8.4	
		6.0	12.0	33.7	24.9	11.2	25.8	21.9	8.6	6.0	12.0	36.8	26.1	12.3	28.1	22.8	9.4	
		5.0	8.5	31.3	24.1	12.5	23.9	21.2	9.6	5.0	8.5	34.2	25.1	13.7	26.1	22.0	10.4	

Product Specifications
Horizontal Fan Coils
2-Pipe/4-Pipe Hydronic

HEATING PERFORMANCE

*HBC-3 (3-Row Coil)							
HEATING CAPACITY (1000 BTUH)							
MODEL	NOMINAL CFM	GPM	P.D. (F.WTR)	ENTERING WATER TEMP.			
				180°F	160°F	140°F	120°F
3*HBC-3	300	3.0	12.6	26.9	22.0	17.1	12.2
		2.0	3.0	26.0	21.2	16.5	11.8
		1.0	1.7	23.4	19.1	14.9	10.6
4*HBC-3	400	3.5	19.3	35.8	29.3	22.8	16.3
		2.5	10.7	34.6	28.3	22.0	15.7
		1.5	4.4	32.1	26.3	20.4	14.6
5*HBC-3	500	5.0	9.8	43.7	35.7	27.8	19.8
		3.5	5.1	42.2	34.5	26.8	19.2
		2.0	1.8	38.6	31.6	24.6	17.5
6*HBC-3	600	5.0	9.8	49.7	40.6	31.6	22.6
		3.5	5.1	47.8	39.1	30.4	21.7
		2.0	1.8	43.5	35.6	27.7	19.8
8*HBC-3	800	7.0	15.7	65.0	53.2	41.4	29.6
		5.0	8.4	62.7	51.3	39.9	28.5
		3.0	3.2	57.7	47.2	39.7	26.2
10*HBC-3	1000	8.0	17.9	79.2	64.8	50.4	36.0
		6.0	10.1	76.6	62.7	48.8	34.8
		4.0	4.5	71.9	58.8	45.7	32.7
13*HBC-3	1300	8.0	18.2	93.3	76.4	59.4	42.4
		6.0	10.5	90.0	73.6	57.2	40.9
		4.0	4.9	83.8	68.6	53.3	38.1

*HBC-31 (1-Row Coil)							
HEATING CAPACITY (1000 BTUH)							
MODEL	NOMINAL CFM	GPM	P.D. (F.WTR)	ENTERING WATER TEMP.			
				180°F	160°F	140°F	120°F
3*HBC-31	300	2.0	11.3	15.2	12.4	9.6	6.9
		1.5	6.7	14.7	12.0	9.4	6.7
		1.0	3.2	13.9	11.4	8.8	6.3
4*HBC-31	400	2.0	14.4	19.6	16.1	12.5	8.9
		1.5	8.9	18.9	15.5	12.0	8.6
		1.0	4.5	17.5	14.4	11.2	8.0
5*HBC-31	500	2.0	15.0	23.3	19.1	14.8	10.6
		1.5	9.0	22.3	18.2	14.2	10.1
		1.0	4.4	20.4	16.7	13.0	9.3
6*HBC-31	600	2.0	15.0	25.7	21.0	16.4	11.7
		1.5	9.0	24.5	20.0	15.6	11.1
		1.0	4.4	22.4	18.3	14.2	10.2
8*HBC-31	800	2.0	18.8	31.6	25.9	20.1	14.4
		1.5	11.3	29.8	24.4	19.0	13.6
		1.0	5.5	26.8	21.9	17.0	12.2
10*HBC-31	1000	2.0	19.9	37.0	30.3	23.5	16.8
		1.5	12.3	34.6	28.3	22.0	15.7
		1.0	6.2	30.8	25.2	19.6	14.0
13A*HBC-31	1300	2.0	23.4	42.3	34.6	26.9	19.2
		1.5	14.0	39.4	32.2	25.1	17.9
		1.0	6.8	35.2	28.8	22.4	16.0

*HBC-4 (4-Row Coil)							
HEATING CAPACITY (1000 BTUH)							
MODEL	NOMINAL CFM	GPM	P.D. (F.WTR)	ENTERING WATER TEMP.			
				180°F	160°F	140°F	120°F
3*HBC-4	300	3.0	15.9	28.6	23.4	18.2	13.0
		2.0	7.6	27.6	22.6	17.6	12.6
		1.0	2.2	14.9	20.3	15.8	11.3
4*HBC-4	400	3.0	18.2	37.6	30.7	23.9	17.1
		2.0	8.9	35.8	29.3	22.8	16.3
		1.0	2.6	31.3	25.6	19.9	14.2
5*HBC-4	500	4.0	8.3	45.6	37.3	29.0	20.7
		3.0	4.9	44.0	36.0	28.0	20.0
		2.0	2.3	41.2	33.7	26.2	18.7
6*HBC-4	600	5.0	12.6	53.2	43.5	33.9	24.2
		4.0	8.3	52.0	42.6	33.1	23.6
		3.0	4.9	50.1	41.0	31.9	22.8
8*HBC-4	800	6.0	14.7	68.8	56.3	43.8	31.3
		4.5	8.9	66.4	54.3	42.3	30.2
		3.0	4.4	62.0	50.7	39.4	28.2
10*HBC-4	1000	7.5	16.1	84.7	69.3	53.9	38.5
		6.0	10.5	82.5	67.5	52.5	37.5
		4.5	4.5	79.0	64.6	50.3	35.9
13*HBC-4	1300	8.0	20.8	100.5	92.2	63.9	45.7
		6.5	14.0	97.9	80.1	62.3	44.5
		5.0	8.5	94.1	77.0	69.9	42.8

*HBC-32 (2-Row Coil)							
HEATING CAPACITY (1000 BTUH)							
MODEL	NOMINAL CFM	GPM	P.D. (F.WTR)	ENTERING WATER TEMP.			
				180°F	160°F	140°F	120°F
3*HBC-32	300	3.0	10.5	18.3	15.0	11.7	8.3
		2.0	5.1	17.7	14.5	11.2	8.0
		1.0	1.5	15.9	13.0	10.1	7.2
4*HBC-32	400	3.0	11.2	24.0	19.6	15.2	10.9
		2.0	5.4	22.8	18.7	14.5	10.4
		1.0	1.6	20.0	16.4	12.7	9.1
5*HBC-32	500	3.0	13.4	28.8	23.5	18.3	13.1
		2.0	6.4	27.2	22.3	17.3	12.4
		1.0	1.9	23.4	19.1	14.9	10.6
6*HBC-32	600	3.0	13.4	32.1	26.2	20.4	14.6
		2.0	6.4	30.3	24.8	19.3	13.8
		1.0	1.9	25.8	21.1	16.4	11.7
8*HBC-32	800	4.0	8.4	40.5	33.1	25.8	18.4
		3.0	4.8	38.6	31.6	24.6	17.5
		2.0	2.2	35.4	28.9	22.5	16.1
10*HBC-32	1000	4.0	8.1	48.2	39.5	30.7	21.9
		3.0	4.7	45.7	37.4	29.1	20.8
		2.0	2.2	41.3	33.8	26.3	18.8
13*HBC-32	1300	4.0	7.8	56.1	45.9	35.7	25.5
		3.0	4.3	52.8	43.2	33.6	24.0
		2.0	1.9	47.3	38.7	30.1	21.5

*HBC-41 (1-Row Coil)							
HEATING CAPACITY (1000 BTUH)							
MODEL	NOMINAL CFM	GPM	P.D. (F.WTR)	ENTERING WATER TEMP.			
				180°F	160°F	140°F	120°F
3*HBC-41	300	2.0	11.3	14.1	11.6	9.0	6.4
		1.5	6.7	13.7	11.2	8.7	6.2
		1.0	3.2	13.0	10.6	8.2	5.9
4*HBC-341	400	2.0	14.4	18.2	14.9	11.6	8.3
		1.5	8.9	17.6	14.4	11.2	8.0
		1.0	4.5	16.3	13.36	10.4	7.4
5*HBC-41	500	2.0	15.0	21.4	17.5	13.6	9.7
		1.5	9.0	20.5	16.8	13.0	9.3
		1.0	4.4	18.8	15.3	11.9	8.5
6*HBC-41	600	2.0	15.0	23.2	19.0	14.8	10.5
		1.5	9.0	22.1	18.1	14.1	10.0
		1.0	4.4	20.2	16.5	12.8	9.2
8*HBC-41	800	2.0	18.8	28.4	23.2	18.1	12.9
		1.5	11.3	26.8	21.9	17.1	12.2
		1.0	5.5	24.1	19.7	15.3	10.9
10*HBC-41	1000	2.0	19.9	33.3	27.2	21.2	15.1
		1.5	12.3	31.1	25.5	19.8	14.1
		1.0	6.2	27.7	22.7	17.6	12.6
13*HBC-41	1300	2.0	23.4	38.1	31.2	24.2	17.3
		1.5	14.0	35.4	29.0	22.5	16.1
		1.0	6.8	31.6	25.9	20.1	14.4

NOTES:

1. Ratings at 70 degree ent. air temp.
2. Contact factory for capacities at other conditions

- * - P - with insulated return plenum
- R - recessed with telescoping panel
- C - cabinet exposed

Product Specifications

Horizontal Fan Coils
2-Pipe/4-Pipe Hydronic

COOLING CORRECTIONS

COOLING CAPACITY CORRECTION FACTORS														
MODEL	3HBC		4HBC		5HBC		6HBC		8HBC		10HBC		13HBC	
CFM	TH	SH	TH	SH	TH	SH	TH	SH	TH	SH	TH	SH	TH	SH
150	.70	.64												
175	.75	.70												
200	.80	.76												
225	.85	.82												
250	0.9	.88	.70	.64										
300	1.00	1.00	.76	.71	.70	.64								
325	1.04	1.06	.79	.75	.72	.67								
350	1.10	1.12	.82	.78	.75	.70	.69	.63						
400			.88	.86	.80	.76	.73	.68						
450			.94	.93	.85	.82	.77	.73	.71	.66				
500			1.00	1.00	.90	.88	.81	.77	.74	.69				
550			1.06	1.07	.95	.94	.85	.82	.78	.73	.71	.65		
600			1.12	1.14	1.00	1.00	.89	.87	.81	.78	.74	.68		
700					1.10	1.12	.98	.98	.88	.85	.79	.75	.70	.64
800							1.05	1.06	.95	.94	.85	.82	.74	.69
900							1.14	1.16	1.02	1.02	.90	.88	.78	.74
1000									1.09	1.11	.96	.95	.83	.79
1100									1.15	1.18	1.02	1.02	.87	.85
1200											1.07	1.09	.92	.90
1300											1.12	1.14	1.06	1.05
1400													1.00	1.00
1500													1.04	1.05

TH - Total Heat SH - Sensible Heat

ARI APPROVED STANDARD RATINGS							
	MODEL	COIL	CFM	PRESS DROP (FT.WTR.)	COOLING (1000 BTUH)		POWER INPUT (WATTS)
					TH	SH	
PSC MOTOR	3*HBC-3	3-ROW	310	8.0	9.8	6.7	120
	4*HBC-3		510	12.5	13.4	9.5	120
	5*HBC-3		600	8.0	16.3	11.0	130
	6*HBC-3		730	10.5	20.0	14.0	240
	8*HBC-3		870	8.0	22.5	17.0	340
	10*HBC-3		1070	8.0	27.8	20.8	450
	13*HBC-3		1400	14.0	35.5	26.5	530
	3*HBC-4	4-ROW	310	12.0	10.8	7.0	120
	4*HBC-4		510	23.2	16.0	10.6	120
	5*HBC-4		600	12.0	18.0	11.8	130
	6*HBC-4		730	18.0	23.0	15.6	240
	8*HBC-4		870	14.0	26.9	18.9	340
	10*HBC-4		1070	14.0	32.2	23	450
	13*HBC-4		1400	24.0	41.5	29.5	530

Rated in accordance with ARI Standard 440.



Product Specifications

Horizontal Fan Coils
2-Pipe/4-Pipe Hydronic

**BLOWER PERFORMANCE
HBC 120 VOLT PSC**

HBC (120 Volt)													
CFM vs EXTERNAL STATIC PRESSURE (3 ROW 120 Volt)													
MODEL	HP	MAX RPM	AMPS (120V)	FAN SPEED	EXTERNAL STATIC PRESSURE (inches of water)								
					0.05	0.10	0.15	0.20	0.25	0.30	0.35	0.40	0.50
3*HBC-3	1/20	1050	.09	HI	335	300	270	235	---	---	---	---	---
				MED	275	245	220	---	---	---	---	---	
				LOW (4)	230	210	---	---	---	---	---		
4*HBC-3	1/12	1050	1.1	HI	525	480	425	350	---	---	---	---	---
				MED	410	375	330	260	---	---	---	---	
				LOW	350	325	280	---	---	---	---		
5*HBC-3	1/12	1050	1.3	HI	610	560	510	450	375	---	---	---	---
				MED	500	465	425	370	---	---	---	---	
				LOW	355	345	325	290	---	---	---		
6*HBC-3	1/8	1550	1.9	HI	755	730	705	680	650	620	---	---	---
				MED	675	650	620	595	565	540	---	---	
				LOW	570	550	530	510	485	450	---	---	
8*HBC-3	1/5	1550	3.0	HI	950	920	895	870	840	810	775	740	635
				MED	775	755	730	710	690	665	635	605	530
				LOW	690	605	585	560	540	515	485	460	405
10*HBC-3	1/4	1550	3.6	HI	1175	1145	1115	1085	1055	1025	995	960	890
				MED	950	930	915	900	885	870	850	820	745
				LOW	805	795	785	775	755	735	710	680	620
13*HBC-3	1/5 (two)	1550	2.3 Ea.	HI	1545	1500	1455	1450	1365	1320	1280	1235	1120
				MED	1355	1320	1280	1240	1205	1165	1125	1085	975
				LOW	1190	1160	1130	1150	1075	1035	990	940	830
CFM vs EXTERNAL STATIC PRESSURE (4 ROW or 3/1 Split 120 Volt)													
3*HBC-4 -31	1/20	1050	0.9	HI	315	280	250	---	---	---	---	---	---
				MED	260	230	200	---	---	---	---	---	
				LOW (4)	220	195	---	---	---	---	---		
4*HBC-4 -31	1/12	1050	1.1	HI	490	450	395	320	---	---	---	---	---
				MED	405	370	320	250	---	---	---	---	
				LOW	350	320	280	---	---	---	---		
5*HBC-4 -31	1/12	1050	1.3	HI	605	550	500	445	375	---	---	---	---
				MED	500	455	415	365	---	---	---	---	
				LOW	360	340	315	275	---	---	---		
6*HBC-4 -31	1/8	1550	1.9	HI	745	710	675	645	610	580	---	---	---
				MED	745	615	590	560	535	500	---	---	
				LOW	650	535	510	485	455	420	---	---	
8*HBC-4 -31	1/5	1550	3.0	HI	915	885	855	825	800	765	735	705	625
				MED	755	730	705	675	650	620	590	555	480
				LOW	620	595	575	550	530	500	475	440	370
10*HBC-4 -31	1/4	1550	3.6	HI	1140	1110	1080	1045	1010	975	935	890	825
				MED	940	915	895	875	850	825	795	765	680
				LOW	790	775	755	735	715	690	660	630	555
13*HBC-4 -31	1/5 (two)	1550	2.3 Ea.	HI	1495	1450	1405	1360	1310	1165	1215	1165	1055
				MED	1310	1270	1235	1200	1160	1115	1070	1020	930
				LOW	1165	1130	1095	1060	1020	985	940	895	780
CFM vs EXTERNAL STATIC PRESSURE (4/1 or 3/2 Split 120 Volt)													
3*HBC-41 -32	1/20	1050	0.9	HI	305	270	240	---	---	---	---	---	---
				MED	250	225	200	---	---	---	---	---	
				LOW (4)	210	190	---	---	---	---	---		
4*HBC-41 -32	1/12	1050	1.1	HI	470	420	365	290	---	---	---	---	---
				MED	395	355	300	235	---	---	---	---	
				LOW	345	305	270	---	---	---	---		
5*HBC-41 -32	1/12	1050	1.3	HI	575	520	470	415	---	---	---	---	---
				MED	480	440	400	350	---	---	---	---	
				LOW	345	325	300	---	---	---	---		
6*HBC-41 -32	1/8	1550	1.9	HI	660	625	595	565	530	495	---	---	---
				MED	555	520	485	445	425	395	---	---	
				LOW	475	440	410	380	350	320	---	---	
8*HBC-41 -32	1/5	1550	3.0	HI	905	875	845	815	785	750	715	680	605
				MED	755	725	705	680	650	620	590	555	495
				LOW	635	615	595	570	550	525	495	465	405
10*HBC-41 -32	1/4	1550	3.6	HI	1115	1075	1040	1005	970	935	900	860	765
				MED	925	905	880	860	835	805	765	725	630
				LOW	790	765	745	725	700	675	640	605	530
13*HBC-41 -32	1/5 (two)	1550	2.3 Ea.	HI	1470	1420	1370	1320	1270	1220	1165	1105	965
				MED	1355	1315	1265	1220	1170	1115	1060	1005	870
				LOW	1195	1160	1120	1080	1035	985	935	875	745

- Notes:**
1. Motors are 120v/60Hz, high efficiency PSC type
 2. Maximum HACR breaker is 15 amp
 3. Coil fins-per-inch varies to allow consistent air flow
 4. (4) The size 3 motor (models 3(P/R/C)(HBC) may not start on low speed due to low starting torque. These units must be wired to start on either Medium or High speed.

Product Specifications
Horizontal Fan Coils
2-Pipe/4-Pipe Hydronic

BLOWER PERFORMANCE
PHBC 120 VOLT PSC

PHBC (120 Volt)													
CFM vs EXTERNAL STATIC PRESSURE (3 ROW 120 Volt)													
MODEL	HP	MAX RPM	AMPS (120V)	FAN SPEED	EXTERNAL STATIC PRESSURE (inches of water)								
					0.05	0.10	0.15	0.20	0.25	0.30	0.35	0.40	0.50
3PHBC-3	1/20	1050	.09	HI	320	285	250	---	---	---	---	---	---
				MED	260	230	205	---	---	---	---	---	
				LOW (4)	220	200	---	---	---	---	---		
4PHBC-3	1/12	1050	1.1	HI	405	355	295	---	---	---	---	---	
				MED	360	315	255	---	---	---	---		
				LOW	340	305	245	---	---	---	---		
5PHBC-3	1/12	1050	1.3	HI	545	500	445	385	---	---	---	---	
				MED	475	440	395	335	---	---	---		
				LOW	345	320	290	250	---	---	---		
6PHBC-3	1/8	1550	1.9	HI	705	675	650	620	590	555	---	---	
				MED	645	620	595	565	535	505	---		
				LOW	560	540	515	490	460	430	---		
8PHBC-3	1/5	1550	3.0	HI	890	855	820	780	745	710	670	630	
				MED	760	725	695	665	630	595	565	530	
				LOW	620	595	565	540	515	485	455	420	
10PHBC-3	1/4	1550	3.6	HI	1165	1130	1095	1060	1020	975	930	880	
				MED	1065	1025	990	955	915	875	835	795	
				LOW	890	865	840	815	790	765	735	700	
13PHBC-3	1/5 (two)	1550	2.3 Ea.	HI	1345	1295	1250	1205	1155	1100	1045	980	
				MED	1255	1210	1170	1120	1075	1025	970	915	
				LOW	1165	1125	1080	1035	985	930	875	820	
CFM vs EXTERNAL STATIC PRESSURE (4 ROW or 3/1 Split 120 Volt)													
3PHBC-4 -31	1/20	1050	0.9	HI	290	260	230	---	---	---	---	---	
				MED	245	220	---	---	---	---	---		
				LOW (4)	215	185	---	---	---	---	---		
4PHBC-4 -31	1/12	1050	1.1	HI	380	335	285	---	---	---	---	---	
				MED	345	295	---	---	---	---	---		
				LOW	315	275	---	---	---	---	---		
5PHBC-4 -31	1/12	1050	1.3	HI	540	490	435	370	---	---	---	---	
				MED	475	435	365	290	---	---	---		
				LOW	365	340	305	---	---	---	---		
6PHBC-4 -31	1/8	1550	1.9	HI	695	660	630	595	560	520	---	---	
				MED	620	590	560	530	500	465	---		
				LOW	560	525	490	460	425	390	---		
8PHBC-4 -31	1/5	1550	3.0	HI	870	830	795	755	720	685	645	605	
				MED	745	715	680	645	615	580	545	510	
				LOW	605	580	555	535	505	480	445	415	
10PHBC-4 -31	1/4	1550	3.6	HI	1120	1075	1030	990	945	905	865	820	
				MED	1035	1000	960	920	880	840	795	755	
				LOW	905	875	845	815	780	750	715	675	
13PHBC-4 -31	1/5 (two)	1550	2.3 Ea.	HI	1300	1255	1210	1165	1115	1060	1005	940	
				MED	1225	1180	1130	1080	1035	990	935	880	
				LOW	1125	1080	1035	990	945	895	845	795	
CFM vs EXTERNAL STATIC PRESSURE (4/1 or 3/2 Split 120 Volt)													
3PHBC-41 -32	1/20	1050	0.9	HI	285	250	220	---	---	---	---	---	
				MED	235	210	---	---	---	---	---		
				LOW (4)	205	180	---	---	---	---	---		
4PHBC-41 -32	1/12	1050	1.1	HI	370	320	265	---	---	---	---	---	
				MED	325	280	---	---	---	---	---		
				LOW	295	250	---	---	---	---	---		
5PHBC-41 -32	1/12	1050	1.3	HI	505	450	395	335	---	---	---	---	
				MED	445	400	350	295	---	---	---		
				LOW	325	300	270	---	---	---	---		
6PHBC-41 -32	1/8	1550	1.9	HI	665	625	590	555	515	480	---	---	
				MED	605	570	535	505	470	430	---		
				LOW	535	505	470	440	405	370	---		
8PHBC-41 -32	1/5	1550	3.0	HI	845	810	780	750	715	680	640	605	
				MED	725	700	670	640	610	580	550	520	
				LOW	605	580	560	535	505	480	455	425	
10PHBC-41 -32	1/4	1550	3.6	HI	1015	975	940	900	865	825	785	750	
				MED	890	855	825	795	765	735	700	665	
				LOW	770	740	710	685	660	630	600	570	
13PHBC-41 -32	1/5 (two)	1550	2.3 Ea.	HI	1295	1245	1195	1145	1090	1035	975	915	
				MED	1215	1165	1120	1065	1015	960	905	845	
				LOW	1120	1075	1025	975	930	885	835	785	

Notes:

1. Motors are 120v / 60Hz, high efficiency PSC type
2. Maximum HACR breaker is 15 amp
3. Coil fins-per-inch varies to allow consistent air flow
4. (4) The size 3 motor (models 3(P/R/C)HBC) may not start on low speed due to low starting torque. These units must be wired to start on either Medium or High speed.

Product Specifications

Horizontal Fan Coils
2-Pipe/4-Pipe Hydronic

**BLOWER PERFORMANCE
RHBC 120 VOLT PSC**

RHBC (120 Volt)													
CFM vs EXTERNAL STATIC PRESSURE (3 ROW 120 Volt)													
MODEL	HP	MAX RPM	AMPS (120V)	FAN SPEED	EXTERNAL STATIC PRESSURE (inches of water)								
					0.05	0.10	0.15	0.20	0.25	0.30	0.35	0.40	0.50
3RHBC-3	1/20	1050	.09	HI	320	285	250	---	---	---	---	---	---
				MED	260	230	205	---	---	---	---	---	
				LOW (4)	220	200	---	---	---	---	---	---	
4RHBC-3	1/12	1050	1.1	HI	405	355	295	---	---	---	---	---	---
				MED	360	315	255	---	---	---	---	---	
				LOW	340	305	245	---	---	---	---	---	
5RHBC-3	1/12	1050	1.3	HI	545	500	445	385	---	---	---	---	---
				MED	475	440	395	335	---	---	---	---	
				LOW	345	320	290	250	---	---	---	---	
6RHBC-3	1/8	1550	1.9	HI	705	675	650	620	590	555	---	---	---
				MED	645	620	595	565	535	505	---	---	
				LOW	560	540	515	490	460	430	---	---	
8RHBC-3	1/5	1550	3.0	HI	890	855	820	780	745	710	670	630	540
				MED	745	725	695	665	630	600	565	530	460
				LOW	620	595	565	540	515	485	455	420	360
10RHBC-3	1/4	1550	3.6	HI	1165	1130	1095	1060	1020	975	930	880	785
				MED	1065	1025	990	955	915	875	835	795	710
				LOW	890	865	840	815	790	765	735	700	625
13RHBC-3	1/5 (two)	1550	2.3 Ea.	HI	1345	1295	1250	1200	1155	1100	1045	980	855
				MED	1255	1210	1170	1120	1075	1025	970	915	795
				LOW	1165	1125	1080	1035	985	930	875	820	710
CFM vs EXTERNAL STATIC PRESSURE (4 ROW or 3/1 Split 120 Volt)													
3RHBC-4-31	1/20	1050	0.9	HI	290	260	230	---	---	---	---	---	---
				MED	245	220	---	---	---	---	---	---	
				LOW (4)	215	185	---	---	---	---	---	---	
4RHBC-4-31	1/12	1050	1.1	HI	380	335	285	---	---	---	---	---	---
				MED	345	295	---	---	---	---	---	---	
				LOW	315	275	---	---	---	---	---	---	
5RHBC-4-31	1/12	1050	1.3	HI	540	490	435	370	---	---	---	---	---
				MED	475	435	365	290	---	---	---	---	
				LOW	365	340	305	---	---	---	---	---	
6RHBC-4-31	1/8	1550	1.9	HI	695	660	630	595	560	520	---	---	---
				MED	620	590	560	530	500	465	---	---	
				LOW	560	525	490	460	425	390	---	---	
8RHBC-4-31	1/5	1550	3.0	HI	870	830	795	755	720	685	645	605	520
				MED	745	715	680	645	615	580	545	510	440
				LOW	605	580	555	535	505	480	445	415	355
10RHBC-4-31	1/4	1550	3.6	HI	1120	1075	1030	990	945	905	865	820	725
				MED	1035	1000	960	920	880	840	795	755	675
				LOW	905	875	845	815	780	750	715	675	600
13RHBC-4-31	1/5 (two)	1550	2.3 Ea.	HI	1300	1255	1210	1165	1115	1060	1005	940	820
				MED	1225	1180	1130	1080	1035	950	935	880	755
				LOW	1125	1080	1035	990	945	895	845	795	690
CFM vs EXTERNAL STATIC PRESSURE (4/1 or 3/2 Split 120 Volt)													
3RHBC-41-32	1/20	1050	0.9	HI	285	250	220	---	---	---	---	---	---
				MED	235	210	---	---	---	---	---	---	
				LOW (4)	205	180	---	---	---	---	---	---	
4RHBC-41-32	1/12	1050	1.1	HI	370	320	265	---	---	---	---	---	---
				MED	325	280	---	---	---	---	---	---	
				LOW	295	250	---	---	---	---	---	---	
5RHBC-41-32	1/12	1050	1.3	HI	505	450	395	335	---	---	---	---	---
				MED	445	400	350	295	---	---	---	---	
				LOW	325	300	270	---	---	---	---	---	
6RHBC-41-32	1/8	1550	1.9	HI	665	625	590	555	515	480	---	---	---
				MED	605	570	535	505	470	430	---	---	
				LOW	535	505	470	440	405	370	---	---	
8RHBC-41-32	1/5	1550	3.0	HI	845	810	780	750	715	680	640	605	530
				MED	725	700	670	640	610	580	550	520	455
				LOW	605	580	560	535	505	480	455	425	370
10RHBC-41-32	1/4	1550	3.6	HI	1015	975	940	900	865	825	785	750	670
				MED	890	855	825	795	765	735	700	665	590
				LOW	770	740	710	685	655	630	600	570	510
13RHBC-41-32	1/5 (two)	1550	2.3 Ea.	HI	1295	1245	1195	1145	1090	1035	975	915	795
				MED	1215	1165	1120	1065	1015	960	905	845	725
				LOW	1120	1075	1025	975	930	885	835	785	655

Notes:

1. Motors are 120v / 60Hz, high efficiency PSC type
2. Maximum HACR breaker is 15 amp
3. Coil fins-per-inch varies to allow consistent air flow
4. (4) The size 3 motor (models 3(P/R/C)HBC) may not start on low speed due to low starting torque. These units must be wired to start on either Medium or High speed.

Product Specifications

Horizontal Fan Coils
2-Pipe/4-Pipe Hydronic

**BLOWER PERFORMANCE
HBC 277 VOLT PSC**

HBC (277 Volt)													
CFM vs EXTERNAL STATIC PRESSURE (3 ROW 277 Volt)													
MODEL	HP	MAX RPM	AMPS (277V)	FAN SPEED	EXTERNAL STATIC PRESSURE (inches of water)								
					0.05	0.10	0.15	0.20	0.25	0.30	0.35	0.40	0.50
3*HBC-3	1/20	1100	0.48	HI	315	285	255	---	---	---	---	---	---
				MED	245	220	195	---	---	---	---	---	
				LOW	180	160	---	---	---	---	---		
4*HBC-3	1/15	1050	0.52	HI	510	450	390	---	---	---	---	---	---
				MED	410	365	305	---	---	---	---	---	
				LOW	350	315	265	---	---	---	---		
5*HBC-3	1/15	1050	0.52	HI	575	535	490	---	---	---	---	---	---
				MED	405	375	340	---	---	---	---	---	
				LOW	335	305	275	---	---	---	---		
6*HBC-3	1/812	1625	0.56	HI	700	670	640	615	590	560	530	495	---
				MED	570	545	520	490	465	430	400	360	---
				LOW	475	455	430	400	370	340	300	255	---
8*HBC-3	1/6	1550	0.80	HI	905	880	855	830	800	765	725	685	---
				MED	720	700	675	650	625	595	565	535	---
				LOW	605	585	560	530	505	475	450	420	---
10*HBC-3	1/4	1625	1.526	HI	1170	1140	1105	1070	1035	995	950	905	---
				MED	945	920	900	875	850	820	785	740	---
				LOW	780	755	730	705	680	655	625	590	---
13*HBC-3	1/6 (two)	1550	0.80 Ea.	HI	1580	1535	1490	1450	1400	1355	1300	1245	1130
				MED	1380	1340	1300	1260	1215	1170	1125	1075	960
				LOW	1180	1140	1105	1070	1030	990	945	895	775
CFM vs EXTERNAL STATIC PRESSURE (4 ROW or 3/1 Split 277 Volt)													
3*HBC-4-31	1/20	1100	0.48	HI	300	270	---	---	---	---	---	---	---
				MED	240	215	---	---	---	---	---	---	
				LOW	195	175	---	---	---	---	---	---	
4*HBC-4-31	1/15	1050	0.52	HI	485	435	380	---	---	---	---	---	---
				MED	395	355	300	---	---	---	---	---	
				LOW	350	315	265	---	---	---	---	---	
5*HBC-4-31	1/125	1050	0.52	HI	565	525	480	---	---	---	---	---	---
				MED	390	360	325	---	---	---	---	---	
				LOW	330	300	270	---	---	---	---	---	
6*HBC-4-31	1/12	1625	0.56	HI	700	665	635	600	575	545	510	470	---
				MED	570	540	515	490	465	435	400	355	---
				LOW	470	445	420	390	360	330	290	255	---
8*HBC-4-31	1/6	1550	0.80	HI	865	835	805	780	745	710	670	625	---
				MED	705	680	660	630	605	570	535	495	---
				LOW	580	555	535	505	475	445	415	395	---
10*HBC-4-31	1/4	1625	1.526	HI	1140	1100	1065	1025	990	950	915	880	---
				MED	915	890	870	845	820	790	755	715	---
				LOW	770	745	720	695	670	640	615	585	---
13*HBC-4-31	1/6 (two)	1550	0.80 Ea.	HI	1510	1465	1420	1370	1325	1275	1225	1170	1050
				MED	1320	1280	1245	1205	1165	1120	1075	1025	905
				LOW	1140	1110	1075	1040	1005	965	920	865	745
CFM vs EXTERNAL STATIC PRESSURE (4/1 or 3/2 Split 277 Volt)													
3*HBC-41-32	1/20	1100	0.48	HI	295	265	---	---	---	---	---	---	---
				MED	235	210	---	---	---	---	---	---	
				LOW	190	160	---	---	---	---	---	---	
4*HBC-41-32	1/15	1050	0.52	HI	485	440	390	---	---	---	---	---	---
				MED	400	360	310	---	---	---	---	---	
				LOW	345	315	270	---	---	---	---	---	
5*HBC-41-32	1/15	1050	0.52	HI	525	475	430	---	---	---	---	---	---
				MED	385	350	310	---	---	---	---	---	
				LOW	320	285	250	---	---	---	---	---	
6*HBC-41-32	1/12	1625	0.56	HI	660	630	600	575	545	515	480	---	---
				MED	540	510	485	460	430	395	360	---	---
				LOW	455	430	405	380	350	315	280	---	---
8*HBC-41-32	1/6	1550	0.80	HI	865	830	800	775	740	705	665	625	---
				MED	690	660	630	605	575	545	515	485	---
				LOW	580	550	525	495	470	440	415	385	---
10*HBC-41-32	1/4	1625	1.26	HI	1100	1065	1030	995	950	900	850	795	---
				MED	940	905	870	845	820	790	750	675	---
				LOW	770	750	730	710	685	645	600	454	---
13*HBC-41-32	1/6 (two)	1550	0.80 Ea.	HI	1460	1415	1365	1320	1270	1225	1175	1120	1005
				MED	1285	1245	1210	1170	1125	1085	1035	985	855
				LOW	1130	1090	1050	1005	970	930	885	840	710

Notes:

1. Motors are 277v / 60Hz, high efficiency PSC type
2. Maximum HACR breaker is 15 amp
3. coil fins-per-inch varies to allow consistent air flow

Product Specifications

Horizontal Fan Coils
2-Pipe/4-Pipe Hydronic

**BLOWER PERFORMANCE
PHBC 277 VOLT PSC**

PHBC (277 Volt)													
CFM vs EXTERNAL STATIC PRESSURE (3 ROW 277 Volt)													
MODEL	HP	MAX RPM	AMPS (277V)	FAN SPEED	EXTERNAL STATIC PRESSURE (inches of water)								
					0.05	0.10	0.15	0.20	0.25	0.30	0.35	0.40	0.50
3*PHBC-3	1/20	1100	0.48	HI	290	260	---	---	---	---	---	---	---
				MED	230	200	---	---	---	---	---	---	
				LOW	180	155	---	---	---	---	---	---	
4*PHBC-3	1/15	1050	0.52	HI	395	340	---	---	---	---	---	---	
				MED	345	295	---	---	---	---	---	---	
				LOW	310	265	---	---	---	---	---	---	
5*PHBC-3	1/15	1050	0.52	HI	500	460	415	---	---	---	---	---	
				MED	385	350	310	---	---	---	---	---	
				LOW	330	295	260	---	---	---	---	---	
6*PHBC-3	1/12	1625	0.56	HI	665	630	595	565	540	510	475	430	
				MED	545	515	490	465	440	410	375	335	
				LOW	460	430	400	375	350	320	290	250	
8*PHBC-3	1/6	1550	0.80	HI	850	820	790	760	725	685	645	605	
				MED	695	665	640	610	585	555	525	490	
				LOW	575	550	525	500	470	445	420	395	
10*PHBC-3	1/4	1625	1.26	HI	1040	1000	960	920	885	850	810	775	
				MED	885	850	810	780	745	720	690	665	
				LOW	710	680	655	635	610	590	565	540	
13*PHBC-3	1/6 (two)	1550	0.80 Ea.	HI	1385	1340	1295	1250	1205	1155	1100	1040	
				MED	1250	1210	1170	1130	1085	1040	985	930	
				LOW	1110	1070	1030	990	945	900	850	800	
CFM vs EXTERNAL STATIC PRESSURE (4 ROW or 3/1 Split 277 Volt)													
3*PHBC-4-31	1/20	1100	0.48	HI	280	255	---	---	---	---	---	---	
				MED	230	200	---	---	---	---	---	---	
				LOW	185	160	---	---	---	---	---	---	
4*PHBC-4-31	1/15	1050	0.52	HI	395	340	---	---	---	---	---	---	
				MED	345	295	---	---	---	---	---	---	
				LOW	305	255	---	---	---	---	---	---	
5*PHBC-4-31	1/15	1050	0.52	HI	500	455	405	---	---	---	---	---	
				MED	380	340	305	---	---	---	---	---	
				LOW	330	295	260	---	---	---	---	---	
6*PHBC-4-31	1/12	1625	0.56	HI	650	615	585	555	525	490	450	405	
				MED	540	510	480	450	425	390	355	320	
				LOW	460	430	400	375	345	315	280	240	
8*PHBC-4-31	1/6	1550	0.80	HI	825	790	760	725	685	650	610	570	
				MED	670	640	615	585	560	530	495	465	
				LOW	560	530	500	475	445	420	395	365	
10*PHBC-4-31	1/4	1625	1.26	HI	1020	980	940	905	865	830	790	750	
				MED	890	855	820	790	755	725	695	660	
				LOW	740	710	685	660	635	610	585	555	
13*PHBC-4-31	1/6 (two)	1550	0.80 Ea.	HI	1335	1290	1245	1200	1155	1105	1045	985	
				MED	1205	1170	1135	1095	1050	1000	940	875	
				LOW	1075	1040	1000	960	915	870	820	765	
CFM vs EXTERNAL STATIC PRESSURE (4/1 or 3/2 Split 277 Volt)													
3*PHBC-41-32	1/20	1100	0.48	HI	275	245	---	---	---	---	---	---	
				MED	225	200	---	---	---	---	---	---	
				LOW	185	155	---	---	---	---	---	---	
4*PHBC-41-32	1/15	1050	0.52	HI	395	345	---	---	---	---	---	---	
				MED	340	300	---	---	---	---	---	---	
				LOW	300	260	---	---	---	---	---	---	
5*PHBC-41-32	1/15	1050	0.52	HI	465	405	365	---	---	---	---	---	
				MED	365	325	280	---	---	---	---	---	
				LOW	305	270	235	---	---	---	---	---	
6*PHBC-41-32	1/12	1625	0.56	HI	610	580	550	520	485	450	415	370	
				MED	515	485	455	430	400	370	335	300	
				LOW	440	410	385	355	325	295	260	215	
8*PHBC-41-32	1/6	1550	0.80	HI	805	775	740	710	675	640	605	570	
				MED	665	635	605	575	550	520	490	460	
				LOW	560	530	505	475	450	425	400	370	
10*PHBC-41-32	1/4	1625	1.26	HI	990	950	915	885	850	815	760	690	
				MED	875	835	805	775	745	715	680	620	
				LOW	735	700	675	650	625	595	560	510	
13*PHBC-41-32	1/6 (two)	1550	0.80 Ea.	HI	1285	1240	1195	1150	1100	1045	990	925	
				MED	1170	1130	1090	1050	1005	955	900	840	
				LOW	1045	1010	975	940	895	845	795	735	

- Notes:**
1. Motors are 277v / 60Hz, high efficiency PSC type
 2. Maximum HACR breaker is 15 amp
 3. coil fins-per-inch varies to allow consistent air flow

Product Specifications

Horizontal Fan Coils
2-Pipe/4-Pipe Hydronic

BLOWER PERFORMANCE RHBC 277 VOLT PSC

RHBC (277 Volt)													
CFM vs EXTERNAL STATIC PRESSURE (3 ROW 277 Volt)													
MODEL	HP	MAX RPM	AMPS (277V)	FAN SPEED	EXTERNAL STATIC PRESSURE (inches of water)								
					0.05	0.10	0.15	0.20	0.25	0.30	0.35	0.40	0.50
3*RHBC-3	1/20	1100	0.48	HI	290	260	---	---	---	---	---	---	---
				MED	230	200	---	---	---	---	---	---	
				LOW	180	155	---	---	---	---	---	---	
4*RHBC-3	1/15	1050	0.52	HI	395	340	---	---	---	---	---	---	
				MED	345	295	---	---	---	---	---	---	
				LOW	310	265	---	---	---	---	---	---	
5*RHBC-3	1/15	1050	0.52	HI	500	460	415	---	---	---	---	---	
				MED	385	350	310	---	---	---	---	---	
				LOW	330	295	260	---	---	---	---	---	
6*RHBC-3	1/12	1625	0.56	HI	665	630	595	565	540	510	475	430	
				MED	545	515	490	465	440	410	375	335	
				LOW	460	430	400	375	350	320	290	250	
8*RHBC-3	1/6	1550	0.80	HI	850	820	790	760	725	685	645	605	
				MED	695	665	640	610	585	555	525	490	
				LOW	575	550	525	500	470	445	420	395	
10*RHBC-3	1/4	1625	1.26	HI	1040	1000	960	920	885	850	810	775	
				MED	885	850	810	780	745	720	690	665	
				LOW	710	680	655	635	610	590	565	540	
13*RHBC-3	1/6 (two)	1550	0.80 Ea.	HI	1385	1340	1295	1250	1205	1155	1100	1040	
				MED	1250	1210	1170	1130	1085	1040	985	930	
				LOW	1110	1070	1030	990	945	900	850	800	
CFM vs EXTERNAL STATIC PRESSURE (4 ROW or 3/1 Split 277 Volt)													
3*RHBC-4 -31	1/20	1100	0.48	HI	280	255	---	---	---	---	---	---	
				MED	230	200	---	---	---	---	---	---	
				LOW	185	160	---	---	---	---	---	---	
4*RHBC-4 -31	1/15	1050	0.52	HI	395	340	---	---	---	---	---		
				MED	345	295	---	---	---	---	---	---	
				LOW	305	255	---	---	---	---	---	---	
5*RHBC-4 -31	1/15	1050	0.52	HI	500	455	405	---	---	---	---		
				MED	380	340	305	---	---	---	---	---	
				LOW	330	295	260	---	---	---	---	---	
6*RHBC-4 -31	1/12	1625	0.56	HI	650	615	585	555	525	490	450	405	
				MED	540	510	480	450	425	390	355	320	
				LOW	460	430	400	375	345	315	280	240	
8*RHBC-4 -31	1/6	1550	0.80	HI	825	790	760	725	685	650	610	570	
				MED	670	640	615	585	560	530	495	465	
				LOW	560	530	500	475	445	420	395	365	
10*RHBC-4 -31	1/4	1625	1.26	HI	1020	980	940	905	865	830	790	750	
				MED	890	855	820	790	755	725	685	660	
				LOW	740	710	685	660	635	610	585	555	
13*RHBC-4 -31	1/6 (two)	1550	0.80 Ea.	HI	1335	1290	1245	1200	1155	1105	1045	985	
				MED	1205	1170	1135	1095	1050	1000	940	875	
				LOW	1075	1040	1000	960	915	870	820	765	
CFM vs EXTERNAL STATIC PRESSURE (4/1 or 3/2 Split 277 Volt)													
3*RHBC-41 -32	1/20	1100	0.48	HI	275	245	---	---	---	---	---	---	
				MED	225	200	---	---	---	---	---	---	
				LOW	185	155	---	---	---	---	---	---	
4*RHBC-41 -32	1/15	1050	0.52	HI	395	345	---	---	---	---	---		
				MED	340	300	---	---	---	---	---	---	
				LOW	300	260	---	---	---	---	---	---	
5*RHBC-41 -32	1/15	1050	0.52	HI	465	415	365	---	---	---	---		
				MED	365	325	280	---	---	---	---	---	
				LOW	305	270	235	---	---	---	---	---	
6*RHBC-41 -32	1/12	1625	0.56	HI	610	580	550	520	485	450	415	370	
				MED	515	485	455	430	400	370	335	300	
				LOW	440	410	385	355	325	295	260	215	
8*RHBC-41 -32	1/6	1550	0.80	HI	805	775	740	710	675	640	605	570	
				MED	665	635	605	575	550	520	490	460	
				LOW	560	530	505	475	450	425	400	370	
10*RHBC-41 -32	1/4	1625	1.26	HI	990	950	915	885	850	815	760	690	
				MED	875	835	805	775	745	715	680	620	
				LOW	735	700	675	650	625	595	560	510	
13*RHBC-41 -32	1/6 (two)	1550	0.80 Ea.	HI	1285	1240	1195	1150	1100	1045	990	925	
				MED	1170	1130	1090	1050	1005	955	900	840	
				LOW	1045	1010	975	940	895	845	795	735	

Notes:

1. Motors are 277v / 60Hz, high efficiency PSC type
2. Maximum HACR breaker is 15 amp
3. coil fins-per-inch varies to allow consistent air flow

Product Specifications

Horizontal Fan Coils
2-Pipe/4-Pipe Hydronic

**BLOWER PERFORMANCE
HBC 220 VOLT/ 50Hz PSC**

HBC (220 Volt / 50Hz)													
CFM vs EXTERNAL STATIC PRESSURE (3 ROW 220 Volt)													
MODEL	HP	MAX RPM	AMPS (220V)	FAN SPEED	EXTERNAL STATIC PRESSURE (inches of water)								
					0.05	0.10	0.15	0.20	0.25	0.30	0.35	0.40	0.50
3*HBC-3	1/20	1075	0.40	HI	240	220	---	---	---	---	---	---	---
				MED	205	175	---	---	---	---	---	---	
				LOW	155	---	---	---	---	---	---		
4*HBC-3	1/12	1050	0.55	HI	470	430	390	335	---	---	---	---	---
				MED	380	340	300	250	---	---	---	---	
				LOW	310	265	220	---	---	---	---		
5*HBC-3	1/12	1050	0.55	HI	455	405	355	---	---	---	---	---	---
				MED	365	325	275	---	---	---	---	---	
				LOW	285	245	210	---	---	---	---		
6*HBC-3	1/5	1550	1.02	HI	675	630	585	540	495	450	---	---	---
				MED	570	530	495	455	415	365	---	---	
				LOW	490	455	415	370	320	265	---	---	
8*HBC-3	1/5	1550	1.02	HI	860	825	790	750	715	675	630	---	---
				MED	630	610	585	560	535	500	455	---	---
				LOW	435	415	400	375	350	320	---	---	
10*HBC-3	1/4	1625	1.53	HI	1080	1025	975	915	860	795	735	665	---
				MED	850	815	775	735	685	635	575	520	---
				LOW	675	645	615	580	540	500	455	410	---
13*HBC-3	1/5 (two)	1550	1.02 Ea.	HI	1355	1295	1225	1160	1100	1030	955	865	---
				MED	1165	1115	1070	1020	965	895	810	710	---
				LOW	890	865	830	795	745	690	615	520	---
CFM vs EXTERNAL STATIC PRESSURE (4 ROW or 3/1 Split 220 Volt)													
3*HBC-4 -31	1/20	1075	0.40	HI	240	215	---	---	---	---	---	---	---
				MED	205	180	---	---	---	---	---	---	
				LOW	160	---	---	---	---	---	---		
4*HBC-4 -31	1/12	1050	0.55	HI	460	425	390	345	---	---	---	---	---
				MED	380	345	300	255	---	---	---	---	
				LOW	305	265	225	---	---	---	---		
5*HBC-4 -31	1/12	1050	0.55	HI	440	395	345	---	---	---	---	---	---
				MED	360	320	275	---	---	---	---	---	
				LOW	310	245	200	---	---	---	---		
6*HBC-4 -31	1/5	1550	1.02	HI	665	620	575	535	490	440	---	---	---
				MED	575	535	495	460	420	370	---	---	
				LOW	485	450	415	370	310	250	---	---	
8*HBC-4 -31	1/5	1550	1.02	HI	810	765	725	690	650	610	565	---	---
				MED	615	585	560	530	495	460	415	---	---
				LOW	420	400	385	365	340	300	---	---	
10*HBC-4 -31	1/4	1625	1.53	HI	1015	965	915	865	815	760	700	640	---
				MED	875	840	805	765	720	670	615	555	---
				LOW	730	695	665	625	585	540	475	390	---
13*HBC-4 -31	1/5 (two)	1550	1.02 Ea.	HI	1240	1185	1125	1065	1000	920	830	730	---
				MED	1085	1035	990	930	860	775	680	590	---
				LOW	860	830	795	745	685	610	525	440	---
CFM vs EXTERNAL STATIC PRESSURE (4/1 or 3/2 Split 220 Volt)													
3*HBC-41 -32	1/20	1075	0.40	HI	235	210	---	---	---	---	---	---	---
				MED	200	170	---	---	---	---	---	---	
				LOW	160	---	---	---	---	---	---		
4*HBC-41 -32	1/12	1050	0.55	HI	450	410	370	---	---	---	---	---	---
				MED	365	325	290	---	---	---	---	---	
				LOW	295	255	220	---	---	---	---		
5*HBC-41 -32	1/12	1050	0.55	HI	425	375	325	---	---	---	---	---	---
				MED	350	305	260	---	---	---	---	---	
				LOW	280	240	200	---	---	---	---		
6*HBC-41 -32	1/5	1550	1.02	HI	605	570	535	495	450	395	---	---	---
				MED	535	500	465	425	385	330	---	---	
				LOW	460	420	380	345	300	---	---		
8*HBC-41 -32	1/5	1550	1.02	HI	805	760	720	680	645	610	565	---	---
				MED	620	590	560	530	495	460	420	---	---
				LOW	425	405	390	365	340	305	---	---	
10*HBC-41 -32	1/4	1625	1.53	HI	985	940	895	850	790	725	645	555	---
				MED	875	835	795	755	710	650	580	485	---
				LOW	715	690	660	625	580	535	490	450	---
13*HBC-41 -32	1/5 (two)	1550	1.02 Ea.	HI	1195	1140	1085	1025	960	885	795	690	---
				MED	1060	1010	955	900	830	750	660	555	---
				LOW	835	805	770	720	665	590	510	415	---

- Notes:**
1. Motors are 220v / 50Hz, high efficiency PSC type
 2. Maximum HACR breaker is 15 amp
 3. coil fins-per-inch varies to allow consistent air flow

Product Specifications

Horizontal Fan Coils
2-Pipe/4-Pipe Hydronic

BLOWER PERFORMANCE PHBC 220 VOLT/ 50Hz PSC

PHBC (220 Volt / 50Hz)														
CFM vs EXTERNAL STATIC PRESSURE (3 ROW 220 Volt)														
MODEL	HP	MAX RPM	AMPS (220V)	FAN SPEED	EXTERNAL STATIC PRESSURE (inches of water)									
					0.05	0.10	0.15	0.20	0.25	0.30	0.35	0.40	0.50	
3*PHBC-3	1/20	1075	0.40	HI	230	200	---	---	---	---	---	---	---	---
				MED	195	160	---	---	---	---	---	---	---	---
				LOW	150	---	---	---	---	---	---	---	---	---
4*PHBC-3	1/12	1050	0.55	HI	420	380	335	---	---	---	---	---	---	---
				MED	350	305	265	---	---	---	---	---	---	---
				LOW	275	240	200	---	---	---	---	---	---	---
5*PHBC-3	1/12	1050	0.55	HI	410	365	---	---	---	---	---	---	---	---
				MED	340	295	---	---	---	---	---	---	---	---
				LOW	270	230	---	---	---	---	---	---	---	---
6*PHBC-3	1/5	1550	1.02	HI	585	540	500	455	410	---	---	---	---	---
				MED	520	480	440	400	350	---	---	---	---	---
				LOW	455	415	375	325	275	---	---	---	---	---
8*PHBC-3	1/5	1550	1.02	HI	795	750	700	660	620	580	535	---	---	---
				MED	605	580	555	530	500	460	410	---	---	---
				LOW	425	405	390	365	340	---	---	---	---	---
10*PHBC-3	1/4	1625	1.53	HI	920	865	810	755	700	650	595	545	---	---
				MED	825	775	730	680	635	585	540	490	---	---
				LOW	685	640	605	570	535	495	440	365	---	---
13*PHBC-3	1/5 (two)	1550	1.02 Ea.	HI	1165	1110	1055	1000	935	860	775	680	---	---
				MED	1050	1000	945	890	825	760	680	580	---	---
				LOW	855	815	775	730	680	625	555	465	---	---
CFM vs EXTERNAL STATIC PRESSURE (4 ROW or 3/1 Split 220 Volt)														
3*PHBC-4-31	1/20	1075	0.40	HI	225	200	---	---	---	---	---	---	---	---
				MED	190	165	---	---	---	---	---	---	---	---
				LOW	150	---	---	---	---	---	---	---	---	---
4*PHBC-4-31	1/12	1050	0.55	HI	405	370	330	---	---	---	---	---	---	---
				MED	340	310	275	---	---	---	---	---	---	---
				LOW	275	240	200	---	---	---	---	---	---	---
5*PHBC-4-31	1/12	1050	0.55	HI	410	365	---	---	---	---	---	---	---	---
				MED	330	290	---	---	---	---	---	---	---	---
				LOW	270	225	---	---	---	---	---	---	---	---
6*PHBC-4-31	1/5	1550	1.02	HI	585	545	505	460	410	355	---	---	---	---
				MED	520	480	440	395	345	295	---	---	---	---
				LOW	455	415	370	325	280	225	---	---	---	---
8*PHBC-4-31	1/5	1550	1.02	HI	745	705	665	625	580	535	485	---	---	---
				MED	590	560	535	500	465	420	370	---	---	---
				LOW	415	395	375	355	325	285	240	---	---	---
10*PHBC-4-31	1/4	1625	1.53	HI	865	815	770	725	675	625	570	---	---	---
				MED	785	735	695	650	610	570	520	---	---	---
				LOW	665	630	595	560	520	475	420	---	---	---
13*PHBC-4-31	1/5 (two)	1550	1.02 Ea.	HI	1080	1020	965	905	835	760	670	---	---	---
				MED	985	930	870	810	745	665	585	---	---	---
				LOW	825	785	740	685	625	555	475	---	---	---
CFM vs EXTERNAL STATIC PRESSURE (4/1 or 3/2 Split 220 Volt)														
3*PHBC-41-32	1/20	1075	0.40	HI	225	195	---	---	---	---	---	---	---	---
				MED	190	160	---	---	---	---	---	---	---	---
				LOW	145	---	---	---	---	---	---	---	---	---
4*PHBC-41-32	1/12	1050	0.55	HI	395	355	315	---	---	---	---	---	---	---
				MED	330	295	260	---	---	---	---	---	---	---
				LOW	260	215	170	---	---	---	---	---	---	---
5*PHBC-41-32	1/12	1050	0.55	HI	395	345	---	---	---	---	---	---	---	---
				MED	325	285	---	---	---	---	---	---	---	---
				LOW	265	225	---	---	---	---	---	---	---	---
6*PHBC-41-32	1/5	1550	1.02	HI	535	495	460	415	370	---	---	---	---	---
				MED	485	445	405	365	320	---	---	---	---	---
				LOW	430	390	350	305	260	---	---	---	---	---
8*PHBC-41-32	1/5	1550	1.02	HI	740	700	660	615	575	525	---	---	---	---
				MED	590	560	530	500	470	430	---	---	---	---
				LOW	420	400	380	360	330	300	---	---	---	---
10*PHBC-41-32	1/4	1625	1.53	HI	850	800	755	705	655	600	540	---	---	---
				MED	785	735	680	635	590	545	490	---	---	---
				LOW	660	615	575	540	505	465	410	---	---	---
13*PHBC-41-32	1/5 (two)	1550	1.02 Ea.	HI	1030	975	920	860	790	715	630	---	---	---
				MED	950	895	835	775	705	630	550	---	---	---
				LOW	800	755	705	650	595	530	455	---	---	---

Notes:

1. Motors are 220v / 50Hz, high efficiency PSC type
2. Maximum HACR breaker is 15 amp
3. coil fins-per-inch varies to allow consistent air flow

Product Specifications

Horizontal Fan Coils
2-Pipe/4-Pipe Hydronic

**BLOWER PERFORMANCE
RHBC 220 VOLT/ 50Hz PSC**

RHBC (220 Volt / 50Hz)													
CFM vs EXTERNAL STATIC PRESSURE (3 ROW 220 Volt)													
MODEL	HP	MAX RPM	AMPS (220V)	FAN SPEED	EXTERNAL STATIC PRESSURE (inches of water)								
					0.05	0.10	0.15	0.20	0.25	0.30	0.35	0.40	0.50
3*RHBC-3	1/20	1075	0.40	HI	230	200	---	---	---	---	---	---	---
				MED	195	160	---	---	---	---	---	---	
				LOW	150	---	---	---	---	---	---		
4*RHBC-3	1/12	1050	0.55	HI	420	380	335	---	---	---	---	---	
				MED	350	305	265	---	---	---	---	---	
				LOW	275	240	200	---	---	---	---		
5*RHBC-3	1/12	1050	0.55	HI	410	365	---	---	---	---	---	---	
				MED	340	295	---	---	---	---	---	---	
				LOW	270	230	---	---	---	---	---		
6*RHBC-3	1/5	1550	1.02	HI	585	540	500	455	410	---	---	---	
				MED	520	480	440	400	350	---	---	---	
				LOW	455	415	375	325	275	---	---		
8*RHBC-3	1/5	1550	1.02	HI	795	750	700	660	620	580	535	---	
				MED	605	580	555	530	500	460	410	---	
				LOW	425	405	390	365	340	---	---		
10*RHBC-3	1/4	1625	1.53	HI	920	865	810	755	700	650	595	545	
				MED	825	775	730	680	635	585	540	490	
				LOW	685	640	605	570	535	495	440	365	
13*RHBC-3	1/5 (two)	1550	1.02 Ea.	HI	1165	1110	1055	1000	935	860	775	680	
				MED	1050	1000	945	890	825	760	680	580	
				LOW	855	815	775	730	680	625	555	465	
CFM vs EXTERNAL STATIC PRESSURE (4 ROW or 3/1 Split 220 Volt)													
3*RHBC-4-31	1/20	1075	0.40	HI	225	200	---	---	---	---	---	---	
				MED	190	165	---	---	---	---	---	---	
				LOW	150	---	---	---	---	---	---		
4*RHBC-4-31	1/12	1050	0.55	HI	405	370	330	---	---	---	---	---	
				MED	340	310	275	---	---	---	---	---	
				LOW	275	240	200	---	---	---	---		
5*RHBC-4-31	1/12	1050	0.55	HI	410	365	---	---	---	---	---	---	
				MED	330	290	---	---	---	---	---	---	
				LOW	270	225	---	---	---	---	---		
6*RHBC-4-31	1/5	1550	1.02	HI	585	545	505	460	410	355	---	---	
				MED	520	480	440	395	345	295	---	---	
				LOW	455	415	370	325	280	225	---		
8*RHBC-4-31	1/5	1550	1.02	HI	745	705	665	625	580	535	485	---	
				MED	590	560	535	500	465	420	370	---	
				LOW	415	395	375	355	325	285	240	---	
10*RHBC-4-31	1/4	1625	1.53	HI	865	815	770	725	675	625	570	---	
				MED	785	735	695	650	610	570	520	---	
				LOW	665	630	595	560	520	475	420	---	
13*RHBC-4-31	1/5 (two)	1550	1.02 Ea.	HI	1080	1020	965	905	835	760	670	---	
				MED	985	930	870	810	745	665	585	---	
				LOW	825	785	740	685	625	555	475	---	
CFM vs EXTERNAL STATIC PRESSURE (4/1 or 3/2 Split 220 Volt)													
3*RHBC-41-32	1/20	1075	0.40	HI	225	195	---	---	---	---	---	---	
				MED	190	160	---	---	---	---	---	---	
				LOW	145	---	---	---	---	---	---		
4*RHBC-41-32	1/12	1050	0.55	HI	395	355	315	---	---	---	---	---	
				MED	330	295	260	---	---	---	---	---	
				LOW	260	215	170	---	---	---	---		
5*RHBC-41-32	1/12	1050	0.55	HI	395	345	---	---	---	---	---	---	
				MED	325	285	---	---	---	---	---	---	
				LOW	265	225	---	---	---	---	---		
6*RHBC-41-32	1/5	1550	1.02	HI	535	495	460	415	370	---	---	---	
				MED	485	445	405	365	320	---	---	---	
				LOW	430	390	350	305	260	---	---		
8*RHBC-41-32	1/5	1550	1.02	HI	740	700	660	615	575	525	---	---	
				MED	590	560	530	500	470	430	---	---	
				LOW	420	400	380	360	330	---	---		
10*RHBC-41-32	1/4	1625	1.53	HI	850	800	755	705	655	600	540	---	
				MED	785	735	680	635	590	545	490	---	
				LOW	660	615	575	540	505	465	410	---	
13*RHBC-41-32	1/5 (two)	1550	1.02 Ea.	HI	1030	975	920	860	790	715	630	---	
				MED	950	895	835	775	705	630	550	---	
				LOW	800	755	705	650	595	530	455	---	

- Notes:**
1. Motors are 220v / 50Hz, high efficiency PSC type
 2. Maximum HACR breaker is 15 amp
 3. coil fins-per-inch varies to allow consistent air flow

Product Specifications

Horizontal Fan Coils
2-Pipe/4-Pipe Hydronic

**BLOWER PERFORMANCE
CHBC (ALL) PSC**

CHBC (120 Volt)					
(3 ROW 120 Volt)					
MODEL	HP	MAX RPM	AMPS (120V)	FAN SPEED	CFM
3*CHBC-3	1/20	1050	.09	HI	300
				MED	245
				LOW	210
4*CHBC-3	1/12	1050	1.1	HI	480
				MED	375
				LOW	325
5*CHBC-3	1/12	1050	1.3	HI	560
				MED	465
				LOW	345
6*CHBC-3	1/8	1550	1.9	HI	730
				MED	650
				LOW	550
8*CHBC-3	1/5	1550	3.0	HI	920
				MED	750
				LOW	605
10*CHBC-3	1/4	1550	3.6	HI	1145
				MED	930
				LOW	795
13*CHBC-3	1/5 (two)	1550	2.3 Ea.	HI	1500
				MED	1320
				LOW	1160
(4 ROW or 3/1 Split 120 Volt)					
3*CHBC-4-31	1/20	1050	0.9	HI	280
				MED	230
				LOW	195
4*CHBC-4-31	1/12	1050	1.1	HI	450
				MED	370
				LOW	320
5*CHBC-4-31	1/12	1050	1.3	HI	550
				MED	455
				LOW	340
6*CHBC-4-31	1/8	1550	1.9	HI	710
				MED	615
				LOW	535
8*CHBC-4-31	1/5	1550	3.0	HI	885
				MED	730
				LOW	595
10*CHBC-4-31	1/4	1550	3.6	HI	1110
				MED	915
				LOW	770
13*CHBC-4-31	1/5 (two)	1550	2.3 Ea.	HI	1450
				MED	1270
				LOW	1130
(4/1 or 3/2 Split 120 Volt)					
3*CHBC-41-32	1/20	1050	0.9	HI	270
				MED	225
				LOW	190
4*CHBC-41-32	1/12	1050	1.1	HI	420
				MED	355
				LOW	305
5*CHBC-41-32	1/12	1050	1.3	HI	520
				MED	440
				LOW	325
6*CHBC-41-32	1/8	1550	1.9	HI	625
				MED	520
				LOW	440
8*CHBC-41-32	1/5	1550	3.0	HI	875
				MED	725
				LOW	615
10*CHBC-41-32	1/4	1550	3.6	HI	1075
				MED	900
				LOW	765
13*CHBC-41-32	1/5 (two)	1550	2.3 Ea.	HI	1420
				MED	1315
				LOW	1160

CHBC (277 Volt)					
(3 ROW 277 Volt)					
MODEL	HP	MAX RPM	AMPS (120V)	FAN SPEED	CFM
3*CHBC-3	1/20	1100	0.48	HI	285
				MED	220
				LOW	160
4*CHBC-3	1/15	105	0.52	HI	450
				MED	365
				LOW	315
5*CHBC-3	1/15	1050	0.52	HI	535
				MED	375
				LOW	305
6*CHBC-3	1/12	1625	0.56	HI	670
				MED	545
				LOW	455
8*CHBC-3	1/6	1550	0.80	HI	880
				MED	700
				LOW	585
10*CHBC-3	1/4	1625	1.26	HI	1140
				MED	920
				LOW	755
13*CHBC-3	1/6 (two)	1550	0.80 Ea.	HI	1535
				MED	1340
				LOW	1140
(4 ROW or 3/1 Split 277 Volt)					
3*CHBC-4-31	1/20	1100	0.48	HI	270
				MED	215
				LOW	175
4*CHBC-4-31	1/15	1050	0.52	HI	435
				MED	355
				LOW	315
5*CHBC-4-31	1/15	1050	0.52	HI	525
				MED	360
				LOW	300
6*CHBC-4-31	1/12	1625	0.56	HI	665
				MED	540
				LOW	445
8*CHBC-4-31	1/6	1550	0.80	HI	835
				MED	680
				LOW	555
10*CHBC-4-31	1/4	1625	1.26	HI	1100
				MED	890
				LOW	745
13*CHBC-4-31	1/56 (two)	1550	0.80 Ea.	HI	1465
				MED	1280
				LOW	1110
(4/1 or 3/2 Split 277 Volt)					
3*CHBC-41-32	1/20	1100	0.48	HI	265
				MED	210
				LOW	160
4*CHBC-41-32	1/15	1050	0.52	HI	440
				MED	355
				LOW	315
5*CHBC-41-32	1/15	1050	0.52	HI	480
				MED	350
				LOW	285
6*CHBC-41-32	1/12	1625	0.56	HI	630
				MED	510
				LOW	430
8*CHBC-41-32	1/6	1550	0.80	HI	830
				MED	660
				LOW	550
10*CHBC-41-32	1/4	1625	1.26	HI	1065
				MED	905
				LOW	750
13*CHBC-41-32	1/6 (two)	1550	0.80 Ea.	HI	1415
				MED	1245
				LOW	1090

CHBC (220 Volt / 50Hz)					
(3 ROW 220 Volt / 50Hz)					
MODEL	HP	MAX RPM	AMPS (120V)	FAN SPEED	CFM
3*CHBC-3	1/20	1075	0.40	HI	225
				MED	175
				LOW	125
4*CHBC-3	1/12	1050	0.55	HI	430
				MED	340
				LOW	265
5*CHBC-3	1/12	1050	0.55	HI	405
				MED	325
				LOW	245
6*CHBC-3	1/5	1550	1.02	HI	630
				MED	530
				LOW	455
8*CHBC-3	1/5	1550	1.02	HI	825
				MED	610
				LOW	415
10*CHBC-3	1/4	1625	1.53	HI	1025
				MED	815
				LOW	645
13*CHBC-3	1/5 (two)	1550	1.02 Ea.	HI	1295
				MED	1115
				LOW	865
(4 ROW or 3/1 Split 220 Volt / 50Hz)					
3*CHBC-4-31	1/20	1075	0.40	HI	225
				MED	180
				LOW	130
4*CHBC-4-31	1/12	1050	0.55	HI	425
				MED	345
				LOW	265
5*CHBC-4-31	1/12	1050	0.55	HI	395
				MED	320
				LOW	245
6*CHBC-4-31	1/5	1550	1.02	HI	620
				MED	535
				LOW	450
8*CHBC-4-31	1/5	1550	1.02	HI	765
				MED	585
				LOW	400
10*CHBC-4-31	1/4	1625	1.53	HI	965
				MED	840
				LOW	695
13*CHBC-4-31	1/5 (two)	1550	1.02 Ea.	HI	1185
				MED	1035
				LOW	830
(4/1 or 3/2 Split 220 Volt / 50Hz)					
3*CHBC-41-32	1/20	1075	0.40	HI	225
				MED	175
				LOW	125
4*CHBC-41-32	1/12	1050	0.55	HI	410
				MED	325
				LOW	255
5*CHBC-41-32	1/12	1050	0.55	HI	375
				MED	305
				LOW	240
6*CHBC-41-32	1/5	1550	1.02	HI	570
				MED	500
				LOW	420
8*CHBC-41-32	1/5	1550	1.02	HI	760
				MED	590
				LOW	405
10*CHBC-41-32	1/4	1625	1.53	HI	940
				MED	835
				LOW	690
13*CHBC-41-32	1/5 (two)	1550	1.02 Ea.	HI	1140
				MED	100
				LOW	805

Product Specifications

Horizontal Fan Coils
2-Pipe/4-Pipe Hydronic

BLOWER PERFORMANCE HBCX 120V ECM

115V/1/60 ECM MOTOR		HBCX SERIES (CONCEALED) - CFM vs ESP (3-ROW)									
MODEL	HP	AMPS/ 120V	SPEED TAP	EXTERNAL STATIC PRESSURE (inches of water)							
				0.1	0.15	0.2	0.25	0.3	0.35	0.4	0.5
4"HBCX-3	1/7	1.4	White	480	455	430	405	380	355	330	*
			Green	400	365	330	305	280	250	220	*
			Orange	350	315	280	250	220	195	170	*
			Yellow	280	235	190	155	120	*	*	*
6"HBCX-3	1/7	2.5	White	690	670	650	635	620	600	580	*
			Green	660	635	610	580	550	540	530	*
			Orange	570	545	520	500	480	455	430	*
			Yellow	480	455	430	410	390	365	340	*
8"HBCX-3	1/2	4.6	Green	980	945	910	890	870	845	820	720
			Orange	800	780	760	745	730	715	700	660
			Yellow	680	660	640	620	600	580	560	530
			Red	530	510	490	470	450	430	410	360
10"HBCX-3	1/2	4.6	White	1120	1105	1090	1075	1060	1040	1020	960
			Green	1010	995	980	960	940	925	910	880
			Orange	830	810	790	765	740	720	700	660
			Yellow	690	665	640	620	600	575	550	510
12"HBCX-3	1/2	6.2	White	1380	1365	1350	1325	1300	1285	1270	1240
			Orange	1180	1165	1150	1130	1110	1090	1070	1030
			Yellow	1080	1070	1060	1045	1030	1010	990	960
			Red	1020	1000	980	960	940	925	910	880
115V/1/60 ECM MOTOR		HBCX SERIES (CONCEALED) - CFM vs ESP (4-ROW or 3/1 SPLIT)									
MODEL	HP	AMPS/ 120V	SPEED TAP	EXTERNAL STATIC PRESSURE (inches of water)							
				0.1	0.15	0.2	0.25	0.3	0.35	0.4	0.5
4"HBCX-4 -31	1/7	1.4	White	480	455	430	405	380	355	330	*
			Green	400	365	330	305	280	250	220	*
			Orange	350	315	280	250	220	195	170	*
			Yellow	280	235	190	155	120	*	*	*
6"HBCX-4 -31	1/7	2.5	White	690	670	650	635	620	600	580	*
			Green	660	635	610	580	550	540	530	*
			Orange	570	545	520	500	480	455	430	*
			Yellow	480	455	430	410	390	365	340	*
8"HBCX-4 -31	1/2	4.6	Green	980	945	910	890	870	845	820	720
			Orange	800	780	760	745	730	715	700	660
			Yellow	680	660	640	620	600	580	560	530
			Red	530	510	490	470	450	430	410	360
10"HBCX-4 -31	1/2	4.6	White	1120	1105	1090	1075	1060	1040	1020	960
			Green	1010	995	980	960	940	925	910	880
			Orange	830	810	790	765	740	720	700	660
			Yellow	690	665	640	620	600	575	550	510
12"HBCX-4 -31	1/2	6.2	White	1380	1365	1350	1325	1300	1285	1270	1240
			Orange	1180	1165	1150	1130	1110	1090	1070	1030
			Yellow	1080	1070	1060	1045	1030	1010	990	960
			Red	1020	1000	980	960	940	925	910	880
115V/1/60 ECM MOTOR		HBCX SERIES (CONCEALED) - CFM vs ESP (3/2 or 4/1 SPLIT)									
MODEL	HP	AMPS/ 120V	SPEED TAP	EXTERNAL STATIC PRESSURE (inches of water)							
				0.1	0.15	0.2	0.25	0.3	0.35	0.4	0.5
4"HBCX-32 -41	1/7	1.4	White	480	455	430	405	380	355	330	*
			Green	400	365	330	305	280	250	220	*
			Orange	350	315	280	250	220	195	170	*
			Yellow	280	235	190	155	120	*	*	*
6"HBCX-32 -41	1/7	2.5	White	690	670	650	635	620	600	580	*
			Green	660	635	610	580	550	540	530	*
			Orange	570	545	520	500	480	455	430	*
			Yellow	480	455	430	410	390	365	340	*
8"HBCX-32 -41	1/2	4.6	Green	980	945	910	890	870	845	820	720
			Orange	800	780	760	745	730	715	700	660
			Yellow	680	660	640	620	600	580	560	530
			Red	530	510	490	470	450	430	410	360
10"HBCX-32 -41	1/2	4.6	White	1120	1105	1090	1075	1060	1040	1020	960
			Green	1010	995	980	960	940	925	910	880
			Orange	830	810	790	765	740	720	700	660
			Yellow	690	665	640	620	600	575	550	510
12"HBCX-32 -41	1/2	6.2	White	1380	1365	1350	1325	1300	1285	1270	1240
			Orange	1180	1165	1150	1130	1110	1090	1070	1030
			Yellow	1080	1070	1060	1045	1030	1010	990	960
			Red	1020	1000	980	960	940	925	910	880

In attempt to maintain CFM consistency, fins per inch (FPI) vary depending on coil rows and is reflected in CFM and capacity calculations

INCLUDES 24V TRANSFORMER,
LINE VOLTAGE TERMINAL
BLOCK, LOW VOLTAGE TERMINAL STRIP, IN
FACTORY MOUNTED CONTROL BOX

Product Specifications
Horizontal Fan Coils
2-Pipe/4-Pipe Hydronic

BLOWER PERFORMANCE
PHBCX 120V ECM

115V/1/60 ECM MOTOR		PHBCX SERIES (PLENUM)- CFM vs ESP (3-ROW)										
MODEL	HP	AMPS/ 120V	SPEED TAP	EXTERNAL STATIC PRESSURE (inches of water)							0.4	0.5
				0.1	0.15	0.2	0.25	0.3	0.35	0.4		
4"PHBCX-3	1/7	1.4	White	455	430	405	380	355	330	*	*	
			Green	365	330	305	280	250	220	*	*	
			Orange	315	280	250	220	195	170	*	*	
			Yellow	235	190	155	120	*	*	*	*	
6"PHBCX-3	1/7	2.5	White	670	650	635	620	600	580	*	*	
			Green	635	610	580	550	540	530	*	*	
			Orange	545	520	500	480	455	430	*	*	
			Yellow	455	430	410	390	365	340	*	*	
8"PHBCX-3	1/2	4.6	Green	945	910	890	870	845	820	720	*	
			Orange	780	760	745	730	715	700	660	*	
			Yellow	660	640	620	600	580	560	530	*	
			Red	510	490	470	450	430	410	360	*	
10"PHBCX-3	1/2	4.6	White	1105	1090	1075	1060	1040	1020	960	*	
			Green	995	980	960	940	925	910	880	*	
			Orange	810	790	765	740	720	700	660	*	
			Yellow	665	640	620	600	575	550	510	*	
12"PHBCX-3	1/2	6.2	White	1365	1350	1325	1300	1285	1270	1240	*	
			Orange	1165	1150	1130	1110	1090	1070	1030	*	
			Yellow	1070	1060	1045	1030	1010	990	960	*	
			Red	1000	980	960	940	925	910	880	*	
115V/1/60 ECM MOTOR		PHBCX SERIES (PLENUM)- CFM vs ESP (4-ROW or 3/1 SPLIT)										
MODEL	HP	AMPS/ 120V	SPEED TAP	EXTERNAL STATIC PRESSURE (inches of water)							0.4	0.5
				0.1	0.15	0.2	0.25	0.3	0.35	0.4		
4"PHBCX-4	1/7	1.4	White	455	430	405	380	355	330	*	*	
			Green	365	330	305	280	250	220	*	*	
			Orange	315	280	250	220	195	170	*	*	
			Yellow	235	190	155	120	*	*	*	*	
6"PHBCX-4	1/7	2.5	White	670	650	635	620	600	580	*	*	
			Green	635	610	580	550	540	530	*	*	
			Orange	545	520	500	480	455	430	*	*	
			Yellow	455	430	410	390	365	340	*	*	
8"PHBCX-4	1/2	4.6	Green	945	910	890	870	845	820	720	*	
			Orange	780	760	745	730	715	700	660	*	
			Yellow	660	640	620	600	580	560	530	*	
			Red	510	490	470	450	430	410	360	*	
10"PHBCX-4	1/2	4.6	White	1105	1090	1075	1060	1040	1020	960	*	
			Green	995	980	960	940	925	910	880	*	
			Orange	810	790	765	740	720	700	660	*	
			Yellow	665	640	620	600	575	550	510	*	
12"PHBCX-4	1/2	6.2	White	1365	1350	1325	1300	1285	1270	1240	*	
			Orange	1165	1150	1130	1110	1090	1070	1030	*	
			Yellow	1070	1060	1045	1030	1010	990	960	*	
			Red	1000	980	960	940	925	910	880	*	
115V/1/60 ECM MOTOR		PHBCX SERIES (PLENUM)- CFM vs ESP (3/2 SPLIT)										
MODEL	HP	AMPS/ 120V	SPEED TAP	EXTERNAL STATIC PRESSURE (inches of water)							0.4	0.5
				0.1	0.15	0.2	0.25	0.3	0.35	0.4		
4"PHBCX-32	1/7	1.4	White	455	430	405	380	355	330	*	*	
			Green	365	330	305	280	250	220	*	*	
			Orange	315	280	250	220	195	170	*	*	
			Yellow	235	190	155	120	*	*	*	*	
6"PHBCX-32	1/7	2.5	White	670	650	635	620	600	580	*	*	
			Green	635	610	580	550	540	530	*	*	
			Orange	545	520	500	480	455	430	*	*	
			Yellow	455	430	410	390	365	340	*	*	
8"PHBCX-32	1/2	4.6	Green	945	910	890	870	845	820	720	*	
			Orange	780	760	745	730	715	700	660	*	
			Yellow	660	640	620	600	580	560	530	*	
			Red	510	490	470	450	430	410	360	*	
10"PHBCX-32	1/2	4.6	White	1105	1090	1075	1060	1040	1020	960	*	
			Green	995	980	960	940	925	910	880	*	
			Orange	810	790	765	740	720	700	660	*	
			Yellow	665	640	620	600	575	550	510	*	
12"PHBCX-32	1/2	6.2	White	1365	1350	1325	1300	1285	1270	1240	*	
			Orange	1165	1150	1130	1110	1090	1070	1030	*	
			Yellow	1070	1060	1045	1030	1010	990	960	*	
			Red	1000	980	960	940	925	910	880	*	



In attempt to maintain CFM consistency, fins per inch (FPI) vary depending on coil rows and is reflected in CFM and capacity calculations

INCLUDES 24V TRANSFORMER,
LINE VOLTAGE TERMINAL
BLOCK, LOW VOLTAGE TERMINAL STRIP, IN
FACTORY MOUNTED CONTROL BOX

Product Specifications

Horizontal Fan Coils
2-Pipe/4-Pipe Hydronic

BLOWER PERFORMANCE RHBCX 120V ECM

115V/1/60 ECM MOTOR RHBCX SERIES (RECESSED) - CFM vs ESP (3-ROW)											
MODEL	HP	AMPS/ 120V	SPEED TAP	EXTERNAL STATIC PRESSURE (inches of water)							
				0.1	0.15	0.2	0.25	0.3	0.35	0.4	0.5
4RHBCX-3	1/7	1.4	White	430	405	380	355	330	*	*	*
			Green	330	305	280	250	220	*	*	*
			Orange	280	250	220	195	170	*	*	*
			Yellow	190	155	120	*	*	*	*	*
6RHBCX-3	1/7	2.5	White	650	635	620	600	580	*	*	*
			Green	610	580	550	540	530	*	*	*
			Orange	520	500	480	455	430	*	*	*
			Yellow	430	410	390	365	340	*	*	*
8RHBCX-3	1/2	4.6	Green	910	890	870	845	820	720	*	*
			Orange	760	745	730	715	700	660	*	*
			Yellow	640	620	600	580	560	530	*	*
			Red	490	470	450	430	410	360	*	*
10RHBCX-3	1/2	4.6	White	1090	1075	1060	1040	1020	960	*	*
			Green	980	960	940	925	910	880	*	*
			Orange	790	765	740	720	700	660	*	*
			Yellow	640	620	600	575	550	510	*	*
12RHBCX-3	1/2	6.2	White	1350	1325	1300	1285	1270	1240	*	*
			Orange	1150	1130	1110	1090	1070	1030	*	*
			Yellow	1060	1045	1030	1010	990	960	*	*
			Red	980	960	940	925	910	880	*	*
115V/1/60 ECM MOTOR RHBCX SERIES (RECESSED) - CFM vs ESP (4-ROW or 3/1 SPLIT)											
MODEL	HP	AMPS/ 120V	SPEED TAP	EXTERNAL STATIC PRESSURE (inches of water)							
				0.1	0.15	0.2	0.25	0.3	0.35	0.4	0.5
4*RHBCX-4	1/7	1.4	White	430	405	380	355	330	*	*	*
			Green	330	305	280	250	220	*	*	*
			Orange	280	250	220	195	170	*	*	*
			Yellow	190	155	120	*	*	*	*	*
6*RHBCX-4	1/7	2.5	White	650	635	620	600	580	*	*	*
			Green	610	580	550	540	530	*	*	*
			Orange	520	500	480	455	430	*	*	*
			Yellow	430	410	390	365	340	*	*	*
8*RHBCX-4	1/2	4.6	Green	910	890	870	845	820	720	*	*
			Orange	760	745	730	715	700	660	*	*
			Yellow	640	620	600	580	560	530	*	*
			Red	490	470	450	430	410	360	*	*
10*RHBCX-4	1/2	4.6	White	1090	1075	1060	1040	1020	960	*	*
			Green	980	960	940	925	910	880	*	*
			Orange	790	765	740	720	700	660	*	*
			Yellow	640	620	600	575	550	510	*	*
12*RHBCX-4	1/2	6.2	White	1350	1325	1300	1285	1270	1240	*	*
			Orange	1150	1130	1110	1090	1070	1030	*	*
			Yellow	1060	1045	1030	1010	990	960	*	*
			Red	980	960	940	925	910	880	*	*
115V/1/60 ECM MOTOR RHBCX SERIES (RECESSED) - CFM vs ESP (3/2 SPLIT)											
MODEL	HP	AMPS/ 120V	SPEED TAP	EXTERNAL STATIC PRESSURE (inches of water)							
				0.1	0.15	0.2	0.25	0.3	0.35	0.4	0.5
4*RHBCX-32	1/7	1.4	White	430	405	380	355	330	*	*	*
			Green	330	305	280	250	220	*	*	*
			Orange	280	250	220	195	170	*	*	*
			Yellow	190	155	120	*	*	*	*	*
6*RHBCX-32	1/7	2.5	White	650	635	620	600	580	*	*	*
			Green	610	580	550	540	530	*	*	*
			Orange	520	500	480	455	430	*	*	*
			Yellow	430	410	390	365	340	*	*	*
8*RHBCX-32	1/2	4.6	Green	910	890	870	845	820	720	*	*
			Orange	760	745	730	715	700	660	*	*
			Yellow	640	620	600	580	560	530	*	*
			Red	490	470	450	430	410	360	*	*
10*RHBCX-32	1/2	4.6	White	1090	1075	1060	1040	1020	960	*	*
			Green	980	960	940	925	910	880	*	*
			Orange	790	765	740	720	700	660	*	*
			Yellow	640	620	600	575	550	510	*	*
12*RHBCX-32	1/2	6.2	White	1350	1325	1300	1285	1270	1240	*	*
			Orange	1150	1130	1110	1090	1070	1030	*	*
			Yellow	1060	1045	1030	1010	990	960	*	*
			Red	980	960	940	925	910	880	*	*

In attempt to maintain CFM consistency, fins per inch (FPI) vary depending on coil rows and is reflected in CFM and capacity calculations

INCLUDES 24V TRANSFORMER,
LINE VOLTAGE TERMINAL
BLOCK, LOW VOLTAGE TERMINAL STRIP, IN
FACTORY MOUNTED CONTROL BOX

Product Specifications

Horizontal Fan Coils
2-Pipe/4-Pipe Hydronic

**BLOWER PERFORMANCE
CHBCX 120V ECM**

115V/1/60 ECM MOTOR		CHBCX SERIES (EXPOSED) - CFM (3-ROW)		
MODEL	HP	AMPS/120V	SPEED TAP	CFM
4"CHBCX-3	1/7	1.4	White	480
			Green	400
			Orange	350
			Yellow	280
6"CHBCX-3	1/7	2.5	White	690
			Green	660
			Orange	570
			Yellow	480
8"CHBCX-3	1/2	4.6	Green	980
			Orange	800
			Yellow	680
			Red	530
10"CHBCX-3	1/2	4.6	White	1120
			Green	1010
			Orange	830
			Yellow	690
12"CHBCX-3	1/2	6.2	White	1380
			Orange	1180
			Yellow	1080
			Red	1020
115V/1/60 ECM MOTOR		CHBCX SERIES (EXPOSED) - CFM (4-ROW or 3/1 SPLIT)		
MODEL	HP	AMPS/120V	SPEED TAP	CFM
4"CHBCX-4	1/7	1.4	White	480
			Green	400
			Orange	350
			Yellow	280
6"CHBCX-4	1/7	2.5	White	690
			Green	660
			Orange	570
			Yellow	480
8"CHBCX-4	1/2	4.6	Green	980
			Orange	800
			Yellow	680
			Red	530
10"CHBCX-4	1/2	4.6	White	1120
			Green	1010
			Orange	830
			Yellow	690
12"CHBCX-4	1/2	6.2	White	1380
			Orange	1180
			Yellow	1080
			Red	1020
115V/1/60 ECM MOTOR		CHBCX SERIES (EXPOSED) - CFM (3/2 SPLIT)		
MODEL	HP	AMPS/120V	SPEED TAP	CFM
4"CHBCX-32	1/7	1.4	White	480
			Green	400
			Orange	350
			Yellow	280
6"CHBCX-32	1/7	2.5	White	690
			Green	660
			Orange	570
			Yellow	480
8"CHBCX-32	1/2	4.6	Green	980
			Orange	800
			Yellow	680
			Red	530
10"CHBCX-32	1/2	4.6	White	1120
			Green	1010
			Orange	830
			Yellow	690
12"CHBCX-32	1/2	6.2	White	1380
			Orange	1180
			Yellow	1080
			Red	1020

ECM MOTOR

In attempt to maintain CFM consistency, fins per inch (FPI) vary depending on coil rows and is reflected in CFM and capacity calculations

INCLUDES 24V TRANSFORMER,
LINE VOLTAGE TERMINAL
BLOCK, LOW VOLTAGE TERMINAL STRIP, IN
FACTORY MOUNTED CONTROL BOX

Product Specifications

Horizontal Fan Coils
2-Pipe/4-Pipe Hydronic

**BLOWER PERFORMANCE
HBCX 277V ECM**

115V/1/60 ECM MOTOR		HBCX SERIES (CONCEALED) - CFM vs ESP (4-ROW or 3/1 SPLIT)									
MODEL	HP	AMPS/120V	SPEED TAP	EXTERNAL STATIC PRESSURE (inches of water)							
				0.1	0.15	0.2	0.25	0.3	0.35	0.4	0.5
4"HBCX-4-31	1/6	1.4	White	500	480	460	405	410	390	370	*
			Green	420	390	360	305	320	290	260	*
			Orange	370	340	310	250	250	220	190	*
			Yellow	290	260	230	155	140	*	*	*
6"HBCX-4-31	1/6	2.5	White	690	670	650	635	610	585	560	*
			Green	640	620	600	580	560	540	520	*
			Orange	540	520	500	500	460	440	420	*
			Yellow	440	420	400	410	360	335	310	*
8"HBCX-4-31	1/2	4.6	Green	990	960	930	890	860	825	790	720
			Orange	840	825	810	745	780	760	740	700
			Yellow	680	660	640	620	600	585	570	540
			Red	500	480	460	470	420	400	380	*
10"HBCX-4-31	1/2	4.6	White	1140	1120	1100	1080	1060	1040	1020	980
			Green	1040	1020	1000	980	960	940	920	880
			Orange	860	840	820	800	780	760	740	700
			Yellow	710	690	670	650	630	610	590	*
12"HBCX-4-31	1/2	6.2	White	1340	1320	1300	1275	1250	1225	1200	1150
			Orange	1240	1220	1200	1175	1150	1125	1100	1050
			Yellow	1130	1110	1090	1070	1050	1020	1000	950
			Red	1040	1020	1000	970	940	920	900	*

Climaproyectos
.com

GUIDE SPECIFICATIONS**PART 1: GENERAL****1.01 Section Includes**

A. Fan Coil Units

1.02 REFERENCES

AMCA 99 – Standards Handbook

AMCA 210 -- Laboratory Methods for Testing Fans for Rating Purposes

AMCA 300 – Test Code for Sound Rating Air Moving Devices

ARI 440 – Room Fan-Coil Unit

ASTMB117 – Standard Practice for Operating Salt Spray Apparatus

NEMA MGI – Motors and Generators

NFPA 70 – National Electric Code

SMACNA – HVAC Duct Construction Standards – Metal and Flexible

UL 723 – Test for Surface Burning Characteristics of Building Materials

UL 900 – Test Performance of Air Filter Units

UL 1995 – Standard for Heating and Cooling Equipment

UL 94 – Test for Flammability of Plastic Materials for Parts in Devices and Appliances

1.03 SUBMITTALS

A. Shop drawings: Indicate assembly, unit dimensions, weight loading, required clearances, construction details, field connection details, and electrical characteristics and connection requirements. A computer generated capacity selection shall be submitted for each cooling coil with design points and final operating point clearly noted.

B. Product Data:

1. Provide literature that indicates dimensions, weights, capacities, ratings, fan performance, finishes of materials, and electrical characteristics and connection requirements.

2. Provide data of filter media, filter performance data.

3. Manufacturer's installation instructions.

1.04 OPERATION AND MAINTENANCE DATA

A. Maintenance Data: Include instructions for lubrication, filter replacement and motor and drive replacement.

1.05 QUALIFICATIONS

A. Manufacturer: Company specializing in manufacturing the products specified in this section with a minimum 10 years documented experience, which issues complete catalog data on total product.

1.06 DELIVERY, STORAGE, AND HANDLING

A. Accept products on site on factory-installed shipping skids. Inspect for damage.

B. Store in clean dry place and protect from weather and construction traffic. Handle carefully to avoid damage to components, enclosures, and finish.

GUIDE SPECIFICATIONS (cont.)**1.07 ENVIRONMENTAL REQUIREMENTS**

A. Do not operate units for any purpose, temporary or permanent, until ductwork is clean, filters are in place, and fan has been test run under observation.

PART 2: PRODUCTS**2.01 MANUFACTURERS**

A. The following manufacturers are approved for use. No substitutions will be permitted.

1. First Company, Dallas TX

2.02 CASING

A. Unit shall have corrosion resistant casing consisting of galvanized steel panels. Unit panels shall be fully insulated with 1.5lb fiberglass insulation with anti-microbial agent. Removable panels shall provide full access to unit components.

B. Drain pans shall be heavy gauge galvanized steel with an insulating coating. Optional stainless steel drain pan shall include an insulating coating. Drain pans shall be removable for cleaning or replacement without removing coils or disturbing coil connections.

2.03 SUPPLY FAN

A. Provide DWDI forward-curved supply fans. Fan assemblies shall be statically and dynamically balanced by manufacturer. The housings are constructed from heavy gauge galvanized steel with die-formed inlet cones.

B. Fan and motor mounting platform shall be a minimum of 12 gauge LFQ galvanized steel.

2.04 MOTORS

A. Direct drive motors to be PSC or ECM type, permanently lubricated type with internal thermal overload protection and mounted with rubber isolation bushings.

2.05 ELECTRICAL

A. Provide units with 115, 208-230, or 277V, 3-speed with 24v control transformer, and 15 amp service switch or optional ECM motor with 120/24V control transformer, 15 amp service switch, 4 speed taps. Controls to be factory mounted and tested.

2.07 COOLING AND HEATING COIL SECTIONS

A. Provide access to coils for service and cleaning.

B. Water Coils: fins shall have full drawn collars to provide a continuous surface cover over the entire tube for maximum heat transfer. Tubes shall be mechanically expanded into the fins to provide a continuous primary-to-secondary compression bond over the entire finned length for maximum heat transfer rates. Bare copper tube shall not be visible between fins. Coil tubes shall be seamless copper, expanded into fins, and brazed at joints. Coil connections shall be copper with sweat connection size to be determined by manufacturer based upon the most efficient coil circuiting. Manual air vent connections shall be provided at the highest point to assure proper venting. Coils shall be tested with 350 pounds air pressure and suitable for 300 psig working pressure. Coil casings shall be a formed channel frame of galvanized steel.

2.08 FILTERS

A. Filter to be disposable type and media shall be UL 900 listed, Class I or Class II.

PART 3: EXECUTION**3.01 INSTALLATION**

A. Install in accordance with manufacturer's instructions.

Product Specifications

Horizontal Fan Coils
2-Pipe/4-Pipe Hydronic

ACCESS PANELS

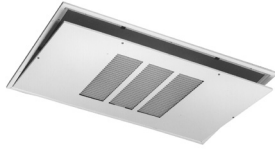

*STANDARD PANEL OPTIONS FOR HBC SERIES					*IAQ MERV 8 PANEL OPTIONS FOR HBC SERIES				
PART #	UNIT SIZE	PANEL TYPE	FRAME DIMENSIONS	*FILTER SIZE	PART #	UNIT SIZE	PANEL TYPE	FRAME DIMENSIONS	*FILTER SIZE
965	3,4,5,6	LOUVERED	27-1/2 X 43	20X20X1 (1)	965-M8	3,4,5,6	LOUVERED	27-1/2 X 43	20X30X1 (1)
965-1		SOLID							
966	8	LOUVERED	27-1/2 X 49	20X20X1 (1)	966-M8	8	LOUVERED	27-1/2 X 49	20X20X1 (2)
966-1		SOLID							
967	10	LOUVERED	27-1/2 X 55-1/2	20X20X1 (1)	967-M8	10	LOUVERED	27-1/2 X 55-1/2	20X20X1 (2)
967-1		SOLID							
967-4	12/13	LOUVERED	27-5/8 X 70-1/8	10X65X1 (1)	967-8M8	12/13	LOUVERED	27-5/8 X 70-1/8	20X30X1 (2)
967-5		SOLID							

Note * Filters not included

IAQ PANEL PERFORMANCE DATA (4) (Clean Filter)											
	CFM										
	500	600	700	800	900	1000	1100	1200	1300	1500	
965-M8 with AF20301HV (20x030, Merv 8) Filters (2)	0.04	0.06	0.06	0.08	0.09	0.10	---	---	---	---	
966-M8 with AF20201HV (20x020, Merv 8) Filters (2)	0.04	0.06	0.06	0.08	0.09	0.10	---	---	---	---	
967-M8 with AF20201HV (20x020, Merv 8) Filters (2)	---	0.05	0.05	0.07	0.08	0.10	---	---	---	---	
967-6-M8 with AF20251HV (20x025, Merv 8) Filters (2)	---	---	---	0.05	0.06	0.07	0.08	0.09	---	---	
967-8-M8 with AF20301HV (20x30, Merv 8) Filters (2)	---	---	---	---	---	0.06	0.06	0.08	0.08	0.10	

Notes:



- (1) The above is the actual laboratory test data of these panels.
- (2) Glassfloss® Industries HV series Merv 8 filters were used to generate above data (**filters must be field supplied**)
- (3) Alternate Merv 8 filters would be acceptable provided they have equal or less resistance.
- (4) Refer to fan coil specification sheets for fan coil blower data.

Product Specifications



Horizontal Fan Coils
2-Pipe/4-Pipe Hydronic

ACCESSORIES

THERMOSTATS

<p>T420 - Manual Changeover with 3 speed fan switch</p> <p>T421 - Auto Changeover with 3 speed fan switch</p>	<p>3-Speed Fan Switching</p> 	<p>HEAT-OFF-COOL System Switch Accepts 24 to 277 VAC., 50 or 60 Hz Maximum Ambient: 130^o F Optional Remote Thermistor Probe Set Point Range: 50 to 90^o F Agency Approvals: UL, UL Canada CE Mounting: Installs to a standard 2" x 4" devise box</p>
<p>T200 - Manual Changeover with Digital Display with Auto Speed Fan Switch</p> <p>T201 - **Auto Changeover Digital Display with Auto Speed Fan Switch</p>	<p>3-Speed Fan Switching</p> 	<p>HEAT/COOL System Switch, Manual or Auto 3-Speed Fan switch with Auto Speed Feature Separate On-Off Switch 18-30 VAC, 50/60 Hz Temperature Accuracy: ± 1.8^o F Ambient Teperature: 50-122^o F Set Point Range: 64-88^o F</p>

SINGLE SPEED THERMOSTATS

<p>T630 - Manual Changeover Digital Display, Single Speed Fan</p>	<p>1-Speed Fan (on-Auto)</p> 	<p>HEAT-OFF-COOL System Switch Manual Changeover 18-30 VAC, 50/60 Hz Temperature Accuracy: ± 1.0^o F Ambient Temperature: 14^o to 140^o F Set Point Range: 45-90^o F DC Power: 3.0 Volt DC (2 AA Alkaline batteries included)</p>
<p>T832 7-Day Programmable 1 heat, 1 cool, Single Speed, Touch Screen display, C7189 Remote sensor available</p>	<p>1-Speed Fan (On-Auto)</p> 	<p>HEAT-OFF-COOL-AUTO Fan Options: Auto-on Circ 20 - 30 Vac, 50/60 Hz Ambient Temperature: 0^o to 120^o F Set Point Range: Clg. 50^oF to 99^oF Htg. 40^of to 90^oF Powering methods: Battery only Common wire only Common wire with battery backup</p>
<p>T4071 5/8 T4072 7/8 Auto Changeover Requires Aguastat (2-pipe applications)</p>		<p>Strap-on Aquastat 5/8" O.D. Tubing 10 amps induction 60 amps locked rotor 25 amps resitive Temperature Changes at 95^o F + 10^oF Resets at 65^oF + 5^oF</p>

Product Specifications

Horizontal Fan Coils
2-Pipe/4-Pipe Hydronic

ACCESSORIES

3-SPEED ROTARY SWITCH

W/OFF POSITION	E332		<p>Resistive Load (Switching Capacity) Rating 10 Amps at 125 VAC 5 Amps at 250/277 VAC</p> <p>Inductive (Motorload) Ratings 1/4 HP at 125/277 VAC 1/2 HP at 250 VAC</p> <p>Standard Switch and Shaft Dimensions 2" x 1-1/2" x 11/16" 3/16" Square Shaft with 13/32" Extension 15/32" Double D 32 Threaded Bushing with 1/4" Extension 6-1/2" Long Leads</p>
NO OFF POSITION	E332-1		

WALL MOUNT 3-SPEED SWITCH

3-SPEED SWITCH ON/OFF WALL MOUNT	T422		<p>Resistive Load (Switching Capacity) Rating 6 Amps at 125 VAC 5 Amps at 240 VAC 4.2 Amps at 277 VAC</p> <p>Inductive (Motorload) Ratings 1/4 HP at 125/277 VAC 1/2 HP at 250 VAC</p> <p>Horizontal mount with manual on/off switch and manual three speed fan switch. Operation with system switch in on position, fan operation is continuous, can be set at one of three speeds. With system switch in off position, all outputs are off.</p>
----------------------------------	------	---	---

OPTIONAL SERVICE SWITCH (15 AMP)

<table border="1"> <tr> <th>Voltage</th> <th>Part #</th> </tr> <tr> <td>120/1/60</td> <td>945-6</td> </tr> <tr> <td>240/1/60</td> <td>945-7</td> </tr> <tr> <td>277/1/60</td> <td>945-7</td> </tr> <tr> <td>220/1/50</td> <td>945-7</td> </tr> </table>	Voltage	Part #	120/1/60	945-6	240/1/60	945-7	277/1/60	945-7	220/1/50	945-7		<p>2 x 4 Service Switch Toggle Switch 15 Amp Single Pole 2 X 4 J-Box 2 X 4 Switch Cover - Galvanized Steel</p>
Voltage	Part #											
120/1/60	945-6											
240/1/60	945-7											
277/1/60	945-7											
220/1/50	945-7											

SINGLE SPEED FAN (24V Control Circuit)

<table border="1"> <tr> <th>Voltage</th> <th>Part #</th> </tr> <tr> <td>120/1/60</td> <td>310-E301</td> </tr> <tr> <td>240/1/60</td> <td>310-E302</td> </tr> <tr> <td>277/1/60</td> <td>310-E303</td> </tr> <tr> <td>220/1/50</td> <td>310-E302</td> </tr> </table>	Voltage	Part #	120/1/60	310-E301	240/1/60	310-E302	277/1/60	310-E303	220/1/50	310-E302		<p>Relay Transformer Assembly 30 Amp, single pole, normally open, 24v coil 18 GA. 4.25 X 4.25 mounting plate Factory assembled and wired</p>
Voltage	Part #											
120/1/60	310-E301											
240/1/60	310-E302											
277/1/60	310-E303											
220/1/50	310-E302											

THREE SPEED FAN (24V Control Circuit)











Multi-24		<p>3-SPEED CONTROL OPTION FOR HBC SERIES FAN COILS FACTORY MOUNTED CONTROLS INCLUDE CB500 RELAY BOARD, 24V TRANSFORMER, (15 AMP) SERVICE SWITCH</p>
FACTORY MOUNTED OPTION ONLY		

Product Specifications

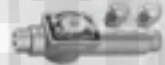
Horizontal Fan Coils
2-Pipe/4-Pipe Hydronic

ACCESSORIES

VALVE PACKAGES AND ACCESSORIES

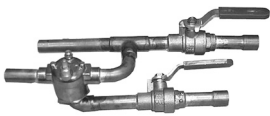
ACTUATOR		 <p>2-Way Valve and Actuator</p>	ACTUATOR MATERIALS			
2-POSITION (ON-OFF) 50/60HZ			BASE	POLYCARBONATE		APPROVALS
VOLTAGE	PART #		COVER	POLYCARBONATE		UL Cul CE
24V	E50131180		BASE PLATE	ALUMINUM		
120/1/60	E50132180		LEAD LENGTH	6" - (24V 18")		
240/1/60	E50138180		POWER REQUIREMENTS	6.5W, 7 VA		
277/1/60	E50137180		AMBIENT TEMPERATURE RANGE	32 TO 170 F		
220/1/50	E50138180		MICRO SWITCH	5 A, 250 V		
		HUMIDITY	95% NON-CONDENSING			
VALVE BODY MATERIALS			VALVE BODIES (2-POSITION)			
BODY	BRASS		E43XXXX 3-WAY		E42XXXX 2-WAY	
STEM	STAINLESS STEEL					
TWO O-RINGS SEALS	EPDM					
PADDLE	EPDM					
FLUID	WATER/GLYCOL					
MAXIMUM % OF GLYCOL	50%					
TEMPERATURE RANGE	32 TO 240					
MAXIMUM STATIC PRESSURE	300 PSI					
SWEAT CONNECTION	1/2", 3/4", 1"		Automatic Fixed Flow Control		Manual Adj. Flow Setter	
			1/2"	3/4"		
			CP654XXXXX	CP655XXXXX		
FLOW CHARACTERISTICS			PETE'S PLUG	Requires CP6025 CP61712		
Connection Size	Flow Coefficient	Maximum Close-Off Pressure AP				
1/2"	1.0 Cv	75	Ball Valves (Sweat)			
1/2"	2.5 Cv	50	Full Port (T-Handle)			
3/4"			1/2"	3/4"	1"	Y-Strainer (Sweat)
1/2"	3.5 Cv	30	CP-9	CP-90	CP-905	
3/4"						
3/4"	5 Cv	25				
1"			EXTENDED DRIP LIPS			
3/4"	7.5 Cv	20	919-1 15"			
1"			919-1X1ss 15"			
1"	8 Cv	20	919-1EXT 19"			
			STANDARD VALVE PACKAGE FACTORY MOUNTED 2-POSITION (ON-OFF)			
			2-WAY 9VH*22BM WITH 2-BV'S			
			3-WAY 9VH*23BM WITH 2-BV'S			

PIPING PACKAGE OPTIONS

TWO POSITION, MODULATING

Manual air vents are standard and are factory mounted on all chilled water and hot water coils.

All pre-piped on/off or modulating valve packages are factory assembled with sweat connections.

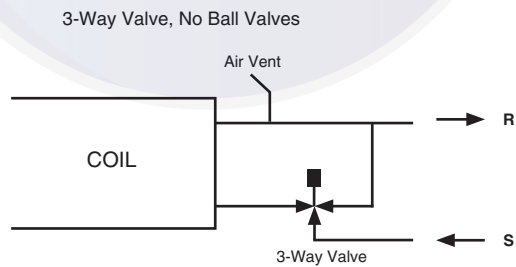
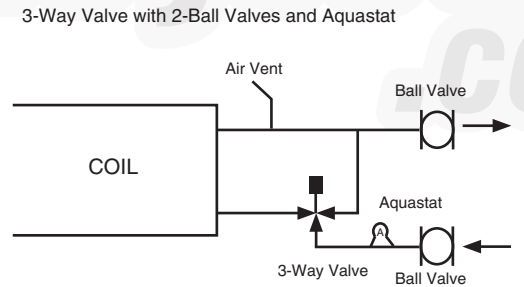
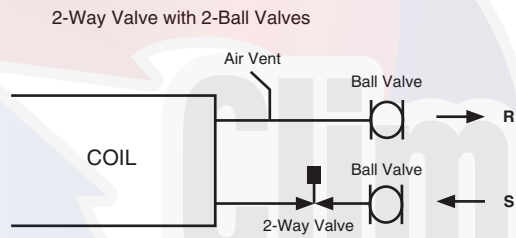
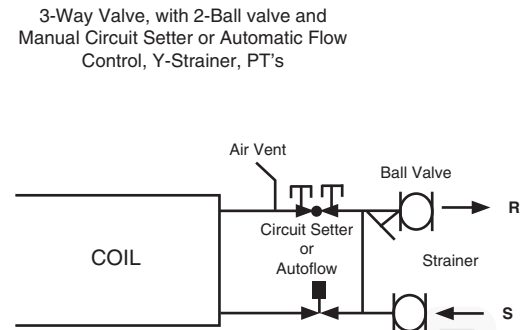
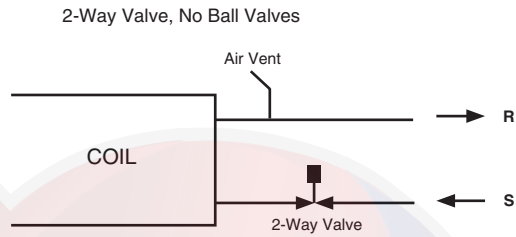
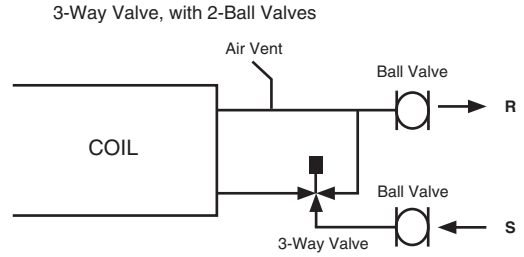
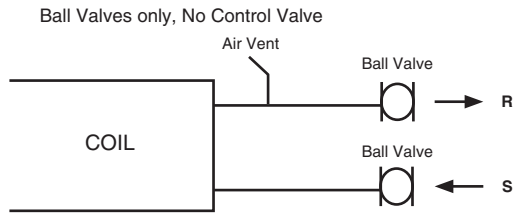

Add Options:
Y-Strainers, Pete's Plugs, Cleanout Blow-down, SS hose kits, Aqua Stats

Additional options and configurations may be available. Contact factory for availability.

Valve packages are available as kits or factory mounted on certain products. Contact factory for availability.

LOW VOLTAGE 24V CONTROLS

2-PIPE SYSTEM	
MODEL	PART # SUFFIX
HBC	450XXXX-MNQ
PHBC	500XXXX-MNQ
RHBC	480XXXX-MNQ
CHBC	490XXXX-MNQ
VOLTAGE CODE-SUFFIC	
120/24V	M
240/24V	N
277/24V	Q
W / 24V CONTROLS	

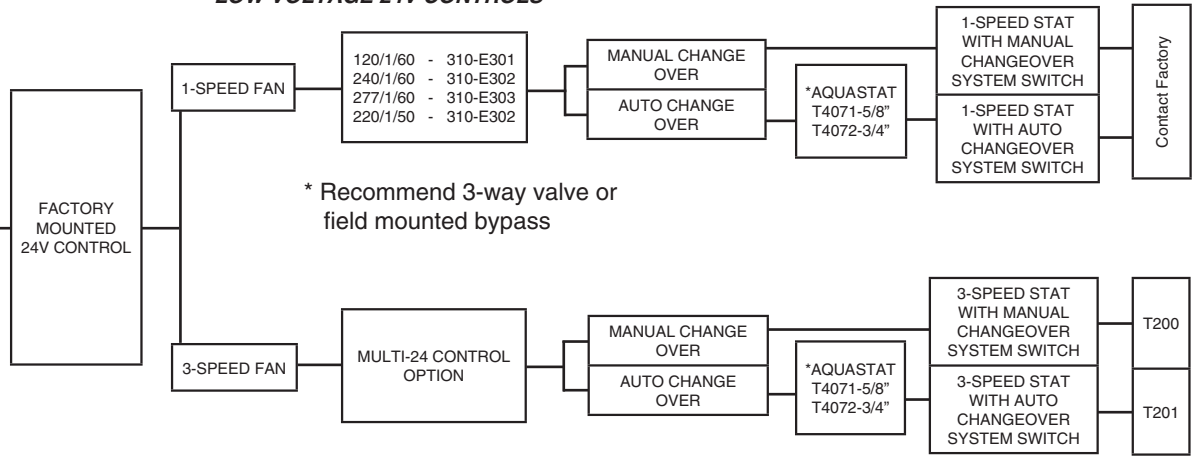

LINE VOLTAGE 120/240/277V CONTROLS

2-PIPE SYSTEM	
MODEL	PART # SUFFIX
HBC	450XXXX-O
PHBC	500XXXX-O
RHBC	480XXXX-O
CHBC	490XXXX-O
NO 24V CONTROLS	
NO SPEED SWITCH	

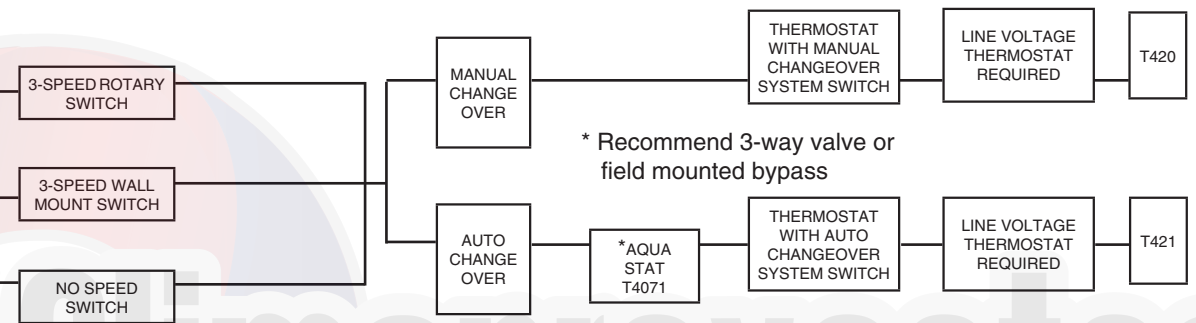

LOW VOLTAGE 24V CONTROLS

4-PIPE SYSTEM	
MODEL	PART # SUFFIX
HBC	450XXXX-MNQ
PHBC	500XXXX-MNQ
RHBC	480XXXX-MNQ
CHBC	490XXXX-MNQ
VOLTAGE CODE-SUFFIC	
120/24V	M
240/24V	N
277/24V	Q
W / 24V CONTROLS	

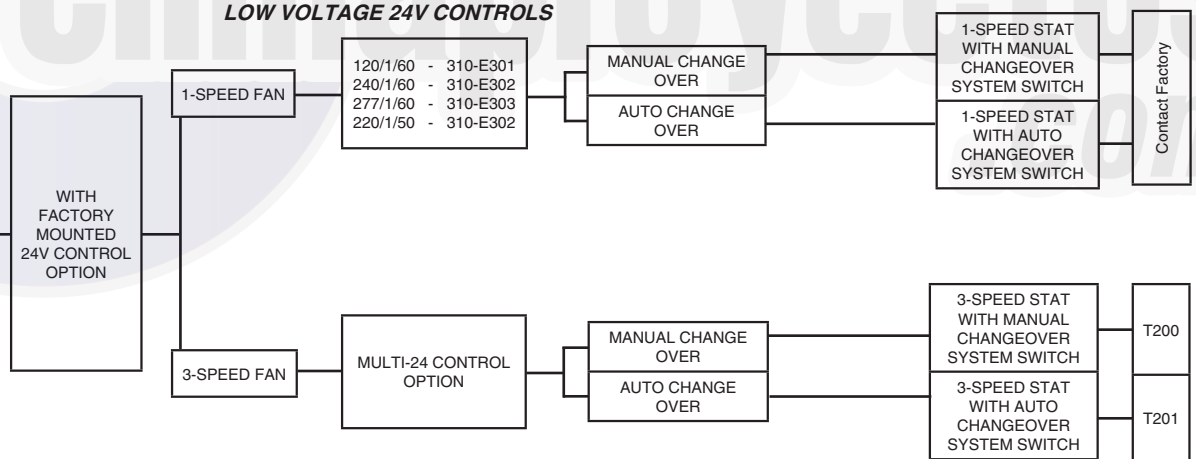

LINE VOLTAGE 120/240/277V CONTROLS

4-PIPE SYSTEM	
MODEL	PART # SUFFIX
HBC	450XXXX-O
PHBC	500XXXX-O
RHBC	480XXXX-O
CHBC	490XXXX-O
NO 24V CONTROLS	
NO SPEED SWITCH	

