



Product Data

AquaSnap® Air-Cooled Chillers 60 Hz

10 to 60 Nominal Tons (35 to 211 Nominal kW)

AQUASNAP greenspeed 



30RC010-060 Air-Cooled Chillers
with R-32 Refrigerant

Carrier’s innovative chiller design provides savings at initial purchase, at installation, and for years afterward.

The AquaSnap chiller is an effective all-in-one package that is easy to install and easy to own. AquaSnap chillers operate quietly and efficiently. Value-added features include:

- Rotary scroll compression
- Hydrofluorocarbon HFC R-32
- Energy Efficiency Ratios (EERs) for all units meet ASHRAE (American Society of Heating, Refrigeration, and Air-Conditioning Engineers) Standard 90.1-2019
- Low-sound AeroAcoustic™ fan system
- Easy to use PIC6 (Product Integrated Control 6) controls
- Optional integrated hydronic pump package, with single or dual pumps available
- Coil design flexibility — microchannel (MCHX) and RTPF (Al/Cu) coil technology available on all units
- Accessory fluid storage tank on all unit sizes
- Optional digital scroll compressors
- High-efficiency, variable-speed condenser fans are standard on unit sizes 010 and 015, and they are optional on unit sizes 020-060

Costs less right from the start

Carrier’s AquaSnap chillers feature a compact, all-in-one package design that installs quickly and easily on the ground or the rooftop.

The optional pump and hydronic components are already built in; this costs

less than buying and installing the components individually. The chiller’s fully integrated and pre-assembled hydronic system installs in minutes.

Among chillers in its class, the AquaSnap chiller is one of the easiest and least expensive to install.

The preassembled and integrated hydronic module uses high-quality components and pumps to ensure years of reliable operation.

Use of the optional fluid storage tank reduces installation costs and ensures that sufficient fluid volume is available for close-coupled and process cooling applications. The AquaSnap unit’s high efficiency keeps energy costs down.

AquaSnap® chillers make noise in the marketplace, not the workplace.

The AquaSnap chiller’s AeroAcoustic fan system is extremely quiet. Much of the noise reduction is in frequencies where noise is most annoying, which makes AquaSnap chillers ideal for sound-sensitive environments. When lower ambient temperatures allow part-load operation, or during scheduled nighttime operation, the units operate with fewer fans and become even quieter. AquaSnap chillers are quiet during the day and even quieter at night.

Savings will continue to mount (30RC chillers with Greenspeed intelligence)

Besides being affordable to purchase and install, AquaSnap chillers are also affordable to operate.

AquaSnap chillers use ultra-quiet, high-efficiency rotary scroll compressors, operated in tandem per independent circuit, for greater efficiency at partial loads.

30RC chillers with Greenspeed intelligence feature a high-efficiency, variable-speed condenser fan option (standard on unit sizes 010 and 015), along with fine-tuned PIC6 controls, which together provide premium part-load efficiency to facilitate reduced utility costs over the lifespan of the chiller. Additionally, the lower sound levels achieved at part-load conditions can be very beneficial for sensitive acoustic applications.

Standard DC link reactor for 30RC units with Greenspeed intelligence is included in all drives for the fans. The use of this component mitigates customer concern over electrical system harmonics; therefore, AC line reactors should not be required for applications employing 30RC chillers with Greenspeed intelligence.

Electronic expansion valve (EXV) allows for precise control through all operating ranges, resulting in higher efficiency and improved reliability.

Proven reliability that’s built in

Thousands of AquaSnap chillers are already in service around the world. This field-proven design is backed by a 12-month warranty that includes the hydronic system. The compressors are maintenance-free and protected by an auto-adaptive control that minimizes compressor wear. Unit sizes 035 and up have two independent refrigerant circuits to increase system safety and flexibility. Year-round operation is standard, from -20°F (-29°C) (for certain sizes and configurations) to 120°F (50°C).

Rotary scroll compressors provide smooth, quiet, and reliable operation.

All-in-one Package

AquaSnap chillers provide one of the most comprehensive chilled water circuits available for air-cooled chillers. Included is a brazed plate evaporator.

Strainer Included

A 20-mesh strainer is provided with every 30RC unit, making the chiller installation easier, lower in cost, and eliminating customer concern. Other manufacturers also require the strainer but may not include it with their chillers, giving the impression that they offer a lower pressure drop chiller. It is important to note that the strainer is required for all brazed plate heat exchangers; therefore, not considering it from the beginning may primary to the selection of the incorrect pump for the system and

Table of contents

	Page
Features/Benefits	2
Model Number Nomenclature	5
Physical Data	6
Options and Accessories	16
Dimensions	19
Selection Procedure	23
Performance Data	25
Typical Piping and Wiring	38
Electrical Data	41
Controls	42
Typical Control Wiring Schematic	45
Application Data	46
Guide Specifications	54

an incorrect evaluation of the overall installation cost.

Electronic thermal-dispersion flow switch is included with the evaporator. The switch is factory installed and tested and contains no moving parts for high reliability.

Optional integrated hydronic package is more than just a pump; it is an entire chilled-water system, including:

- Single/dual pumps up to 10 hp
- Combination valve (includes isolation capability, flow regulator and check valve)
- Freeze protection to -20°F (-29°C)
- Heaters
- Required piping
- Pressure/temperature taps
- Isolation valves for dual pump systems

The factory-installed and tested hydronic package provides faster, simpler and less expensive installation.

Digital scroll compressors are available as a factory-installed option. These allow for incremental unloading with capacity modulation to better match building load when compared to standard scroll compressors.

Environmentally Balanced

In accordance with the AIM Act (American Innovation and Manufacturing), R-32 is available. R-32 has a safety class/flammability of A2L.

Durable Construction

The 30RC chillers have a structurally sound base that can be point-loaded; therefore, no perimeter base rail is required. In addition to overhead rigging, the unit may be lifted using the standard fork pockets. All 30RC units have weatherized cabinets constructed of heavy-duty galvanized steel with exterior panels painted with corrosion-resistant baked enamel. Inside and outside surfaces are protected to ensure long life and good appearance. The durable, galvanized steel, painted components

shall withstand 1000 hours in constant neutral salt spray under ASTM (American Society for Testing and Materials) B117 conditions with a 1 mm scribe per ASTM D1654. After test, painted parts shall show no signs of wrinkling or cracking, no loss of adhesion, no evidence of blistering, and the mean creepage shall not exceed 1/4 in. (Rating \geq per ASTM D1654) on either side of the scribe line.

PIC6 Microprocessor Controls

The PIC6 controls communicate in easy-to-understand English, making it as easy as possible to monitor and control each AquaSnap chiller while accurately maintaining fluid temperatures. PIC6 controls are also available in multiple languages.

The PIC6 controls provide features such as chilled water temperature reset, demand limiting, compressor wear minimization and protection, temperature and pressure displays, and diagnostic functions. These controls result in higher chiller reliability, simplified training, and more productive service calls, with correspondingly lower operational and maintenance costs.

The user interface comes with a display with a chiller pictorial. The PIC6 display is an easy-to-use touch screen that provides simple navigation for configuration and control of AquaSnap units.

The display can be used with the touch of a finger. The PIC6 display helps technicians quickly diagnose chiller issues and helps prevent problems from occurring. All AquaSnap chillers are ready for use with Carrier Comfort Network[®] (CCN) devices and BACnet^{TM1} internet protocol (IP); use of either may require additional field programming.

A LON (Local Operating Network) Translator control is available as a field-installed accessory. This device, when provided with appropriate field

programming, allows interface between the network and the 30RC chiller.

AquaSnap units minimize the impact on your footprint, as well as your bottom line

The integrated hydronics and the chilled fluid storage tank's placement under the chiller minimize the footprint, allowing easy installation almost anywhere.

Novation[®] heat exchanger technology

The Novation heat exchanger design with microchannel (MCHX) condenser coil is a robust, cost effective alternative to traditional coil design. These coils are offered coated or uncoated to match coil protection to site conditions. The e-coated version of this coil (as well as the e-coated version of Al/Cu Coils) can withstand a 10,000-hour salt spray test in accordance with ASTM B-117 Standard. The Carrier Electronic Catalog (E-Cat) can be used to determine whether or not corrosion protection is recommended for particular applications in coastal/marine environments. Following the input of the requested data, the E-Cat program output will recommend the appropriate coil to be used. Other factors described in "Selection Guide: Environmental Corrosion Protection" catalog number 04-581061-01 must also be considered to determine if corrosion protection is required.

Microchannel coils are more robust than other coil types, making them easier to clean without causing damage to the coil.

Due to the compact, all-aluminum design, microchannel coils will reduce average unit operating weight as well as refrigerant charge by a significant amount.

The coil is designed with rubber isolation around the powder-painted coil frame to eliminate galvanic couples, which can cause corrosion due to dissimilar metals.

1. Third-party trademarks and logos are the property of their respective owners.

Remote Connectivity

In an ever-interconnected world, there is a need to provide communication capability to large chillers. Remote connectivity, a factory-installed option, is a communication capability allowing the factory and service technicians access to the machine information from a remote location. This allows for remote diagnostics and prognostics, leading to less down time for the customer and quicker resolution of field problems. Remote connectivity is a factory-installed, secure cellular

communication system that communicates information, such as the equipment parameters, operating conditions, and equipment state, to a central site (Operations Center) where the data can then be imported into various systems, like the existing North American Field Office (NAFO) web portal and mobile app. The service is dependent upon cellular coverage and customer acceptance of communication transmission.

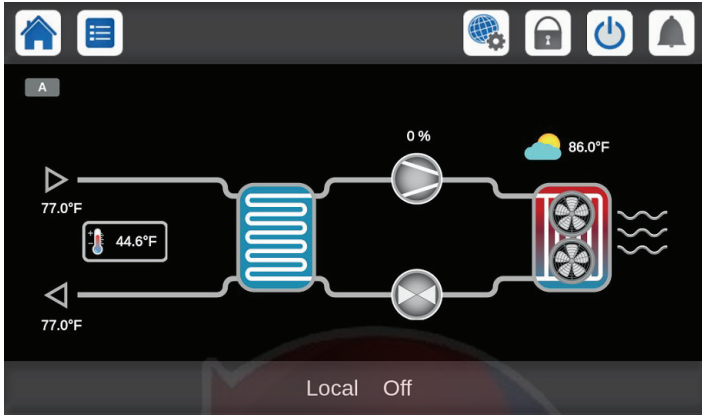

Carrier Controller Display

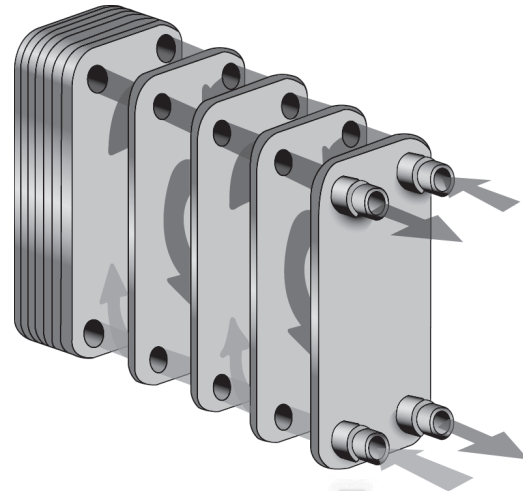

**Brazed Plate Evaporator
(Alternate Paths for Refrigerant and Water Flow)**

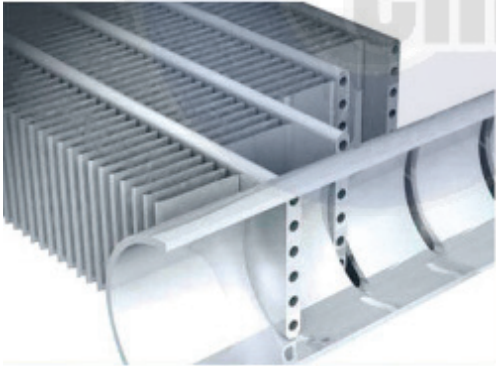

MCHX E-Coat

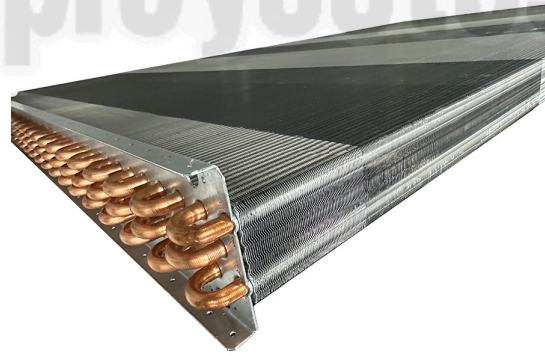

Optional Al/Cu, Al/Cu E-Coat

AquaSnap® Chiller Model Number Designation, 30RC010-060

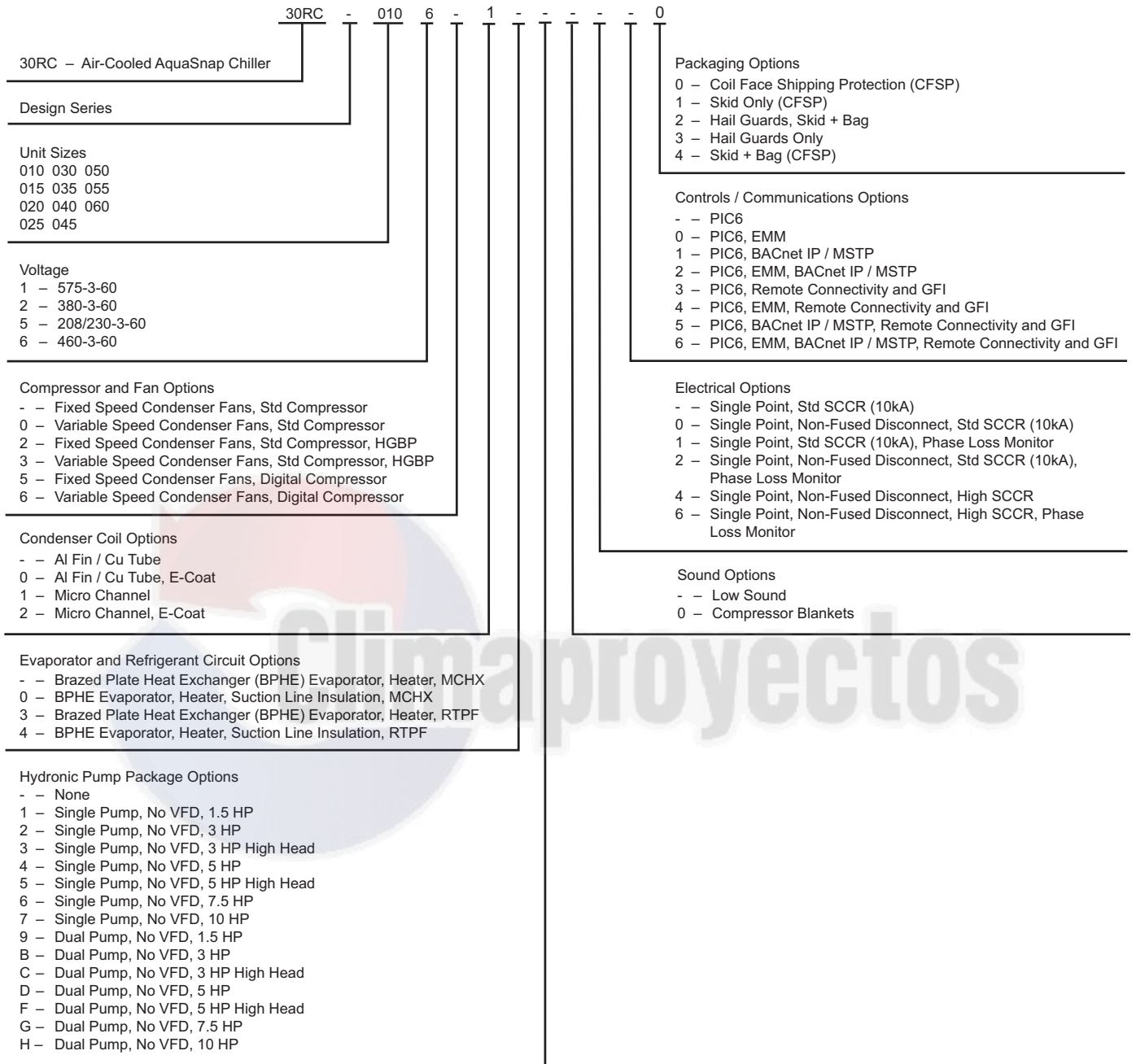

LEGEND

- EMM** — Energy Management Module
- GFI** — Ground Fault Interrupting
- MCHX** — Microchannel Heat Exchanger
- SCCR** — Short Circuit Current Rating
- VFD** — Variable Frequency Drive

Quality Assurance

ISO 9001: 2015-certified processes



Physical Data, 30RC 010-025 — English^a

UNIT 30RC	010	015	020	025
CHASSIS DIMENSIONS (in.)				
Length	44	44	89	89
Width ^b	67	67	67	67
Height	67	67	67	79
SHIPPING WEIGHT (lb)				
MCHX Condenser, No Pump	914	955	1271	1400
MCHX Condenser, Single Pump	1077	1117	1434	1563
MCHX Condenser, Dual Pump	1239	1280	1596	1597
Al-Cu Condenser, No Pump	974	1015	1343	1490
Al-Cu Condenser, Single Pump	1136	1177	1506	1652
Al-Cu Condenser, Dual Pump	1299	1340	1668	1815
OPERATING WEIGHT (lb)				
MCHX Condenser, No Pump	937	981	1305	1445
MCHX Condenser, Single Pump	1100	1144	1468	1608
MCHX Condenser, Dual Pump	1262	1306	1630	1770
Al-Cu Condenser, No Pump	997	1041	1377	1535
Al-Cu Condenser, Single Pump	1159	1203	1540	1697
Al-Cu Condenser, Dual Pump	1322	1366	1702	1860
REFRIGERANT TYPE				
R-32, EXV Controlled System				
Total Refrigerant Charge MCHX (lb)	7.50	8.00	10.50	12.75
Refrigerant Charge MCHX (lb) Ckt A/Ckt B	7.50/—	8.00/—	10.50/—	12.75/—
Total Refrigerant Charge RTPF (lb)	15.50	16.50	21.75	26.50
Refrigerant Charge RTPF (lb) Ckt A/Ckt B	15.50/—	16.50/—	21.75/—	26.50/—
COMPRESSORS				
Scroll, Hermetic				
Quantity	2	2	2	2
Speed (rpm)	3500			
Capacity (tons), Ckt A	10	15	20	26
No. Capacity Steps				
Standard	3	3	2	2
With Hot Gas Bypass	—	—	3	3
Digital Compressor Option	21	21	22	22
Minimum Capacity Step (%)				
Standard	40	40	50	50
With Hot Gas Bypass	—	—	24	29
Digital Compressor Option	20	20	17	17
Capacity (%)				
Circuit A	100	100	100	100
Circuit B	—	—	—	—
EVAPORATOR				
Braze, Direct-Expansion Plate Heat Exchanger				
Weight (lb) (empty)	32	38	49	62
Net Fluid Volume (gal)	1.20	1.56	2.28	3.72
Maximum Refrigerant Pressure (psig)	710			
Maximum Water-Side Pressure				
Without Pump (psig)	300			
With Pump (psig)	150			
CHILLED WATER CONNECTIONS (in.)				
Inlet and Outlet, Victaulic (IPS Carbon Steel) ^c	2	2	2	2
Drain (NPT)	0.25			

Physical data (cont)



Physical Data, 30RC 010-025 — English^a (cont)

UNIT 30RC	010	015	020	025
CONDENSER FANS	Axial Vertical Discharge, Composite			
Fan Speed (rpm)	850			
No. Blades...Diameter (in.)	9...30			
No. Fans	1	1	2	2
Total Airflow (cfm)	9,400	9,400	17,500	19,400
CONDENSER COILS	Novation MCHX Aluminum Tube, Aluminum Fin (Optional Round Tube Plate Fin)			
Quantity (Ckt A/Ckt B)	1/-	1/-	1/-	1/-
Total Face Area (sq ft)	19	19	26	33
Maximum Refrigerant Pressure (psig)	650			
HYDRONIC MODULE (Optional)	Pump(s), Strainer with Blowdown Valve, Expansion Tank, Pressure Taps, Drain and Vent Plugs, Flow Switch and Balance Valve			
Pump	Single or Dual, Centrifugal Monocell Pump(s), 3500 RPM, Dual Pumps with Check and Isolation Valves			
Expansion Tank Volume (gal)				
Total/Acceptance	4.4/3.2	4.4/3.2	4.4/3.2	4.4/3.2

NOTE(S):

- a. Flow switch and strainer are standard on all units, with or without hydronic package.
- b. The width shown here includes a 4 inch overhang for the control panel. The footprint width is 4 inches less than the indicated value.
- c. Unit connection is IPS Carbon Steel piping.



Physical Data, 30RC 030-060 — English^a

UNIT 30RC	030	035	040	045	050	055	060
CHASSIS DIMENSIONS (in.)							
Length	89	89	89	89	89	89	89
Width ^b	67	96	96	96	96	96	96
Height	67	67	67	79	79	79	79
SHIPPING WEIGHT (lb)							
MCHX Condenser, No Pump	1434	2237	2255	2337	2356	2458	2561
MCHX Condenser, Single Pump	1597	2581	2599	2681	2699	2802	2805
MCHX Condenser, Dual Pump	1759	2924	2942	3024	3043	3145	3148
AI-Cu Condenser, No Pump	1523	2382	2400	2516	2534	2637	2740
AI-Cu Condenser, Single Pump	1686	2726	2744	2859	2878	2981	3084
AI-Cu Condenser, Dual Pump	1848	3069	3087	3203	3203	3222	3427
OPERATING WEIGHT (lb)							
MCHX Condenser, No Pump	1478	2309	2335	2417	2438	2543	2646
MCHX Condenser, Single Pump	1641	2653	2679	2761	2781	2887	2890
MCHX Condenser, Dual Pump	1803	2996	3022	3104	3125	3230	3233
AI-Cu Condenser, No Pump	1567	2454	2480	2596	2616	2722	2825
AI-Cu Condenser, Single Pump	1730	2798	2824	2939	2960	3066	3169
AI-Cu Condenser, Dual Pump	1892	3141	3167	3283	3304	3409	3512
REFRIGERANT TYPE							
R-32, EXV Controlled System							
Total Refrigerant Charge MCHX (lb)	14.00	25.00	26.00	27.00	27.50	28.00	28.00
Refrigerant Charge MCHX (lb) Ckt A/Ckt B	14.00/—	12.50/12.50	13.00/13.00	13.50/13.50	13.75/13.75	14.00/14.00	14.00/14.00
Total Refrigerant Charge RTPF (lb)	29.00	52.00	54.00	56.00	57.00	58.00	58.00
Refrigerant Charge RTPF (lb) Ckt A/Ckt B	29.00/—	26.00/26.00	27.00/27.00	28.00/28.00	28.50/28.50	29.00/29.00	29.00/29.00
COMPRESSORS							
Scroll, Hermetic							
Quantity	2	4	4	4	4	4	4
Speed (rpm)	3500						
Capacity (tons), Ckt A	30	20	22	22	26	26	30
No. Capacity Steps							
Standard	2	4	4	4	4	4	4
With Hot Gas Bypass	3	5	5	5	5	5	5
Digital Compressor Option	22	44	44	44	44	44	44
Minimum Capacity Step (%)							
Standard	23	23	24	25	23	23	25
With Hot Gas Bypass	32	9	11	12	14	13	16
Digital Compressor Option	17	9	8	8	8	8	8
Capacity (%)							
Circuit A	100	54	47	47	50	46	50
Circuit B	—	46	53	53	50	54	50
EVAPORATOR							
Braze, Direct-Expansion Plate Heat Exchanger							
Weight (lb) (empty)	62	88	114	114	122	133	133
Net Fluid Volume (gal)	3.72	6.24	7.19	7.19	7.43	7.79	7.79
Maximum Refrigerant Pressure (psig)	710						
Maximum Water-Side Pressure							
Without Pump (psig)	300						
With Pump (psig)	150						
CHILLED WATER CONNECTIONS (in.)							
Inlet and Outlet, Victaulic (IPS Carbon Steel) ^c	2	2.5	2.5	2.5	2.5	2.5	2.5
Drain (NPT)	0.25						

Physical data (cont)



Physical Data, 30RC 030-060 — English^a (cont)

UNIT 30RC	030	035	040	045	050	055	060
CONDENSER FANS	Axial Vertical Discharge, Composite						
Fan Speed (rpm)	850						
No. Blades...Diameter (in.)	9...30						
No. Fans	2	3	3	3	3	4	4
Total Airflow (cfm)	19,400	29,600	30,500	30,500	30,500	38,800	38,500
CONDENSER COILS	Novation MCHX Aluminum Tube, Aluminum Fin (Optional Round Tube Plate Fin)						
Quantity (Ckt A/Ckt B)	1/-	1/1	1/1	1/1	1/1	1/1	1/1
Total Face Area (sq ft)	33	53	53	66	66	66	66
Maximum Refrigerant Pressure (psig)	650						
HYDRONIC MODULE (Optional)	Pump(s), Strainer with Blowdown Valve, Expansion Tank, Pressure Taps, Drain and Vent Plugs, Flow Switch and Balance Valve						
Pump	Single or Dual, Centrifugal Monocell Pump(s), 3500 RPM, Dual Pumps with Check and Isolation Valves						
Expansion Tank Volume (gal)							
Total/Acceptance	4.4/3.2	10.3/10.3	10.3/10.3	10.3/10.3	10.3/10.3	10.3/10.3	10.3/10.3

NOTE(S):

- a. Flow switch and strainer are standard on all units, with or without hydronic package.
- b. The width shown here includes a 4 inch overhang for the control panel. The footprint width is 4 inches less than the indicated value.
- c. Unit connection is IPS Carbon Steel piping.



Physical Data, 30RC 010-025 — SI^a

UNIT 30RC	010	015	020	025
CHASSIS DIMENSIONS (mm)				
Length	1117	1117	2260	2260
Width ^b	1701	1701	1701	1701
Height	1701	1701	1701	2006
SHIPPING WEIGHT (kg)				
MCHX Condenser, No Pump	415	433	577	635
MCHX Condenser, Single Pump	489	507	650	709
MCHX Condenser, Dual Pump	562	581	724	782
Al-Cu Condenser, No Pump	442	460	609	676
Al-Cu Condenser, Single Pump	515	534	683	749
Al-Cu Condenser, Dual Pump	589	608	757	823
OPERATING WEIGHT (kg)				
MCHX Condenser, No Pump	425	445	592	655
MCHX Condenser, Single Pump	499	519	666	729
MCHX Condenser, Dual Pump	572	592	739	803
Al-Cu Condenser, No Pump	452	472	624	696
Al-Cu Condenser, Single Pump	526	546	698	769
Al-Cu Condenser, Dual Pump	600	620	772	843
REFRIGERANT TYPE				
R-32, EXV Controlled System				
Total Refrigerant Charge MCHX (kg)	3.4	3.63	4.42	5.78
Refrigerant Charge MCHX (kg) Ckt A/Ckt B	3.4/-	3.63/-	4.42/-	5.78/-
Total Refrigerant Charge RTPF (kg)	8	7	8.6	11
Refrigerant Charge RTPF (kg) Ckt A/Ckt B	8/-	7/-	8.6/-	11/-
COMPRESSORS				
Scroll, Hermetic				
Quantity	2	2	2	2
Speed (R/s)	58.3			
Capacity (kw), Ckt A	35	53	70	91
Oil Charge (L) Ckt A/Ckt B	—	—	—	—
No. Capacity Steps				
Standard	3	3	2	2
With Hot Gas Bypass	3	3	2	2
Digital Compressor Option	—	—	3	3
Minimum Capacity Step (%)				
Standard	40	40	50	50
With Hot Gas Bypass	—	—	24	29
Digital Compressor Option	20	20	17	17
Capacity (%)				
Circuit A	100	100	100	100
Circuit B	—	—	—	—
EVAPORATOR				
Brazed, Direct-Expansion Plate Heat Exchanger				
Weight (kg) (empty)	15	17	22	28
Net Fluid Volume (L)	4.54	5.91	8.63	14.08
Maximum Refrigerant Pressure (kPa)				
1172				
Maximum Water-Side Pressure				
Without Pump(s) (kPa)				
2068				
With Pump (kPa)				
1034				
CHILLED WATER CONNECTIONS (in.)				
Inlet and Outlet, Victaulic (IPS Carbon Steel) ^c	2	2	2	2
Drain (NPT)	0.25			

Physical data (cont)



Physical Data, 30RC 010-025 — SI^a (cont)

UNIT 30RC	010	015	020	025
CONDENSER FANS	Axial Vertical Discharge, Composite			
Fan Speed (rpm)	850			
No. Blades...Diameter (mm)	9...762			
No. Fans	1	1	2	2
Total Airflow (cfm)	9,400	9,400	17,500	19,400
CONDENSER COILS	Novation MCHX Aluminum Tube, Aluminum Fin (Optional Round Tube Plate Fin)			
Quantity (Ckt A/Ckt B)	1/-	1/-	1/-	1/-
Total Face Area (sq m)	1.76	1.76	2.41	3.06
Maximum Refrigerant Pressure (kPa)	4481			
HYDRONIC MODULE (Optional)	Pump(s), Strainer with Blowdown Valve, Expansion Tank, Pressure Taps, Drain and Vent Plugs, Flow Switch and Balance Valve			
Pump	Single or Dual, Centrifugal Monocell Pump(s), 3500 RPM, Dual Pumps with Check and Isolation Valves			
Expansion Tank Volume (L)				
Total/Acceptance	16.7/12.11	16.7/12.11	16.7/12.11	16.7/12.11

NOTE(S):

- Flow switch and strainer are standard on all units, with or without hydronic package.
- The width shown here includes a 102 mm overhang for the control panel. The footprint width is 102 mm less than the indicated value.
- Unit connection is IPS Carbon Steel piping.



Physical Data, 30RC 030-060 — SI^a (cont)

UNIT 30RC	030	035	040	045	050	055	060
CHASSIS DIMENSIONS (mm)							
Length	2260	2260	2260	2260	2260	2260	2260
Width ^b	1701	2438	2438	2438	2438	2438	2438
Height	1701	1701	1701	2006	2006	2006	2006
SHIPPING WEIGHT (kg)							
MCHX Condenser, No Pump	650	1015	1023	1060	1069	1115	1162
MCHX Condenser, Single Pump	724	1171	1179	1216	1224	1271	1272
MCHX Condenser, Dual Pump	798	798	1334	1372	1372	1427	1428
Al-Cu Condenser, No Pump	691	691	1089	1141	1149	1196	1243
Al-Cu Condenser, Single Pump	765	765	1245	1297	1305	1352	1399
Al-Cu Condenser, Dual Pump	838	838	1453	1453	1461	1508	1554
OPERATING WEIGHT (kg)							
MCHX Condenser, No Pump	670	1047	1059	1096	1106	1153	1200
MCHX Condenser, Single Pump	744	1203	1215	1261	1261	1310	1311
MCHX Condenser, Dual Pump	818	1359	1371	1408	1417	1465	1466
Al-Cu Condenser, No Pump	711	1113	1125	1177	1187	1235	1281
Al-Cu Condenser, Single Pump	785	1269	1281	1333	1343	1391	1437
Al-Cu Condenser, Dual Pump	858	1425	1436	1489	1499	1546	1593
REFRIGERANT TYPE R-32, EXV Controlled System							
Total Refrigerant Charge MCHX (kg)	6.12	8.85	8.96	11.11	11.57	11.91	12.25
Refrigerant Charge MCHX (kg) Ckt A/Ckt B	6.12/-	4.42/4.42	4.54/4.42	5.33/	5.78/5.78	5.78/6.12	6.12/6.12
Total Refrigerant Charge RTPF (kg)	12	17	17.5	21.8	22.7	23.4	24
Refrigerant Charge RTPF (kg) Ckt A/Ckt B	12/-	8.62/8.62	8.85/15.62	10.43/11.34	11.34/11.34	11.34/11.97	11.97/11.97
COMPRESSORS Scroll, Hermetic							
Quantity	2	4	4	4	4	4	4
Speed (R/s)	58.3						
Capacity (kw), Ckt A	106	70	77	77	91	91	106
Oil Charge (L) Ckt A/Ckt B	—	10	11	15	15	17	17
No. Capacity Steps							
Standard	2	4	4	4	4	4	4
With Hot Gas Bypass	3	5	5	5	5	5	5
Digital Compressor Option	22	44	44	44	44	44	44
Minimum Capacity Step (%)							
Standard	23	23	24	25	23	23	25
With Hot Gas Bypass	32	9	11	12	14	13	16
Digital Compressor Option	17	9	8	8	8	8	8
Capacity (%)							
Circuit A	100	54	47	47	50	46	50
Circuit B	—	46	53	53	50	54	50
EVAPORATOR Brazed, Direct-Expansion Plate Heat Exchanger							
Weight (kg) (empty)	28	40	52	52	55	60	60
Net Fluid Volume (L)	14.08	23.06	27.22	27.22	28.13	29.49	29.49
Maximum Refrigerant Pressure (kPa) 1172							
Maximum Water-Side Pressure							
Without Pump(s) (kPa)	2068						
With Pump (kPa)	1034						
CHILLED WATER CONNECTIONS (in.)							
Inlet and Outlet, Victaulic (IPS Carbon Steel) ^c	2	2.5	2.5	2.5	2.5	2.5	2.5
Drain (NPT)	0.25						

Physical Data, 30RC 030-060 — SI^a (cont)

UNIT 30RC	030	035	040	045	050	055	060
CONDENSER FANS	Axial Vertical Discharge, Composite						
Fan Speed (rpm)	850						
No. Blades...Diameter (mm)	9...762						
No. Fans	2	3	3	3	3	4	4
Total Airflow (cfm)	19,400	29,600	30,500	30,500	30,500	38,800	38,500
CONDENSER COILS	Novation MCHX Aluminum Tube, Aluminum Fin (Optional Round Tube Plate Fin)						
Quantity (Ckt A/Ckt B)	1/-	1/1	1/1	1/1	1/1	1/1	1/1
Total Face Area (sq m)	3	5	5	6	6	6	6
Maximum Refrigerant Pressure (kPa)	4481						
HYDRONIC MODULE (Optional)	Pump(s), Strainer with Blowdown Valve, Expansion Tank, Pressure Taps, Drain and Vent Plugs, Flow Switch and Balance Valve						
Pump	Single or Dual, Centrifugal Monocell Pump(s), 3500 RPM, Dual Pumps with Check and Isolation Valves						
Expansion Tank Volume (L)							
Total/Acceptance	38.9/38.9	38.9/38.9	38.9/38.9	38.9/38.9	38.9/38.9	38.9/38.9	38.9/38.9

NOTE(S):

- Flow switch and strainer are standard on all units, with or without hydronic package.
- The width shown here includes a 102 mm overhang for the control panel. The footprint width is 102 mm less than the indicated value.
- Unit connection is IPS Carbon Steel piping.



MCHX Coil, No Pump Units

30RC SIZE	POUNDS				
	A	B	C	D	Total Weight
010	299	230	177	230	937
015	320	239	180	242	981
020	420	306	243	334	1305
025	457	337	276	373	1445
030	467	347	283	381	1478
035	696	779	441	394	2309
040	752	745	417	421	2335
045	729	819	459	409	2417
050	789	780	432	436	2438
055	799	818	469	458	2543
060	831	849	488	478	2646

30RC SIZE	KILOGRAMS				
	A	B	C	D	Total Weight
010	136	104	80	104	425
015	145	108	82	110	445
020	191	139	110	151	592
025	207	153	125	169	655
030	212	157	129	173	670
035	316	353	200	179	1047
040	341	338	189	191	1059
045	331	371	208	186	1096
050	358	354	196	198	1106
055	362	371	213	208	1153
060	377	385	221	217	1200

MCHX Coil, Single Pump Units

30RC SIZE	POUNDS				
	A	B	C	D	Total Weight
010	314	296	238	252	1100
015	335	305	240	264	1144
020	447	361	294	365	1468
025	484	392	327	404	1608
030	495	400	334	413	1641
035	732	913	560	449	2653
040	787	881	534	477	2679
045	765	953	579	464	2761
050	823	916	550	493	2781
055	833	953	587	514	2887
060	835	953	588	516	2890

30RC SIZE	KILOGRAMS				
	A	B	C	D	Total Weight
010	142	134	108	114	499
015	152	138	109	120	519
020	203	164	134	165	666
025	220	178	148	183	729
030	224	181	151	187	744
035	332	414	254	204	1203
040	357	400	242	216	1215
045	347	432	262	210	1252
050	373	415	249	224	1261
055	378	432	266	233	1310
060	378	432	267	234	1311

MCHX Coil, Dual Pump Units

30RC SIZE	POUNDS				
	A	B	C	D	Total Weight
010	331	362	297	272	1262
015	352	372	298	283	1306
020	474	416	345	393	1630
025	510	447	379	433	1770
030	522	454	386	442	1803
035	772	1044	679	501	2996
040	824	1014	653	531	3022
045	803	1085	699	518	3104
050	859	1050	668	548	3125
055	871	1086	707	568	3230
060	872	1085	708	569	3233

30RC SIZE	KILOGRAMS				
	A	B	C	D	Total Weight
010	150	164	135	123	572
015	160	169	135	128	592
020	215	189	157	178	739
025	232	203	172	196	803
030	237	206	175	200	818
035	350	473	308	227	1359
040	374	460	296	241	1371
045	364	492	317	235	1408
050	390	476	303	248	1417
055	395	492	321	257	1465
060	396	492	321	258	1466

AL/CU Coil, No Pump Units

30RC SIZE	POUNDS				
	A	B	C	D	Total Weight
010	296	233	206	262	997
015	318	242	207	274	1041
020	422	307	273	375	1377
025	457	338	315	1377	1535
030	467	346	321	433	1567
035	739	828	468	418	2454
040	799	792	443	447	2480
045	783	880	493	439	2596
050	847	837	464	468	2616
055	855	875	502	490	2722
060	887	907	521	510	2825

30RC SIZE	KILOGRAMS				
	A	B	C	D	Total Weight
010	134	106	94	119	452
015	144	110	94	124	472
020	191	139	124	170	624
025	207	153	143	193	696
030	212	157	146	196	711
035	335	376	212	190	1113
040	363	359	201	203	1125
045	355	399	224	199	1177
050	384	380	212	1187	1187
055	388	397	228	222	1235
060	402	411	236	231	1281

AL/CU Coil, Single Pump Units

30RC SIZE	POUNDS				
	A	B	C	D	Total Weight
010	312	299	269	280	1159
015	333	309	271	292	1203
020	448	362	325	403	1540
025	485	393	367	453	1697
030	495	400	373	462	1730
035	772	962	590	473	2798
040	829	928	563	503	2824
045	815	1015	617	494	2939
050	876	975	585	525	2960
055	885	1012	623	545	3066
060	915	1044	644	565	3169

30RC SIZE	KILOGRAMS				
	A	B	C	D	Total Weight
010	142	136	122	127	526
015	151	140	123	132	546
020	203	164	148	183	698
025	220	178	166	206	769
030	224	181	169	210	785
035	350	436	268	214	1269
040	376	421	255	228	1281
045	369	460	280	224	1333
050	397	442	265	238	1343
055	402	459	283	247	1391
060	415	474	292	256	1437

AL/CU Coil, Dual Pump Units

30RC SIZE	POUNDS				
	A	B	C	D	Total Weight
010	330	363	331	300	1322
015	351	372	332	311	1366
020	475	417	378	432	1702
025	512	448	420	480	1860
030	522	455	426	490	1892
035	809	1099	711	523	3141
040	864	1065	683	554	3167
045	849	1148	739	547	3283
050	908	1110	708	579	3304
055	919	1146	746	599	3409
060	948	1178	768	618	3512

30RC SIZE	KILOGRAMS				
	A	B	C	D	Total Weight
010	150	165	150	136	600
015	159	169	151	141	620
020	215	189	171	196	772
025	232	203	190	218	843
030	237	206	193	222	858
035	367	499	323	237	1425
040	392	483	310	251	1436
045	385	520	335	248	1489
050	412	503	321	262	1499
055	417	520	338	271	1546
060	430	534	348	280	1593

Unit Mounting Points

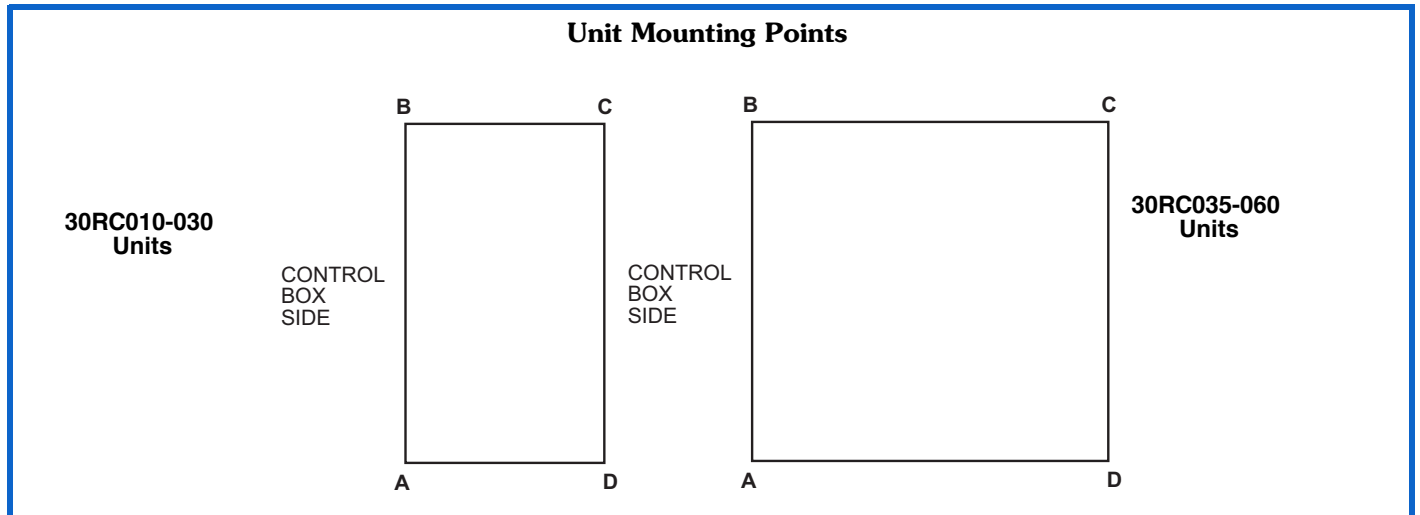

ITEM	FACTORY-INSTALLED OPTION	FIELD-INSTALLED ACCESSORY
Condenser Coil and Sound Options		
MCHX, E-Coated	X	
Aluminum Fins/Copper Tube	X	
Aluminum Fins/Copper Tube, E-Coat	X	
Compressor Blankets	X	X
Controls/Communication Options		
BACnet IP	X	
LonWorks Translator		X
Energy Management Module (EMM)	X	X
Remote Connectivity (includes GFI convenience outlet)	X	
Electrical Options^a		
Unit-Mounted Main Disconnect, Non-Fused	X	
GFI Convenience Outlet (115 v)	X	X
Phase Loss Monitor	X	
High SCCR (Short Circuit Current Rating) ^b (includes non-fused disconnect)	X	
Hydronics Option (60 Hz only)		
Hydronic Pump Package	X	
Chilled Water Storage Tank		X
Refrigeration Circuit Options		
High-Efficiency Variable Condenser Fans (standard on sizes 010, 015)	X	
Hot Gas Bypass (not available as a factory option on sizes 010, 015)	X	X
Suction Line Insulation	X	
Digital Compressor	X	
Security/Packaging Options		
Hail Guards	X	X
Vibration Isolation		X
Wind Baffles		X

NOTE(S):

- a. Std SCCR (short circuit current rating) (10 kA).
- b. High SCCR (65 kA for all voltages other than 575, 25 kA for 575-v units).

LEGEND

- E-Coated** — Epoxy Coating Applied to Entire Coil Assembly
- EMM** — Energy Management Module
- LON** — Local Operating Network
- MCHX** — Microchannel Heat Exchanger

Factory-Installed Options

Condenser coil

Condenser coil options are available to match coil construction to the site conditions for the best durability. Refer to the Condenser Coil Corrosion Protection Options table on page 18 or the appropriate selection guide for more information.

Compressor blankets

Compressor blankets provide a combination of low sound AeroAcoustic™ fans with sound blankets.

Digital compressor control

Digital compressor control allows incremental unloading for a closer match to building load. This option is not available on any application with a leaving fluid temperature below 38°F (3.3°C).

High-efficiency variable condenser fans

High-efficiency variable condenser fans control the speed of all fans for improvement in part load efficiency and sound levels. Additionally, high-efficiency variable condenser fans maintain head pressure control down to -20°F (-29°C) ambient temperature with the use of glycol and

wind baffles or hail guards. Varying the speed of all fans on a circuit to a prescribed speed provides accurate head pressure control to the most efficient point while achieving optimum usage of the coils to accomplish excellent part load efficiency. These fans are the key component of the 30RC chiller with Greenspeed® intelligence. This option is standard on unit sizes 010 and 015.

High short circuit current rating (SCCR)

High short circuit current rating (SCCR) provides a short circuit current rating protection for the unit up to 65 kA on 460-v and 208/230-v units, and up to 25 kA on 575-v units. The high SCCR option includes a non-fused disconnect for all unit sizes. The standard SCCR rating, regardless of voltage, is 10 kA.

Non-fused disconnect

Non-fused disconnect includes factory-installed non-fused disconnect capability for power and control located at the unit. This option is included with the high SCCR option.

Energy management module (EMM)

Energy management module (EMM) provides energy management capabilities to minimize chiller energy consumption. Several features are provided with this module

including cooling set point reset and demand limit control from a 4 to 20 mA signal, 2-point demand limit control (from 0 to 100%) activated by a remote contact closure, discrete input for “Ice Done” indication for ice storage system interface, and dual chiller leaving water temperature or chilled water reset based upon space temperature. The EMM is also available as an accessory.

Hydronic pump package (208/230 and 460-v only)

Hydronic pump package option adds circulating pumps, complete with controls, contactor, VFD compatible motors, and insulated expansion tank. Available in single or dual (primary/secondary controlled) pump versions.

Hot gas bypass

Hot gas bypass option allows additional capacity reduction for unit operation down below the minimum standard step of capacity. This option is not available on units with the digital compressor option, on size 010 and 015 units, or on any application with a leaving fluid temperature below 38°F (3.3°C). This option is also available as an accessory on all 30RC units without digital compressors.

Hail guards

Hail guards consist of louvered, sheet metal panels which securely fasten to the chiller and provide condenser coil protection against hail and physical damage. This option directly covers the coil(s) on all sizes. Hail guards also provide the functionality of wind baffles. This option is also available as an accessory.

BACnet IP

Provides an interface between the chiller and a BACnet Local Area Network (LAN) and allows integration with i-Vu® Open control system or a third-party BACnet building automation system. Field configuration is required.

Suction line insulation

Suction line insulation provides a tubular, closed-cell form of insulation that is factory-installed on the chiller suction piping.

Phase loss monitor

Phase loss monitor provides the unit with protection against phase loss.

Remote connectivity (includes GFI convenience outlet)

Remote connectivity provides a secure cellular system which communicates information such as equipment parameters, operating conditions and equipment status to a central operating site.

GFI convenience outlet (includes remote connectivity)

GFI convenience outlet is a factory-installed convenience outlet that includes a 4-amp GFI (ground fault interrupter) receptacle with independent fuse protection. The convenience outlet is a 115-v female receptacle. The GFI convenience outlet is also available as a field-installed accessory.

Field-Installed Accessories

Energy management module

Energy management module provides energy management capabilities to minimize chiller energy consumption. Several features are provided with this module including cooling set point reset and demand limit control from a 4

to 20 mA signal, 2-point demand limit control (from 0 to 100%) activated by a remote contact closure, discrete input for “Ice Done” indication for ice storage system interface, and dual chiller leaving water temperature or chilled water reset based upon space temperature. The EMM is also available as a factory-installed option.

LONworks Translator

LONworks Translator provides an interface between the unit and a local operating network (i.e., LonWorks®¹ FT-10A ANSI/EIA-709.1). Field programming is required.

Chilled water storage tank

Chilled water storage tank provides a minimum of 4 gallons per ton loop storage capacity. Includes insulated steel shell tank, Victaulic pipe connections, electric tank heaters (with thermostat to prevent overheating), electric cables, vent, drain, and enclosure to allow tank to be installed under the chiller to protect to -20°F (-29°C). The power supply for the storage tank is obtained from the chiller, so no separate power source is required for this accessory.

Vibration isolation

Vibration isolation consists of field-installed 1/4-in. (0.64 cm) neoprene isolator pads (24-in. x 3-in.) (61.0 cm x 7.6 cm) that reduce vibration transmission from the compressor through the floor and into the conditioned space.

Compressor blankets

Compressor blankets reduce unit sound levels by providing an acoustic blanket on each compressor.

Hot gas bypass

Hot gas bypass accessory allows additional capacity reduction for unit operation below the minimum standard step of capacity. This accessory is not available on units that have the digital compressor option or any application with a leaving fluid temperature below 38°F (3.3°C). This field-installed accessory is also available as a factory-installed option, but the factory option is not available with digital compressors or unit sizes 010 and 015.

GFI convenience outlet

GFI convenience outlet is a field-installed convenience outlet that includes a 4-amp GFI (ground fault interrupter) receptacle with independent fuse protection. The convenience outlet is a 115-v female receptacle. The GFI convenience outlet may be factory-installed but only in combination with other factory options.

Hail guards

Hail guards consist of louvered, sheet metal panels which securely fasten to the chiller and provide condenser coil protection against hail and physical damage. This accessory directly covers the coil(s) on all sizes. Hail guards also provide the functionality of wind baffles. Hail guards are also available as a factory-installed option.

Wind baffles

Wind baffles facilitate operation down to -20°F (-29°C) when used in conjunction with either low ambient temperature head pressure control or high-efficiency variable condenser fans.

1. Third-party trademarks and logos are the property of their respective owners.

Condenser Coil Corrosion Protection Options

ENVIRO-SHIELD™ OPTION ^a	ENVIRONMENT				
	Standard	Mild Coastal	Severe Coastal	Industrial	Combined Industrial/Coastal
Novation® Heat Exchanger (Standard)	See NACO Packaged Chiller Builder				
Novation Heat Exchanger, E-coat	See NACO Packaged Chiller Builder				
AL Fins	X				
AL Fins, E-coat			X	X	X

NOTE(S):

a. See NACO Packaged Chiller Builder for details. Additional corrosion protection is available. For Novation or round tube/plate fin (RTPF) heat exchangers, see selection guide "Environmental Corrosion Protection" (Publication 04-581061-01).

LEGEND

AL — Aluminum
NACO — North American Commercial Operations



Chiller Layout Dimensions

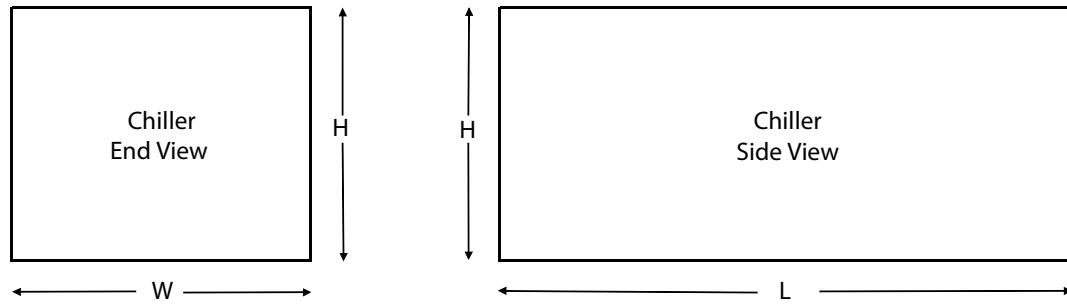

Chiller Layout Dimensions - English

30RC UNIT	LENGTH (in.)	WIDTH (in.)	HEIGHT (in.)
010	67	44	66
015	67	44	66
020	89	44	66
025	89	44	78
030	89	44	78
035	89	96	66
040	89	96	66
045	89	96	78
050	89	96	78
055	89	96	78
060	89	96	78

Chiller Layout Dimensions - SI

30RC UNIT	LENGTH (mm)	WIDTH (mm)	HEIGHT (mm)
010	1683	1021	1689
015	1683	1021	1689
020	2241	1021	1689
025	2241	1021	1994
030	2241	1021	1994
035	2241	2340	1689
040	2241	2340	1689
045	2241	2340	1994
050	2241	2340	1994
055	2241	2340	1994
060	2241	2340	1994

NOTES:

1. The chiller width shown in the chart does not include 4 inches (102 mm) of width associated with the control panel.
2. When determining the suitability of a given chiller for a space, do not forget to consider the availability of adequate airflow to that location. Airflow guidelines and clearances are presented in the Application Section of this publication.

Accessory Storage Tank for Unit Sizes 010 and 015

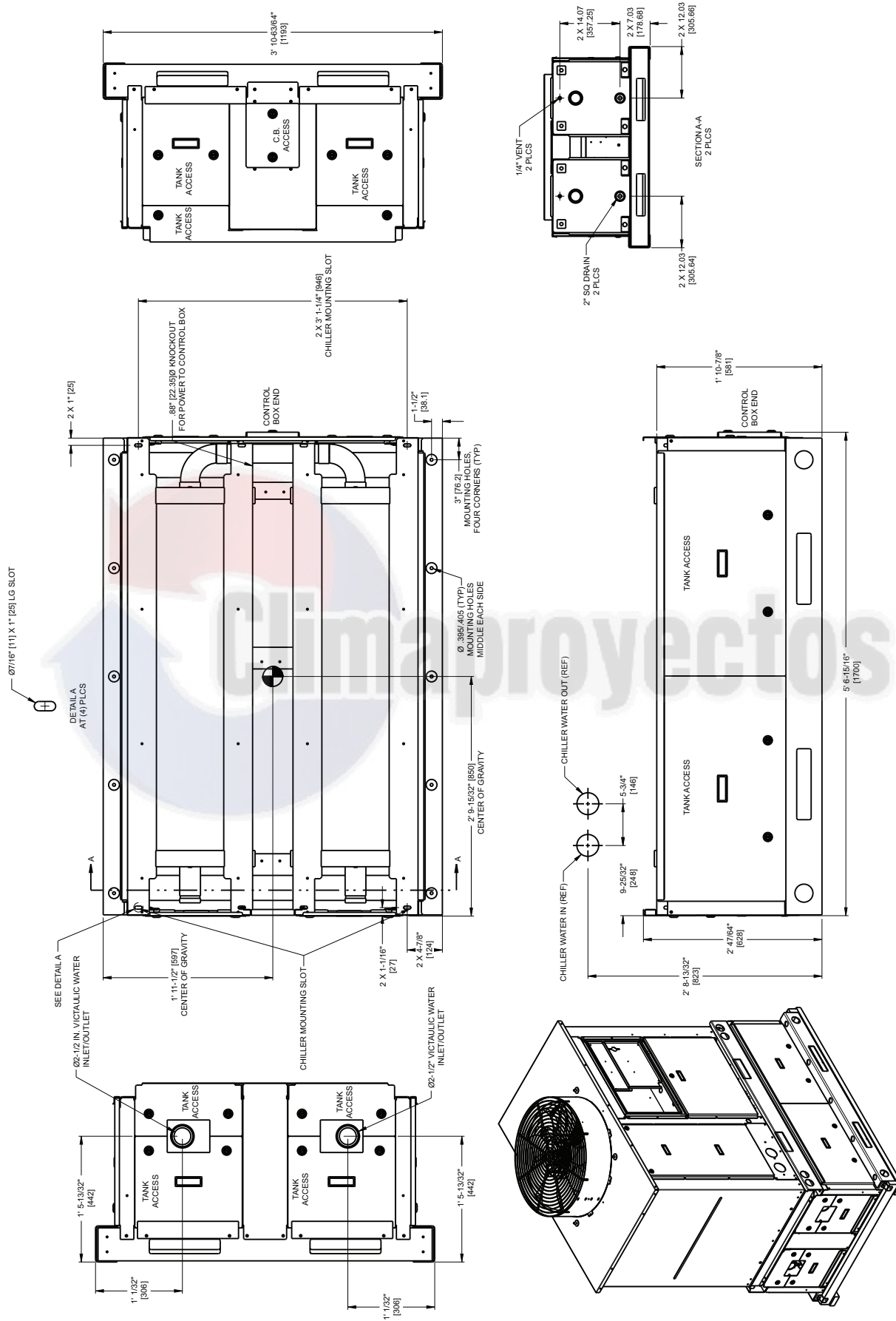

Selection procedure



Carrier's NACO (North American Commercial Operations) Packaged Chiller Builder Program provides quick, easy selection of Carrier's air-cooled liquid chillers. The program considers specific temperature, fluid, and flow requirements, among other factors such as fouling and altitude corrections. Before selecting a chiller, consider the following points:

Leaving water (fluid) temperature (LWT)

- If the LWT is less than 38°F (3.3°C), a suitable anti-freeze solution must be used. The solution concentration must be sufficient to protect the chilled water loop to a freeze protection (first crystals) concentration of at least 15°F (8.3°C) below the leaving water temperature set point.
- If the LWT requirement is greater than 70°F (21.1°C), a mixing loop is required.

Entering water temperature (EWT)

- If the EWT requirement is greater than 80°F (26.7°C), a mixing loop is required. The EWT cannot exceed 80°F (26.7°C) for extended operation. Pulldown can be accomplished from 95°F (35°C).

Evaporator flow rate or evaporator delta-T

- The evaporator delta-T must fall between 3 and 20°F (1.7 and 11°C) while still meeting both the fluid min/max temperature requirements and the fluid min/max flow requirements.

For larger or smaller delta-T applications, a mixing loop is required.

- If the evaporator flow is variable, then the rate of change of flow should not exceed 10% per minute. A loop volume of greater than 3 gallons per ton (3.25 L per kW) is recommended.

Evaporator pressure drop

- A high evaporator pressure drop can be expected when the evaporator delta-T is low. A mixing loop can help to alleviate this situation.
- A low evaporator pressure drop can be expected when the evaporator delta-T is high.

Water quality, fouling factor

- Poor water quality can increase evaporator fouling.
- Higher than standard fouling factors lead to lower capacity and higher input kW from a given chiller size compared to running the same application with better quality water (and lower fouling factors).

Operation below 32°F (0°C)

- Variable speed condenser fans are required.

- Wind baffles or hail guards are required.
- Consider higher loop volumes, at least 6 gallons per nominal ton (6.5 L per kW).
- Loop freeze protection with glycol is strongly recommended to a minimum of 15°F (8°C) below lowest anticipated ambient temperature.
- Chilled water pump control is strongly recommended; otherwise, override capability is required.

Chiller idle below 32°F (0°C)

- Loop freeze protection with glycol is strongly recommended to a minimum of 15°F (8°C) below lowest anticipated ambient temperature.
- Chilled water pump control is strongly recommended; otherwise, override capability is required.

Ambient temperature

- Highest allowable ambient air temperature is 115°F for full load operation and to 125.6°F for part load operation.
- Chillers are capable of starting and operating down to -20°F (-29°F) on sizes 010 and 015, 45°F (7.2°C) on sizes 020-030 and 32°F (0°C) on sizes 035-060 as standard. With the inclusion of wind baffles or hail guards, as well as variable speed condenser fans, units are capable of starting as low as -13°F (-25°C) and operating as low as -20°F (-29°C) ambient temperature.

Evaporator capacity requirements:

- Do not oversize the chillers by more than 15% at design conditions.
- If additional stages of capacity control are desired, the digital option should be selected.
- If evaporator capacity control is required below the standard minimum step of unloading, the minimum load control option should be employed (not available with digital compressors).
- Coil corrosion requirements
- Coastal application
- Industrial application
- Coastal/industrial application
- Urban application
- Farming

See NACO Packaged Chiller Builder and appropriate selection guides for more information.

Selection procedure (cont)



Carrier's electronic catalog chiller selection program provides quick, easy selection of Carrier chillers. The program considers specific temperature, fluid, flow requirements, system pressure drop (for proper pump selection, when

required), as well as other factors, such as fouling and altitude correction.

To select a 30RC chiller, including optional pump package when required, use the NACO (North American Commercial Operation) Packaged Chiller Builder Program.

Pump Impeller Sizes^a

UNIT 30RC	PUMP Hp	SINGLE PUMP					DUAL PUMP				
		Option Code ^b		Rpm	Impeller Dia. (in.)	Pump Curve	Option Code ^b		Rpm	Impeller Dia. (in.)	Pump Curve
		non-VFD	VFD				non-VFD	VFD			
010-030	1.5	1	N/A	3500	4.25	I	9	N/A	3500	4.25	I
	3	2	N/A	3500	4.75	I	B	N/A	3500	4.75	I
	3 (high head)	3	N/A	3500	5.00	I	C	N/A	3500	5.00	I
	5	4	N/A	3500	5.50	II	D	N/A	3500	5.50	II
035-045	3	2	N/A	3500	4.75	I	B	N/A	3500	4.75	I
	3 (high head)	3	N/A	3500	5.25	I	C	N/A	3500	5.25	I
	5	4	N/A	3500	4.50	III	D	N/A	3500	4.50	III
	5 (high head)	5	N/A	3500	4.88	III	F	N/A	3500	4.88	III
	7.5	6	N/A	3500	5.50	IV	G	N/A	3500	5.50	IV
050-060	3 (high head)	3	N/A	3500	5.25	I	C	N/A	3500	5.25	I
	5	4	N/A	3500	4.50	III	D	N/A	3500	4.50	III
	5 (high head)	5	N/A	3500	4.88	III	F	N/A	3500	4.88	III
	7.5	6	N/A	3500	5.50	IV	G	N/A	3500	5.50	IV
	10	7	N/A	3500	6.00	IV	H	N/A	3500	6.00	IV

NOTE(S):

- a. Pump selections are chiller size dependent. For example, option code 4 on a 30RC010-030 chiller is not the same as option code 4 on a 30RC035-045 chiller.
- b. Option Code refers to the Hydronics Option (position 13) in the model number. See the 30RC nomenclature on page 5 for option identification.

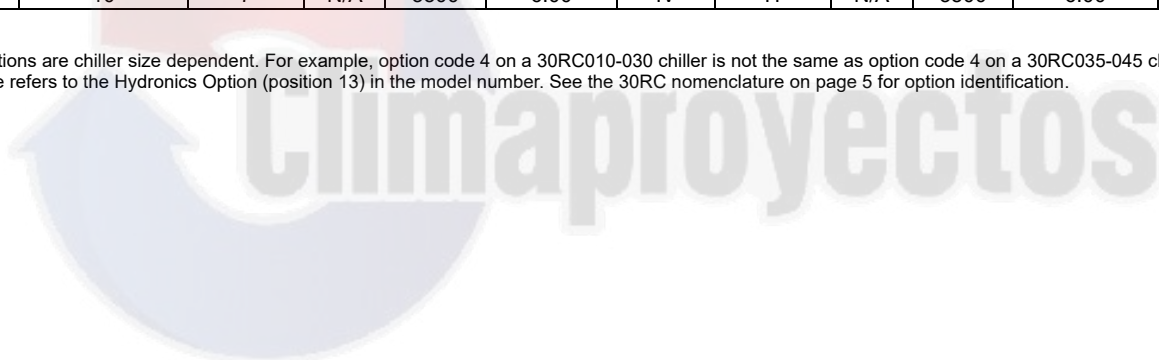

Pump Curve I for Hydronic Package — Single Pump 1.5 Hp, Dual Pump 1.5 Hp, Single Pump 3.0 Hp, Dual Pump 3.0 Hp, Single Pump High Head 3.0 Hp, Dual Pump High Head 3.0 Hp — 30RC010-060 Units

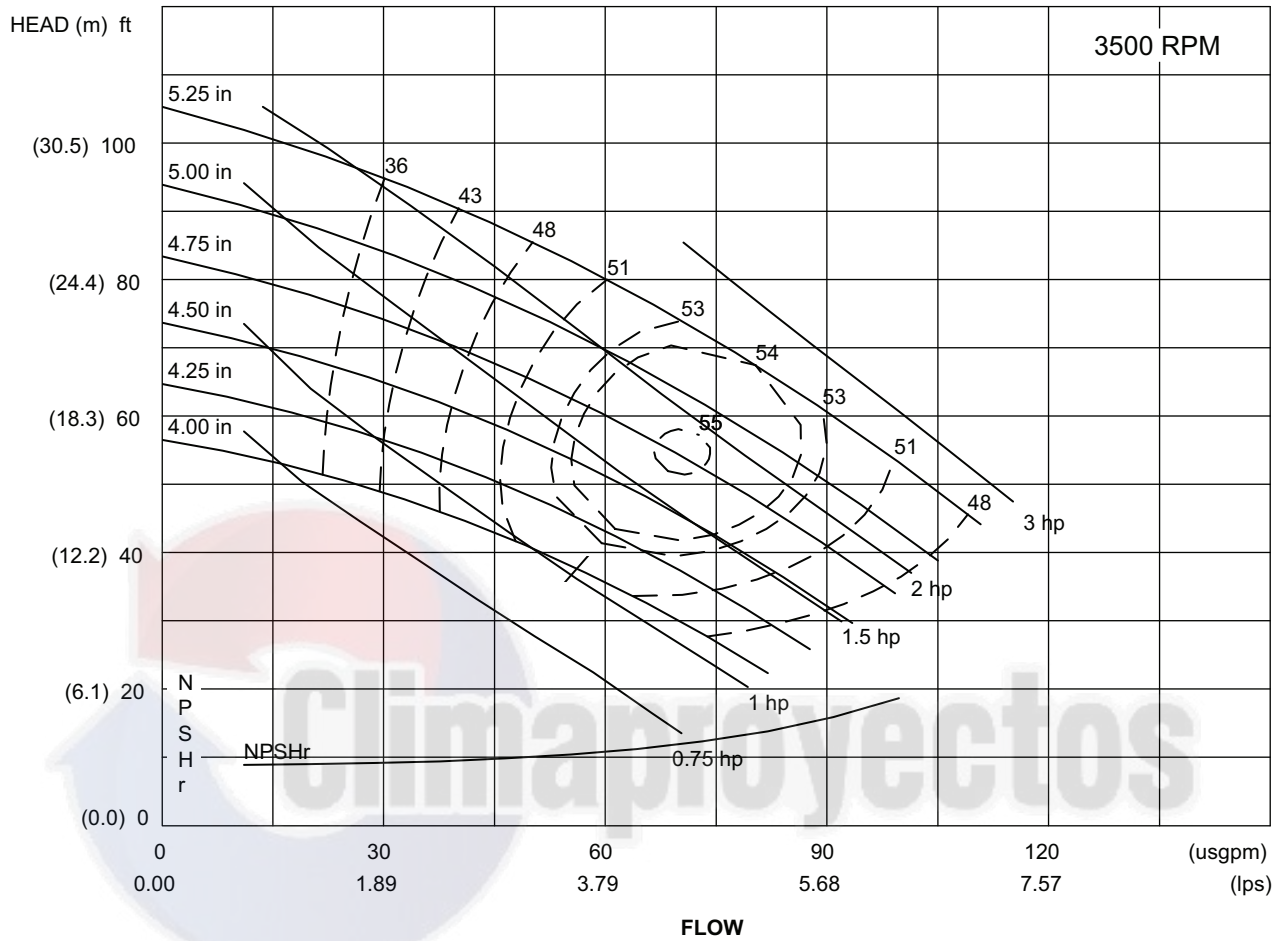

water, specific gravity = 1.00

LEGEND

NPSHr — Net Pump Suction Head Required

NOTE: Refer to the Pump Impeller Sizes chart on page 24 for proper unit size matching as well as the determination of the impeller diameter.

Performance data (cont)



**Pump Curve II for Hydronic Package — Single Pump 5.0 Hp,
Dual Pump 5.0 Hp — 30RC010-030 Units**

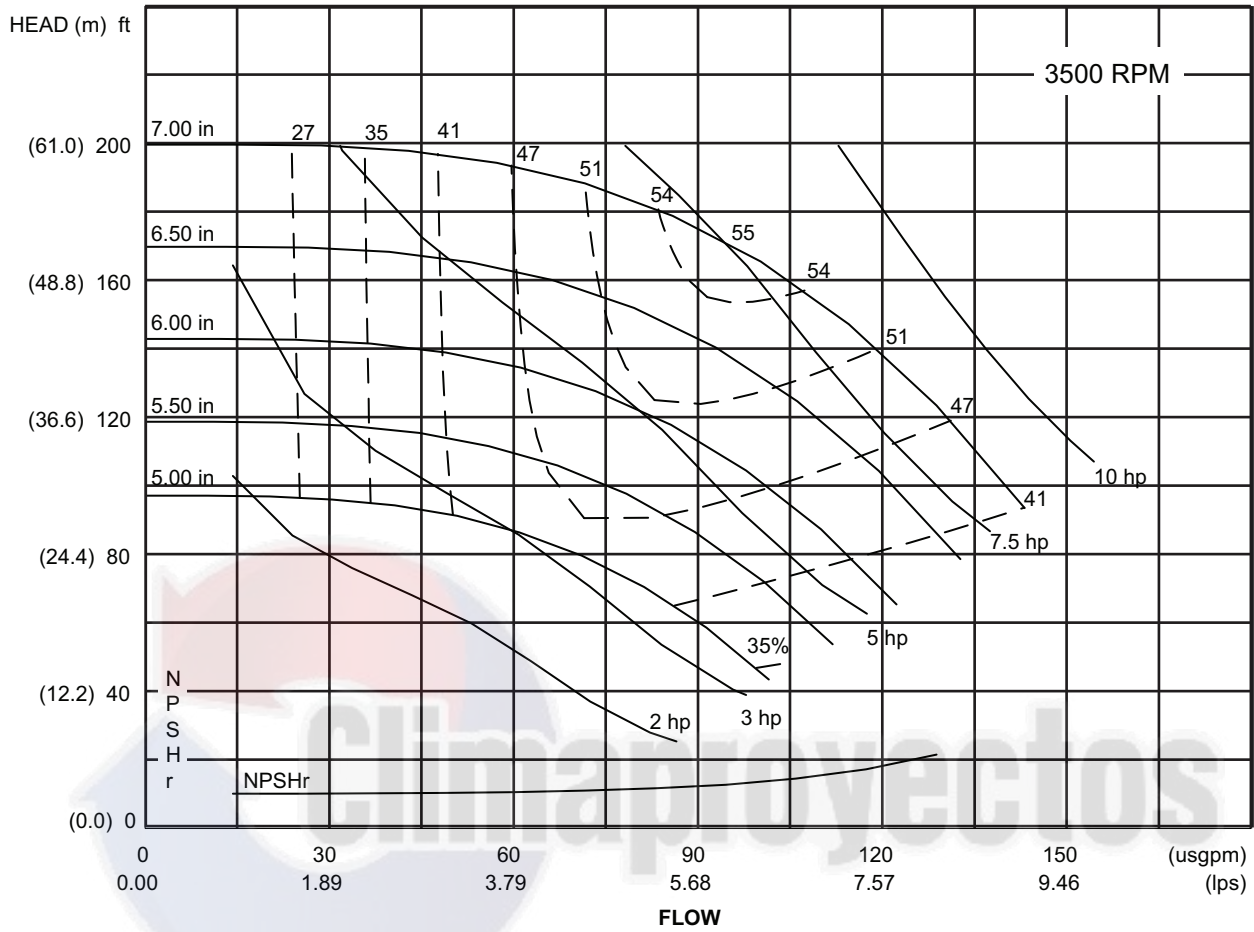

water, specific gravity = 1.00

LEGEND

NPSHr — Net Pump Suction Head Required

NOTE: Refer to the Pump Impeller Sizes chart on page 24 for proper unit size matching as well as the determination of the impeller diameter.

Performance data (cont)



Pump Curve III for Hydronic Package— Single Pump 5.0 Hp, Dual Pump 5.0 Hp, Single Pump High Head 5.0 Hp, Dual Pump High Head 5.0 Hp — 30RC035-060 Units

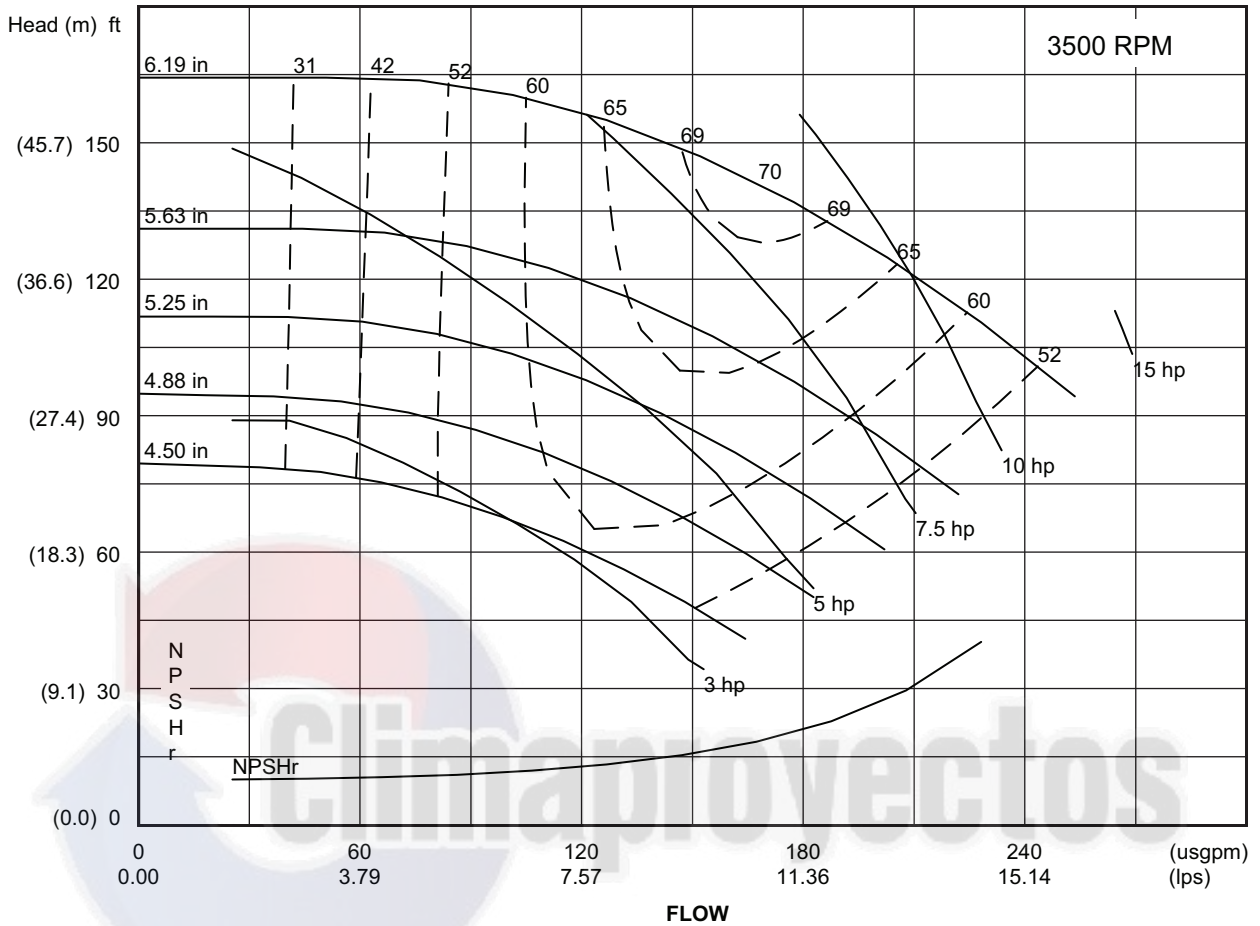

water, specific gravity = 1.00

LEGEND

NPSHr — Net Pump Suction Head Required

NOTE: Refer to the Pump Impeller Sizes chart on page 24 for proper unit size matching as well as the determination of the impeller diameter.

Performance data (cont)



Pump Curve IV for Hydronic Package — Single Pump 7.5 Hp, Dual Pump 7.5 Hp, Single Pump 10.0 Hp, Dual Pump 10.0 Hp — 30RC035-060 Units

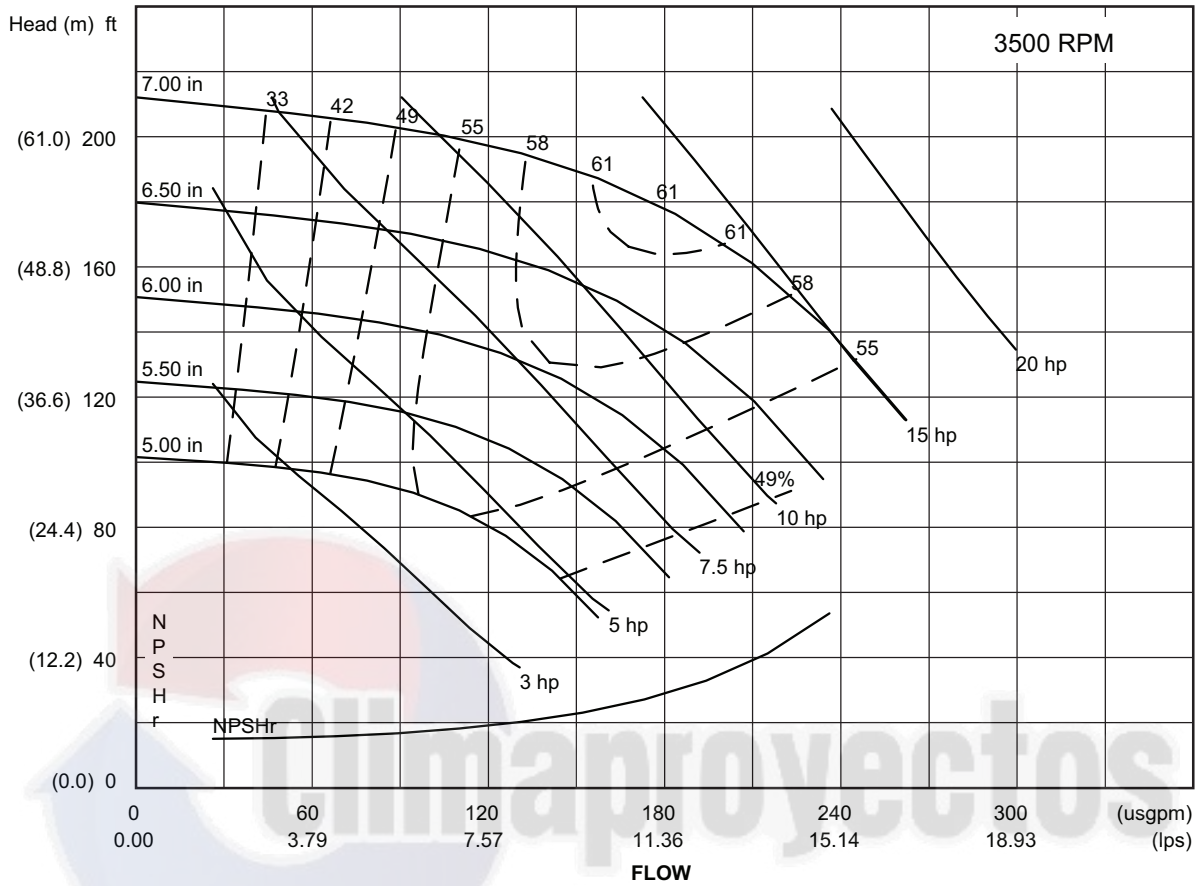

water, specific gravity = 1.00

LEGEND

NPSHr — Net Pump Suction Head Required

NOTE: Refer to the Pump Impeller Sizes chart on page 24 for proper unit size matching as well as the determination of the impeller diameter.

Heat Exchanger Pressure Drop — 30RC010-030 (English)

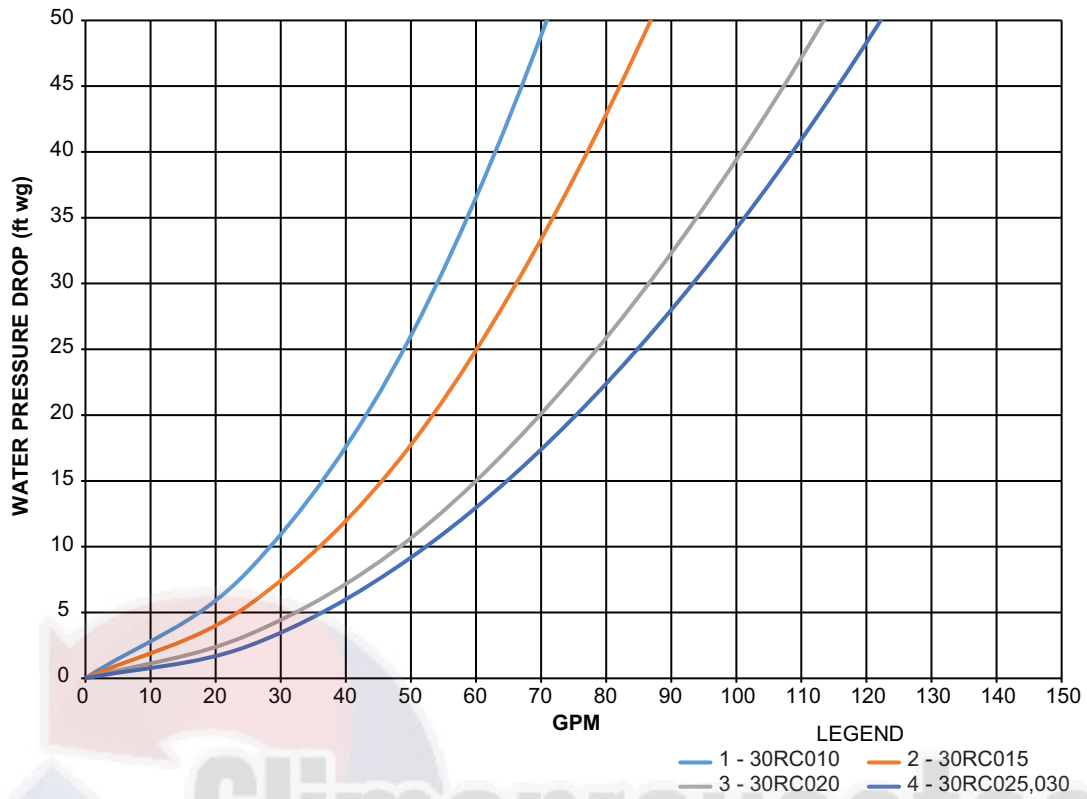

Heat Exchanger Pressure Drop — 30RC035-060 (English)

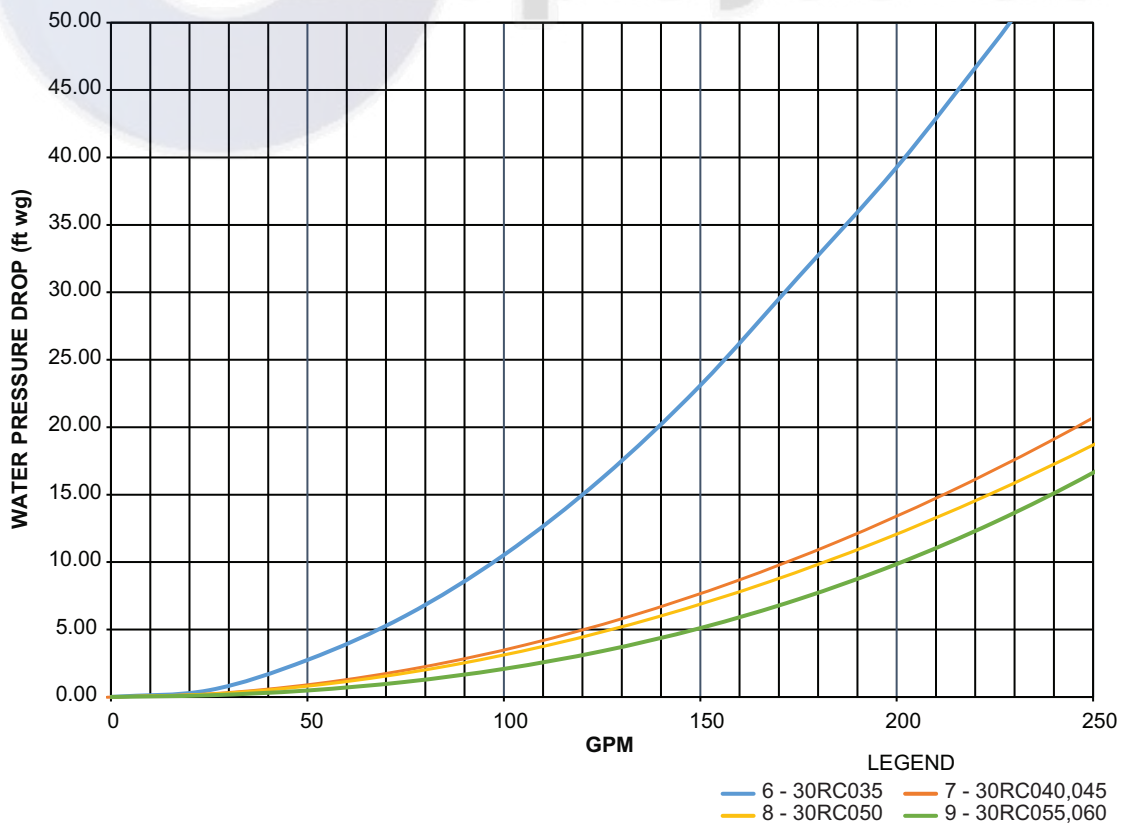

Heat Exchanger Pressure Drop — 30RC010-030 (SI)

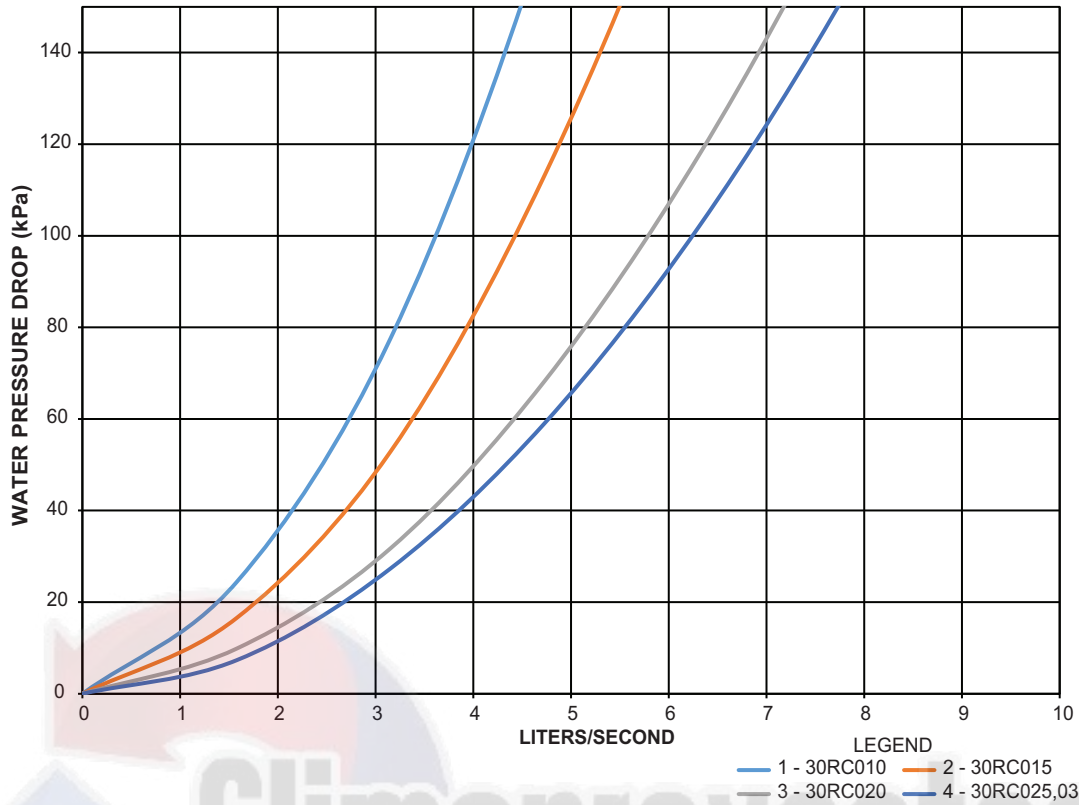

Heat Exchanger Pressure Drop — 30RC035-060 (SI)

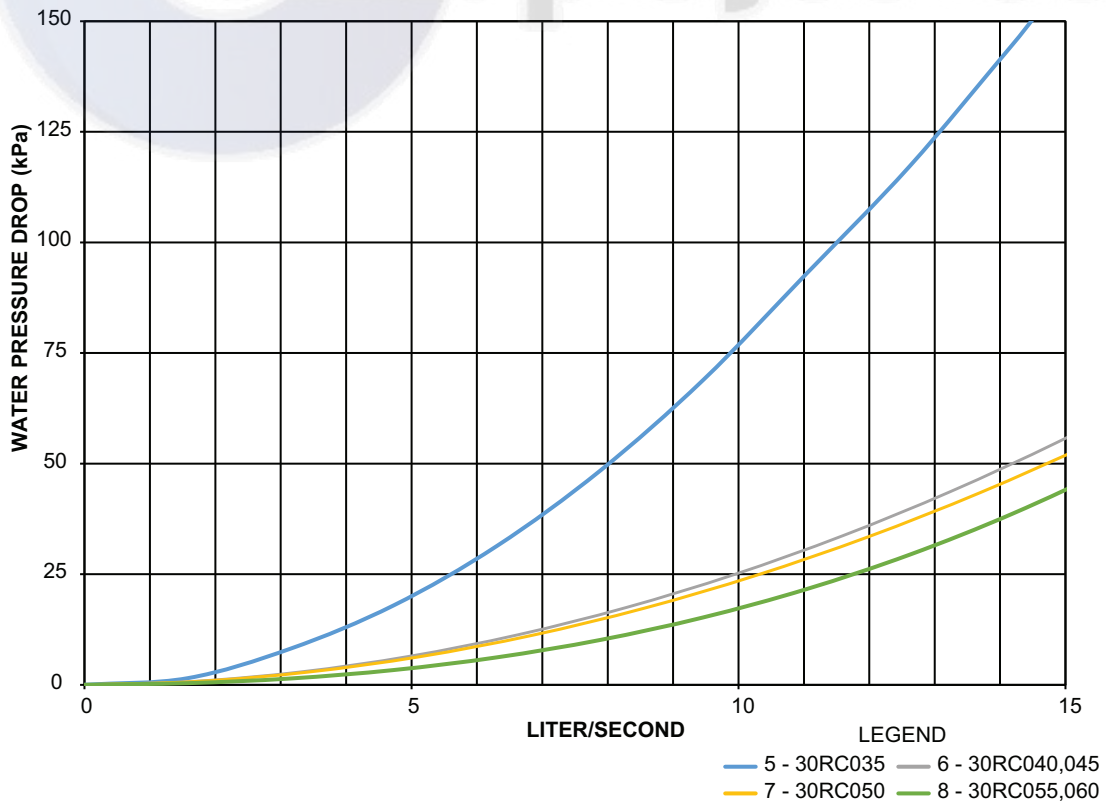

Unit Pressure Drop — No Hydronic Package — 30RC010-030 (English)

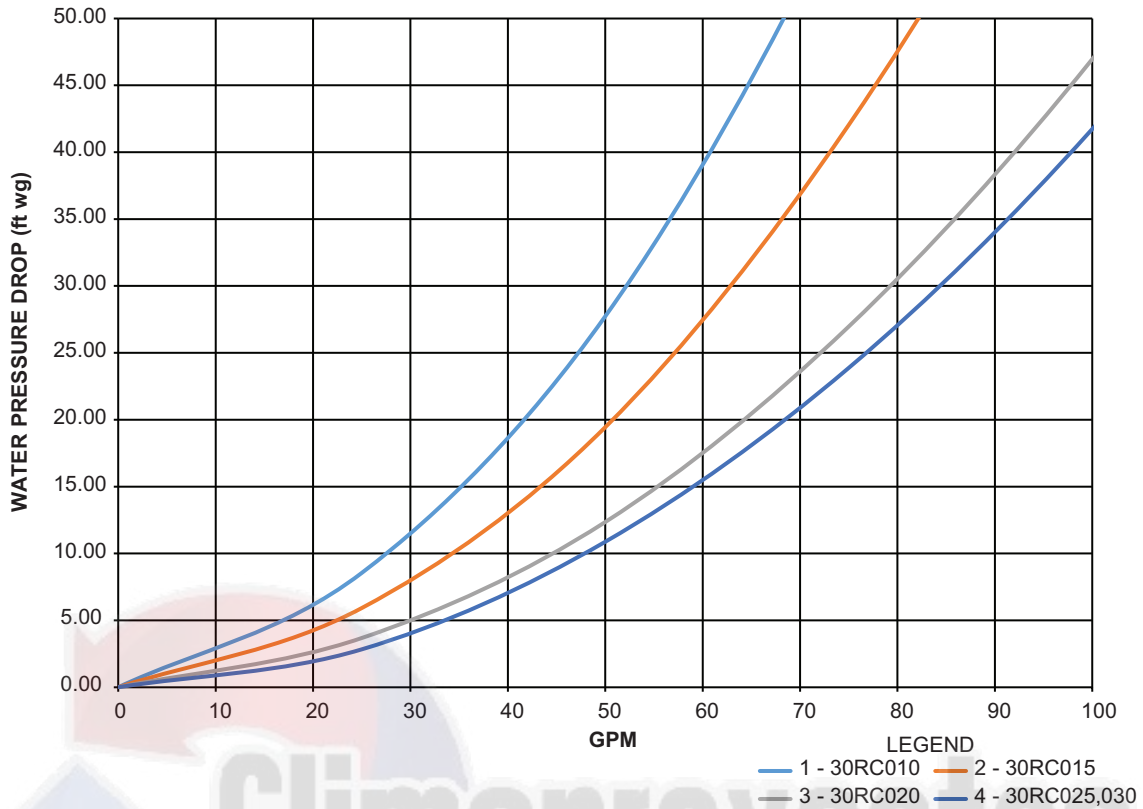

Unit Pressure Drop — No Hydronic Package — 30RC035-060 (English)

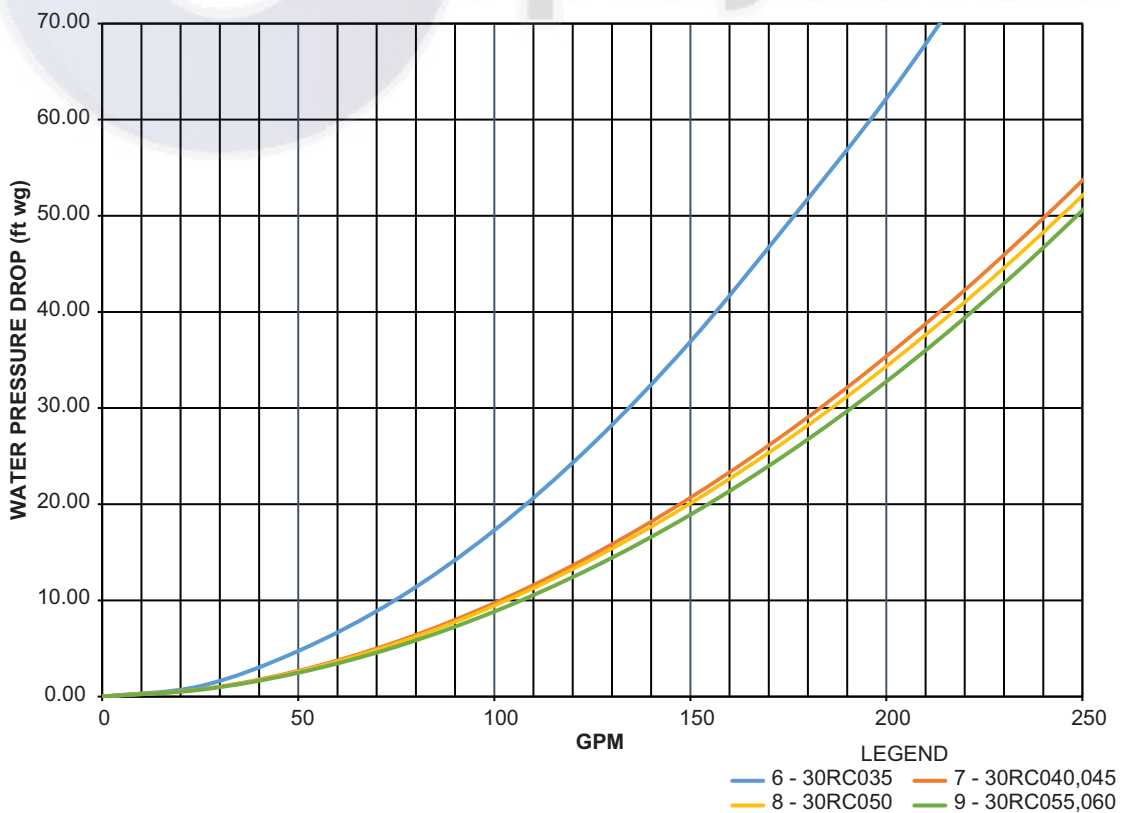

Unit Pressure Drop — No Hydronic Package — 30RC010-030 (SI)

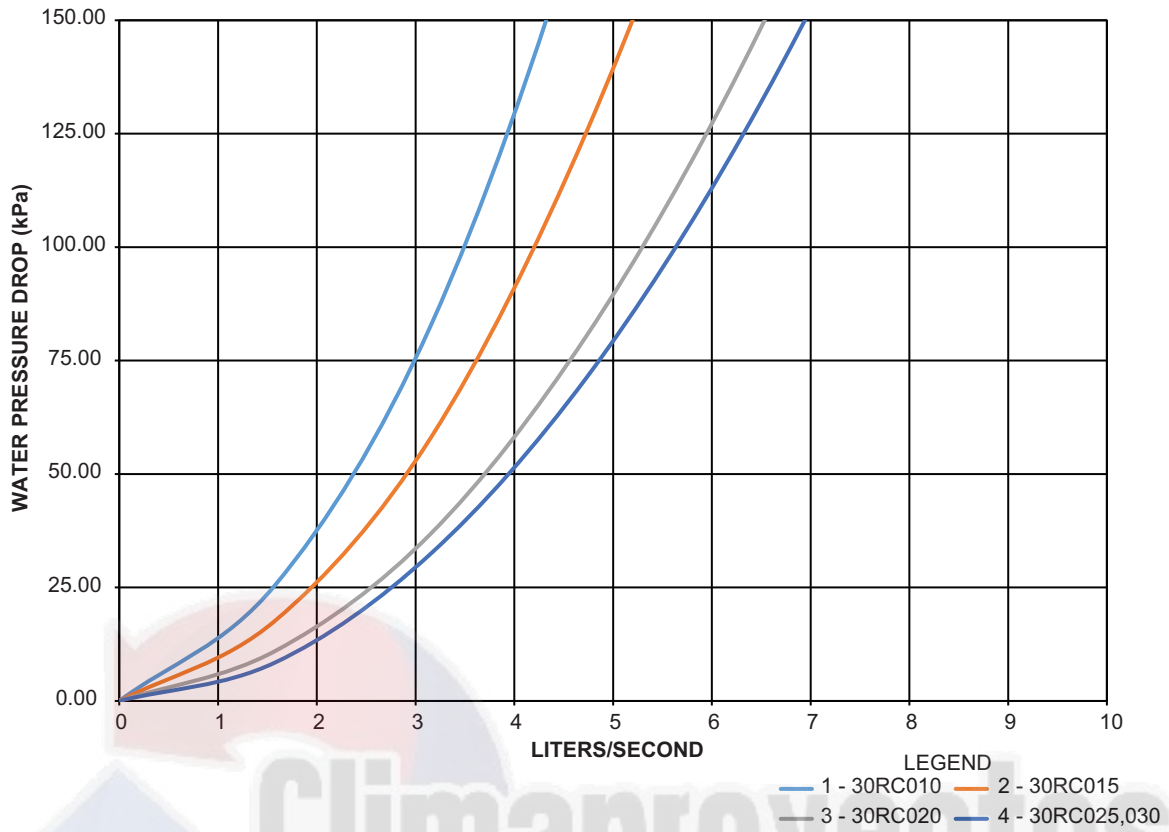

Unit Pressure Drop — No Hydronic Package — 30RC035-060 (SI)

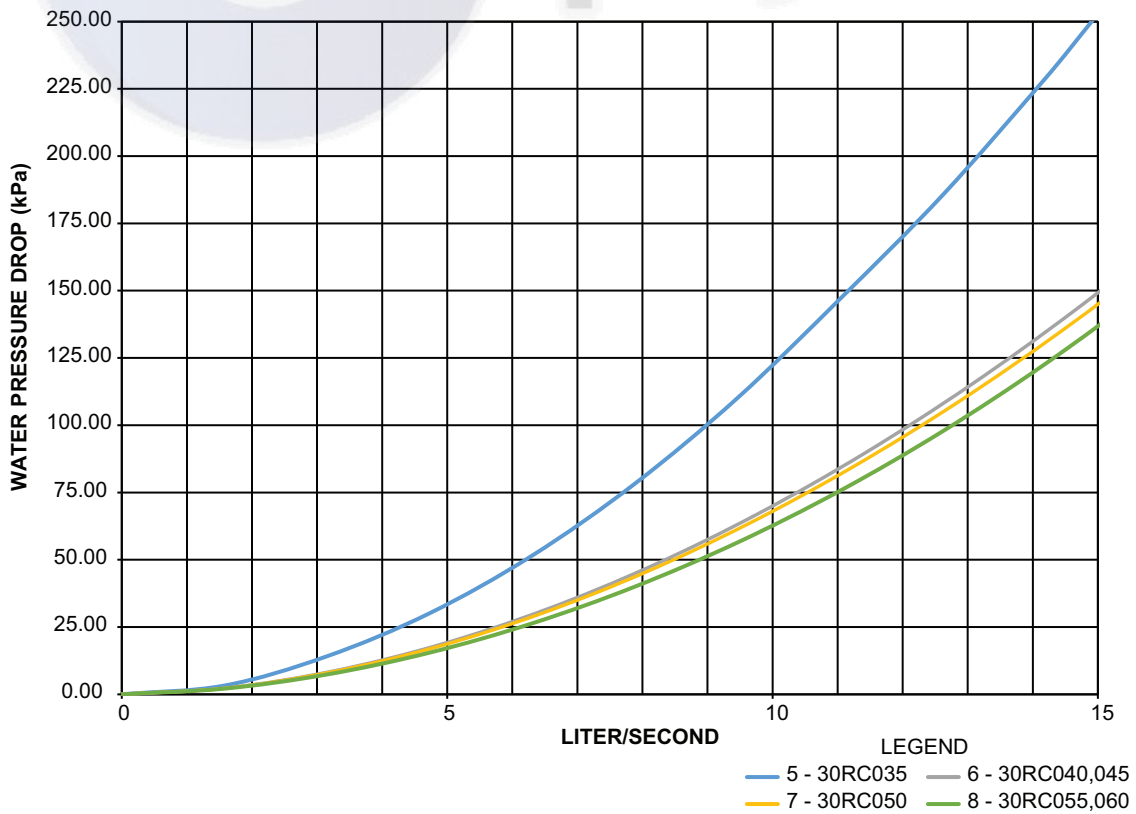

Unit Pressure Drop — Single Pump Hydronic Package — 30RC010-030 (English)

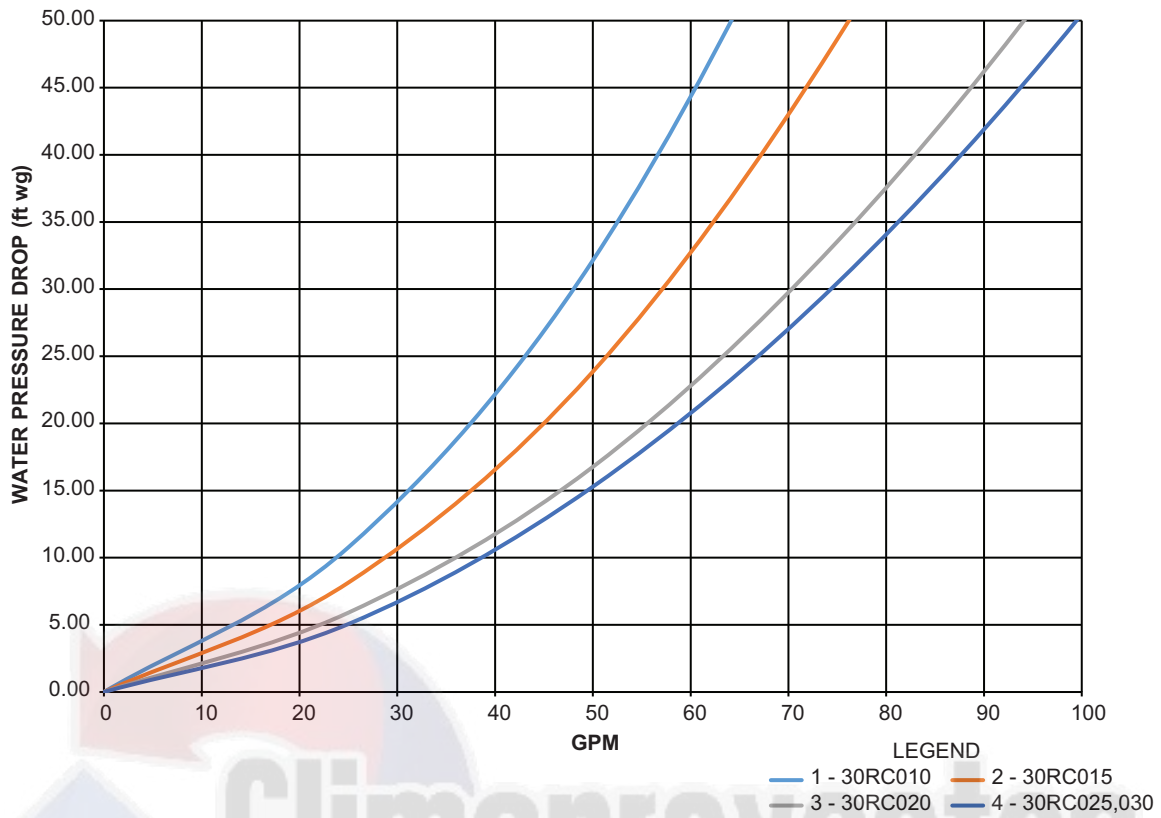

Unit Pressure Drop — Single Pump Hydronic Package — 30RC035-060 (English)

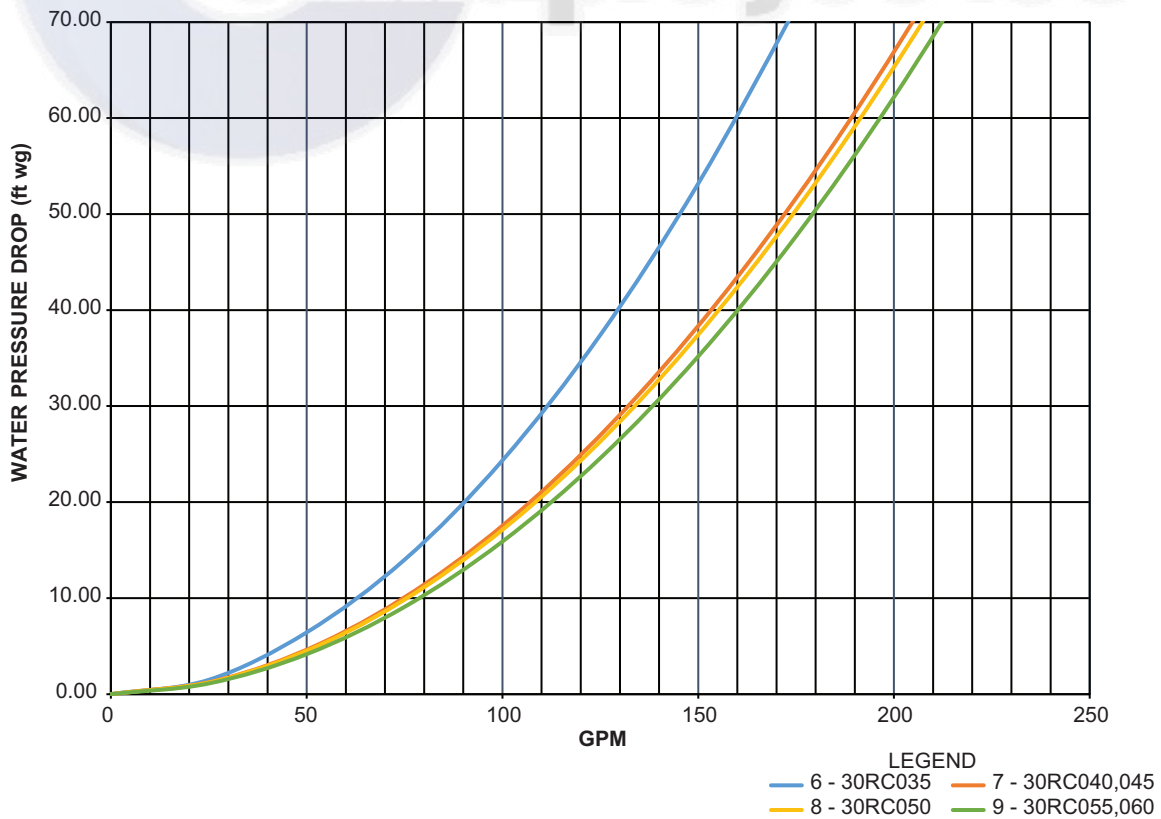

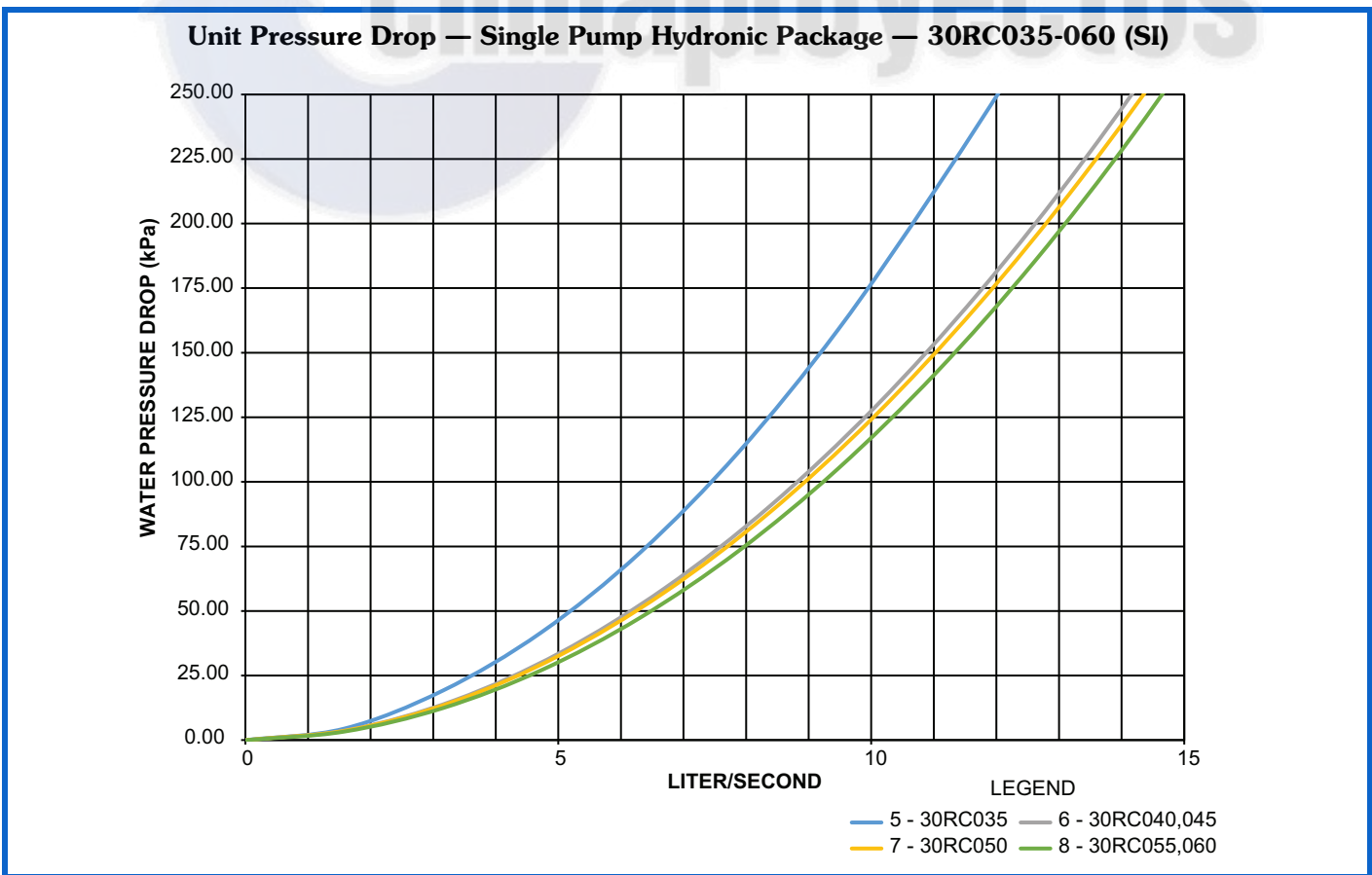
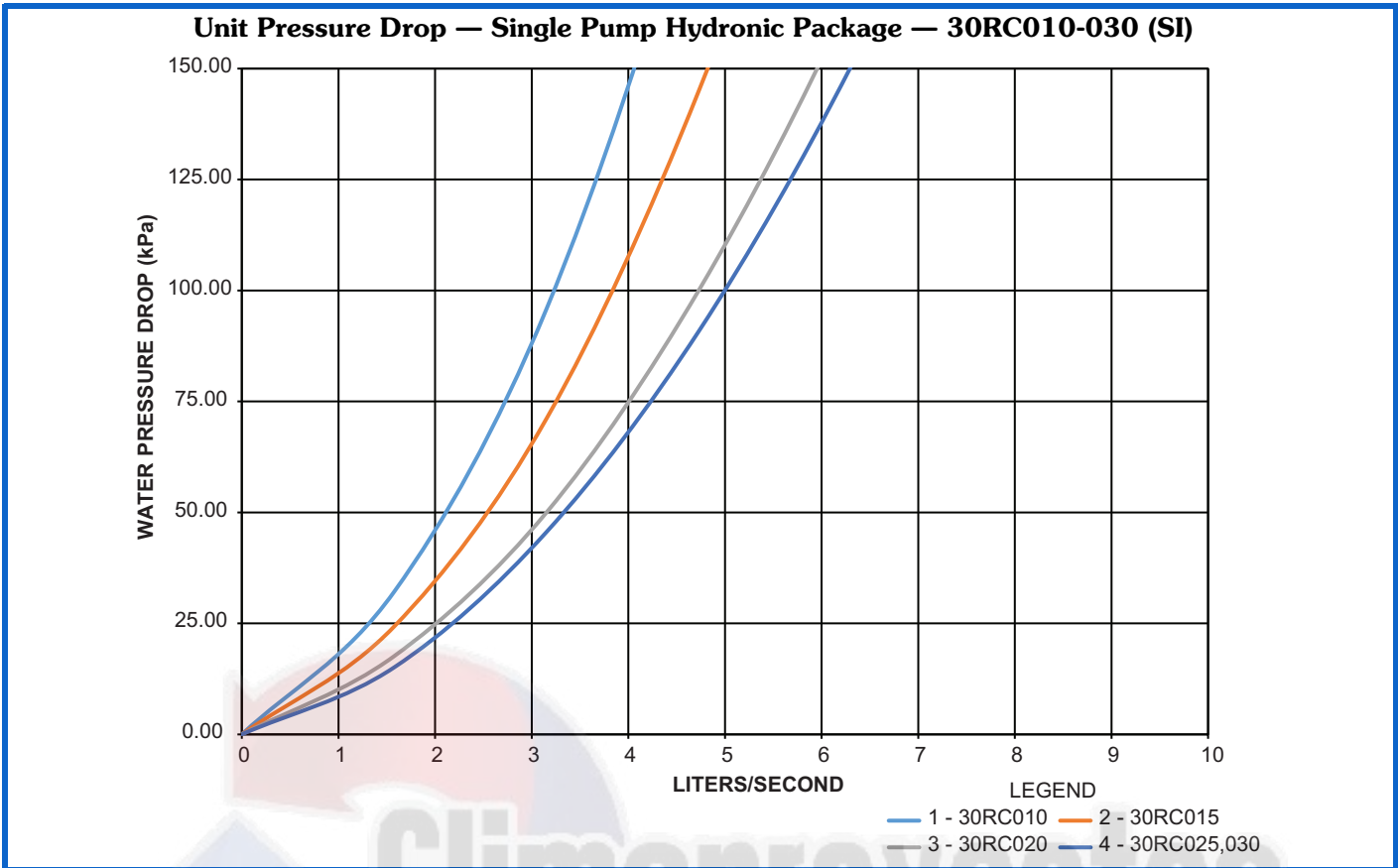

Unit Pressure Drop — Dual Pump Hydronic Package — 30RC010-030 (English)

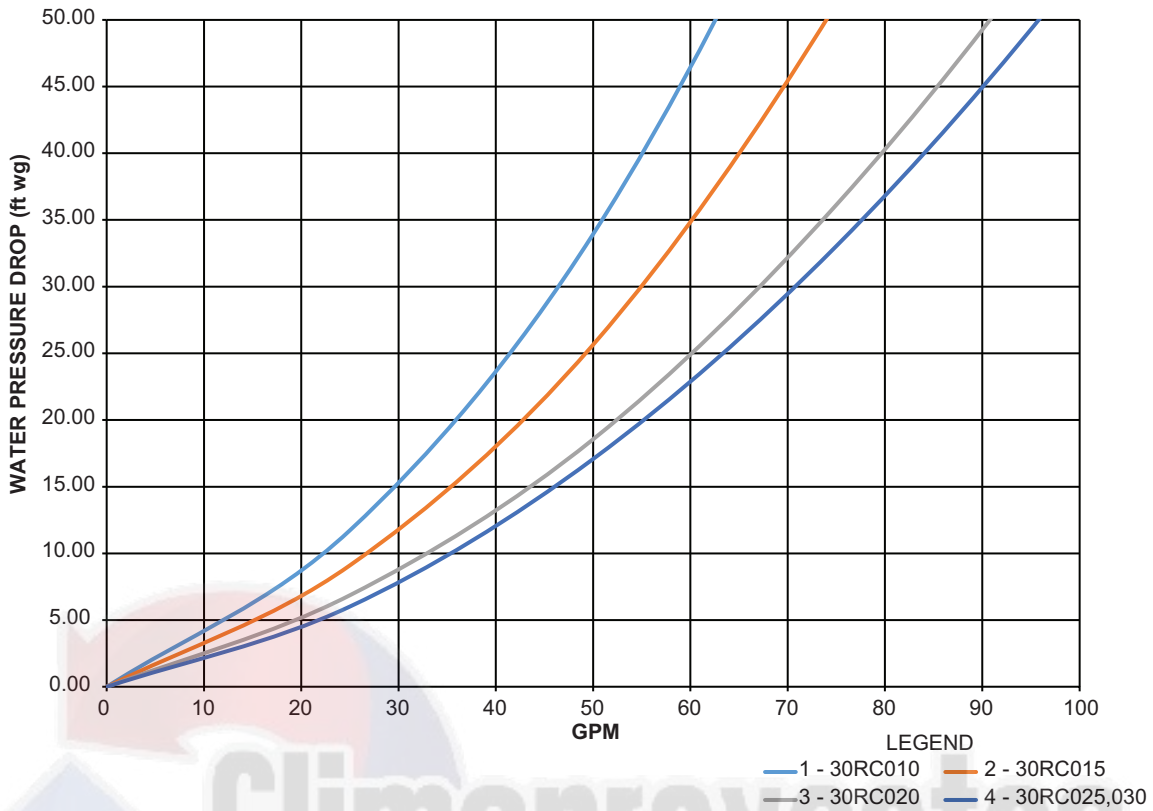

Unit Pressure Drop — Dual Pump Hydronic Package — 30RC035-060 (English)

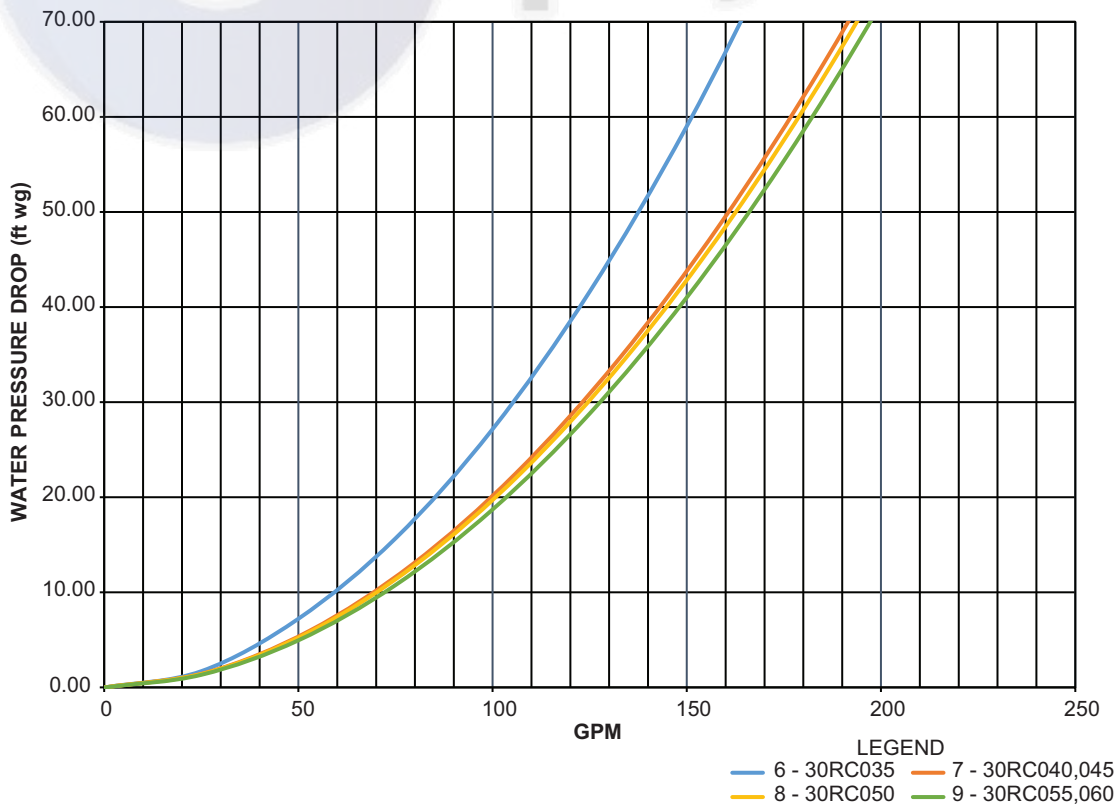

Unit Pressure Drop — Dual Pump Hydronic Package — 30RC010-030 (SI)

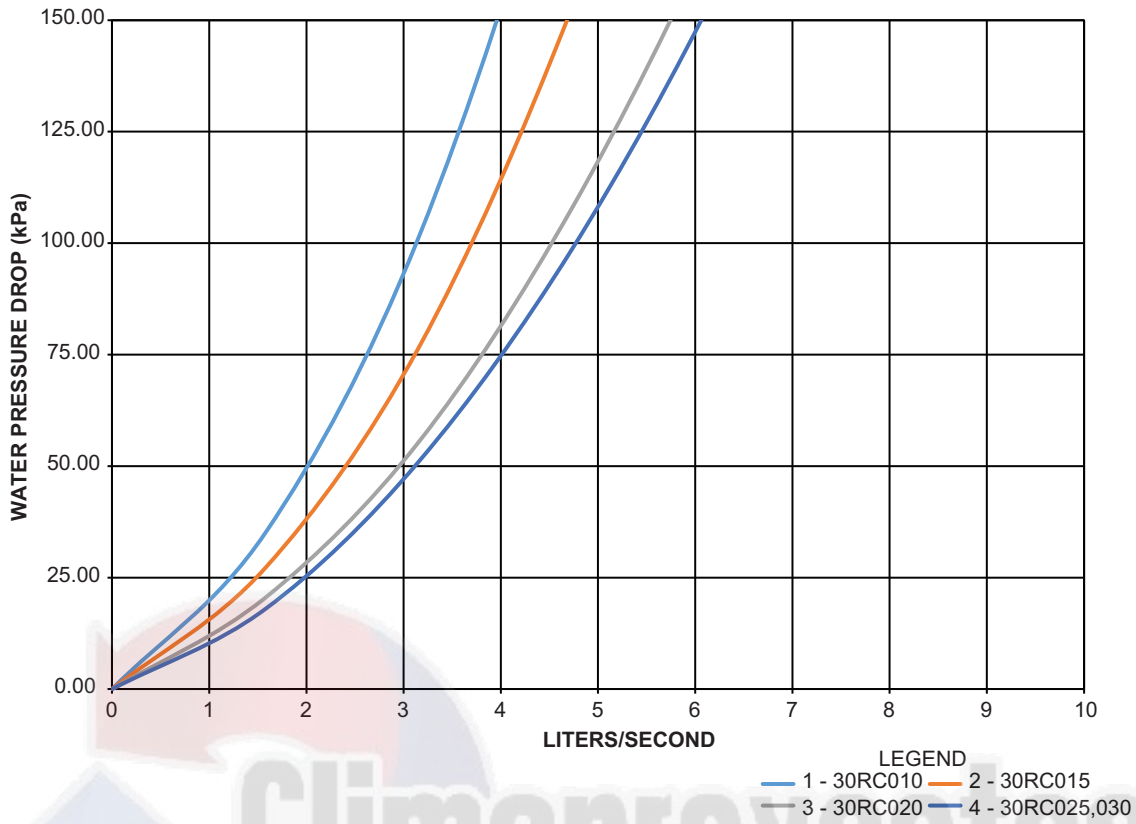

Unit Pressure Drop — Dual Pump Hydronic Package — 30RC035-060 (SI)

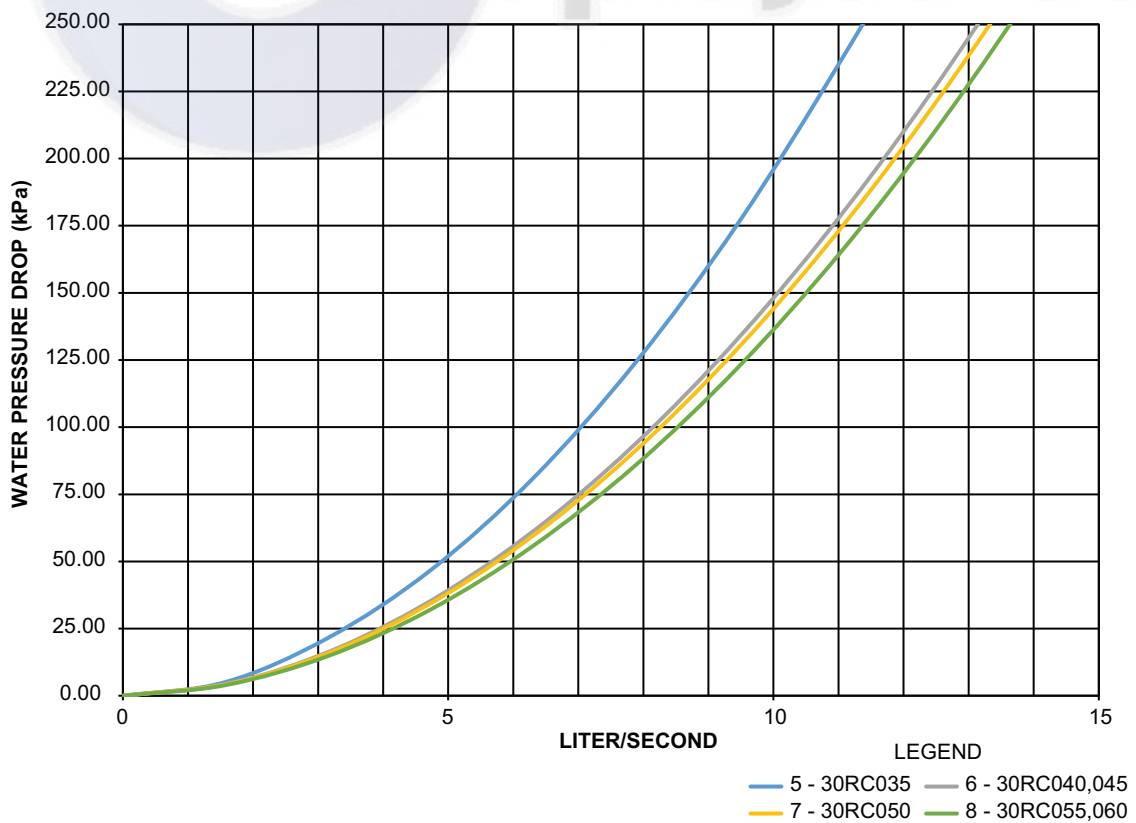

Storage Tank Pressure Drop Curves

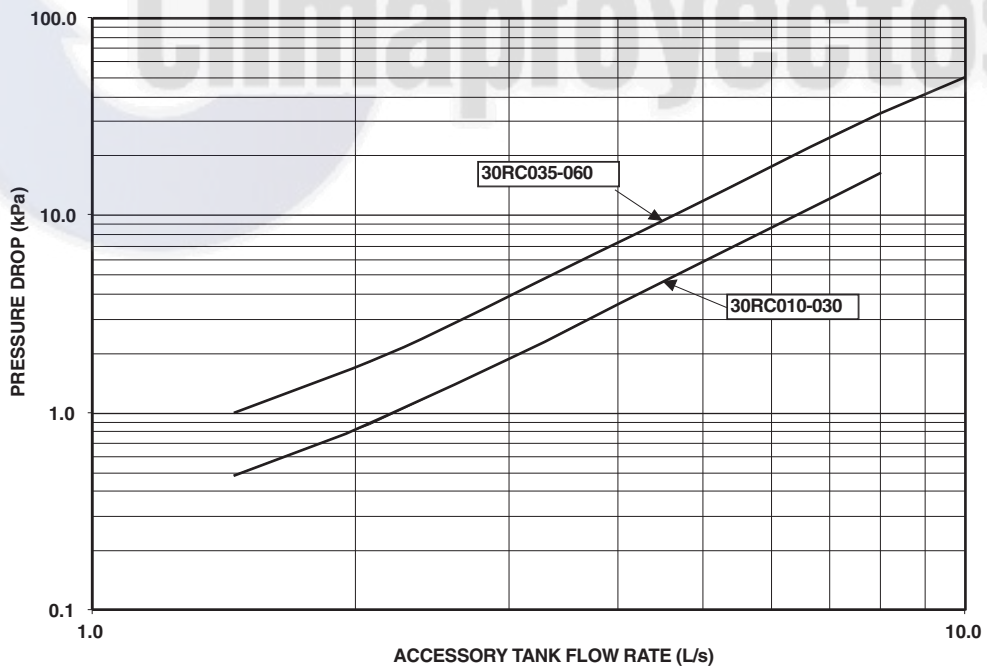
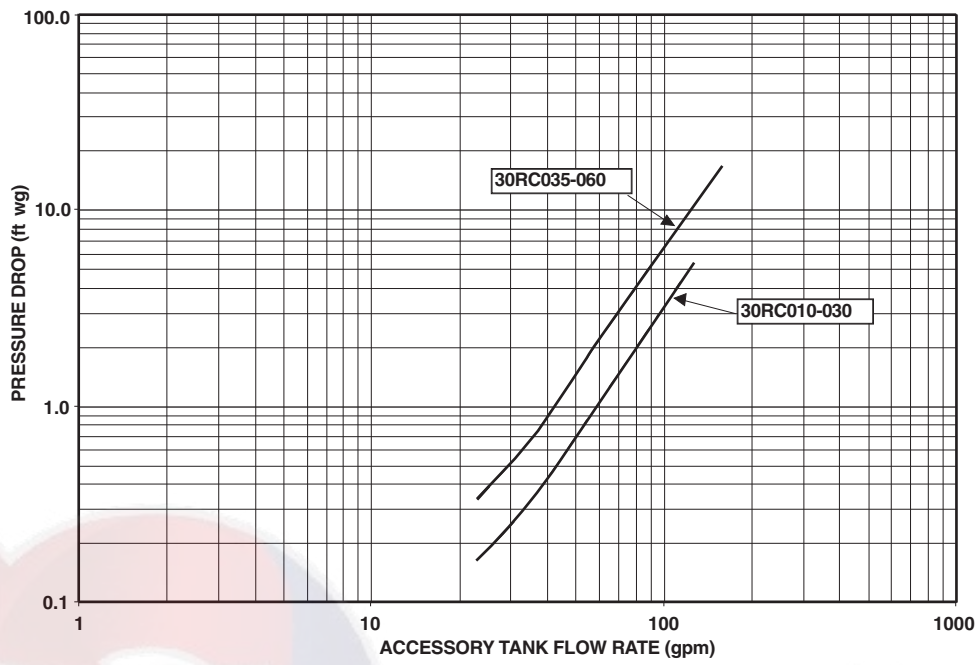

Typical Piping Diagram on 30RC Units Without Hydronic Package

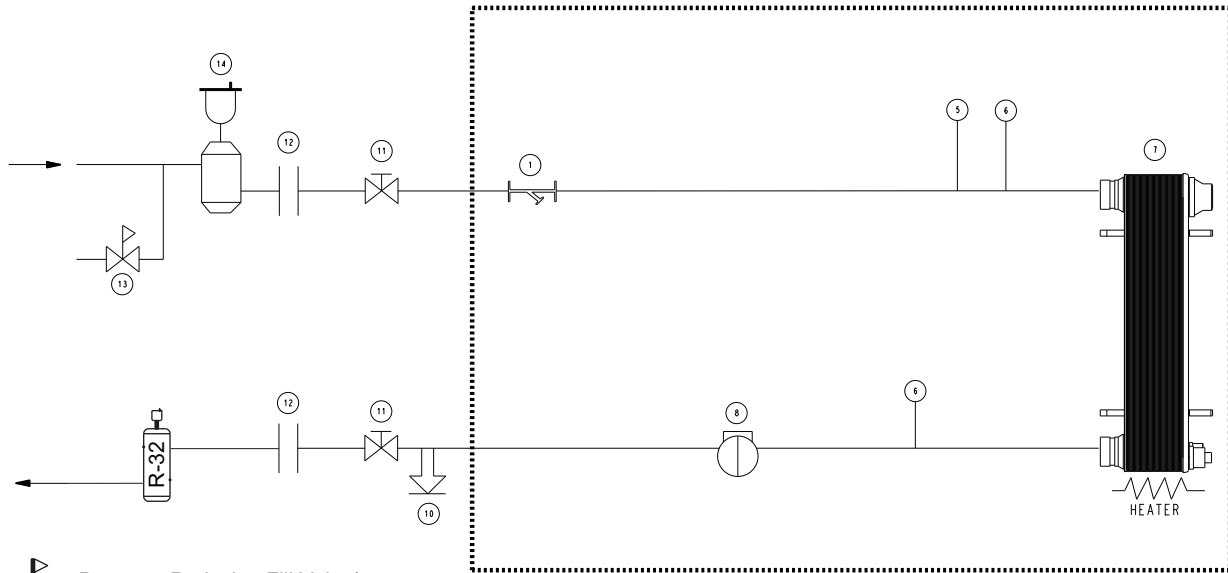

- Pressure Reducing Fill Valve*
- Isolation Valve*
- Flexible Connections*
- Strainer:
16 mesh for 5 in. pipe
20 mesh for 3 in. pipe
- Pressure Relief*
- Air Separator with Vent*
(required for R-32 units)

* Field-supplied and installed.

LEGEND

- | | |
|---|---|
| <ul style="list-style-type: none"> 1 — Strainer (20 Mesh) 4 — Electric Heater 5 — Air Vent Connection Port 6 — Pressure/Temperature Access Port 7 — Heat Exchanger | <ul style="list-style-type: none"> 8 — Flow Switch 10 — Pressure Relief 11 — Isolation Valves 12 — Flex Connections 13 — Pressure Reducing/Fill Valve 14 — Air Separator and Vent --- Factory Supplied |
|---|---|

Typical Piping Diagram on 30RC Units with Single-Pump Hydronic Package

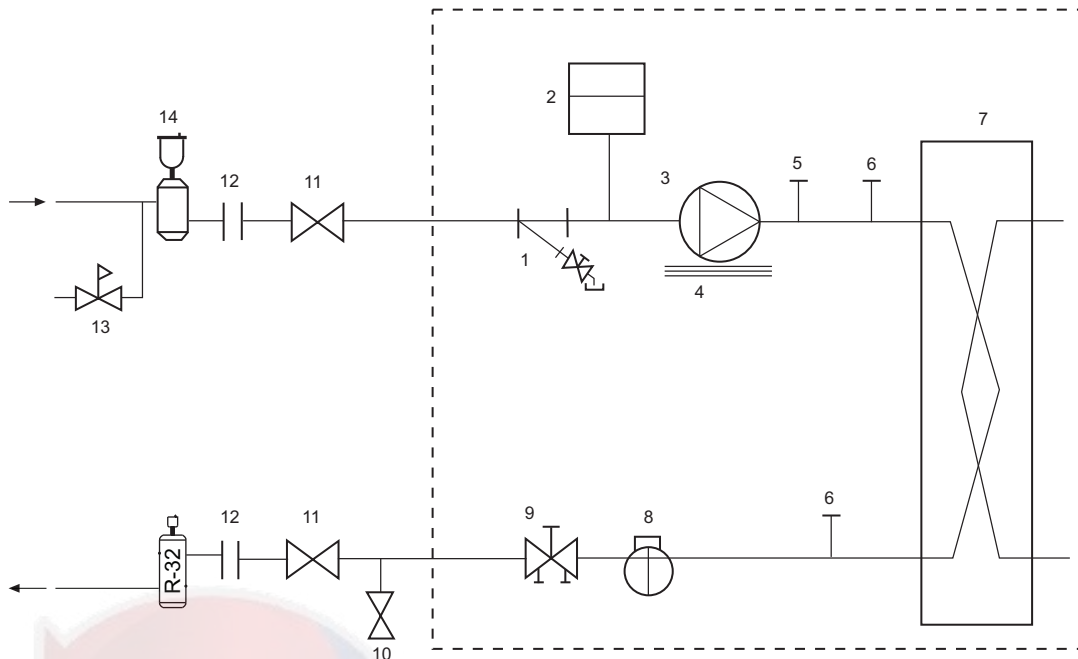

- Pressure Reducing Fill Valve*
- Isolation Valve*
- Flexible Connections*
- Air Separator with Vent*
(required for R-32 units)

* Field-supplied and installed.

LEGEND

- | | |
|--|-----------------------------------|
| 1 — Strainer (20 Mesh)/Blow-Down Valve | 8 — Flow Switch |
| 2 — Expansion Tank | 9 — Balance Valve/Drain Plug |
| 3 — Pump | 10 — Pressure Relief |
| 4 — Electric Heater | 11 — Isolation Valves |
| 5 — Air Vent Connection Port | 12 — Flex Connections |
| 6 — Pressure/Temperature Access Port | 13 — Pressure Reducing/Fill Valve |
| 7 — Heat Exchanger | 14 — Air Separator and Vent |
| | --- Factory Supplied |

Typical Piping Diagram on 30RC Units with Dual-Pump Hydronic Package

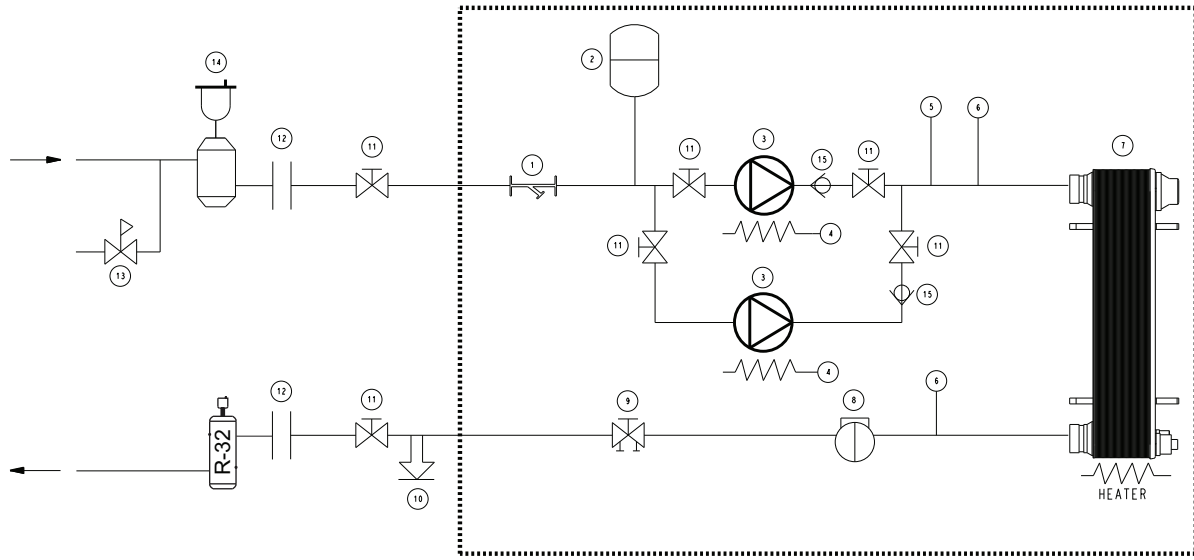

- Pressure Reducing Fill Valve*
- Isolation Valve*
- Flexible Connections*
- Air Separator with Vent*
(required for R-32 units)

* Field-supplied and installed.

LEGEND

- | | |
|---|---|
| <ul style="list-style-type: none"> 1 — Strainer (20 Mesh) 2 — Expansion Tank 3 — Pump 4 — Electric Heater 5 — Air Vent Connection Port 6 — Pressure/Temperature Access Port 7 — Heat Exchanger | <ul style="list-style-type: none"> 8 — Flow Switch 9 — Balance Valve/Drain Plug 10 — Pressure Relief 11 — Isolation Valves 12 — Flex Connections 13 — Pressure Reducing/Fill Valve 14 — Air Separator and Vent 15 — Check Valve --- Factory Supplied |
|---|---|

Field Wiring Sizes^{a,b}

CONNECTION TYPE	30RC UNIT SIZES	MCA RANGE	WIRE SIZE RANGE	MAXIMUM NUMBER OF WIRES PER PHASE	HIGH SCCR FUSE TYPE
TERMINAL BLOCK	010-060	MCA up to 175	14 AWG to 2/0 AWG	1	J, T, RK1, RK5, G, CC
		MCA 175.1 to 420	2 AWG to 600 kcmil	1	J, T, RK1, RK5, G, CC
NON-FUSED DISCONNECT	ALL	MCA up to 125	14 AWG to 3/0 AWG	1	—
		MCA 125.1 to 225	4 AWG to 4/0	1	—
		MCA 225.1 to 400	2/0 AWG to 500 kcmil	1	—
			2/0 AWG to 250 kcmil	2	—

NOTE(S):

a. Wiring for main field supply must be rated 75°C. Use copper conductors only.

b. Units with high SCCR option and terminal block must use approved fuses to meet high SCCR rating.

LEGEND

AWG — American Wire Gauge
MCA — Minimum Circuit Amps
SCCR — Short Circuit Current Rating

Accessory Tank Electrical Data for 30RC010-060^a

UNIT VOLTAGE (V-Hz)	ACCESSORY PART NO. 30RA-900---	FLA
208/230-60	050	11.3
	051	11.3
	052	22.6
460-60	050	5.7
	051	5.7
	052	11.3
575-60	050	7.1
	051	7.1
	052	14.1
360-60	050	4.7
	051	4.7
	052	9.3

NOTE(S):

a. The storage tank obtains its power from the chiller. No separate power source is required.

LEGEND

FLA — Full Load Amps

Microprocessor

The Carrier Controller microprocessor controls overall unit operation and controls a number of processes simultaneously. These processes include internal timers, reading inputs, analog to digital conversions, fan control, display control, diagnostic control, output relay control, demand limit, capacity control, head pressure control, and temperature reset. Some processes are updated almost continuously, others every 2 to 3 seconds, and some every 30 seconds. The microprocessor routine is started by switching the Emergency ON-OFF switch to the ON position. Pump control of external pumps (where configured) will energize the evaporator pump to the internal (or CCN) time schedule (or input occupied signal from external system).

Where dual pumps are utilized, only one pump will be operated at a time. The control will start the pump with the least hours. When the unit receives a call for cooling (based on a deviation from chilled water set point), the unit stages up in capacity to maintain the evaporator fluid set point. The first compressor starts 1 to 3 minutes after the call for cooling. The Carrier Controller microprocessor controls the capacity of the chiller by cycling compressors at a rate to satisfy actual dynamic load conditions. The control maintains the leaving-fluid temperature set point shown on the Carrier Controller display through intelligent cycling. Accuracy depends on loop volume, loop flow rate, load, outdoor-air temperature, number of stages, and particular stage being cycled off. No adjustment for cooling range or evaporator flow rate is required, because the control automatically compensates for cooling range by measuring both the return-fluid temperature and leaving-fluid temperature. This is referred to as leaving-fluid temperature control with return-fluid temperature compensation.

The basic logic for determining when to add or remove a stage is a time band integration of deviation from set point plus rate of change of leaving-fluid temperature. When the leaving-fluid temperature is close to the set point and slowly moving closer, logic prevents the addition of another stage.

If 1°F per minute (0.6°C per minute) pulldown control has been selected (adjustable setting), no additional steps of capacity are added as long as the difference between the leaving-fluid temperature and set point is greater than 4°F (2.2°C) and the rate of change in leaving-fluid temperature is greater than the selected pulldown control rate. If it has been less than 90 seconds since the last capacity change, then compressors will continue to run unless a safety device trips. This prevents rapid cycling and also helps return oil during short on periods.

Control Sequence

Off cycle

If the ambient temperature is below the trip point (default value of 37.4°F [3°C] for fresh water), then the evaporator heaters (if installed) are also energized.

Start-up

After the control circuit switches on, the prestart process takes place, and then the microprocessor checks itself, starts the pump (if configured), and waits for the temperature to stabilize. The controlled pulldown feature limits compressor loading on start-up to reduce demand on start-up and unnecessary compressor usage. The

microprocessor limits supply-fluid temperature decrease (start-up only) to 1°F (0.6°C) per minute.

Capacity control

On the first call for cooling, the microprocessor starts initial compressor and fan stage on primary circuit. As additional cooling is required, additional compressors are energized.

The speed at which capacity is added or reduced is controlled by temperature deviation from set point and rate of temperature change of chilled fluid.

The controls respond to the supply chilled water temperature to cycle the compressors to match cooling load requirements.

The hot gas bypass valve (if equipped and only available on circuit A) is energized by AUX board. The valve allows hot gas to pass directly into the evaporator circuit on the final step of unloading, permitting the unit to operate at lower loads with less compressor cycling.

On units equipped with the digital compressor option (available on sizes 010-060), the control will integrate the modulation of the digital compressor into the capacity routine to match cooling load requirements. The digital compressor option will modulate in 21 steps for sizes 010 and 015, 22 steps for sizes 030-030, 44 steps for sizes 035-060.

The digital scroll option provides better capacity control by incrementally modulating capacity effectively, increasing the number of compression stages compared to chillers that are not equipped with this option. The digital scroll compressor is not a variable speed device, it modulates the capacity output by allowing the scroll sets to separate during operation, alternating between full capacity and zero capacity. Utilizing a fixed timeframe ratio, the percentage of time that the scroll set is engaged is the percentage capacity of that compressor.

There are 2 major advantages of this type of capacity control. First, there is closer capacity control operation with all the available capacity steps compared to the on/off cycling control of conventional scrolls. Second, there is much less wear factor on digital scrolls compared to standard scroll compressors because the digital scrolls are not subject to as many of the shutdown/restart cycles as conventional scrolls. Digital scrolls, rather than shutting off, tend to remain on as they vary to deliver the correct capacity step.

Sensors

Thermistors are used to control temperature-sensing inputs to the microprocessor. No additional thermistor sensors are required for optional leaving chilled water temperature, return water, or outdoor air reset.

The following temperature sensors are provided on 30RC units:

- Evaporator leaving chilled fluid temperature (LWT)
- Evaporator entering fluid (return) temperature (EWT)
- Outside air temperature (OAT)
- Discharge Gas Temperature (DGT)
- Suction Gas Temperature (SGT)
- Space temperature (optional with EMM board)

Two refrigerant pressure transducers are used in each circuit for sensing suction and discharge pressure. The microprocessor uses these inputs to control capacity and fan cycling.

The pressure transducers above are also used to calculate the following values:

- Saturated condensing temperature
- Evaporator saturation temperature

Additional Information

Detailed information on controls and operation is available in the Controls, Start-Up, Operation, Service, and Troubleshooting guide included with each unit. Packaged Service Training programs are also available. Contact your local Carrier representative for more information.

High-Efficiency Variable Condenser Fans (30RC Chillers with Greenspeed® Intelligence Only)

All fans on a circuit run at the same speed and are controlled by a VFD with special CCN software to maintain SCT (saturated condensing temperature) set point. The set point is calculated from operating conditions and adjusted to the most efficient operating point. The high-efficiency variable condenser fan option uses Danfoss VLT 102 variable frequency drives. Drives are connected to the LEN communication bus. Fan speed is determined by the chiller controller and communicated to the drive to provide excellent part load efficiency and reduced sound level operation over the life of the chiller.

Dual Chiller Control

The Carrier Controller allows 2 chillers (piped in parallel or in series) to operate as a single chilled water plant, with standard control functions coordinated through the primary chiller controller. This standard control feature requires a communication link between the 2 chillers, and in the case of parallel chillers, requires an additional thermistor and well for each chiller.

Carrier Controller Microprocessor

The dynamic Carrier Controller microprocessor keeps the chiller online during periods of extreme operating conditions. If the saturated suction temperature is 68°F (10°C) or higher, then the maximum operating pressure (MOP) feature limits the suction to keep the chiller online, which may limit the chiller to reach 100% capacity at high ambient conditions. The controller will equalize run time on each circuit through the primary/secondary feature if hot gas bypass is not equipped. If hot gas bypass is equipped, run equalization is disabled since minimum load control is only available on circuit A. If a circuit becomes disabled, the controller will automatically set the active circuit to primary, keeping the chiller online at a reduced capacity.

Capacity Control Steps

UNIT SIZE	010	015	020	025
Capacity Steps	40	40	50	50
	60	60	100	100
	100	100	—	—

Capacity Control Steps (cont)

UNIT SIZE	030	035	040	045	050	055	060
Capacity Steps	50	26	26	22	25	23	25
	100	50	50	50	50	50	50
		76	76	73	75	73	75
		100	100	100	100	100	100

Low temperature override

This feature prevents LCWT (leaving chilled water [fluid] temperature) from overshooting the set point and possibly causing a nuisance trip-out by the freeze protection.

High temperature override

This feature allows the chiller to add capacity quickly during rapid load variations.

Temperature Reset

Reset reduces compressor power usage at part load when design LCWT is not necessary. Humidity control should be considered since higher coil temperatures resulting from reset will reduce latent heat capacity. Four reset options are offered, based on the following:

- Return fluid temperature increases LCWT set point as return (or entering) fluid temperature decreases (indicating load decrease). Option may be used in any application where return fluid provides accurate load indication. A limitation of return fluid reset is that LCWT may only be reset to value of design return fluid temperature.
- Outdoor air temperature increases the LCWT as outdoor ambient temperature decreases (indicating load decrease). This reset should be applied only where outdoor ambient temperature is an accurate indication of load.
- Space temperature increases the LCWT as space temperature decreases (indicating load decrease). This reset should be applied only where space temperature is an accurate indication of load. An accessory space temperature thermistor is required. The unit must be equipped with the energy management module and the space thermistor accessory.
- The control system is also capable of temperature reset based on an externally powered 4 to 20 mA signal. Temperature reset by this method requires a Building Management System (BMS) to determine the amount of reset required and signal the unit.

The energy management module is required for 4 to 20 mA signal temperature reset for outdoor air temperature or space temperature. Return fluid temperature does not require this module.

For details on applying a reset option, refer to the Controls, Start-Up, Operation, Service, and Troubleshooting literature shipped with the unit. Obtain ordering part numbers for reset option from the Packaged Chiller Builder program or contact your local Carrier representative.

Safety

Abnormal conditions

All control safeties in the chiller operate through the compressor protection board or control relay and microprocessor. Loss of feedback signal to the CIOB boards will cause the compressor(s) to shut down. For other safeties, the microprocessor makes an appropriate decision to shut down a compressor due to a safety trip or bad sensor reading and shows the appropriate failure code on the display.

Low-pressure safety

Safety cuts out if system pressure drops below minimum.

High-pressure cutout

Switch shuts down compressors if compressor discharge pressure increases to 650 psig (4481 kPa).

Compressor anti-cycling

This feature limits compressor cycling.

Loss of flow protection

Proof of flow switches are standard and installed on all 30RC chillers.

Sensor failures

Failures are detected by the microprocessor.

Accessory controls

Demand can be limited by controlling the chiller capacity through the demand limit control (the energy management module is required for this function). This FIOP/accessory interfaces with the microprocessor to control the unit so that the chiller's kW demand does not exceed its setting. It is activated from an external switch or a 4 to 20 mA signal.

The standard Carrier Controller microprocessor is programmed to accept various accessory temperature reset options (based on outdoor air temperature [standard], return-fluid temperature [standard], or a 4-20 mA signal from an external Building Management System), that resets the LCWT. The energy management module (EMM) is only required for the temperature reset that is initiated by space temperature.

Demand Limit

If the demand limit is applied, it limits the total power draw of unit to a selected point by controlling the number of operational compressors during periods of peak electrical demand.

The energy management module is required for either 3-step or 4 to 20 mA demand limit.

Electronic Expansion Valve (EXV)

The EXV controls refrigerant flow to the evaporator for different operating conditions by varying an orifice size to increase or decrease the flow area through the valve based on microprocessor input. The orifice is positioned by a stepper motor through approximately 600 discrete steps and is monitored every 10 seconds. The EXV maintains an approximate 9°F (5°C) refrigerant superheat entering the compressor.

Diagnostics

The microprocessor may be put through a service test (see Controls, Start-Up, Operation, Service, and Troubleshooting literature). Service test confirms microprocessor is functional, informs observer through displaying the condition of each sensor and switch in the chiller, and allows observer to check for proper operation of fans and compressors.

Default Settings

To facilitate quick start-ups, 30RC chillers employing the Carrier Controller microprocessor are pre-configured with a default setting that assumes stand-alone operation supplying 44°F (6.6°C) chilled water.

Configuration settings will be based on any options or accessories included with the unit at the time of manufacturing.

Date and time are set to U.S.A. Eastern Time zone and will need reconfiguring based on location and local time zone. If operation based on occupancy scheduling is desired, schedule must be set during installation.

Typical control wiring schematic



- NOTES:
- FACTORY WIRING IS IN ACCORDANCE WITH UL 60335-40-2 STANDARDS. FIELD MODIFICATIONS MUST BE IN COMPLIANCE WITH ALL APPLICABLE CODES.
 - ALL UNITS OR MODULES HAVE SINGLE POINT PRIMARY POWER CONNECTION. MAIN POWER MUST BE SUPPLIED FROM A FIELD OR FACTORY SUPPLIED DISCONNECT.
 - WIRING FOR MAIN FIELD SUPPLY MUST BE RATED 75C. USE COPPER CONDUCTORS ONLY.

CONNECTION TYPE	MCA RANGE	WIRE SIZE RANGE	MAXIMUM NUMBER OF WIRES PER PHASE	HIGH SHORT FUSE TYPE
TERMINAL BLOCK	MCA UP TO 115	14 AWG TO 2/0 AWG	1	J, T, RB1, RS5, G, CC
	MCA 115.1 TO 420	2 AWG TO 600kcmil	1	J, T, RB1, RS5, G, CC
NON-FUSED DISCONNECT	MCA UP TO 125	14 AWG - 3/0 AWG	1	-
	MCA 125.1 TO 225	4 AWG TO 4/0	1	-
NON-FUSED DISCONNECT	MCA 225.1 TO 400	2/0 AWG TO 500kcmil	1	-
	MCA 400 TO 500kcmil	2/0 AWG TO 250kcmil	2	-

- REFER TO CERTIFIED DIMENSIONAL DRAWINGS FOR EXACT LOCATIONS OF THE MAIN FIELD POWER SUPPLY.
- TERMINALS TB5-14 ARE FOR CONTROL OF CHILLED WATER PUMP1 (CMP1) STARTER. TB5-27 AND TB1 ARE FOR CONTROL OF CHILLED WATER PUMP2 (CMP2) STARTER. THE MAXIMUM LOAD ALLOWED FOR THE CHILLED WATER PUMP RELAY IS 5 VA SEALED, 10 VA INRUSH AT 24 V. FIELD POWER SUPPLY IS NOT REQUIRED.
- TERMINALS TB5-13 AND TB5-14 ARE FOR RUNNING AND ALARM RELAYS. THE MAXIMUM LOAD ALLOWED FOR THE ALARM RELAY IS 5 VA SEALED, 10 VA INRUSH AT 24V. FIELD POWER SUPPLY IS NOT REQUIRED.
- THE CONNECTION FOR DEMAND LIMIT AND ICE DONE OPTIONS MUST BE RATED FOR DRY CIRCUIT APPLICATION REQUIRED. FACTORY INSTALLED JUMPER BETWEEN TERMINALS TB5-10 AND 20 WHEN FIELD CWPI IS INSTALLED.
- TERMINALS 8 OF TB5 ARE FOR FIELD TERMINAL CONNECTIONS FOR REMOTE DRIFT OFF.
- THE CONTACTS MUST BE RATED FOR DRY CIRCUIT APPLICATION CAPABLE OF HANDLING A 24VAC LOAD UP 50MA.

EMM OPTION

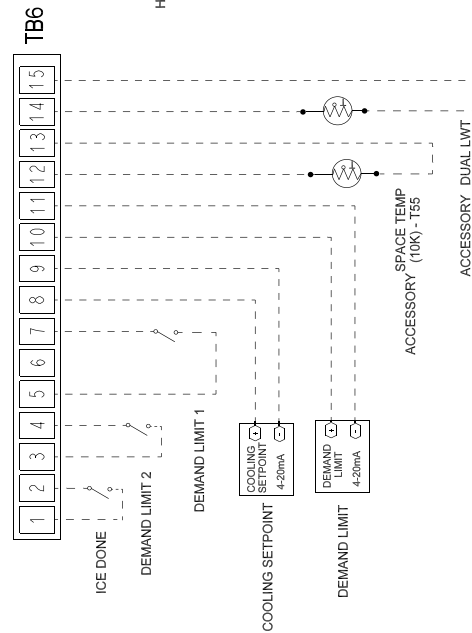

COM WIRING

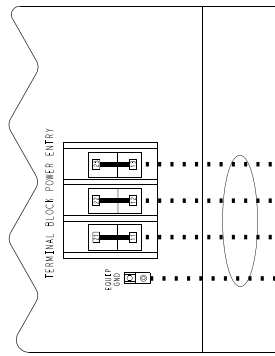
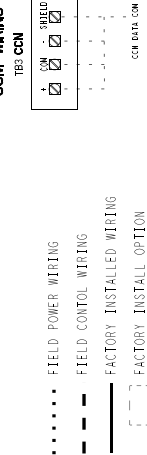

TERMINAL BLOCK

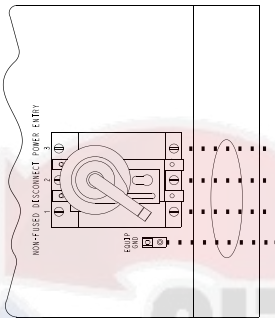

NON-FUSED DISCONNECT

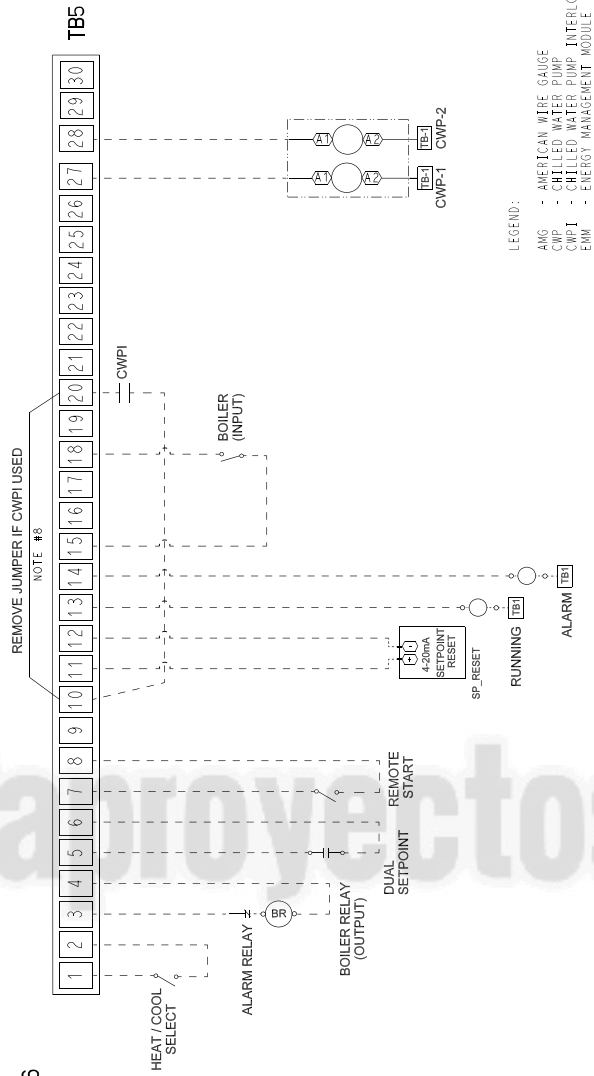

- LEGEND:
- ANG - AMERICAN WIRE GAUGE
 - CWP - CHILLED WATER PUMP
 - CWP1 - CHILLED WATER PUMP INTERLOCK
 - EMM - ENERGY MANAGEMENT MODULE

TYPICAL MAIN POWER & CONTROL CONNECTIONS

ITC CLASSIFICATION	SHEET	DATE	SUPERCEDES	REV
U.S. ECCN-EAR99	1 OF 1	10/19/23	30RC 010-060T ELECTRICAL	30RC60001070

Chiller Location and Clearances

The 30RC unit must be installed outdoors.

Do not locate near sound-sensitive areas without proper acoustic consideration. For applications requiring mounting a chiller on a building rooftop, consideration should be given to using rubber-in-shear or spring isolators to minimize structure-borne transmission. Unit must be level when installed to ensure proper oil return to the compressors. Clearances must be provided around chillers for airflow, service and local code requirements. See dimensional drawings for specific unit clearance requirements. Ensure adequate clearance between adjacent chillers is maintained.

When parallel chillers are aligned such that coils face each other, a minimum of 6 ft (1829 mm) is recommended. When the parallel arrangement has only one coil drawing air from the space between chillers, a minimum of 3.5 ft (1067 mm) is recommended. When parallel chillers have no coils facing each other (a back-to-back arrangement), be sure to maintain the larger of the recommended service clearances associated with each chiller (see the certified drawings). Due to NEC (National Electric Code, U.S.A.) regulations, a minimum clearance of 4 ft (1219 mm) must be maintained on the side of the chiller that has an electrical box. Chiller fan discharge is strongly recommended to be at least as high as adjacent solid walls. Installation in pits is not recommended.

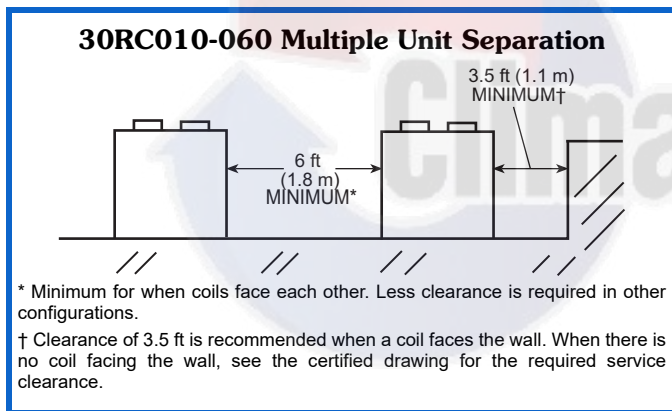

Oversizing Chillers

Oversizing chillers by more than 15% at design conditions must be avoided as the system operating efficiency is adversely affected (resulting in greater or excessive electrical demand). When future expansion of equipment is anticipated, install a single chiller to meet present load requirements and add a second chiller to meet the additional load demand. It is also recommended that 2 smaller

chillers be installed where operation at minimum load is critical. The operation of a smaller chiller loaded to a greater percentage over minimum is preferred to operating a single chiller at or near its minimum recommended value. Hot gas bypass should not be used as a means to allow oversizing chillers. Hot gas bypass should be given consideration where substantial operating time is anticipated below the minimum unloading step.

Multiple Chillers

Where chiller capacities greater than can be supplied by a single 30RC chiller are required, or where standby capability is desired, chillers may be installed in parallel or in series. Units may be of the same or different sizes with this piping arrangement. However, in parallel chiller applications, evaporator flow rates must be balanced to ensure proper flow to each chiller.

Unit software is capable of controlling 2 units as a single plant by making use of the dual chiller control feature. Refer to the Controls, Start-up, Operation, Service, and Troubleshooting guide for further details, as well as more piping/control detail than discussed here.

If the dual chiller algorithm is used and the machines are installed in parallel, then an additional chilled water sensor must be installed for each module. Install one thermistor and well per chiller in the common leaving water header.

Parallel chiller control with dedicated pumps is recommended. The chiller must start and stop its own water pump, located in its own piping. Check valves are required at the discharge of each pump (when the factory hydronic package option is chosen, and **dual pumps** are selected, the check valves are automatically supplied). If pumps are not dedicated for each chiller then isolation valves are required. Each chiller must open and close its own isolation valve through the unit control (the valve must be connected to the pump outputs). Refer to the chiller piping configuration shown on the next page.

Hydronic pump packages may not be applied in series applications.

Series Chillers

Where a large temperature drop (greater than 20°F [11.1°C]) is desired, where chiller capacities greater than can be supplied by a single 30RC chiller are required, or where standby capability is required, chillers may be installed in series. The leaving fluid temperature sensors need not be relocated. However, the evaporator minimum entering fluid temperature limitations should be considered for the chillers located downstream of other chillers. Refer to the chiller piping configuration shown on the next page.

Typical Parallel Dual Chiller Operation

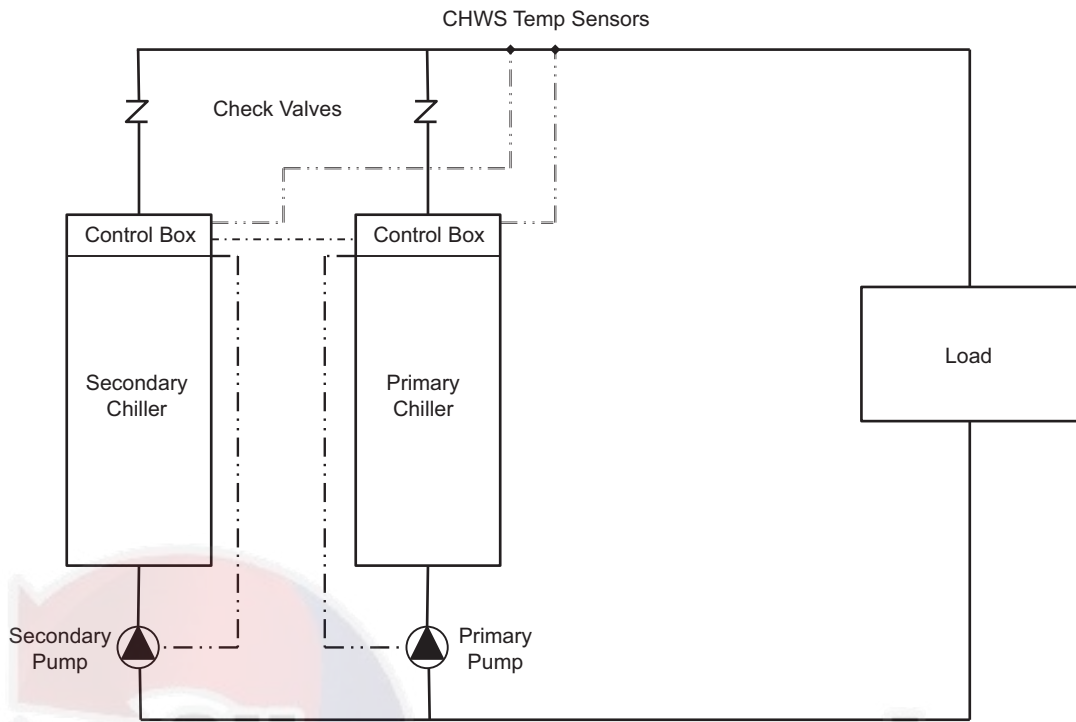

- - - - - Field Wiring
 ······ Field Communication Wiring

NOTE: This is a simplified piping diagram. Not all hydronic specialties are shown.

Typical Series Dual Chiller Operation

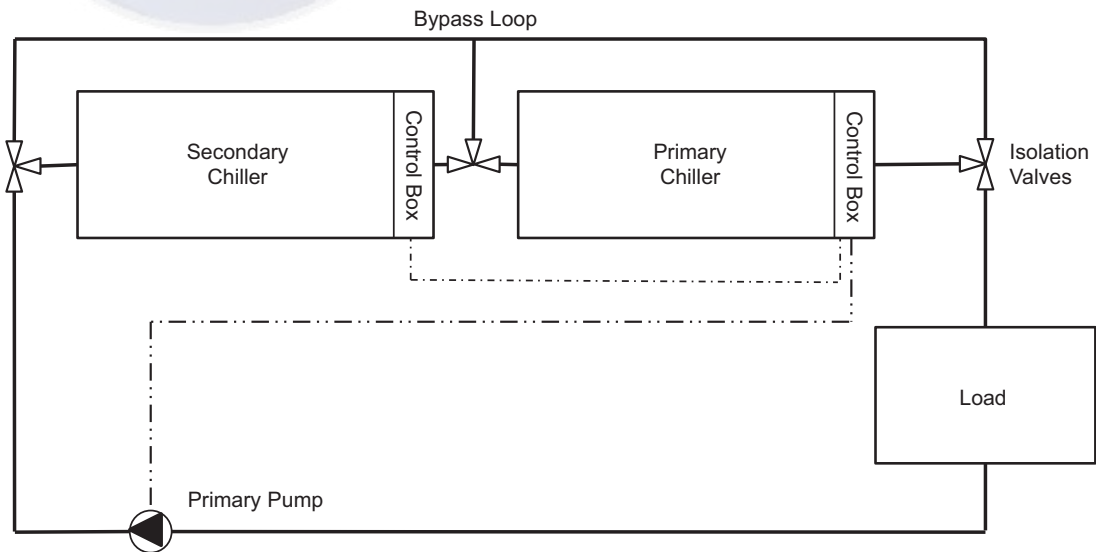

- - - - - Field Wiring
 ······ Field Communication Wiring

NOTE: This is a simplified piping diagram. Not all hydronic specialties are shown.

Evaporator Water Temperature

1. Maximum leaving chilled water temperature (LCWT) for the unit is 70°F (21.1°C). Unit can start and pull-down with up to 95°F (35°C) entering water temperature. It is recommended that entering water temperature not exceed 80°F (26.7°C).
2. Minimum LCWT for standard unit is 38°F (3.3°C).

NOTE: Water flowing through evaporator should not exceed 100°F (38°C).

Water Quality

Maintaining proper water quality is important in closed-loop systems. When a brazed plate evaporator is selected, follow the guidelines presented in the following table.

Water Quality Characteristics and Limitations

WATER CHARACTERISTIC	QUALITY LIMITATION
Alkalinity (HCO ₃ ⁻)	70 – 300 ppm
Sulfate (SO ₄ ²⁻)	Less than 70 ppm
HCO ₃ ⁻ /SO ₄ ²⁻	Greater than 1.0
Electrical Conductivity	10 – 500 µS/cm
pH	7.5 – 9.0
Ammonium (NH ₃)	Less than 2 ppm
Chlorides (Cl ⁻)	Less than 300 ppm
Free Chlorine (Cl ₂)	Less than 1 ppm
Hydrogen Sulfide (H ₂ S) ^a	Less than 0.05 ppm
Free (aggressive) Carbon Dioxide (CO ₂) ^b	Less than 5 ppm
Total Hardness (dH)	4.0 – 8.5
Nitrate (NO ₃)	Less than 100 ppm
Iron (Fe)	Less than 0.2 ppm
Aluminum (Al)	Less than 0.2 ppm
Manganese (Mn)	Less than 0.1 ppm

NOTE(S):

- a. Sulfides in the water quickly oxidize when exposed to air, requiring that no agitation occur as the sample is taken. Unless tested immediately at the site, the sample will require stabilization with a few drops of one Molar zinc acetate solution, allowing accurate sulfide determination up to 24 hours after sampling. A low pH and high alkalinity cause system problems, even when both values are within the ranges shown. The term pH refers to the acidity, basicity, or neutrality of the water supply. Below 7.0, the water is considered to be acidic. Above 7.0, water is considered to be basic. Neutral water contains a pH of 7.0.
- b. Dissolved carbon dioxide can either be calculated from the pH and total alkalinity values, shown below, or measured on the site using a test kit. Dissolved Carbon Dioxide, PPM = TA x 2[(6.3-pH)/0.3] where TA = Total Alkalinity, PPM as CaCO₃.

Strainers

All 30RC chillers are supplied with a factory-installed 20 mesh strainer.

Please contact your Carrier representative for all open-loop applications.

Evaporator Flow/Range

The 30RC chillers may be operated over a wide range of temperature rise, providing flow limits are not exceeded. For minimum and maximum evaporator flow rates, see the Minimum and Maximum Evaporator Flow Rates table on page 50. A high flow rate is generally limited by the maximum pressure drop that can be tolerated by the unit. The 30RC chillers are designed for a full load temperature rise of 3° to 20°F (1.7° to 11.1°C). Use the Packaged Chiller Builder Program to obtain all ratings.

Minimum evaporator flow (maximum evaporator temperature rise).

The minimum evaporator flow for standard units is shown in Minimum and Maximum Evaporator Fluid Flow Rates table. When system design conditions require a lower flow (or higher rise) than the minimum allowable evaporator flow, follow the recommendations below.

- Multiple smaller chillers may be applied in series, each providing a portion of the design temperature rise.
- Evaporator fluid may be recirculated to raise the flow rate to the chiller. The mixed temperature entering the evaporator must be maintained to a minimum of at least 3°F (1.7°C) above the LCWT and to a maximum of no more than 20°F (11.1°C) above the LCWT.

NOTE: Recirculation flow is shown below.

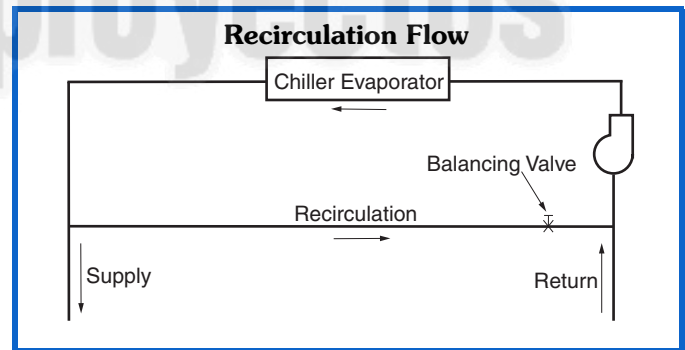

Maximum evaporator flow

The maximum evaporator flow (approximately 3°F [1.7°C] rise) results in a practical maximum pressure drop through evaporator.

Return fluid may bypass the evaporator to keep the pressure drop through the evaporator within acceptable limits. This permits a higher delta T with lower fluid flow through evaporator and mixing after the evaporator. The mixed temperature entering the evaporator must be maintained to a minimum of at least 3°F (1.7°C) above the LCWT and to a maximum of no more than 20°F (11.1°C) above the LCWT.

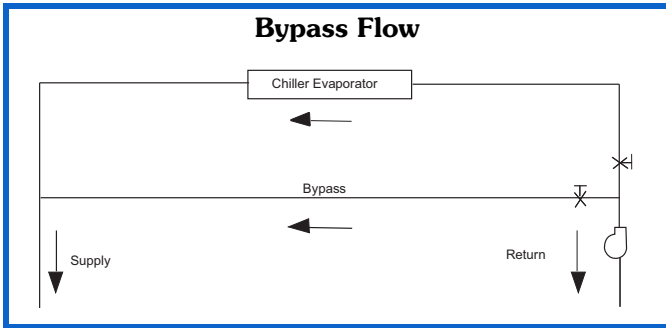

Variable Evaporator Flow Rates

Variable flow rates may be applied to a standard chiller. The unit will, however, attempt to maintain a constant leaving chilled water temperature. In such cases, minimum flow must be in excess of minimum flow given in the Minimum and Maximum Evaporator Fluid Flow Rates table on page 50, and minimum fluid volume in circulation must be in excess of those values shown for normal air-conditioning applications in the Minimum Fluid Volume in Circulation table. Flow rate must change in steps of less than 10% per minute. Apply 6 gal. or more per ton (6.5 L per kW) water loop volume minimum if flow rate changes more rapidly.

Fluid Loop Volume

The minimum volume of fluid required to be in circulation is a function of the number of compressors in the chiller, the type of application, and whether or not a device providing additional unloading steps is employed. The minimum fluid in circulation must equal or exceed the values in the following table. Note that in process cooling applications, or for operation at ambient temperatures below 32°F (0°C) with low loading conditions, there should be more volume than is required for normal air-conditioning applications.

Minimum Fluid Volume in Circulation

30RC UNIT SIZE	NORMAL AIR CONDITIONING APPLICATION gal/ton (L per kW)			PROCESS COOLING OR LOW AMBIENT OPERATION APPLICATION gal/ton (L per kW)		
	Std Unit	HGBP	Digital	Std Unit	HGBP	Digital
010-015	12 (13)	N/A	3 (3.3)	12 (13)	N/A	6 (6.5)
020-030	6 (6.5)	4 (4.3)	3 (3.3)	10 (10.8)	10 (10.8)	6 (6.5)
035-060	3 (3.3)	3 (3.3)	3 (3.3)	6 (6.5)	6 (6.5)	6 (6.5)

LEGEND

HGBP — Hot Gas Bypass

To achieve this fluid volume, it is often necessary to install a tank in the loop. The tank should be baffled to ensure there is no stratification and that water (or brine) entering the tank is adequately mixed with liquid in the tank. A fluid storage tank is available as an accessory.

The piping between the chiller and the accessory tank can be done to allow the tank to be on the return side of the chiller (tank piped to chiller inlet) or the supply side of the chiller (tank piped to the chiller outlet). However, it is recommended that the tank be piped to the return side of the chiller to buffer any changes in load to allow more stable chiller operation.

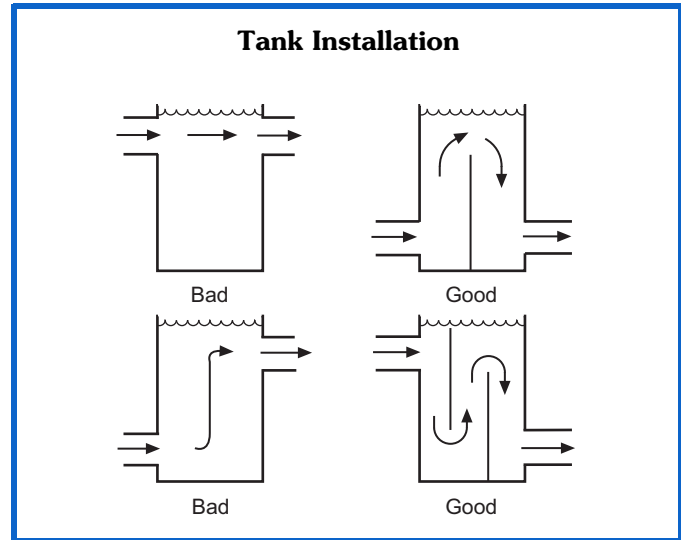

Tank Volume and Weight

A properly baffled storage tank is available as an accessory on all units. These tanks are designed to physically fit beneath the corresponding 30RC unit, taking up the same footprint. Available volume is as follows:

30RC010-015 83 gallons (314 liters)

30RC020-030 119 gallons (450 liters)

30RC035-060 241 gallons (912 liters)

Storage tank weight (water weight included) is as follows:

30RC010-015 1673 lb (759 kg)

30RC020-030 2193 lb (995 kg)

30RC035-060 4361 lb (1978 kg)

NOTE: This tank will obtain power from the main unit. No separate power source is required.

NOTE: Units with storage tanks weigh considerably more than units without tanks.

Evaporator Fouling Factor

The standard AHRI fouling factor is 0.00010 ft² · hr · °F/Btu (0.000018 m² · °C/W). As fouling factor is increased, unit capacity decreases and compressor power increases. Use the Packaged Chiller Builder Program to obtain all ratings.

Evaporator and Hydronic System Freeze Protection

Freeze protection for down to -20°F (-28.9°C) the evaporator and hydronic package is standard. Since power is sometimes lost for extended periods during winter storms, freeze protection provided by heater tapes will be effective only if a back-up power supply can be assured for the unit's control circuit, heater and evaporator pump. If not protected with an antifreeze solution, draining the evaporator and outdoor piping is recommended if the system will not be used during freezing weather conditions.

Two conditions that must be considered when determining antifreeze concentration are leaving water set point and ambient freeze conditions. Both of these parameters can help determine the recommended concentration level. Higher concentration must be used to adequately protect the machine.

NOTE: Use only antifreeze solutions approved for heat exchanger duty.

For applications in which the leaving water temperature set point is less than 40°F (4.4°C), a suitable inhibited anti-freeze solution must be used. The solution concentration must be sufficient to protect the chilled water loop to a freeze protection (first crystals) concentration of at least 15°F (8.3°C) below the leaving water temperature set point.

If the chiller refrigerant or fluid lines are in an area where ambient conditions fall below 34°F (1°C), it is required that an antifreeze solution be added to protect the unit and fluid piping to a temperature of 15°F (8.3°C) below the lowest anticipated ambient temperature.

Select concentration based on either burst or freeze protection as dictated by the application. If the chiller does not operate during the winter, nor is a start-up expected, a burst protection concentration is recommended. This concentration may not be high enough to pump the fluid through the unit. Burst protection is typically a lower concentration that will provide better performance from the machine. If the chiller does operate during winter, a freeze protection concentration is recommended. This concentration will be high enough to keep the fluid in a condition that it can be pumped at low ambient conditions.

IMPORTANT: Glycol anti-freeze solutions are highly recommended since heater tapes provide no protection in the event of a power failure.

Consult glycol fluid manufacturers for burst protection recommendations and fluid specifications.

High Ambient Temperature Operation

High outdoor ambient chiller start-up and operation is possible for standard 30RC chillers at ambient temperatures up to 120°F (50°C) at nominal voltage. The unit will additionally be able to stay running at reduced capacity up to 125°F (52°C).

Low Ambient Temperature Operation

Units will operate down to -20°F (-29°C) on sizes 010 and 015 (with the inclusion of wind baffles or hail guards), 45°F (7°C) on sizes 020-030, and 32°F (0°C) on sizes 035-060 as standard.

With the inclusion of wind baffles or hail guards and high-efficiency variable condenser fans (high-efficiency variable condenser fans are automatically provided on unit sizes 010 and 015), all units are able to start as low as -13°F (-25°C) and to operate as low as -20°F (-29°C) ambient temperature.

Minimum and Maximum Evaporator Flow Rates

30RC SIZE	MINIMUM EVAPORATOR FLOW RATE (gpm) ^a	MAXIMUM EVAPORATOR FLOW RATE (gpm)	MINIMUM EVAPORATOR FLOW RATE (l/s) ^a	MAXIMUM EVAPORATOR FLOW RATE (l/s)
010	13	49	0.8	3.1
015	18	69	1.1	4.4
020	24	95	1.5	6.0
025	31	124	2.0	7.8
030	36	142	2.3	8.9
035	44	172	2.8	10.8
040	50	196	3.2	12.3
045	57	224	3.6	14.1
050	61	243	3.8	15.3
055	66	263	4.2	16.6
060	72	284	4.5	17.9

NOTE(S):

a. For minimum evaporator flow rate with brine applications, refer to E-CAT software performance tables

Inhibited propylene glycol or other suitable corrosion-resistant anti-freeze solution must be field supplied and installed in all units for unit operation below 32°F (0°C). Solution must be added to fluid loop to protect loop down to 15°F (8°C) below minimum operating ambient temperature. Concentration should be based on expected minimum temperature and either “Burst” or “Freeze” protection levels. At least 6 gal. per ton (6.5 L per kW) of fluid volume is the recommended minimum for a moderate system load.

NOTE: In order for a chiller to operate at -20°F (-29°C) ambient temperature, the minimum load on the chiller must be above the minimum step of unloading.

High-Efficiency Variable Condenser Fans

Highly efficient part load performance is available with variable speed condenser fan motors controlled by variable speed drives. In most applications, the chiller will run at part load conditions the vast majority of the time, and this is particularly the case if the application has a 24/7 duty cycle. This option will lower utility costs while producing a scroll compressor design that is best-in-class in part load efficiency. This is the essence of 30RC chillers with Greenspeed® intelligence. The use of this option also enables the chiller to operate at ambient conditions down to -20°F (-29°C) with the inclusion of either wind baffles or hail guards. Note: Unit sizes 010-015 are always provided with high-efficiency variable condenser fans.

Condenser Airflow

Airflow restrictions on units with standard fans will affect the unit capacity, condenser head pressure, and compressor power input. Correction factors to be applied for external static restrictions up to 0.2 in. wg (50 Pa) are as follows:

EXTERNAL STATIC		CAPACITY MULTIPLIER	COMPRESSOR POWER MULTIPLIER
in. wg	Pa		
0.0	00.0	1.000	1.00
0.1	25.0	0.986	1.01
0.2	50.0	0.968	1.03

Water System Overview (closed loop systems only)

The 30RC chillers are designed for use with closed systems, meaning that there is no more than one water-air interface in the water loop. Cooling tower loops, for example, have two water-air interfaces (sump and nozzles) and would thus be classified as open, whereas a correctly designed chilled water loop with the only water-air interface being in the expansion tank is closed. Since closed and open water systems behave very differently, the following assumes that the chilled water loop is closed. A system installed incorrectly such that air is not handled properly — pipe leaks, vent leaks, air in pipes, etc. — may behave as an open system and thus have unsatisfactory operation. Pump seal wear can also cause leaks that cause poor system operation.

Proper closed system design and installation procedures should be followed closely. The system must be constructed with pressure tight components and thoroughly tested for installation leaks. Factory-supplied hydronic systems are available with single or dual (for back-up) pumps. The factory-installed system includes all of the

components within the dashed lines shown in the figure on page 38.

Installation of water systems should follow sound engineering practice as well as applicable local and industry standards. Improperly designed or installed systems may cause unsatisfactory operation and/or system failure. Consult a water treatment specialist or appropriate literature for information regarding filtration, water treatment, and control devices.

It is recommended that isolation (shutoff) valves be placed exterior to the unit to allow removal and service of the entire pump assembly, if necessary. Also, if the unit is isolated with valves, a properly sized pressure relief valve should be installed in the piping between the unit and the valves, following all applicable state and local codes.

Water System Cleaning

Proper water system cleaning is of vital importance. Excessive particulates in the water system can cause excessive pump seal wear, reduce or stop flow, and cause damage of other components. Water quality should be maintained within the limits indicated in the “Water Quality Characteristics and Limitations” on page 48.

1. Install a temporary bypass around the chiller to avoid circulating dirty water and particulates into the pump package and chiller during the flush. Use a temporary circulating pump during the cleaning process. Also, be sure that there is capability to drain the system fully after cleaning.
2. Be sure to use a cleaning agent that is compatible with all system materials. Be especially careful if the system contains any galvanized or aluminum components. Both detergent-dispersant and alkaline-dispersant cleaning agents are available.
3. It is a good idea to fill the system through a water meter. This provides a reference point for the future for loop volume readings, but it also establishes the correct quantity of cleaner needed in order to get the required concentration.
4. Use a feeder/transfer pump to mix the solution and fill the system. Circulate the cleaning system for the length of time recommended by the cleaning agent manufacturer.
 - a. After cleaning, drain the cleaning fluid and flush the system with fresh water.
 - b. A slight amount of cleaning residue in the system can help keep the desired, slightly alkaline, water pH of 8 to 9. Avoid a pH greater than 10, since this will adversely affect pump seal components.
 - c. A side stream filter is recommended during the cleaning process. Filter side flow rate should be enough to filter the entire water volume every 3 to 4 hours. Change filters as often as necessary during the cleaning process.
 - d. Remove temporary bypass when cleaning is complete.

A 20 mesh strainer with a blow-down valve is standard on all 30RC units, both with and without hydronic packages. The blow-down valve allows removal of particulates caught in the strainer without complete removal of the screen. A female NPT connection is provided on the valve, allowing hose connection for drainage outside the unit.

The PIC6 controls provided have a built-in feature to remind building owners or operators to clean the strainer by discharging the blow-down valve at a pre-set time interval. Properly installed and cleaned systems will rarely need the strainer cleaned after the initial fill. This time interval is user-configurable.

Condenser Coil Protection (Enviro-Shield™)

Refer to the environmental selection guides for more information. If the standard Novation® (microchannel) coil does not meet the corrosion requirements for a given application, additional coil options are available. For specific geographical recommendations, please refer to the NACO (North American Commercial Operations) Packaged Chiller Builder program.

Aluminum fin/copper tube coils

Aluminum fin/copper tube coils are constructed of seamless copper tubes mechanically bonded to aluminum fins. The fins have wavy enhancements. These coils are not recommended for corrosive environments.

E-coated Novation® coils

E-coated Novation® coils have an extremely flexible and durable epoxy coating uniformly applied to all coil surfaces. Unlike brittle phenolic dip and bake coatings, e-coat provides superior protection with unmatched flexibility, edge coverage, metal adhesion, thermal performance and most importantly, corrosion resistance. E-coated coils provide this protection since all coil surfaces are completely encapsulated from environmental contamination. This option provides the best protection for Novation coil technology. E-coated aluminum-fin coils shall be capable of withstanding an 8,000-hour salt spray test in accordance with the ASTM (American Society for Testing and Materials) B-117 Standard.

E-coated aluminum-fin coils

E-coated aluminum-fin coils have the same flexible and durable epoxy coating as e-coated Novation coils. This option provides better protection compared to standard or pre-coated aluminum-fin coils in many environments. E-coated aluminum-fin coils shall be capable of withstanding an 8,000-hour salt spray test in accordance with the ASTM (American Society for Testing and Materials) B-117 Standard.

Electrical/Utility Interests

Energy management

Use of energy management practices can significantly reduce operating costs, especially during off-peak modes of operation. Demand limiting and temperature reset are 2 techniques for accomplishing efficient energy management. See Demand Limiting (also called load shedding) section on this page for further details.

Demand limiting (load shedding)

When a utility's demand for electricity exceeds a certain level, loads are shed to keep electricity demand below a prescribed maximum level. Typically, this happens on hot days when air conditioning is most needed. The energy management module (EMM) can be added to accomplish this reduction. Demand may be limited on unit by resetting the fluid temperature, or by unloading the chiller to a given predetermined percentage of the load. Demand limit may

also be driven by an external 4 to 20 mA signal. These features require a signal from an intelligent central control. Do not cycle demand limiter for less than 10 minutes on and 5 minutes off. Duty cycling cycles electrical loads at regular intervals regardless of need. This reduces the electrical operating costs of building by "fooling" demand indicating devices. Duty cycling of compressors or fans is not recommended since motor winding and bearing life will suffer from constant cycling.

Remote on-off control

Remote on-off control may be applied by hard-wired connection (see Controls and Troubleshooting literature) or by connection to a Carrier Comfort Network® (CCN) system.

Optional hydronic system selection

Select pump gpm from resulting chiller selection and total pressure loss in the system plus the chiller internal pressure loss.

NOTE: Maximum gpm (L/s), pressure and pump hp must not exceed maximum on pump curve.

NOTE: Optional hydronic system is available in constant-speed and VFD configuration on 280/230 and 460-v units.

Pump flow can be reduced by using the factory-supplied triple-duty valve up to 10%. Beyond that, impeller trimming is recommended to reduce energy consumption. Follow local codes or ASHRAE 90.1 recommendations. Contact your Carrier representative for specific amount of trim required.

Expansion tank supplied will allow loop expansion due to ambient fluctuations for loop volumes of up to the values in the table below. If loop volume exceeds the maximum loop volume, a larger expansion tank must be field supplied.

The supplied expansion tanks have the following specifications: 30RC010-030 — 4.4 total gal. (17.0 L) and 3.2 gal. (12.4 L) acceptance volume, 30RC035-060 — 10.3 total gal. (39.0 L) and 10.3 gal. (39.0 L) acceptance volume.

Maximum loop volume is based on typical system of 12 psig (83 kPa) and 30 psig (207 kPa) of min/max pressures, and 38°F (3.3°C) and 100°F (37.8°C) min/max water temperature.

Maximum Loop Volume^a

CONCENTRATION	30RC010-030		30RC035-060	
	GAL.	L	GAL.	L
PURE WATER	230	871	738	2793
10% EG	132	500	425	1609
20% EG	123	466	394	1491
30% EG	114	431	366	1385
40% EG	107	405	342	1294
10% PG	124	469	399	1510
20% PG	106	401	339	1283
30% PG	93	352	298	1128
40% PG	83	314	267	1011

NOTE(S):

a. Maximum loop volume is based on typical system of 12 psig (83 kPa) and 30 psig (207 kPa) of min/max pressures, and 38°F (3.3°C) and 100°F (37.8°C) min/max water temperature. If the volume in the system is greater than the limits listed, then extra expansion tank volume must be added to the system.

LEGEND

EG — Ethylene Glycol
PG — Propylene Glycol

Parallel chillers with hydronic packages require that pump inlets be equalized to prevent pump cavitation. Pump expansion tanks must be removed and located together in the common pump suction header. All materials needed for expansion tank relocation are field supplied. Appropriate measures must be taken for freeze protection.

Air Separation

For proper system operation, it is essential that water loops be installed with proper means to manage air in the system. This is typically done by the installing contractor. Free air in the system can cause noise, reduce terminal output, stop flow, or even cause pump failure due to pump cavitation. For closed systems, equipment should be provided to eliminate all air from the system.

The amount of air that water can hold in solution depends on the pressure and temperature of the water/air mixture. Air is less soluble at higher temperatures and at lower pressures. Therefore, separation can best be done at the point of highest water temperature and lowest pressure. Typically, this point would be on the suction side of the pump as the water is returning from the system or terminals. Generally speaking, this is the best place to install an air separator, if possible.

1. Install automatic air vents at all high points in the system. (If the 30RC unit is located at the high point of the system, a vent can be installed on the piping

entering the heat exchanger on the 1/4-in. NPT female port.)

2. Install an air separator in the water loop, at the place where the water is at higher temperatures and lower pressures — usually in the chilled water return piping. On a primary-secondary system, the highest temperature water is normally in the secondary loop, close to the decoupler. Preference should be given to that point on the system. In-line or centrifugal air separators are readily available in the field.

It may not be possible to install air separators at the place of lowest pressure and highest temperature. In such cases, preference should be given to the points of highest temperature. It is important that pipe be sized correctly so that free air can be moved to the point of separation. Generally, a water velocity of at least 2 ft per second (0.6 m per second) will keep free air entrained and prevent it from forming air pockets.

Automatic vents should be installed at all physically elevated points in the system so that air can be eliminated during system operation. Provision should also be made for manual venting during the water loop fill. It is important that the automatic vents be located in accessible locations for maintenance purposes, and that they be located where they can be prevented from freezing.

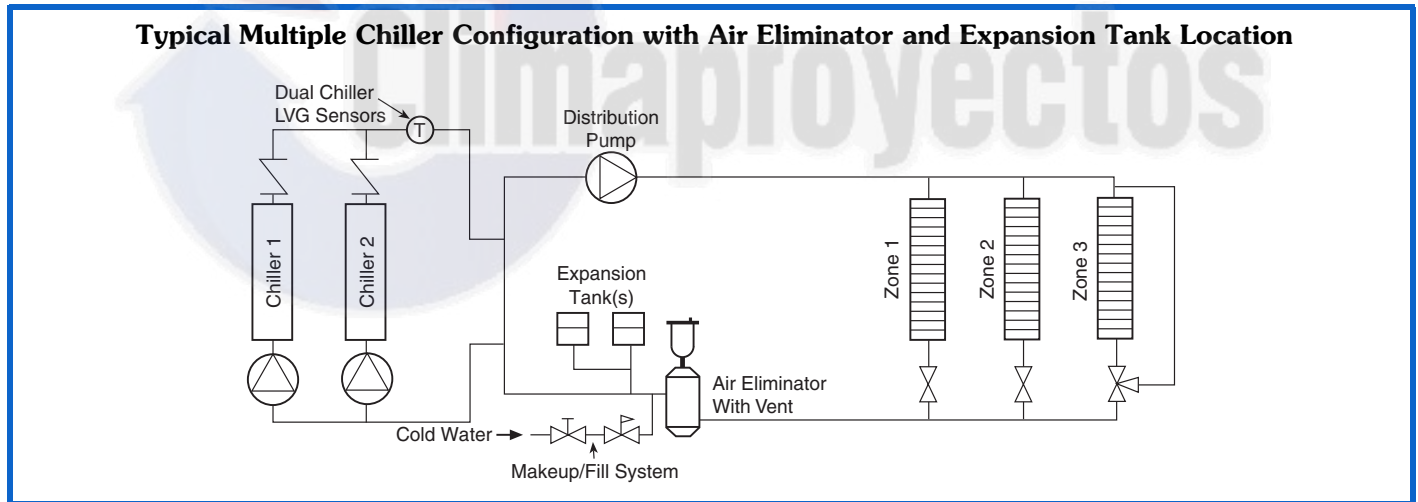

Outdoor 60 Hz Air-Cooled Liquid Chiller

HVAC Guide Specifications

Size Range: **10 to 60 Tons**
(35 to 211 kW) Nominal

Carrier Model Number: **30RC**

Part 1 — General

1.01 SYSTEM DESCRIPTION

- A. Microprocessor controlled, air-cooled liquid chiller for outdoor installation, utilizing scroll compressors, low sound fans, electronic expansion valve, optional hydronic pump system and fluid storage tank.

For units that incorporate Greenspeed intelligence, all fans are controlled with variable speed fan drive motors. Chiller software shall be specifically developed to coordinate optimal fan speed for application conditions and provide refrigerant circuit optimization, resulting in higher part load efficiency and reduced acoustic levels.

1.02 QUALITY ASSURANCE

- A. Unit shall be rated in accordance with AHRI (Air-Conditioning, Heating and Refrigeration Institute) Standard 550/590, latest edition (U.S.A.) and all units shall be ASHRAE (American Society of Heating, Refrigerating and Air-Conditioning Engineers) 90.1-2019 compliant.
- B. Unit construction shall comply with ASHRAE 15 Safety Code, UL (Underwriters Laboratories) latest edition, and ASME (American Society of Mechanical Engineers) applicable codes (U.S.A. codes).
- C. The management system governing the manufacture of this product is ISO (International Organization for Standardization) 9001:2015 certified.
- D. An operational test, in which the chiller is run under load, is performed at the factory. This test checks for proper operation of fans as well as various controls and safeties, and a Certificate of Unit Testing, indicating successful end-of-line testing, is provided with the unit.

1.03 DELIVERY, STORAGE AND HANDLING

- A. Unit controls shall be capable of withstanding 150°F (66°C) storage temperatures in the control compartment.
- B. Unit shall be stored and handled per unit manufacturer's recommendations.

Part 2 — Products

2.01 EQUIPMENT

- A. General:
1. Factory assembled, single-piece chassis, air-cooled liquid chiller. Contained within the unit cabinet shall be all factory wiring, piping, controls, refrigerant charge (R-32), and special features required prior to field start-up.
- B. Materials of Construction:
1. Frame shall be of heavy-gauge, galvanized steel.

2. Exterior panels shall be galvanized steel with a baked enamel powder or pre-painted finish.
 3. Painted parts shall withstand 1000 hours in constant neutral salt spray under ASTM (American Society for Testing and Materials) B117 conditions with a 1 mm scribe per ASTM D1654. After test, painted parts shall show no signs of wrinkling or cracking, no loss of adhesion, no evidence of blistering, and the mean creepage shall not exceed 1/4 in. (Rating \geq per ASTM D1654) on either side of the scribe line.
- C. Fans:
1. Standard condenser fans shall be direct-driven (VFD [variable frequency drive] controlled on units with Greenspeed intelligence), 9-blade airfoil cross-section, reinforced polymer construction, shrouded-axial type, and shall be statically and dynamically balanced with inherent corrosion resistance.
 2. The variable speed drives for the condenser fans on 30RC units with Greenspeed intelligence shall include a DC link reactor.
 3. Fan operation shall allow reduced sound levels during scheduled unoccupied operating periods. Manufacturers without unoccupied reduced sound capability shall submit 1/3 octave band data and sound power data as measured according to AHRI 370 as confirmation of unit sound characteristics.
 4. Air shall be discharged vertically upward.
 5. Fans shall be protected by coated steel wire safety guards.
 6. Fan blades shall have serrated edges to minimize the sound that is produced.
- D. Compressor/Compressor Assembly:
1. Fully hermetic, direct-drive, scroll-type compressors.
 2. Compressor motors shall be cooled by refrigerant gas passing through motor windings and shall have either internal line break thermal and current overload protection or external current overload modules with compressor temperature sensors.
 3. Compressors shall be mounted on rubber in shear vibration isolators.
 4. Staging of compressors shall provide unloading capability. Digital compressor unloading control shall be available as an option.
 5. When RTPF coils are employed, each compressor shall be equipped with crankcase heaters to minimize oil dilution. Crankcase heaters shall not be required when microchannel condenser coils are utilized.
- E. Brazed Plate Evaporator:
1. Evaporator shall be rated for a refrigerant working-side pressure of 710 psig (4895 kPa) and shall be tested for a maximum water-side pressure of

300 psig (2068 kPa) or 150 psig (1034 kPa) when optional hydronic package is installed.

2. Shall be single-pass, ANSI (American National Standards Institute) type 316 stainless steel, brazed plate construction.
3. Shell shall be insulated with 3/4-in. (19 mm) closed-cell, polyvinyl-chloride foam with a maximum K factor of 0.28.
4. Shall incorporate 2 independent refrigerant circuits on sizes 035 to 060; sizes 010 to 030 shall have one independent refrigerant circuit.
5. Evaporator shall have factory-installed heater, to protect Evaporator from ambient temperature freeze down to -20°F (-29°C). Unit shall be provided with a factory-installed flow switch.
6. All connections shall use standard Victaulic-type fittings.
7. Evaporator shall be supplied with a 20 mesh strainer.

F. Condenser:

1. Coil shall be air-cooled Novation[®] heat exchanger technology with microchannel (MCHX) coils and shall have a series of flat tubes containing a series of multiple, parallel flow microchannels layered between the refrigerant manifolds.
2. Coils shall consist of a two-pass arrangement. Coil construction shall consist of aluminum alloys for fins, tubes, and manifolds in combination with a corrosion-resistant coating.
3. Tubes shall be cleaned, dehydrated, and sealed.
4. Assembled condenser coils shall be leak tested and pressure tested at 656 psig (4522 kPa).

G. Refrigeration Components:

Refrigerant circuit components shall include filter drier, moisture indicating sight glass, electronic expansion device and complete operating charge of both refrigerant R-32 and compressor oil. Per Department of Transportation regulations, when any A2L refrigerant is employed, there must be a suction service valve on any chiller containing a charge of 20 kg or more. Therefore, a suction service valve is included on all 30RC035-060 chillers which employ Al/Cu coils.

H. Controls, Safeties, and Diagnostics:

1. Unit controls shall include the following minimum components:
 - a. Microprocessor with non-volatile memory. Battery backup system shall not be accepted.
 - b. Separate terminal block for power and controls.
 - c. Control transformer to serve all controllers, relays, and control components.
 - d. ON/OFF control switch.
 - e. Replaceable solid-state controllers.
 - f. Pressure sensors shall be installed to measure suction and discharge pressure for each

circuit. Thermistors shall be installed to measure evaporator entering and leaving fluid temperatures, outdoor ambient temperature, and discharge temperature.

2. Unit controls shall include the following functions:
 - a. Automatic circuit primary/secondary for dual circuit chillers.
 - b. Hermetic scroll compressors are maintenance free and protected by an auto-adaptive control that minimizes compressor wear.
 - c. Capacity control based on leaving chilled fluid temperature and compensated by rate of change of return-fluid temperature with temperature set point accuracy to 0.1°F (0.06°C).
 - d. Limiting the chilled fluid temperature pull-down rate at start-up to an adjustable range of 0.2°F to 2°F (0.11°C to 1.1°C) per minute to prevent excessive demand spikes at start-up.
 - e. Seven-day time schedule.
 - f. Leaving chilled fluid temperature reset from return fluid and outside air temperature.
 - g. Chilled water pump start/stop control and primary/standby sequencing to ensure equal pump run time.
 - h. Dual chiller control for parallel chiller applications without addition of hardware modules and control panels (additional thermistors and wells are required).
 - i. Timed maintenance scheduling to signal maintenance activities for pumps, condenser coil cleanings, strainer maintenance and user-defined maintenance activities.
 - j. Boiler enable signal to initiate system heating mode.
 - k. Low ambient protection to energize evaporator and hydronic system heaters.
 - l. Periodic pump start to ensure pump seals are properly maintained during off-season periods.
 - m. Single step demand limit control activated by remote contact closure.
 - n. Nighttime sound mode to reduce the sound of the machine by a user-defined schedule.
3. Diagnostics:
 - a. The control panel shall include, as standard, a display:
 - 1) Color touch screen display with stylus.
 - 2) Display shall allow a user to navigate through menus, select desired options, and modify data.
 - b. Features of the display shall include:
 - 1) Multiple connection ports for USB, Ethernet, or BACnet¹ IP, Modbus¹-RTU (Remote Terminal Unit), LEN (local

equipment network), and Carrier Comfort Network® (CCN) connections.

NOTE: BACnet IP may require additional programming.

- 2) Automatic reporting of alarms over email.
- 3) Ability to graphically plot trends of system performance and conditions over time.
- 4) Graphical summary display of current chiller operation and water conditions.
- 5) Display shall allow access to configuration, maintenance, service, set point, time schedules, alarm history, and status data.
- 6) Three levels of password protection against unauthorized access to configuration and maintenance information, and display set up parameters.
- 7) Full compatibility with the Carrier Comfort Network® (CCN) system to provide email alarm notification and to provide network capability to fully monitor and control chiller.
- 8) Display shall be capable of displaying the last 50 alarms, with clear full text description and time and date stamp, and will store a snapshot of operating conditions before and after the 10 most recent alarms.
- 9) Display run hours and number of starts for machine and individual compressors.
- 10) The control system shall allow software upgrade without the need for new hardware modules.

4. Safeties:

- a. Unit shall be equipped with thermistors and all necessary components in conjunction with the control system to provide the unit with the following protections:
 - 1) Reverse rotation.
 - 2) Low chilled fluid temperature.
 - 3) Motor overtemperature.
 - 4) High pressure.
 - 5) Electrical overload.
 - 6) Thermal overload.
 - 7) Loss of refrigerant charge.
- b. Condenser fan motors shall have internal overcurrent protection.

I. Operating Characteristics:

1. Unit shall be capable of operating down to – 20°F (–29°C) on size 010 and 015 units, 45°F (7.2°C) on size 020-030 units, and 32°F (0°C) on size 035-060 units as standard.

2. Unit sizes 020-060 are capable of lower starting and operating temperatures with the inclusion of wind baffles and high-efficiency variable condenser fans.
3. Unit shall be capable of starting and running at outdoor ambient temperatures up to 120°F (50°C) for all sizes. Unit shall additionally be able to stay online when running with a 125°F (52°C) ambient temperature.
4. Unit shall be capable of starting up with 95°F (35°C) entering fluid temperature to the evaporator.

J. Fan Motors:

1. Condenser fan motors shall be totally enclosed, air over, 3-phase type with permanently lubricated bearings and Class F insulation. Fans shall use 8-pole motor.

K. Electrical Requirements:

1. Unit/module primary electrical power supply shall enter the unit at a single electrical box.
2. Unit shall operate on 3-phase power at the voltage shown in the equipment schedule.
3. Control points shall be accessed through terminal block.
4. Unit shall be shipped with factory control and power wiring installed.
5. Unit shall have a standard SCCR (short circuit current rating) of 10 kA.

L. Chilled Water Circuit:

1. Chilled water circuit shall be rated for 300 psig (2068 kPa). Units with optional pump package are rated for 150 psig (1034 kPa) working pressure.
2. Solid-state flow monitor with integral relay shall be factory installed and wired.
3. Brass body strainer with 20 mesh screen and ball type blow down.
4. Optional hydronic package (applies to 280/230 and 460-v unit sizes except as noted, with or without the use of VFD [variable frequency drive]):
 - a. Field pipe connections shall be carbon steel Victaulic type.
 - b. Optional single or primary/stand-by operation pump systems. Dual pump systems shall have a pump discharge check valve.
 - c. For dual-pump packages, the equipment shall have one pump operating, and a simple transition to the back-up pump shall be accomplished by means of a valve which shall be supplied with this configuration.
 - d. For dual-pump packages, when servicing is required, the pump removal/installation process shall require neither the chiller to be drained nor the installation of a blank flange

1. Third-party trademarks and logos are the property of their respective owners.

to replace the pump vertical in-line, being removed/installed.

- e. Pumps shall be single stage design, capable of being serviced without disturbing piping connections.
 - 1) Pump casing shall be of class 30 cast iron.
 - 2) The impeller shall be of cast bronze, closed type, dynamically balanced, keyed to the shaft and secured by locking cap screw.
 - 3) The hydronic kit will be provided with a flush line connection to ensure lubrication at the seal face and allow for positive venting of the seal chamber.
 - 4) Each port shall be fitted with an isolation valve that allows the units to operate in parallel or standby, yet may be used to isolate one pumping unit for servicing or removal with the other pump still running.
 - 5) Pump shall be rated for 150 psig (1034 kPa) working pressure.
 - 6) The pump piping shall have gauge tappings at the suction and discharge lines and include drain ports.
 - 7) Dual pumps shall allow for the servicing of one pump without draining the chilled water loop.
 - 8) Motors shall be TEFC 3-phase type with grease-lubricated ball bearings.
 - 9) Each pump shall be factory tested per Hydraulic Institute Standards.
 - 10) Pump motors shall be VFD compatible.
- f. Fluid expansion tank shall be factory installed within the chiller cabinet insulates, pre-charged and rated for a maximum working pressure of 150 psig (1034 kPa).
- g. Water pressure taps (2) shall be factory installed across the evaporator and rated for 150 psig (1034 kPa).
- h. Combination valve (which includes check, isolation, and modulation) shall be factory installed. Pressure/temperature taps (2) shall be factory installed to measure the pressure differential across the combination valve.
- i. Hydronic assembly shall have factory-supplied electric freeze protection to -20°F (-29°C) when optional heaters are used.

M. Special Features:

Certain standard features are not applicable when the features designated by * are specified. For assistance in amending the specifications, contact your Carrier representative.

1. High-efficiency variable condenser fans:

All fans on the unit shall have variable speed fan motors to provide higher part load efficiency and reduced acoustic levels. Each fan circuit shall have a factory-installed, independent variable speed drive with display. Variable speed drives are rated IP-55 enclosures and UL Listed. The use of this option or accessory, with the addition of antifreeze in the evaporator circuit and wind baffles or hail guards, shall allow running with outdoor ambient temperatures down to -20°F (-28.9°C). This feature is standard on sizes 010 and 015.

2. *Low-Ambient Operation:

Unit shall be capable of starting as low as and operating down to -20°F (-29°C) with the addition of high-efficiency variable condenser fans. In addition, adequate field-supplied antifreeze with suitable corrosion inhibitor protection shall be field-installed in the evaporator circuit. Field-installed wind baffles or factory-installed hail guards shall also be required. If significant low-load operation is anticipated, then hot gas bypass is recommended. High-efficiency variable condenser fans are standard on sizes 010 and 015.

NOTE: The motors associated with low ambient head pressure control will be open type and shall have class B insulation.

3. Unit-Mounted Non-Fused Disconnect:

Unit shall be supplied with factory-installed, non-fused electrical disconnect for main power supply. This option shall be included with the high SCCR option.

4. Optional Condenser Coil Materials:

a. E-coated microchannel coils:

E-coated aluminum microchannel coil shall have a flexible epoxy polymer coating uniformly applied to all coil external surface areas without material bridging between fins or louvers. Coating process shall ensure complete coil encapsulation, including all exposed fin edges. E-coat shall have a thickness of 0.8 to 1.2 mil with top coat having a uniform dry film thickness from 1.0 to 2.0 mil on all external coil surface areas including fin edges. E-coated coils shall have superior hardness characteristics of 2H per ASTM D3363-00 and cross hatch adhesion of 4B-5B per ASTM D3359-02. Impact resistance shall be up to 160 in./lb (ASTM D2794-93). E-coated coil shall have superior impact resistance with no cracking, chipping, or peeling per NSF/ANSI 51-2002 Method 10.2. E-coated aluminum microchannel coils shall be capable of withstanding 10,000-hour salt spray test in accordance with the ASTM (American Society for Testing and Materials) B-117 Standard.

- b. Aluminum fin/copper tube coils:

Coil shall be constructed of seamless copper tubes mechanically bonded to aluminum fins. Fins shall have wavy enhancements. These coils are not recommended for corrosive environments.
- c. E-coated aluminum-fin coils:

Coil shall have a flexible epoxy polymer coating uniformly applied to all coil surface areas without material bridging between fins. Coating process shall ensure complete coil encapsulation. Color shall be high gloss black with gloss; 60° of 65 to 90% per ASTM ID523-89. Uniform dry film thickness from 0.8 to 1.2 mil on all surface areas including fin edges. Superior hardness characteristics of 2H per ASTM D3363-92A and cross hatch adhesion of 4B5B per ASTM D3359-93. Impact resistance shall be up to 160 in./lb (ASTM D2794-93). Humidity and water immersion resistance shall be up to minimum 1000 and 250 hours respectively (ASTM D2247-92 and ASTM D870-92). E-coated aluminum-fin coils shall be capable of withstanding 10,000-hour salt spray test in accordance with the ASTM (American Society for Testing and Materials) B-117 Standard. Coil construction shall be aluminum fins mechanically bonded to copper tubes.
- 5. Hot Gas Bypass:

Unit shall be equipped with factory or field-installed, microprocessor-controlled, hot gas bypass that shall permit unit operation down below the minimum standard step of capacity. The factory option is not available on sizes 010 and 015 or on any application with a leaving fluid temperature below 38°F (3.3°C). Option and accessory not available on units with the digital compressor option.
- 6. Energy Management Module:

A factory or field-installed module shall provide the following energy management capabilities: cooling set point and demand limit control; 2-point demand limit control (from 15% to 100%) activated by a remote contact closure; discrete input for “Ice Done” indication for ice storage system interface and dual chiller leaving water temperature or chilled water reset based upon space temperature.
- 7. Hail Guards:

Unit shall be supplied with factory or field-installed, louvered, sheet metal panels which securely fasten to the chiller and provide condenser coil protection against hail and other physical damage. This option or accessory directly covers the coil(s) on all sizes. Hail guards also provide the functionality of wind baffles.
- 8. Vibration Isolation:

Vibration isolation pads shall be supplied for field installation at unit mounting points. Pads shall help to reduce vibration transmission into the occupied space.
- 9. Chilled Water Storage Tank:
 - a. Fluid storage tank shall be rated for a maximum of 150 psig (1034 kPa).
 - b. Shall provide a minimum 4 gallon per ton (3.7 L per kW) fluid storage capacity.
 - c. Shall fit under the chiller to minimize system footprint requirements. Tanks fitted outside of chiller footprint shall not be acceptable.
 - d. Tank shall be constructed a cold rolled carbon steel shell.
 - e. Tank shall be insulated with 3/4-in. (19 mm) closed-cell, polyvinyl-chloride foam with a maximum K factor of 0.28.
 - f. Tank shall be baffled to prevent temperature stratification.
 - g. Tank shall have Victaulic connections.
 - h. Tank shall have vent and drain plugs accessible from outside tank enclosure.
 - i. Internal heaters shall provide freeze protection to -20°F (-29°C). The included heater thermostat prevents overheating of the fluid.
- 10. BACnet IP:

Shall provide a factory-installed interface between the chiller and a BACnet Local Area Network (LAN) and allows integration with i-Vu® Open control system or a third-party BACnet building automation system. Field configuration is required.
- 11. LonWorks Translator:

Unit shall be supplied with field-installed interface between the chiller and a Local Operating Network (LON, i.e., LonWorks FT-10A ANSI/EIA-709.1). Field programming shall be required.
- 12. GFI Convenience Outlet:

Shall be factory or field installed to provide the chiller with a 4 amp GFI receptacle. The receptacle shall have independent fuse protection. The convenience outlet is a 115-v female receptacle. When this item is factory-installed, remote connectivity is also included.
- 13. Compressor Blankets:

Shall provide factory or field-installed sound blankets around each compressor in conjunction with low-sound AeroAcoustic™ fans to provide significant chiller sound reduction.
- 14. High SCCR (Short Circuit Current Rating):

The optional high SCCR (short circuit current rating) device shall allow the chiller to tolerate a 65 kA (208/230-v, 380-v and 460-v) and 25 kA (575V) short circuit current for a brief

period of time while protecting the downstream components. The high SCCR option shall provide a higher level of protection than the standard unit. The selection of this option includes a non-fused disconnect.

15. Digital Compressor Option:

Shall provide a factory-installed digital compressor to provide incremental steps for tighter temperature control (not available on any application with a leaving fluid temperature below 38°F [3.3°C]).

16. Wind Baffles:

Wind baffles shall be field installed to facilitate operation down to -20°F (-29°C) when used in

conjunction with high-efficiency variable condenser fans.

17. Suction Line Insulation:

Shall provide a tubular, closed-cell form of insulation that is factory-installed on the chiller suction piping.

18. Phase Loss Monitor:

Shall be field installed to provide the unit with protection against phase loss.

19. Remote connectivity:

Shall be factory-installed to provide a secure cellular system which communicates operating information to a central operating site. The selection of this option automatically includes GFI convenience outlet.



